

Safe management of wastes from health-care activities

Safe management of wastes from health-care activities

Edited by

A. Prüss

Department of Protection of the Human Environment
World Health Organization
Geneva, Switzerland

E. Giroult

Ministry of Urban Development and Housing
Paris, France

P. Rushbrook

WHO European Centre for Environment and Health
Rome, Italy



World Health Organization
Geneva
1999

WHO Library Cataloguing-in-Publication Data

Safe management of wastes from health-care activities/edited by A. Prüss,
E. Giroult, P. Rushbrook.

1. Medical waste 2. Medical waste disposal—methods 3. Safety management—
handbooks 4. Manuals 5. Guidelines I. Prüss, Annette II. Giroult, Eric
III. Rushbrook, Philip

ISBN 92 4 154525 9

(NLM classification: WA 790)

The World Health Organization welcomes requests for permission to reproduce or translate its publications, in part or in full. Applications and enquiries should be addressed to the Office of Publications, World Health Organization, Geneva, Switzerland, which will be glad to provide the latest information on any changes made to the text, plans for new editions, and reprints and translations already available.

© World Health Organization, 1999

Publications of the World Health Organization enjoy copyright protection in accordance with the provisions of Protocol 2 of the Universal Copyright Convention. All rights reserved.

The designations employed and the presentation of the material in this publication do not imply the expression of any opinion whatsoever on the part of the Secretariat of the World Health Organization concerning the legal status of any country, territory, city or area or of its authorities, or concerning the delimitation of its frontiers or boundaries.

The mention of specific companies or of specific manufacturers' products does not imply that they are endorsed or recommended by the World Health Organization in preference to others of a similar nature that are not mentioned. Errors and omissions excepted, the names of proprietary products are distinguished by initial capital letters.

The editors alone are responsible for the views expressed in this publication.

Designed by WHO Graphics
Typeset in Hong Kong
Printed in Hong Kong
98/12312—Best-set/Speedflex-7000



Contents

Foreword	xi
Acknowledgements	xiii
1. Introduction	1
2. Definition and characterization of health-care waste	2
2.1 Health-care waste: definition and classification	2
2.1.1 Definition	2
2.1.2 Infectious waste	2
2.1.3 Pathological waste	3
2.1.4 Sharps	3
2.1.5 Pharmaceutical waste	3
2.1.6 Genotoxic waste	4
2.1.7 Chemical waste	5
2.1.8 Waste with high content of heavy metals	6
2.1.9 Pressurized containers	6
2.1.10 Radioactive waste	7
2.2 Sources of health-care waste	9
2.3 Health-care waste generation	12
2.4 Physicochemical characteristics of hazardous health-care waste	14
References and suggested further reading	18
3. Health impacts of health-care waste	20
3.1 Hazards of health-care waste	20
3.1.1 Types of hazards	20
3.1.2 Persons at risk	20
3.1.3 Hazards from infectious waste and sharps	20
3.1.4 Hazards from chemical and pharmaceutical waste	22
3.1.5 Hazards from genotoxic waste	22
3.1.6 Hazards from radioactive waste	23
3.1.7 Public sensitivity	24
3.2 Public health impact of health-care waste	24
3.2.1 Impacts of infectious waste and sharps	24
3.2.2 Impacts of chemical and pharmaceutical waste	26
3.2.3 Impacts of genotoxic waste	27
3.2.4 Impacts of radioactive waste	27
3.3 Survival of pathogenic microorganisms in the environment	28
3.4 Needs for further research and epidemiological surveys	28
References and suggested further reading	29

4. Legislative, regulatory, and policy aspects	31
4.1 International agreements and underlying legislative and regulatory principles	31
4.2 Legal provisions	31
4.3 Policy document and technical guidelines	32
Reference	33
5. Health-care waste management planning	34
5.1 The need for planning	34
5.2 International recommendations for waste management	34
5.3 National plans for health-care waste management	34
5.3.1 Purpose of a national management plan	34
5.3.2 Action plan for the development of a national programme	35
5.4 Waste management plan for a health-care establishment	45
5.4.1 Assignment of responsibilities	45
5.4.2 Management structure, liaison paths, and duties	46
5.4.3 Assessment of waste generation	51
5.4.4 Development of a waste management plan	51
5.4.5 Implementation of the waste management plan	54
5.5 Management of health-care waste from scattered small sources	54
5.5.1 Basic principles	54
5.5.2 Private medical or dental practitioners	55
5.5.3 Research activities	55
5.5.4 Nursing homes	56
5.5.5 Home treatment	56
5.5.6 Ambulance services	56
5.5.7 Veterinary centres	57
References and suggested further reading	57
6. Waste minimization, recycling, and reuse	58
6.1 Waste minimization	58
6.2 Safe reuse and recycling	59
7. Handling, storage, and transportation of health-care waste	61
7.1 Waste segregation and packaging	61
7.2 On-site collection, transport, and storage of waste	64
7.2.1 Collection	64
7.2.2 Storage	64
7.2.3 On-site transport	65
7.3 Off-site transportation of waste	65
7.3.1 Regulation and control system	65
7.3.2 Special packaging requirements for off-site transport	67
7.3.3 Labelling	71
7.3.4 Labelling for radioactive waste	73
7.3.5 Preparation for transportation	74
7.3.6 Transportation vehicles or containers	75
7.3.7 Routing	76
References	76

8. Treatment and disposal technologies for health-care waste	77
8.1 Incineration	77
8.1.1 Principles of incineration	77
8.1.2 Pyrolytic incinerators	80
8.1.3 Rotary kilns	84
8.1.4 Incineration in municipal incinerators	84
8.1.5 Incineration options that meet minimum requirements	86
8.1.6 Environmental control technology for incinerators	88
8.2 Chemical disinfection	93
8.2.1 Simple chemical disinfection processes	93
8.2.2 Commercial treatment systems based on chemical disinfection	96
8.3 Wet and dry thermal treatment	98
8.3.1 Wet thermal treatment	98
8.3.2 Screw-feed technology	104
8.4 Microwave irradiation	104
8.5 Land disposal	105
8.5.1 Municipal disposal sites	105
8.5.2 Encapsulation	109
8.5.3 Safe burial on hospital premises	109
8.5.4 Land disposal of residues	111
8.6 Inertization	111
References and suggested further reading	111
9. Application of treatment and disposal methods to health-care waste categories	113
9.1 Infectious waste and sharps	113
9.2 Pharmaceutical waste	113
9.2.1 Disposal of small quantities of pharmaceutical waste	113
9.2.2 Disposal of large quantities of pharmaceutical waste	115
9.3 Cytotoxic waste	116
9.4 Chemical waste	118
9.4.1 Disposal of general chemical waste	118
9.4.2 Disposal of small quantities of hazardous chemical waste	118
9.4.3 Disposal of large quantities of hazardous chemical waste	118
9.5 Wastes with high heavy-metal content	119
9.6 Pressurized containers	119
9.7 Radioactive waste	120
9.7.1 Radioactive waste classification	120
9.7.2 Radioactive waste segregation and characterization	121
9.7.3 Management options for radioactive health-care waste	122
References and suggested further reading	128
10. Collection and disposal of wastewater	130
10.1 Characteristics and hazards of wastewater from health-care establishments	130
10.1.1 Microbiological pathogens	130

10.1.2	Hazardous chemicals	130
10.1.3	Pharmaceuticals	130
10.1.4	Radioactive isotopes	130
10.1.5	Related hazards	130
10.2	Wastewater management	131
10.2.1	Connection to a municipal sewage treatment plant	131
10.2.2	On-site treatment or pretreatment of wastewater	132
10.3	Options for establishments that apply minimal waste management programmes	133
10.3.1	Lagooning	133
10.3.2	Minimal safety requirements	133
10.3.3	Sanitation	133
	References and suggested further reading	134
11.	Costs related to health-care waste management	135
11.1	Principles	135
11.2	Methods of financing	135
11.3	Cost estimation	136
11.4	Recommendations for cost reductions	139
12.	Health and safety practices for health-care personnel and waste workers	140
12.1	Principles	140
12.2	Workers' protection	140
12.2.1	Protective clothing	140
12.2.2	Personal hygiene	142
12.2.3	Immunization	142
12.2.4	Management practices	142
12.2.5	Special precautions for clearing up spillages of potentially hazardous substances	142
12.2.6	Response to injury and exposure	142
12.3	Cytotoxic safety	143
	References and suggested further reading	144
13.	Emergency response	145
13.1	Principles	145
13.2	Dealing with spillages	145
13.3	Reporting accidents and incidents	147
14.	Hospital hygiene and infection control	148
14.1	Objective	148
14.2	Epidemiology of nosocomial infections	148
14.2.1	The transition from contamination to infection	149
14.2.2	The sources of infection	149
14.2.3	The routes of transmission	151
14.3	The prevention of nosocomial infection	151
14.3.1	Principles	151
14.3.2	Isolation of infected patients and standard precautions	153
14.3.3	Cleaning	153

14.3.4	Sterilization	153
14.3.5	Disinfection	155
14.3.6	Hand hygiene	156
	References and suggested further reading	157
15.	Training	159
15.1	Public education on hazards linked to health-care waste	159
15.2	Education and training of health-care personnel	160
15.2.1	Principles	160
15.2.2	Implementing a training course	161
15.3	Training of health-care waste management operators	163
15.3.1	Training for staff who transport waste	163
15.3.2	Training of treatment plant operators	164
15.3.3	Training of landfill operators	164
16.	Minimal programmes for health-care waste management	167
16.1	Basic principles	167
16.2	Health-care waste segregation	168
16.2.1	The waste categories	168
16.2.2	Segregation and packaging	169
16.2.3	Safe handling and storage	170
16.3	Minimization and safe recycling of health-care waste	171
16.3.1	Chemicals and pharmaceuticals	171
16.3.2	Pressurized containers	171
16.3.3	Mercury	171
16.3.4	Recyclable sharps	171
16.4	Treatment and disposal of hazardous health-care waste	172
16.4.1	Thermal processes	172
16.4.2	Wet thermal disinfection	173
16.4.3	Chemical disinfection	174
16.4.4	Containment processes	175
16.5	Management of hazardous health-care waste by waste categories	177
16.5.1	Infectious waste and sharps	177
16.5.2	Pharmaceutical waste	177
16.5.3	Chemical waste	178
16.5.4	Cytotoxic waste	179
16.5.5	Radioactive waste	179
16.5.6	Pressurized containers	179
16.5.7	Used batteries and thermometers	179
16.6	Workers' training and safety at work	180
	References and suggested further reading	180
	Glossary of terms used in the book	183
Annex 1	Guidance levels of activity for procedures in nuclear medicine for a typical adult patient	188

Safe management of wastes from health-care activities

Annex 2	Chemical destruction methods for cytostatic drugs	190
Annex 3	Clearance levels for radioactive waste	222
Annex 4	Procedure to be followed in the event of accidental contamination by mutagenic and carcinogenic products	226

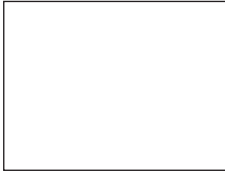

Foreword

In pursuing their aims of reducing health problems and eliminating potential risks to people's health, health-care services inevitably create waste that may itself be hazardous to health. The waste produced in the course of health-care activities carries a higher potential for infection and injury than any other type of waste. Wherever it is generated, safe and reliable methods for its handling are therefore essential. Inadequate and inappropriate handling of health-care waste may have serious public health consequences and a significant impact on the environment. Sound management of health-care waste is thus a crucial component of environmental health protection.

In both the short term and the long term, the actions involved in implementing effective health-care waste management programmes require multisectoral cooperation and interaction at all levels. Policies should be generated and coordinated globally, and the management practices implemented locally. Establishment of a national policy and a legal framework, training of personnel, and raising public awareness are essential elements of successful health-care waste management. Improved public awareness of the problem is vital in encouraging community participation in generating and implementing policies and programmes. Management of health-care waste should thus be put into a systematic, multi-faceted framework, and should become an integral feature of health-care services.

To achieve this aim, the World Health Organization, together with WHO's European Centre for Environment and Health in Nancy, France, set up an international working group to produce a practical guide, addressing particularly the problems of health-care waste management in developing countries. The group included representatives of the private sector involved in waste management activities and members of the public. This handbook, the result of their efforts, is intended to be comprehensive yet concise, "user-friendly", and oriented towards practical management of health-care waste in local facilities. It provides guidelines for the responsible national and local administrators and is the first publication to offer globally relevant advice on the management of health-care waste. The guidelines complement and supplement those produced in different regions in the past.

WHO strongly encourages the widespread implementation of these guidelines and is ready to assist users in adapting them to national settings. This book has been prepared as a practical response to the need for improved health-care waste management, especially in developing countries. Continuing efforts are being made to refine this response and feedback from users of the handbook would be appreciated. Comments and suggestions based on experience of its use may be sent to

Department of Protection of the Human Environment, World Health Organization, 1211 Geneva 27, Switzerland.

WHO has also produced a teacher's guide to complement this handbook (Prüss A, Townend WK, *Teacher's guide: management of wastes from health-care activities*; unpublished document WHO/EOS/98.6), which may be obtained from Marketing and Dissemination, World Health Organization, 1211 Geneva 27, Switzerland. The guide is designed as the basis for a three-day training course and contains overhead slides, hand-outs, exercises, illustrations, and training recommendations.

Annette Prüss
Eric Giroult
Philip Rushbrook



Acknowledgements

The valuable contributions made by the following individuals to the production of this handbook are gratefully acknowledged:

- C. Bartone, World Bank, Washington, DC, USA (reviewer)
- A.D. Bhide, National Environmental Engineering Research Institute, Nagpur, India (reviewer)
- M. Castegnaro, International Agency for Research on Cancer, Lyon, France (author and reviewer)
- E. Cole, DynCorp, Durham, NC, USA (author and reviewer)
- J. Christen, Swiss Centre for Development Cooperation in Technology and Management (SKAT), St Gallen, Switzerland (reviewer)
- G. Ducel, Fondation Hygie, Geneva, Switzerland (reviewer)
- B.R. Durand, Ministry of Health, Paris, France (author and reviewer)
- M. Giannoni, Bonnard & Gardel, Geneva, Switzerland (author and reviewer)
- A. Gur, WHO Centre for Environmental Health Activities, Amman, Jordan (reviewer)
- S. Hansel, Central Pharmacy, Lapeyronnie Hospital, Montpellier, France (author)
- P. Harteman, Public Health Laboratory, Nancy, France (author and reviewer)
- H. Kitawaki, Faculty of Regional Development Studies, University of Toyo, Toyo, Japan (resource person)
- G. Linsley, Division of Radiation and Waste Safety, International Atomic Energy Agency, Vienna, Austria (author)
- M. Manciaux, University of Nancy, Nancy, France (resource person)
- S.T.W. Miaw, Division of Radiation and Waste Safety, International Atomic Energy Agency, Vienna, Austria (author)
- H. Ogawa, WHO Regional Office for the Western Pacific, Manila, Philippines (reviewer)
- J.C. Pospisilik, WHO Regional Office for South-East Asia, New Delhi, India (reviewer)
- G. Reybrouck, University Hospital, Louvain, Belgium (author)
- A. Roth, International Solid Waste Association, Netherlands (reviewer and resource person)
- D. Saw, waste management consultant, Penang, Malaysia (author and reviewer)
- S. Shirato, Japanese Society for Medical Waste Research, Tokyo, Japan (resource person)
- F. Siem Tjam, Department of Health Systems, World Health Organization, Geneva, Switzerland (reviewer)

M.H. Sportouch, Central Pharmacy, Lapeyronnie Hospital, Montpellier, France (author)

C. Struck, Ingenius, Berlin, Germany (reviewer)

E. Tikhomirov, Department of Communicable Disease Surveillance and Response, World Health Organization, Geneva, Switzerland (reviewer)

W. Townend, Environmental Agency, London, England (author and reviewer)

M. Wilson, Environmental Protection Agency, Washington, DC, USA (resource person)

Wong Sze-Pong, WHO Regional Office for Africa, Brazzaville, Congo (reviewer)

F. Zepeda, WHO Regional Office for the Americas/Pan American Sanitary Bureau, Washington, DC, USA (reviewer)

The World Health Organization thanks all institutions and individuals who have provided information and helped to make this handbook possible; particular thanks are due for the contributions made by the International Agency for Research on Cancer, the International Atomic Energy Agency, the International Solid Waste Association, the United States Environmental Protection Agency, the Japanese Society for Research on Medical Waste, and the Swiss Corporation for Appropriate Technology.

1

Introduction

This handbook recommends safe, efficient, sustainable, and—it is hoped—affordable and culturally acceptable methods for the treatment and disposal of health-care waste, both within and outside health-care establishments. Particular attention is paid to basic processes and technologies; more sophisticated or advanced methods, many of which have been undergoing major developments, are often addressed in less detail. Smaller health-care establishments in remote locations or with very limited resources may wish to confine themselves to the minimal health-care waste management programme recommended in Chapter 16.

In publishing this handbook, WHO aims not only to promote a sound managerial approach and the use of appropriate technologies, but also to inform countries about the health risks that result from inadequate management of health-care waste. The advice and guidance offered are intended to assist both national bodies and individual medical institutions to improve health-care waste management. Some countries may choose to develop their own regulations and practices; others may elect to use the information provided in this handbook as the basis for their policies and for guidance. The intended readership includes public health managers, hospital managers and other administrators of health-care establishments, policy-makers, regulators, waste managers, and environmental health professionals.

Health-care waste management, as well as posing technical problems, is strongly influenced by cultural, social, and economic circumstances. A well designed waste policy, a legislative framework, and plans for achieving local implementation are essential. Change will be gradual and should be technically and financially sustainable in the long term.

Hospitals and other health-care establishments have a “duty of care” for the environment and for public health, and have particular responsibilities in relation to the waste they produce. The onus is on such establishments to ensure that there are no adverse health and environmental consequences of their waste handling, treatment, and disposal activities. By implementing a health-care waste management policy, including the components outlined in this handbook, medical and research facilities are moving toward the achievement of a healthy and safe environment for their employees and communities.

It should be understood that this handbook does not specifically address the management of wastes from animal health-care/veterinary establishments: any reference to animal waste deals only with that resulting from the use of animals in research into human medicine.

2

Definition and characterization of health-care waste

2.1 Health-care waste: definition and classification

2.1.1 *Definition*

Health-care waste includes all the waste generated by health-care establishments, research facilities, and laboratories. In addition, it includes the waste originating from “minor” or “scattered” sources—such as that produced in the course of health care undertaken in the home (dialysis, insulin injections, etc.).

Between 75% and 90% of the waste produced by health-care providers is non-risk or “general” health-care waste, comparable to domestic waste. It comes mostly from the administrative and housekeeping functions of health-care establishments and may also include waste generated during maintenance of health-care premises. The remaining 10–25% of health-care waste is regarded as hazardous and may create a variety of health risks (see Chapter 3). This handbook is concerned almost exclusively with hazardous health-care waste (also known as “health-care risk waste”); general wastes should be dealt with by the municipal waste disposal mechanisms.

Classification of hazardous health-care waste is summarized in Table 2.1 and described in more detail in sections 2.1.2 to 2.1.10.

2.1.2 *Infectious waste*

Infectious waste is suspected to contain pathogens (bacteria, viruses, parasites, or fungi) in sufficient concentration or quantity to cause disease in susceptible hosts. This category includes:

- cultures and stocks of infectious agents from laboratory work;
- waste from surgery and autopsies on patients with infectious diseases (e.g. tissues, and materials or equipment that have been in contact with blood or other body fluids);
- waste from infected patients in isolation wards (e.g. excreta, dressings from infected or surgical wounds, clothes heavily soiled with human blood or other body fluids);
- waste that has been in contact with infected patients undergoing haemodialysis (e.g. dialysis equipment such as tubing and filters, disposable towels, gowns, aprons, gloves, and laboratory coats);
- infected animals from laboratories;
- any other instruments or materials that have been in contact with infected persons or animals.

Note: Infected “sharps” are a subcategory of infectious waste but are dealt with separately in this handbook (see section 2.1.4).

Table 2.1 *Categories of health-care waste*

Waste category	Description and examples
Infectious waste	Waste suspected to contain pathogens e.g. laboratory cultures; waste from isolation wards; tissues (swabs), materials, or equipment that have been in contact with infected patients; excreta
Pathological waste	Human tissues or fluids e.g. body parts; blood and other body fluids; fetuses
Sharps	Sharp waste e.g. needles; infusion sets; scalpels; knives; blades; broken glass
Pharmaceutical waste	Waste containing pharmaceuticals e.g. pharmaceuticals that are expired or no longer needed; items contaminated by or containing pharmaceuticals (bottles, boxes)
Genotoxic waste	Waste containing substances with genotoxic properties e.g. waste containing cytostatic drugs (often used in cancer therapy); genotoxic chemicals
Chemical waste	Waste containing chemical substances e.g. laboratory reagents; film developer; disinfectants that are expired or no longer needed; solvents
Wastes with high content of heavy metals	Batteries; broken thermometers; blood-pressure gauges; etc.
Pressurized containers	Gas cylinders; gas cartridges; aerosol cans
Radioactive waste	Waste containing radioactive substances e.g. unused liquids from radiotherapy or laboratory research; contaminated glassware, packages, or absorbent paper; urine and excreta from patients treated or tested with unsealed radionuclides; sealed sources

Cultures and stocks of highly infectious agents, waste from autopsies, animal bodies, and other waste items that have been inoculated, infected, or in contact with such agents are called **highly infectious waste**.

2.1.3 Pathological waste

Pathological waste consists of tissues, organs, body parts, human fetuses and animal carcasses, blood, and body fluids. Within this category, recognizable human or animal body parts are also called **anatomical waste**. This category should be considered as a subcategory of infectious waste, even though it may also include healthy body parts.

2.1.4 Sharps

Sharps are items that could cause cuts or puncture wounds, including needles, hypodermic needles, scalpel and other blades, knives, infusion sets, saws, broken glass, and nails. Whether or not they are infected, such items are usually considered as highly hazardous health-care waste.

2.1.5 Pharmaceutical waste

Pharmaceutical waste includes expired, unused, spilt, and contaminated pharmaceutical products, drugs, vaccines, and sera that are no longer required and need to be disposed of appropriately. The category also includes discarded items used in the handling of pharmaceuticals, such

as bottles or boxes with residues, gloves, masks, connecting tubing, and drug vials.

2.1.6 Genotoxic waste

Genotoxic waste is highly hazardous and may have mutagenic, teratogenic, or carcinogenic properties. It raises serious safety problems, both inside hospitals and after disposal, and should be given special attention. Genotoxic waste may include certain cytostatic drugs (see below), vomit, urine, or faeces from patients treated with cytostatic drugs, chemicals, and radioactive material.

Cytotoxic (or antineoplastic) drugs, the principal substances in this category, have the ability to kill or stop the growth of certain living cells and are used in chemotherapy of cancer. They play an important role in the therapy of various neoplastic conditions but are also finding wider application as immunosuppressive agents in organ transplantation and in treating various diseases with an immunological basis. Cytotoxic drugs are most often used in specialized departments such as oncology and radiotherapy units, whose main role is cancer treatment; however, their use in other hospital departments is increasing and they may also be used outside the hospital setting.

The most common genotoxic substances used in health care are listed in Box 2.1.

Box 2.1 Most common genotoxic products used in health care^a

Classified as carcinogenic

Chemicals:

benzene

Cytotoxic and other drugs:

azathioprine, chlorambucil, chlornaphazine, ciclosporin, cyclophosphamide, melphalan, semustine, tamoxifen, thiotepa, treosulfan

Radioactive substances:

(radioactive substances are treated as a separate category in this handbook)

Classified as possibly or probably carcinogenic

Cytotoxic and other drugs:

azacitidine, bleomycin, carmustine, chloramphenicol, chlorozotocin, cisplatin, dacarbazine, daunorubicin, dihydroxymethylfuratrizine (e.g. Panfuran S—no longer in use), doxorubicin, lomustine, methylthiouracil, metronidazole, mitomycin, nafenopin, niridazole, oxazepam, phenacetin, phenobarbital, phenytoin, procarbazine hydrochloride, progesterone, sarcolysin, streptozocin, trichlormethine

^aClassified by working groups of the International Agency for Research on Cancer (IARC).

Harmful cytostatic drugs can be categorized as follows:

- alkylating agents: cause alkylation of DNA nucleotides, which leads to cross-linking and miscoding of the genetic stock;
- antimetabolites: inhibit the biosynthesis of nucleic acids in the cell;
- mitotic inhibitors: prevent cell replication.

Cytotoxic wastes are generated from several sources and can include the following:

- contaminated materials from drug preparation and administration, such as syringes, needles, gauges, vials, packaging;
- outdated drugs, excess (leftover) solutions, drugs returned from the wards;
- urine, faeces, and vomit from patients, which may contain potentially hazardous amounts of the administered cytostatic drugs or of their metabolites and which should be considered genotoxic for at least 48 hours and sometimes up to 1 week after drug administration.

In specialized oncological hospitals, genotoxic waste (containing cytostatic or radioactive substances) may constitute as much as 1% of the total health-care wastes.

2.1.7 *Chemical waste*

Chemical waste consists of discarded solid, liquid, and gaseous chemicals, for example from diagnostic and experimental work and from cleaning, housekeeping, and disinfecting procedures. Chemical waste from health care may be hazardous or nonhazardous; in the context of protecting health, it is considered to be hazardous if it has at least one of the following properties:

- toxic;
- corrosive (e.g. acids of pH < 2 and bases of pH > 12);
- flammable;
- reactive (explosive, water-reactive, shock-sensitive);
- genotoxic (e.g. cytostatic drugs).

Nonhazardous chemical waste consists of chemicals with none of the above properties, such as sugars, amino acids, and certain organic and inorganic salts.

The types of hazardous chemicals used most commonly in maintenance of health-care centres and hospitals and the most likely to be found in waste are discussed in the following paragraphs.

Formaldehyde

Formaldehyde is a significant source of chemical waste in hospitals. It is used to clean and disinfect equipment (e.g. haemodialysis or surgical equipment), to preserve specimens, to disinfect liquid infectious waste, and in pathology, autopsy, dialysis, embalming, and nursing units.

Photographic chemicals

Photographic fixing and developing solutions are used in X-ray departments. The fixer usually contains 5–10% hydroquinone, 1–5% potassium hydroxide, and less than 1% silver. The developer contains approxi-

mately 45% glutaraldehyde. Acetic acid is used in both stop baths and fixer solutions.

Solvents

Wastes containing solvents are generated in various departments of a hospital, including pathology and histology laboratories and engineering departments. Solvents used in hospitals include halogenated compounds, such as methylene chloride, chloroform, trichloroethylene, and refrigerants, and non-halogenated compounds such as xylene, methanol, acetone, isopropanol, toluene, ethyl acetate, and acetonitrile.

Organic chemicals

Waste organic chemicals generated in health-care facilities include:

- disinfecting and cleaning solutions such as phenol-based chemicals used for scrubbing floors, perchlorethylene used in workshops and laundries;
- oils such as vacuum-pump oils, used engine oil from vehicles (particularly if there is a vehicle service station on the hospital premises);
- insecticides, rodenticides.

Inorganic chemicals

Waste inorganic chemicals consist mainly of acids and alkalis (e.g. sulfuric, hydrochloric, nitric, and chromic acids, sodium hydroxide and ammonia solutions). They also include oxidants, such as potassium permanganate (KMnO_4) and potassium dichromate ($\text{K}_2\text{Cr}_2\text{O}_7$), and reducing agents, such as sodium bisulfite (NaHSO_3) and sodium sulfite (Na_2SO_3).

2.1.8 Wastes with high content of heavy metals

Wastes with a high heavy-metal content represent a subcategory of hazardous chemical waste, and are usually highly toxic. Mercury wastes are typically generated by spillage from broken clinical equipment but their volume is decreasing with the substitution of solid-state electronic sensing instruments (thermometers, blood-pressure gauges, etc.). Whenever possible, spilled drops of mercury should be recovered. Residues from dentistry have a high mercury content. Cadmium waste comes mainly from discarded batteries. Certain “reinforced wood panels” containing lead are still used in radiation proofing of X-ray and diagnostic departments. A number of drugs contain arsenic, but these are treated here as pharmaceutical waste.

2.1.9 Pressurized containers

Many types of gas are used in health care (see Box 2.2), and are often stored in pressurized cylinders, cartridges, and aerosol cans. Many of these, once empty or of no further use (although they may still contain residues), are reusable, but certain types—notably aerosol cans—must be disposed of.

Whether inert or potentially harmful, gases in pressurized containers should always be handled with care; containers may explode if incinerated or accidentally punctured.

Box 2.2 Most common gases used in health care

Anaesthetic gases:

nitrous oxide, volatile halogenated hydrocarbons (such as halothane, isoflurane, and enflurane), which have largely replaced ether and chloroform.

Applications—in hospital operating theatres, during childbirth in maternity hospitals, in ambulances, in general hospital wards during painful procedures, in dentistry, for sedation, etc.

Ethylene oxide

Applications—for sterilization of surgical equipment and medical devices, in central supply areas, and, at times, in operating rooms.

Oxygen

Stored in bulk tank or cylinders, in gaseous or liquid form, or supplied by central piping.

Application—inhalation supply for patients.

Compressed air

Applications—in laboratory work, inhalation therapy equipment, maintenance equipment, and environmental control systems.

2.1.10 Radioactive waste

Background on radioactivity

Ionizing radiations cannot be detected by any of the senses and—other than burns, which may occur in exposed areas—usually cause no immediate effects unless an individual receives a very high dose. The ionizing radiations of interest in medicine include the X-rays, α - and β -particles, and γ -rays emitted by radioactive substances. An important practical difference between these types of radiation is that X-rays from X-ray tubes are emitted only when generating equipment is switched on, whereas radiation from radionuclides can never be switched off and can be avoided only by shielding the material.

Radionuclides continuously undergo spontaneous disintegration (known as “radioactive decay”) in which energy is liberated, generally resulting in the formation of new nuclides. The process is accompanied by the emission of one or more types of radiation, such as α - and β -particles and γ -rays. These cause ionization of intracellular material; radioactive substances are therefore genotoxic.

- *α -Particles* are heavy, positively charged, and include protons and neutrons. They have a low penetration power, and are hazardous to humans mostly when inhaled or ingested.
- *β -Particles* are negatively or positively charged electrons with significant ability to penetrate human skin; they affect health through ionization of intracellular proteins and proteinaceous components.
- *γ -Rays* are electromagnetic radiations similar to X-rays but of shorter wavelength. Their penetrating power is high and lead (or thick concrete) shielding is required to reduce their intensity.

Disintegration is measured in terms of the time required for the radioactivity to decrease by half—the “half-life”. Each radionuclide has a characteristic half-life, which is constant and by which it may be identified. Half-lives range from fractions of a second to millions of years. Values for the most common radionuclides used in nuclear medicine are listed in Table 2.2.

The *activity* of a radioactive substance corresponds to the disintegration rate and is measured in becquerels (Bq), the SI unit that has replaced the curie (Ci):

$$1 \text{ Bq} = 1 \text{ disintegration per second}$$

$$1 \text{ Ci} = 3.7 \times 10^{10} \text{ Bq}$$

The amount of energy absorbed, per unit mass, as a result of exposure to ionizing radiation is called the *absorbed dose* and is expressed in gray (Gy); this SI unit has replaced the rad (1 Gy = 100 rad). However, different types of radiation have different effects according to the biological material and the type of tissue. To allow for these differences, absorbed dose is averaged over an organ or tissue and “weighted” for the type of radiation. This yields the *equivalent dose*, measured in sievert (Sv), which replaces the rem (1 Sv = 100 rem).

Radioactive substances used in health care and generating waste

Radioactive waste includes solid, liquid, and gaseous materials contaminated with radionuclides. It is produced as a result of procedures such as *in-vitro* analysis of body tissue and fluid, *in-vivo* organ imaging and tumour localization, and various investigative and therapeutic practices.

Table 2.2 *Principal radionuclides used in health-care establishments^a*

Radionuclide ^b	Emission	Format	Half-life	Application
³ H	β	Unsealed	12.3 years	Research
¹⁴ C	β	Unsealed	5730 years	Research
³² P	β	Unsealed	14.3 days	Diagnosis; therapy
⁵¹ Cr	γ	Unsealed	27.8 days	<i>In-vitro</i> diagnosis
⁵⁷ Co	β	Unsealed	271 days	<i>In-vitro</i> diagnosis
⁶⁰ Co	β	Sealed	5.3 years	Diagnosis; therapy; research
⁵⁹ Fe	β	Unsealed	45 days	<i>In-vitro</i> diagnosis
⁶⁷ Ga	γ	Unsealed	78 hours	Diagnostic imaging
⁷⁵ Se	γ	Unsealed	119 days	Diagnostic imaging
⁸⁵ Kr	β	Unsealed	10.7 years	Diagnostic imaging; research
^{99m} Tc	γ	Unsealed	6 hours	Diagnostic imaging
¹²³ I	γ	Unsealed	13.1 hours	Diagnostic uptake; therapy
¹²⁵ I	γ	Unsealed	60 days	Diagnostic uptake; therapy
¹³¹ I	β	Unsealed	8 days	Therapy
¹³³ Xe	β	Unsealed	5.3 days	Diagnostic imaging
¹³⁷ Cs	β	Sealed	30 years	Therapy; research
¹⁹² Ir	β	Sealed (ribbons)	74 days	Therapy
¹⁹⁸ Au	β	Sealed (seeds)	2.3 days	Therapy
²²² Rn	α	Sealed (seeds)	3.8 days	Therapy
²²⁶ Ra	α	Sealed	1600 years	Therapy

^a Adapted from WHO (1985).

^b ³H and ¹⁴C used for research purposes account for the largest amount of radioactive health-care waste.

Radionuclides used in health care are usually conditioned in unsealed (or “open”) sources or sealed sources. Unsealed sources are usually liquids that are applied directly and not encapsulated during use; sealed sources are radioactive substances contained in parts of equipment or apparatus or encapsulated in unbreakable or impervious objects such as “seeds” or needles.

Radioactive health-care waste usually contains radionuclides with short half-lives, which lose their activity relatively quickly (see Table 2.2). Certain therapeutic procedures, however, require the use of radionuclides with longer half-lives; these are usually in the form of pins, needles, or “seeds” and may be reused on other patients after sterilization.

The type and form of radioactive material used in health-care establishments usually results in low-level radioactive waste (<1MBq). Waste in the form of sealed sources may be of fairly high activity, but is only generated in low volumes from larger medical and research laboratories. Sealed sources are generally returned to the supplier and so do not enter the waste stream. The principal activities involving use of radioactive substances, and the waste they generate, are described in Box 2.3. The most common radionuclides used in diagnostic nuclear medicine and the maximum activity per diagnostic test are listed in Annex 1.

The waste produced by health-care and research activities involving radionuclides, and related activities such as equipment maintenance, storage, etc., can be classified as follows:

- sealed sources;
- spent radionuclide generators;
- low-level solid waste, e.g. absorbent paper, swabs, glassware, syringes, vials;
- residues from shipments of radioactive material and unwanted solutions of radionuclides intended for diagnostic or therapeutic use;
- liquid immiscible with water, such as liquid scintillation-counting residues used in radioimmunoassay, and contaminated pump oil;
- waste from spills and from decontamination of radioactive spills;
- excreta from patients treated or tested with unsealed radionuclides;
- low-level liquid waste, e.g. from washing apparatus;
- gases and exhausts from stores and fume cupboards.

2.2 Sources of health-care waste

The sources of health-care waste can be classed as major or minor according to the quantities produced. The major sources are listed in Box 2.4.

While minor and scattered sources may produce some health-care waste in categories similar to hospital waste, their composition will be different. For example:

- they rarely produce radioactive or cytostatic waste;
- human body parts are generally not included;
- sharps consist mainly of hypodermic needles.

Minor sources of health-care waste are listed in Box 2.5.

Box 2.3 Health care and research involving radionuclides, and waste produced

Nuclear medicine laboratories

Unsealed sources

Diagnostic procedures (organ imaging, tumour localization): use preparations with activities up to 800 MBq (or even 6000 MBq for certain lung-imaging techniques) and short half-life. Over 90% of diagnostic nuclear medicine applications use ^{99m}Tc .

Therapeutic applications (radiotherapy): use preparations of ^{32}P , ^{125}I and ^{131}I , which are of a much higher level of activity. However, these applications are infrequent. They are used in the activity range of up to 1 GBq to treat hyperthyroidism and up to 10 GBq to treat thyroid carcinoma.

Generated waste: glassware, syringes, absorbent paper, solutions, excreta from patients treated or tested with unsealed radionuclides. Waste from diagnostic procedures is usually low-level; wastes from therapeutic applications, however, may be relatively high-level. All radionuclides used have relatively short half-lives (between 6 hours and 60 days).

Sealed sources

Therapeutic applications: use sealed sources that generally involve radionuclides with high activity levels and long half-lives (e.g. cobalt, caesium). In teletherapy the source is comparatively distant from the patient's body; brachytherapy usually employs small sources to deliver doses at distances up to a few centimetres, by surface, intracavitary, or interstitial application.

Generated waste: these activities do not routinely generate radioactive waste. Sources should be reused as long as is feasible, or returned to the supplier when exhausted or no longer required.

Research laboratories

Generated waste: significant quantities of ^{14}C and ^3H (both with long half-lives) are used in research activities, which therefore generate large volumes of waste with low activity.

Clinical laboratories

Generated waste: laboratories involved in radioimmunoassay produce relatively large volumes of waste with low radioactivity, including gases (e.g. ^{85}Kr , ^{133}Xe).

The composition of wastes is often characteristic of the type of source. For example, the different units within a hospital would generate waste with the following characteristics:

- *Medical wards*: mainly infectious waste such as dressings, bandages, sticking plaster, gloves, disposable medical items, used hypodermic needles and intravenous sets, body fluids and excreta, contaminated packaging, and meal scraps.
- *Operating theatres and surgical wards*: mainly anatomical waste such as tissues, organs, fetuses, and body parts, other infectious waste, and sharps.

Box 2.4 Major sources of health-care waste

Hospitals

- University hospital
- General hospital
- District hospital

Other health-care establishments

- Emergency medical care services
- Health-care centres and dispensaries
- Obstetric and maternity clinics
- Outpatient clinics
- Dialysis centres
- First-aid posts and sick bays
- Long-term health-care establishments and hospices
- Transfusion centres
- Military medical services

Related laboratories and research centres

- Medical and biomedical laboratories
- Biotechnology laboratories and institutions
- Medical research centres

Mortuary and autopsy centres

Animal research and testing

Blood banks and blood collection services

Nursing homes for the elderly

- *Other health-care units:* mostly general waste with a small percentage of infectious waste.
- *Laboratories:* mainly pathological (including some anatomical), highly infectious waste (small pieces of tissue, microbiological cultures, stocks of infectious agents, infected animal carcasses, blood and other body fluids), and sharps, plus some radioactive and chemical waste.
- *Pharmaceutical and chemical stores:* small quantities of pharmaceutical and chemical wastes, mainly packaging (containing only residues if stores are well managed), and general waste.
- *Support units:* general waste only.

Health-care waste from scattered sources generally has the following characteristic composition:

- *Health care provided by nurses:* mainly infectious waste and many sharps.
- *Physicians' offices:* mainly infectious waste and some sharps.
- *Dental clinics and dentists' offices:* mainly infectious waste and sharps, and wastes with high heavy-metal content.
- *Home health care* (e.g. dialysis, insulin injections): mainly infectious waste and sharps.

Box 2.5 Minor sources of health-care waste

Small health-care establishments

- Physicians' offices
- Dental clinics
- Acupuncturists
- Chiropractors

Specialized health-care establishments and institutions with low waste generation

- Convalescent nursing homes
- Psychiatric hospitals
- Disabled persons' institutions

Non-health activities involving intravenous or subcutaneous interventions

- Cosmetic ear-piercing and tattoo parlours
- Illicit drug users

Funeral services

Ambulance services

Home treatment

2.3 Health-care waste generation

Several surveys have provided an indication of typical health-care waste generation. Data from some of these surveys are summarized in Tables 2.3 to 2.6 and show that generation of health-care wastes differs not only from country to country but also within a country. Waste generation depends on numerous factors such as established waste management methods, type of health-care establishment, hospital specializations, proportion of reusable items employed in health care, and proportion of patients treated on a day-care basis. It is therefore suggested that these data are viewed only as examples, and not used as a basis for waste management within an individual health-care establishment. Even a limited survey will probably provide more reliable data on local waste generation than any estimate based on data from other countries or types of establishment.

In middle- and low-income countries, health-care waste generation is usually lower than in high-income countries. However, the range of values for countries of similar income level is probably as wide in high-income countries (Table 2.4) as in less wealthy countries.

The amount of radioactive health-care waste is generally extremely small compared with the radioactive waste produced by the nuclear industry.

Developing countries that have not performed their own surveys of health-care waste may find the following estimates for average

Table 2.3 *Health-care waste generation according to national income level^f*

National income level	Annual waste generation (kg/head of population)
High-income countries:	
— all health-care waste	1.1–12.0
— hazardous health-care waste	0.4–5.5
Middle-income countries:	
— all health-care waste	0.8–6.0
— hazardous health-care waste	0.3–0.4
Low-income countries:	
— all health-care waste	0.5–3.0

^fSources: Commission of the European Union (1995), Halbwachs (1994), Durand (1995).

Table 2.4 *Health-care waste generation according to source size^a*

Source	Daily waste generation ^b (kg/bed)
University hospital	4.1–8.7
General hospital	2.1–4.2
District hospital	0.5–1.8
Primary health-care centre	0.05–0.2

^aSource: Economopoulos (1993).

^bData from high-income countries.

Table 2.5 *Total health-care waste generation by region^a*

Region	Daily waste generation (kg/bed)
North America	7–10
Western Europe	3–6
Latin America	3
Eastern Asia:	
— high-income countries	2.5–4
— middle-income countries	1.8–2.2
Eastern Europe	1.4–2
Eastern Mediterranean	1.3–3

^aSources: Durand (personal communication, 1995), Johannessen (1997). Further information may be obtained from International Healthcare Waste Network, 12–14 avenue Paul Vaillant Couturier, 94804 Villejuif, France.

Table 2.6 *Hospital waste generation by waste type (western Europe)^a*

Waste class	Daily waste generation (kg/bed)
Chemical and pharmaceutical waste	0.5
Sharps	0.04
Combustible packaging	0.5

^aSource: Durand (personal communication, 1995). Further information may be obtained from International Healthcare Waste Network, 12–14 avenue Paul Vaillant Couturier, 94804 Villejuif, France.

distribution of health-care wastes useful for *preliminary* planning of waste management:

- 80% general health-care waste, which may be dealt with by the normal domestic and urban waste management system;
- 15% pathological and infectious waste;
- 1% sharps waste;
- 3% chemical or pharmaceutical waste;
- less than 1% special waste, such as radioactive or cytostatic waste, pressurized containers, or broken thermometers and used batteries.

Before further planning is undertaken, health-care establishments should make estimates of their own waste production, particularly for hazardous health-care wastes. Typical figures for small producers of health-care wastes in Europe are given in Table 2.7.

A survey carried out in selected countries in Latin America and the Caribbean provides estimates of hazardous waste produced by health-care facilities; data are summarized in Box 2.6. Boxes 2.7 and 2.8 contain data on health-care wastes generated in the United Republic of Tanzania and in Botswana.

2.4 Physicochemical characteristics of hazardous health-care waste

When the use of treatment techniques such as incineration is planned, a number of physicochemical parameters of the waste should be assessed

Table 2.7 *Health-care waste generation for small waste generators (Europe)^a*

Source type	Waste generation (kg/year)
General practitioners:	
— sharps	4
— infectious waste	20
— total waste	100
Phlebotomists:	
— infectious waste	175
Gynaecologists:	
— infectious waste	350
Nurses:	
— sharps	20
— infectious waste	100
Dentists:	
— sharps	11
— infectious waste	50
— heavy metals (including mercury)	2.5
— total waste	260
Biomedical laboratories (60 analyses per day):	at least 300
— infectious waste	
Kidney dialysis (3 per week):	
— infectious waste	400

^aSource: Durand (personal communication, 1995). Further information may be obtained from International Healthcare Waste Network, 12–14 avenue Paul Vaillant Couturier, 94804 Villejuif, France.

Box 2.6 Hazardous health-care waste quantities produced in health-care facilities in selected countries of Latin America and the Caribbean^a

Country	Number of beds	Hazardous waste generation ^b (tonnes/year)
Argentina	150 000	32 850
Brazil	501 660	109 960
Cuba	50 293	11 010
Jamaica	5 745	1 260
Mexico	60 100	13 160
Venezuela	47 200	10 340

^aSource: PAHO (1994), used with permission.

^bThese estimates are based on 0.22 tonnes/year for each bed in a health-care establishment.

Box 2.7 Health-care waste generation in government health facilities of Dar es Salaam (United Republic of Tanzania)^a

Health-care facility	Health-care waste quantities in 1995/1996 ^b	
	Non-hazardous waste (kg/day per patient)	Hazardous waste (kg/day per patient)
District hospital (in- and outpatients)	0.06	0.08
Health centres (urban)	0.01	0.01
Dispensaries:		
— rural	0.02	0.02
— urban	0.01	0.01

^aSource: Christen (1996), used with permission.

^bAverage quantities estimated on the basis of a survey conducted in a representative number of health-care establishments in Dar es Salaam.

or estimated.¹ Table 2.8 provides typical figures for percentage of combustibles, heating value, and moisture content of waste. It is also important to assess the composition of waste, which varies greatly not only from country to country but also among facilities within any given country. This variation may be due to different hospital specializations, waste management practices, use of reusable items, etc. As examples, Boxes 2.9, 2.10, and 2.11 contain data from surveys in Italy, China (Province of

¹ Instructions on the estimation of several of these parameters may be found in WHO-CEPIS (1994), Annex 2. An English version of this document was planned when the text of the present handbook was finalized.

Table 2.8 *Physical parameters*

Parameter	Minimum value	Maximum value	Average value
Percentage of combustible matter	83%	99%	—
Low heating value	3000 kcal/kg (12550 kJ/kg)	6000 kcal/kg (25 100 kJ/kg)	—
Moisture content	0% (for plastic waste)	90% (for some anatomical waste)	35%

Box 2.8 **Estimated health-care waste production in Botswana^{a,b}**

Facility	Health-care waste, excluding sharps (kg/day)	Sharps (containers ^c)	Household waste (kg/day)
Referral and regional hospitals	0.75/bed	1.5/100 beds per day	3/bed
Private hospitals	1.0/bed	2/100 beds per day	4/bed
Primary hospitals	0.5/bed	1/100 beds per day	2/bed
Urban clinics with beds	20	2/30 days	40
Rural clinics with beds	10	2/30 days	20
Urban clinics	15	2/30 days	30
Rural clinics	7	2/30 days	15
Health posts	2.5	1/30 days	5
Medical and veterinary practices	2.5	1/30 days	5

^aSource: NCSA (1996, plus personal communication); used with permission.

^bThese data were estimated on the basis of questionnaires sent to health-care facilities and subsequent visits, in 1995–1998.

^cSharps container capacity: 4 litres.

Box 2.9 **Average composition of hospital waste in Italy**

The data below are derived from a survey conducted in a large hospital in southern Italy in 1992 (Liberti et al., 1994).

Material	Percentage (wet-weight basis)
Paper	34
Plastics	46
Glass	7.5
Metals	0.4
Anatomical waste	0.1
Liquids	12
Others	0.1

Box 2.10 Composition of waste from three hospitals in Taiwan, China^a

Material	Percentage (by weight)		
	University hospital	Hospital A	Hospital B
Paper	16	34	51
Plastics	50	21	18
Textiles	10	14	2
Food waste	21	17	7
Metals (sharps etc.)	0.5	1	9
Glass	1	11	8
Others	1.5	2	5

^aSource: Chih-Shan & Fu-Tien (1993), used with permission.

Box 2.11 Average composition of hospital waste in India^a

The data below are average values obtained from 10 large hospitals in Bombay, Calcutta, Delhi, and Nagpur during the period 1993–1996.

Material	Percentage (wet-weight basis)
Paper	15
Plastics	10
Rags	15
Metals (sharps, etc.)	1
Infectious waste	1.5
Glass	4.0
General waste (food waste, sweepings from hospital premises)	53.5

^aSource: National Environmental Engineering Research Institute (personal communication, 1997).

Taiwan), and India, respectively. A survey of general hospitals in Italy yielded characterization data for hazardous health-care waste; these data are summarized in Box 2.12. A typical low heating value of wet hazardous health-care waste in middle-income developing countries would be 3500 kcal/kg (14.65 MJ/kg).

The approximate chemical composition of general health-care waste is usually as follows:

- 50% carbon
- 20% oxygen
- 6% hydrogen
- numerous other elements.

Box 2.12 Hazardous health-care waste characterization data

The following data are derived from a survey performed in several Italian general hospitals of different size (Liberti et al., 1994). They are based on daily waste production of 4.0 litres or 0.44 kg per bed in use.

Density:	0.11 kg/litre
Heating value:	
high:	dry waste 5400 kcal/kg (22.6 MJ/kg) wet waste 3900 kcal/kg (16.3 MJ/kg)
low:	wet waste 3500 kcal/kg (14.65 MJ/kg)
Chlorine content:	0.4%
Mercury content:	2.5 mg/kg
Cadmium content:	1.5 mg/kg
Lead content:	28 mg/kg

Assessing the type of plastic used in health-care activities, and if possible the percentage of halogenated plastics (such as polyvinyl chloride), would indicate the cleaning requirements for exhaust gases if waste is incinerated. Certain types of plastics are now frequently labelled with internationally recognized symbols to facilitate identification of halogenated plastics.

References and suggested further reading

- Chih-Shan L, Fu-Tien J (1993). Physical and chemical composition of hospital waste. *Infection control and hospital epidemiology*, 14(3):145–150.
- Christen J (1996). *Dar es Salaam Urban Health Project. Health care waste management in district health facilities: situational analysis and system development*. St. Gallen, Switzerland, Swiss Centre for Development Cooperation in Technology and Management (SKAT).
- Economopoulos AP (1993). *Assessment of sources of air, water and land pollution. A guide to rapid source inventory techniques and their use in formulating environmental control strategies. Part 1: Rapid inventory techniques in environmental pollution*. Geneva, World Health Organization.
- Halbwachs H (1994). Solid waste disposal in district health facilities. *World health forum*, 15:363–367.
- Johannessen LM (1997). Management of health care waste. In: *Proceedings in Environment '97 Conference, 16–18 February 1997, Cairo*. Dokki-Giza, Egyptian Environmental Affairs Agency.
- Liberti L et al. (1994). Optimization of infectious hospital waste management in Italy. Part I: Waste production and characterization study. *Waste management and research*, 12(5): 373–385.
- NCSA (1996). *Study on the management of medical wastes*. Gaborone, Botswana, National Conservation Strategy (Co-ordinating) Agency (Report No. NCS/GTZ 7/96, in cooperation with the German Agency for Technical Cooperation, coordinated by Integrated Skills Ltd).

Definition and characterization of health-care waste

- PAHO (1994). *Hazardous waste and health in Latin America and the Caribbean*. Washington, DC, Pan American Health Organization.
- WHO (1985). *Management of waste from hospitals and other health care establishments. Report on a WHO meeting, Bergen, 28 June–1 July 1983*. Copenhagen, World Health Organization Regional Office for Europe (EURO Reports and Studies, No. 97).
- WHO/CEPIS (1994). *Guía para el manejo interno de residuos sólidos hospitalarios. [Guide to the internal management of solid hospital waste.]* Lima, World Health Organization/Pan American Sanitary Engineering and Environmental Sciences Center.

3

Health impacts of health-care waste

3.1 Hazards of health-care waste

Health-care waste includes a large component of general waste and a smaller proportion of hazardous waste. This chapter addresses the potential hazards of exposure to hazardous (or risk) health-care waste.

3.1.1 *Types of hazards*

Exposure to hazardous health-care waste can result in disease or injury. The hazardous nature of health-care waste may be due to one or more of the following characteristics:

- it contains infectious agents;
- it is genotoxic;
- it contains toxic or hazardous chemicals or pharmaceuticals;
- it is radioactive;
- it contains sharps.

3.1.2 *Persons at risk*

All individuals exposed to hazardous health-care waste are potentially at risk, including those within health-care establishments that generate hazardous waste, and those outside these sources who either handle such waste or are exposed to it as a consequence of careless management. The main groups at risk are the following:

- medical doctors, nurses, health-care auxiliaries, and hospital maintenance personnel;
- patients in health-care establishments or receiving home care;
- visitors to health-care establishments;
- workers in support services allied to health-care establishments, such as laundries, waste handling, and transportation;
- workers in waste disposal facilities (such as landfills or incinerators), including scavengers.

The hazards associated with scattered, small sources of health-care waste should not be overlooked; waste from these sources includes that generated by home-based health care, such as dialysis, and that generated by illicit drug use (usually intravenous).

3.1.3 *Hazards from infectious waste and sharps*

Infectious waste may contain any of a great variety of pathogenic microorganisms. Pathogens in infectious waste may enter the human body by a number of routes:

- through a puncture, abrasion, or cut in the skin;
- through the mucous membranes;
- by inhalation;
- by ingestion.

Examples of infections that can be caused by exposure to health-care waste are listed in Table 3.1, together with the body fluids that are the usual vehicles of transmission.

There is particular concern about infection with human immunodeficiency virus (HIV) and hepatitis viruses B and C, for which there is strong evidence of transmission via health-care waste. These viruses are generally transmitted through injuries from syringe needles contaminated by human blood.

The existence in health-care establishments of bacteria resistant to antibiotics and chemical disinfectants may also contribute to the hazards created by poorly managed health-care waste. It has been demonstrated, for example, that plasmids from laboratory strains contained in health-care waste were transferred to indigenous bacteria via the waste disposal system. Moreover, antibiotic-resistant *Escherichia coli* have been shown to survive in an activated sludge plant, although there does not seem to be significant transfer of this organism under normal conditions of wastewater disposal and treatment.

Concentrated cultures of pathogens and contaminated sharps (particularly hypodermic needles) are probably the waste items that represent the most acute potential hazards to health.

Sharps may not only cause cuts and punctures but also infect these wounds if they are contaminated with pathogens. Because of this double risk—of injury and disease transmission—sharps are considered as a

Table 3.1 *Examples of infections caused by exposure to health-care wastes, causative organisms, and transmission vehicles*

Type of infection	Examples of causative organisms	Transmission vehicles
Gastroenteric infections	Enterobacteria, e.g. <i>Salmonella</i> , <i>Shigella</i> spp.; <i>Vibrio cholerae</i> ; helminths	Faeces and/or vomit
Respiratory infections	<i>Mycobacterium tuberculosis</i> ; measles virus; <i>Streptococcus pneumoniae</i>	Inhaled secretions; saliva
Ocular infection	Herpesvirus	Eye secretions
Genital infections	<i>Neisseria gonorrhoeae</i> ; herpesvirus	Genital secretions
Skin infections	<i>Streptococcus</i> spp.	Pus
Anthrax	<i>Bacillus anthracis</i>	Skin secretions
Meningitis	<i>Neisseria meningitidis</i>	Cerebrospinal fluid
Acquired immunodeficiency syndrome (AIDS)	Human immunodeficiency virus (HIV)	Blood, sexual secretions
Haemorrhagic fevers	Junin, Lassa, Ebola, and Marburg viruses	All bloody products and secretions
Septicaemia	<i>Staphylococcus</i> spp.	Blood
Bacteraemia	Coagulase-negative <i>Staphylococcus</i> spp.; <i>Staphylococcus aureus</i> ; <i>Enterobacter</i> , <i>Enterococcus</i> , <i>Klebsiella</i> , and <i>Streptococcus</i> spp.	
Candidaemia	<i>Candida albicans</i>	Blood
Viral hepatitis A	Hepatitis A virus	Faeces
Viral hepatitis B and C	Hepatitis B and C viruses	Blood and body fluids

very hazardous waste class. The principal concerns are infections that may be transmitted by subcutaneous introduction of the causative agent, e.g. viral blood infections. Hypodermic needles constitute an important part of the sharps waste category and are particularly hazardous because they are often contaminated with patients' blood.

3.1.4 Hazards from chemical and pharmaceutical waste

Many of the chemicals and pharmaceuticals used in health-care establishments are hazardous (e.g. toxic, genotoxic, corrosive, flammable, reactive, explosive, shock-sensitive). These substances are commonly present in small quantities in health-care waste; larger quantities may be found when unwanted or outdated chemicals and pharmaceuticals are disposed of. They may cause intoxication, either by acute or by chronic exposure, and injuries, including burns. Intoxication can result from absorption of a chemical or pharmaceutical through the skin or the mucous membranes, or from inhalation or ingestion. Injuries to the skin, the eyes, or the mucous membranes of the airways can be caused by contact with flammable, corrosive, or reactive chemicals (e.g. formaldehyde and other volatile substances). The most common injuries are burns.

Disinfectants are particularly important members of this group: they are used in large quantities and are often corrosive. It should also be noted that reactive chemicals may form highly toxic secondary compounds.

Obsolete pesticides, stored in leaking drums or torn bags, can directly or indirectly affect the health of anyone who comes into contact with them. During heavy rains, leaked pesticides can seep into the ground and contaminate the groundwater. Poisoning can occur through direct contact with the product, inhalation of vapours, drinking of contaminated water, or eating of contaminated food. Other hazards may include the possibility of fire and contamination as a result of inadequate disposal such as burning or burying.

Chemical residues discharged into the sewerage system may have adverse effects on the operation of biological sewage treatment plants or toxic effects on the natural ecosystems of receiving waters. Similar problems may be caused by pharmaceutical residues, which may include antibiotics and other drugs, heavy metals such as mercury, phenols, and derivatives, and disinfectants and antiseptics.

3.1.5 Hazards from genotoxic waste

The severity of the hazards for health-care workers responsible for the handling or disposal of genotoxic waste is governed by a combination of the substance toxicity itself and the extent and duration of exposure. Exposure to genotoxic substances in health care may also occur during the preparation of or treatment with particular drugs or chemicals. The main pathways of exposure are inhalation of dust or aerosols, absorption through the skin, ingestion of food accidentally contaminated with cytotoxic drugs, chemicals, or waste, and ingestion as a result of bad practice, such as mouth pipetting. Exposure may also occur through contact with the bodily fluids and secretions of patients undergoing chemotherapy.

The cytotoxicity of many antineoplastic drugs is cell-cycle-specific, targeted on specific intracellular processes such as DNA synthesis and

mitosis. Other antineoplastics, such as alkylating agents, are not phase-specific, but cytotoxic at any point in the cell cycle. Experimental studies have shown that many antineoplastic drugs are carcinogenic and mutagenic; secondary neoplasia (occurring after the original cancer has been eradicated) is known to be associated with some forms of chemotherapy.

Many cytotoxic drugs are extremely irritant and have harmful local effects after direct contact with skin or eyes (Box 3.1). They may also cause dizziness, nausea, headache, or dermatitis. Additional information on health hazards from cytotoxic drugs may be obtained on request from the International Agency for Research on Cancer (IARC).¹

Special care in handling genotoxic waste is absolutely essential; any discharge of such waste into the environment could have disastrous ecological consequences.

Radioactive waste is dealt with separately, in section 3.1.6.

3.1.6 Hazards from radioactive waste

The type of disease caused by radioactive waste is determined by the type and extent of exposure. It can range from headache, dizziness, and vomiting to much more serious problems. Because radioactive waste, like certain pharmaceutical waste, is genotoxic, it may also affect genetic material. Handling of highly active sources, e.g. certain sealed sources from diagnostic instruments, may cause much more severe injuries (such

Box 3.1 Cytotoxic drugs hazardous to eyes and skin

Alkylating agents

Vesicant¹ drugs: aclarubicin, chlormethine, cisplatin, mitomycin

Irritant drugs: carmustine, cyclophosphamide, dacarbazine, ifosfamide, melphalan, streptozocin, thiotepa

Intercalating agents

Vesicant drugs: amsacrine, dactinomycin, daunorubicin, doxorubicin, epirubicin, pirarubicin, zorubicin

Irritant drugs: mitoxantrone

Vinca alkaloids and derivatives

Vesicant drugs: vinblastine, vincristine, vindesine, vinorelbine

Epipodophyllotoxins

Irritant drugs: teniposide

¹Blistering.

¹ International Agency for Research on Cancer, Unit of Gene–Environment Interactions, 150 Cours Albert-Thomas, 69372 Lyon Cedex 08, France.

as destruction of tissue, necessitating amputation of body parts) and should therefore be undertaken with the utmost care.

The hazards of low-activity waste may arise from contamination of external surfaces of containers or improper mode or duration of waste storage. Health-care workers or waste-handling or cleaning personnel exposed to this radioactivity are at risk.

3.1.7 Public sensitivity

Quite apart from fear of health hazards, the general public is very sensitive about the visual impact of *anatomical waste*, that is recognisable human body parts, including fetuses. In no circumstances is it acceptable to dispose of anatomical waste inappropriately, such as on a landfill.

In some cultures, especially in Asia, religious beliefs require that human body parts be returned to a patient's family, in tiny "coffins," to be buried in cemeteries. The Muslim culture, too, generally requires that body parts are buried in cemeteries.

3.2 Public health impact of health-care waste

3.2.1 Impacts of infectious waste and sharps

For serious virus infections such as HIV/AIDS and hepatitis B and C, health-care workers—particularly nurses—are at greatest risk of infection through injuries from contaminated sharps (largely hypodermic needles). Other hospital workers and waste-management operators outside health-care establishments are also at significant risk, as are individuals who scavenge on waste disposal sites (although these risks are not well documented). The risk of this type of infection among patients and the public is much lower. Certain infections, however, spread through other media or caused by more resilient agents, may pose a significant risk to the general public and to hospital patients. For instance, uncontrolled discharges of sewage from field hospitals treating cholera patients have been strongly implicated in cholera epidemics in some Latin American countries.

Individual cases of accidents and subsequent infections caused by health-care waste are well documented (see Box 3.2 for example). The overall situation, however, remains difficult to assess, especially in developing countries. It is suspected that many cases of infection with a wide variety of pathogens have resulted from exposure to improperly managed health-care wastes in developing countries.

Box 3.2 Reported case of infection caused by contact with health-care waste

A hospital housekeeper in the USA developed staphylococcal bacteraemia and endocarditis after a needle injury.

The annual rates of injuries from sharps in medical waste for health-care and sanitary service personnel, within and outside hospitals, were estimated by the US Agency for Toxic Substances and Diseases Register (ATSDR) in their report to Congress on medical waste (Table 3.2). Many injuries are caused by recapping of hypodermic needles before disposal into containers, by unnecessary opening of these containers, and by the use of materials that are not puncture-proof for construction of containers.

Box 3.3 summarizes data on occupational transmission of HIV, and Table 3.3 shows the estimated risk of infection with HIV or viral hepatitis after hypodermic needle puncture based on data from France, Japan, and USA. Outside health-care establishments, the risk to the general public of HIV infection by this means is negligible: it has been estimated that no more than 1–4 HIV infections are caused annually by health-care waste in the USA, compared with an overall total of about 68 000 infections for the whole country during 1995. The risk of viral hepatitis B and C infection from contact with health-care waste may be more significant, as this virus is viable for longer than HIV.

A report by the US Environmental Protection Agency to Congress on medical waste estimated the annual numbers of viral hepatitis B (HBV) infections resulting from injuries from sharps among medical personnel and waste-management workers (Table 3.2). The annual number of HBV infections in the USA resulting from exposure to health-care waste is between 162 and 321, out of an overall yearly total of 300 000 cases.

Box 3.3 Occupational transmission of HIV in France and USA

France

In 1992, eight cases of HIV infection were recognized as occupational infections. Two of these cases, involving transmission through wounds, occurred in waste-handlers.

USA

In June 1994, 39 cases of HIV infection were recognized by the Centers for Disease Control and Prevention as occupational infections, with the following pathways of transmission:

- 32 from hypodermic needle injuries
- 1 from blade injury
- 1 from glass injury (broken glass from a tube containing infected blood)
- 1 from contact with non-sharp infectious item
- 4 from exposure of skin or mucous membranes to infected blood.

By June 1996, the cumulative recognized cases of occupational HIV infection had risen to 51. All cases were nurses, medical doctors, or laboratory assistants.

Table 3.2 *Viral hepatitis B infections caused by occupational injuries from sharps (USA)*

Professional category	Annual number of people injured by sharps	Annual number of HBV infections caused by injury
Nurses		
in hospital	17 700–22 200	56–96
outside hospital	28 000–48 000	26–45
Hospital laboratory workers	800–7 500	2–15
Hospital housekeepers	11 700–45 300	23–91
Hospital technicians	12 200	24
Physicians and dentists in hospital	100–400	<1
Physicians outside hospital	500–1 700	1–3
Dentists outside hospital	100–300	<1
Dental assistants outside hospital	2 600–3 900	5–8
Emergency medical personnel (outside hospital)	12 000	24
Waste workers (outside hospital)	500–7 300	1–15

Table 3.3 *Risk of infection after hypodermic needle puncture*

Infection	Risk of infection
HIV	0.3%
Viral hepatitis B	3%
Viral hepatitis C ^a	3–5%

^aData from Japan.

There were insufficient data on other infections linked to health-care waste to allow any conclusions to be reached. On the basis of the figures for HBV, however, it is recommended that all personnel handling health-care waste should be immunized against the disease. Unfortunately, no vaccine is yet available against viral hepatitis C.

If these data are to be extrapolated to developing countries, it should be borne in mind that supervision and training of personnel exposed to waste in those countries may be less rigorous, with the result that more people are likely to be exposed to health-care wastes, both within and outside health-care establishments.

In any health-care establishment, nurses and housekeeping personnel are the main groups at risk of injuries; annual injury rates are 10–20 per 1000 workers. Highest rates of occupational injury among all workers who may be exposed to health-care waste are reported by cleaning personnel and waste handlers; the annual rate in the USA is 180 per 1000. Although most work-related injuries among health-care workers and refuse collectors are sprains and strains caused by overexertion, a significant percentage are cuts and punctures from discarded sharps.

3.2.2 *Impacts of chemical and pharmaceutical waste*

While there is no scientifically documented incidence of widespread illnesses among the general public due to chemical or pharmaceutical

waste from hospitals, many examples may be found of extensive intoxication caused by industrial chemical waste. Moreover, many cases of injury or intoxication result from the improper handling of chemicals or pharmaceuticals in health-care establishments. Pharmacists, anaesthetists, and nursing, auxiliary, and maintenance personnel may be at risk of respiratory or dermal diseases caused by exposure to such substances as vapours, aerosols, and liquids. To minimize this type of occupational risk, less hazardous chemicals should be substituted whenever possible and protective equipment should be provided to all personnel likely to be exposed. Premises where hazardous chemicals are used should be properly ventilated, and personnel at risk should be trained in preventive measures and in emergency care in case of accident.

3.2.3 Impacts of genotoxic waste

To date there are few data on the long-term health impacts of genotoxic health-care waste. This is partly because of the difficulty of assessing human exposure to this type of compound. A study undertaken in Finland, for example, found a significant correlation between fetal loss and occupational exposure to antineoplastic drugs during the first three months of pregnancy, but similar studies in France and the USA failed to confirm this result.

Numerous published studies have investigated the potential health hazard associated with the handling of antineoplastic drugs, manifested by increased urinary levels of mutagenic compounds in exposed workers and an increased risk of abortion. A recent study has demonstrated that exposure of personnel cleaning hospital urinals exceeded that of nurses and pharmacists; these individuals were less aware of the danger and took fewer precautions. The concentration of cytotoxic drugs in the air inside hospitals has been examined in a number of studies designed to evaluate health risks linked to such exposure (Pyy, 1988; Sessink, 1988).

No scientific publication has yet reported adverse effects on health resulting from mismanagement of genotoxic waste.

3.2.4 Impacts of radioactive waste

Several accidents resulting from improper disposal of nuclear therapeutic materials have been reported, with a large number of persons suffering from the results of exposure.

In Brazil, one case of carcinogenic impact on the general population linked to exposure to radioactive hospital waste has been analysed and fully documented. While moving, a radiotherapy institute left a sealed radiotherapy source in its old premises. An individual who gained access to these premises removed the source and took it home. As a consequence, 249 people were exposed, of whom several either died or suffered severe health problems (IAEA, 1988).

Apart from the Brazil incident, no reliable scientific data are available on the impact of radioactive hospital waste. It may be that many cases of exposure to radioactive health-care waste, and associated health problems, go unreported. The only recorded accidents involving exposure to ionizing radiations in health-care settings have resulted from unsafe operation of X-ray apparatus, improper handling of radiotherapy solutions, or inadequate control of radiotherapy.

3.3 Survival of pathogenic microorganisms in the environment

Pathogenic microorganisms have limited ability to survive in the environment. This ability is specific to each microorganism and is a function of its resistance to environmental conditions such as temperature, humidity, ultraviolet irradiation, availability of organic substrate material, presence of predators, etc.

The hepatitis B virus is very persistent in dry air and can survive for several weeks on a surface; it is also resistant to brief exposure to boiling water. It can survive exposure to some antiseptics and to 70% ethanol and remains viable for up to 10 hours at a temperature of 60°C. The Japanese Association for Research on Medical Waste found that an infective dose of hepatitis B or C virus can survive for up to a week in a blood droplet trapped inside a hypodermic needle.

By contrast, HIV is much less resistant. It survives for no more than 15 minutes when exposed to 70% ethanol and only 3–7 days at ambient temperature. It is inactivated at 56°C.

Bacteria are less resistant than viruses, but much less is known about the survival of prions and agents of degenerative neurological diseases (Creutzfeldt–Jakob disease, kuru, etc.), which seem to be very resistant.

With the exception of waste containing pathogenic cultures or excreta of infected patients, the microbial load of health-care waste is generally not very high. Furthermore, health-care wastes do not seem to provide favourable media for the survival of pathogens, perhaps because they frequently contain antiseptics. Results of a number of studies have shown that the concentration of indicator microorganisms in health-care waste is generally no higher than in domestic waste, and that survival rates are low.

In evaluating the survival or spread of pathogenic microorganisms in the environment, the role of vectors such as rodents and insects should be considered. This applies to management of health-care waste both within and outside health-care establishments. Vectors such as rats, flies, and cockroaches, which feed or breed on organic waste, are well known passive carriers of microbial pathogens; their populations may increase dramatically where there is mismanagement of waste.

3.4 Needs for further research and epidemiological surveys

Very few data are available on the health impacts of exposure to health-care waste, particularly in the case of developing countries. Better assessment of both risks and effects of exposure would permit improvements in the management of health-care waste management and in the planning of adequate protective measures. Unfortunately, the classical application of epidemiology to the problem is difficult because of methodological complications and uncertainties regarding evaluation of both exposure and health outcome. The great diversity of hazardous wastes that can be involved and of circumstances of exposures is a particularly problematic feature of all such evaluations. It prevents not only the development of a unified analytical approach to the assessment of exposure and health outcome but also the generalization of any statistical inferences drawn about a specific waste-exposed population. Neverthe-

less, suspected cases of adverse health effects of health-care waste should be adequately documented, with precise descriptions of exposure, exposed individuals or populations, and outcome.

Within health-care establishments, the surveillance of infection and record-keeping are important tools that can provide indications of inadequate hygiene practices or of contamination of the immediate environment (including that caused by health-care waste). Surveillance allows an outbreak of infection to be recognized and investigated and provides a basis for introducing control measures, for assessing the efficacy of those measures and of the routine preventive measures taken by the establishment, and for reducing the level of avoidable infection. It will also ensure that the control measures have maximum effect and are as cost-effective as possible.

In summary, further research is necessary to increase knowledge of:

- the extent to which health-care waste is contaminated;
- the risk level for contamination of the exposed population by digestive, respiratory, and percutaneous routes;
- growth and survival of pathogens in waste during storage.

References and suggested further reading

- Allwood M, Wright P, eds (1993). *The cytotoxic handbook*. Oxford, Radcliffe Medical Press.
- Ayliffe GAJ et al., eds (1992). *Control of hospital infection: a practical handbook*, 3rd ed. London, Chapman & Hall Medical.
- Babich H (1985). Reproductive and carcinogenic health risks to hospital personnel from chemical exposure. A literature review. *Environmental health*, 48(2):52–56.
- Benhamou S et al. (1986). Mutagenicity in urine from nurses handling cytostatic agents. *European journal of cancer and clinical oncology*, 22:1489–1493.
- Bouvet E, Groupe d'Etude sur le Risque d'Exposition au Sang (1993). Risque professionnel d'infection par le virus de l'immunodéficience humaine. Synthèse des connaissances actuelles et évolution de la prévention. [Risk for health professionals of infection with human immunodeficiency virus. Current knowledge and developments in preventive measures.] *Médecine et maladies infectieuses*, 23:28–33.
- Estryn-Behar M, Prugnaud JL, Sainte-Laudry J (1983). Hypersensibilité immédiate et antimétaboliques. Nécessité de protection du personnel soignant. [Immediate hypersensitivity and antimetabolites. The need to protect caregivers.] *Journal de pharmacie clinique*, 2:131–143.
- FAO (1995). *Prevention of accumulation of obsolete pesticide stocks. Provisional guidelines*. Rome, Food and Agriculture Organization of the United Nations (document GCP/INT/572/NET, available from Food and Agriculture Organization of the United Nations, Rome, Italy).
- Finch GR, Smith DW (1986). The survival of antibiotic-resistant *E. coli* in an activated sludge plant. *Environmental technology letters*, 7:487–494.
- Gealt MA et al. (1985). Transfer of plasmids pBR322 and pBR325 in wastewater from laboratory strains of *Escherichia coli* to bacteria indigenous to the waste disposal system. *Applied environmental microbiology*, 49(4):836–841.
- Heptonstall J, Porter K, Gill ON (1993). *Occupational transmission of HIV. Summary of published reports*. Atlanta, GA, Centers for Disease Control and Prevention.
- IAEA (1988). *The radiological accident in Goiânia*. Vienna, International Atomic Energy Agency.

- IARC (1991). *IARC monographs on the evaluation of carcinogenic risk of chemicals to humans. Some antineoplastic and immunosuppressive agents*. Lyon, International Agency for Research on Cancer (IARC Monographs, No. 26).
- IARC (1994). *IARC monographs on the evaluation of carcinogenic risks to humans: list of IARC evaluations*. Lyon, International Agency for Research on Cancer.
- Lee MG (1988). The environmental risks associated with the use and disposal of pharmaceuticals in hospitals. Proceedings of 3rd European Conference. *Risk assessment of chemicals in the environment*, 491–504.
- Loft F, Abiteboul D (1994). Infections professionnelles par le VIH en France. Le point au 31 décembre 1993. [Health professionals infected with HIV in France. The situation at 31 December 1993.] *Bulletin épidémiologique hebdomadaire*, 5(2):111–113.
- Pyy L et al. Ambient monitoring of cyclophosphamide in manufacture and hospitals. *American Industrial Hygiene Association journal*, 49:314–317.
- Saurel-Cubizolles MJ, Job-Spira M, Estry-Behar M (1983). Ectopic pregnancy and occupational exposure to antineoplastic drugs and fetal loss in nurses. *Lancet*, 341:1169–1171.
- Selavan SG et al. (1985). A study of occupational exposure to antineoplastic drugs and fetal loss in nurses. *New England journal of medicine*, 313(19):1173–1178.
- Sessink PJM et al. (1992). Occupational exposure to antineoplastic agents at several departments in a hospital. Environmental contamination and excretion of cyclophosphamide and ifosfamide in urine of exposed workers. *International archives of occupational and environmental health*, 64:105–112.
- Sodeyama T et al. (1993). Detection of hepatitis C virus markers and hepatitis C virus genomic RNA after needlestick accidents. *Archives of internal medicine*, 153:1567–1572.
- Sorsa M, Hemminki K, Vanio H (1985). Occupational exposure to anticancer drugs: potential real hazards. *Mutation research*, 154:135–149.
- Stücker I et al. (1990). Risk of spontaneous abortion among nurses handling antineoplastic drugs. *Scandinavian journal of work, environment and health*, 16:102–107.
- WHO (1992). *The hospital in rural and urban districts. Report of a WHO Study Group on the Functions of Hospitals at the First Referral Level*. Geneva, World Health Organization (WHO Technical Report Series, No. 819).
- WHO (1995). *Survey of hospital wastes management in South-East Asia Region*. New Delhi, World Health Organization Regional Office for South-East Asia.

4

Legislative, regulatory, and policy aspects

4.1 International agreements and underlying legislative and regulatory principles

International agreement has been reached on a number of underlying principles that govern either public health or safe management of hazardous waste. These principles—outlined below—should be taken into consideration when national legislation or regulations governing health-care waste management are formulated:

- **The Basel Convention**, signed by more than 100 countries, concerns transboundary movements of hazardous waste; it is also applicable to health-care waste. Countries that signed the Convention accepted the principle that the only legitimate transboundary shipments of hazardous waste are exports from countries that lack the facilities or expertise to dispose safely of certain wastes to other countries that have both facilities and expertise. Exported waste should be labelled according to the UN recommended standards outlined in section 7.3 (page 65).
- The **“polluter pays” principle** implies that all producers of waste are legally and financially responsible for the safe and environmentally sound disposal of the waste they produce. This principle also attempts to assign liability to the party that causes damage.
- The **“precautionary” principle** is a key principle governing health and safety protection. When the magnitude of a particular risk is uncertain, it should be assumed that this risk is significant, and measures to protect health and safety should be designed accordingly.
- The **“duty of care” principle** stipulates that any person handling or managing hazardous substances or related equipment is ethically responsible for using the utmost care in that task.
- The **“proximity” principle** recommends that treatment and disposal of hazardous waste take place at the closest possible location to its source in order to minimize the risks involved in its transport. According to a similar principle, any community should recycle or dispose of the waste it produces, inside its own territorial limits.

4.2 Legal provisions

National legislation is the basis for improving health-care waste practices in any country. It establishes legal controls and permits the national agency responsible for the disposal of health-care waste, usually the ministry of health, to apply pressure for their implementation. The ministry of environment or national environmental protection agency may also be involved; there should be a clear designation of responsibilities before the law is enacted.

The law should be complemented by a policy document, and by technical guidelines developed for implementation of the law. This legal “package” should specify regulations on treatment for different waste categories, segregation, collection, storage, handling, disposal, and transport of waste, responsibilities, and training requirements; it should take into account the resources and facilities available in the country concerned and any cultural aspects of waste-handling.

A national law on health-care waste management may stand alone or may be part of more comprehensive legislation such as the following:

- law on management of hazardous wastes: application to health-care waste should be explicitly stated;
- law on hospital hygiene and infection control: a specific chapter or article should be devoted to health-care waste.

The law should include the following:

- a clear definition of hazardous health-care waste and of its various categories;
- a precise indication of the legal obligations of the health-care waste producer regarding safe handling and disposal;
- specifications for record-keeping and reporting;
- specifications for an inspection system to ensure enforcement of the law, and for penalties to be imposed for contravention;
- designation of courts responsible for handling disputes arising from enforcement of or noncompliance with the law.

In addition, hospitals should be run, and health-care waste disposed of, in accordance with all other relevant national legislation, such as regulations pertaining to:

- waste in general;
- effects on public health and the environment;
- air quality;
- prevention and control of infectious disease;
- management of radioactive materials.

4.3 Policy document and technical guidelines

The policy document should outline the rationale for the legislation, plus national goals and the key steps essential to the achievement of these goals. It may contain the following:

- descriptions of the health and safety risks resulting from mismanagement of health-care waste;
- reasons for sound and safe health-care waste management practices in health-care establishments;
- listing of approved methods of treatment and disposal for each waste category;
- warning against unsafe practices, such as disposing of hazardous health-care waste in municipal landfills;
- management responsibilities within and outside health-care establishments;
- assessment of the costs of health-care waste management;

- key steps of health-care waste management: minimization, separation, identification, handling, treatment, and final disposal of waste; technical specifications for the implementation of each step should be described in separate technical guidelines;
- record-keeping and documentation;
- training requirements;
- rules governing the protection of workers' health and safety.

The technical guidelines associated with the legislation should be practical and directly applicable. They should include the following specifications, with sufficient detail to ensure that safe practices are observed and appropriate standards achieved:

- legal framework covering safe management of health-care waste, hospital hygiene, and occupational health and safety (limits of emission of atmospheric pollutants and measures for protection of water resources may be addressed here or in the other national guidelines);
- the responsibilities of public health authorities, of the national environmental protection body, of the heads of health-care establishments, of the scattered and smaller producers of health-care waste; and of the heads of any private or public waste-disposal agencies involved;
- safe practices for waste minimization;
- separation, handling, storage, and transport of health-care waste;
- recommended treatment and disposal methods for each category of health-care waste and for wastewater.

For ease of application, the definitions of health-care waste categories included in the law should be repeated in the technical guidelines.

Gradual implementation of the law is recommended in preference to any attempt to introduce all measures simultaneously, particularly where existing practices are inadequate.

Reference

UNEP (1997). *Basel Convention on the Control of Transboundary Movements of Hazardous Wastes and Their Disposal, 1989, and Decisions Adopted by the First (1992), Second (1994) and Third (1995) Meetings of the Conference of the Parties*. Geneva, United Nations Environment Programme.

5

Health-care waste management planning

5.1 The need for planning

Formulation of objectives and planning for their achievement are important for improving health-care waste management at the national, regional, and local level. Planning requires the definition of a strategy that will facilitate careful implementation of the necessary measures and the appropriate allocation of resources according to the identified priorities. This is important for the motivation of authorities, health-care workers, and the public, and for defining further actions that may be needed.

Surveys on the generation of waste will be the basis for identifying opportunities—and setting targets—for waste minimization, reuse and recycling, and cost reduction.

A national programme of sound health-care waste management is achievable through an action plan (see section 5.3).

5.2 International recommendations for waste management

The United Nations Conference on the Environment and Development (UNCED) in 1992 led to the adoption of Agenda 21, which recommends a set of measures for waste management. The recommendations may be summarized as follows:

- Prevent and minimize waste production.
- Reuse or recycle the waste to the extent possible.
- Treat waste by safe and environmentally sound methods.
- Dispose of the final residues by landfill in confined and carefully designed sites.

Agenda 21 also stresses that any waste producer is responsible for the treatment and final disposal of its own waste; where possible, each community should dispose of its waste within its own boundaries.

The European Union has elaborated a common “European Community Strategy on Waste Management”; other regional groupings of countries may set up similar policies in the future.

5.3 National plans for health-care waste management

5.3.1 *Purpose of a national management plan*

A national management plan will permit health-care waste management options to be optimized on a national scale. A national survey of health-care waste will provide the relevant agency with a basis for identifying

actions on a district, regional, and national basis, taking into account conditions, needs, and possibilities at each level. An appropriate, safe, and cost-effective strategy will be concerned principally with treatment, recycling, transport, and disposal options.

5.3.2 Action plan for the development of a national programme

A national programme of sound health-care waste management can be developed through a seven-step action plan. The seven steps and their suggested time frame are shown in Fig. 5.1 and described in more detail in the following paragraphs.

Step 1. Establish policy commitment and responsibility for health-care waste management

Before an action plan is implemented there must be commitment to the development of a national policy, and responsibility must be delegated to the appropriate government authority. The ministry of health or the ministry of environment will usually serve as the principal authority, and should work closely with other relevant ministries. The designated authority will cooperate with other ministries, the private sector, non-governmental organizations (NGOs), and professional organizations, as necessary, to ensure implementation of the action plan.

Policy commitment should be reflected in appropriate budgetary allocations at different government levels. Guidance from central government should lead to maximum efficiency in the use of available resources from health-care establishments.

Step 2. Conduct a national survey of health-care waste practices

The national agency responsible for the disposal of health-care waste should be fully aware of current levels of waste production and of national waste management practices. A comprehensive survey is essential for planning an effective waste management programme. It is suggested that a wide-ranging questionnaire be completed for all health-care establishments in order to establish the following:

- number of hospital beds and bed occupancy rate for each health-care establishment;
- types and quantities of waste generated;
- personnel involved in the management of health-care waste;
- current health-care waste disposal practices, including segregation, collection, transportation, storage, and disposal methods.

The survey should also include site observations and interviews with health or support workers (waste workers, cleaners, etc.) at different levels. The information collected will provide a basis for formulating strategy for district, regional, and national levels.

A typical survey questionnaire is reproduced on pages 37 to 42; it has been used in a survey of hospitals in WHO's South-East Asia Region to identify issues that require interventions.

Step 3. Develop national guidelines

The foundation for a national programme for health-care waste management is the technical guidelines—plus the legal framework that supports them. Step 3 thus consists of the formulation of a national policy document and technical guidelines based on the results of the national

Fig. 5.1 Action plan for national programme of sound health-care waste management^a

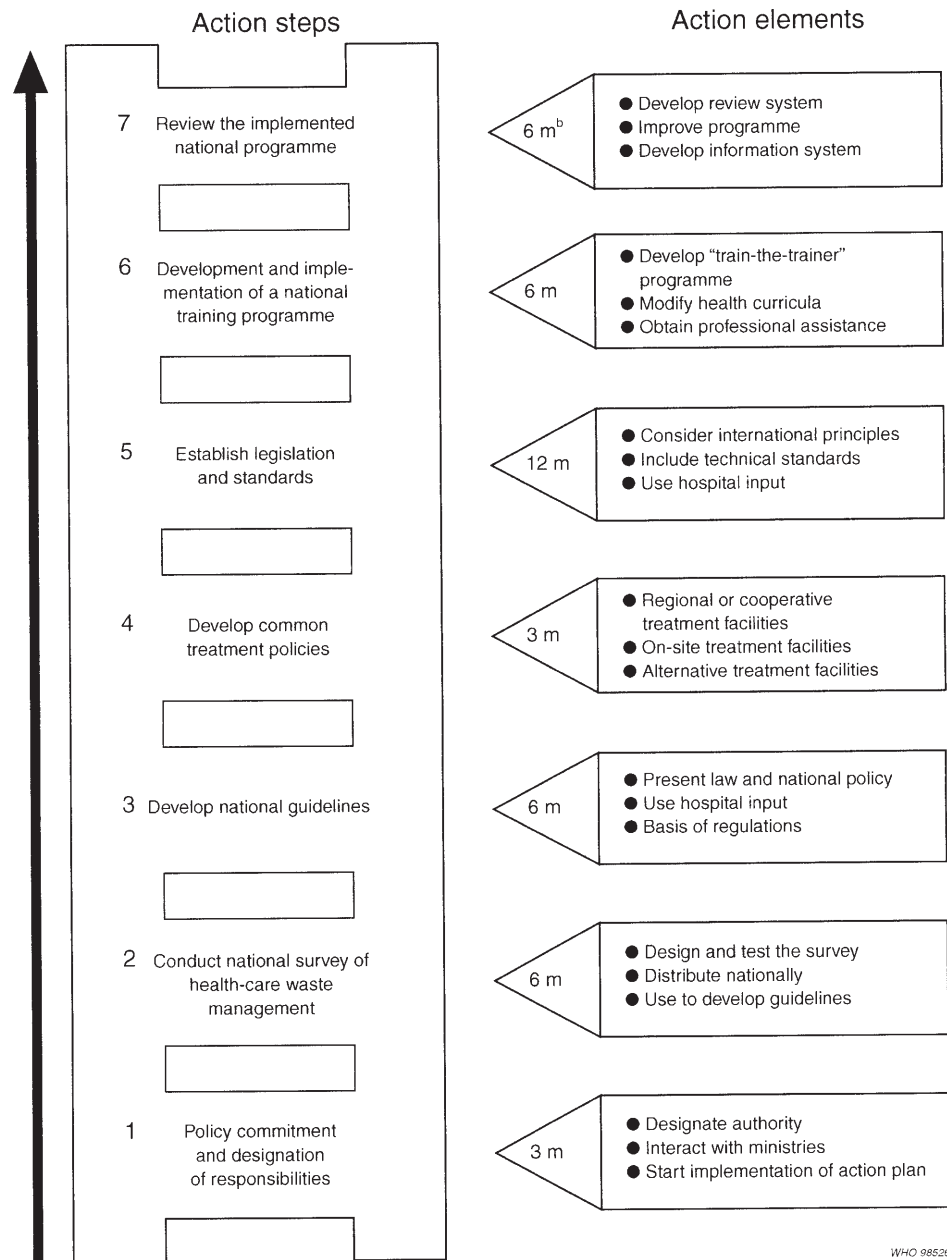

WHO 98526

^aSource: WHO (1997).

^bTime (months) to complete action.

survey; the two may be brought together in one comprehensive document. Their content, outlined in section 4.3, should provide the technical foundation on which health-care establishments can build their individual management programmes.

Survey questionnaire for hospital waste management¹

QUESTIONNAIRE

Hospital (name, location): _____

- Type of hospital (tick one):
- Specialist
 - General
 - University (training/provincial)
 - Regional
 - District
 - Sub-district

No. of inpatients: _____ /day

No. of outpatients: _____ /day

No. of beds (total): _____ /day

including _____ in _____ ward
(no.) (type of ward)

_____ in _____ ward
(no.) (type of ward)

_____ in _____ ward
(no.) (type of ward)

_____ in _____ ward
(no.) (type of ward)

¹ With minor editorial changes, as used by the WHO Regional Office for South-East Asia.

Survey questionnaire for hospital waste management (continued)

Type of solid waste produced and estimated quantity
(Consult classification and mark X where waste is produced.)

Sources	Waste category								Est. quantity (kg/day)	
	General	Pathological	Radioactive	Chemical	Infectious	Sharps	Pharmaceutical	Pressurized containers		
<i>Patient services</i> Medical Surgical Operating theatre Recovery/intensive care Isolation ward Dialysis unit Oncology unit Emergency Outpatient clinic Autopsy room Radiology										
<i>Laboratories</i> Biochemistry Microbiology Haematology Research Pathology Nuclear medicine										
<i>Support services</i> Blood bank Pharmacy Central sterile supply Laundry Kitchen Engineering Administration Public areas Long-term health care										

Survey questionnaire for hospital waste management *(continued)*

Waste segregation, collection, storage, and handling

Describe briefly what happens between segregation (if any) and final disposal of:

Sharps _____

Pathological waste _____

Infectious waste _____

Radioactive waste _____

Chemical waste _____

Pharmaceutical waste _____

Pressurized containers _____

Survey questionnaire for hospital waste management (continued)

Waste segregation, collection, labelling, transport, and disposal

Handling of segregated waste	Sharps	Pathological waste	Infectious waste	Radioactive waste	Chemical waste	Pharmaceutical waste	Pressurized containers
Indicate by X the type of waste (if any) that is segregated from general waste stream.							
Where is the segregation taking place (i.e. operating room, laboratory, etc.)?							
What type of containers/bags (primary containment vessels) are used to segregate waste (bags, cardboard boxes, plastic containers, metal containers, etc.)? Describe accurately.							
What type of labelling, colour-coding (if any) is used for marking segregated waste? Describe.							
1. Who handles (removes) the segregated waste (designation of the hospital staff member)? 2. Is the waste handler using any protective clothing (gloves, etc.) during waste handling? Yes/No.							
What type of containers (plastic bins, bags, cardboard boxes, trolleys, wheelbarrows, etc.) are used for collection and internal transport of the waste? Describe.							
Where is the segregated waste stored while awaiting removal from the hospital or disposal? Describe.							
Describe briefly the final disposal of segregated waste (taken to municipal landfill, buried on hospital grounds, incinerated, open burned, etc.).							

Survey questionnaire for hospital waste management (continued)

Personnel involved in the management of hospital solid waste

1. (a) Designation of person(s) responsible for organization and management of waste collection, handling, storage, and disposal at the hospital administration level.

(b) General qualification and level of education of designated person.

(c) Has he/she received any training on hospital waste management? Yes No
If yes, what type of training and of what duration?

2. Indicate the number of persons involved in the collection, handling, and storage of hospital waste, their designation, their training in solid waste handling and management, and the number of years of experience of this type of work.

Number	Designation	Training	Experience

3. Do the waste management staff have job descriptions detailing their tasks? Yes No

4. Are instructions/training given to newly hired waste management staff? Yes No

Hospital waste management policy

1. Are you aware of any legislation application to hospital waste management? Yes No
If yes, please list the legislative Acts:

Survey questionnaire for hospital waste management (continued)

2. Are you aware of a document outlining the hospital waste management policy? Yes No
If yes, give title of document (and attach a copy if possible):

3. Is there a manual or guideline document on management of hospital wastes available:
(a) In the Ministry of Health? Yes No
If yes, give title of document:

(b) In your hospital? Yes No
If yes, give title of document:

4. (a) Does your hospital have a Waste Management Plan? Yes No
If yes, please attach a copy.

(b) Does your hospital have a Waste Management Team (or Teams)? Yes No
If yes, please list the members by designation:

	<i>Designation</i>	<i>No.</i>
Team leader	_____	_____
Team members:	_____	_____
Waste handling staff:	_____	_____

5. Are there clearly defined procedures for collection and handling of wastes from specified units in the hospital? Yes No

6. Are there waste management responsibilities included in the job descriptions of hospital supervisory staff (Head of Hospital, Department Heads, Matron/Senior Nursing Officer, Hospital Engineer, Infection Control Officer, Pharmacist, Laboratory Supervisor, etc.)? Yes No
If yes, provide sample copies.

7. How are the present waste collection, handling, and disposal responsibilities defined in the job descriptions of the staff involved? (Cite appropriate statement or provide copies.)

Step 4. Develop a policy on regional and cooperative methods of health-care waste treatment

The designated government agency should identify resources that will ensure a national network of disposal facilities for health-care waste, accessible by hospitals and other health-care facilities. The national (or regional) policy should also include technical specifications for the processes and equipment involved in acceptable treatment options.

There are three basic options for managing the treatment of health-care waste:

- Option 1: an on-site treatment facility in each health-care establishment.
- Option 2: regional or cooperative health-care waste treatment facilities, supplemented by individual facilities for outlying hospitals.
- Option 3: treatment of health-care waste in existing industrial or municipal treatment facilities (e.g. municipal incinerators), where these exist.

Each option has advantages and disadvantages. The national or regional planning policy will depend on local circumstances such as the administrative mechanisms for verifying proper waste management procedures, the number, location, size, and type of health-care establishments, quality of road network, and financial and technical resources.

On-site health-care waste treatment facility

The advantages of providing each health-care establishment with on-site treatment facilities include the following:

- convenience;
- minimization of risks to public health and the environment by confinement of hazardous wastes to the health-care premises.

On-site treatment facilities are particularly appropriate in areas where hospitals are situated far from each other and the road system is poor. They must be managed by the hospitals where they are located and may accept health-care waste collected from scattered small sources in the surrounding areas.

The drawbacks of on-site disposal include the following:

- Costs may be high if there are many hospitals.
- Overall, more technical staff may be required to operate and maintain the facilities.
- It may be difficult for the relevant authorities to monitor the performance of many small facilities; this may result in poor compliance with operating standards, depending on the type of facilities, and increased environmental pollution.

Regional and cooperative treatment facilities

On-site waste disposal methods, which may be desirable for large health-care establishments, may not be practicable or cost-effective for smaller institutions, for which regional or cooperative disposal may be the better option. Such systems are in use in several countries, operating on either a voluntary or a statutory basis. For example, a group of hospitals may cooperate to set up a regional health-care waste treatment facility (e.g. a high-capacity incinerator) at one hospital which will then receive wastes

from others within the group. In other cases, the local authority or a private waste disposal contractor may establish a centralized plant to receive waste from health-care facilities within its region.

Centralized regional facilities could provide the following advantages:

- greater cost-effectiveness for larger units, through economies of scale;
- spare capacity can be provided more economically;
- future modifications or expansions (relating to flue-gas cleaning systems of incinerators, for example) are likely to be less expensive;
- where privatization of facilities is seen as a desirable option, this can be achieved more easily on a regional basis than for numerous small units; in addition, it will be easier for the relevant government agencies to supervise and monitor the facilities;
- efficient operation can be more easily ensured in one centralized facility than in several plants where skilled workers may not be readily available;
- air pollution may be more easily kept to a minimum at a centralized plant (costs of monitoring and surveillance and of flue-gas cleaning, for example, will be reduced);
- hospitals will not have to devote time and personnel to managing their own installations.

The location of regional facilities for the treatment of health-care waste should be carefully chosen. Catchment areas should be defined on the basis of estimated waste production by the health-care establishments involved, and the location of the treatment plant within each catchment area should then be based on the following considerations:

- accessibility for the hospitals and health-care facilities to be served (road conditions, distances, and transportation times);
- quantities of health-care waste expected from the various establishments within the identified catchment area;
- whether or not transfer stations are needed (daily transfer of waste direct from hospitals to the regional facility, with no need for transfer stations, would be optimal, avoiding double handling of waste);
- likely changes in the capacity or function of each hospital and hence in the quantity or nature of its waste;
- preliminary environmental considerations, based on a detailed environmental and health impact assessment (the assessed impact may be lower if the facility is located inside an industrial “park” designed specifically for hazardous industries);
- adequacy of the land area for the facility at a proposed site;
- public attitude towards the treatment method.

Minimizing total times for transportation of health-care wastes to the regional facility should be an important factor in the choice of site and in determining appropriate transportation routes. Allotting adequate numbers of collection vehicles to the various routes in the region will ensure regular collection of waste and contribute to overall cost-effectiveness.

Step 5. Legislation: regulations and standards for health-care waste management

Once developed, the policy and guidelines should be supported by legislation that regulates their application. This law is usually based on

international agreements and underlying principles of sound waste management as outlined in Chapter 4.

Step 6. Institute a national training programme

In order to achieve acceptable practices in health-care waste management and compliance with regulations, it is essential for all managers and other personnel involved to receive appropriate training. To this end, the central government should assist in preparation of “train the trainer” activities, and competent institutions or centres for the trainers’ programme should be identified. Details on training programmes are provided in Chapter 14.

Step 7. Review the national health-care waste management programme after implementation

The national programme for management of health-care waste should be viewed as a continuous process with periodic monitoring and assessment by the responsible national government agency. In addition, the recommendations on treatment methods should be regularly updated to keep pace with new developments.

The national agency will base its assessment primarily on reports from the health-care establishments on their success in implementing waste management plans. It should review annual reports submitted by the heads of the establishments and make random visits to carry out audits of the waste management systems. Any deficiencies in the waste management system should be pointed out to the head of the establishment in writing, together with recommendations for remedial measures. The time limit for implementation of remedial measures should be specified and the head of the establishment should be informed of the follow-up date.

In the case of off-site waste treatment facilities, incinerator operators, road haulage contractors, and landfill operators should also be audited. Periodic review of waste management practices by both the national government agency and the health-care establishments should result both in improved protection of occupational and public health and in enhanced cost-effectiveness of waste disposal.

5.4 Waste management plan for a health-care establishment

5.4.1 Assignment of responsibilities

The proper management of health-care waste depends largely on good administration and organization but also requires adequate legislation and financing, as well as active participation by trained and informed staff.

The head of the hospital should form a waste management team to develop a waste management plan. The team should have the following members:

- Head of Hospital (as chairperson)
- Heads of Hospital Departments
- Infection Control Officer
- Chief Pharmacist
- Radiation Officer

- Matron (or Senior Nursing Officer)
- Hospital Manager
- Hospital Engineer
- Financial Controller
- Waste Management Officer (if already designated).

In certain establishments, the structure may include a Hospital Hygienist, in addition to or instead of the Infection Control Officer, to address specific problems relating to hospital hygiene. In such cases, some or all of the duties of the Infection Control Officer specified below will be carried out by the Hospital Hygienist.

The Head of Hospital should formally appoint the members of the waste management team in writing, informing each of them of their duties and responsibilities as outlined in the following sections. (In an institution that is not directly involved in patient care, such as a medical research institution, the head of the establishment should use his discretion to appoint members of the waste management team from among the relevant staff.) He or she should appoint a Waste Management Officer with overall responsibilities for the development of the hospital waste management plan and for the subsequent day-to-day operation and monitoring of the waste disposal system. Depending on availability of relevant staff, this post may be assigned to the Hospital Engineer, to the Hospital Manager, or to any other appropriate staff member at the discretion of the Head of Hospital.

5.4.2 Management structure, liaison paths, and duties

A typical hospital waste management structure is shown in Fig. 5.2, with line management responsibilities and liaison paths between key personnel involved in the handling of health-care waste. This structure may be adjusted to the particular needs of each hospital. The sharing of duties of key personnel in large hospitals is described in the following paragraphs; in smaller hospitals, one individual may fulfil two or more sets of responsibilities, but the same principles will apply.

Head of Hospital

The Head of Hospital is responsible for the following tasks:

- Forming a waste management team to develop a written waste management plan for the hospital. The plan should clearly define the duties and responsibilities of all members of staff, both clinical and non-clinical, in respect of the handling of health-care waste, and establish lines of accountability.
- Designating a Waste Management Officer (WMO) to supervise and coordinate the waste management plan. The Head of Hospital retains overall responsibility for ensuring that health-care and other wastes are disposed of in accordance with national guidelines.
- Keeping the management plan up to date.
- Allocating sufficient financial and personnel resources to ensure efficient operation of the plan. For example, sufficient staff should be assigned to the Waste Management Officer to ensure efficient operation of the waste management plan.
- Ensuring that monitoring procedures are incorporated in the plan. The efficiency and effectiveness of the disposal system should be monitored so that the system can be updated and improved when necessary.

Fig. 5.2 Hospital waste management structure^a

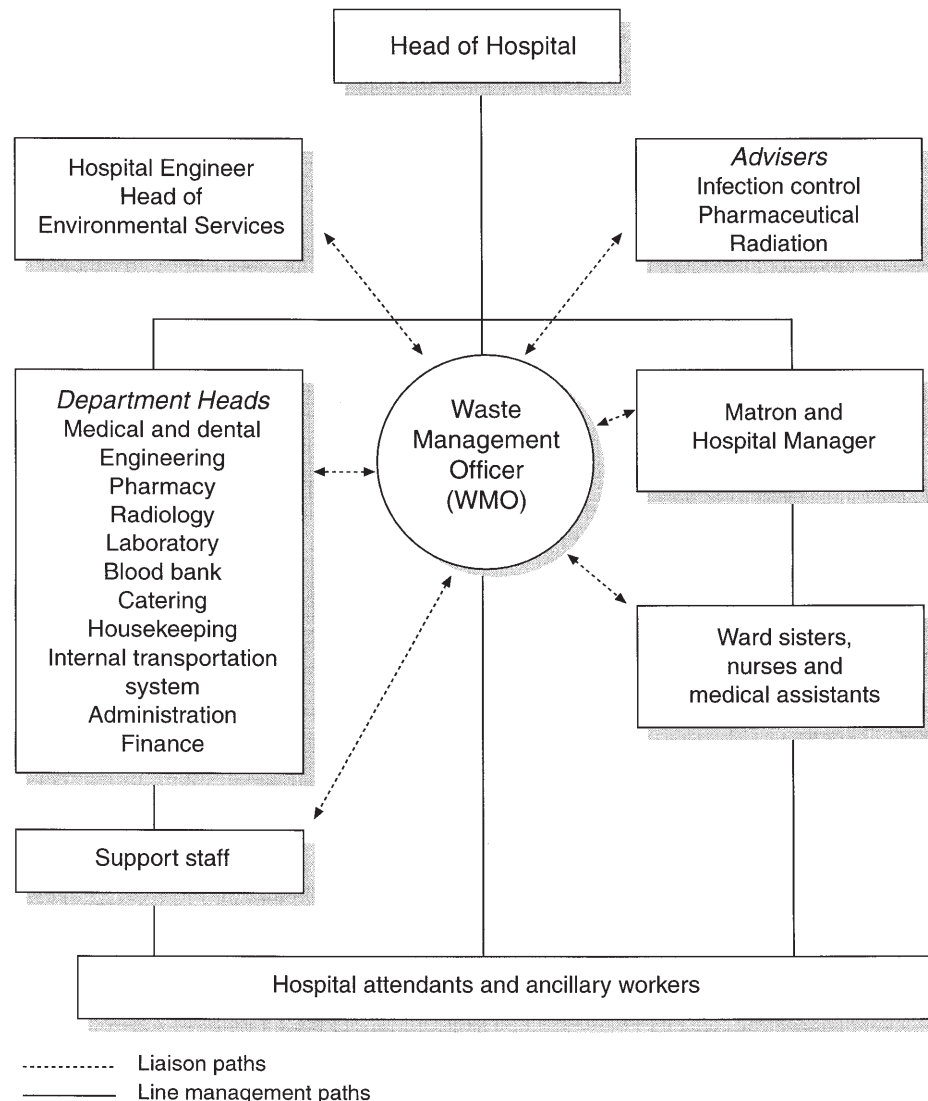

WHO 98527

^aAdapted from a 1994 draft document, *Regional guidelines for healthcare waste management in developing countries*, produced by the World Health Organization Western Pacific Regional Environmental Health Centre, Kuala Lumpur.

- Immediately appointing a successor in the event of personnel leaving key positions in the waste management team (or temporarily assigning responsibility to another staff member until a successor can be appointed).
- Ensuring adequate training for key staff members and designating the staff responsible for coordinating and implementing training courses.

Waste Management Officer (WMO)

The WMO is responsible for the day-to-day operation and monitoring of the waste management system. It is therefore essential that he or she has direct access to all members of the hospital staff (see Fig. 5.2). The

WMO is directly responsible to the Head of Hospital. He or she should liaise with the Infection Control Officer, the Chief Pharmacist, and the Radiation Officer in order to become familiar with the correct procedures for handling and disposing of pathological, pharmaceutical, chemical, and radioactive wastes.

In the area of waste collection, the WMO should:

- control internal collection of waste containers and their transport to the central waste storage facility of the hospital on a daily basis;
- liaise with the Supplies Department to ensure that an appropriate range of bags and containers for health-care waste, protective clothing, and collection trolleys are available at all times;
- ensure that hospital attendants and ancillary staff immediately replace used bags and containers with the correct new bags or containers;
- directly supervise hospital attendants and ancillary workers assigned to collect and transport health-care waste.

Concerning waste storage, the WMO should:

- ensure the correct use of the central storage facility for health-care waste, which should be kept locked but should always be accessible to authorized hospital staff;
- prevent all unsupervised dumping of waste containers on the hospital grounds.

To supervise collection and disposal of the waste, the WMO should:

- coordinate and monitor all waste disposal operations;
- monitor methods of transportation of wastes both on- and off-site and ensure that wastes collected from the hospital are transported by an appropriate vehicle to the designated treatment and disposal site;
- ensure that waste is not stored for longer than specified in the guidelines and that the transport organization (which may be the local authority or a private contractor) collects the waste with the required frequency.

For staff training and information, the WMO should:

- liaise with the Matron (or Senior Nursing Officer) and the Hospital Manager to ensure that the nursing staff and medical assistants are aware of their own responsibilities for segregation and storage of waste and that the responsibilities of hospital attendants and ancillary staff are limited to the handling and transport of sealed waste bags and containers;
- liaise with Department Heads to ensure that all doctors and other qualified clinical staff are aware of their own responsibilities regarding segregation and storage of waste and that the responsibilities of hospital attendants and ancillary staff are limited to the handling and transport of sealed bags and containers;
- ensure that hospital attendants and ancillary staff are not involved in waste segregation and that they handle only waste bags and containers that have been sealed in the correct manner.

For incident management and control the WMO should:

- ensure that written emergency procedures are available, that they are in place at all times, and that personnel are aware of the action to be taken in the event of an emergency;
- investigate and review any reported incidents concerning the handling of health-care waste.

In addition, the WMO should continuously monitor certain parameters, which are listed in Box 5.1.

Department Heads

Department Heads are responsible for the segregation, storage, and disposal of waste generated in their departments. They should

- ensure that all doctors, nurses, and clinical and non-clinical professional staff in their departments are aware of the segregation and storage procedures and that all personnel comply with the highest standards;
- continuously liaise with the WMO to monitor working practices for failures or mistakes;
- ensure that key staff members in their departments are given training in waste segregation and disposal procedures;
- encourage medical and nursing staff to be vigilant so as to ensure that hospital attendants and ancillary staff follow correct procedures at all times.

Matron and Hospital Manager

The Matron (or Senior Nursing Officer) and the Hospital Manager are responsible for training nursing staff, medical assistants, hospital attendants, and ancillary staff in the correct procedures for segregation, storage, transport, and disposal of waste. They should therefore:

Box 5.1 Parameters to be monitored by the waste management officer

Waste generated each month, by waste category:

- in each department;
- treatment and disposal methods.

Financial aspects of health-care waste management:

- direct costs of supplies and materials used for collection, transport, storage, treatment, disposal, decontamination, and cleaning;
- training costs (labour and material);
- costs of operation and maintenance of on-site treatment facilities;
- costs for contractor services.

Public health aspects:

- Incidents resulting in injury, “near misses”, or failures in the handling, separation, storage, transport, or disposal system, which should also be reported to the Infection Control Officer; this will be the basis for preventive measures to prevent recurrences.

- liaise with the WMO and the advisers (Infection Control Officer, Chief Pharmacist, and Radiation Officer) to maintain the highest standards;
- participate in staff introduction to, and continuous training in, the handling and disposal of health-care waste;
- liaise with Department Heads to ensure coordination of training activities, other waste management issues specific to particular departments, etc.

Infection Control Officer

The Infection Control Officer should liaise with the WMO on a continuous basis and provide advice concerning the control of infection and the standards of the waste disposal system. His or her duties are to:

- identify training requirements according to staff grade and occupation;
- organize and supervise staff training courses on safe waste management;
- liaise with the Department Heads, the Matron, and the Hospital Manager to coordinate the training.

The Infection Control Officer also has overall responsibility for chemical disinfection, sound management of chemical stores, and chemical waste minimization.

Chief Pharmacist

The Chief Pharmacist is responsible for the sound management of pharmaceutical stores and for pharmaceutical waste minimization. His or her duties are to:

- liaise with Department Heads, the WMO, the Matron, and the Hospital Manager, giving advice, in accordance with the national policy and guidelines, on the appropriate procedures for pharmaceutical waste disposal;
- coordinate continuous monitoring of procedures for the disposal of pharmaceutical waste;
- ensure that personnel involved in pharmaceutical waste handling and disposal receive adequate training.

The Chief Pharmacist also has the special responsibility of ensuring the safe utilization of genotoxic products and the safe management of genotoxic waste.

Radiation Officer

The duties and responsibilities of the Radiation Officer are the same as those of the Pharmaceutical Officer but relate to radioactive waste.

Supply Officer

The Supply Officer should liaise with the WMO to ensure a continuous supply of the items required for waste management (plastic bags and containers of the right quality, spare parts for on-site health-care waste treatment equipment, etc.). These items should be ordered in good time to ensure that they are always available, but accumulation of excessive stores should be avoided. The Supply Officer should also investigate the possibility of purchasing environmentally friendly products (e.g. PVC-free plastic items).

Hospital Engineer

The Hospital Engineer is responsible for installing and maintaining waste storage facilities and handling equipment that comply with the specifications of the national guidelines. She or he is also accountable for the adequate operation and maintenance of any on-site waste treatment equipment and is responsible for the staff involved in waste treatment, ensuring that:

- staff receive training in the principles of waste disposal and are aware of their responsibilities under the hospital waste management plan;
- staff operating on-site waste treatment facilities are trained in their operation and maintenance.

5.4.3 Assessment of waste generation

In order to develop a waste management plan, the waste management team needs to make an assessment of all waste generated in the hospital. The WMO should be responsible for coordinating such a survey and for analysing the results.

The waste should be categorized according to the classification system specified in the national guidelines (or as described in this handbook if no such guidelines are available). The survey should determine the average daily quantity of waste in each category generated by each hospital department. Special care should be taken to assess the likelihood of peak production—the occasional generation of extraordinary quantities of wastes. For example, the impact of epidemics and other emergencies that affect the quantities of waste generated should be estimated. Account should also be taken of potential slack periods or other unusual circumstances that may cause significant variations in waste quantities. Survey results should include an assessment of any future changes in hospital designation, departmental growth, or the establishment of new departments. Table 5.1 shows a sample sheet for the daily assessment of waste, by waste category, for each waste collection point.

Data from the waste production survey should form the basis on which an appropriate waste management plan can be developed.

5.4.4 Development of a waste management plan

During development of the waste management plan, every member of the waste management team (WMT) should carry out a review of existing waste management arrangements in his or her area of responsibility. Existing practices should then be evaluated in the light of the national guidelines and recommendations made to the WMO on how the guidelines can be implemented in each area. On the basis of the waste generation survey and these recommendations, the WMO should prepare a draft discussion document for the WMT. This discussion document should include details of the new waste management system as outlined in Box 5.2. It should be divided into sections addressing the following issues:

- present situation (waste management practices, personnel and equipment involved)
- quantities of waste generated
- possibilities for waste minimization, reuse, and recycling
- waste segregation

Table 5.1 *Sample sheet for assessment of waste generation^a*

Name of the health-care facility: Week:

Waste collection point: department/location	Waste category ^b (specify)	Quantity of waste generated per day (weight and volume)													
		Monday		Tuesday		Wednesday		Thursday		Friday		Saturday		Sunday	
		kg	litre	kg	litre	kg	litre	kg	litre	kg	litre	kg	litre	kg	litre

^aAdapted from Christen (1996), with permission.

^bInfectious waste, pathological waste, sharps, pharmaceutical waste, cytotoxic waste, waste with high heavy-metal content, radioactive waste.

- on-site handling, transport, and storage practices
- identification and evaluation of waste treatment and disposal options (on- and off-site)
- identification and evaluation of the options, and associated costs
- record-keeping
- training
- estimation of costs relating to waste management (actual situation and proposed options)
- strategy for implementation of the plan.

The draft discussion document should be prepared in consultation with all members of the WMT and their staff. Officials from the local authority and from the national government agency responsible for the disposal of health-care wastes should be invited to assist in the development of the waste management plan (WMP). The WMP should be based on the discussion document and should be presented to a meeting of the WMT for approval. The WMO should amend the draft discussion document in the light of comments made by the WMT. When full agreement has been reached, the document should be designated as the hospital WMP.

The WMO should now complete the WMP with a diagram that outlines the line management structure and the liaison paths, and a list of names and telephone numbers of responsible personnel to be notified in the event of an emergency.

Box 5.2 Details for inclusion in the waste management plan

Location and organization of collection and storage facilities

1. Drawings of the establishment showing designated bag-holder sites for every ward and department in the hospital; each bag site shall be appropriately designated for health-care waste or other waste.
2. Drawings showing the central storage site for health-care waste and the separate site for other waste. Details of the type of containers, security equipment, and arrangements for washing and disinfecting waste-collection trolleys (or other transport devices) should be specified. The document should also address eventual needs for refrigerated storage facilities.
3. Drawings showing the paths of waste-collection trolleys through the hospital, with clearly marked individual collection routes.
4. A collection timetable for each trolley route, the type of waste to be collected, the number of wards and departments to be visited on one round. The central storage point in the establishment for that particular waste should be identified.

Design specifications

5. Drawings showing the type of bag holder to be used in the wards and departments.
6. Drawings showing the type of trolley or wheeled container to be used for bag collection.
7. Drawings of sharps containers, with their specification.

Required material and human resources

8. An estimate of the number and cost of bag holders and collection trolleys.
9. An estimate of the number of sharps containers and health-care waste drum containers required annually, categorized into different sizes if appropriate.
10. An estimate of the number and cost of yellow and black plastic bags to be used annually.
11. An estimate of the number of personnel required for waste collection.

Responsibilities

12. Definitions of responsibilities, duties, and codes of practice for each of the different categories of personnel of the hospital who, through their daily work, will generate waste and be involved in the segregation, storage, and handling of the waste.
13. A definition of the responsibilities of hospital attendants and ancillary staff in collecting and handling wastes, for each ward and department; where special practices are required, e.g. for radioactive waste or hazardous chemical waste, the stage at which attendants or ancillary staff become involved in waste handling shall be clearly defined.

Procedures and practices

14. Simple diagram (flow chart) showing procedure for waste segregation.
15. The procedures for segregation, storage, and handling of wastes requiring special arrangements, such as autoclaving.
16. Outline of monitoring procedures for waste categories and their destination.
17. Contingency plans, containing instructions on storage or evacuation of health-care waste in case of breakdown of the treatment unit or during closure down for planned maintenance.
18. Emergency procedures.

Training

19. Training courses and programmes.

5.4.5 Implementation of the waste management plan

Implementation of the WMP is the responsibility of the Head of Hospital. It involves the following steps:

1. Interim measures, to be introduced as a precursor to complete implementation of the new waste management system, should be developed by the WMO, in collaboration with the WMT, and be appended to the plan. A bar chart should also be added, showing dates of implementation of each part of the new system.
2. Provision for future expansion—of the hospital or of waste storage facilities—should be made.
3. The Head of Hospital appoints personnel to the posts with responsibility for waste management. Notices of these appointments should be widely circulated and updates should be issued when changes occur.
4. The Infection Control Officer should organize and supervise training programmes for all staff, in collaboration with the WMO and other members of the WMT. Initial training sessions should be attended by key staff members, including medical staff, who should be urged to be vigilant in monitoring the performance of waste disposal duties by non-medical staff. The Infection Control Officer should choose the speakers for training sessions and determine the content and type of training given to each category of personnel.
5. As soon as the actions in 1–4 have been completed and necessary equipment for waste management is available, the operations described in the WMP can be put into practice.
6. The WMT should review the WMP annually and initiate changes necessary to upgrade the system. Interim revisions may also be made as and when necessary.
7. The Head of Hospital should prepare an annual report to the national government agency responsible for the disposal of health-care wastes, providing data on waste generation and disposal, personnel and equipment requirements, and costs.

Failures in the waste handling, segregation, storage, transport, or disposal system, or waste management incidents that result in injury should be reported as soon as possible to the Infection Control Officer.

5.5 Management of health-care waste from scattered small sources

5.5.1 Basic principles

Improvement in health-care waste management should start in large hospitals, then extend to smaller health-care establishments, and finally to the diverse sources of small quantities of waste.

The heads of health-care establishments are responsible for health protection and safety at the workplace and bear legal responsibility for the safe disposal of health-care waste generated in their establishments. They should therefore take all reasonable measures to:

- prevent health-care waste from causing environmental pollution or adverse effects on human health;
- ensure that health-care waste is adequately segregated (as outlined in section 7.1) and safely packed, especially in the case of sharps which should be packed in puncture-proof containers;

- ensure that bags or containers of health-care waste are handled only by those officially licensed to transport and/or dispose of such waste;
- ensure that a transfer note describing the waste is handed to the recipient when waste is transferred;
- check that the driver of the collection vehicle is aware of the rules governing transport of hazardous goods.

The options for safe collection and disposal of health-care waste from small sources, which do usually not treat their own waste, include the following:

- the local authority or an authorized private contractor collects the waste for treatment at a local hospital incinerator or other facility;
- an authorized private contractor collects and treats the waste at the contractor's treatment facility;
- the local authority or an authorized private contractor collects the waste for treatment at a municipal waste incinerator or for treatment by another disinfection or confinement process.

All waste should be clearly marked with self-adhesive or tie-on labels indicating point of production (hospital and department), content, and—in the case of transport off-site—certain additional information (see also sections 7.2 and 7.3). Any contract for collection by a private registered health-care waste carrier should identify the disposal or treatment facility to be used. The carrier should, whenever possible, use dedicated vehicles for the collection of infectious waste. Collection of health-care wastes from their source should be regular and frequent. Any storage of waste before destruction or collection for off-site disposal should be in a secure location designated for the purpose.

Private practitioners, health-care research establishments, haemodialysis centres, veterinary practices, and nursing homes should establish infection control policies. All employees should be able to understand the policy, which should contain details of the procedures to follow in case of a needle-stick injury or exposure to infected blood.

5.5.2 Private medical or dental practitioners

Private medical and dental practitioners represent numerous, scattered sources of health-care waste, including contaminated sharps. They should establish certain rules for dealing with health-care waste:

- Arrangements should be made for waste segregation (see section 7.1) and collection; specific containers for sharps and infectious waste will usually be needed.
- When an injection is carried out at a patient's home, the practitioner is responsible for disposing of syringes, needles, and all other items used.
- Practitioners' employees should be informed of policy and procedures of health-care waste disposal, including any special arrangements with hospitals, clinics, or local authorities, and should be appropriately trained.

5.5.3 Research activities

Waste produced in research areas can range from small items such as culture dishes to large animal carcasses, and may also include soiled

beddings and sharps. The waste is often infectious or even highly infectious. Heads of research units are responsible for the training of personnel and for ensuring correct segregation of waste. Because of the nature of the waste generated in research establishments, the following precautions should be taken:

- Highly infectious waste should be autoclaved or incinerated on site whenever possible and should be handled only by trained and authorized staff.
- If on-site treatment is impossible or uneconomical, cooled storage facilities should be provided and there should be a regular collection by a contractor who has suitable incineration facilities.
- Animal carcasses that cannot be destroyed immediately after experimentation should be stored at a temperature below -20°C .

Any contractual arrangement for research by workers outside the establishment should include adequate provisions for the safe handling and disposal of any waste.

Biotechnology laboratories may generate waste that presents special hazards (such as genetically modified material) and that should in no circumstances be released into the environment. Management of such waste needs additional precautions that are beyond the scope of this handbook.

5.5.4 Nursing homes

Waste from nursing homes will consist mainly of swabs, soiled dressings, sharps, stoma bags, and incontinence pads. Suitable containers will be required for infectious waste and sharps. The head of each establishment is responsible for the training of all personnel and for implementing segregation practices.

5.5.5 Home treatment

The amount of health-care waste produced at an individual patient's home will be very small. Most of it will be handled by the patient or by his or her family. It will mainly consist of items contaminated with blood (e.g. from haemodialysis patients equipped with machines), incontinence pads, dressings, or syringes and hypodermic needles (e.g. from diabetics).

Sharps may be packed in small puncture-proof containers and then disposed of with the general refuse. Diabetics should be provided with such containers or boxes for hypodermic needles and should return them, when full, to the physician in charge of treatment. Health-care waste other than sharps should be double-packed in plastic bags and then disposed of with household refuse. Health-care waste produced by chemotherapy treatments at home, such as needles from infusion sets or syringes, and protective gloves, contaminated with cytotoxic drugs, should be packaged safely and transferred to the treating physician. In some countries, separate collection services are provided for health-care waste produced at home or in hotels.

5.5.6 Ambulance services

Ambulance services and the hospitals they serve should have a policy for the safe disposal of health-care waste. Ambulances should be equipped

with puncture-proof containers of appropriate size, mainly for infectious waste and sharps. The sealed yellow bags and containers should be deposited at the hospital emergency department on arrival and can then be dealt with by that department. Ambulance staff should be trained in the safe handling of health-care waste.

5.5.7 Veterinary centres

Waste from health-care research activities involving animals should be handled in the same way as waste arising from human health-care. Waste from veterinary health-care activities is not addressed in this handbook.

References and suggested further reading

- Christen J (1996). *Dar es Salaam Urban Health Project. Health-care waste management in district health facilities: situational analysis and system development*. St Gallen, Switzerland, Swiss Centre for Development Cooperation in Technology and Management (SKAT).
- WHO (1995). *Survey of hospital wastes management in South-East Asia Region*. New Delhi, World Health Organization Regional Office for South-East Asia (document SEA/EH/493).
- WHO (1997). *Action plan for the development of national programme for sound management of hospital wastes. An outcome of the Regional Consultation on Sound Management of Hospital Waste, Chiang Mai, Thailand, 28–29 November 1996*. New Delhi, World Health Organization Regional Office for South-East Asia.
- WHO/CEPIS (1994). *Guía para el manejo interno de residuos sólidos hospitalarios. [Guide to the internal management of solid hospital waste.]* Lima, World Health Organization/Pan American Sanitary Engineering and Environmental Sciences Center.

6

Waste minimization, recycling, and reuse

6.1 Waste minimization

Significant reduction of the waste generated in health-care establishments and research facilities may be encouraged by the implementation of certain policies and practices, including the following:

- **Source reduction:** measures such as purchasing restrictions to ensure the selection of methods or supplies that are less wasteful or generate less hazardous waste.
- **Recyclable products:** use of materials that may be recycled, either on-site or off-site.
- **Good management and control practices:** apply particularly to the purchase and use of chemicals and pharmaceuticals.
- **Waste segregation:** careful segregation (separation) of waste matter into different categories (see section 7.1) helps to minimize the quantities of hazardous waste.

A number of examples of policies and practices that tend to minimize quantities of waste are summarized in Box 6.1.

Careful management of stores will prevent the accumulation of large quantities of outdated chemicals or pharmaceuticals and limit the waste to the packaging (boxes, bottles, etc.) plus residues of the products remaining in the containers. These small amounts of chemical or pharmaceutical waste can be disposed of easily and relatively cheaply, whereas disposing of larger amounts requires costly and specialized treatment, which underlines the importance of waste minimization.

Waste minimization usually benefits the waste producer: costs for both the purchase of goods and for waste treatment and disposal are reduced and the liabilities associated with the disposal of hazardous waste are lessened.

All health-service employees have a role to play in this process and should therefore be trained in waste minimization and the management of hazardous materials. This is particularly important for the staff of departments that generate large quantities of hazardous waste.

Suppliers of chemicals and pharmaceuticals can also become responsible partners in waste minimization programmes. The health service can encourage this by ordering only from suppliers who provide rapid delivery of small orders, who accept the return of unopened stock, and who offer off-site waste management facilities for hazardous wastes.

Reducing the toxicity of waste is also beneficial, by reducing the problems associated with its treatment or disposal. For example, the Supply Officer could investigate the possibilities of purchasing PVC-free

Box 6.1 Examples of policies and practices that encourage waste minimization

Source reduction

- Purchasing reductions: selection of supplies that are less wasteful or less hazardous.
- Use of physical rather than chemical cleaning methods (e.g. steam disinfection instead of chemical disinfection).
- Prevention of wastage of products, e.g. in nursing and cleaning activities.

Management and control measures at hospital level

- Centralized purchasing of hazardous chemicals.
- Monitoring of chemical flows within the health facility from receipt as raw materials to disposal as hazardous wastes.

Stock management of chemical and pharmaceutical products

- Frequent ordering of relatively small quantities rather than large amounts at one time (applicable in particular to unstable products).
- Use of the oldest batch of a product first.
- Use of *all* the contents of each container.
- Checking of the expiry date of all products at the time of delivery.

plastics that may be recycled or of goods supplied without unnecessary packaging.

6.2 Safe reuse and recycling

Medical and other equipment used in a health-care establishment may be reused provided that it is designed for the purpose and will withstand the sterilization process. Reusable items may include certain sharps, such as scalpels and hypodermic needles, syringes, glass bottles and containers, etc. After use, these should be collected separately from non-reusable items, carefully washed (particularly in the case of hypodermic needles, in which infectious droplets could be trapped), and may then be sterilized by one of the processes listed in Box 6.2. Although reuse of hypodermic needles is not recommended, it may be necessary in establishments that cannot afford disposable syringes and needles. Plastic syringes and catheters should not be thermally or chemically sterilized; they should be discarded.

Long-term radionuclides conditioned as pins, needles, or seeds and used for radiotherapy may be reused after sterilization.

Special measures must be applied in the case of potential or proven contamination with the causative agents of transmissible spongiform encephalopathies (also known as prion diseases). These measures, which

Box 6.2 Examples of sterilization methods for reusable items

Thermal sterilization

- *Dry sterilization*
Exposure to 160 °C for 120 minutes or 170 °C for 60 minutes in a “Poupinel” oven.
- *Wet sterilization*
Exposure to saturated steam at 121 °C for 30 minutes in an autoclave.

Chemical sterilization

- *Ethylene oxide*
Exposure to an atmosphere saturated with ethylene oxide for 3–8 hours, at 50–60 °C, in a reactor tank; the so-called “gas-sterilizer” tank should be dry before injection of the ethylene oxide. Ethylene oxide is a very hazardous chemical; this process should therefore be undertaken only by highly trained and adequately protected technical personnel (see section 8.2 for protective measures).
- *Glutaraldehyde*
Exposure to a glutaraldehyde solution for 30 minutes. This process is safer for the operators than the use of ethylene oxide but is microbiologically less efficient.

are capable of reducing or eliminating infectivity, are described in detail in a WHO document.¹

The effectiveness of thermal sterilization may be checked, for example, by the *Bacillus stearothermophilus* test and of chemical sterilization by the *Bacillus subtilis* test (see Box 8.13, page 102, for description).

Certain types of container may be reused provided that they are carefully washed and disinfected. Containers of pressurized gas, however, should generally be sent to specialized centres to be refilled. Containers that once held detergent or other liquids may be reused as containers for sharps waste (if purpose-made containers are not affordable) provided that they are puncture-proof and correctly and clearly marked on all sides.

Recycling is usually not practised by health-care facilities, apart, perhaps, from the recovery of silver from fixing-baths used in processing X-ray films. However, recycling of materials such as metals, paper, glass, and plastics can result in savings for the health-care facility—either through reduced disposal costs or through payments made by the recycling company.

In temperate climates, the heat generated by on-site incinerators may be an attractive and cost-effective option for heating hospital premises.

In determining the economic viability of recycling, it is important to take account of the costs of alternative disposal methods and not just the cost of the recycling process and the value of the reclaimed material.

¹ *Report of a WHO consultation on public health issues related to animal and human encephalopathies*. Geneva, World Health Organization, 1992 (unpublished document WHO/CDS/VPH/92.104, available on request from Department of Communicable Disease Surveillance and Response, World Health Organization, 1211 Geneva 27, Switzerland). This document was undergoing revision at the time of publication of this handbook.

7

Handling, storage, and transportation of health-care waste

7.1 Waste segregation and packaging

The key to minimization and effective management of health-care waste is segregation (separation) and identification of the waste. Appropriate handling, treatment, and disposal of waste by type reduces costs and does much to protect public health. Segregation should always be the responsibility of the waste producer, should take place as close as possible to where the waste is generated, and should be maintained in storage areas and during transport. The same system of segregation should be in force throughout the country.

The most appropriate way of identifying the categories of health-care waste is by sorting the waste into colour-coded plastic bags or containers. The recommended colour-coding scheme is given in Table 7.1.

In addition to the colour coding of waste containers, the following practices are recommended:

- General health-care waste should join the stream of domestic refuse for disposal.
- Sharps should all be collected together, regardless of whether or not they are contaminated. Containers should be puncture-proof (usually made of metal or high-density plastic) and fitted with covers. They should be rigid and impermeable so that they safely retain not only the sharps but also any residual liquids from syringes. To discourage abuse, containers should be tamper-proof (difficult to open or break) and needles and syringes should be rendered unusable. Where plastic or metal containers are unavailable or too costly, containers made of dense cardboard are recommended (WHO, 1997); these fold for ease of transport and may be supplied with a plastic lining. See Fig. 7.1.
- Bags and containers for infectious waste should be marked with the international infectious substance symbol (see Fig. 7.2).
- Highly infectious waste should, whenever possible, be sterilized immediately by autoclaving. It therefore needs to be packaged in bags that are compatible with the proposed treatment process: red bags, suitable for autoclaving, are recommended.
- Cytotoxic waste, most of which is produced in major hospital or research facilities, should be collected in strong, leak-proof containers clearly labelled “Cytotoxic wastes”.
- Small amounts of chemical or pharmaceutical waste may be collected together with infectious waste.
- Large quantities of obsolete or expired pharmaceuticals stored in hospital wards or departments should be returned to the pharmacy for disposal. Other pharmaceutical waste generated at this level, such as spilled or contaminated drugs or packaging containing drug residues should *not* be returned because of the risk of contaminating the phar-

Table 7.1 Recommended colour-coding for health-care waste

Type of waste	Colour of container and markings	Type of container
Highly infectious waste	Yellow, marked "HIGHLY INFECTIOUS"	Strong, leak-proof plastic bag, or container capable of being autoclaved
Other infectious waste, pathological and anatomical waste	Yellow	Leak-proof plastic bag or container
Sharps	Yellow, marked "SHARPS"	Puncture-proof container
Chemical and pharmaceutical waste	Brown	Plastic bag or container
Radioactive waste ^a	—	Lead box, labelled with the radioactive symbol ^b
General health-care waste	Black	Plastic bag

^aOnly generated in major hospitals; see also section 9.7.

^bSee Fig. 7.6.

Fig. 7.1. Collapsible cardboard sharps container



Fig. 7.2 International infectious substance symbol



macy; it should be deposited in the correct container at the point of production.

- Large quantities of chemical waste should be packed in chemical-resistant containers and sent to specialized treatment facilities (if available). The identity of the chemicals should be clearly marked on the containers: hazardous chemical wastes of different types should never be mixed.
- Waste with a high content of heavy metals (e.g. cadmium or mercury) should be collected separately.
- Aerosol containers may be collected with general health-care waste once they are completely empty, provided that the waste is not destined for incineration.
- Low-level radioactive infectious waste (e.g. swabs, syringes for diagnostic or therapeutic use) may be collected in yellow bags or containers for infectious waste if these are destined for incineration.

Since costs for safe treatment and disposal of hazardous health-care waste are typically more than 10 times higher than those for general waste, all general, i.e. non-hazardous, waste should be handled in the same manner as domestic refuse and collected in black bags. No health-care waste other than sharps should be deposited in sharps containers, as these containers are more expensive than the bags used for other infectious waste. Measures of this sort help to minimize the costs of health-care waste collection and treatment. When a disposable syringe is used, for example, the packaging should be placed in the general waste bin and the used syringe in the yellow sharps container. In most circumstances, the needle should *not* be removed from the syringe because of the risk of injury; if removal of the needle is required, special care must be taken.

Appropriate containers or bag holders should be placed in all locations where particular categories of waste may be generated. Instructions on waste separation and identification should be posted at each waste collection point to remind staff of the procedures. Containers should be removed when they are three-quarters full. Examples of suitable containers and bags are shown in Fig. 7.3 and Plates 7.1–7.3. Ideally, they should be made of combustible, non-halogenated plastics.

Staff should never attempt to correct errors of segregation by removing items from a bag or container after disposal or by placing one bag inside another bag of a different colour. If general and hazardous wastes are accidentally mixed, the mixture should be treated as hazardous health-care waste.

Cultural and religious constraints in certain countries make it unacceptable for anatomical waste to be collected in the usual yellow bags; such waste should be disposed of in accordance with local custom, which commonly specifies burial.

Fig. 7.3 Waste containers recommended for small hospitals in Thailand^a

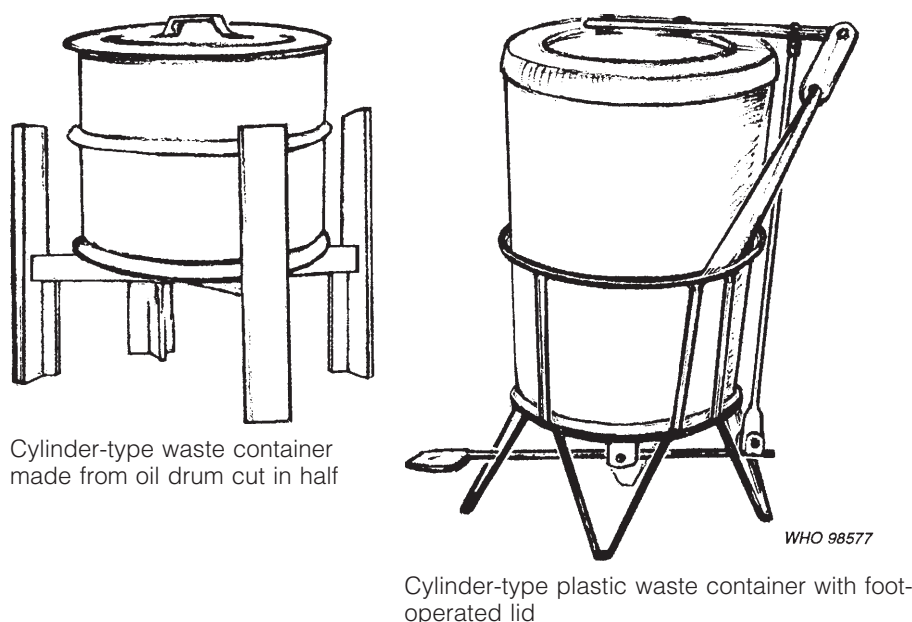

^aSource: Ministry of Health (1995), *Handbook of hazardous healthcare waste management in 10-bed and 30-bed community hospitals*, Bangkok; used with permission.

7.2 On-site collection, transport, and storage of waste

7.2.1 Collection

Nursing and other clinical staff should ensure that waste bags are tightly closed or sealed when they are about three-quarters full. Light-gauge bags can be closed by tying the neck, but heavier-gauge bags probably require a plastic sealing tag of the self-locking type. Bags should *not* be closed by stapling. Sealed sharps containers should be placed in a labelled, yellow infectious health-care waste bag before removal from the hospital ward or department.

Wastes should not be allowed to accumulate at the point of production. A routine programme for their collection should be established as part of the health-care waste management plan.

Certain recommendations should be followed by the ancillary workers in charge of waste collection:

- Waste should be collected daily (or as frequently as required) and transported to the designated central storage site.
- No bags should be removed unless they are labelled with their point of production (hospital and ward or department) and contents.
- The bags or containers should be replaced immediately with new ones of the same type.

A supply of fresh collection bags or containers should be readily available at all locations where waste is produced.

7.2.2 Storage

A storage location for health-care waste should be designated inside the health-care establishment or research facility. The waste, in bags or containers, should be stored in a separate area, room, or building of a size appropriate to the quantities of waste produced and the frequency of collection. Recommendations for the storage area and its equipment are listed in Box 7.1.

Unless a refrigerated storage room is available, storage times for health-care waste (i.e. the delay between production and treatment) should not exceed the following:

temperate climate: 72 hours in winter
48 hours in summer

warm climate: 48 hours during the cool season
24 hours during the hot season

Cytotoxic waste should be stored separately from other health-care waste in a designated secure location.

Radioactive waste should be stored in containers that prevent dispersion, behind lead shielding. Waste that is to be stored during radioactive decay should be labelled with the type of radionuclide, the date, and details of required storage conditions. Further information is provided in section 9.7, which addresses methods of treatment and disposal of radioactive waste.

Box 7.1 Recommendations for storage facilities for health-care waste

- The storage area should have an impermeable, hard-standing floor with good drainage; it should be easy to clean and disinfect.
- There should be a water supply for cleaning purposes.
- The storage area should afford easy access for staff in charge of handling the waste.
- It should be possible to lock the store to prevent access by unauthorized persons.
- Easy access for waste-collection vehicles is essential.
- There should be protection from the sun.
- The storage area should be inaccessible for animals, insects, and birds.
- There should be good lighting and at least passive ventilation.
- The storage area should not be situated in the proximity of fresh food stores or food preparation areas.
- A supply of cleaning equipment, protective clothing, and waste bags or containers should be located conveniently close to the storage area.

7.2.3 On-site transport

Health-care waste should be transported within the hospital or other facility by means of wheeled trolleys, containers, or carts that are not used for any other purpose and meet the following specifications:

- easy to load and unload;
- no sharp edges that could damage waste bags or containers during loading and unloading;
- easy to clean.

The vehicles should be cleaned and disinfected daily with an appropriate disinfectant (see Chapter 14). All waste-bag seals should be in place and intact at the end of transportation. Different types of vehicle for the on-site transportation of health-care waste are shown in Plate 7.4 and Fig. 7.4.

7.3 Off-site transportation of waste

7.3.1 Regulation and control system

The health-care waste producer is responsible for safe packaging and adequate labelling of waste to be transported off-site and for authorization of its destination. Packaging and labelling should comply with

Fig. 7.4 Wheeled vehicles used for transportation of health-care waste in small hospitals in Thailand^a

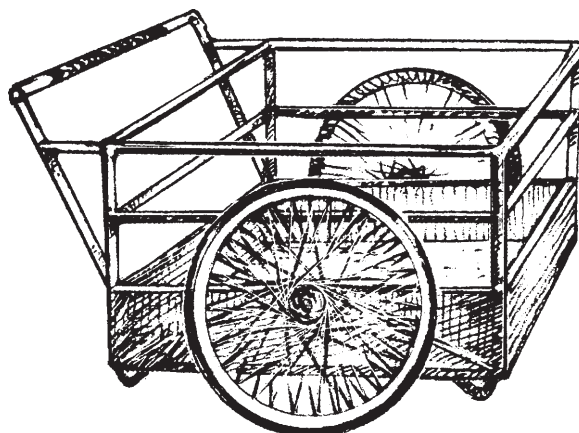

Waste vehicle with opaque floor and partly opaque sides

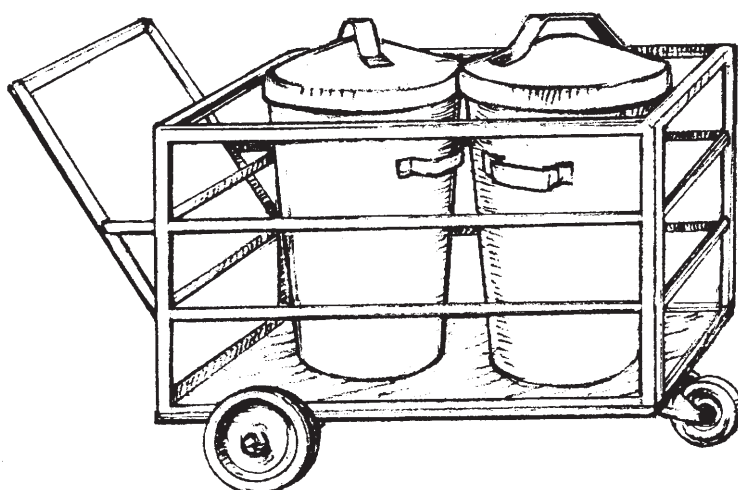

Waste vehicle that can be loaded with either containers or plastic bags

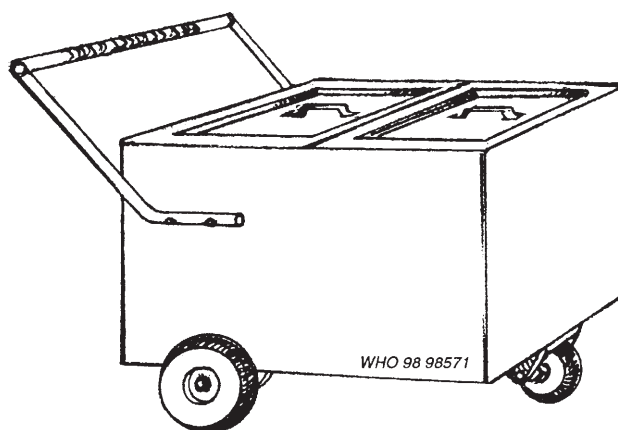

Waste vehicle with opaque sides and compartments to load waste or waste bags

^aSource: Ministry of Health (1995), *Handbook of hazardous healthcare waste management in 10-bed and 30-bed community hospitals*, Bangkok; used with permission.

national regulations governing the transport of hazardous wastes, and with international agreements if wastes are shipped abroad for treatment. In case there are no such national regulations, responsible authorities may refer to *Recommendations on the transport of dangerous goods*, published by the United Nations.

The control strategy for health-care waste should have the following components:

- A consignment note should accompany the waste from its place of production to the site of final disposal. On completion of the journey, the transporter should complete the part of the consignment note especially reserved for him and return it to the waste producer. A typical consignment note for carriage and disposal of hazardous waste, used in the United Kingdom, and the routing of the consignment note are shown in Figs 7.5 and 7.6, respectively.
- The transporting organization should be registered with, or known to, the waste regulation authority.
- Handling and disposal facilities should hold a permit, issued by a waste regulation authority, allowing the facilities to handle and dispose of health-care waste.

The consignment note should be designed to take into account the waste control system in operation within the country. The “Multimodal Dangerous Goods Form” recommended by the United Nations may be taken as an example (for a simplified version of this form see Fig. 7.7).

If a waste regulation authority is sufficiently well established, it may be possible to pre-notify the agency about the planned system of transport and disposal of the health-care waste and obtain the agency’s approval.

Anyone involved in the production, handling, or disposal of health-care waste has a general “duty of care”, i.e. an obligation to ensure that waste handling and associated documentation comply with the national regulations.

7.3.2 Special packaging requirements for off-site transport

In general, the waste should be packaged according to the recommendations provided in section 7.1 above, in sealed bags or containers, to prevent spilling during handling and transportation. The bags or containers should be appropriately robust for their content (puncture-proof for sharps, for example, or resistant to aggressive chemicals) and for normal conditions of handling and transportation, such as vibration or changes in temperature, humidity, or atmospheric pressure.

In addition, radioactive material should be packed in containers whose surfaces can be easily decontaminated. The United Nations recommend further packing requirements for infectious substances. For infectious health-care wastes, it is recommended that packaging should be design type-tested and certified as approved for use. Health-care wastes that are known or suspected to contain pathogens likely to cause human disease should be considered as “Infectious Substances” (UN No. 2814: INFECTIOUS SUBSTANCE, AFFECTING HUMANS) and should comply with the packaging requirements indicated in Box 7.2. The packaging recommended for most health-care wastes, with a relatively low probability that infectious substances are present and which are not

Fig. 7.5 Example of consignment note for carriage and disposal of hazardous waste^a

[Name of waste regulation authority] [Address and telephone number of waste regulation authority]		Serial no.
		Originator's reference
CONSIGNMENT NOTE FOR THE CARRIAGE AND DISPOSAL OF HAZARDOUS WASTE		
A	Producer's Certificate (1) The material described in B is to be collected from: and (2) taken to: Signed Name On behalf of Position Address Telephone no. Date Estimated date of collection	
B	Description of the Waste (1) General description and physical nature of waste (2) Relevant chemical and biological components and maximum concentrations (3) Quantity of waste and size, type and number of containers (4) Process(es) from which waste originated	
C	Carrier's Collection Certificate I certify that I collected the consignment of waste and that the information given in A (1) and (2) and B (1) and (3) is correct, subject to any amendment listed in this space: I collected this consignment on at hours Signed Name Date On behalf of Vehicle reg. no. Address Telephone no.	
D	Producer's Collection Certificate I certify that the information given in B and C is correct and that the carrier was advised of appropriate precautionary measures. Signed Name Date Tel. no.	
E	Disposer's Certificate I certify that Waste Disposal Licence No , issued by [name of issuing body], authorizes the treatment/disposal at this facility of the waste described in B (and as amended where necessary at C). Name and address of facility This waste was delivered in vehicle [reg. no.] at hours on [date] and the carrier gave his name as on behalf of Proper instructions were given that the waste should be taken to Signed Name Position Date on behalf of	
For use by Producer/ Carrier/ Disposer		

^aBased on a consignment note that has been used in the United Kingdom.

Fig. 7.6 Route of the consignment note used in the United Kingdom^a

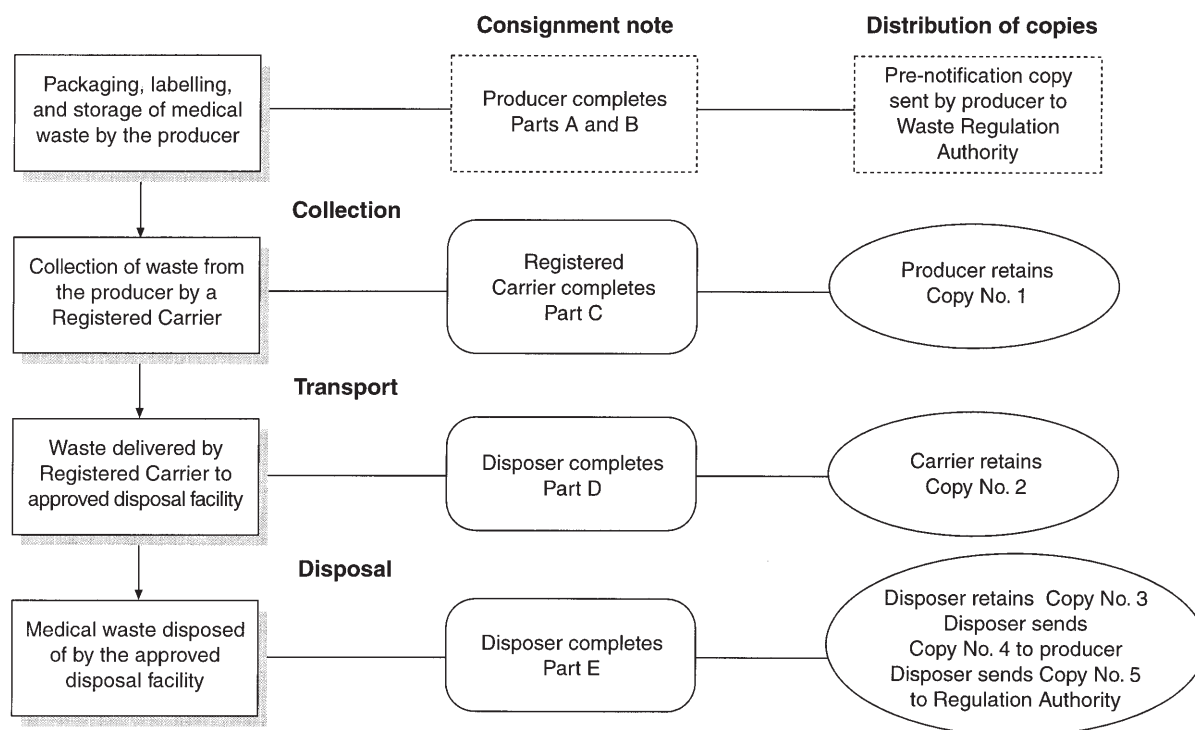

^aSource: London Waste Regulation Authority (1994).

WHO 96228

Box 7.2 United Nations packaging requirements for infectious substances, class 6.2, UN No. 2814: INFECTIOUS SUBSTANCE, AFFECTING HUMANS (adapted to hazardous health-care waste)^a

The packaging should include the following essential elements:

- An inner packaging comprising:
 - watertight primary receptacle of metal or plastics with leak-proof seal (e.g. a heat seal, a skirted stopper, or a metal crimp seal);
 - a watertight secondary packaging;
 - absorbent material in sufficient quantity to absorb the entire contents placed between the primary receptacle and the secondary packaging.
- An outer packaging of adequate strength for its capacity, mass, and intended use, and with a minimum external dimension of 100mm.

A list of contents should be enclosed between the secondary packaging and the outer packaging. The outer packaging should be appropriately labelled.

^aSource: United Nations (1997), used with permission.

Fig. 7.7 Adaptation of the Multimodal Dangerous Goods Form recommended by the United Nations^a

Shipper/Consignor/Sender (Name & Address)		Transport document number		
		Page 1 of pages	Shipper's reference	
			Freight Forwarder's reference	
Consignee		Carrier (to be completed by the carrier)		
Additional handling information		<p>SHIPPER'S DECLARATION I hereby declare that the contents of this consignment are fully and accurately described below by the proper shipping name, and are classified, packaged, marked and labelled/placarded and are in all respects in proper condition for transport according to the applicable international and national governmental regulations.</p>		
Shipping marks	Number & kind of packages; description of goods	Gross mass (kg)	Net mass	Cube (m ³)
Container identification no./ Vehicle registration	Seal number(s)	Container/vehicle size & type	Tare (kg)	Total gross mass (including tare) (kg)
<p>CONTAINER/VEHICLE PACKING CERTIFICATE I hereby declare that the goods described above have been packed/loaded into the container/vehicle identified above in accordance with the applicable provisions MUST BE COMPLETED AND SIGNED FOR ALL CONTAINER/VEHICLE LOADS BY PERSON RESPONSIBLE FOR PACKING/LOADING</p>		<p>RECEIVING ORGANISATION RECEIPT Received the above number of packages/containers/trailers in apparent good order and condition unless stated hereon: RECEIVING ORGANISATION REMARKS:</p>		
Name of the company		Haulier's name	Name of company (of shipper preparing this note)	
Name/Status of declarant		Vehicle reg. no.	Name/Status of declarant	
Place and date		Signature and date	Place and date	
Signature of declarant		DRIVER'S SIGNATURE	Signature of declarant	

^aSource: United Nations (1997), used with permission.

Box 7.3 United Nations packaging requirements for infectious substances, class 6.2, UN No. 3291: CLINICAL WASTE, UNSPECIFIED, N.O.S., OR (BIO)MEDICAL WASTE, N.O.S., OR REGULATED MEDICAL WASTE, N.O.S. (adapted to hazardous health-care waste)^a

There are two possibilities for packaging:

- Rigid and leak-proof packaging (complying with a number of requirements and tests specified by the United Nations (1997)).
- Intermediate bulk containers—large rigid or flexible bulk containers made from a variety of materials such as wood, plastics, or textile (complying with a number of requirements and tests specified by the United Nations (1997)).

Packaging or intermediate bulk containers intended to contain sharp objects such as broken glass and needles shall be resistant to puncture and shall undergo additional performance tests.

^aSource: United Nations (1997), used with permission.

likely to cause human disease (UN No. 3291: CLINICAL WASTE, UNSPECIFIED, N.O.S., OR (BIO)MEDICAL WASTE, N.O.S., OR REGULATED MEDICAL WASTE, N.O.S.), is simpler and is indicated in Box 7.3. However, since these packaging requirements are relatively complex, it is suggested that the United Nations recommendations are consulted directly for further details (United Nations, 1997).

7.3.3 Labelling

All waste bags or containers should be labelled with basic information on their content and on the waste producer. This information may be written directly on the bag or container or on preprinted labels, securely attached.

According to the United Nations recommendations for Class 6.2 substances, the following indications should appear on the label:

- the United Nations substance class, e.g. Class 6.2 for infectious waste (see Box 7.4 for other classes that may be relevant to health-care waste);
- the United Nations packaging symbol, e.g. the international symbol for infectious substances (see Figs 7.2 and 7.8 and Plate 7.5);
- the proper shipping name and the UN number (see examples in Box 7.5);
- the total quantity (mass or volume) of waste covered by the description;
- the country authorizing the allocation of the label (identified by international code system used on motor vehicles).

Box 7.4 United Nations substance classes that may characterize health-care waste

Class 5.1: Oxidizing substances

Class 6.1: Toxic substances

Class 6.2: Infectious substances (containers of sharps should in addition be marked with “Danger, contaminated sharps”)

Class 7: Radioactive material

Class 8: Corrosive substances

Classes 5.1, 6.1, and 8 would usually characterize chemical or pharmaceutical waste.

The classification should represent the most hazardous property of the transported waste.

Box 7.5 Examples of proper shipping names (recommended by the United Nations)

Note 1: N.O.S. = not otherwise specified.

Note 2: For wastes, the word “WASTE” should precede the shipping name.

<i>Class</i>	<i>UN number</i>	<i>Shipping name</i>
5.1	3212	HYPOCHLORITES, INORGANIC, N.O.S.
5.1	3139	OXIDIZING LIQUID, N.O.S.
5.1	1479	OXIDIZING SOLID, N.O.S.
6.1	1851	MEDICINE, LIQUID, TOXIC, N.O.S.
6.1	2810	TOXIC LIQUID, ORGANIC, N.O.S.
6.1	2811	TOXIC SOLID, ORGANIC, N.O.S.
6.1	3249	MEDICINE, SOLID, TOXIC, N.O.S.
6.2	3291	CLINICAL WASTE, UNSPECIFIED, N.O.S., or (BIO)MEDICAL WASTE, N.O.S., or REGULATED MEDICAL WASTE, N.O.S.
6.2	2814	INFECTIOUS SUBSTANCE, AFFECTING HUMANS
6.2	2900	INFECTIOUS SUBSTANCE, AFFECTING ANIMALS only
7	2912	RADIOACTIVE MATERIAL, LOW SPECIFIC ACTIVITY (LSA), N.O.S.
8	1759	CORROSIVE SOLID, N.O.S.
8	1760	CORROSIVE LIQUID, N.O.S.

Fig. 7.8 International ionizing radiation symbol

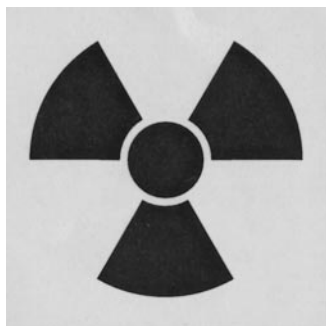

Fig. 7.9 Blank label

[SYMBOL]
(UN Class/year of waste packaging)
(UN Number, proper shipping name)
(Country/name of producer)
(Waste class/date of production)
(Special remarks)
(Waste quantity—waste destination)

It is also recommended that the last two digits of the year of manufacture of the packaging specified by the competent authority are marked on the package, as well as a special code designating the type of packaging (for details see United Nations, 1997).

For health-care waste, the following additional information should be marked on the label:

- waste category
- date of collection
- place in hospital where produced (e.g. ward)
- waste destination.

In case of problems involving questions of liability, full and correct labelling allows the origin of the waste to be traced. Labelling also warns operative staff and the general public of the hazardous nature of the waste. The hazards posed by container contents can be quickly identified in case of accident, enabling emergency services to take appropriate action.

Typical blank and completed labels are shown in Figs 7.9 and 7.10 respectively.

Cytotoxic waste should be marked with the label “CYTOTOXIC WASTE”.

7.3.4 Labelling for radioactive waste

Three labels have been designed by the UN/IAEA for radioactive material, providing information on the levels of activity of a given package. Unless the package is large (and it is assumed here that all packages containing radioactive waste do not exceed 1 m² in cross-sectional area),

Fig. 7.10 *Example of correct labelling*

[BIOHAZARD SYMBOL]
CLASS 6.2/98 (UN Class, year of waste packaging)
3291 CLINICAL WASTE, UNSPECIFIED, N.O.S. (UN Number, proper shipping name)
GB/Queen's University Hospital London (Country/name of producer)
Sharps/collected 04.05.1998 (Waste class/date of production)
DANGER—CONTAMINATED SHARPS (Special remarks)
350 kg—Special incinerator ARD, London (Waste quantity—waste destination)

Table 7.2 *Categories of packages for radioactive waste^a*

Conditions		Category
Maximum radiation level at a distance of 1 m from the external surface of the package	Maximum radiation level at any point on the external surface	
Not more than 0.0005 mSv/h	Not more than 0.005 mSv/h	I-WHITE
More than 0.0005 mSv/h but not more than 0.01 mSv/h	More than 0.005 mSv/h but not more than 0.5 mSv/h	II-YELLOW
More than 0.01 mSv/h but not more than 0.1 mSv/h	More than 0.5 mSv/h but not more than 2 mSv/h	III-YELLOW

^aAdapted from IAEA (1996), used with permission.

the labels should be chosen according to Table 7.2. If the two types of conditions of Table 7.2 differ, the package shall be assigned to the higher category. This categorization is as recommended in *Regulations for the safe transport of radioactive material* (IAEA, 1996). For large packages or higher activity levels than those dealt with here, these regulations (IAEA, 1996) should be consulted directly.

7.3.5 *Preparation for transportation*

Before transportation of the waste, dispatch documents should be completed, all arrangements should be made between consignor, carrier, and consignee, and, in case of exportation, the consignee should have confirmed with the relevant competent authorities that the waste can be legally imported and that no delays will be incurred in the delivery of the consignment to its destination.

7.3.6 *Transportation vehicles or containers*

Waste bags may be placed directly into the transportation vehicle, but it is safer to place them in further containers (e.g. cardboard boxes or wheeled, rigid, lidded plastic or galvanized bins). This has the advantage of reducing the handling of filled waste bags but results in higher disposal costs. These secondary containers should be placed close to the waste source.

Any vehicle used to transport health-care waste should fulfil the following design criteria:

- The body of the vehicle should be of a suitable size commensurate with the design of the vehicle, with an internal body height of 2.2 metres.
- There should be a bulkhead between the driver's cabin and the vehicle body, which is designed to retain the load if the vehicle is involved in a collision.
- There should be a suitable system for securing the load during transport.
- Empty plastic bags, suitable protective clothing, cleaning equipment, tools, and disinfectant, together with special kits for dealing with liquid spills, should be carried in a separate compartment in the vehicle.
- The internal finish of the vehicle should allow it to be steam-cleaned, and the internal angles should be rounded.
- The vehicle should be marked with the name and address of the waste carrier.
- The international hazard sign should be displayed on the vehicle or container, as well as an emergency telephone number.

A vehicle used for the transportation of health-care waste in the United Kingdom is shown in Fig. 7.11.

Vehicles or containers used for the transportation of health-care waste should not be used for the transportation of any other material. They should be kept locked at all times, except when loading and unloading. Articulated or demountable trailers (temperature-controlled if required) are particularly suitable, as they can easily be left at the site of waste production. Other systems may be used, such as specially designed large containers or skips; however, open-topped skips or containers should never be used for transporting health-care waste.

Where the use of a dedicated vehicle cannot be justified, a bulk container that can be lifted on to a vehicle chassis may be considered. The container may be used for storage at the health-care establishment and replaced with an empty one when collected. Refrigerated containers may be used if the storage time exceeds the recommendations in section 7.2.2 or transportation times are long. The finish of these bulk containers should be smooth and impervious and permit easy cleansing or disinfection.

The same safety measures should apply to the collection of hazardous health-care waste from scattered small sources.

Health-care establishments that practise minimal programmes of health-care waste management should either avoid off-site transportation of hazardous waste or at least use closed vehicles to avoid spillage.

Fig. 7.11 Example of vehicle used for transportation of health-care waste in the United Kingdom



The internal surfaces of any vehicle used for this purpose should be easy to clean.

7.3.7 Routing

Health-care waste should be transported by the quickest possible route, which should be planned before the journey begins. After departure from the waste production point, every effort should be made to avoid further handling. If handling cannot be avoided, it should be pre-arranged and take place in adequately designed and authorized premises. Handling requirements can be specified in the contract established between the waste producer and the carrier.

References

- IAEA (1996). *Regulations for the safe transport of radioactive material*. Vienna, International Atomic Energy Agency (IAEA Safety Standards Series, No. ST-1).
- London Waste Regulation Authority (1994). *The London Waste Regulation Authority's clinical waste guidelines*, 2nd ed. London.
- Ministry of Health (1995). *Handbook of hazardous health-care waste management in 10-bed and 30-bed community hospitals*. Bangkok.
- UN (1997). *Recommendations on the transport of dangerous goods—model regulations*, 10th revised ed. New York, United Nations (ST/SG/AC.10/1/Rev. 10).
- WHO (1997). *Product information sheets: equipment for Expanded Programme on Immunization, Acute Respiratory Infections, Blood Safety, Emergency Campaigns, Primary Health Care*. Geneva, World Health Organization (unpublished document WHO/EPI/LHIS/97.01, obtainable from Expanded Programme on Immunization, World Health Organization, 1211 Geneva 27, Switzerland).

8

Treatment and disposal technologies for health-care waste

Incineration used to be the method of choice for most hazardous health-care wastes and is still widely used. However, recently developed alternative treatment methods are becoming increasingly popular. The final choice of treatment system should be made carefully, on the basis of various factors, many of which depend on local conditions:

- disinfection efficiency;
- health and environmental considerations;
- volume and mass reduction;
- occupational health and safety considerations;
- quantity of wastes for treatment and disposal/capacity of the system;
- types of waste for treatment and disposal;
- infrastructure requirements;
- locally available treatment options and technologies;
- options available for final disposal;
- training requirements for operation of the method;
- operation and maintenance considerations;
- available space;
- location and surroundings of the treatment site and disposal facility;
- investment and operating costs;
- public acceptability;
- regulatory requirements.

Certain treatment options presented in this chapter may effectively reduce the infectious hazards of health-care waste and prevent scavenging but, at the same time, give rise to other health and environmental hazards. For example, incineration of certain types of health-care waste, particularly those containing chlorine or heavy metals, may under certain conditions (such as insufficiently high incineration temperatures, inadequate control of emissions) release toxic material into the atmosphere. Land disposal may result in groundwater pollution if the landfill site is inadequately designed and/or operated. In choosing a treatment or disposal method for health-care waste, particularly if there is a risk of toxic emissions or other hazardous consequences, the relative risks, as well as the integration into the overall framework of comprehensive waste strategy, should therefore be carefully evaluated in the light of local circumstances.

Advantages and drawbacks of the various treatment and disposal technologies discussed in this chapter are summarized in Table 8.4 (page 110).

8.1 Incineration

8.1.1 *Principles of incineration*

Incineration is a high-temperature dry oxidation process that reduces organic and combustible waste to inorganic, incombustible matter and

results in a very significant reduction of waste volume and weight. This process is usually selected to treat wastes that cannot be recycled, reused, or disposed of in a landfill site. The process flow is illustrated schematically in Fig. 8.1.

The combustion of organic compounds produces mainly gaseous emissions, including steam, carbon dioxide, nitrogen oxides, and certain toxic substances (e.g. metals, halogenic acids), and particulate matter, plus solid residues in the form of ashes. If the conditions of combustion are not properly controlled, toxic carbon monoxide will also be produced. The ash and wastewater produced by the process also contain toxic compounds, which have to be treated to avoid adverse effects on health and the environment.

Most large, modern incinerators include energy-recovery facilities. In cold climates, steam and/or hot water from incinerators can be used to feed urban district-heating systems, and in warmer climates the steam from incinerators is used to generate electricity. The heat recovered from small hospital incinerators is used for preheating of waste to be burnt.

Required waste characteristics

Incineration of waste is affordable and feasible only if the “heating value” of the waste reaches at least 2000kcal/kg (8370kJ/kg). The value for infectious waste, for instance, exceeds 4000kcal/kg. The characteristics that make waste suitable for incineration are listed in Box 8.1.

Fig. 8.1 Simplified flow scheme of incinerator

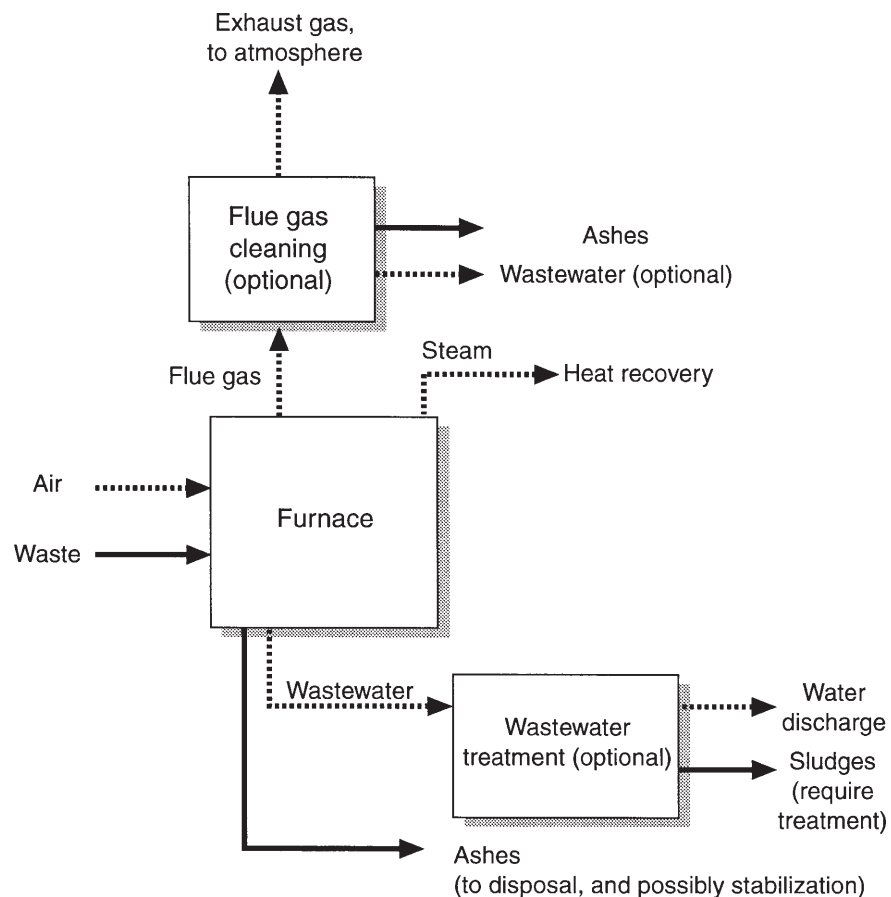

An input of appropriate fuel may overcome a slightly deficient heating value or a slightly excessive moisture content.

Incineration requires no pretreatment, provided that certain waste types are not included in the matter to be incinerated. Wastes that should not be incinerated are listed in Box 8.2.

Types of incinerator

Incinerators can range from extremely sophisticated, high-temperature operating plants to very basic combustion units that operate at much lower temperatures. All types of incinerator, if operated properly, eliminate pathogens from waste and reduce the waste to ashes. However, certain types of health-care wastes, e.g. pharmaceutical or chemical wastes, require higher temperatures for complete destruction. Higher operating temperatures and cleaning of exhaust gases limit the atmospheric pollution and odours produced by the incineration process.

Incineration equipment should be carefully chosen on the basis of the available resources and the local situation, and of risk–benefit considerations—balancing the public health benefits of pathogen elimination

Box 8.1 Characteristics of waste suitable for incineration

- Low heating value: above 2000kcal/kg (8370kJ/kg) for single-chamber incinerators, and above 3500kcal/kg (14640kJ/kg) for pyrolytic double-chamber incinerators.
- Content of combustible matter above 60%.
- Content of non-combustible solids below 5%.
- Content of non-combustible fines below 20%.
- Moisture content below 30%.

Box 8.2 Waste types not to be incinerated

- Pressurized gas containers.
- Large amounts of reactive chemical waste.
- Silver salts and photographic or radiographic wastes.
- Halogenated plastics such as polyvinyl chloride (PVC).
- Waste with high mercury or cadmium content, such as broken thermometers, used batteries, and lead-lined wooden panels.
- Sealed ampoules or ampoules containing heavy metals.

before waste disposal against the potential risks of air or groundwater pollution caused by inadequate destruction of certain wastes.

Three basic kinds of incineration technology are of interest for treating health-care waste:

- double-chamber pyrolytic incinerators, which may be especially designed to burn infectious health-care waste;
- single-chamber furnaces with static grate, which should be used only if pyrolytic incinerators are not affordable;
- rotary kilns operating at high temperature, capable of causing decomposition of genotoxic substances and heat-resistant chemicals.

Incinerators designed especially for treatment of health-care waste should operate at temperatures between 900 and 1200°C. Low-cost, high-temperature incinerators of simple design are currently being developed, and a system designed specifically for health-care and pharmaceutical waste in low-income countries is currently under test in England, at De Montfort University.

Mobile incinerators for health-care waste have been tested in Brazil. These units permit on-site treatment in hospitals and clinics, thus avoiding the need to transport infectious waste through city streets. Test results for units with a capacity of 30 kg/hour were satisfactory in terms of function, performance, and air pollution (Bartone, 1998).

High-temperature incineration of chemical and pharmaceutical waste in industrial cement or steel kilns is practised in many countries and is a valuable option; no additional investments are required and industry benefits from a supply of free combustible matter.

Assessment of waste parameters

Specific waste parameters should be assessed at the planning stage to determine the most suitable type and size of incinerator:

- current extent of waste production and types of health-care waste;
- estimated future waste production;
- production of incinerable waste per day (and per bed per day);
- all the physical parameters that determine the suitability of waste for incineration, such as low heating value and moisture content (see Box 8.1).

8.1.2 Pyrolytic incinerators

Technology

The most reliable and commonly used treatment process for health-care waste is pyrolytic incineration, also called controlled air incineration or double-chamber incineration. The main characteristics of pyrolytic incinerators, which may be especially designed for hospitals, are summarized in Box 8.3.

The pyrolytic incinerator comprises a pyrolytic chamber and a post-combustion chamber and functions as follows:

- In the pyrolytic chamber, the waste is thermally decomposed through an oxygen-deficient, medium-temperature combustion process (800–900°C), producing solid ashes and gases. The pyrolytic chamber

Box 8.3 Characteristics of pyrolytic incinerators

Adequate for the following waste categories:

- *Infectious waste (including sharps) and pathological waste*
— efficient treatment; elimination of all pathogens.
- *Pharmaceutical and chemical residues*
— causes disintegration of most residues; however, only small amounts (e.g. 5% of total waste load) of these wastes should be incinerated in this process.

The low heating value of the wastes should exceed 3500kcal/kg (14650kJ/kg).

Inadequate for the following wastes:

- *Non-risk health-care waste similar to urban waste*
— pyrolytic incineration would waste resources.
- *Genotoxic waste*
— treatment probably not efficient.
- *Radioactive waste*
— treatment does not affect radioactive properties and may disperse radiation.

Wastes that should not be incinerated:

- *Pressurized containers*
— may explode during incineration and cause damage to the equipment.
- *Halogenated plastics such as PVC*
— exhaust gases may contain hydrochloric acids and dioxins.
- *Wastes with high heavy-metal content*
— incineration will cause emission of toxic metals (e.g. lead, cadmium, mercury) into the atmosphere.

Incineration temperature: 800–900°C.

Incinerator capacity: Available capacities range from 200kg/day to 10 tonnes/day. Hospitals are usually equipped with incinerators with a capacity of less than 1 tonne/day.

Exhaust-gas cleaning equipment: Needed for larger facilities.

Additional remarks: The equipment is relatively expensive to purchase, and expensive to operate and maintain. Well trained personnel are required.

includes a fuel burner, used to start the process. The waste is loaded in suitable waste bags or containers.

- The gases produced in this way are burned at high temperature (900–1200°C) by a fuel burner in the post-combustion chamber, using an excess of air to minimize smoke and odours.

Larger pyrolytic incinerators (capacity 1–8 tonnes/day) are usually designed to function on a continuous basis. They may also be capable of fully automatic operation, including loading of waste, removal of ashes, and internal movement of burning waste.

Adequately maintained and operated pyrolytic incinerators of limited size, as commonly used in hospitals, do not require exhaust-gas cleaning equipment. Their ashes will contain less than 1% unburnt material,

which can be disposed of in landfills. However, to avoid dioxin production, no chlorinated plastic bags (and preferably no other chlorinated compounds) should be introduced into the incinerator, and should therefore not be used for packaging waste before its incineration.

Design and size of a pyrolytic incinerator

Optimal combustion conditions are essential if there is to be almost complete destruction of wastes without the generation of significant amounts of harmful solid, liquid, or gaseous outputs (e.g. dioxins, furans). The burning temperature, waste residence time inside the furnace, gas turbulence, and size of airflow inputs are therefore critical, and the incinerator should fulfil the following criteria:

- The temperature in the post-combustion chamber should reach at least 900°C, and gas residence time should be at least 2 seconds; air inflow with 100% excess oxygen and high turbulence should be ensured.
- The pyrolytic chamber should be of sufficient size to allow a residence time for the waste of 1 hour. It should contain baffles or dampers to increase the mixing of waste with the air inflow.
- The pyrolytic and post-combustion chambers should be of steel with an internal lining of refractory bricks, resistant to corrosive waste or gas and to thermal shock.
- The feed opening should be large enough to allow the loading of packed waste. The size of the ash removal opening should be appropriate for the expected percentage of incombustibles in the waste. There should be provision for accumulated ashes to cool down before disposal.
- The incinerator should be operated, monitored, and regulated from a central console, which should include a continuous display of operating parameters and conditions (temperature, airflow, fuel flow, etc.).

A computerized facility for programming automatic operation is very useful—but not essential—for maintaining good operating conditions, in particular when the heating value varies widely as may be the case for health-care waste.

Operation and maintenance of pyrolytic incinerators

The pyrolytic incinerator should be operated and monitored by a well trained technician who can maintain the required conditions, controlling the system manually if necessary. Correct operation is essential, not only to maximize treatment efficiency and minimize the environmental impact of emissions, but also to reduce maintenance costs and extend the life expectancy of the equipment. A careful operational balance needs to be maintained between the two combustion chambers. If this is not done, the following are the likely consequences:

- Too rapid combustion of waste will increase the flow of gas and decrease its residence time to below the minimum desired period of 2 seconds. This may result in partial, rather than complete, combustion of the gases and an increase in the soot and slag produced, which may clog the system and lead to major maintenance problems.
- If the pyrolytic combustion of waste is too slow, the flow speed of gases in the post-combustion chamber will be reduced. This may reduce air pollution, but will result in lower incinerating capacity and higher fuel consumption.

Fuel consumption of pyrolytic incinerators is between 0.03 and 0.08 kg of fuel-oil per kg of waste, or between 0.04 and 0.1 m³ of gas fuel per kg of waste.

Periodic maintenance includes cleaning of the combustion chambers and declogging of air inflows and fuel burners, when necessary. Operators in charge of loading waste and removing ashes should wear protective equipment—masks, gloves, safety glasses, overalls, and safety shoes.

On-site and off-site facilities

The choice of on-site (i.e. at the hospital) or off-site (at a central location) incineration facilities should be in line with the national planning policies discussed in section 5.3. Only technical parameters are described here.

Small-scale incinerators used in hospitals, of capacity 200–1000 kg/day, are operated on demand. They are manually loaded and de-ashed daily or every 2–3 days; a shovel or a vacuum cleaner should be used to remove the ashes. The combustion process is under automatic control and the services of an operator are therefore required for only part of a working day (e.g. 2 hours). The various activities involved in operating this type of incineration unit are summarized in Box 8.4.

Off-site regional facilities will have large-scale incinerators of capacity 1–8 tonnes/day, operating continuously and equipped with automatic loading and de-ashing devices. Incinerators of this size would benefit from energy-recovery systems—at least for preheating of the waste to be incinerated—and exhaust-gas cleaning facilities. It may be possible to use the steam produced to generate electricity. Facilities should also be available for the treatment and final disposal of incineration by-products. Operation and maintenance of a large, centralized, pyrolytic incinerator of capacity 4–8 tonnes/day will require the full-time services of a waste disposal engineer.

Box 8.4 Activities involved in operation of a pyrolytic hospital incinerator

- Removal of ashes left inside the pyrolytic chamber (after cooling down).
- Loading of waste packages to be incinerated.
- Ignition of fuel burner in post-combustion chamber.
- Ignition of the pyrolytic fuel burner to start waste burning in the pyrolytic chamber.
- Pyrolysis of waste and monitoring of gas production.
- Monitoring high-temperature burning of gas inside post-combustion chamber.
- Stopping the fuel burners after completion of waste and gas burning, and letting the incinerator cool down.

Table 8.1 *Approximate costs of pyrolytic incinerators (Europe, 1996)*

Incinerator equipment	Investment costs (in 1000 US\$) for capacities (tonnes/day) of				
	0.4	1	2	4	8
Without energy recovery or gas cleaning	50	100	120	150	230
With energy recovery but without gas cleaning	100	180	230	340	570
With energy recovery and gas cleaning	300	400	480	600	780

Ideally, large-scale incinerators should be located in industrial areas specially designated for hazardous plants. Such areas have good road access and power and water supplies, and are usually remote from housing. In any case, incinerators must be located at a minimum distance of 500 metres from any human settlement.

Investment and operating costs

Capital costs for pyrolytic incinerators suitable for treating health-care waste vary widely. For illustrative purposes only, approximate costs of equipment available on the European market in 1996 are given in Table 8.1.

In Europe, operating and maintenance costs for a small-scale hospital pyrolytic incinerator may reach about US\$ 380 per tonne of waste incinerated.

8.1.3 Rotary kilns

A rotary kiln, which comprises a rotating oven and a post-combustion chamber, may be specifically used to burn chemical wastes, and is also suited for use as a regional health-care waste incinerator. The main characteristics of rotary kilns are summarized in Box 8.5.

The axis of a rotary kiln is inclined at a slight angle to the vertical (3–5% slope). The kiln rotates 2 to 5 times per minute and is charged with waste at the top. Ashes are evacuated at the bottom end of the kiln. The gases produced in the kiln are heated to high temperatures to burn off gaseous organic compounds in the post-combustion chamber and typically have a residence time of 2 seconds.

Rotary kilns may operate continuously and are adaptable to a wide range of loading devices. Those designed to treat toxic wastes should preferably be operated by specialist waste disposal agencies and should be located in industrial areas or “parks”.

8.1.4 Incineration in municipal incinerators

It is economically attractive to dispose of infectious health-care waste in municipal incinerators if these are located reasonably close to hospitals. As the heating value of health-care waste is significantly higher than that of domestic refuse, the introduction of relatively small quantities of health-care waste will not affect the operation of a municipal incinerator. Municipal incinerators are usually of a double-chamber design, with an operating temperature of 800°C in the first combustion chamber and gas combustion in the second chamber at temperatures of, typically, 1000–1200°C.

Box 8.5 Characteristics of rotary kilns

Adequate for the following waste categories:

- *Infectious waste (including sharps) and pathological waste.*
- *All chemical and pharmaceutical wastes, including cytotoxic waste.*

Inadequate for the following wastes:

- *Non-risk health-care waste*
 - incineration in rotary kilns would represent a waste of resources.
- *Radioactive waste*
 - treatment does not affect radioactive properties and may disperse radiation.

Wastes that should not be incinerated:

- *Pressurized containers*
 - may explode during incineration and cause damage to the equipment.
- *Wastes with high heavy-metal content*
 - incineration will cause emission of toxic metals (e.g. lead, cadmium, mercury) into the atmosphere.

Incineration temperature: 1200–1600°C, which allows decomposition of very persistent chemicals such as PCBs (polychlorobiphenyls).

Incinerator capacity: Available capacities range from 0.5 to 3 tonnes/hour.

Exhaust-gas cleaning and ash treatment equipment: Likely to be needed, as the incineration of chemical waste produces exhaust gases and ashes that may be loaded with toxic chemicals.

Additional remarks: Equipment and operation costs are high, as is energy consumption. Wastes and incineration by-products are highly corrosive, and the refractory lining of the kiln often has to be repaired or replaced. Well trained personnel are required.

A number of rules and recommendations apply to the disposal of health-care wastes in municipal facilities:

- When health-care waste is delivered to the incineration plant, the packaging should be checked to ensure that it is undamaged.
- Health-care waste should not be packed in cylindrical containers, because these could roll on the grids where they are placed for combustion.
- Facilities should be available at the incineration site for the cleaning and disinfection of transportation equipment, including vehicles.
- Deposit of health-care waste in the normal reception bunker is not recommended: there is a risk of waste bags being damaged during transfer to the furnace by the overhead crane. Health-care waste should therefore be loaded directly into the furnace.
- Use of an automatic loading device for bags and containers of health-care waste, rather than manual loading, would protect the safety of workers.
- Health-care waste should not be stored for more than 24 hours at an incineration plant; longer storage would require cooling facilities

to prevent the growth of certain pathogens and the development of odours.

- The combustion efficiency should be checked. It should be at least 97% during incineration of health-care waste.
- Health-care waste should be introduced into the furnace only when the normal conditions of combustion have been established—never during start-up or shutdown of the combustion process.
- The process should be designed to prevent contamination of ashes or wastewater by the health-care waste.

Wastes that should *not* be incinerated are the same as those listed for pyrolytic incinerators (section 8.1.2).

8.1.5 Incineration options that meet minimum requirements

Single-chamber incinerator

If a pyrolytic incinerator cannot be afforded, health-care waste may be incinerated in a static-grate, single-chamber incinerator with the characteristics summarized in Box 8.6. This type of incinerator treats waste in batches; loading and de-ashing operations are performed manually. The combustion is initiated by addition of fuel and should then continue unaided. Air inflow is usually based on natural ventilation from the oven mouth to the chimney; if this is inadequate, however, it may be assisted by mechanical ventilation. Regular removal of soot and slags is essential.

Atmospheric emissions will usually include acid gases such as sulfur dioxide, hydrogen chloride, and hydrogen fluoride, black smoke, fly ash (particulates), carbon monoxide, nitrogen oxide, heavy metals, and volatile organic chemicals. To limit these emissions, the incinerator should be properly operated and carefully maintained, and sources of pollution should be excluded from the waste to be incinerated whenever possible.

The different types of single-chamber incinerators range from the simple to the sophisticated. Different types of simple design are illustrated in Figs 8.2 and 8.3; the Bailleul single-chamber incinerator shown in Fig. 8.4 can be used as a guideline for design.

Drum incinerator and brick incinerator

A “drum” or “field” incinerator is the simplest form of single-chamber incinerator. It should be used only as a last resort as it is difficult to burn the waste completely without generating potentially harmful smoke. The option is appropriate only in emergency situations during acute outbreaks of communicable diseases and should be used only for infectious waste.

The drum incinerator should be designed to allow the intake of sufficient air and the addition of adequate quantities of fuel—essential to keep the temperature as high as possible. A 210-litre (55 US gallon) steel drum should be used, with both ends removed; this will allow the burning of one bag of waste at a time (see Fig. 8.5). A fine screen placed on the top of the drum will prevent some of the ash or light material from blowing out. Another screen or fine grate should be placed under the drum, and a chimney may also be fitted (Fig. 8.6). This type of incinerator can also be fabricated from sheet metal or clay.

To operate the drum incinerator, a good fire should first be established on the ground underneath it. One bag of waste should then be lowered into

Box 8.6 Characteristics of single-chamber incinerators

Adequate for the following waste categories:

- Infectious waste (including sharps) and pathological waste. Pathogens are eliminated if the incinerator is correctly operated. Ashes should contain <3% unburnt matter.
- General health-care waste (similar to domestic refuse). This type of waste may be incinerated, particularly if the low heating value exceeds 4000 kcal/kg (16740 kJ/kg).

Inadequate for the following wastes:

- Pharmaceutical and chemical residues. The process is of limited suitability for these wastes and is not generally recommended; exhaust gases may contain toxic substances, such as dioxins. For safety reasons, therefore, large quantities of these wastes should not be introduced into this type of incinerator.
- Genotoxic waste. Treatment by this means is not efficient.
- Radioactive waste. This type of treatment has no effect on radioactive properties and may actually cause dispersal of radioactivity.
- Inorganic compounds and thermally resistant waste.

Waste that should not be incinerated:

- Pressurized containers. Explosion may occur and cause damage to the equipment.
- Halogenated plastics (e.g. PVC). Exhaust gases contain hydrogen chloride and may contain dioxins.
- Wastes with high content of heavy metals (e.g. thermometers, batteries). Incineration will cause emission of toxic metals (e.g. lead, cadmium, mercury) into the atmosphere.

Incineration temperature: 300–400 °C.

Incinerator capacity: 100–200 kg/day.

Exhaust gas cleaning: Not usually practicable; this type of incinerator should therefore not be installed where air pollution is already a problem.

the drum. Tying the bag to a stick with string will help to avoid burns. Wood should be added to the fire until the waste is completely burned. After burning is complete, the ashes from both the fire and the waste itself should be collected and buried safely inside the premises of health-care facilities (see section 8.5.3).

A “brick incinerator”, for use in similar circumstances, may be built by constructing a closed area with brick or concrete walls.

The efficiency of this type of incinerator may reach 80–90% and result in destruction of 99% of microorganisms and a dramatic reduction in the volume and weight of waste. However, many chemical and pharmaceutical residues will persist if temperatures do not exceed 200 °C. In addition, the process will cause massive emission of black smoke, fly ash, and potentially toxic gases.

Fig. 8.2 Apparatus for controlled burning



Fig. 8.3 Single-chamber incinerator



8.1.6 Environmental control technology for incinerators

General principles

Incinerator emissions should comply with the national standards. If the relevant authorities have not established such standards, they may refer to standards in force in Europe or the USA for instance (see Tables 8.2 and 8.3).

Fig. 8.4 Bailleul single-chamber incinerator^a

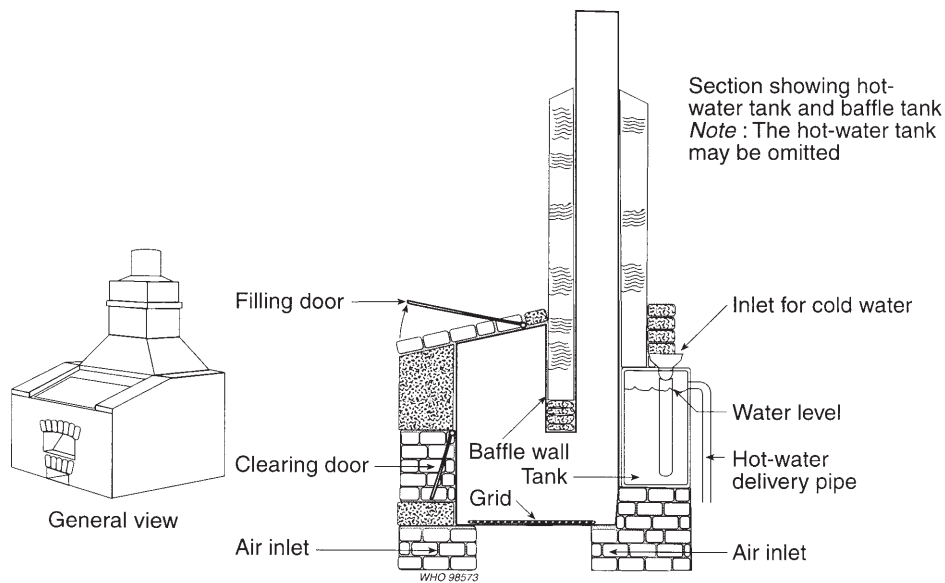

^a Source: Christen (1996), used with permission.

Fig. 8.5 Drum incinerator^a

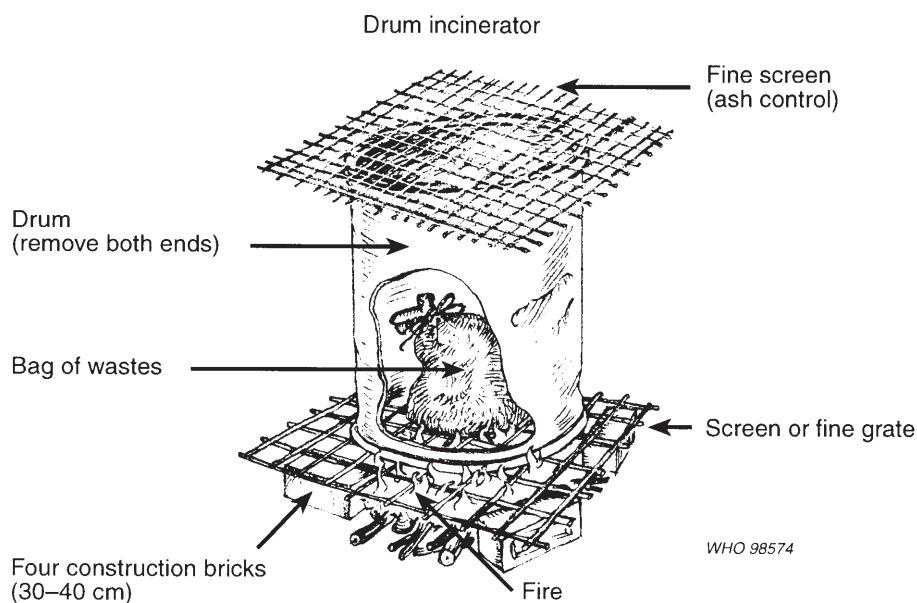

^a Source: Dunsmore (1986).

Flue (exhaust) gases from incinerators contain fly ash (particulates), composed of heavy metals, dioxins, furans, thermally resistant organic compounds, etc., and gases such as oxides of nitrogen, sulfur, and carbon, and hydrogen halides. If flue gases are to be treated, this must be done in at least two different stages—“de-dusting”, to remove most of the fly ash, followed by washing with alkaline substances to remove hydrogen

Fig. 8.6 Drum incinerator with chimney



halides and sulfur oxides. These treatments are briefly described below. Catalytic oxidation of carbon monoxide and reduction of nitrogen oxides are not common procedures; optimal adjustment of the combustion conditions is the best means of keeping production of these gases to a minimum.

Wastewater from gas washing and quenching of ashes should undergo a chemical neutralization treatment before being discharged into a sewer; the treatment includes neutralization of acids and flocculation and precipitation of insoluble salts. Sludges from wastewater treatment and from cooling of fly ash should be considered as hazardous waste. They may either be evacuated to a waste disposal facility for hazardous chemicals, or be treated on-site by drying followed by encapsulation in drums which are then filled up with cement mortar and may be disposed of in a landfill. The encapsulation process prevents the rapid leakage of chemicals.

The solid ashes in the incineration residue are far less hazardous than fly ash, and in the past have been reused in civil engineering works. Recently, however, growing concern about potential leakage of toxic substances from these ashes and subsequent pollution of groundwaters has led a number of countries to insist that the ashes are disposed of in landfills designed specifically for potentially hazardous substances.

Table 8.2 *Emission guidelines for “hospital/medical/infectious waste” incinerators^a*

Note: These standards and guidelines also establish requirements for operator training/qualification, waste management plans, and testing/monitoring of pollutants and operating parameters. The standards for new incinerators also include siting requirements.

Pollutant	Small incinerator (≤91 kg/hour)	Medium incinerator (>91–227 kg/hour)	Large incinerator (>227 kg/hour)
<i>A. Emission limits for new incinerators (construction after June 1996)</i>			
Particulate matter	115 mg/m ³	69 mg/m ³	
Carbon monoxide (CO)	40 ppmv	40 ppmv	
Dioxins/furans	125 ng/m ³ total CCD/CDF or 2.3 ng/m ³ TEQ	125 ng/m ³ total CCD/CDF or 2.3 ng/m ³ TEQ	125 ng/m ³ total CCD/CDF or 2.3 ng/m ³ TEQ
Hydrogen chloride (HCl)	100 ppmv or 93% reduction	100 ppmv or 93% reduction	100 ppmv or 93% reduction
Sulfur dioxide (SO ₂)	55 ppmv	55 ppmv	55 ppmv
Nitrogen oxides	250 ppmv	250 ppmv	250 ppmv
Lead	1.2 mg/m ³ or 70% reduction	1.2 mg/m ³ or 70% reduction	1.2 mg/m ³ or 70% reduction
Cadmium	0.16 mg/m ³ or 65% reduction	0.16 mg/m ³ or 65% reduction	0.16 mg/m ³ or 65% reduction
Mercury	0.55 mg/m ³ or 85% reduction	0.55 mg/m ³ or 85% reduction	0.55 mg/m ³ or 85% reduction
<i>B. Emission limits for existing incinerators (construction started before June 1996)</i>			
Particulate matter	115 mg/m ³	69 mg/m ³	34 mg/m ³
Carbon monoxide (CO)	40 ppmv	40 ppmv	40 ppmv
Dioxins/furans	125 ng/m ³ total CCD/CDF or 2.3 ng/m ³ TEQ	125 ng/m ³ total CCD/CDF or 2.3 ng/m ³ TEQ	125 ng/m ³ total CCD/CDF or 2.3 ng/m ³ TEQ
Hydrogen chloride (HCl)	100 ppmv or 93% reduction	100 ppmv or 93% reduction	100 ppmv or 93% reduction
Sulfur dioxide (SO ₂)	55 ppmv	55 ppmv	55 ppmv
Nitrogen oxides	250 ppmv	250 ppmv	250 ppmv
Lead	1.2 mg/m ³ or 70% reduction	1.2 mg/m ³ or 70% reduction	1.2 mg/m ³ or 70% reduction
Cadmium	0.16 mg/m ³ or 65% reduction	0.16 mg/m ³ or 65% reduction	0.16 mg/m ³ or 65% reduction
Mercury	0.55 mg/m ³ or 85% reduction	0.55 mg/m ³ or 85% reduction	0.55 mg/m ³ or 85% reduction
<i>C. Emission limits for existing incinerators that meet rural criteria, i.e. at a certain distance from metropolitan areas and incinerating less than 908 kg/week (construction started before June 1996)</i>			
Particulate matter		197 mg/m ³	
Carbon monoxide (CO)		40 ppmv	
Dioxins/furans		800 ng/m ³ total CDD/CDF or 15 ng/m ³ TEQ	
Hydrogen chloride (HCl)		3100 ppmv	
Sulfur dioxide (SO ₂)		55 ppmv	
Nitrogen oxides		250 ppmv	
Lead		10 mg/m ³	
Cadmium		4 mg/m ³	
Mercury		7.5 mg/m ³	

^aAdapted from: Environmental Protection Agency (1997). Standards of performance for new stationary sources and emission guidelines for existing sources: hospital/medical/infectious waste incinerators; final rule. *Federal register*, 62(178).

ppmv = parts per million in volume.

CDD = polychlorinated dibenzo-*p*-dioxins.

CDF = polychlorinated dibenzofurans.

TEQ = 2,3,7,8-tetrachlorinated dibenzo-*p*-dioxin toxic equivalent based on the 1989 international toxic equivalency factors.

Table 8.3 *Standards for incinerator emissions in the European Union*

Emission	Daily average (mg/m ³) ^a	Hourly average (mg/m ³) ^a	4-hour average (mg/m ³) ^a
Total dust	5	10	—
Total organic carbon	5	10	—
Chlorine compounds	5	10	—
Fluorine compounds	1	2	—
Sulfur oxides as SO ₂	25	50	—
Nitrogen oxides as NO ₂	100	200	—
Carbon monoxide	50	100	—
Mercury	—	—	0.05
Cadmium and thallium	—	—	0.05
Lead, chromium, copper, and manganese	—	—	0.5
Nickel and arsenic	—	—	0.5
Antimony, cobalt, vanadium, and tin	—	—	0.5
Dioxins and furans	—	—	0.1
Oxygen content	at least 6% at any moment		

^aMeasurements made at standard temperature and pressure.

After de-dusting and acid neutralization, flue gases are emitted through the incinerator stack, the design of which should comply with national regulations. In France, for example, regulations require that the stack design ensures a minimum gas exit speed of 12 m/s.

Dust removal

The design of flue-gas cleaning facilities assumes normal operation of the incinerator, especially as regards temperature and air inputs. The facilities are not designed to cope with the consequences of poor operation, such as massive production of soot and/or slag.

Flue gas emerges from the post-combustion chamber at about 800°C and must be cooled to 300°C before entering the dust-removal equipment. This is usually achieved in cooling towers, called quenching towers or baths, where the gas is cooled by water circulating in a closed system. (The water may subsequently be used for preheating of waste or for other purposes.) Cooling of the flue gas may also be effected by the introduction of fresh air, although this method is less efficient.

Incineration produces between 25 and 30 kg of dust per tonne of waste; an incinerator of x tonnes/day capacity should therefore be equipped with dust-removal equipment that can deal with $30x$ kg/day of dust.

The most common types of dust-removal equipment used in incinerator plants are briefly described in the following paragraphs.

Cyclonic scrubbers are static devices in which gases circulate in spiral movements, and centrifugal forces separate the particulate matter. Efficiency in removing very small particulate matter (diameter <15 μm) is low, and cyclonic scrubbers therefore provide only a preliminary dust removal; treatment by electrofilter (see below) usually follows. Some improvement in the efficiency of cyclonic scrubbers may be effected by water injection along the axis of the cylinder.

Fabric dust removers, also called *baghouse filters*, are widely used. They are highly efficient, but investment and operating costs are relatively high, and the life of the equipment is limited at high temperatures. The filters are made of jute or synthetic textiles that are relatively resistant to chemical aggression. Flue gas is blown through the filter fabric, which retains the particulate matter. The particulate matter is automatically removed from the bags at intervals, by reverse airflow or by mechanical means.

Electrofilters, also called *electrostatic precipitators*, are highly efficient (efficiency 99% or better) and are extensively used in large municipal incinerators of capacity in excess of 5 tonnes/hour. Operating costs are moderate but initial investment costs high. The flue gas is brought into contact with a series of electrodes at a potential of 1000–6000 volts. Particulate matter becomes electrically charged and is deposited on the electrodes, from which it is removed mechanically.

Removal of acids or alkalis

Three processes—known as wet, semi-wet, and dry—are available for the removal of acids such as hydrofluoric acid (HF), hydrochloric acid (HCl), and sulfuric acid (H₂SO₄). In the *wet process*, gases are washed in a spraying tower with soda or lime solution, which also contributes to gas cooling and to the removal of very small particulates. The alkaline solution is continuously recycled, with occasional replacement of some of the solution. (Acidic spray may be used if flue-gas alkalinity is a problem.) Wastewater generated by the process requires treatment by chemical neutralization, flocculation, and settling of sludges before it is discharged into a sewer. In the *semi-wet process*, a lime suspension is injected into the gas column. Salts generated by the neutralization process have to be removed. In the *dry process*, lime powder is injected into the gas column; again, salts produced during the neutralization have to be removed.

The wet process is the most efficient of these three options, but requires complex treatment of the resultant wastewater.

8.2 Chemical disinfection

8.2.1 Simple chemical disinfection processes

Chemical disinfection, used routinely in health care to kill microorganisms on medical equipment and on floors and walls, is now being extended to the treatment of health-care waste. Chemicals are added to waste to kill or inactivate the pathogens it contains; this treatment usually results in disinfection rather than sterilization. Chemical disinfection is most suitable for treating liquid waste such as blood, urine, stools, or hospital sewage. However, solid—and even highly hazardous—health-care wastes, including microbiological cultures, sharps, etc., may also be disinfected chemically, with the following limitations:

- Shredding and/or milling of waste is usually necessary before disinfection; the shredder is often the weak point in the treatment chain, being subject to frequent mechanical failure or breakdown.
- Powerful disinfectants are required, which are themselves also hazardous and should be used only by well trained and adequately protected personnel.
- Disinfection efficiency depends on operational conditions.
- Only the surface of intact solid waste will be disinfected.

Human body parts and animal carcasses should not normally be disinfected chemically. If alternative facilities for disposal are not readily available, however, they may be shredded and then subjected to chemical disinfection. In planning the use of chemical disinfection, requirements for the eventual disposal of the residues should be carefully considered; improper disposal could give rise to serious environmental problems.

Microbial resistance to disinfectants has been investigated and it is possible to list the major groups of microorganisms from most to least resistant as follows: bacterial spores—mycobacteria—hydrophilic viruses—lipophilic viruses—vegetative fungi and fungal spores—vegetative bacteria. A disinfectant known to be effective against a particular group of microorganisms will also be effective against all the groups that are less resistant. Most parasites, such as *Giardia* and *Cryptosporidium* spp., are significantly resistant to disinfection and are usually rated between the mycobacteria and the viruses.

The effectiveness of disinfection is estimated from the survival rates of indicator organisms in standard microbiological tests.

At present, chemical disinfection of health-care waste is limited in industrialized countries. However, it is an attractive option for developing countries, particularly for treating highly infectious physiological fluids, such as patients' stools in case of cholera outbreaks.

Chemical disinfection is usually carried out on hospital premises. Recently, however, commercial, self-contained, and fully automatic systems have been developed for health-care waste treatment and are being operated in industrial zones. The disinfected waste may be disposed of as non-risk health-care waste, but the chemical disinfectants may create serious environmental problems in case of leakage or after disposal.

Chemical disinfection of hospital sewage requires less powerful—and less hazardous—chemicals, and is discussed further in Chapter 10.

Operational considerations

The speed and efficiency of chemical disinfection will depend on operational conditions, including the following:

- the kind of chemical used;
- the amount of chemical used;
- the contact time between disinfectant and waste;
- the extent of contact between disinfectant and waste;
- the organic load of the waste;
- operating temperature, humidity, pH, etc.

Shredding of waste before disinfection

Shredding of solid health-care waste before disinfection is essential for the following reasons:

- to increase the extent of contact between waste and disinfectant by increasing the surface area and eliminating any enclosed spaces;
- to render any body parts unrecognizable to avoid any adverse visual impact on disposal;
- to reduce the volume of waste.

Water is usually added during shredding; it prevents excessive warming and facilitates subsequent contact with the disinfectant. Excess water may have to be treated, e.g. by chemical disinfection.

Rotating-blade shredders are used most commonly, and consist of blades attached to two wheels that rotate in opposite directions. The presence of an excessive proportion of sharps in waste may cause deterioration of the shredder.

Shredding of waste before disinfection plus subsequent compacting can reduce the original waste volume by 60–90%.

Types of chemical disinfectants

The aim of disinfection is to eliminate microorganisms or at least reduce their numbers to a “satisfactory” level. Some disinfectants are effective in killing or inactivating specific types of microorganisms and others are effective against all types. It is therefore essential to know the identity of the target microorganisms to be destroyed. However, selection of disinfectants depends not only on their effectiveness, but also on their corrosiveness and other hazards related to their handling. More comprehensive information on disinfectants is provided in Chapter 14 (section 14.3.5).

The types of chemicals used for disinfection of health-care waste are mostly aldehydes, chlorine compounds, ammonium salts, and phenolic compounds; the characteristics of those most commonly used for waste applications are outlined in Boxes 8.7 to 8.11. The use of ethylene oxide is no longer recommended for waste treatment because of the significant hazards related to its handling. However, it has been used in the past and may still be in use in some places, and its characteristics are therefore outlined in Box 8.8 for the sake of completeness.

The use of ozone (O₃) for disinfection of waste is currently being investigated. This disinfectant is strong and relatively safe. The process would be similar to the wet thermal process, described in section 8.3.

Most of the disinfectants described here are stable for at least 5 years and—with the exception of sodium hypochlorite—remain effective for 6–12 months after opening of the container.

Powerful disinfectants are often hazardous and toxic; many are harmful to skin and mucous membranes. Users should therefore wear protective clothes, including gloves and protective eye glasses or goggles. Disinfectants are also aggressive to certain building materials and should be handled and stored accordingly.

Small amounts of disinfectants can be discharged into sewers without pretreatment, provided that there is an adequate sewage-treatment process; large amounts of disinfectants should never be discharged into sewers. No disinfectants should be discharged into natural water bodies.

Chemical disinfection costs and equipment

For the disinfection of waste, capital investment costs are in the range US\$ 50 000–100 000; operating costs, which are generally in the range US\$ 100–120 per tonne, are heavily dependent on the price of chemical disinfectants, which may vary from country to country. Where relatively cheap chemical disinfectants are easily available on the local market,

Box 8.7 Characteristics of formaldehyde (HCHO) as a chemical disinfectant

Application

Inactivating effect against all microorganisms, including bacteria, viruses, and bacterial spores; may be applied to dry, solid waste, in combination with steam at 80°C. Contact time: 45 minutes.

Physical and chemical properties

Gas at ambient temperature; flammable and explosive in mixtures with air at concentrations of 7–73%; reactive at ambient temperature; polymerizes at temperatures below 80°C. Formalin is a 37% solution of formaldehyde. Formaldehyde odour threshold: 0.1–1 ppm.

Health hazards

WHO guideline value for the general public: 0.1 ppm. WHO guideline value for occupational exposure: 1 ppm for 5 minutes, with no more than 8 peaks in one working period (of up to 8 hours). Irritant effects may be experienced at concentrations of 1–3 ppm upwards; exposure to concentrations above 10 ppm may result in severe irritation of eyes or respiratory tract. Occupational safety limit: 1 ppm in the USA. Formaldehyde has been classified as a probable human carcinogen by the International Agency for Research on Cancer; all precautions should therefore be taken to avoid inhalation of this compound during handling. NIOSH IDLH: 20 ppm.¹

Protective measures

Gloves and protective eye glasses should be worn during handling of formaldehyde to protect skin and eyes; in case of skin contact, the affected area should be rinsed abundantly with water.

Corrosiveness

Formalin is slightly corrosive to most metals except stainless steel and aluminium; it should be stored in stainless steel, aluminium, or polyethylene containers, in well ventilated, leakage-proof rooms.

Fire

Firefighters should wear breathing masks when tackling fires involving formaldehyde.

Comments

Formaldehyde is suitable for use as a chemical disinfectant only in situations in which a high level of chemical safety can be maintained.

¹National Institute for Occupational Safety and Health/Immediately Dangerous to Life or Health (concentration).

chemical disinfection is an economically attractive treatment option. However, the process is not very popular in developing countries at present, and the choice of equipment is therefore limited. It seems that the best available reacting tanks are of the “Virhoplan” type, incorporating a shredder and designed to operate with ethylene oxide gas.

Box 8.8 Characteristics of ethylene oxide (CH₂OCH₂) as a chemical disinfectant

Application

Inactivating effect against all microorganisms, including bacteria, viruses, and bacterial spores; disinfection of solid waste at temperatures of 37–55 °C, at 60–80% humidity, for 4–12 hours.

Physical and chemical properties

Gas at temperatures above 10 °C; flammable and explosive in mixtures with air at concentrations of 3% and above; very reactive at ambient temperature; soluble in water and most organic solvents. Odour threshold: 320–700 ppm.

Health hazards

Liquid ethylene oxide and aqueous solutions are extremely irritant to skin and eyes; occupational safety limit: 1–5 ppm (depending on the country). Ethylene oxide has been classified as a human carcinogen by the International Agency for Research on Cancer; all precautions should therefore be taken to avoid inhalation of this compound during handling. NIOSH IDLH: 800 ppm.

Protective measures

Gloves and protective eye glasses should be worn during handling of ethylene oxide to protect skin and eyes; in case of skin contact, the affected area should be rinsed abundantly with water; in case of eye contact, the eyes should be rinsed abundantly with water for at least 15 minutes, followed by medical examination; immediate hospital attention is needed in case of inhalation or ingestion; continuous monitoring of ethylene oxide should be performed.

Corrosiveness

Ethylene oxide is corrosive to rubber and plastics but not to metal; it is usually stored in pressurized metal containers, in liquid form, under high-pressure nitrogen gas.

Fire

Ethylene oxide fires are very difficult to stop; in case of fire, gas inflow should be stopped; CO₂ or powder extinguishers should be used; firefighters should wear protective masks.

Comments

The use of ethylene oxide is not recommended because of significant related health hazards.

8.2.2 Commercial treatment systems based on chemical disinfection

Several self-contained waste-treatment systems, based on chemical disinfection, have been developed specifically for health-care waste and are available commercially; some have been officially approved for use in several countries. One such system is described in Box 8.12 but numerous others are commercially available or under development, using various disinfectants. Some of these self-contained treatment systems use disinfectants such as chlorine dioxide, which are not described in section 8.2.1. Certain systems are fully automatic and equipped with air filtration systems; they are thus easy to operate and

Box 8.9 Characteristics of glutaraldehyde (CHO-(CH₂)₃-CHO) as a chemical disinfectant

Application

Active against both bacteria and parasite eggs. Available in 25–50% aqueous solutions; should be used as 2% aqueous solution with acetate buffer. Contact times: 5 minutes for disinfection of medical equipment; 10 hours to kill spores. For waste, operating parameters should be adjusted on the basis of bacteriological tests.

Physical and chemical properties

Liquid; very reactive; non-flammable. Addition of methanol allows for long-term conservation.

Health hazards

Concentrated solutions are irritant to eyes and skin; occupational safety limit depends on the country (e.g. 0.2ppm or 0.7mg/m³ in France).

Protective measures

Gloves and protective eye glasses should be worn during handling of glutaraldehyde to protect skin and eyes; in case of skin contact the affected area should be rinsed abundantly with water; in case of eye contact, the eyes should be rinsed abundantly with water for at least 15 minutes, followed by medical examination.

Corrosiveness

Aqueous solutions of glutaraldehyde are corrosive to most metals; usually stored in stainless steel containers, steel containers lined with phenolic resins, or reinforced polyethylene containers, in well ventilated, leakage-proof rooms.

Comments

Glutaraldehyde is suitable for use as a chemical disinfectant only in situations in which a high level of chemical safety can be maintained. Glutaraldehyde waste should never be discharged in sewers; it may be neutralized through careful addition of ammonia or sodium bisulfite; it may also be incinerated after mixing with a flammable solvent.

have a lesser impact on the environment. They can usually be adapted to a range of capacities. Most of these commercial systems shred the waste, and some combine a thermal process; they may be based on wet or dry chemical disinfection. They are not usually adequate for cytotoxic or chemical waste, but some may treat pathological waste. Waste volume is reduced by about 80%.

8.3 Wet and dry thermal treatment

8.3.1 Wet thermal treatment

Wet thermal—or steam—disinfection is based on exposure of shredded infectious waste to high-temperature, high-pressure steam, and is similar to the autoclave sterilization process. It inactivates most types of microorganisms if temperature and contact time are sufficient; for sporulated bacteria, a minimum temperature of 121°C is needed. About

Box 8.10 Characteristics of sodium hypochlorite (NaOCl) as a chemical disinfectant

Application

Active against most bacteria, viruses, and spores; not effective for disinfection of liquids with high organic content such as blood or stools; widely used for treatment of wastewater. For waste, operating parameters should be adjusted on the basis of bacteriological tests.

Physical and chemical properties

Available as aqueous solution with 2–12% of active chlorine; at ambient temperature slowly decomposes into sodium chlorate, sodium chloride, and oxygen; solutions of low concentration are more stable; solutions should be protected from light which accelerates decomposition; reacts with acids to produce hazardous chlorine gas.

Health hazards

Irritant to skin, eyes, and respiratory tract; toxic.

Protective measures

Gloves and protective eye glasses should be worn during handling of sodium hypochlorite to protect skin and eyes; in case of eye contact, the eyes should be rinsed abundantly with water.

Corrosiveness

Aqueous solutions are corrosive to metals; usually stored in plastic containers in well ventilated, dark, and leakage-proof rooms; should be stored separately from acids.

Comments

Sodium hypochlorite may be widely used because of relatively mild health hazards. Unused solutions should be reduced with sodium bisulfite or sodium thiosulfate and neutralized with acids before discharge into sewers. Large quantities of concentrated solutions should be treated as hazardous chemical waste.

99.99% inactivation of microorganisms may be expected, compared with the 99.9999% achievable with autoclave sterilization.

The wet thermal process requires that waste be shredded before treatment; for sharps, milling or crushing is recommended to increase disinfection efficiency. The process is inappropriate for the treatment of anatomical waste and animal carcasses, and will not efficiently treat chemical or pharmaceutical wastes.

The disadvantages of the wet thermal process are the following:

- the shredder is liable to mechanical failure and breakdown;
- the efficiency of disinfection is very sensitive to the operational conditions.

However, the relatively low investment and operating costs and the low environmental impact are distinct advantages of the wet thermal

Box 8.11 Characteristics of chlorine dioxide (ClO₂) as a chemical disinfectant

Application

Active against most bacteria, viruses, and spores; widely used, for instance in drinking-water preparation, sanitation, and wastewater treatment.

Physical and chemical properties

Reddish-yellow gas at ambient temperature; explosion limit: >10% in air; will react with water or steam to produce corrosive fumes of hydrochloric acid.

Health hazards

Irritant to skin, eyes, and respiratory tract; toxic. NIOSH IDLH: 5 ppm.

Protective measures

In case of eye contact, eyes should be rinsed abundantly with water; contaminated areas of the body should be washed with soap and water.

Corrosiveness

Containers of chlorine dioxide should be stored in well ventilated and leakage-proof rooms.

process, which should be considered when incineration is not practicable. Once disinfected, waste can join the municipal waste collection and disposal mechanism.

Operation and technology

The reacting tank for the wet thermal process may be a horizontal steel cylinder, connected to a steam generator, both of which can withstand a pressure of 6 bar (600 kPa) and a temperature of 160 °C. The system also includes a vacuum pump and an electricity supply. Pressure and temperature are controlled and monitored during the process, and operation of the system may be automated. Wet thermal processes are usually batch systems, but may also be continuous.

At the start of the operation, the waste is shredded and the sharps crushed or milled before being introduced into the tank. Vacuum conditions are established in the tank; this increases the partial pressure of the steam and hence the effectiveness of contact between steam and waste. Superheated steam is then introduced to the tank. A minimal temperature of 121 °C and a pressure usually of 2–5 bar (200–500 kPa) should be maintained during the total contact time of 1–4 hours. Since disinfection efficiency depends upon the extent of contact between the steam and the surface of the waste, the tank should not be overloaded. Optimal operational conditions can be achieved when the waste is finely shredded and does not fill more than half the tank. At the end of the contact time, the reacting tank is cooled down and then emptied and cleaned.

The theoretical contact times needed to achieve disinfection—20 minutes above 121 °C and 2 bar (200 kPa) and 5 minutes above 134 °C and 3.1 bar (310 kPa)—are less than those needed in practice. This is because more

Box 8.12 Self-contained chemical disinfection treatment system^a

After peroxide pretreatment, the waste undergoes shredding and alkaline oxidation by calcium oxide (burnt lime) followed by encapsulation in a siliceous mass. The treated waste is rendered suitable for disposal in landfills without the need for special consideration. The appearance of the processed waste, which is reduced by about 80% in volume, is shown in the photograph.

The process is environmentally friendly and easy to operate.



Infectious waste residues from chemical disinfection by self-contained system

^aPhotograph reproduced with the kind permission of Matrix Technology PTY Ltd, Cairns, Australia.

time may be needed for steam to penetrate certain waste components such as microbiological cultures or hypodermic needles.

The effectiveness of a wet thermal disinfection technique should be routinely checked using the *Bacillus subtilis* or *Bacillus stearothermophilus* tests as outlined in Box 8.13.

The equipment should be operated and maintained by adequately trained technicians; maintenance is required largely for the shredder.

Investment and operating costs

Equipment from many different suppliers is currently available in Europe, North America, and the Pacific region. Investment costs range from US\$ 50 000 to US\$ 200 000 for the full equipment, with tank capacities between 20 litres and 8 m³ and operating temperatures between 120 °C and 160 °C. As an illustration, the cost of wet thermal equipment

Box 8.13 Description of *Bacillus subtilis* and *Bacillus stearothermophilus* tests

- Dried test spores are placed in a thermally resistant and steam-permeable container near the centre of the waste load and the apparatus is operated under normal conditions.
- At the end of the cycle, the test organisms are removed from the load; within 24 hours, test discs or strips should be aseptically inoculated in 5.0ml soybean–casein digest broth medium and incubated for at least 48 hours, at 30°C for *Bacillus subtilis* and at 55°C for *Bacillus stearothermophilus*.
- The media should then be examined for turbidity as a sign of bacterial growth; any growth should be subcultured onto appropriate media to identify the organism either as the test microorganism or as an environmental contaminant.

Fig. 8.7 Off-site wet thermal (or “steam autoclave”) treatment facility

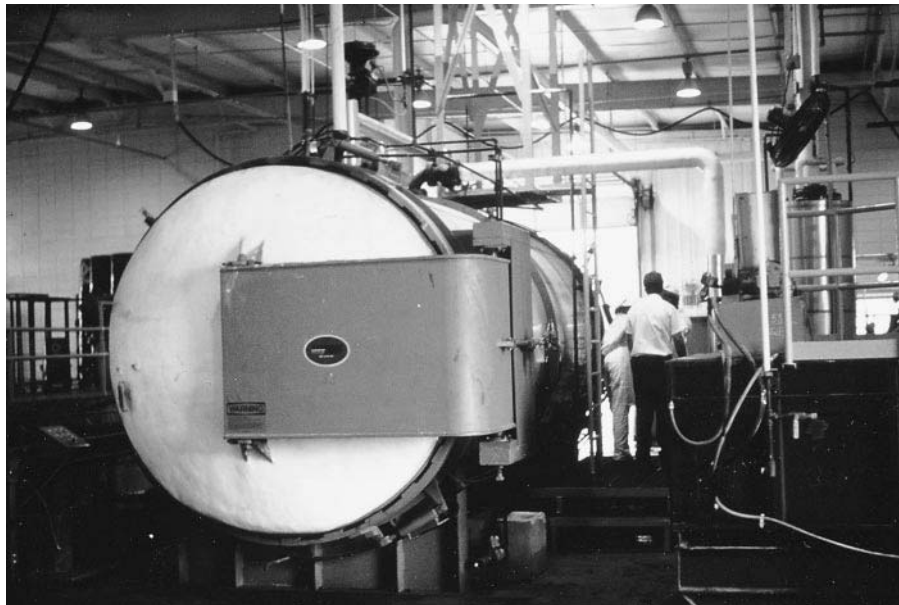

with the capacity to treat 50 tonnes of waste per year is about US\$ 100 000 on the European market; operating costs are about US\$ 400 per tonne of waste (less in developing countries).

Large-scale equipment for off-site treatment

Large-scale wet thermal (or “steam autoclave”) disinfection equipment with reacting tanks of capacities up to 8m³ or more may be used for regional health-care waste treatment facilities. Their technical characteristics are similar to those of small systems, but some operate without shredders. Some systems may also treat anatomical waste (which becomes unrecognizable). An increasing number of health-care waste treat-

ment facilities around the world are using the wet thermal process (see Fig. 8.7).

Recommendations for minimal programmes

Because of the need for regular maintenance of the shredder in most systems, and the requirement to establish vacuum conditions in the exposure tank, which is a delicate operation requiring qualified technicians, the wet thermal process is not particularly recommended for minimal programmes. It should only be considered by hospitals with the necessary technical and financial resources, and in places where single-chamber incineration or bunker burning of waste is not acceptable, for example because of the air pollution problems that may result.

Autoclaving

Autoclaving is an efficient wet thermal disinfection process. Typically, autoclaves are used in hospitals for the sterilization of reusable medical equipment. They allow for the treatment of only limited quantities of waste and are therefore commonly used only for highly infectious waste, such as microbial cultures or sharps. It is recommended that all general hospitals, even those with limited resources, be equipped with autoclaves.

The advantages and disadvantages of autoclaving wastes are the same as for other wet thermal processes discussed in this section. The physical requirements for effective steam autoclave treatment are normally different from those required for sterilizing medical supplies. Minimum contact times and temperatures will depend on several factors such as the moisture content of the waste and ease of penetration of the steam. Research has shown that effective inactivation of all vegetative microorganisms and most bacterial spores in a small amount of waste (about 5–8 kg) requires a 60-minute cycle at 121 °C (minimum) and 1 bar (100 kPa); this allows for full steam penetration of the waste material.

Figure 8.8 shows an on-site steam autoclave for health-care waste treatment

Fig. 8.8 On-site steam autoclave



Fig. 8.9 Schematic plan of a self-contained screw-feed unit^a

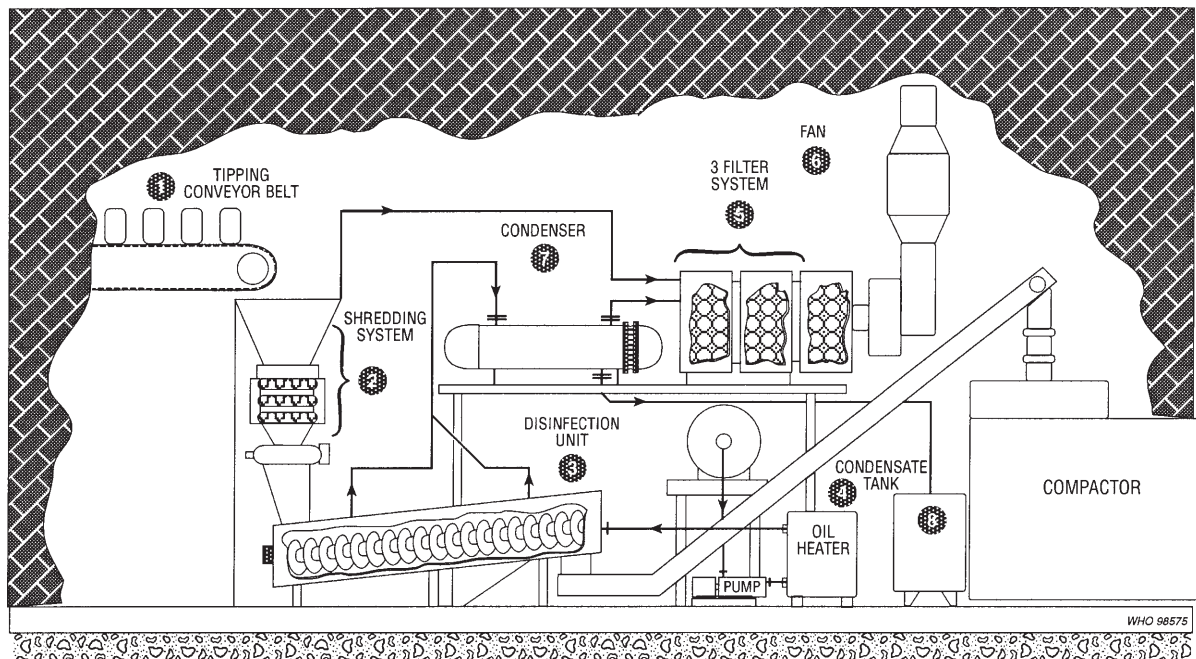

^aReproduced with the kind permission of ScotSafe Ltd, Glasgow, Scotland.

8.3.2 Screw-feed technology

Screw-feed technology is the basis of a non-burn, dry thermal disinfection process in which waste is shredded and heated in a rotating auger. Continuously operated units, also called continuous feed augers, are commercially available and already in use in several hospitals. The principal steps of the process are the following:

- The waste is shredded to particles about 25 mm in diameter.
- The waste enters the auger, which is heated to a temperature of 110–140 °C by oil circulating through its central shaft.
- The waste rotates through the auger for about 20 minutes, after which the residues are compacted.

The waste is reduced by 80% in volume and by 20–35% in weight. This process is suitable for treating infectious waste and sharps, but it should not be used to process pathological, cytotoxic, or radioactive waste. Exhaust air should be filtered, and condensed water generated during the process should be treated before discharge.

A typical self-contained screw-feed unit is shown schematically in Fig. 8.9.

8.4 Microwave irradiation

Most microorganisms are destroyed by the action of microwaves of a frequency of about 2450 MHz and a wavelength of 12.24 cm. The water contained within the wastes is rapidly heated by the microwaves and the infectious components are destroyed by heat conduction.

Fig. 8.10 Microwave treatment unit for health-care waste

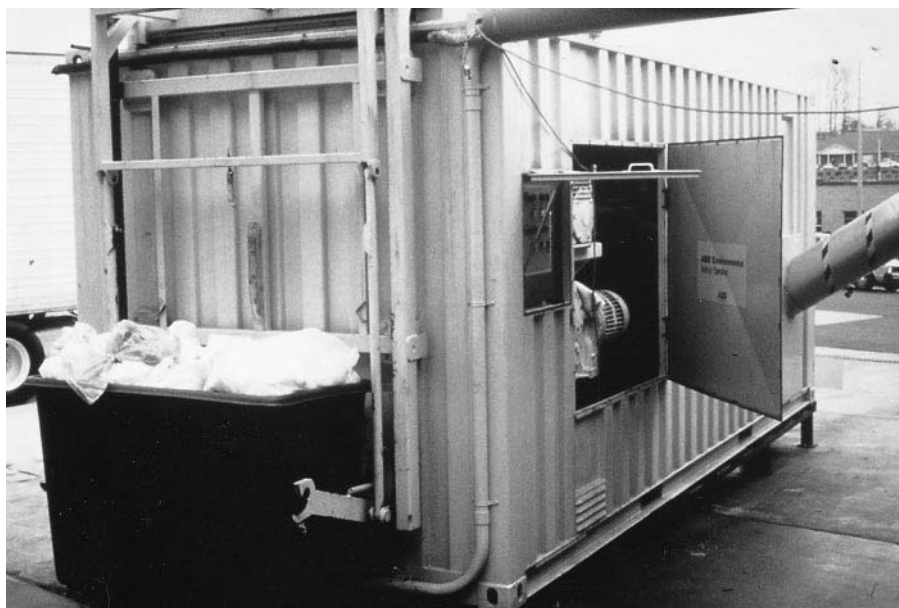

In a microwave treatment unit, a loading device transfers the wastes into a shredder, where it is reduced to small pieces. The waste is then humidified, transferred to the irradiation chamber, which is equipped with a series of microwave generators, and irradiated for about 20 minutes. A typical self-contained microwave system is shown in Fig. 8.10. After irradiation, the waste is compacted inside a container and enters the municipal waste stream.

The efficiency of microwave disinfection should be checked routinely through bacteriological and virological tests. In the USA, a routine bacteriological test using *Bacillus subtilis* is recommended to demonstrate a 99.99% reduction of viable spores. The testing procedure is similar to that described for wet thermal disinfection (see Box 8.13).

The microwave process is widely used in several countries and is becoming increasingly popular. However, relatively high costs coupled with potential operation and maintenance problems mean that it is not yet recommended for use in developing countries. Similar processes using other wavelengths or electron beams are also being developed.

Microwave irradiation equipment with a capacity of 250 kg/hour (3000 tonnes/year), including loading device, shredder, steam humidification tank, irradiation chamber, and microwave generators, plus a waste compactor, may cost about US\$ 0.5 million. More compact systems have recently been developed to treat health-care waste at the point of production. They are of considerably lower capacity, but are much cheaper.

8.5 Land disposal

8.5.1 Municipal disposal sites

If a municipality or medical authority genuinely lacks the means to treat wastes before disposal, the use of a landfill has to be regarded as an

Fig. 8.11 Routes of exposure to hazards caused by open dumping^a

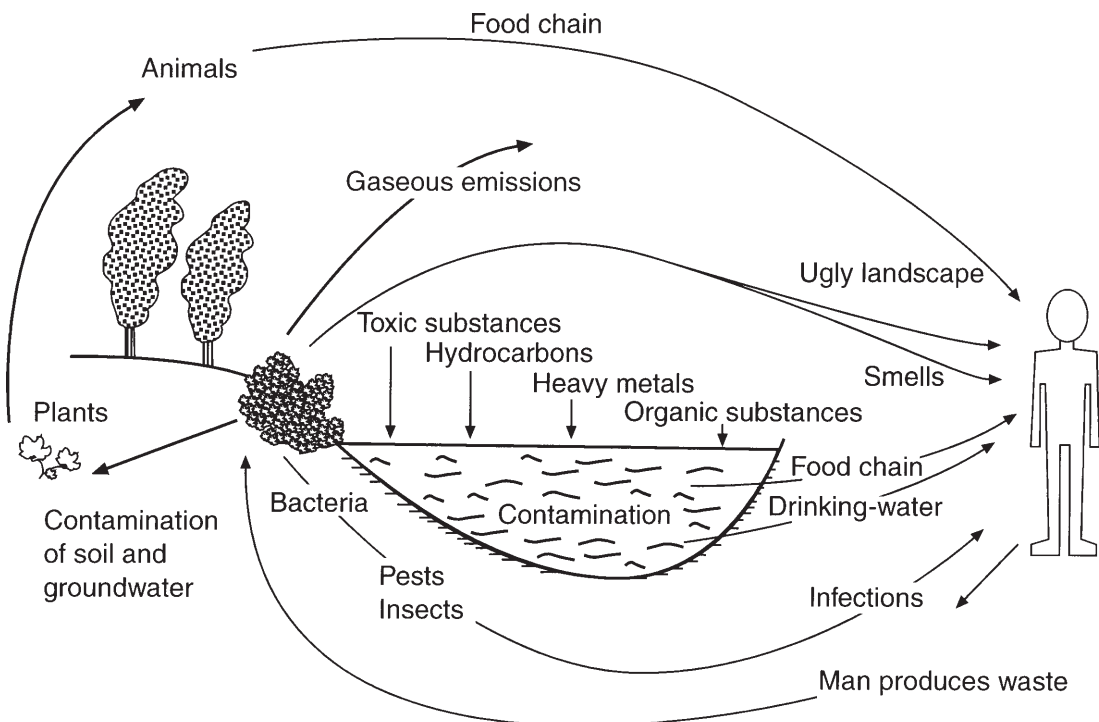

^aSource: Oeltzschner (1996); reproduced with the kind permission of Deutsche Gesellschaft für Technische Zusammenarbeit GmbH.

WHO 986570

acceptable disposal route. Allowing health-care waste to accumulate at hospitals or elsewhere constitutes a far higher risk of the transmission of infection than careful disposal in a municipal landfill, even if the site is not designed to the standard used in higher-income countries. The primary objections to landfill disposal of hazardous health-care waste, especially untreated waste, may be cultural or religious or based on a perceived risk of the release of pathogens to air and water or on the risk of access by scavengers.

There are two distinct types of waste disposal to land—*open dumps* and *sanitary landfills*.

- *Open dumps* are characterized by the uncontrolled and scattered deposit of wastes at a site; this leads to acute pollution problems, fires, higher risks of disease transmission, and open access to scavengers and animals. **Health-care waste should not be deposited on or around open dumps.** The risk of either people or animals coming into contact with infectious pathogens is obvious, with the further risk of subsequent disease transmission, either directly through wounds, inhalation, or ingestion, or indirectly through the food chain or a pathogenic host species (see Fig. 8.11).
- *Sanitary landfills* are designed to have at least four advantages over open dumps: geological isolation of wastes from the environment, appropriate engineering preparations before the site is ready to accept wastes, staff present on site to control operations, and organized deposit and daily coverage of waste. Some of the rules applicable to

Box 8.14 Some essential elements for design and operation of sanitary landfills

- Access to site and working areas possible for waste delivery and site vehicles.
- Presence of site personnel capable of effective control of daily operations.
- Division of the site into manageable phases, appropriately prepared, before landfill starts.
- Adequate sealing of the base and sides of the site to minimize the movement of wastewater (leachate) off the site.
- Adequate mechanisms for leachate collection, and treatment systems if necessary.
- Organized deposit of wastes in a small area, allowing them to be spread, compacted, and covered daily.
- Surface water collection trenches around site boundaries.
- Construction of a final cover to minimize rainwater infiltration when each phase of the landfill is completed.

sanitary landfills are listed in Box 8.14. Disposing of certain types of health-care waste (infectious waste and small quantities of pharmaceutical waste) in sanitary landfills is acceptable; sanitary landfill prevents contamination of soil and of surface water and groundwater, and limits air pollution, smells, and direct contact with the public.

Upgrading from open dumping directly to sophisticated sanitary landfills may be technically and financially difficult for many municipalities. It has often been found impossible to sustain such efforts from the available local resources. However, this is no reason for municipal authorities to abandon the move towards safer land disposal techniques, perhaps by a gradual approach, such as that outlined in Box 8.15.

In the absence of sanitary landfills, any site from a controlled dump upwards could accept health-care waste and avoid any measurable increase in infection risk. The minimal requirements would be the following:

- an established system for rational and organized deposit of wastes which could be used to dispose of health-care wastes;
- some engineering work already completed to prepare the site to retain its wastes more effectively;
- rapid burial of the health-care waste, so that as much human or animal contact as possible is avoided.

It is further recommended that health-care waste be deposited in one of the two following ways:

Box 8.15 Proposed pathway for gradual upgrading of landfills¹

1. **From open dumping to “controlled dumping”.** This involves reduction of the working area of the site to a more manageable size (2ha for a medium-size town), covering unneeded areas of the site with soil, extinguishing fires, and agreeing rules of on-site working with scavengers if they cannot be excluded completely.
2. **From controlled dumping to “engineered landfill”.** This involves the gradual adoption of engineering techniques to prevent surface water from entering the waste, extract and spread soils to cover wastes, gather wastewater (leachate) into lagoons, spread and compact waste into thinner layers, prepare new parts of the landfill with excavation equipment, and isolate the waste from the surrounding geology (e.g. with plastic sheeting under the waste).
3. **From engineered landfill to “sanitary landfill”.** This involves the continuing refinement, with increasing design and construction complexity, of the engineering techniques begun for engineered landfill. In addition, there should be landfill gas control measures, environmental monitoring points and bore holes (for monitoring air and groundwater quality), a highly organized and well trained work force, detailed record-keeping by the site office, and, in some circumstances, on-site treatment of leachate.

¹ Adapted from Rushbrook & Pugh (1997).

- In a shallow hollow excavated in mature municipal waste in the layer below the base of the working face, and immediately covered by a 2-metre layer of fresh municipal waste. Scavenging in this part of the site must be prevented. The same method is often used for hazardous solid industrial wastes; it is specifically intended to prevent animals and scavengers from re-excavating the deposited health-care waste.
- In a deeper (1–2m) pit excavated in mature municipal waste (i.e. waste covered at least 3 months previously). The pit is then backfilled with the mature municipal waste that was removed. Scavenging in this part of the site must be prevented.

Alternatively, a special *small burial pit* could be prepared to receive health-care waste only. The pit should be 2m deep and filled to a depth of 1–1.5m. After each waste load, the waste should be covered with a soil layer 10–15cm deep. If coverage with soil is not possible, lime may be deposited over the waste. In case of outbreak of an especially virulent infection (such as Ebola virus), both lime and soil cover may be added. Access to this dedicated disposal area should be restricted, and the use of a pit would make supervision by landfill staff easier and thus prevent scavenging. A typical example of pit design for health-care waste is shown in Fig. 8.12.

Before health-care wastes are sent for disposal, it is prudent to inspect landfill sites to ensure that there is sensible control of waste deposition.

Fig. 8.12 Example of a small burial pit for health-care waste

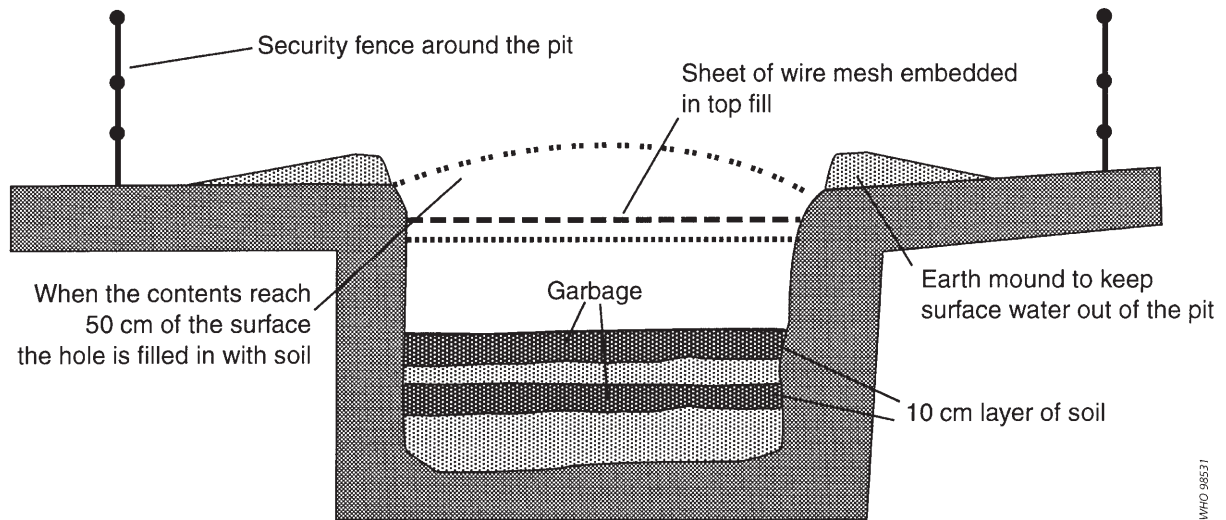

8.5.2 Encapsulation

Disposal of health-care waste in municipal landfills is less advisable if it is untreated than if it is pretreated. One option for pretreatment is encapsulation, which involves filling containers with waste, adding an immobilizing material, and sealing the containers. The process uses either cubic boxes made of high-density polyethylene or metallic drums, which are three-quarters filled with sharps and chemical or pharmaceutical residues. The containers or boxes are then filled up with a medium such as plastic foam, bituminous sand, cement mortar, or clay material. After the medium has dried, the containers are sealed and disposed of in landfill sites.

This process is relatively cheap, safe, and particularly appropriate for establishments that practise **minimal programmes** for the disposal of sharps and chemical or pharmaceutical residues. Encapsulation alone is not recommended for non-sharp infectious waste, but may be used in combination with burning of such waste. The main advantage of the process is that it is very effective in reducing the risk of scavengers gaining access to the hazardous health-care waste.

8.5.3 Safe burial on hospital premises

In health-care establishments that use minimal programmes for health-care waste management, particularly in remote locations, in temporary refugee encampments, or in areas experiencing exceptional hardship, the safe burial of waste on hospital premises may be the only viable option available at the time. However, certain basic rules should still be established by the hospital management:

- Access to the disposal site should be restricted to authorized personnel only.
- The burial site should be lined with a material of low permeability, such as clay, if available, to prevent pollution of any shallow groundwater that may subsequently reach nearby wells.

- Only hazardous health-care waste should be buried. If general hospital waste were also buried on the premises, available space would be quickly filled up.
- Large quantities (>1 kg) of chemical wastes should not be buried at one time. Burying smaller quantities avoids serious problems of environmental pollution.
- The burial site should be managed as a landfill, with each layer of waste being covered with a layer of earth to prevent odours, as well as to prevent rodents and insects proliferating.

The safety of waste burial depends critically on rational operational practices. The design and use of the burial pit are described in the previous section and illustrated in Fig. 8.12. The bottom of the pit should be at least 1.5 metres higher than the groundwater level.

Table 8.4 Summary of main advantages and disadvantages of treatment and disposal options

Treatment/ disposal method	Advantages	Disadvantages
Rotary kiln	Adequate for all infectious waste, most chemical waste, and pharmaceutical waste.	High investment and operating costs.
Pyrolytic incineration	Very high disinfection efficiency. Adequate for all infectious waste and most pharmaceutical and chemical waste.	Incomplete destruction of cytotoxics. Relatively high investment and operating costs.
Single-chamber incineration	Good disinfection efficiency. Drastic reduction of weight and volume of waste. The residues may be disposed of in landfills. No need for highly trained operators. Relatively low investment and operating costs.	Significant emissions of atmospheric pollutants. Need for periodic removal of slag and soot. Inefficiency in destroying thermally resistant chemicals and drugs such as cytotoxics.
Drum or brick incinerator	Drastic reduction of weight and volume of the waste. Very low investment and operating costs.	Destroys only 99% of microorganisms. No destruction of many chemicals and pharmaceuticals. Massive emission of black smoke, fly ash, toxic flue gas, and odours.
Chemical disinfection ^a	Highly efficient disinfection under good operating conditions. Some chemical disinfectants are relatively inexpensive. Drastic reduction in waste volume.	Requires highly qualified technicians for operation of the process. Uses hazardous substances that require comprehensive safety measures. Inadequate for pharmaceutical, chemical, and some types of infectious waste.
Wet thermal treatment ^a	Environmentally sound. Drastic reduction in waste volume. Relatively low investment and operating costs.	Shredders are subject to frequent breakdowns and poor functioning. Operation requires qualified technicians. Inadequate for anatomical, pharmaceutical, and chemical waste and waste that is not readily steam-permeable.
Microwave irradiation	Good disinfection efficiency under appropriate operating conditions. Drastic reduction in waste volume. Environmentally sound.	Relatively high investment and operating costs. Potential operation and maintenance problems.
Encapsulation	Simple, low-cost, and safe. May also be applied to pharmaceuticals.	Not recommended for non-sharp infectious waste.
Safe burying	Low costs. Relatively safe if access to site is restricted and where natural infiltration is limited.	Safe only if access to site is limited and certain precautions are taken.
Inertization	Relatively inexpensive.	Not applicable to infectious waste.

^aMay not apply to more sophisticated, self-contained, commercial methods.

It should be borne in mind that safe on-site burial is practicable only for relatively limited periods, say 1–2 years, and for relatively small quantities of waste, say up to 5 or 10 tonnes in total. Where these conditions are exceeded, a longer-term solution, probably involving disposal at a municipal solid waste landfill, will need to be found.

8.5.4 *Land disposal of residues*

After disinfection or incineration, infectious health-care waste becomes non-risk waste and may be finally disposed of in landfill sites. However, certain types of health-care waste, such as anatomical waste, will still have an offensive visual impact after disinfection, and this is culturally unacceptable in many countries. Such wastes should therefore be made unrecognizable before disposal, for example by incineration. If this is not possible, these wastes should be placed in containers before disposal.

8.6 Inertization

The process of “inertization” involves mixing waste with cement and other substances before disposal in order to minimize the risk of toxic substances contained in the waste migrating into surface water or groundwater. It is especially suitable, for pharmaceuticals and for incineration ashes with a high metal content (in this case the process is also called “stabilization”).

For the inertization of pharmaceutical waste, the packaging should be removed, the pharmaceuticals ground, and a mixture of water, lime, and cement added. A homogeneous mass is formed and cubes (e.g. of 1 m³) or pellets are produced on site and then can be transported to a suitable storage site. Alternatively, the homogeneous mixture can be transported in liquid state to a landfill and poured into municipal waste.

The following are typical proportions for the mixture:

- 65% pharmaceutical waste
- 15% lime
- 15% cement
- 5% water

The process is reasonably inexpensive and can be performed using relatively unsophisticated equipment. Other than personnel, the main requirements are a grinder or road roller to crush the pharmaceuticals, a concrete mixer, and supplies of cement, lime, and water.

The main advantages and disadvantages of the various treatment and disposal options addressed in this handbook are outlined in Table 8.4.

References and suggested further reading

- Andrychowski J (1988). *Les déchets hospitaliers et leur incinération, principes de combustion, évolution technologique des fours. [Hospital waste: incineration, principles of combustion, technological development in incinerators.]* Paris, Centre de formation et de documentation sur l'environnement industriel.
- Bonnard & Gardel (1990). *Plan sectoriel des déchets d'hôpitaux, Canton de Fribourg. [Canton of Fribourg: sectoral hospital waste scheme.]* Geneva, Bonnard & Gardel Ingénieurs-Conseils SA.

- Bartone C (1998). Municipal solid waste management. In: *Brazil: managing pollution problems—the brown environmental agenda*. Washington, DC, World Bank (Report No. 16635).
- Brunner CPE (1989). *Handbook of hazardous waste incineration*. Blue Ridge Summit, PA, TAB Books.
- Canadian Council of Ministers of the Environment (1992). *Guidelines for the management of biomedical waste in Canada*. Winnipeg (CCME/EPC-WM-42E).
- Christen J (1996). *Dar es Salaam Urban Health Project. Health care waste management in district facilities: situational analysis and system development*. St. Gallen, Switzerland, Swiss Centre for Development Cooperation in Technology and Management (SKAT).
- Constructions navales et industrielles de la Méditerranée (1992). *Four de pyrolyse par torche à plasma pour destruction de déchets. [Pyrolytic destruction of waste by plasma torch.]* Nantes.
- Cross F, Hesketh H, Rykowski K (1990). *Infectious waste management*. Lancaster, PA, Technomic Publishing.
- Danish Waste Management Association/Association of Danish Hospital Administrators (DAKFA/FSAD) (1991). *Waste. European conference on hospital waste management*. Copenhagen.
- Dunsmore DJ (1986). *Safety measures for use in outbreaks of communicable disease*. Geneva, World Health Organization.
- Liberti A et al. (1994). Optimization of infectious hospital waste management in Italy. Part 1: Waste production and characterization study. *Waste management and research*, 12:373–385.
- Ministère de la Santé (1990). *Guide sur l'élimination des déchets hospitaliers. [Guide to hospital waste disposal.]* Paris.
- Ministère de la Santé (1991). *Élimination des déchets produits par les professionnels de santé en exercice libéral, enquête sur les conditions actuelles d'élimination. [Disposal of waste produced by health professionals in the course of their duties and survey of current waste disposal conditions.]* Paris.
- Ministère de la Santé (1991). *Enquête nationale sur les conditions actuelles d'élimination des déchets solides hospitaliers. [National survey on current hospital waste disposal conditions.]* Paris.
- Oeltzschner H, Mutz D (1996). *Guidelines for an appropriate management of domestic sanitary landfills*. Eschborn, Gesellschaft für Technische Zusammenarbeit.
- Office fédéral suisse de la santé publique/Bonnard & Gardel Ingénieurs-Conseils SA (1994). *Analyse des méthodes d'élimination des déchets infectieux hospitaliers. [Analysis of disposal methods for infectious hospital waste.]* Berne.
- Reinhardt PA, Gordon JH (1991). *Infectious and medical waste*. Chelsea, MI, Lewis Publishers.
- Rushbrook PK, Pugh MP (1997). *Decision-maker's guide on the planning, siting, design and operation of sanitary landfills in middle- and lower-income countries*. To be published collaboratively by WHO/SKAT/World Bank, 1997.
- L'élimination des déchets. [Waste disposal.] *Techniques hospitalières*, 1991, 554 (numéro spécial).
- WHO (1985). *Solid waste management selected topics*. Copenhagen, World Health Organization Regional Office for Europe.
- WHO (1996). *Suggested guiding principles and practices for the sound management of hazardous hospital wastes. Regional Consultation on Sound Management of Hospital Waste in Chiang Mai, Thailand, November 1996*. New Delhi, World Health Organization Regional Office for South-East Asia.
- WHO (1996). *Healthy cities—healthy islands. Guides for municipal solid waste management in Pacific Island countries*. Manila, World Health Organization Regional Office for the Western Pacific (Document Series, No. 6).

9

Application of treatment and disposal methods to health-care waste categories

Suitable treatment and disposal methods for the different categories of health-care waste are summarized in Table 9.1 and discussed in more detail in this chapter.

9.1 Infectious waste and sharps

Within the limitations mentioned in the relevant sections, almost all the treatment methods outlined in Chapter 8 are suitable for infectious waste and sharps, except “inertization.” The treatment option should be chosen according to the national and local situation.

Destroying infectious microorganisms—by heat, by chemical means, or by microwave irradiation—is relatively easy. Highly infectious waste, such as cultures and stocks of infectious agents from laboratory work, should be sterilized by wet thermal treatment (e.g. autoclaving) at the earliest stage possible. For other infectious health-care waste, disinfection is adequate.

Sharps should undergo incineration whenever possible, and can be incinerated together with other infectious waste. Encapsulation is also suitable for sharps. After incineration or other disinfection, the residues may be landfilled.

In exceptional emergency situations, such as outbreaks of communicable diseases, burning of infectious health-care waste in open trenches may also be envisaged if it is not possible to use any of the treatment options described in Chapter 8 (see also Chapter 16).

Unless there is an adequate wastewater treatment plant, blood should be disinfected before discharge to a sewer; it may also be incinerated.

9.2 Pharmaceutical waste

Sound management of pharmaceutical products facilitates waste minimization (see section 6.1) and is of prime importance to better waste management in general. Disposal of small amounts of chemical or pharmaceutical waste is easy and relatively cheap; large amounts require the use of special treatment facilities.

9.2.1 *Disposal of small quantities of pharmaceutical waste*

The disposal options for small quantities of pharmaceutical waste include those outlined in the following paragraphs.

Table 9.1 Overview of disposal and treatment methods suitable for different categories of health-care waste

Technology or method	Infectious waste	Anatomical waste	Sharps	Pharmaceutical waste	Cytotoxic waste	Chemical waste	Radioactive waste
Rotary kiln	Yes	Yes	Yes	Yes	Yes	Yes	Low-level infectious waste
Pyrolytic incinerator	Yes	Yes	Yes	Small quantities	No	Small quantities	Low-level infectious waste
Single-chamber incinerator	Yes	Yes	Yes	No	No	No	Low-level infectious waste
Drum or brick incinerator	Yes	Yes	Yes	No	No	No	No
Chemical disinfection	Yes	No	Yes	No	No	No	No
Wet thermal treatment	Yes	No	Yes	No	No	No	No
Microwave irradiation	Yes	No	Yes	No	No	No	No
Encapsulation	No	No	Yes	Yes	Small quantities	Small quantities	No
Safe burial on hospital premises	Yes	Yes	Yes	Small quantities	No	Small quantities	No
Sanitary landfill	Yes	No	No	Small quantities	No	No	No
Discharge to sewer	No	No	No	Small quantities	No	No	Low-level liquid waste
Inertization	No	No	No	Yes	Yes	No	No
Other methods				Return expired drugs to supplier	Return expired drugs to supplier	Return unused chemicals to supplier	Decay by storage

- Landfill disposal*
Small quantities of pharmaceutical waste produced on a daily basis may be landfilled provided that they are dispersed in large quantities of general waste. Cytotoxic and narcotic drugs, however, should *never* be landfilled, even in small quantities.
- Encapsulation*
Small quantities of pharmaceutical waste may be encapsulated, together with sharps if appropriate.
- Safe burial on hospital premises*
Safe burial of small quantities of pharmaceutical waste prevents scavenging and may be an appropriate disposal method for establishments applying **minimal programmes**.
- Discharge to a sewer*
Moderate quantities of relatively mild liquid or semi-liquid pharmaceuticals, such as solutions containing vitamins, cough syrups, intravenous solutions, eye drops, etc. (but *not* antibiotics or cytotoxic drugs), may be diluted in a large flow of water and discharged into municipal sewers. It is not acceptable, however, to discharge even small quanti-

ties of pharmaceutical waste into slow-moving or stagnant water bodies.

- *Incineration*

Small quantities of pharmaceutical waste may be incinerated together with infectious or general waste, provided that they do not form more than 1% of the total waste (in order to limit potentially toxic emissions to the air).

9.2.2 *Disposal of large quantities of pharmaceutical waste*

Large quantities of solid pharmaceutical waste may have to be dealt with if a pharmacy closes down, for example, or after emergencies (see also *Guidelines for safe disposal of unwanted pharmaceuticals in emergencies and difficult circumstances*¹). The treatment methods outlined in the following paragraphs are suitable.

- *Incineration*

Incineration is the best way to dispose of pharmaceutical waste. The wastes should be mixed with their cardboard packaging, and possibly with other combustible material and infectious waste, to ensure optimal combustion conditions. Low-temperature incineration (<800°C), however, provides only limited treatment for this type of waste; it is not recommended unless it is followed by combustion in a second chamber, operating at temperatures about 1000°C, to burn off potentially toxic exhaust gases that may be produced. Ideally, large amounts of pharmaceuticals should be treated in incinerators designed for industrial waste (including rotary kilns), which can operate at high temperatures (>1200°C). Cement kilns are also particularly suited to the treatment of pharmaceuticals; in many countries, cement producers accept pharmaceutical waste as an alternative fuel, thus reducing fuel costs. As a “rule of thumb”, however, it is suggested that no more than 5% of the fuel fed into the furnace at any time is pharmaceutical material.

- *Encapsulation*

Solid, liquid, and semi-liquid waste can be encapsulated in metal drums (see section 8.5).

Landfilling of large quantities of pharmaceuticals is *not* recommended unless the waste is encapsulated and disposed of in sanitary landfill sites, where the risk of groundwater contamination is minimized. Large amounts of pharmaceutical waste should not be disposed of with general hospital waste, nor should they be diluted and discharged into sewers (except for certain very mild solutions, such as vitamin preparations).

Intravenous fluids and glass ampoules are special cases. Intravenous fluids (salts, amino acids, lipids, glucose, etc.), which are relatively harmless, can be disposed of to a landfill or discharged into a sewer. Ampoules should be crushed on a hard, impermeable surface; workers should wear protective clothing, eye protection, gloves, etc. The glass should then be

¹ *Disposal of unwanted pharmaceuticals in emergencies and difficult circumstances.* Geneva, World Health Organization (unpublished document, in preparation; will be available on request from Department of Essential Drugs and other Medicines, World Health Organization, 1211 Geneva 27, Switzerland).

swept up, collected, and disposed of with sharps. Ampoules should not be incinerated as they may explode, damaging the incinerator or injuring workers.

9.3 Cytotoxic waste

Cytotoxic waste is highly hazardous and should never be landfilled or discharged into the sewerage system. Disposal options include the following:

- *Return to original supplier*
Safely packaged but outdated drugs and drugs that are no longer needed should be returned to the supplier. This is currently the preferred option for countries that lack the facilities for incineration. Drugs that have been unpacked should be repackaged in a manner as similar as possible to the original packaging and marked “outdated” or “not for use”.
- *Incineration at high temperatures*
Full destruction of all cytotoxic substances may require temperatures up to 1200 °C; Table 9.2 gives the minimum temperatures necessary to destroy common cytotoxic products. Incineration at lower temperatures may result in the release of hazardous cytotoxic vapours into the atmosphere.

Modern double-chamber pyrolytic incinerators are suitable, provided that a temperature of 1200 °C with a minimum gas residence time of 2 seconds or 1000 °C with a minimum gas residence time of 5 seconds can be achieved in the second chamber. The incinerator should be

Table 9.2 *Minimum temperatures for destruction of cytotoxic drugs, for conventional residence times, according to different authors*

Compound	Temperature	Compound	Temperature
Aclarubicin	1000 °C ^a	Etoposide	1000 °C ^b , 700 °C ^a
Amsacrine	>260 °C ^a , 260 °C ^b	5-Fluorouracil	1200 °C ^c , 1000 °C ^b , 700 °C ^a
Bleomycin	1000 °C ^a	Idarubicin	700 °C ^a
Carboplatin	1000 °C ^a	Ifosfamide	1000 °C ^a
Carmustine	1000 °C ^{a,b}	Melphalan	500 °C ^a
Chlormethine (mustine)	800 °C ^a	Methotrexate	1000 °C ^{a,b}
Cisplatin	250 °C ^b , 800 °C ^a	Mithramycin	1000 °C ^c , 300 °C ^b
Cyclophosphamide	900 °C ^a	Mitomycin	1000 °C ^a
Cytarabine	1000 °C ^a	Mitoxantrone	800 °C ^a
Dacarbazine	500 °C ^a	Plicamycin	1000 °C ^a
Dactinomycin	1000 °C ^a	Thiotepa	800 °C ^{a,b}
Daunorubicin	800 °C ^{b,c} , 700 °C ^a	Vincristine	1000 °C ^{a,b}
Doxorubicin	>700 °C ^c , 700 °C ^a	Vindesine	1000 °C ^{a,b}
Epirubicin	700 °C ^{b,c}		

^aAllwood & Wright (1993); ^bLee (1988); ^cWilson (1983).

Note: The data included in this table were the most recent data available at the time of preparation of this handbook, but no information has been provided as to the scientific background which led to these proposals. The Agence de l'Environnement et de la Maîtrise de l'Energie (ADEME) (contact address: Centre de Sophia Antipolis, Département Toxicologie et Exotoxicologies, 500 route des Lucioles, 06560 Valbonne, France) is investigating the efficiency of incineration of a number of individual drugs and the genotoxic risk of the outgoing residues.

fitted with gas-cleaning equipment. Incineration is also possible in rotary kilns designed for thermal decomposition of chemical wastes, in foundries, or in cement kilns, which usually have furnaces operating well in excess of 850°C.

Incineration in most municipal incinerators, in single-chamber incinerators, or by open-air burning is inappropriate for the disposal of cytotoxic waste.

- *Chemical degradation*

Chemical degradation methods, which convert cytotoxic compounds into non-toxic/non-genotoxic compounds, can be used not only for drug residues but also for cleaning of contaminated urinals, spillages, and protective clothing. The methods are appropriate for developing countries. Drugs for which chemical degradation methods are available are listed in Box 9.1. Most of these methods are relatively simple and safe; they include oxidation by potassium permanganate (KMnO₄) or sulfuric acid (H₂SO₄), denitrosation by hydrobromic acid (HBr), or reduction by nickel and aluminium. They are described in detail in Annex 2. The International Agency for Research on Cancer (IARC) may be contacted for further information.¹ The methods are *not* appropriate for the treatment of contaminated body fluids.

It should be noted that neither incineration nor chemical degradation currently provides a *completely* satisfactory solution for the treatment of waste, spillages, or biological fluids contaminated by antineoplastic agents. Until such a solution is available, hospitals should use the utmost care in the use and handling of cytotoxic drugs.

Where neither high-temperature incineration nor chemical degradation methods are available and where exportation of cytotoxic wastes for adequate treatment to a country with the necessary facilities and expertise is not possible, encapsulation or inertization may be considered as a last resort.

Box 9.1 Cytotoxic drugs for which chemical degradation methods exist

Carmustine	Doxorubicin	Semustine
Chlorambucil	Ifosfamide	Spiromustine
Chlormethine	Lomustine	Streptozocin
Chlorozotocin	Melphalan	6-Thioguanine
Cisplatin	6-Mercaptopurine	Uramustine
Cyclophosphamide	Methotrexate	Vincristine sulfate
Daunorubicin	PCNU ^a	Vinblastine sulfate
Dichloromethotrexate	Procarbazine	

^a1-(2-Chloroethyl)-3-(2,6-dioxo-3-piperidyl)-1-nitrosourea.

¹ International Agency for Research on Cancer, Unit of Gene-Environment Interactions, 150 Cours Albert-Thomas, 69372 Lyon Cedex 08, France.

9.4 Chemical waste

As for pharmaceutical waste, improving the management of chemical waste starts with waste minimization efforts (see section 6.1).

9.4.1 *Disposal of general chemical waste*

Non-recyclable, general chemical waste, such as sugars, amino acids, and certain salts (see also section 2.1.7), may be disposed of with municipal waste or discharged into sewers. The discharge into sewers of aqueous chemical wastes that arise in health-care establishments, together with their associated suspended colloidal and dissolved solids, has traditionally been accepted by sewerage authorities in many countries. However, official permission from the appropriate authority may be required and the types and quantities of material that can be discharged may be limited. Generally, conditions for discharge may include restrictions on pollutant concentrations, content of suspended solids, temperature, pH, and, sometimes, rate of discharge. Unauthorized discharge of hazardous chemicals can be dangerous to sewage treatment workers and may adversely affect the functioning of sewage treatment works.

Petroleum spirit, calcium carbide, and halogenated organic solvents should *not* be discharged into sewers.

9.4.2 *Disposal of small quantities of hazardous chemical waste*

Small quantities of hazardous chemical waste, e.g. residues of chemicals inside their packaging, may be dealt with by pyrolytic incineration, encapsulation, or landfilling.

9.4.3 *Disposal of large quantities of hazardous chemical waste*

There is no way to dispose both safely and cheaply of significant quantities of hazardous chemical waste. The appropriate means of disposal is dictated by the nature of the hazard presented by the waste.

Certain combustible wastes, including many solvents, may be incinerated. However, incineration of large quantities of halogenated solvents (containing chlorine or fluorine for instance) should not be undertaken unless facilities have adequate gas-cleaning equipment. Any waste that cannot be safely and efficiently incinerated should be handled and disposed of by an organization or company specifically authorized to manage hazardous waste. This organization may eliminate the wastes in a rotary kiln, treat them chemically, or store them in a safe disposal facility engineered for hazardous chemicals.

Other possibilities for disposing of hazardous chemicals include return to the original supplier, who should be equipped to deal with them safely. Where such an arrangement is envisaged, appropriate provisions should be included in the original purchase contract for the chemicals. The waste could also be exported to a country with the expertise and facilities to dispose safely of hazardous waste. Shipment for this purpose should comply with international agreements, such as the Basel Convention (see section 4.1). Use of certain products for non-medical purposes may also be considered; for example, use of outdated disinfectants to clean toilets is often acceptable.

The following additional measures are also recommended:

- Hazardous chemical wastes of different composition should be stored separately to avoid unwanted chemical reactions.
- Hazardous chemical waste should not be discharged into sewerage systems.
- Large amounts of chemical waste should not be buried as they may contaminate water sources.
- Large amounts of chemical disinfectants should never be encapsulated as they are corrosive and sometimes flammable.

9.5 Wastes with high heavy-metal content

Wastes containing mercury or cadmium should never be burned or incinerated because of the risk of atmospheric pollution with toxic vapours, and should never be disposed of in municipal landfills as they may pollute the groundwater.

In countries with “cottage” industries specializing in the recovery of heavy metals, mercury- and/or cadmium-containing waste can be sent to these facilities for recovery of the valuable materials. It may also be possible to send back the waste to the suppliers of the original equipment, with a view to reprocessing or final disposal, but this is unusual because suppliers are generally reluctant to accept these wastes. The situation should be checked before dispatch of wastes. Exporting the waste to countries with the expertise and facilities for its adequate treatment should also be considered.

If none of the above options is feasible, the wastes may be disposed of in a safe storage site especially designed for the final disposal of hazardous industrial waste. Establishments that apply **minimal programmes** may also consider encapsulation, followed by disposal in an impermeable landfill (if available).

Where the production of waste with high heavy-metal content is minimal (e.g. in similar quantities to that present in municipal waste) and there are no facilities for recovery of heavy metals within the country, this waste may join the municipal waste stream.

9.6 Pressurized containers

Incineration or burning is not a disposal option for pressurized containers or aerosol cans because of the risk of explosion. The best disposal options are recycling and reuse; most undamaged pressurized containers may be sent back to the gas suppliers for refilling. Appropriate arrangements for the return of containers should be included in the original purchase contracts. Halogenated agents in liquid form, supplied in glass bottles, should be handled as hazardous chemical waste and disposed of as such (see section 9.4).

The following disposal options exist:

- *Undamaged containers*
The following containers should be returned to the supplier:

- nitrous oxide cartridges or cylinders attached directly to the anaesthesia equipment;
- ethylene oxide cartridges or cylinders, which are usually attached to specially designed sterilizers;
- pressurized cylinders for other gases, such as oxygen, nitrogen, carbon dioxide, compressed air, cyclopropane, hydrogen, petroleum gases (for heating and cooking), and acetylene (for welding).

- *Damaged containers*

Pressurized containers that have been damaged and are unsuitable for refilling may be crushed after being emptied completely; they can then be disposed of in any landfill. This option may also be selected when the return of empty containers to the gas suppliers is uneconomical. “Cottage” industries specializing in recovery of metals may also accept damaged pressurized containers. In extreme cases, where containers have corroded valves and still have residual pressure, the only safe solution is to assemble them at a safe location (e.g. a military training area) and arrange for qualified specialists to destroy them by controlled explosion.

- *Aerosol cans*

Small aerosol cans should be collected and disposed of with general waste in black waste bags, but *only* if this waste is not destined for burning or incineration. They should never be placed in yellow bags, which will go for incineration. Large quantities of disposable aerosol cans may be returned to the supplier or sent to waste recycling plants where possible.

9.7 Radioactive waste

Note: A number of specific terms used in this section are explained in the Glossary (page 183).

The safe management of radioactive waste should ideally be the subject of a proper national strategy with an infrastructure that includes appropriate legislation, competent regulatory and operational organizations, and adequately trained personnel. The national strategy should also determine whether there will be centralized waste management or whether waste will be managed entirely at source (e.g. at the health-care institutions). This decision will be based on the quantity and activity levels of the waste generated and on the outcome of a cost–benefit analysis.

Each hospital or laboratory that uses unsealed radioactive sources for diagnostic, therapeutic, or research purposes should designate a trained Radiation Officer who will be responsible for the safe use of radioactive substances and for record-keeping. Properly calibrated instruments should be available for monitoring dose rates and contamination. A suitable record system that will ensure the traceability of radioactive waste transferred or disposed of locally should be established and kept up to date at all times.

9.7.1 Radioactive waste classification

Note: The classification of radioactive waste and the clearance levels should be established by the regulatory authority. Table 9.3 and

Table 9.3 *Radioactive waste classification*

Class	Description
Cleared material/waste	Materials containing levels of radionuclides at concentrations less than those expressed in Annex 3 (Tables A3.1–A3.3)
Low-level (short-lived)/decay waste	Low-level radioactive waste containing short-lived radionuclides only (e.g. with half-lives less than 100 days), that will decay to clearance levels within 3 years of being produced
Low- and intermediate-level short-lived waste (LILW-SL)	Waste that will not decay to clearance levels within 3 years, containing β - and γ -emitting radionuclides with half-lives less than 30 years and/or α -emitting radionuclides with an activity less than 400Bq/g and a total activity of less than 4000Bq in each waste package
Low- and intermediate-level long-lived waste (LILW-LL)	Radioactive waste that contains radionuclides at concentrations above those for LILW-SL but with heat-generating capacity not exceeding 2kW/m ³ of waste
High-level waste (HLW)	Radioactive waste that contains radionuclides at concentrations above those for LILW-SL and with heat-generating capacity above 2kW/m ³ of waste

Annex 3 provide examples of waste classification and clearance levels.

Radioactive waste should be classified in accordance with national legislation and according to the activity levels and half-lives of the radionuclides present, as shown in Table 9.3.

9.7.2 *Radioactive waste segregation and characterization*

Radioactive waste should be categorized and segregated on the basis of the available options for treatment, conditioning, storage, and disposal. Possible categories are:

- half-life—for instance, short-lived (e.g. half-life <100 days), suitable for decay storage;
- activity and radionuclide content;
- physical and chemical form:
 - liquid: aqueous and organic
 - non-homogeneous (e.g. contain sludges or suspended solids)
 - solid: combustible/non-combustible (if applicable) and compactable/non-compactable (if applicable)
- sealed/non-sealed sources—for instance, spent sealed sources;
- waste content—for instance, waste containing hazardous (e.g. pathogenic, infectious, toxic) material.

After segregation, each category of waste should be kept separately, i.e. in separate containers. The waste containers should:

- be clearly identified;
- bear a radiation trefoil symbol when in use;
- be robust;
- be compatible with the waste contents;
- be capable of being filled and emptied safely.

The following information should be recorded for each waste container:

- identification number;
- radionuclides;
- activity (if measured or estimated) and date of measurement;
- origin (room, laboratory, individual, etc. if applicable);
- potential/actual hazards (chemical, infectious, etc.);
- surface dose rate and date of measurement;
- quantity (weight or volume);
- responsible person.

Containers for solid wastes should be lined with a durable transparent plastic bag which can be sealed (tied with plastic adhesive tape or heat-sealed).

Liquid waste should be collected in suitable containers according to its chemical and radiological characteristics, volume, and handling and storage requirements.

Spent sealed sources should be kept under shielding.

Containers should be checked for radioactive contamination; loose contaminating material should be removed before containers are reused.

Characterization of radioactive waste in terms of activity, radionuclide content, physical and chemical form, and associated hazards can be achieved by a combination of quality assurance (records of radionuclide inventory, activity decay, composition of materials used, etc.) and direct measurement techniques. Waste of unknown origin and composition will require detailed analysis. This may be complex and expensive.

9.7.3 Management options for radioactive health-care waste

A range of options may need to be considered for dealing with radioactive waste generated by health-care activities, depending on the amount and characteristics of the waste.

The waste may be suitable for release from regulatory control immediately or after a period of decay storage, which may vary from some days to a few years. Such waste may be released in quantities or at activity levels established by the regulatory authority. The recycling or reuse of radioactive materials is also possible if the regulatory authority has approved such an option.

If release is not a feasible option, return of the waste to the producer/supplier of the original material should be considered. This is of particular importance for large sealed sources and sources containing long-lived radionuclides.

For waste that can neither be released from regulatory control nor returned to the producer/supplier, an acceptable destination will need to be identified. This could be either a disposal facility or a facility for long-term storage pending future disposal. In both cases, prior treatment or conditioning of waste may be needed.

Decisions on waste management have significant financial implications that have to be addressed, since the waste generator is responsible for the waste. In developing its strategy, the national government may choose to undertake essential waste treatment, conditioning, storage,

and/or disposal if it is in the public interest to do so. In such cases, the function of the regulatory authority should be clearly separate and independent from that of the operating organizations.

Exemption and clearance

Some radioactive wastes can be exempted, or released, from regulatory control, because they represent a negligible radiological hazard. The radioactivity of materials released to the environment should be below the clearance levels established by the regulatory authority (examples are given in Tables A3.1–A3.3 of Annex 3). The discharge or release of the radioactive material should be monitored and recorded with sufficient detail and accuracy to demonstrate its compliance with the regulations.

Radioactive waste containing short-lived radionuclides should be stored for decay to the clearance levels.

Exemption of radioactive health-care waste from regulatory control is unlikely to mean that it is also exempt from regulatory control of other hazards.

Recycling and reuse

Recycling and reuse of radioactive materials should be considered as an alternative to disposal, if circumstances permit. Possibilities include:

- reuse of sealed sources;
- decontamination and reuse of equipment and protective clothing;
- reuse of dilute waste streams (for rinsing and washing of waste tanks that contained liquid waste with higher radioactivity content).

The reuse and/or recycling of radioactive materials should be subject to approval by the regulatory authority. Special attention should be given both to the implications of producing secondary waste streams, and to the need to ensure that sealed sources are in a serviceable condition and suitable for the intended application.

Spent sealed sources should not be recycled by the health-care institutions.

Return to supplier

If at all possible, spent sealed sources should be returned to suppliers. This is particularly important for sources with high activity and those containing long-lived radionuclides.

The high-activity radionuclides, usually of long half-life, used for therapeutic purposes are conditioned as sealed sources, in the form of pills, seeds, ribbons, capsules, tubes, or needles. Brachytherapy sources are recovered after use, washed, disinfected, and stored under lead shielding until needed for other patients. These items may become waste if their conditioning is damaged, the activity has decayed, or they are no longer required. Spent sources for teletherapy also become waste. In countries that lack a nuclear industry equipped to dispose of spent sealed sources, hospitals should return these items to their original containers or otherwise package them appropriately (see Chapter 7) and send them back to the supplier for reprocessing, recycling, or safe disposal. Where a nuclear industry with appropriate capabilities exists, hospitals may send non-

recyclable spent sealed sources to an authorized facility or to the national agency designated for radioactive waste disposal.

Any health-care institution proposing to import a sealed source containing radioactive material that will have an activity greater than 100 MBq 10 years after receipt is recommended to:

- require the supplier to accept the source back after expiry of its useful lifetime, within 1 year of such return being requested, on condition that the user undertakes to return the source to the supplier not later than 15 years after receiving it;
- submit to the regulatory authority a copy of relevant parts of the contract (if the source is purchased) or acceptance document (if the source is donated) and obtain the written agreement of the authority before purchasing or accepting the source.

Storage

Storage facilities may be required for untreated, treated, and conditioned radioactive health-care waste; special care is needed for the storage of unconditioned waste in order to limit the risk of dispersion. Storage facilities should be designed to provide physical security, retrievability, and radiological protection. Radioactive waste must be stored in such a way that human health and the environment are protected; it must not be stored in the vicinity of corrosive, explosive, or readily flammable materials.

Where activity limits for immediate or simple discharge/disposal methods cannot be met, health-care establishments should segregate radioactive waste and store it for the time required for the activity to decay to clearance levels. Since the half-life of most radioactive materials used in hospitals is of the order of hours or days, storage for at least 10 half-life periods can be followed by disposal to the ordinary waste system (with appropriate monitoring). Decayed, non-infectious radioactive waste should be placed in transparent bags to facilitate visual inspection (if the wastes are to be landfilled). Decayed but infectious radioactive waste requires disinfection before disposal and is therefore collected in yellow plastic bags.

All radioactive waste that is to be stored during decay should be kept in suitable containers that prevent dispersion of their content. A plastic bag in an easy-to-handle can or drum should be used. Containers used for the storage of radioactive waste should be clearly identified (marked with the words “RADIOACTIVE WASTE” and the radiation symbol), and labelled to show the activity of the radionuclide on a particular date, period of storage required, origin of the waste, surface dose rate on a particular date, quantity, and responsible person. The containers should be stored in a specially designated area in storage rooms—lead-shielded if necessary—designed for radioactive substances or waste. The storage record should be clearly endorsed to indicate the items that are “radioactive waste”.

Facilities or areas for radioactive waste must be clearly demarcated, with controlled access, and should have the characteristics listed in Box 9.2. Areas for untreated (raw) waste should be separate from those for conditioned waste.

Box 9.2 Characteristics of storage facilities/areas for radioactive health-care waste

- Sufficient capacity to accommodate all waste generated before discharge, treatment, or transportation.
- Simple construction, with non-flammable walls and floors that may be easily decontaminated.
- Impermeable floor covering, with a containment edge and slight slope to a central collection area.
- Adequate ventilation.
- Air sampling and radiation alarms (as required by the regulatory authority).
- Fire detection/control equipment (as required by the regulatory authority).
- Fire-resistant, lockable doors.
- Compartments to allow separation of different kinds of waste (e.g. to facilitate the safe storage of materials presenting particular hazards—volatile, pathogenic, infectious and putrescible, chemically reactive).
- Demarcation as radiologically controlled areas.
- A log-book, listing the number of containers, entry date, waste types, activity, etc., which should be kept outside, but near, the storage room or area.
- Protection from the environment (weather), including extremes of temperature.
- Protection against unauthorized entry and against the intrusion of animals, insects, etc.
- Movable radiation shielding (placed as appropriate to protect workers from radiation).

Treatment and conditioning

Radioactive health-care waste should be treated and conditioned in accordance with the national radioactive waste management strategy and, in particular, to meet any waste acceptance criteria laid down by the regulatory authority. Treatment and conditioning should be undertaken, when necessary, to improve the characteristics of waste before interim storage and/or disposal.

Treatment includes operations intended to improve safety or economy by changing the characteristics of the radioactive waste. The basic objectives are:

- Volume reduction:
 - for solid waste: shredding, low-force compaction, and controlled incineration;
 - for liquid waste: evaporation under controlled conditions.

- Removal of radionuclides:
 - for solid waste: decontamination;
 - for liquid waste: ion exchange.
- Change of composition:
 - for liquid waste: precipitation/filtration.

It is important to be aware that treatment processes may result in the production of secondary radioactive waste streams (contaminated filters, spent resins, sludges, ash), which also need to be appropriately managed.

Conditioning involves those operations that convert radioactive waste into a form that is more suitable for handling, transportation, storage, and disposal. The operations may include immobilization of radioactive waste in concrete, placing the waste in suitable containers, and providing additional packaging. In many instances, treatment and conditioning take place in close physical conjunction with one another.

Discharge/disposal

Although management may involve the concentration and containment of radioactive waste, it may also involve the discharge of effluents (for example, of liquid and gaseous waste) into the environment. This may be done only within the limits authorized by the regulatory authority, and should take into account subsequent dispersion. For all practical purposes this is an irreversible action and is considered suitable only for limited amounts of certain radioactive wastes.

The health-care institution should ensure that radionuclides are not released to the environment unless:

- the activity released is confirmed to be below the clearance levels; or
- the activity of the liquid or gaseous effluents discharged is within limits authorized by the regulatory authority.

Any health-care institution wishing to release to the environment solid, liquid, or gaseous radioactive waste with activity above the clearance levels should apply for an authorization. It should also:

- keep all radioactive discharges or releases as far below the authorized limits as is reasonably achievable;
- monitor and record the discharges or releases of radionuclides with sufficient detail and accuracy to demonstrate compliance with the authorized discharge limits;
- report discharges to the regulatory authority at whatever intervals are specified in the authorization; and
- report promptly to the regulatory authority any discharges or releases that exceed the authorized limits.

Whether radioactivity is released within the clearance levels or under authorization, the non-radiological hazards of the release must also be considered and the requirements of any regulations governing those hazards should be met.

Disposal is the final step in the management of radioactive waste. Essentially, it involves the placement of radioactive waste in a disposal facility that provides reasonable assurance of safety; in general there is no intention of retrieval, and no long-term surveillance or maintenance of

the disposal site. The establishment of an engineered disposal facility (repository) is thus a complex and costly undertaking.

When radioactive waste is not suitable for discharge or release to the environment or for clearance within a reasonable time, the health-care institution should submit its proposals for disposal to the regulatory authority. It should then ensure that the criteria set by the regulatory authority for acceptance of the waste at any repository or by any national waste management organization are met.

Additional remarks

- Disposable syringes containing radioactive residues should be emptied in a location designated for the disposal of radioactive liquid waste. They should then be stored in a sharps container to allow decay of any residual activity, before normal procedures for disposal of syringes and needles are followed.
- It is not appropriate to disinfect radioactive solid waste by wet thermal or microwave procedures.
- Solid radioactive waste such as bottles, glassware, and containers should be destroyed before disposal to avoid reuse by the public.
- The drains that serve sinks designated for discharge of radioactive liquids should be identified. If repairs become necessary, radiation levels should be measured as the drain or sewer is opened up, and appropriate precautions should be taken.
- Liquids that are immiscible with water, such as scintillation counting residues, should not be discharged to sewers but treated by an alternative method, e.g. incineration, absorption.
- Higher-level radioactive waste of relatively short half-life (e.g. from iodine-131 therapy) and liquids that are immiscible with water, such as scintillation counting residues and contaminated oil, should be stored for decay in marked containers, under lead shielding, until activities have reached authorized clearance levels. Water-miscible waste may then be discharged to the sewer system and immiscible waste may be disposed of by the methods recommended for large quantities of hazardous chemical waste.
- Radioactive waste resulting from cleaning-up operations after a spillage or other accident should be retained in suitable containers, unless the activity is clearly low enough to permit immediate discharge. If excessive activity enters the sewer accidentally, a large volume of water should be allowed to flow to provide dilution to about 1 kBq per litre. The relevant governmental agency must be informed urgently if radioactive waste in excess of the permitted amounts has been discharged to sewers, the atmosphere, or otherwise into the environment. After the emergency period, the activity of the resulting waste should be assessed and the relevant ministries should be informed of the circumstances that gave rise to the incident.
- It is not usually necessary to collect and confine patients' excreta after diagnostic procedures, although ordinary toilets used by such patients should be checked regularly for radioactive contamination by competent staff (e.g. the Radiation Officer). In the case of therapeutic procedures involving radionuclides, hospital toilets must be checked for radioactive contamination after each use by patients, unless every patient has an individual toilet. Some countries require the use of separate toilets equipped with delay tanks and/or special treatment systems for patients undergoing radiotherapy.

- Radioactive gases, deriving mainly from research and radioimmunoassays, should be discharged directly to the atmosphere for dilution by dispersal (within the authorized limits). In general, all gaseous waste discharges, including exhausts from stores and fume cupboards, should be designed and sited to prevent re-entry into any part of the premises. Radiation and contamination levels near discharge points should be checked periodically by the Radiation Officer. The WHO air quality guideline value for atmospheric radioactivity is 1 Bq/m³.

References and suggested further reading

- Allwood M, Wright P, eds (1993). *The cytotoxic handbook*. Oxford, Radcliffe Medical Press.
- Barek J et al. (1987). Method for efficient degradation of melphalan into non-mutagenic products. *Microchemical journal*, 36:192–197.
- Bisson M et al. (1995). *Élimination par incinération des déchets liés à l'utilisation de médicaments anticancéreux. Rapport final. [Elimination of wastes related to the use of anti-cancer drugs by incineration. Final report.]* Valbonne, Agence de l'Environnement et de la Maîtrise de l'Énergie.
- Bisson M (1996). *Élimination par incinération des déchets liés à l'utilisation de médicaments anticancéreux: optimisation couple température-temps. Rapport final. [Elimination of wastes related to the use of anti-cancer drugs by incineration: optimization of temperature–time parameters. Final report.]* Valbonne, Agence de l'Environnement et de la Maîtrise de l'Énergie.
- Castegnaro M, Rousselin X (1994). Cancérogènes, mutagènes chimiques et autres substances toxiques: traitement des déchets avant rejet. [Carcinogens, chemical mutagens and other toxic substances: treatment of wastes before disposal.] In: Rousselin X et al., eds. *Prévention et sécurité lors de la manipulation des substances génotoxiques utilisées au laboratoire. [Prevention and safety in the manipulation of genotoxic substances used in the laboratory.]* Paris, Institut National de Recherche Scientifique (Publication ED769).
- Castegnaro M et al. (1983). *Laboratory decontamination and destruction of carcinogens in laboratory wastes: some hydrazines*. Lyon, International Agency for Research on Cancer (IARC Scientific Publications, No. 54).
- Castegnaro M et al. (1985). *Laboratory decontamination and destruction of carcinogens in laboratory wastes: some antineoplastic agents*. Lyon, International Agency for Research on Cancer.
- Castegnaro M et al. (1997). Chemical degradation of wastes of antineoplastic agents. Part 2: six anthracyclines: idarubicin, doxorubicin, epirubicin, pirarubicin, aclarubicin and daunorubicin. *International archives of occupational and environmental health*, 70:378–384.
- Hansel S, Castegnaro M, Sportouch M-H (1997). Chemical degradation of wastes of antineoplastic agents. Part 1: cyclophosphamide, ifosfamide and melphalan. *International archives of occupational and environmental health*, 69:109–114.
- IAEA (1992). *Treatment and conditioning of radioactive solid wastes*. Vienna, International Atomic Energy Agency (TECDOC 655).
- IAEA (1993). *Radioactive waste management glossary*. Vienna, International Atomic Energy Agency.
- IAEA (1994). *Classification of radioactive waste*. Vienna, International Atomic Energy Agency (Safety Series, 111-G-1.1).
- IAEA (1995a). *The principles of radioactive waste*. Vienna, International Atomic Energy Agency (Safety Series, 111-F).
- IAEA (1995b). *Establishing a national system for radioactive waste management*. Vienna, International Atomic Energy Agency (Safety Series, 111-S-1).
- IAEA (1996a). *International basic safety standards for protection against ionizing radiation and for the safety of radiation sources*. Vienna, International Atomic Energy Agency (Safety Series, No. 115).

- IAEA (1996b). *Clearance levels for radionuclides in solid materials*. Vienna, International Atomic Energy Agency (TECDOC 855).
- IAEA. *Clearance of materials resulting from the use of radionuclides in medicine, industry and research*. Vienna, International Atomic Energy Agency (in press).
- IAEA. *Implementation of safety regulations on radioactive waste management*. Vienna, International Atomic Energy Agency (in press).
- IARC (1979). *Report of the first meeting of the working group on methods for containment, destruction and disposal of carcinogenic waste from laboratories*. Lyon, International Agency for Research on Cancer (IARC Technical Report No. 79/002).
- IARC (1991). *IARC monograph on the evaluation of carcinogenic risk of chemicals to humans: some antineoplastic and immunosuppressive agents*. Lyon, International Agency for Research on Cancer (IARC Monographs, No. 26).
- IARC (1994). *IARC monographs on the evaluation of carcinogenic risks to humans. List of IARC evaluations*. Lyon, International Agency for Research on Cancer.
- Lunn G, Sansone EB (1987). Reductive destruction of dacarbazine, procarbazine hydrochloride, isoniazid and iproniazid. *American journal of hospital pharmacy*, 44:2519–2524.
- Lunn G et al. (1989). Degradation and disposal of some antineoplastic drugs. *Journal of pharmaceutical sciences*, 78:652–659.
- Monteith DK, Connor TH, Benvenuto JA (1987). Stability and inactivation of mutagenic drugs and their metabolites in the urine of patients administered antineoplastic therapy. *Environmental and molecular mutagenesis*, 10:341–356.
- Wilson SJ (1983). Safe disposal of some commonly used injectable antineoplastic drugs. *Journal of clinical and hospital pharmacy*, 8:295–299.

10

Collection and disposal of wastewater

10.1 Characteristics and hazards of wastewater from health-care establishments

Wastewater from health-care establishments is of a similar quality to urban wastewater, but may also contain various potentially hazardous components, discussed in the following paragraphs.

10.1.1 *Microbiological pathogens*

The principal area of concern is wastewater with a high content of enteric pathogens, including bacteria, viruses, and helminths, which are easily transmitted through water. Contaminated wastewater is produced by wards treating patients with enteric diseases and is a particular problem during outbreaks of diarrhoeal disease.

10.1.2 *Hazardous chemicals*

Small amounts of chemicals from cleaning and disinfection operations are regularly discharged into sewers. If the recommendations of section 9.4 are not followed, larger quantities of chemicals may be present in wastewater.

10.1.3 *Pharmaceuticals*

Small quantities of pharmaceuticals are usually discharged to the sewers from hospital pharmacies and from the various wards. If the recommendations of section 9.2 are not followed, more important quantities of pharmaceuticals—including antibiotics and genotoxic drugs—may also be discharged.

10.1.4 *Radioactive isotopes*

Small amounts of radioactive isotopes will be discharged into sewers by oncology departments but should not pose any risk to health if the recommendations of section 9.7 are followed.

10.1.5 *Related hazards*

In some developing and industrializing countries, outbreaks of cholera are periodically reported. Sewers of the health-care establishments where cholera patients are treated are not always connected to efficient sewage treatment plants, and sometimes municipal sewer networks may not even exist. Although links between the spread of cholera and unsafe wastewater disposal have not been sufficiently studied or documented, they have been strongly suspected, for instance during recent African outbreaks (Democratic Republic of the Congo, Rwanda), and during the 1991–92 cholera epidemic in southern America. Little information is

available on the transmission of other diseases through the sewage of health-care establishments.

In developed countries, water use is commonly high and the sewage therefore greatly diluted; effluents are treated in municipal treatment plants and no significant health risks should be expected, even without further specific treatment of these effluents. Only in the unlikely event of an outbreak of acute diarrhoeal diseases should excreta from patients be collected separately and disinfected. In developing countries, where there may be no connection to municipal sewage networks, discharge of untreated or inadequately treated sewage to the environment will inevitably pose major health risks.

The toxic effects of any chemical pollutants contained in wastewater on the active bacteria of the sewage purification process may give rise to additional hazards.

10.2 Wastewater management

The basic principle underlying effective wastewater management is a strict limit on the discharge of hazardous liquids to sewers, as recommended in Chapter 9.

10.2.1 Connection to a municipal sewage treatment plant

In countries that do not experience epidemics of enteric disease and that are not endemic for intestinal helminthiasis, it is acceptable to discharge the sewage of health-care establishments to municipal sewers without pretreatment, provided that the following requirements are met:

- the municipal sewers are connected to efficiently operated sewage treatment plants that ensure at least 95% removal of bacteria;
- the sludge resulting from sewage treatment is subjected to anaerobic digestion, leaving no more than one helminth egg per litre in the digested sludge;
- the waste management system of the health-care establishment maintains high standards, ensuring the absence of significant quantities of toxic chemicals, pharmaceuticals, radionuclides, cytotoxic drugs, and antibiotics in the discharged sewage;
- excreta from patients being treated with cytotoxic drugs may be collected separately and adequately treated (as for other cytotoxic waste).

If these requirements cannot be met, the wastewater should be managed and treated as recommended in section 10.2.2 below.

In normal circumstances, the usual secondary bacteriological treatment of sewage, properly applied, complemented by anaerobic digestion of sludge, can be considered as sufficient. During outbreaks of enteric disease, however, or during critical periods (usually in summertime because of warm weather, and in autumn because of reduced river water flow), effluent disinfection by chlorine dioxide (ClO₂) or by any other efficient process is recommended. If the final effluent is discharged into coastal waters close to shellfish habitats, disinfection of the effluent will be required throughout the year.

When the final effluents or the sludges from sewage treatment plants are reused for agricultural or aquacultural purposes, the safety recommendations of the relevant WHO guidelines should be respected (see section 10.2.2).

10.2.2 On-site treatment or pretreatment of wastewater

Many hospitals, in particular those that are not connected to any municipal treatment plant, have their own sewage treatment plants.

Wastewater treatment

Efficient on-site treatment of hospital sewage should include the following operations:

- *Primary treatment*
- *Secondary biological purification.* Most helminths will settle in the sludge resulting from secondary purification, together with 90–95% of bacteria and a significant percentage of viruses; the secondary effluent will thus be almost free of helminths, but will still include infective concentrations of bacteria and viruses.
- *Tertiary treatment.* The secondary effluent will probably contain at least 20 mg/litre suspended organic matter, which is too high for efficient chlorine disinfection. It should therefore be subjected to a tertiary treatment, such as lagooning; if no space is available for creating a lagoon, rapid sand filtration may be substituted to produce a tertiary effluent with a much reduced content of suspended organic matter (<10 mg/litre).
- *Chlorine disinfection.* To achieve pathogen concentrations comparable to those found in natural waters, the tertiary effluent will be subjected to chlorine disinfection to the breakpoint. This may be done with chlorine dioxide (which is the most efficient), sodium hypochlorite, or chlorine gas. Another option is ultraviolet light disinfection.

Disinfection of the effluents is particularly important if they are discharged into coastal waters close to shellfish habitats, especially if local people are in the habit of eating raw shellfish.

Sludge treatment

The sludge from the sewage treatment plant requires anaerobic digestion to ensure thermal elimination of most pathogens. Alternatively, it may be dried in natural drying beds and then incinerated together with solid infectious health-care waste. On-site treatment of hospital sewage will produce a sludge that contains high concentrations of helminths and other pathogens.

Reuse of wastewater and sludges in agriculture and aquaculture

According to the relevant WHO guidelines (Mara & Cairncross, 1989), the treated wastewater should contain no more than one helminth egg per litre and no more than 1000 faecal coliforms per 100 ml if it is to be used for unrestricted irrigation. It is essential that the treated sludge contains no more than one helminth egg per kilogram and no more than 1000 faecal coliforms per 100 g. The sludge should be applied to fields in trenches and then covered with soil.

10.3 Options for establishments that apply minimal waste management programmes

10.3.1 Lagooning

In a region or an individual health-care establishment that cannot afford sewage treatment plants, a lagooning system is the minimal requirement for treatment of wastewater. The system should comprise two successive lagoons to achieve an acceptable level of purification of hospital sewage. Lagooning may be followed by infiltration of the effluent into the land, benefiting from the filtering capacity of the soil. There is no safe solution for the disposal of sewage from a hospital that cannot afford a compact sewage treatment plant and that has no space available to build a lagooning system.

10.3.2 Minimal safety requirements

For health-care establishments that apply minimal programmes and are unable to afford any sewage treatment, the following measures should be implemented to minimize health risks:

- Patients with enteric diseases should be isolated in wards where their excreta can be collected in buckets for chemical disinfection; this is of utmost importance in case of cholera outbreaks, for example, and strong disinfectants will be needed (see section 16.4.3).
- No chemicals or pharmaceuticals should be discharged into the sewer.
- Sludges from hospital cesspools should be dehydrated on natural drying beds and disinfected chemically (e.g. with sodium hypochlorite, chlorine gas, or preferably chlorine dioxide).
- Sewage from health-care establishments should never be used for agricultural or aquacultural purposes.
- Hospital sewage should not be discharged into natural water bodies that are used to irrigate fruit or vegetable crops, to produce drinking-water, or for recreational purposes.

Small-scale rural health-care establishments that apply minimal waste management programmes may discharge their wastewater to the environment. An acceptable solution would be natural filtration of the sewage through porous soils, but this must take place outside the catchment area of aquifers used to produce drinking-water or to supply water to the health-care establishment.

10.3.3 Sanitation

In many health-care establishments in developing countries, patients have no access to sanitation facilities. Excreta are usually disposed of in the environment, creating a high direct or indirect risk of infection to other people. Human excreta are the principal vehicle for the transmission and spread of a wide range of communicable diseases, and excreta from hospital patients may be expected to contain far higher concentrations of pathogens, and therefore to be far more infectious, than excreta from households. This underlines the prime importance of providing access to adequate sanitation in every health-care establishment, and of handling this issue with special care. The faecal–oral transmission route—and other routes such as penetration of the skin—must be interrupted to prevent continuous infection and reinfection of the population.

The health-care establishment should ideally be connected to a sewerage system. Where there are no sewerage systems, technically sound on-site sanitation should be provided. Guidance on this is available in a number of publications (Franceys, Pickford & Reed, 1992; WHO, 1996; Mara, 1996) which cover both simple techniques, such as the simple pit latrine, ventilated pit latrine, and pour-flush latrine, and the more advanced septic tank with soakaway or the aqua-privy. In temporary field hospitals during outbreaks of communicable diseases, other options such as chemical toilets may also be considered (Dunsmore, 1986). In addition, convenient washing facilities (with warm water and soap available) should be available for patients, personnel, and visitors in order to limit the spread of infectious diseases within the health-care establishment.

References and suggested further reading

- Dunsmore DJ (1986). *Safety measures for use in outbreaks of communicable diseases*. Geneva, World Health Organization.
- Franceys R, Pickford J, Reed R (1992). *A guide to the development of on-site sanitation*. Geneva, World Health Organization.
- Mara D (1996). *Low-cost urban sanitation*. Chichester, England, Wiley.
- Mara D, Cairncross S (1989). *Guidelines for the safe use of wastewater and excreta in agriculture and aquaculture*. Geneva, World Health Organization.
- WHO (1989). *Health guidelines for the use of wastewater in agriculture and aquaculture*. Report of a WHO Scientific Group. Geneva, World Health Organization (WHO Technical Report Series, No. 778).
- WHO (1996). *Fact sheets on environmental sanitation. Epidemic diarrhoeal diseases control*. Geneva, World Health Organization (unpublished document WHO/EOS/96.4, available on request from Division of Operation Support in Environmental Health, World Health Organization, 1211 Geneva 27, Switzerland).

11

Costs related to health-care waste management

11.1 Principles

According to the “polluter pays” principle, each health-care establishment should be financially liable for the safe management of any waste it generates. The costs of separate collection, appropriate packaging, and on-site handling are *internal* to the establishment and paid as labour and supplies costs; the costs of off-site transport, treatment, and final disposal are *external* and paid to the contractors who provide the service.

The costs of construction, operation, and maintenance of systems for managing health-care waste can represent a significant part of the overall budget of a hospital or health-care establishment. They should be covered by a specific allotment from the hospital budget. The total costs are generally made up of the elements listed in Box 11.1, all of which have to be carefully considered if the most cost-effective option is to be selected. Certain basic principles should always be respected in order to minimize these costs:

- Waste minimization, segregation, and recycling, as recommended in Chapters 6 and 7, can greatly reduce disposal costs. The benefits of producing less waste are evident, and segregation prevents the unnecessary treatment of general waste by the costly methods necessary for hazardous waste.
- Designing all elements of the system to be of adequate capacity will obviate the need for subsequent costly modifications.
- Future trends in waste production and the likelihood of legislation becoming more stringent should be foreseen.

The financial resources available from the public and private sectors will necessarily influence the choice of system and the standards of operations.

11.2 Methods of financing

Funds may come from the private sector or from one or more levels of government. For government-owned health-care establishments, the government may use general revenues to pay the cost of the waste management system. For private health-care establishments, the government may impose direct regulations, requiring them to implement their own waste management systems, compelling them to use public facilities, or allowing them the choice (as happens in the USA). These regulations may also impose limits on certain disposal options or specify the required treatment technology and standards of operation.

Over the past few years privatization has been increasingly adopted in a number of countries as an alternative method of financing various types

Box 11.1 Total costs of a waste management system

- Initial capital investment.
- Amortization over the effective life of plant and equipment.
- Operating costs for such elements as as labour and consumables.
- Utility requirements (fuel, electricity, water, etc.).
- Contractual and overhead costs.

of public works, including health-care waste management. Under such an arrangement a private entity finances, designs, builds, owns, and operates the treatment facilities and sells its collection and disposal services to government and private health-care establishments. It may be a desirable option, particularly for treatment methods other than incineration. The following are probably among the main reasons for considering privatization:

- inability of hospitals to raise the needed capital;
- expected greater efficiency in the private sector because of fewer constraints than in the public sector (e.g. greater flexibility in purchasing and personnel policies, allowing for more rapid adaptation to changing needs);
- transfer of responsibility for proper operation and maintenance to an organization with more resources for minimizing risk.

A disadvantage of privatization is the potential loss of overall control by the responsible public agency. It should be possible to minimize this by addressing the following issues in the agreement between the private operator and the public agency:

- minimum level of service, especially with regard to reliability, safety, public health risks, and future expansions;
- future increases in costs resulting from factors that cannot be fully assessed at the outset;
- environmental concerns;
- future transfer of ownership of the facilities;
- regular inspection and regulatory control.

The feasibility of cooperation between local health-care establishments should be explored as another means of minimizing costs.

11.3 Cost estimation

All hospitals need to establish accounting procedures to document the costs they incur in managing health-care waste. Accurate record-keeping and cost analysis must be undertaken by a designated individual. Health-care waste costs should be the subject of a separate budget line; this allows costs for different periods to be compared and helps to reduce management costs.

Box 11.2 Costs of construction and operation of a health-care waste incineration plant

Site

Cost of land
Rights of way
Site preparation and infrastructure
Provision of utilities to site

Consultancy fees

Environmental/waste management consultant
Engineering
Architectural
Legal fees

Construction costs

Incinerator building
Waste storage room
Offices

Incinerator

Cost of incinerator
Freight and storage charges

Waste transport costs

Waste collection trucks
Bins/containers for transporting waste from hospitals to incinerator site

Equipment costs

Trolleys for collecting waste bags from wards
Bag holders to be located at all sources of waste in hospitals
Weighing machines for weighing waste bags
Refrigerators for storage of waste if necessary

Financing charges

Interest
Taxes
Accounting and audit fees

Direct operating costs

Manpower requirements (manager, operators, drivers, . . .)
Yellow bags with tags for infectious wastes
Black bags for non-risk waste
Sharps containers
Transportation costs
Utilities (fuel, water, electricity)
Chemicals (for flue-gas cleaning)

Indirect operating costs

Training
Incinerator maintenance and parts replacement
Vehicle maintenance
Uniforms and safety equipment
Ash disposal cost
Compliance monitoring of flue-gas emissions
Project management and administrative costs for the organization responsible for the execution and long-term operation of the project

Box 11.2 lists the elements that should be included in the cost assessment for—in this example—a health-care waste management system comprising an incineration facility.

If a waste treatment project is undertaken by a private concern, charges for the service should be computed, so that all costs can be recovered from those using the services, i.e. both government and private health-care establishments. To ensure that the project is self-supporting, charges should reflect the full cost of operations, maintenance, depreciation, debt

amortization, and interest. The inclusion of an amortization factor ensures the availability of funds for future plant and equipment replacements. If the charges levied do not cover all costs, the system will need to be subsidized and a financing plan should be designed accordingly.

Examples of investment costs of various types and sizes of incinerators available in southern Asia are shown in Table 11.1, waste disposal costs of Hungarian health-care establishments in Table 11.2, and costs of different treatment methods in Switzerland in Table 11.3. Box 11.3 lists additional examples of cost components.

More details on approximate costs of pyrolytic incinerators are provided in Table 8.1 (page 84).

Table 11.1 Investment costs for incinerators, southern Asia^a

Capacity	Equipment	Costs (US\$)
50 kg/day	Manual loading, manual de-ashing, one combustion chamber, without flue-gas cleaning	20 000
100 kg/day	Manual loading and de-ashing, secondary combustion chamber (temperature >1000 °C, residence time >1 s), without flue-gas cleaning	200 000
100 kg/hour	Mechanical loading and de-ashing, secondary combustion chamber (temperature >1000 °C, residence time >1 s), without flue-gas cleaning	400 000
200 kg/hour	Automatic loading, mechanical de-ashing, secondary combustion chamber (temperature >1000 °C, residence time >1 s), with flue-gas cleaning	800 000
400 kg/hour	Automatic loading and de-ashing, secondary combustion chamber (temperature >1000 °C, residence time >2 s), with flue-gas cleaning and emission monitoring	1 700 000

^aSource: WHO (1994). *Regional guidelines for health care waste management in developing countries*. (Working document used at the WHO Regional Workshop on Clinical Waste Management, Kuala Lumpur, 28 November–2 December 1994.) Kuala Lumpur, World Health Organization Western Pacific Regional Environmental Health Centre.

Table 11.2 Examples of total health-care waste disposal costs, Hungary

Hospital	Beds	Treatment	Tonnes/year	Costs (US\$/tonne)
Hospital A	2196	On-site	110	55
Hospital B	350	On-site	20	73
Hospital C	300	Off-site	0.2	111
Hospital D	300	On-site	9	104
Hospital E	70	Off-site	4.5	100

Table 11.3 Examples of health-care waste treatment costs, Switzerland

Treatment method	Costs (US\$/tonne)
Pyrolytic incineration	380
Wet thermal disinfection	400
Chemical disinfection	200

Box 11.3 Examples of cost components of health-care waste management

Tunisia

- Cost of 1 hospital cleaner: US\$ 240–300 per month.

France

- Average cost of health-care waste management according to European Union quality standards: US\$ 1–3 per bed per day
- Personnel required: 1 cleaner per 30 beds, 1 waste operator per 175 beds
- All-inclusive personnel costs: US\$ 28 000 per operator per year
- Supplies costs:
 - plastic bags: US\$ 0.2–0.6 each
 - small sharps containers: US\$ 2 each.

11.4 Recommendations for cost reductions

Cost reductions can be achieved by taking particular measures at different stages in the management of wastes:

On-site management

- Comprehensive management of chemicals and pharmaceuticals stores.
- Substitution of disposable medical care items by recyclable items.
- Adequate segregation of waste to avoid costly or inadequate treatment of waste that does not require it.
- Improved waste identification to simplify segregation, treatment, and recycling.

Comprehensive planning

- Development and implementation of a comprehensive health-care waste management strategy, within the framework of the hospital waste management plan, which includes the above recommendations.
- Planning collection and transport in such a way that all operations are safe and cost-efficient.
- Possible cooperative use of regional incineration facilities, including private sector facilities where appropriate.
- Establishment of a wastewater disposal plan.

Documentation

- Waste management and cost documentation: assessment of the true costs makes it easier to identify priorities for cost reduction and to monitor progress in the achievement of objectives.

Choice of adequate treatment or disposal method

- Selection of a treatment and disposal option that is appropriate for waste type and local circumstances.
- Use of treatment equipment of appropriate type and capacity.

Measures at personnel level

- Establishment of training programmes for workers to improve the quality and quantity of work.
- Protection of workers against occupational risks.

12

Health and safety practices for health-care personnel and waste workers

12.1 Principles

Health-care waste management policies or plans should include provision for the continuous monitoring of workers' health and safety to ensure that correct handling, treatment, storage, and disposal procedures are being followed. Essential occupational health and safety measures include the following:

- proper training of workers;
- provision of equipment and clothing for personal protection;
- establishment of an effective occupational health programme that includes immunization, post-exposure prophylactic treatment, and medical surveillance.

Training in health and safety should ensure that workers know of and understand the potential risks associated with health-care waste, the value of immunization against viral hepatitis B, and the importance of consistent use of personal protection equipment.

Workers at risk include health-care providers, hospital cleaners, maintenance workers, operators of waste treatment equipment, and all operators involved in waste handling and disposal within and outside health-care establishments.

12.2 Workers' protection

The production, segregation, transportation, treatment, and disposal of health-care waste involve the handling of potentially hazardous material. Protection against personal injury is therefore essential for all workers who are at risk. The individuals responsible for management of health-care waste should ensure that all risks are identified and that suitable protection from those risks is provided.

A comprehensive risk assessment of all activities involved in health-care waste management, carried out during preparation of the waste management plan, will allow the identification of necessary protection measures. These measures should be designed to prevent exposure to hazardous materials or other risks, or at least to keep exposure within safe limits. Once the assessment is completed, personnel should receive suitable training (see Chapter 13).

12.2.1 Protective clothing

The type of protective clothing used will depend to an extent upon the risk associated with the health-care waste, but the following should be made available to all personnel who collect or handle health-care waste:

- Helmets, with or without visors—depending on the operation.
- Face masks—depending on operation.
- Eye protectors (safety goggles)—depending on operation.
- Overalls (coveralls)—obligatory.
- Industrial aprons—obligatory.
- Leg protectors and/or industrial boots—obligatory.
- Disposable gloves (medical staff) or heavy-duty gloves (waste workers)—obligatory.

Industrial boots and heavy-duty gloves are particularly important for waste workers. The thick soles of the boots offer protection in the storage area, as a precaution from spilled sharps, and where floors are slippery. If segregation is inadequate, needles or other sharp items may have been placed in plastic bags; such items may also pierce thin-walled or weak plastic containers. If it is likely that health-care waste bags will come into contact with workers' legs during handling, leg protectors may also need to be worn. An example of the protective clothing recommended in Thailand is shown in Fig. 12.1.

Operators of manually loaded incinerators should wear protective face visors and helmets. During ash and slag removal and other operations that create dust, dust masks should be provided for operators.

Fig. 12.1 *Recommended protective clothing for health-care waste transportation in small hospitals in Thailand^a*

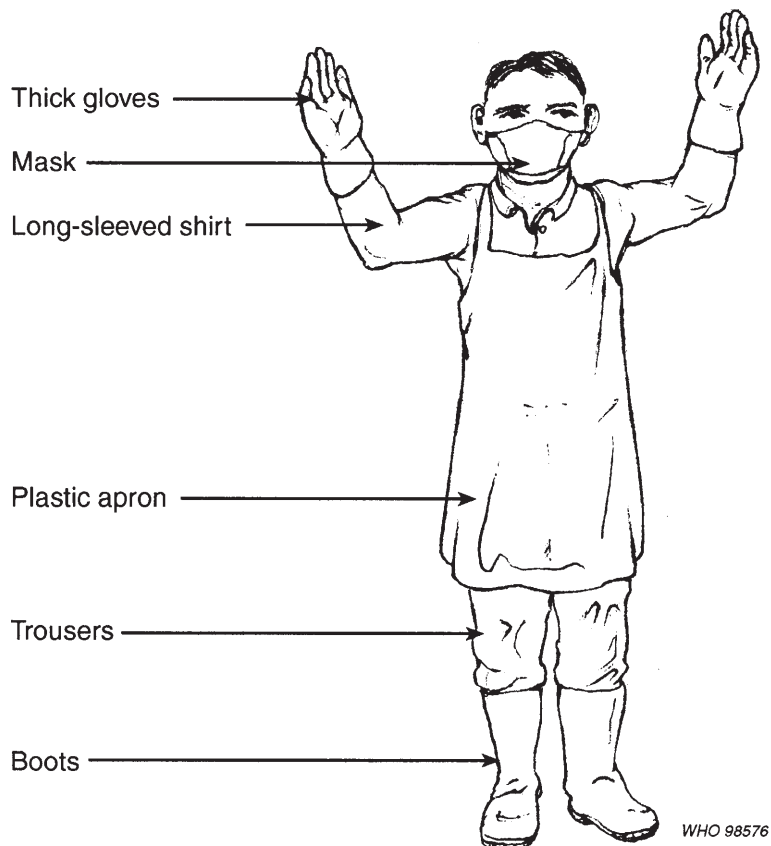

^aSource: *Handbook of hazardous healthcare waste management in 10-bed and 30-bed community hospitals, Thailand*. Bangkok. Ministry of Health, 1995; adapted with permission.

12.2.2 Personal hygiene

Basic personal hygiene is important for reducing the risks from handling health-care waste, and convenient washing facilities (with warm water and soap) should be available for personnel involved in the task. This is of particular importance at storage and incineration facilities.

12.2.3 Immunization

Viral hepatitis B infections have been reported among health-care personnel and waste handlers, and immunization against the disease is therefore recommended. Tetanus immunization is also recommended for all personnel handling waste.

12.2.4 Management practices

Many of the management practices recommended in Chapters 6 and 7 contribute to a reduction in risk for personnel who handle health-care waste; these are summarized as follows:

- *Waste segregation*: careful separation of different types of waste into different and distinct containers or bags defines the risk linked to each waste package.
- *Appropriate packaging*: prevents spillage of waste and protects workers from contact with waste.
- *Waste identification* (through distinct packaging and labelling): allows for easy recognition of the class of waste and of its source.
- *Appropriate waste storage*: limits the access to authorized individuals only, protects against infestation by insects and rodents, and prevents contamination of surrounding areas.
- *Appropriate transportation*: reduces risks of workers being exposed to waste.

12.2.5 Special precautions for clearing up spillages of potentially hazardous substances

For clearing up spillages of body fluids or other potentially hazardous substances, particularly if there is any risk of splashing, eye protectors and masks should be worn, in addition to gloves and overalls.

Respirators (gas masks) are also needed if an activity is particularly dangerous, for example if it involves toxic dusts, the clearance of incinerator residues, or the cleaning of contaminated equipment.

Residues should be recovered as completely as possible using hand tools (e.g. a shovel), and then packed safely. It is especially important to recover spilled droplets of metallic mercury. If a leakage or spillage involves infectious material, the floor should be cleaned and disinfected after most of the waste has been recovered.

12.2.6 Response to injury and exposure

A programme of response should be established that prescribes the actions to be taken in the event of injury or exposure to a hazardous substance. All staff who handle health-care waste should be trained to deal with injuries and exposures. The programme should include the following elements:

- immediate first-aid measures, such as cleansing of wounds and skin, and irrigation (splashing) of eyes with clean water;
- an immediate report of the incident to a designated responsible person;
- retention, if possible, of the item involved in the incident; details of its source for identification of possible infection;
- additional medical attention in an accident and emergency or occupational health department, as soon as possible;
- medical surveillance;
- blood or other tests if indicated;
- recording of the incident;
- investigation of the incident, and identification and implementation of remedial action to prevent similar incidents in the future.

In case of a needle stick injury, bleeding of the wound should be encouraged and the area should be washed under clean running water. The remaining elements of the accident response plan should then be followed.

The purpose of incident reporting should not be seen as punitive; active support by managers should encourage prompt and accurate reporting.

12.3 Cytotoxic safety

The senior pharmacist of the health-care establishment should be designated to ensure safe use of cytotoxic drugs. Large oncological hospitals may appoint a full-time Genotoxic Safety Officer, who should also supervise the safe management of cytotoxic waste. The following key measures are essential in minimizing exposure:

- written procedures that specify safe working methods for each process;
- data sheets, based on the supplier's specifications, to provide information on potential hazards;
- established procedure for emergency response in case of spillage or other occupational accident;
- appropriate education and training for all personnel involved in the handling of cytotoxic drugs.

These measures are unlikely to be needed in rural or urban district hospitals of middle- and low-income countries, which do not typically use genotoxic products, either cytotoxic or radioactive. In countries where the safe use of cytotoxic and radioactive materials is difficult to ensure, it may be advisable for use of those substances to be limited to a small number of specialized (e.g. oncological) hospitals, that are better able to implement appropriate safety measures.

In hospitals that do use cytotoxic products, specific guidelines on their safe handling should be established for the protection of personnel. These guidelines should include rules on the following waste handling procedures:

- separate collection of waste in leak-proof bags or containers, and labelling for identification;
- return of outdated drugs to suppliers;
- safe storage separately from other health-care waste;

- provisions for the disposal of contaminated material, for the decontamination of reusable equipment, and for the treatment of spillages;
- provisions for the treatment of infectious waste contaminated with cytotoxic products, including excreta from patients and disposable linen used for incontinent patients.

More information on the treatment and disposal of cytotoxic waste is given in section 9.3, and specific procedures to follow in case of spillages of, or contamination by, mutagenic and carcinogenic products are proposed in Annex 4.

Hospital staff should ensure that the families of patients undergoing chemotherapy at home are aware of the risks and know how they can be minimized or avoided.

Minimal protective measures for all waste workers who handle cytotoxic waste should include protective clothing, gloves, goggles, and masks.

References and suggested further reading

- American Society of Hospital Pharmacy (1983). *Procedures for handling cytotoxic and hazardous drugs*. Bethesda, MD.
- Canadian Society of Hospital Pharmacy (1981). *Guidelines for the handling of hazardous pharmaceuticals*. Toronto.
- Cass Y, Musgrave CF (1992). Guidelines for the safe handling of excreta contaminated by cytotoxic agents. *American journal of hospital pharmacy*, 49:1957–1958.
- Directorate of Labour Inspection (1980). *Guidelines concerning the handling of cytostatic agents*. Oslo, Norway.
- HMSO (1983). *Precautions for the safe handling of cytotoxic drugs*. London, Her Majesty's Stationery Office (Guidance Note MS 21).
- Irish Association for Nurses in Oncology (1990). *Guidelines for the safe handling and administration of cytotoxic drugs*. Dublin.
- Ladik CF, Stoehr GP, Maurer MA (1980). Precautionary measures in the preparation of antineoplastics. *American journal of hospital pharmacy*, 37:1184–1185.
- Ministry of Health (1995). *Handbook of hazardous healthcare waste management in 10-bed and 30-bed community hospitals, Thailand*. Bangkok.
- National Social Welfare Board, Department of Drugs (1978). *Instructions for handling and administering of cytostatics*. Stockholm.
- The Society of Hospital Pharmacists of Australia's Speciality Practice on Parenteral Services, Australia (1981). Guidelines for safe handling of cytotoxic drugs in pharmacy departments and hospital wards. *Hospital pharmacy*, 16:17–20.
- Yodaiken RE, Bennett D (1986). OSHA work-practice guidelines for personnel dealing with cytotoxic (antineoplastic) drugs. *American journal of hospital pharmacy*, 43:1193–1204.

13

Emergency response

13.1 Principles

One person should be designated as responsible for the handling of emergencies, including coordination of actions, reporting to managers and regulators, and liaising with emergency services, and a deputy should be appointed to act in case of absence.

In health-care establishments, spillage is probably the most common type of emergency involving infectious or other hazardous material or waste. Response procedures are essentially the same regardless of whether the spillage involves waste or material in use, and should ensure that:

- the waste management plan is respected;
- contaminated areas are cleaned and, if necessary, disinfected;
- exposure of workers is limited as much as possible during the clearing-up operation;
- the impact on patients, medical and other personnel, and the environment is as limited as possible.

Health-care personnel should be trained for emergency response, and the necessary equipment should be to hand and readily available at all times to ensure that all required measures can be implemented safely and rapidly. Written procedures for the different types of emergencies should be drawn up. For dangerous spills, the clean-up operation should be carried out by designated personnel specially trained for the purpose.

The response in the event of injury is outlined in section 12.2.

13.2 Dealing with spillages

Spillages usually require clean-up only of the contaminated area. For spillages of infectious material, however, it is important to determine the type of infectious agent; in some cases, immediate evacuation of the area may be necessary. In general, the more hazardous spillages occur in laboratories rather than in health-care departments.

Procedures for dealing with spillages should specify safe handling operations and appropriate protective clothing. An example of such a procedure is provided in Box 13.1. Appropriate equipment for collecting the waste and new containers should be available as should means for disinfection; Table 13.1 provides a typical list of required items.

In case of skin and eye contact with hazardous substances, there should be immediate decontamination. The exposed person should be removed from the area of the incident for decontamination, generally with copious amounts of water. Special attention should be paid to the eyes and any

Box 13.1 Example of general procedure for dealing with spillages^a

1. **Evacuate** the contaminated area.
2. **Decontaminate** the eyes and skin of exposed personnel immediately.
3. **Inform** the designated person (usually the Waste Management Officer), who should coordinate the necessary actions.
4. Determine the **nature** of the spill.
5. **Evacuate** all the people not involved in cleaning up if the spillage involves a particularly hazardous substance.
6. Provide **first aid** and medical care to injured individuals.
7. **Secure** the area to prevent exposure of additional individuals.
8. Provide adequate **protective clothing** to personnel involved in cleaning-up.
9. **Limit** the spread of the spill.
10. **Neutralize or disinfect** the spilled or contaminated material if indicated.
11. **Collect** all spilled and contaminated material. [**Sharps should never be picked up by hand**; brushes and pans or other suitable tools should be used.] Spilled material and disposable contaminated items used for cleaning should be placed in the appropriate waste bags or containers.
12. **Decontaminate or disinfect** the area, wiping up with absorbent cloth. The cloth (or other absorbent material) should never be turned during this process, because this will spread the contamination. The decontamination should be carried out by working from the least to the most contaminated part, with a change of cloth at each stage. Dry cloths should be used in the case of liquid spillage; for spillages of solids, cloth impregnated with water (acidic, basic, or neutral as appropriate) should be used.
13. **Rinse** the area, and wipe dry with absorbent cloth.
14. Decontaminate or disinfect any tools that were used.
15. Remove protective clothing and decontaminate or disinfect it if necessary.
16. **Seek medical attention** if exposure to hazardous material has occurred during the operation.

^a Adapted from: Reinhardt & Gordon (1991). *Infectious and medical waste*. Chelsea, MI, Lewis.

open wounds. In case of eye contact with corrosive chemicals, the eyes should be irrigated continuously with clean water for 10–30 minutes; the entire face should be washed in a basin, with the eyes being continuously opened and closed.

Table 13.1 *Example of a list of items for spillage cleaning^a*

Action	Tools or items
Approaching the spillage	Protective equipment (see section 12.2)
Containing the spillage	Absorbent material (e.g. absorbent paper, towels, gauze pads)
Neutralizing or disinfecting the spillage (if necessary)	For infectious material: disinfectant ^b For acids: sodium carbonate, calcium carbonate, or other base For bases: citric acid powder or other acid For cytotoxic material: special chemical degradation substances
Collecting the spillage	For liquids: absorbent paper, gauze pads, wood shavings, calcium bentonite, diatomaceous earth For solids: forceps, broom, dust pan or shovel Mercury: mercury sponge or vacuum pump
Containment for disposal	Plastic bag (red, yellow, or brown, as appropriate), sharps container
Decontamination or disinfection of the area	For infectious material: disinfectants ^b For hazardous chemicals: suitable solvent or water

^aAdapted from: Reinhardt & Gordon (1991). *Infectious and medical waste*. Chelsea, MI, Lewis.

^bSuch as bleaching powder, which is a mixture of calcium hydroxide, calcium chloride, and sodium hypochlorite, used in the powder form or in solution of varying dilution (1:1 to 1:100) depending on the nature of the spilled material.

Section 8.2 provides further details on dealing with spillages of strong disinfectants. Specific procedures for spills of, or contamination by, mutagenic and carcinogenic products are proposed in Annex 4.

13.3 Reporting accidents and incidents

All waste management staff should be trained in emergency response and made aware of the correct procedure for prompt reporting. Accidents or incidents, including near-misses, spillages, damaged containers, inappropriate segregation, and any incidents involving sharps should be reported to the Waste Management Officer (if waste is involved) or to another designated person. The report should include details of:

- the nature of the accident or incident;
- the place and time of the accident or incident;
- the staff who were directly involved;
- any other relevant circumstances.

The cause of the accident or incident should be investigated by the Waste Management Officer (in case of waste) or other responsible officer, who should also take all possible action to prevent recurrence. The records of the investigation and subsequent remedial measures should be kept.

14

Hospital hygiene and infection control

14.1 Objective

Management of health-care waste is an integral part of hospital hygiene and infection control. Health-care waste should be considered as a reservoir of pathogenic microorganisms, which can cause contamination and give rise to infection. If waste is inadequately managed, these microorganisms can be transmitted by direct contact, in the air, or by a variety of vectors. Infectious waste contributes in this way to the risk of nosocomial infections, putting the health of hospital personnel, and patients, at risk. The practices described in Chapters 6 to 10 of this handbook for the proper management of health-care waste should therefore be strictly followed as part of a comprehensive and systematic approach to hospital hygiene and infection control.

This chapter outlines the basic principles of prevention and control of the infections that may be acquired in health-care facilities (but does not address other aspects of hospital hygiene and safety such as pressure sores and the risk of falls). It should be stressed here that other environmental health considerations, such as adequate water-supply and sanitation facilities for patients, visitors, and health-care staff, are of prime importance.

14.2 Epidemiology of nosocomial infections

Nosocomial infections—known also as hospital-acquired infections, hospital-associated infections, and hospital infections—are infections that are not present in the patient at the time of admission to hospital but develop during the course of the stay in hospital. There are two forms:

- *Endogenous infection, self-infection, or auto-infection.* The causative agent of the infection is present in the patient at the time of admission to hospital but there are no signs of infection. The infection develops during the stay in hospital as a result of the patient's altered resistance.
- *Cross-contamination followed by cross-infection.* During the stay in hospital the patient comes into contact with new infective agents, becomes contaminated, and subsequently develops an infection.

While there is no clinically significant difference between the endogenous self-infection and the exogenous cross-infection, the distinction is important from the standpoint of epidemiology and prevention.

Healthy people are naturally contaminated. Faeces contain about 10^{13} bacteria per gram, and the number of microorganisms on skin varies between 100 and 10 000 per cm^2 . Many species of microorganisms live

on mucous membranes where they form a normal flora. None of these tissues, however, is infected. Microorganisms that penetrate the skin or the mucous membrane barrier reach subcutaneous tissue, muscles, bones, and body cavities (e.g. peritoneal cavity, pleural cavity, bladder), which are normally sterile (i.e. contain no detectable organisms). If a general or local reaction to this contamination develops, with clinical symptoms, there is an infection.

14.2.1 The transition from contamination to infection

Whether or not a tissue will develop an infection after contamination depends upon the interaction between the contaminating organisms and the host.

Healthy individuals have a normal *general resistance* to infection. Patients with underlying disease, newborn babies, and the elderly have less resistance and will probably develop an infection after contamination. Health-care workers are thus less likely to become infected than patients.

Local resistance of the tissue to infection also plays an important role: the skin and the mucous membranes act as barriers in contact with the environment. Infection may follow when these barriers are breached. Local resistance may also be overcome by the long-term presence of an irritant, such as a cannula or catheter; the likelihood of infection increases daily in a patient with an indwelling catheter.

The most important determinants of infection, however, are the nature and number of the contaminating organisms. Microorganisms range from the completely innocuous to the extremely pathogenic: the former will never cause an infection, even in immunocompromised individuals, while the latter will cause an infection in any case of contamination. A classification of conventional, conditional, and opportunistic pathogens is given in Box 14.1.

When only a few organisms are present on or in a tissue, an infection will not necessarily develop. However, when a critical number is exceeded, it is very likely that the tissue will become infected. For every type of microorganism, the *minimal infective dose* can be determined; this is the lowest number of bacteria, viruses, or fungi that cause the first clinical signs of infection in a healthy individual. For most causative agents of nosocomial infections, the minimal infective dose is relatively high. For *Klebsiella* and *Serratia* spp. and other Enterobacteriaceae, for example, it is more than 100 000, but for hepatitis B virus it is less than 10.

14.2.2 The sources of infection

In a health-care facility, the sources of infection, and of the preceding contamination, may be the personnel, the patients, or the inanimate environment.

The hospital environment can be contaminated with pathogens. *Salmonella* or *Shigella* spp., *Escherichia coli* O157:H7, or other pathogens may be present in the food and cause an outbreak of disease just as they can in a community outside the hospital. If the water distribution system breaks down, waterborne infections may develop. In more sophisticated premises the water cooling system of air conditioning equipment may

Box 14.1 Classification of pathogenic germs¹

Conventional pathogens

Cause disease in healthy individuals in the absence of specific immunity.

Examples:

Staphylococcus aureus, *Streptococcus pyogenes*, *Salmonella* spp., *Shigella* spp., *Corynebacterium diphtheriae*, *Mycobacterium tuberculosis*, *Bordetella pertussis*, hepatitis A and B viruses, rubella virus, rotaviruses, human immunodeficiency virus (HIV).

Conditional pathogens

Cause disease, other than trivial local infections, only in persons with reduced resistance to infection (including newborn infants) or when implanted directly into tissue or a normally sterile body area.

Examples:

Streptococcus agalactiae, *Enterococcus* spp., *Clostridium tetani*, *Escherichia coli*, *Klebsiella* spp., *Serratia marcescens*, *Acinetobacter baumannii*, *Pseudomonas aeruginosa*, *Candida* spp.

Opportunistic pathogens

Cause generalized disease, but only in patients with profoundly diminished resistance to infection.

Examples:

atypical mycobacteria, *Nocardia asteroides*, *Pneumocystis carinii*.

¹Source: Parker (1978).

become contaminated with *Legionella pneumophila*, causing Legionnaires' disease in susceptible patients. Pharmaceuticals may become contaminated during production or preparation; an outbreak of infection with, for example, *Pseudomonas aeruginosa*, *Burkholderia cepacia*, or *Serratia marcescens*, may occur as a consequence. In all these examples, it may be possible to isolate the same causative agent in several patients, which would suggest a common source. All possible measures should be taken to prevent the recurrence of such incidents.

The source of an outbreak of nosocomial infection may also be a health worker who is infected or colonized (a carrier). The symptoms of frank infection will make the potential of transmission apparent to the health worker and/or to managerial staff, and infected personnel are usually dismissed from patient care duties. A symptomless carrier, however, is contaminated or colonized by potentially pathogenic organisms but does not develop any infection. A typical example is *Staphylococcus aureus*, which may be carried in the nasal passages of 30–60% of personnel. Faecal carriage of enteropathogens such as *Salmonella* spp. also occurs frequently, but the prevalence varies according to the region. Other conventional pathogens that can be found in symptomless carriers include *Streptococcus pyogenes*, *Corynebacterium diphtheriae*, *Neisseria meningitidis*, hepatitis B virus, and cytomegalovirus. Contamination of patients by carriers can give rise to an outbreak of disease. Careful investigation and isolation of the same organisms from a cluster of patients should reveal the cause of the outbreak.

The source of most hospital epidemics is infected patients, i.e. patients contaminated with pathogenic microorganisms. These microorganisms are often released into the environment in very high numbers, exceeding the minimal infective dose, and contaminate other patients who subsequently develop hospital-acquired infections.

14.2.3 The routes of transmission

Microorganisms can be transmitted from their source to a new host through direct or indirect contact, in the air, or by vectors.

Vector-borne transmission is typical of countries in which insects, arthropods, and other parasites are widespread. These become contaminated by contact with excreta or secretions from an infected patient and transmit the infective organisms mechanically to other patients.

Airborne transmission occurs only with microorganisms that are dispersed into the air and that are characterized by a low minimal infective dose. Only a few bacteria and viruses are present in expired air, and these are dispersed in large numbers only as a result of sneezing or coughing.

Direct contact between patients does not usually occur in health-care facilities, but an infected health-care worker can touch a patient and directly transmit a large number of microorganisms to the new host.

The most frequent route of transmission, however, is indirect contact. The infected patient touches—and contaminates—an object, an instrument, or a surface. Subsequent contact between that item and another patient is likely to contaminate the second individual who may then develop an infection.

During general care and/or medical treatment, the hands of health-care workers often come into close contact with patients. The hands of the clinical personnel are thus the most frequent vehicles for nosocomial infections. Transmission by this route is much more common than vector-borne or airborne transmission or other forms of direct or indirect contact.

The spread of nosocomial infections is summarized and illustrated in Fig. 14.1.

14.3 The prevention of nosocomial infection

14.3.1 Principles

Two basic principles govern the main measures that should be taken in order to prevent the spread of nosocomial infections in health-care facilities:

- separate the infection source from the rest of the hospital;
- cut off any route of transmission.

The separation of the source has to be interpreted in a broad sense. It includes not only the isolation of infected patients but also all “aseptic techniques”—the measures that are intended to act as a barrier between

Fig. 14.1 The spread of nosocomial infections

Notes: Many of the listed diseases can spread by more than one route. The figure shows only a few of the many diseases that may be transmitted within a hospital setting.

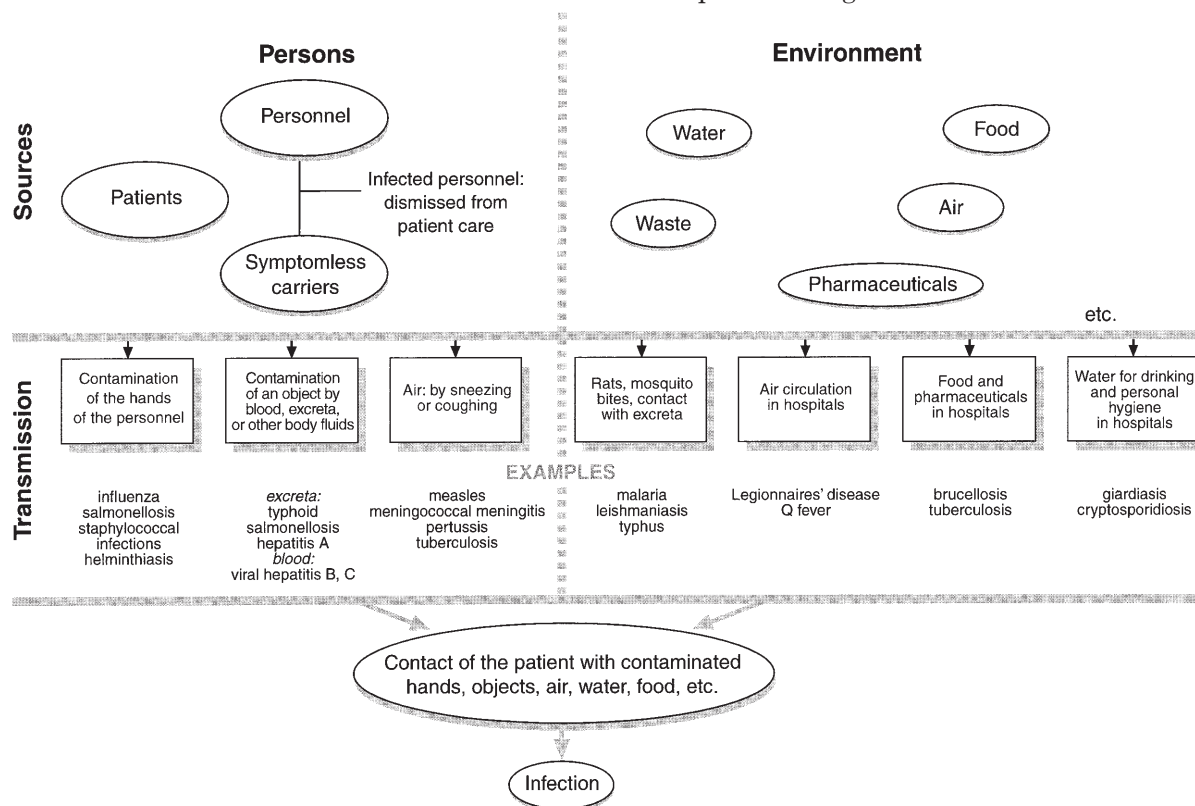

WHO 96632

infected or potentially contaminated tissue and the environment, including other patients and personnel.

In recent years, increasing attention has been paid to the protection of the personnel, in particular against the transmission of bloodborne infections, e.g. AIDS and viral hepatitis B and C. Preventive measures are known as “universal” or “standard” precautions.

It is impossible to avoid all contact with infected tissue or potentially contaminated body fluids, excreta, and secretions. Even when they are not touched with the bare hands, they may come in contact with instruments, containers, linen, etc. **All objects that come in contact with patients should be considered as potentially contaminated.** If an object is disposable, it should be discarded as waste. If it is reusable, transmission of infective agents must be prevented by cleaning, disinfection, or sterilization.

Despite the continuing concern of hospital managers and all attempts at improvement, many health-care establishments are unable to achieve adequate levels of prevention, particularly in developing countries. An international survey of the prevalence of hospital-acquired infections was conducted in 14 countries in different regions of the world between 1983 and 1985. The results of this survey, which covered 47 hospitals of size

ranging from 227 to 1502 beds (mean 614) showed a wide range of nosocomial infections, with prevalence varying from 3% to 21% (mean 8.4%) in individual hospitals. This work emphasizes the importance of the public health problem.

14.3.2 Isolation of infected patients and standard precautions

The first essential measure in preventing the spread of nosocomial infections is *isolation* of infected patients. The term isolation covers a broad domain of measures. The strictest form of isolation is applied in case of very infectious diseases (e.g. haemorrhagic fever, diphtheria); less stringent precautions can be taken in case of diseases such as tuberculosis, other respiratory infections, and infectious diarrhoea. Isolation of any degree is expensive, labour-intensive, and usually inconvenient or uncomfortable for both patients and health-care personnel; its implementation should therefore be adapted to the severity of the disease and to the causative agent. Disease-specific precautions should include details of all the measures (private room, wearing of masks or gowns, etc.) to be taken in the case of a specific disease caused by a defined organism.

The so-called standard precautions, summarized in Box 14.2, essentially protect health-care workers from bloodborne infections caused by human immunodeficiency virus and hepatitis B and C viruses.

14.3.3 Cleaning

One of the most basic measures for the maintenance of hygiene, and one that is particularly important in the hospital environment, is cleaning. The principal aim of cleaning is to remove visible dirt. It is essentially a mechanical process: the dirt is dissolved by water, diluted until it is no longer visible, and rinsed off. Soaps and detergents act as solubility-promoting agents. The microbiological effect of cleaning is also essentially mechanical: bacteria and other microorganisms are suspended in the cleaning fluid and removed from the surface. The efficacy of the cleaning process depends completely on this mechanical action, since neither soap nor detergents possess any antimicrobial activity. Thorough cleaning will remove more than 90% of microorganisms. However, careless and superficial cleaning is much less effective; it is even possible that it has a negative effect, by dispersing the microorganisms over a greater surface and increasing the chance that they may contaminate other objects. Cleaning has therefore to be carried out in a standardized manner or, better, by automated means that will guarantee an adequate level of cleanliness.

Diluting and removing the dirt also removes the breeding-ground or culture medium for bacteria and fungi. Most non-sporulating bacteria and viruses survive only when they are protected by dirt or a film of organic matter; otherwise they dry out and die. Non-sporulating bacteria are unlikely to survive on clean surfaces.

The effectiveness of disinfection and sterilization is increased by prior or simultaneous cleaning.

14.3.4 Sterilization

Self-evidently, an object should be sterile, i.e. free of microorganisms, after sterilization. However, sterilization is never absolute; by definition,

Box 14.2 Essentials of the standard precautions to be used in the care of all patients

A. Hand washing

- Wash hands after touching blood, secretions, excretions and contaminated items, whether or not gloves are worn. Wash hands immediately after gloves are removed, between patient contacts.
- Use a plain soap for routine hand washing.
- Use an antimicrobial agent for specific circumstances.

B. Gloves

- Wear gloves when touching blood, body fluids, secretions, excretions, and contaminated items. Put on clean gloves just before touching mucous membranes and non-intact skin.

C. Mask, eye protection, face shield

- Wear a mask and eye protection or a face shield during procedures and patient-care activities that are likely to generate splashes or sprays of blood, body fluids, secretions, and excretions.

D. Gown

- Wear a gown during procedures and patient-care activities that are likely to generate splashes or sprays of blood, body fluids, secretions, or excretions.

E. Patient-care equipment

- Ensure that reusable equipment is not used for the care of another patient until it has been cleaned and reprocessed appropriately.

F. Environmental control

- Ensure that the hospital has adequate procedures for the routine care, cleaning, and disinfection of environmental surfaces.

G. Linen

- Handle used linen, soiled with blood, body fluids, secretions, and excretions in a manner that prevents skin and mucous membrane exposures, and that avoids transfer of microorganisms to other patients and environments.

H. Occupational health and bloodborne pathogens

- Take care to prevent injuries when using needles, scalpels, and other sharp instruments or devices.
- Use ventilation devices as an alternative to mouth-to-mouth resuscitation methods.

I. Place of care of the patient

- Place a patient who contaminates the environment or who does not assist in maintaining appropriate hygiene in an isolated (or separate) room.

it effects a reduction in the number of microorganisms by a factor of more than 10^6 (i.e. more than 99.9999% are killed). Standard reference works, such as pharmacopoeias, often state that no more than one out of 1 000 000 sterilized items may still bear microorganisms. It is therefore important to minimize the level of contamination of the material to be

sterilized. This is done by sterilizing only objects that are clean (free of visible dirt) and applying the principles of good manufacturing practice.

Sterilization can be achieved by both physical and chemical means. Physical methods are based on the action of heat (autoclaving, dry thermal or wet thermal sterilization), on irradiation (γ -irradiation), or on mechanical separation by filtration. Chemical means include gas sterilization with ethylene oxide or other gases, and immersion in a disinfectant solution with sterilizing properties (e.g. glutaraldehyde).

14.3.5 *Disinfection*

The term disinfection is difficult to define, as the activity of a disinfectant process can vary widely. The guidelines of the Centers for Disease Control (Garner & Favero, 1986) allow the following distinction to be made:

- *High-level disinfection*: can be expected to destroy all microorganisms, with the exception of large numbers of bacterial spores.
- *Intermediate disinfection*: inactivates *Mycobacterium tuberculosis*, vegetative bacteria, most viruses, and most fungi; does not necessarily kill bacterial spores.
- *Low-level disinfection*: can kill most bacteria, some viruses, and some fungi; cannot be relied on to kill resistant microorganisms such as tubercle bacilli or bacterial spores.

There is no ideal disinfectant and the best compromise should be chosen according to the situation. A disinfectant solution is considered appropriate when the compromise between the antimicrobial activity and the toxicity of the product is satisfactory for the given application. Another consideration may well be the cost. The more active disinfectants are automatically the more toxic ones; potentially toxic products can be applied to inanimate objects or surfaces, whereas for disinfection of human tissues only the less toxic disinfectants can be considered. For antisepsis, different disinfectants are used for application to the intact skin (e.g. alcoholic solutions) and to mucous membranes or wounds (only aqueous solutions of non-toxic substances). Cost is a less important consideration for an antiseptic than for a disinfectant.

The principal requirements for a good antiseptic are absence of toxicity and rapid and adequate activity on both the natural flora and, especially, pathogenic bacteria and other microorganisms after a very short exposure time. Essential requirements for a disinfectant are somewhat different: there must be adequate activity against bacteria, fungi, and viruses that may be present in large numbers and protected by dirt or organic matter. In addition, since disinfectants are applied in large quantities, they should be of low ecotoxicity.

In general, use of the chosen disinfectant, at the appropriate concentration and for the appropriate time, should kill pathogenic microorganisms, rendering an object safe for use in a patient, or human tissue free of pathogens to exclude cross-contamination.

An overview of the characteristics of the main groups of disinfectants is given in Table 14.1.

Table 14.1 *Characteristics of the main disinfectant groups*

Disinfectants	Bactericidal activity	Tuberculocidal activity	Fungicidal activity	Virucidal activity	Sporicidal activity	Local human toxicity	Applications
Alcohol	Very active	Very active	Very active	Very active	Not active	Moderate	<ul style="list-style-type: none"> • Skin antisepsis • Disinfection of small surfaces
Chlorhexidine	Less active against Gram-negative bacilli	Not active	Less active	Not active	Not active	Low	<ul style="list-style-type: none"> • Skin and wound antisepsis
Chlorine compounds (chloramine, hypochlorite)	Very active	Active	Active	Very active	Less active	Moderate	<ul style="list-style-type: none"> • Skin and wound antisepsis • Water treatment • Surface disinfection
Formaldehyde	Very active	Very active	Very active	Very active	Less active	High	<ul style="list-style-type: none"> • Disinfection of inanimate objects and surfaces
Glutaraldehyde	Very active	Very active	Very active	Very active	Very active	High	<ul style="list-style-type: none"> • Disinfection of inanimate objects
Hydrogen peroxide	Less active against staphylococci and enterococci	Active	Active	Active	Less active	Low	<ul style="list-style-type: none"> • Wound antisepsis
Iodophore	Active	Active	Less active	Active	Not active	Moderate	<ul style="list-style-type: none"> • Skin and wound antisepsis
Peracetic acid	Very active	Active	Active	Active	Active	High	<ul style="list-style-type: none"> • Disinfection of inanimate objects
Phenolic compounds	Very active	Very active	Very active	Less active	Not active	High	<ul style="list-style-type: none"> • Disinfection of inanimate objects and surfaces
Quaternary ammonium compounds	Less active against Gram-negative bacilli	Not active	Less active	Less active	Not active	Low	<ul style="list-style-type: none"> • In combination with other compounds

14.3.6 Hand hygiene

As the hands of health-care workers are the most frequent vehicle of nosocomial infections, hand hygiene—including both hand washing and hand disinfection—is the primary preventive measure.

Thorough hand washing with adequate quantities of water and soap removes more than 90% of the transient, i.e. superficial, flora including all or most contaminants. An antimicrobial soap will further reduce the transient flora, but only if used for several minutes. Hand washing with (non-medicated) soap is essential when hands are dirty and should be routine after physical contact with a patient.

Killing *all* transient flora with all contaminants within a short time (a few seconds) necessitates hygienic hand disinfection: *only alcohol or alcoholic preparations act sufficiently fast*. Hands should be disinfected with alcohol when an infected tissue or body fluid is touched without gloves.

Table 14.2 *The main forms of hand hygiene*

Technique	Main purpose	Influence on hand flora	Agents	Rapidity of action	Residual effect
Social hand washing	Cleansing	Reduces transient flora	Non-medicated soap	Slow	Short
Careful hand washing	Cleansing after patient contact	Partly removes transient flora	Non-medicated soap	Slow	Short
Hygienic hand disinfection	Disinfection after contamination	Kills transient flora	Alcohol	Fast	Short
Surgical hand disinfection	Preoperative disinfection	Kills transient flora and inhibits resident flora	Antibacterial soap, alcoholic solutions	Slow (soap) or fast (alcohol)	Long

During a surgical intervention, a high proportion of gloves becomes perforated. Hands should therefore be disinfected with a long-acting disinfectant before gloves are put on. This will not only kill all the transient flora, but will also prevent the microorganisms of the resident (or deeper) flora from taking the place of the transient flora during the intervention. For this purpose, hands should be washed for 5–10 minutes with an antibacterial detergent containing chlorhexidine or an iodophore, or rubbed twice for 2 minutes with an alcoholic solution of one of these antiseptics.

An overview of the main forms of hand hygiene is given in Table 14.2.

References and suggested further reading

- Ayliffe GAJ et al. (1992). *Control of hospital infection. A practical handbook*, 3rd ed. London, Chapman & Hall.
- Beck EG, Schmidt P (1986). *Hygiene im Krankenhaus und Praxis. [Hygiene in the hospital and in medical practice.]* Berlin, Springer.
- Block SS (1991). *Disinfection, sterilization, and preservation*, 4th ed. Philadelphia, Lea & Febiger.
- Daschner F (1997). *Praktische Krankenhaushygiene und Umweltschutz*, 2 Aufl. [Practical hospital hygiene and protection of the environment, 2nd ed.] Berlin, Springer.
- Garner JS (1996). Guideline for isolation precautions in hospitals. The Hospital Infection Control Practices Advisory Committee. *Infection control and hospital epidemiology*, 17:53–80.
- Garner JS, Favero MS (1986). CDC Guideline for handwashing and hospital environmental control. *Infection control*, 7:231–243.
- Garner JS, Simmons BP (1983). CDC Guideline for isolation precautions in hospitals. *Infection control*, 4:245–325.
- Mayhall CG (1996). *Hospital epidemiology and infection control*. Baltimore, MD, Williams & Wilkins.
- Mehtar S (1992). *Hospital infection control. Setting up with minimal resources*. Oxford, Oxford Medical.
- Parker MT (1978). *Hospital-acquired infections: guidelines to laboratory methods*. Copenhagen, World Health Organization Regional Office for Europe (European Series, No. 4).
- Philpott-Howard JN, Casewell MM (1994). *Hospital infection control. Policies and practical procedures*. London, Saunders.

- Russell AD, Hugo WB, Ayliffe GAJ (1992). *Principles and practice of disinfection, preservation and sterilization*, 2nd ed. Oxford, Blackwell.
- Rutala A (1995). *Chemical germicides in health care*. Morin Heights, Canada, Polyscience.
- Steuer W (1992). *Hygiene in der ärztlichen Praxis. [Hygiene in medical practice.]* Stuttgart, Fischer.
- Thofern E, Botzenhart K (1983). *Hygiene und Infektion im Krankenhaus. [Hygiene and infection in the hospital.]* Stuttgart, Fischer.
- Wenzel RP (1997). *Prevention and control of nosocomial infections*, 3rd ed. Baltimore, MD, Williams & Wilkins.

15

Training

15.1 Public education on hazards linked to health-care waste

Promotion of the appropriate handling and disposal of medical waste is important for community health, and every member of the community should have the right to be informed about potential health hazards. The objectives of public education on health-care waste are the following:

- *To prevent exposure* to health-care waste and related health hazards; this exposure may be voluntary, in the case of scavengers, or accidental, as a consequence of unsafe disposal methods.
- *To create awareness and foster responsibility* among hospital patients and visitors to health-care establishments regarding hygiene and health-care waste management.
- *To inform the public* about the risks linked to health-care waste, focusing on people living or working in close proximity to, or visiting, health-care establishments, families of patients treated at home, and scavengers on waste dumps.

The following methods can be considered for public education on risks, waste segregation, or waste disposal practices:

- Poster exhibitions on health-care waste issues, including the risks involved in scavenging discarded syringes and hypodermic needles.
- Explanation by the staff of health-care establishments to incoming patients and visitors on waste management policy. This may be difficult to achieve, in which case the distribution of leaflets should be considered.
- Information poster exhibitions in hospitals, at strategic points such as waste bin locations, giving instructions on waste segregation. Posters should be explicit, using diagrams and illustrations to convey the message to as broad an audience as possible, including illiterate people.

For maximum effectiveness, all information should be displayed or communicated in an attractive manner that will hold people's attention.

In the health-care establishment, waste bins should be easily accessible for patients and visitors and should be clearly marked with the waste category for which they are intended.

Growing awareness of health and environmental hazards has greatly increased public demand for information and guidance on these issues. Demand has intensified as the prevalence of HIV/AIDS and viral hepatitis B has risen. Health-care establishments should set an example to society by managing their waste in a manner designed to protect health and the environment.

15.2 Education and training of health-care personnel

15.2.1 Principles

Aim

A policy for the management of health-care waste cannot be effective unless it is applied carefully, consistently, and universally. Training health-care personnel in implementing the policy is thus critical if a waste management programme is to be successful. The overall aim of training is to develop awareness of the health, safety, and environmental issues relating to health-care waste, and how these can affect employees in their daily work. It should highlight the roles and responsibilities of health-care personnel in the overall management programme. Health and safety at the workplace and environmental awareness are the responsibility of all and in the interests of all.

Employees to be trained

All hospital personnel, including senior medical doctors, should be convinced of the need for a comprehensive health-care waste management policy and the related training, and of its value for the health and safety of all. This should ensure their collaboration in the implementation of such a policy.

Separate training activities should be designed for, and targeted to, four main categories of personnel:

- hospital managers and administrative staff responsible for implementing regulations on health-care waste management;
- medical doctors;
- nurses and assistant nurses;
- cleaners, porters, auxiliary staff, and waste handlers.

Since action is needed at management level, by those producing the waste as well as by the waste handlers, training of all of these categories of personnel is equally important.

Medical doctors may be educated through senior staff workshops and general hospital staff through formal seminars. The training of waste managers and regulators, however, could take place outside the hospitals, at public health schools or in university departments.

Content

Staff education programmes should include:

- information on, and justification for, all aspects of the health-care waste policy;
- information on the role and responsibilities of each hospital staff member in implementing the policy;
- technical instructions, relevant for the target group, on the application of waste management practices.

One of the best ways of learning is through practice, and hands-on training of small groups of personnel should be considered where appropriate. Testing the participants at the end of the course, by means of simple true/false or multiple-choice questions, often provides an incentive for learning, and allows the course organizers to assess the knowledge acquired by participants.

The instructors should have experience in teaching and training, and be familiar with the hazards and practices of health-care waste management; ideally, they should also have experience in waste handling.

Follow-up and refresher courses

Periodic repetition of courses will provide refreshment training as well as orientation for new employees and for existing employees with new responsibilities; it will also update knowledge in line with policy changes. Follow-up training is instructive for trainers, indicating how much information has been retained by course participants and the likely need for future refresher courses.

Training responsibility

The Infection Control Officer (ICO) should be given responsibility for all training related to the segregation, collection, storage, and disposal of health-care waste. He or she should ensure that staff at all levels are aware both of the hospital waste management plan and policy and of their own responsibilities and obligations in this regard. A record should be kept of all training sessions, and the content of training programmes should be periodically reviewed and updated where necessary.

For similar training of those concerned with smaller sources of health-care waste, the regional health authority may be able to make centralized arrangements for courses.

15.2.2 Implementing a training course

The training package

A training package could be developed by the national government agency responsible for the disposal of health-care wastes or by an international or development agency. The package should be suitable for various types of health-care establishments, including government, private, teaching, and dental hospitals, polyclinics, health centres, health-care research institutions, and clinical laboratories. It would also be useful for more general educational establishments and for organizations that provide services for health-care waste disposal.

The package should be liberally illustrated with drawings, diagrams, photographs, slides, or overhead transparencies. These should reflect the environments in which trainees work and provide examples of measures that have been (or will be) implemented. Where it is likely that waste handlers and other workers are illiterate, all procedures should be carefully represented in diagrams and photographs.

Selection of participants

The ideal number of participants in a training course is 20–30; larger groups may make effective discussions and exercises difficult. Courses should be aimed at all categories of personnel; discussions may be easier and more useful if the group is composed of trainees from various disciplines (e.g. supervisors, medical and nursing staff, laboratory staff, engineers, ancillary staff) or at least contains one or two medical assistants and nurses. It may also be valuable to include senior administration staff and heads of departments in certain training groups to demonstrate their commitment to the waste management policy and to show the relevance of the policy to all personnel of health-care establishments.

Box 15.1 Training and waste segregation

All staff who produce health-care waste should be responsible for its segregation, and should therefore receive training in the basic principles and practical applications of segregation. Waste is generated by a large number of personnel, many of whom are directly involved with care of patients, often in conditions of urgency; management of the waste generated in such circumstances may thus seem to be of little importance. Training should make staff aware of the potentially serious implications of the mismanagement of waste for the health of waste handlers and patients, provide them with an overall view of the fate of waste after collection and removal from the ward, and teach them the importance of proper segregation of the different categories of waste.

Line managers may find it worthwhile to run the training sessions themselves, for their own personnel.

Training recommendations: health-care personnel

The training course should provide an overview of the waste management policy and underlying rationale and information on practices relevant to the targeted group of trainees. For personnel who provide health-care, waste segregation is a key element in their training in waste management (see Box 15.1).

In addition to the practices outlined in the various chapters of this book, which may form the basis for the course, the following precautions should be emphasized:

- The greatest care should be taken if needles have to be removed from syringes.
- In no case should any attempt be made to correct segregation mistakes by removing items from a bag or container or by placing one bag into another of a different colour.
- Hazardous and general waste should not be mixed. If the two are accidentally mixed, the entire mixture should be treated as hazardous health-care waste.
- Nursing and clinical staff should ensure that adequate numbers of bag holders and containers are provided for the collection, and subsequent on-site storage, of health-care waste—in the wards, clinics, operating theatres, and other areas where waste is generated. These receptacles should be located as close to the common sources of waste as possible.

Training recommendations: waste handlers

Again, relevant chapters of this book may form the basis for a training course. Topics covered may include the waste management policy, health hazards, on-site transportation, storage, safety practices, and emergency response. Among staff who routinely handle health-care waste, awareness of the need for safety may decrease with time, which will increase the risk of injury. Periodic refresher training is therefore recommended.

Points that should be stressed in the training of waste handlers are summarized in Box 15.2.

Box 15.2 Training of waste handlers

- Check that waste storage bags and containers are sealed; no bags should be removed unless properly labelled and securely sealed to prevent spillages.
- Bags should be picked up by the neck only. They should be put down in such a way that they can again be picked up by the neck for further handling. Manual handling of waste bags should be minimized whenever possible.
- Waste bags should not touch the body during handling and collectors should not attempt to carry too many bags at one time—probably no more than two.
- When moving of waste bags or containers is complete, the seal should again be checked to ensure that it is unbroken.
- To avoid puncture or other damage, waste bags should not be thrown or dropped.
- Sharps may occasionally puncture the side or bottom of a polypropylene container; the container should therefore be carried by its handle and should not be supported underneath with the free hand.
- Bags for hazardous health-care waste and for general waste should not be mixed, but segregated throughout handling; hazardous waste should be placed only in specified storage areas.
- Appropriate cleaning and disinfection procedures should be followed in the event of accidental spillage; any such incident should be reported immediately to the responsible member of staff.
- Adequate protective clothing should be worn during all waste handling operations.

15.3 Training of health-care waste management operators

The minimal training for waste management operators should include:

- information on the risks associated with the handling of health-care waste;
- procedures for dealing with spillages and other accidents;
- instructions on the use of protective clothing.

The training needs will obviously depend on the type of operations the operators perform, but may well include specific topics such as operation of incinerators and waste transportation.

15.3.1 Training for staff who transport waste

The health-care establishment itself may carry out the transportation of waste, or it may contract this operation to an “authorized” waste transporter. Drivers and waste handlers should be aware of the nature and risks of the transported waste. In particular, transport staff should be

trained in the procedures listed below. They should be able to carry out all procedures in accordance with the instructions, without help from others.

- Correct procedures for handling, loading, and unloading waste bags and containers.
- Procedures for dealing with spillages or other accidents; written instructions for these procedures should be available in the transport vehicle.
- The wearing of protective clothing and strong footwear at all times.
- The availability at all times in dedicated waste collection vehicles of spare plastic bags, protective clothing, and the cleaning tools and disinfectants needed to deal with any spillage that occurs during loading, transport, or unloading.
- Documentation and recording of health-care waste, e.g. by means of a consignment note system, to allow waste to be traced from the point of collection to the final place of disposal.

The head of the health-care establishment should liaise with the transport contractor to ensure that members of the waste collection crew are well trained. Untrained personnel should never be allowed to handle hazardous health-care waste.

15.3.2 Training of treatment plant operators

Qualified operators are needed for incinerators and other treatment facilities. If no qualified operators are available, health-care establishments should arrange to train an adequate number of personnel.

Treatment plant operators should have received technical education to at least secondary school level, and should be specifically trained in the following areas:

- general functioning of the treatment facility, including heat recovery and flue-gas cleaning technologies, where appropriate;
- health, safety, and environmental implications of treatment operations;
- technical procedures for operation of the plant;
- emergency response, in case of equipment failures and alarms for example;
- maintenance of the plant and record-keeping;
- surveillance of the quality of ash and emissions, according to the specifications.

Further details for the training of treatment plant operators are given in in Box 15.3.

15.3.3 Training of landfill operators

In many middle- and lower-income countries, “safe burying” will continue to be used for the disposal of health-care waste until there is sufficient capacity for incineration or other disinfection. The training of landfill operators is important for limiting the risks associated with buried health-care waste, in relation to both scavenging and the quality of groundwater. Landfill operators should therefore be trained in the following issues:

Box 15.3 Issues to address in training treatment plant operators

Waste handling

- Procedures for receiving, handling, and storage of health-care waste.
- Loading of waste into the treatment unit.

Operation of the plant

- Operation of the plant equipment, including start-up and shut-down procedures.
- Operation and testing of control, alarm, and instrumentation systems; corrections where necessary.
- Optimum operating temperatures, pressures, concentrations of emissions, speeds, flows, etc., and maintenance of correct conditions.
- Detection of defects or malfunctions (following written procedures) and servicing.
- Safe removal of residues and ashes.

Maintenance

- Daily, weekly, monthly, semi-annual, and annual tests, inspection, cleaning, lubrication, replacement and replenishment of consumables (e.g. thermocouples), and overhaul, with special attention to major components of the installation; appropriate action when necessary.

Safety measures and emergency response

- Use of protective equipment; personal hygiene.
- Fire precautions.
- Procedures for emergency response, including manual operation of the plant under emergency conditions; dealing with spillages, accidents, and other incidents.
- Contingency plans for implementation during breakdown or planned maintenance.

Administrative procedures

- Licence conditions and regulations governing emissions.
- Record-keeping.
- Reporting of spillages, accidents, and other incidents.

- health risks related to health-care waste;
- hazards related to the sorting of this type of waste, which should *not* be practised either by the landfill operators or by other people;
- minimizing the handling of health-care waste by drivers or site operators;
- use of protective equipment, and personal hygiene;
- safe procedures for landfilling the wastes;
- procedures for emergency response.

16

Minimal programmes for health-care waste management

This chapter summarizes the waste management practices recommended in this handbook and selects the options that are especially suitable for use by establishments that apply minimal programmes or in emergency situations. Typically, these situations include smaller rural health-care establishments or field hospitals, e.g. in refugee camps. The selected practices should ensure that health and safety requirements are met and an acceptable level of hazard protection is achieved. However, the recommendations should not be viewed as a substitute for the longer-term aim of establishing the more rigorous managerial procedures described elsewhere in this handbook.

Implementation of the recommendations should be incremental, i.e. achieved through gradual improvements, but it is of paramount importance that municipal authorities and managers of health-care establishments are made fully aware of the need for proper waste management procedures.

The first step would be the introduction of waste segregation: too often, health-care establishments treat hazardous health-care waste in the same manner as general waste. Separation of sharps may be a good starting point. Specific methods for the disposal of hazardous health-care wastes can then be introduced, followed by efforts to encourage waste minimization and the safe reuse of materials wherever possible.

16.1 Basic principles

The total absence of management measures to prevent exposure to hazardous health-care waste results in the maximum health risk to the general public, patients, health-care personnel, and waste workers. It is therefore emphasized that even very limited waste management measures can dramatically reduce this risk.

Effective confinement of waste and safe handling measures provide significant health protection. For example, burning hazardous health-care waste in open trenches or small furnaces is better than uncontrolled dumping; reducing the amount of hazardous waste by segregation is better than accumulating large quantities; good stock management of chemicals and pharmaceuticals not only reduces waste quantities but also saves purchase costs; proper identification of waste packages warns health-care personnel and waste handlers about their contents. All these measures to reduce risk are relatively simple and cheap and should be considered by any health-care establishment. The principle of “doing something is better than doing nothing” is important and underlies any effort to initiate a system for the management of health-care waste.

Fig. 16.1 Basic steps in health-care waste management in minimal programmes

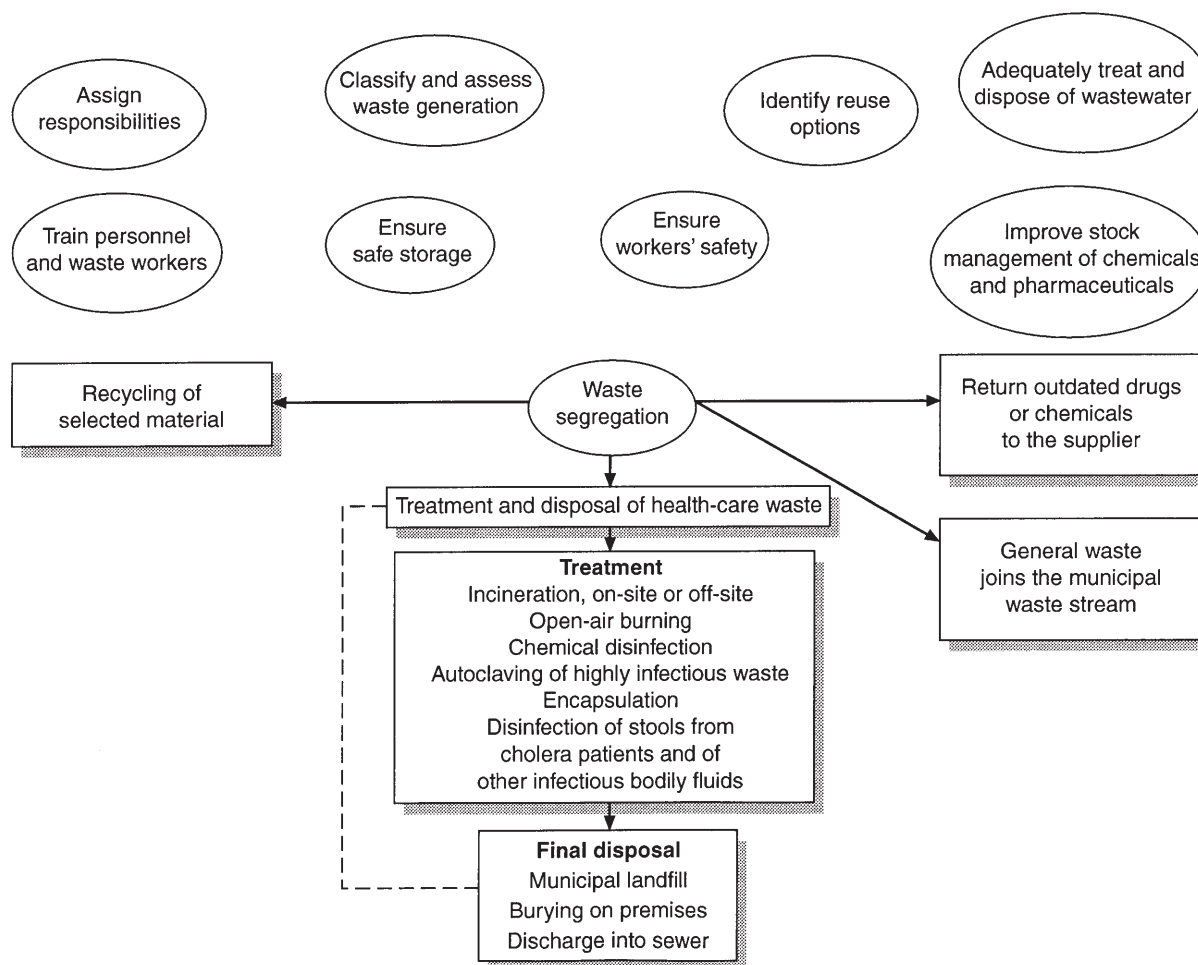

The basic elements of minimal programmes of health-care waste management are represented schematically in Fig. 16.1. At the local level, the following basic actions should be taken:

- assessment (quantitative and qualitative) of waste production;
- evaluation of local treatment and disposal options;
- segregation of health-care waste from general (or municipal) waste;
- establishment of internal rules for waste handling (storage, colour coding, collection frequency, etc.);
- assignment of responsibilities within the health-care establishment;
- choice of suitable—or better—treatment and disposal options.

16.2 Health-care waste segregation

16.2.1 The waste categories

Three categories of health-care waste are recognized:

- General (non-risk) waste, including uncontaminated waste similar to domestic waste; may represent about 80% of the total waste production from health-care establishments.
- Hazardous health-care waste.
- Highly hazardous health-care waste.

Hazardous health-care waste includes:

- “Usual” infectious waste, excluding sharps but including anatomical or pathological waste, and waste contaminated with human blood or other body fluids, excreta, and vomit. This category typically makes up about 75% of the hazardous health-care waste, or around 15% of the total waste, produced by health-care establishments.
- Chemical and pharmaceutical residues, e.g. cans, bottles, or boxes containing such residues, and small quantities of outdated products.
- Non-recyclable and discarded pressurized containers, which are hazardous only if burned as they may explode. Many undamaged containers may be refilled.

Highly hazardous health-care waste, which should be given special attention, includes:

- Sharps, especially hypodermic needles.
- Highly infectious non-sharp waste, including microbial cultures, carcasses of inoculated laboratory animals, highly infectious physiological fluids, pathological and anatomical waste.
- Stools from cholera patients or body fluids of patients with other highly infectious diseases.
- Bulk quantities of outdated hazardous chemicals, such as strong disinfectants, or significant quantities of waste containing mercury.
- Genotoxic waste, e.g. radioactive or cytotoxic waste, typically used in cancer chemotherapy but not in district hospitals. If minimal waste management programmes are being applied, genotoxic substances should not be used in general hospitals, but may be used in the oncological departments of university hospitals.

16.2.2 Segregation and packaging

Careful segregation and separate collection of hospital waste may be somewhat onerous for hospital personnel but it is the key to safe, sound management of health-care waste. Segregation can substantially reduce the quantity of health-care waste that requires specialized treatment. To make separate collection possible, hospital personnel at all levels, especially nurses, support staff, and cleaners, should be trained to sort the waste they produce.

In any area that produces hazardous waste—hospital wards, treatment rooms, operating theatres, laboratories, etc.—three bins plus a separate sharps container will be needed. Recommendations for the segregation of waste are given in Table 16.1. The following important points should be noted:

- If hazardous and highly hazardous wastes are to be disposed of in the same way, they should not be collected separately.
- In a health-care establishment using genotoxic products, the safety procedures applicable to radioactive or genotoxic products should be enforced.
- If sharps are to be encapsulated, it is convenient to collect them directly in the metallic drums or barrels used for encapsulation, which limits the hazards associated with handling.
- For hazardous waste and highly hazardous waste the use of double packaging, e.g. a plastic bag inside a holder or container is recommended for ease of cleaning.

Table 16.1 *Segregation of health-care waste*

Waste		Receptacle		
Category	Description	Type	Colour and markings	Characteristics
Hazardous	Non-sharp infectious waste; some pharmaceutical and chemical residues	Container, or plastic bag in a holder	Yellow	Leak-proof
Highly hazardous	Highly infectious non-sharp waste	Container, or plastic bag in a holder	Yellow, marked HIGHLY INFECTIOUS	Leak-proof, suitable for autoclaving
Sharps	Sharps	Sealable box or drum or cardboard box	Yellow, marked SHARPS	Puncture-proof, leak-proof
General	Similar to municipal waste, not contaminated by hazardous substances	Plastic bag or container	Black	No special requirements

- Stools of cholera patients should be collected in buckets because of the need for disinfection. Discharge to sewers or to the environment may contribute to the spread of the disease.

Selection of appropriate packaging is difficult in establishments that cannot afford disposable plastic bags or containers. In such circumstances, hazardous waste may also be collected in paper bags, inside a container that will not be removed. Plastic or metal containers for hazardous waste should be disinfected, for example with sodium hypochlorite (bleach), before reuse. The bags should be sealed or containers firmly closed before they are filled to three-quarters of their capacity. The equipment should be simple, robust and locally available.

16.2.3 *Safe handling and storage*

Hospital cleaning personnel should be informed about the potential risks posed by waste handling. They should be trained in safe handling procedures and should wear protective aprons and gloves.

The waste should be collected daily. General waste may be stored in convenient places that facilitate collection by the municipal service, but hazardous health-care waste should be stored in a closed room. Waste should not be stored close to patients or where food is prepared. Infectious waste should be disposed of within the following periods:

temperate climate: maximum 72 hours in winter
 maximum 48 hours in summer

warm climate: maximum 48 hours during the cool season
 maximum 24 hours during the hot season

Before containers of hazardous health-care waste are loaded on to a truck for transport off site, they should be sealed. Waste bags and containers should also be labelled with the address of the producer and the waste category. For safety reasons, however, it is strongly recommended that establishments applying minimal waste management programmes in

areas without adequate treatment facilities should dispose of hazardous health-care waste within their own premises.

16.3 Minimization and safe recycling of health-care waste

16.3.1 Chemicals and pharmaceuticals

Careful and comprehensive management of stores will substantially reduce the quantities of chemical and/or pharmaceutical waste produced by health-care establishments. Ideally, the waste in these categories should be limited to residues of chemical or pharmaceutical products in their original packaging (bottles, boxes, cans, etc.). Waste minimization will also give rise to financial savings.

Proper management of chemical or pharmaceutical stores will be supervised by the Chief Pharmacist of the health-care establishment and should include the practices listed in Box 16.1.

16.3.2 Pressurized containers

Aerosol cans are not generally recyclable and may be disposed of to landfills together with general waste. Many undamaged pressurized gas containers, however, may be easily recycled, and should be returned to their original supplier for refilling. Pressurized containers must never be incinerated as they may explode, causing injury to workers and/or damage to equipment.

16.3.3 Mercury

Metallic mercury is a valuable product. In case of a spill, e.g. from a broken thermometer, all droplets of mercury should be recovered with a spoon for later sale or reuse.

16.3.4 Recyclable sharps

Hospitals with very limited resources should use recyclable sharps, such as glass syringes with needles, and scalpels. Only items that are designed for reuse, i.e. that withstand the sterilization process, should be recycled

Box 16.1 Management of chemicals and pharmaceuticals for waste minimization

- Frequent ordering of relatively small quantities rather than large amounts at one time; this applies particularly to unstable products.
- Use of the oldest batch of a product before newer batches.
- Use of *all* the contents of each box or bottle.
- Prevention of product wastage, e.g. in wards and during cleaning procedures.
- Checking the expiry date of any product at the time of delivery.

in this way. Before reuse, scalpels, syringes, needles, and other sharps must be thoroughly cleaned and sterilized; disinfection alone is inadequate. Any failure in the sterilization process may result in the transmission of severe infections. Sterilization may be by chemical means, by flame exposure, or by autoclaving. Smaller district hospitals that lack autoclave facilities may consider sending items to the closest general hospital for sterilization.

16.4 Treatment and disposal of hazardous health-care waste

For health-care establishments with few resources and applying minimal waste management programmes, affordable treatment and disposal methods for hazardous and highly hazardous waste may be classified into three categories:

- thermal processes
- chemical processes
- containment processes.

16.4.1 Thermal processes

Static-grate single-chamber incineration

Waste may be burned in a simple furnace, with a static grate and natural air flow. De-ashing, loading, and unloading operations are carried out manually. The low heating value of properly segregated health-care waste is high enough for combustion, but addition of a small quantity of kerosene may be needed to start the fire and blowing of air may also help in establishing optimal combustion. The burning efficiency may reach 90–95%, i.e. 5–10% of the material may remain unburnt in the ashes and slags. The operating temperature will be around 300°C, which will kill most microorganisms but will be insufficient to destroy thermally resistant chemicals or pharmaceuticals.

Advantages

- Good disinfection efficiency.
- Drastic reduction of waste; the weight and volume of residual ashes and slags are about 20% those of the original waste. The residues may then be landfilled.
- No requirement for highly qualified operators.
- Relatively low investment and operation costs.

Drawbacks

- Generation of significant emissions containing atmospheric pollutants, including flue gases and fly ash; may produce odours (which can be limited by not incinerating halogenated plastics).
- Periodic removal of slag and soot necessary.
- Inefficiency in destruction of thermally resistant chemicals and drugs (e.g. cytotoxics).

Drum or brick incinerators

Where a single-chamber incinerator is not affordable or available, simple confined burning may be applied. A steel drum or walls of bricks or concrete can be erected over a screen or fine grate and covered with a second screen to prevent dispersion of ashes or light material. The waste is placed inside and burned with the help of manual ventilation and addition of kerosene if necessary. Constant supervision is essential to

prevent any spread of the fire to the surrounding area. The combustion efficiency may reach 80–90% and kill 99% of microorganisms. The temperature of the fire will not exceed 200 °C, and this process should be used only in emergency situations or when other treatment methods cannot be implemented.

Advantages

- Drastic reduction of weight and volume of the waste.
- Very low investment and operating costs.

Drawbacks

- Relatively poor destruction efficiency.
- No destruction of many chemicals and pharmaceuticals.
- Massive emission of black smoke, particulates, and toxic flue gases.

Open-air burning

Open-air burning of infectious waste (excluding pathological waste) should be carried out only as a last resort, in rural dispensaries, isolated health posts, or emergency situations. If possible, the burning should take place in the pit of final disposal (i.e. where the residues will be buried), and the process should be supervised by the person responsible for waste management in the health-care facility. It should be performed downwind of, and as far as possible from, the facility or other communities. The area within which the burning is carried out should be fenced to prevent unauthorized persons and animals from entering.

Confined burning, e.g. in a drum incinerator, should always be preferred, as the risk to personnel of contact with the waste or with partly burned residues is lower. The advantages and drawbacks of open-air burning are the same as for drum or brick incinerators, but there is the additional disadvantage that burning may be incomplete and non-uniform.

16.4.2 Wet thermal disinfection

Wet thermal disinfection is based on exposure of shredded infectious waste to high-temperature, high-pressure steam. Shredded waste is introduced into a reacting tank, vacuum conditions are established, and steam is introduced. Precise operating procedures have to be followed by qualified technicians for efficient disinfection. Wet thermal disinfection should be considered only by health-care establishments with sufficient technical and financial resources and where incineration in single-chamber or drum/brick incinerators is unacceptable, for example because of air pollution problems.

Advantages

- Environmentally sound.
- Reduction in waste volume.
- Relatively low investment and operation costs.

Drawbacks

- Shredders subject to breakdown and poor functioning (and are thus the weak point of the process).
- Qualified operators essential.
- Inadequate for anatomical, pharmaceutical, and chemical waste, and waste that is not easily penetrated by steam.

Autoclaving

Autoclaving is an efficient wet thermal disinfection process. Typically, autoclaves are used in hospitals for the sterilization of recyclable items, and these units allow for the treatment of only limited quantities of waste. They are therefore generally used only for highly infectious waste, such as microbial cultures and sharps. Even a general hospital with very limited resources should be equipped with an autoclave, but a district hospital may well not have one. The advantages and drawbacks of the autoclave are similar to those of wet thermal processes.

Advantages

- Efficient.
- Environmentally sound.
- Relatively low investment and operation costs.

Drawbacks

- Qualified operators essential.
- Inadequate for anatomical, pharmaceutical, and chemical waste, and waste that is not easily penetrated by steam.
- The hospital autoclave used for sterilization has capacity for treatment of only limited quantity of waste.

16.4.3 Chemical disinfection

Chemical disinfection is an efficient process, but costly if the prices of disinfectants are high. For safe operation it requires trained technicians provided with adequate protective equipment and is therefore not recommended for treating all infectious health-care waste. However, the process can be useful in specific cases, such as disinfection of recyclable sharps or disinfection of stools from cholera patients.

Chemical sterilization of recyclable sharps

Chemical sterilization of scalpels, syringes with needles, and other recyclable sharps may be considered as an alternative or complementary method to thermal sterilization. After thorough cleaning and drying, the sharps are placed in a tank and exposed to a strong disinfecting gas or liquid, such as ethylene oxide, formaldehyde, or glutaraldehyde.

Advantage

- Highly efficient (may be more efficient than thermal sterilization).

Drawbacks

- Trained operators essential.
- Costly if the chemical disinfectants are expensive.
- Uses hazardous substances that necessitate safety measures.

Chemical disinfection of stools from cholera patients

Vibrio cholerae, the causative agent of cholera, is not very resistant and its elimination does not require the use of very strong chemical disinfectants. Buckets containing stools of patients with acute diarrhoea may be disinfected through addition of chlorine oxide powder or dehydrated lime oxide (CaO). Other liquid or powder disinfectants may also be used. In case of a cholera epidemic, hospital sewage must also be treated and disinfected. Where there is sufficient space, sewage may be treated through lagooning, followed by effluent disinfection with sodium hypochlorite. In cholera epidemics in emergency situations these disinfection

measures should also be applied in field hospitals to prevent the spread of the disease.

Advantages

- Efficient disinfection.
- No need for highly trained operators.

Drawback

- Not significant compared with the benefits.

16.4.4 Containment processes

Landfilling in municipal disposal sites

Waste may be landfilled in municipal disposal sites if it cannot be treated before disposal. However, health-care waste should not be deposited or scattered on the surface of open dumps. If landfilling is planned, the following minimal requirements should be met:

- measures established by a municipal authority for the rational and organized deposit of municipal wastes that could be used to dispose of health-care wastes;
- if possible, engineering work instigated by the municipal authority to prepare the disposal site to retain wastes more effectively;
- rapid burial of the health-care waste, so that human or animal contact is as limited as possible.

In addition, it is recommended that health-care waste is deposited in one of the following two ways:

- in a shallow hollow excavated in the mature municipal waste, in the layer below the base of the working face, where it is immediately covered by a 2-m layer of fresh municipal waste; scavenging in this part of the site must be prevented.
- in a deeper pit (1–2 m) excavated in mature municipal waste (at least 3 months since being landfilled) which is then backfilled with the mature waste that was dug out; again, scavenging in this part of the site must be prevented.

Alternatively, a specially constructed small burial pit could be prepared to receive health-care waste only. The pit can be 2 m deep and filled to a depth of 1 m. Each load of waste should be covered with a soil layer 10–15 cm deep. (Lime may be placed over the waste if coverage with soil is not possible.) In case of a disease outbreak involving especially virulent pathogens (such as the Ebola virus), both lime and soil cover may be added. Access to this area should be restricted and closely supervised by the responsible staff to prevent scavenging. An example of dedicated pit design is shown in Fig. 8.12 (page 109).

Before health-care wastes are sent for land disposal, it is prudent to inspect the proposed landfill site to ensure that there is satisfactory control of waste deposition.

Advantages

- Low costs.
- Relatively safe if access is restricted and the site is selected according to the above conditions.

- Effective biodegradation of the biological components of health-care waste if landfill operations are properly carried out.

Drawbacks

- Access restrictions may not always be guaranteed.
- It may be difficult to assess whether the conditions for safe landfill are being met.

Safe burying inside premises

In certain health-care establishments in remote locations, temporary refugee camps, and areas experiencing exceptional hardship, safe burial of wastes on hospital premises may be the only rational option available at times. The design and operation of the burial pit is as described above and illustrated in Fig. 8.12 (page 109). To limit risks to health and of environmental pollution, some basic rules should be applied:

- Access to the disposal site should be restricted to authorized personnel only.
- The burial boundary should be lined with a material of low permeability (e.g. clay), if available.
- Only hazardous health-care waste should be buried.
- Large quantities (over 1 kg) of chemical wastes should not be buried at the same time; burial should be spread over several days.
- The burial site should be managed in the same way as a landfill, with each layer of waste being covered with a layer of earth to prevent development of odours and infestation by rodents and insects.

The safety of waste burial relies critically on operational practices. Safe on-site burial is practicable for only relatively limited periods of time, e.g. 1–2 years, and for relatively small quantities of waste, say up to 5–10 tonnes in total. Where these limits are exceeded, a longer-term solution, involving treatment of the waste or disposal at a municipal solid waste landfill, will need to be found.

Advantages

- Less hazardous than letting waste accumulate and remain accessible.
- Low costs.

Drawbacks

- Risks of pollution in permeable soils if the waste becomes saturated with water.
- It may be difficult to prevent scavenging at all times.

Encapsulation

Encapsulation is recommended as the easiest technology for the safe disposal of sharps. Sharps are collected in puncture-proof and leak-proof containers, such as high-density polyethylene boxes, metallic drums, or barrels. When a container is three-quarters full, a material such as cement mortar, bituminous sand, plastic foam, or clay is poured in until the container is completely filled. After this material has dried, the container is sealed and may be landfilled, stored, or buried inside the hospital premises. It is also possible to encapsulate chemical or pharmaceutical residues together with sharps.

Advantages

- Simple and safe.
- Low costs.
- Also applicable to chemicals and pharmaceuticals.

Drawback

- Not recommended for non-sharp infectious waste.

16.5 Management of hazardous health-care waste by waste categories

16.5.1 Infectious waste and sharps

Most treatment methods outlined in section 16.4 above are suitable for infectious waste and sharps, except that:

- in the wet thermal process, shredding of sharps is problematic;
- encapsulation is not suitable for infectious waste.

Incineration in single-chamber incinerators should be the method of choice in establishments that apply minimal waste management programmes. Highly infectious waste, such as cultures and stocks of infectious agents from laboratory work, should be sterilized by wet thermal treatment (e.g. autoclaving) at the earliest stage, i.e. inside the health-care establishment, and soon after production, if possible. For other infectious health-care waste, disinfection to reduce microbial concentration is sufficient.

Sharps should also be incinerated whenever possible and can be incinerated together with other infectious waste. Encapsulation is also suitable for disposing of sharps.

Blood should be disinfected before discharge to the sewer (unless there is an adequate wastewater treatment plant) or may be incinerated.

After incineration or other disinfection process, residues may be landfilled.

16.5.2 Pharmaceutical waste

Sound management of pharmaceutical products, with a view to waste minimization (see section 16.2), is of prime importance. Small quantities of chemical or pharmaceutical waste can be disposed of easily and relatively cheaply, but large amounts may require special, more costly treatment, such as high-temperature incineration. Comprehensive management of pharmaceutical stores should be supervised by the Chief Pharmacist of the health-care establishment.

Small quantities of pharmaceutical waste are usually collected in yellow containers together with infectious waste and therefore follow the same disposal pathway, being either incinerated or safely buried. It should be noted, however, that temperatures reached in a single-chamber furnace may be insufficient to disintegrate thermally resistant pharmaceuticals. Small quantities of pharmaceutical waste, such as outdated drugs (except cytotoxics and antibiotics), may also be discharged to the sewer but should not be discharged into natural waters (rivers, lakes, etc.).

Significant quantities of pharmaceutical waste may be disposed of by the following methods:

- Incineration (if an incinerator able to reach a combustion temperature of 800 °C is available); the incineration residues may be landfilled.
- Discharge to the sewer. Water-soluble, relatively mild pharmaceutical mixtures, such as vitamin solutions, cough syrups, intravenous solutions, eye drops, etc., may be diluted with large amounts of water and then discharged to sewers (where sewerage systems exist). This process should *not* be used for antibiotics.
- Encapsulation. When incineration is not feasible and water dispersion is not recommended, pharmaceutical waste should be encapsulated.
- Return to the original supplier if possible.

Note: Cytotoxic drug residues and other cytotoxic waste should *never* be mixed with other pharmaceutical waste, but should be processed separately according to the procedure described in this handbook (section 9.3).

16.5.3 Chemical waste

As for pharmaceutical waste, improved management of chemical waste starts with waste minimization efforts. The proper management of chemical stores will be supervised by the Chief Pharmacist of the health-care establishment (see section 16.3).

The hospital's Infection Control Officer, Chief Hygienist, or Chief Pharmacist should be designated to supervise the use of chemicals throughout the health-care establishment. The main users of chemical disinfectants, which are among the most hazardous chemicals used in the establishment, are likely to be the Infection Control Officer/Chief Hygienist and his or her staff.

Small quantities of chemical waste will include residues of chemicals in their packaging, outdated or decomposed chemicals, or chemicals that are no longer required. These are generally collected in yellow containers, together with infectious waste, and follow the same disposal pathway (either incineration or safe burying).

Large quantities of chemical waste should *not* be collected in yellow plastic bags or containers. There is no safe and cheap method for their disposal; the treatment options are the following:

- Incineration under subcontract by a public or private agency equipped for the safe disposal of hazardous chemical waste. The thermal reactivity of the waste should be checked; certain solvents will burn and can therefore be incinerated in simple incineration units, although it must be remembered that those containing halogens could cause air pollution.
- Return to the original supplier (if the supplier has facilities for safe disposal). In this case, appropriate provisions should be included in the original purchase contract for chemicals.
- Exportation to a country with the expertise and facilities to dispose safely of hazardous chemical waste. Shipment of chemical waste should comply with international agreements, such as the Basel Convention and the United Nations *Recommendations on the transport of dangerous goods*.

All three options are costly and may be unpracticable, which makes it particularly crucial that chemical waste is minimized. The following recommendations should also be observed:

- Hazardous chemical wastes of different nature should never be mixed.
- Hazardous chemical waste should not be disposed of in sewer systems.
- Large amounts of chemical waste should not be buried as they may contaminate groundwater.
- Large amounts of chemical disinfectants should not be encapsulated as they are corrosive and sometimes flammable.

16.5.4 Cytotoxic waste

Cytotoxic drugs are highly hazardous to the health of the individual and to the environment. Recommendations on cytotoxic safety may be found in section 12.3. Disposal options, described in section 9.3, are the following:

- Return to the original supplier.
- Incineration at high temperatures, e.g. in rotary kilns or high-performance double-chamber pyrolytic incinerators (if available).
- Chemical degradation.

The following recommendations should also be observed:

- Residues from cytotoxic drugs or other cytotoxic waste should never be mixed with other pharmaceutical waste.
- Cytotoxic waste should never be discharged into natural water bodies or landfilled.

In countries where the above disposal procedures are not feasible, use of cytotoxic and radioactive products should be restricted to university research and teaching hospitals.

16.5.5 Radioactive waste

For safety reasons, medical use of radioactive isotopes should be restricted to university hospitals, and any hospital that uses radioactive products should appoint a qualified Radiation Officer. The rules for safe management of radioactive waste outlined in section 9.7 of this handbook should be enforced.

16.5.6 Pressurized containers

Undamaged pressurized containers should be returned to the supplier for refilling, and adequate provision for this should be included in the original purchase contracts. If return is not possible, containers may be buried safely. Any residual pressure should be released before disposal. Aerosol containers cannot usually be refilled and should be buried. Pressurized containers should never be burned or incinerated because of the severe risk of explosion.

16.5.7 Used batteries and thermometers

Batteries, thermometers, and various items of measuring equipment may have a high metal content, including toxic heavy metals such as mercury or cadmium. Disposal options are as follows:

- Recycling by specialized cottage industries. This is the best disposal solution when available.
- Exportation to a country with the expertise and facilities to dispose safely of hazardous chemical waste. Conditions of shipment should comply with the Basel Convention.
- Encapsulation. If neither of the two options above is feasible, encapsulated waste may be disposed of in an impermeable landfill (if available) or other landfill.

This type of waste should not be incinerated because of the toxic metallic vapours emitted, nor should it be buried without encapsulation as this may cause pollution of groundwater.

However, if the quantities of wastes with high heavy-metal content are minimal (similar to the quantities in municipal waste) and there are no opportunities for reuse of heavy metals within the country, they may also join the municipal waste stream.

16.6 Workers' training and safety at work

In health-care establishments and regions that operate minimal management programmes, the health and safety practices described in Chapter 12 and the training outlined in Chapter 15 should be implemented. This is of particular importance, since minimal programmes of waste management are likely to result in greater risks of exposure for workers than the more comprehensive managerial methods described in this handbook.

For personnel who handle wastes, including hospital cleaners and technicians, training in safety measures should cover the following issues:

- packing, handling, and storing of hazardous health-care waste;
- the need to wear protective gloves and aprons when handling waste containers;
- operation of on-site treatment and disposal methods, such as single-chamber furnace operations, encapsulation, and safe burying.

Technicians in charge of chemical disinfection should be trained to implement appropriate safety precautions and emergency measures and be informed about chemical hazards. Nurses and cleaning personnel should be made aware of the occupational risks linked to handling of sharps.

References and suggested further reading

Christen J (1996). *Dar es Salaam Urban Health Project. Health care waste management in district facilities: situational analysis and system development*. St Gallen, Switzerland, Swiss Centre for Development Cooperation in Technology and Management (SKAT).

WHO. *Guidelines for drug disposal after emergencies*. Geneva, World Health Organization (unpublished document, in preparation; will be available from Department of Essential Drugs and other Medicines, World Health Organization 1211 Geneva 27, Switzerland).



Glossary of terms used in the book

The definitions given in this glossary refer to the use of terms in this book and are not necessarily valid in other contexts.

- activity** Disintegration of an amount of a radionuclide in a particular energy state at a given time per time interval at a given time.
- antineoplastic** Inhibiting or preventing the development of neoplasms.
- antisepsis** Prevention of infection by inhibiting the growth of infectious agents.
- calorific value** *See* heating value.
- capacity** The quantity of solid waste that can be processed in a given time under certain specified conditions, usually expressed in terms of mass per 24 hours.
- characterization** The determination of the physical and chemical and—for radioactive waste—radiological properties of waste, or of other features, to establish the need for further adjustment, treatment, or conditioning, or suitability for further handling, processing, storage, or disposal.
- clearance levels** (in the context of radioactive waste management) A set of values established by the regulatory authority and expressed in terms of activity concentrations and/or total activities, at or below which sources of radiation can be released from regulatory control.
- conditioning** Operations that produce a package suitable for handling, transportation, storage, and/or disposal.
- container** Vessel in which waste is placed for handling, transportation, storage, and/or eventual disposal. The waste container is a component of the waste package.
- cytostatic** Causing suppression of growth and multiplication of cells.
- cytotoxic** Possessing a specific destructive action on certain cells; used in particular in referring to the lysis (disintegration or dissolution) of cells brought about by immune phenomena and to antineoplastic drugs that selectively kill dividing cells.
- decontamination** Reduction of microbiological contamination to a safe level.
- disinfectant** Chemical agent that is able to reduce the viability of microorganisms.

disinfection	Treatment aimed at reducing the number of vegetative microorganisms to safe or relatively safe levels. (See section 14.3.5 for more comprehensive information.)
disposal	<p>Intentional burial, deposit, discharge, dumping, placing, or release of any waste material into or on any air, land, or water.</p> <p>In the context of radioactive waste management, disposal means the emplacement of waste in an approved, specified facility (e.g. near surface or geological repository) or the approved direct discharge of effluents into the environment. Disposal is undertaken without the intention of retrieval.</p>
exempt waste (in the context of radioactive waste management)	Waste that is released from nuclear regulatory control in accordance with clearance levels because the associated radiological hazards are negligible. The designation should be used in terms of activity concentration and/or total activity and may include a specification of the type, chemical/physical form, mass, or volume of waste, and its potential use.
flue gas (or exhaust gas)	Gases and suspended particles emitted from an industrial stack or chimney.
furnace	The chamber of the incinerator into which the refuse is charged for subsequent ignition and burning.
genotoxic	Descriptive of a substance that is capable of interacting directly with genetic material, causing DNA damage that can be assayed. The term may refer to carcinogenic, mutagenic, or teratogenic substances.
groundwater	The water contained in porous underground strata as a result of infiltration from the surface.
handling	The functions associated with the movement of solid waste materials, excluding storage, processing, and ultimate disposal.
hazard	<p>Intrinsic potential property or ability (e.g. of any agent, equipment, material, or process) to cause harm.</p> <p><i>Note:</i> Harm is an injury or damage to health of people and/or to the environment.</p>
heating value (or calorific value)	The quantity of heat that is produced when the unit mass of a material undergoes complete combustion under certain specified conditions. For solids, it is expressed in terms of calories or joules per kilogram (kcal/kg, kJ/kg, MJ/kg, etc.). The <i>high heating value</i> includes the specific enthalpy of vaporization, whereas the <i>low heating value</i> omits it.
incineration	The controlled burning of solid, liquid, or gaseous combustible wastes to produce gases and residues containing little or no combustible material.
leachate	Liquid from a landfill containing substances that were present in the waste, either as liquids or as solids, and were dissolved by the water passing through the waste.
microorganism	Any microbiological entity, cellular or non-cellular, capable of replication or of transferring genetic material.

monitoring	The measurement of a concentration or other parameter (radiation or radionuclide concentration in the context of radioactive waste management) for purposes of assessment or control of environmental quality or exposure and the interpretation of such measurements. Monitoring can be continuous or non-continuous.
municipal waste	General waste for collection by municipalities, generated mainly by households, commercial activities, and street-sweeping.
prion	A poorly characterized slow infectious agent. Prions are believed to be the cause of a number of neurodegenerative diseases, e.g. Creutzfeldt–Jakob disease.
pyrolysis	The decomposition of organic material by heat in the absence, or with a limited supply, of oxygen.
radioactive waste	Material that contains, or is contaminated with, radionuclides at concentrations or activities greater than clearance levels and for which no use is foreseen.
radio-immunoassay	Assay or test involving radionuclides and using an antibody as the receptor.
radionuclide	A nuclide (i.e. an atom of specified atomic number and mass number) that exhibits properties of spontaneous disintegration, liberating energy, generally resulting in the formation of new nuclides, and accompanied by the emission of one or more types of radiation, such as α - and β -particles and γ -rays.
radiotherapy	The use of ionizing radiation to treat disease.
recycling	A term embracing the recovery and reuse of scrap or waste material for manufacturing or other purposes.
repository	A nuclear facility where radioactive waste is emplaced for disposal. Future retrieval of waste from the repository is not intended.
residence time	The time that elapses between the entry of a substance into a furnace and the exit of burn-out residue from the furnace.
residue	The material remaining after combustion of wastes such as ash or slag. Also refers to materials extracted from a liquid or gas stream.
risk	Probability that a hazard will cause harm, and the severity of that harm.
sanitary landfilling	An engineered method of disposing of solid waste on land in a manner that protects the environment, e.g. by spreading the waste in thin layers, compacting it to the smallest practical volume, and covering it with soil by the end of each working day, constructing barriers to infiltration, evacuating the gases produced.
scavenging	The manual sorting of solid waste at landfills and removal of usable material.
sealed source	Radioactive material that is permanently encapsulated or closely bounded in a solid form to prevent its release under the most severe conditions likely to be encountered in normal use and handling.

segregation	The systematic separation of solid waste into designated categories.
sewage	A community's water supply after it has been fouled by various uses. Its source may be a combination of the liquid or water-carried wastes from domestic, municipal, and industrial premises, together with such groundwater, surface water, and storm water as may be present.
sewerage	A system for the collection and transport of sewage, including conduits, pipes, and pumping stations.
SI	Abbreviation for the <i>Système international d'Unités</i> , a system of units of measurement developed to permit international harmonization and acceptability.
sludge	The accumulated solids that separate from liquids such as water or wastewater during processing, or deposits on the bottom of streams or other bodies of water.
sterilization	A reduction in microorganisms of more than 10^6 (more than 99.9999% of the microorganisms are killed), achieved by physical, chemical, or mechanical methods or by irradiation.
storage	The placement of waste in a suitable location or facility where isolation, environmental and health protection, and human control (e.g. monitoring for radioactivity, limitation of access) are provided. This is done with the intention that the waste will be subsequently retrieved for treatment and conditioning and/or disposal (or clearance of radioactive waste).
teletherapy	Therapeutic irradiation in which the source of irradiation is located at a distance from the patient's body.
treatment	Any method, technique or process for altering the biological, chemical, or physical characteristics of waste to reduce the hazards it presents and facilitate, or reduce the costs of, disposal. The basic treatment objectives include volume reduction, disinfection, neutralization, or other change of composition to reduce hazards, including removal of radionuclides from radioactive waste.
waste form	Waste in its solid physical and chemical form after treatment and/or conditioning before packaging; the waste form is a component of the waste package.
waste generator	Any person, organization or facility engaged in activities that generate waste.
waste inventory	In the context of radioactive waste management, a detailed, itemized record maintained by the operator or regulatory authority in accordance with established regulations; it may contain data such as physical quantity, the activity of the waste, and the radionuclide content.
waste management	All the activities, administrative and operational, involved in the handling, treatment, conditioning, storage, and disposal of waste (including transportation).
waste package	The product of waste conditioning, which includes the waste form, waste container(s), and any internal barriers (e.g. absorbing materials or liners), prepared in accordance with requirements for handling, transportation, storage, and/or disposal.

References

- IAEA (1993). *Radioactive waste management glossary*. Vienna, International Atomic Energy Agency.
- Shleien B, ed. (1992). *The health physics and radiological health handbook*, revised ed. Silver Spring, MD, Scinta.
- Stedman's medical dictionary*, 26th ed. (1995). Baltimore, MD, Williams & Wilkins.
- WHO (1980). *Glossary on solid waste*. Copenhagen, World Health Organization Regional Office for Europe.

ANNEX 1

Guidance levels of activity for procedures in nuclear medicine for a typical adult patient^a

Test	Radionuclide	Chemical form ^b	Max. usual activity per test ^c (MBq)
<i>Bone</i>			
Bone imaging	^{99m} Tc	Phosphonate and phosphate compounds	600
Bone imaging by single photon emission computerized tomography (SPECT)	^{99m} Tc	Phosphonate and phosphate compounds	800
Bone marrow imaging	^{99m} Tc	Labelled colloid	400
<i>Brain</i>			
Brain imaging (static)	^{99m} Tc	TcO ₄ ⁻	500
	^{99m} Tc	Diethylenetriaminepentaacetic acid (DTPA), gluconate, and glucoheptonate	500
Brain imaging (SPECT)	^{99m} Tc	TcO ₄ ⁻	800
	^{99m} Tc	DTPA, gluconate, and glucoheptonate	800
	^{99m} Tc	Exametazime	500
Cerebral blood flow	¹³³ Xe	In isotonic sodium chloride solution	400
	^{99m} Tc	Hexamethyl propylene amine oxime (HM-PAO)	500
Cisternography	¹¹¹ In	DTPA	40
<i>Lacrimal</i>			
Lacrimal drainage	^{99m} Tc	TcO ₄ ⁻	4
	^{99m} Tc	Labelled colloid	4
<i>Thyroid</i>			
Thyroid imaging	^{99m} Tc	TcO ₄ ⁻	200
	¹²³ I	I ⁻	20
Thyroid metastases (after ablation)	¹³¹ I	I ⁻	400
Parathyroid imaging	²⁰¹ Tl	Tl ⁺ , chloride	80
<i>Lung</i>			
Lung ventilation imaging	⁸¹ Kr ^m	Gas	6000
	^{99m} Tc	DTPA-aerosol	80
Lung ventilation study	¹³³ Xe	Gas	400
	¹²⁷ Xe	Gas	200
Lung perfusion imaging	⁸¹ Kr ^m	Aqueous solution	6000
	^{99m} Tc	Human albumin (macroaggregates or microspheres)	100
Lung perfusion imaging (with venography)	^{99m} Tc	Human albumin (macroaggregates or microspheres)	160
Lung perfusion studies	¹³³ Xe	Isotonic solution	200
	¹²⁷ Xe	Isotonic chloride solution	200
Lung imaging (SPECT)	^{99m} Tc	Macroaggregated albumin (MAA)	200
<i>Liver and spleen</i>			
Liver and spleen imaging	^{99m} Tc	Labelled colloid	80
Functional biliary system imaging	^{99m} Tc	Iminodiacetates and equivalent agents	150
Spleen imaging	^{99m} Tc	Labelled denatured red blood cells	100
Liver imaging (SPECT)	^{99m} Tc	Labelled colloid	200
<i>Cardiovascular</i>			
First pass blood flow studies	^{99m} Tc	TcO ₄ ⁻	800
	^{99m} Tc	DTPA	800
	^{99m} Tc	Macroaggregated globulin 3	400
Blood pool imaging	^{99m} Tc	Human albumin complex	40
Cardiac and vascular imaging/probe studies	^{99m} Tc	Human albumin complex	800

Test	Radionuclide	Chemical form ^b	Max. usual activity per test ^c (MBq)
Myocardial imaging/probe studies	^{99m} Tc	Labelled normal red blood cells	800
Myocardial imaging	^{99m} Tc	Phosphonate and phosphate compounds	600
Myocardial imaging (SPECT)	^{99m} Tc	Isonitriles	300
	²⁰¹ Tl	Tl ⁺ chloride	100
	^{99m} Tc	Phosphonate and phosphate compounds	800
	^{99m} Tc	Isonitriles	600
<i>Stomach, gastrointestinal tract</i>			
Stomach/salivary gland imaging	^{99m} Tc	TcO ₄ ⁻	40
Meckel's diverticulum imaging	^{99m} Tc	TcO ₄ ⁻	400
Gastrointestinal bleeding	^{99m} Tc	Labelled colloid	400
	^{99m} Tc	Labelled normal red blood cells	400
Oesophageal transit and reflux	^{99m} Tc	Labelled colloid	40
	^{99m} Tc	Non-absorbable compounds	40
Gastric emptying	^{99m} Tc	Non-absorbable compounds	12
	¹¹¹ In	Non-absorbable compounds	12
	^{113m} In	Non-absorbable compounds	12
<i>Kidney, urinary system, and adrenals</i>			
Renal imaging	^{99m} Tc	Dimercaptosuccinic acid	160
Renal imaging/renography	^{99m} Tc	DTPA, gluconate, and glucoheptonate	350
	^{99m} Tc	Macroaggregated globulin 3	100
	¹²³ I	<i>o</i> -Iodohippurate	20
Adrenal imaging	⁷⁵ Se	Selenocholesterol	8
<i>Miscellaneous</i>			
Tumour or abscess imaging	⁶⁷ Ga	Citrate	300
	²⁰¹ Tl	Chloride	100
Tumour imaging	^{99m} Tc	Dimercaptosuccinic acid	400
Neuroectodermal tumour imaging	¹²³ I	<i>m</i> -Iodobenzylguanidine	400
	¹³¹ I	<i>m</i> -Iodobenzylguanidine	20
Lymph node imaging	^{99m} Tc	Labelled colloid	80
Abscess imaging	^{99m} Tc	Exametazime labelled white cells	400
	¹¹¹ In	Labelled white cells	20
Thrombus imaging	¹¹¹ In	Labelled platelets	20

^aSource: IAEA (1996). *International basic safety standards for protection against ionizing radiation and for the safety of radiation sources*. Vienna, International Atomic Energy Agency (Safety Series, No. 115); used with permission.

^bIn some countries, some of the compounds are considered obsolete.

^cIn some countries the typical values are lower than those indicated in the table.

Chemical destruction methods for cytostatic drugs

Note: The text of Methods 1–11, with minor editorial changes, is taken from the following publications with the permission of IARC:

IARC (1983). *Laboratory decontamination and destruction of carcinogens in laboratory wastes: some hydrazines*. Lyon, International Agency for Research on Cancer (IARC Scientific Publications, No. 54).

IARC (1985). *Laboratory decontamination and destruction of carcinogens in laboratory wastes: some antineoplastic agents*. Lyon, International Agency for Research on Cancer (IARC Scientific Publications, No. 73).

Introduction

Use of the methods described in this annex requires precautions in the handling both of cytostatic drugs and of some corrosive chemicals; for example, it is essential to wear gloves for the work.

A number of guidelines for the safe handling of antineoplastic agents have been published elsewhere (Knowles & Virden, 1980; David, 1981; Harrison, 1981; Zimmerman et al., 1981; Anderson et al., 1982; National Institutes of Health, 1982; Jones et al., 1983; Solimando, 1983; Stolar et al., 1983; National Study Commission on Cytotoxic Exposure, 1984; American Society of Hospital Pharmacists, 1985); the following warnings and precautions should also be observed during performance of the tests described here:

- Concentrated sulfuric and hydrochloric acids and sodium hydroxide are corrosive and should be handled with care. All reactions should be carried out in a well ventilated fume cupboard.
- Care should be taken in the preparation of solutions of potassium permanganate in sulfuric acid: solid potassium permanganate should never be added to concentrated sulfuric acid.
- The dilution of concentrated sulfuric acid with water is an extremely exothermic reaction; the acid should always be added to the water (never the reverse) and the heat of reaction removed by cooling in a cold-water bath.
- Potassium permanganate is a strong oxidizing agent; care must be taken not to mix it with concentrated reducing agents.
- In case of skin contact with corrosive chemicals, the skin should be washed under running water for at least 15 minutes.
- Dry sodium nitrate is highly combustible.

All the methods described in this annex have been tested for efficiency of degradation and absence of mutagenic activity of the residues. If more

information is required for testing, details of the methods can be found in IARC Scientific Publications, Nos 54 (1983) and 73 (1985).

Method 1. Destruction of doxorubicin and daunorubicin using potassium permanganate/sulfuric acid

Doxorubicin or daunorubicin, 30 mg, dissolved in 3 mol/litre sulfuric acid, 10 ml, is destroyed by potassium permanganate, 1 g, in 2 hours.

1. Reagents

Potassium permanganate: technical grade

Sulfuric acid (concentrated): relative density 1.84 (about 18 mol/litre); technical grade

Sulfuric acid (dilute): 3 mol/litre, aqueous

Note: The dilution of concentrated sulfuric acid is an extremely exothermic reaction. Always add the acid to the water, never the reverse, and remove heat by cooling in a cold-water bath.

Potassium permanganate/
sulfuric acid solution: to 100 ml of 3 mol/litre sulfuric acid, add 4.7 g solid potassium permanganate

Note 1: To avoid frothing, add the potassium permanganate in small increments.

Note 2: The reagent should always be freshly prepared on the day of use.

Ascorbic acid or sodium
bisulfite: technical grade

Ascorbic acid solution or
sodium bisulfite solution ~50 g/litre, aqueous

Sodium hydroxide: technical grade

Sodium hydroxide solution ~2 mol/litre (~8 g/100 ml), aqueous

Sodium carbonate: technical grade

2. Apparatus

Standard laboratory equipment.

3. Procedure (see Fig. A2.1)

3.1 Solid compounds

3.1.1 Estimate the amount of drug to be destroyed, and dissolve in 3 mol/litre sulfuric acid to obtain a maximum content of 3 mg/ml.

3.1.2 Place flask on a magnetic stirrer; add about 1 g potassium permanganate per 10 ml of solution from 3.1.1.

Note: To avoid frothing, add the potassium permanganate in small increments.

3.1.3 Allow to react for 2 hours with stirring.

3.1.4 Neutralize with 8g/100ml sodium hydroxide solution, and discard.

3.2 Aqueous solutions

3.2.1 Estimate the amount of drug to be destroyed, and dilute with water if necessary to obtain a maximum concentration of 3mg/ml.

3.2.2 Add slowly, with stirring, enough concentrated sulfuric acid to obtain a 3mol/litre solution, and allow to cool to room temperature.

3.2.3 Proceed as in 3.1.2 to 3.1.4.

3.3 Pharmaceutical preparations

Note: To avoid frothing, add potassium permanganate in small increments.

3.3.1 *Liquids:* proceed as in 3.2, using twice the amount of potassium permanganate.

3.3.2 *Solids:* dissolve in water and proceed as in 3.2, using twice the amount of potassium permanganate.

3.4 Glassware

3.4.1 Immerse in a freshly prepared solution of potassium permanganate/sulfuric acid. Allow to react for 2 hours.

3.4.2 Clean the glass by immersion in a solution of ascorbic acid or sodium bisulfite.

3.5 Spills of solid compounds

3.5.1 Isolate the area, and put on suitable protective clothing.

3.5.2 Pour an excess of potassium permanganate/sulfuric acid solution over the contaminated area. If the purple colour fades, add more potassium permanganate. Allow to react for 2 hours.

3.5.3 Decolorize the surface with a solution of ascorbic acid or sodium bisulfite.

3.5.4 Neutralize by addition of solid sodium carbonate.

3.5.5 Remove the decontamination mixture with an absorbent material.

3.5.6 Discard.

3.6 Spills of aqueous solutions or of pharmaceutical preparations

Proceed as in 3.5.

Fig. A2.1 Schematic representation of procedure for destruction of doxorubicin or daunorubicin



^aDetails of this optional step may be found in IARC Scientific Publication No. 73.

WHO 9854

Method 2. Destruction of methotrexate and dichloromethotrexate using potassium permanganate/sulfuric acid

Methotrexate, 50 mg, or dichloromethotrexate, 10 mg, solid compound, dissolved in 3 mol/litre sulfuric acid, 10 ml, is destroyed by potassium permanganate, 0.5 g, in 1 hour.

Note: In the case of pharmaceutical preparations of dichloromethotrexate, up to 50 mg can be dissolved in 10 ml of 3 mol/litre sulfuric acid and can be satisfactorily destroyed with 0.5 g of potassium permanganate.

1. *Reagents*

Potassium permanganate: technical grade

Sulfuric acid (concentrated): relative density 1.84 (about 18 mol/litre); technical grade

Sulfuric acid (dilute): 3 mol/litre, aqueous

Note: The dilution of concentrated sulfuric acid is an extremely exothermic reaction. Always add the acid to the water, never the reverse, and remove heat by cooling in a cold-water bath.

Potassium permanganate/
sulfuric acid solution: to 100 ml of 3 mol/litre sulfuric acid, add 4.7 g solid potassium permanganate

Note 1: To avoid frothing, add the potassium permanganate in small increments.

Note 2: The reagent should always be freshly prepared on the day of use.

Ascorbic acid or sodium
bisulfite: technical grade

Ascorbic acid solution or
sodium bisulfite solution: ~50 g/litre, aqueous

Sodium hydroxide: technical grade

Sodium hydroxide solution: ~2 mol/litre (~8 g/100 ml), aqueous

2. *Apparatus*

Standard laboratory equipment.

3. *Procedure* (see Fig. A2.2)

3.1 Solid compounds

3.1.1 For each 50 mg methotrexate or about 10 mg dichloromethotrexate, add 10 ml of 3 mol/litre sulfuric acid.

3.1.2 Place on a magnetic stirrer, and add 0.5 g potassium permanganate per each 10 ml solution.

Note: To avoid frothing, add the potassium permanganate in small increments.

3.1.3 Continue stirring for 1 hour.

3.1.4 Neutralize with 8 g/100 ml sodium hydroxide solution and discard.

3.2 Aqueous solutions

3.2.1 Dilute with water to obtain a maximum concentration of 5 mg/ml methotrexate or 1 mg/ml dichloromethotrexate.

3.2.2 Add slowly, with stirring, enough concentrated sulfuric acid to obtain a 3 mol/litre solution.

3.2.3 Proceed as in 3.1.2 to 3.1.4.

3.3 Injectable pharmaceutical preparations

Note: This method has been tested using solutions containing 2–5% glucose and 0.45% saline.

3.3.1 Dilute with water to obtain a maximum concentration of 2.5 mg/ml of either compound.

3.3.2 Add slowly, with stirring, enough concentrated sulfuric acid to obtain a 3 mol/litre solution.

3.3.3 Add 1 g potassium permanganate for each 10 ml solution and continue stirring for 1 hour.

Note: To avoid frothing, add potassium permanganate in small increments.

3.4.4 Proceed as in 3.1.4.

3.4 Glassware

3.4.1 Immerse in a freshly prepared solution of potassium permanganate/sulfuric acid. Allow to react for 1 hour or more.

3.4.2 Clean the glass by immersion in a solution of ascorbic acid or sodium bisulfite.

3.5 Spills of solid compounds

3.5.1 Isolate the area, and put on suitable protective clothing.

3.5.2 Collect the solid, place it in a beaker and treat as in 3.1.

3.5.3 Rinse the area with an excess of 3 mol/litre sulfuric acid. Take up the rinse with absorbent material.

3.5.4 Place the absorbent material in a beaker and cover with potassium permanganate/sulfuric acid solution. Allow to react for 1 hour or more. If the purple colour fades, add more potassium permanganate.

3.5.5 Neutralize by addition of solid sodium carbonate. Discard.

3.6 Spills of aqueous solutions or of injectable pharmaceutical preparations

3.6.1 Isolate the area, and put on suitable protective clothing.

3.6.2 Take up the spill with absorbent material. Place the material in a beaker for inactivation.

3.6.3 Rinse the area with 3 mol/litre sulfuric acid and take up the rinse with absorbent material. Place the material in the same beaker as the other waste.

3.6.4 Proceed as in 3.5.4 and 3.5.5.

Fig. A2.2 Schematic representation of procedure for destruction of methotrexate or dichloromethotrexate using potassium permanganate sulfuric acid

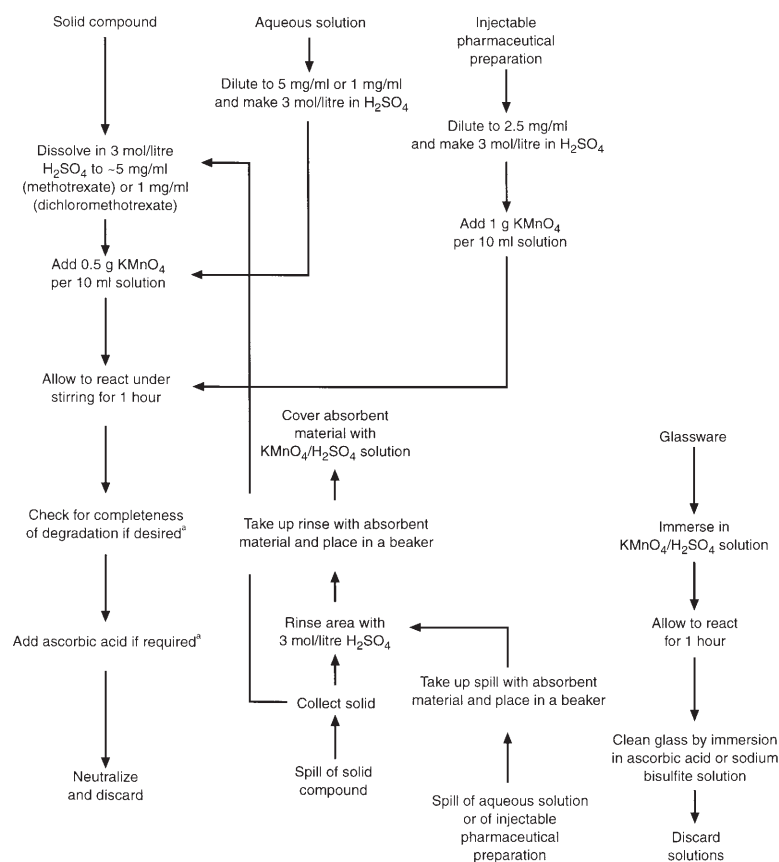

^a Details of this optional step may be found in IARC Scientific Publication N^o. 73.

Method 3. Destruction of methotrexate using a aqueous alkaline potassium permanganate

Methotrexate, 50 mg, dissolved in 4 g/100 ml sodium hydroxide solution, 50 ml, is destroyed by 1 g/100 ml potassium permanganate solution, 5.5 ml, in 30 minutes.

1. Reagents

Potassium permanganate: technical grade

Sodium hydroxide: technical grade

Sodium bisulfite: technical grade

Potassium permanganate solution: 0.06 mol/litre (1 g/100 ml), aqueous

Sodium bisulfite solution:	0.1 mol/litre (1 g/100 ml), aqueous
Sodium hydroxide solutions:	1 mol/litre (4 g/100 ml), aqueous 2 mol/litre (8 g/100 ml), aqueous
Sodium hydroxide/potassium permanganate solution	1 g/100 ml potassium permanganate, in 4 g/100 ml sodium hydroxide

2. *Apparatus*

Standard laboratory equipment.

3. *Procedure* (see Fig. A2.3)

3.1 **Solid compound**

- 3.1.1 Dissolve in 4 g/100 ml sodium hydroxide solution to obtain a concentration of not more than 1 mg/ml.
- 3.1.2 Add potassium permanganate solution until the purple colour persists for 30 minutes.
- 3.1.3 Add sodium bisulfite solution to the reaction mixture until the purple colour disappears.
- 3.1.4 Discard.

3.2 **Aqueous solutions, including injectable pharmaceutical preparations**

- 3.2.1 Add an equal volume of 8 g/100 ml sodium hydroxide solution.
- 3.2.2 Proceed as in 3.1.2 to 3.1.4.

3.3 **Glassware**

- 3.3.1 Immerse in potassium permanganate/sodium hydroxide solution. Allow to react for 30 minutes.
- 3.3.2 Clean the glass by immersion in sodium bisulfite solution.

3.4 **Spills of solid compound**

- 3.4.1 Isolate the area, and put on suitable protective clothing.
- 3.4.2 Collect the solid and place it in a beaker.
- 3.4.3 Rinse the area with 4 g/100 ml sodium hydroxide solution.
- 3.4.4 Take up the rinse with absorbent material. Place the material in the same beaker as the solid.
- 3.4.5 Cover the waste in the beaker with potassium permanganate/sodium hydroxide solution and allow to react for 30 minutes.
- 3.4.6 Discard.

3.5 **Spill of aqueous solutions**

- 3.5.1 Isolate the area, and put on suitable protective clothing.

Fig. A2.3 Schematic representation of procedure for destruction of methotrexate using aqueous alkaline potassium permanganate

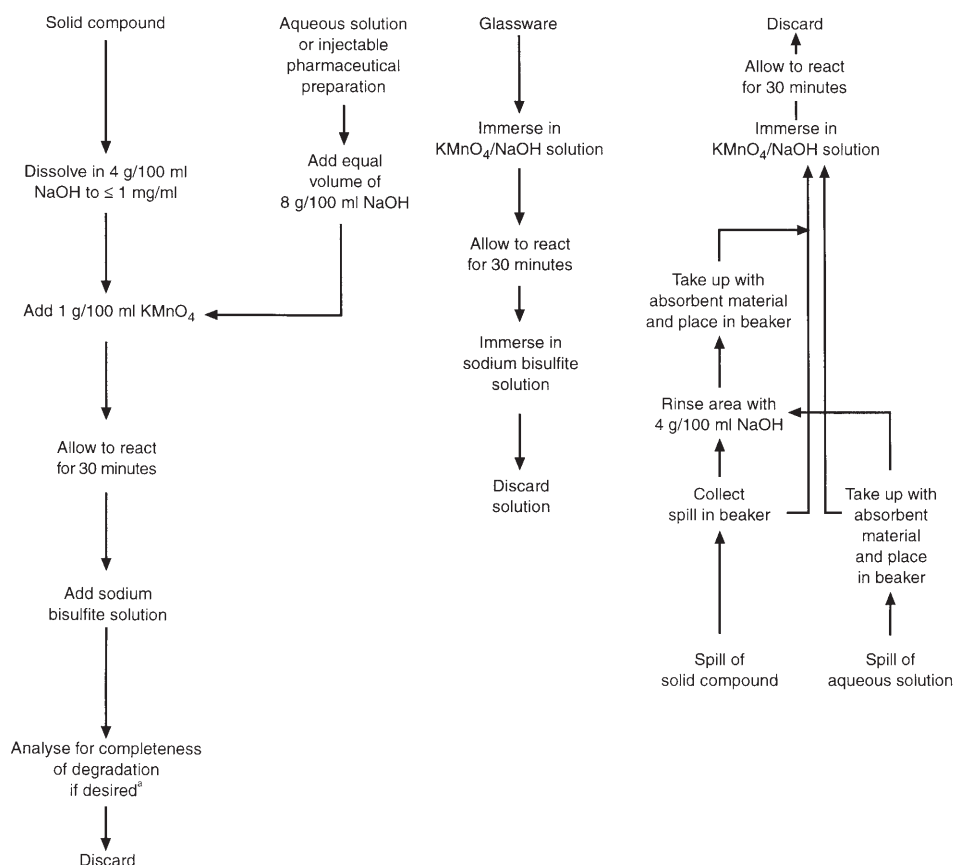

^a Details of this optional step may be found in IARC Scientific Publication N°. 73.

3.5.2 Take up the spill with absorbent material. Place the material in a beaker and cover with potassium permanganate/sodium hydroxide solution.

3.5.3 Proceed as in 3.4.3 to 3.4.6.

Method 4. Destruction of methotrexate using a aqueous sodium hypochlorite

Methotrexate, 50 mg, dissolved in 4 g/100 ml sodium hydroxide solution, 100 ml, is destroyed by 5% sodium hypochlorite solution, 4.6 ml, in 30 minutes.

1. Reagents

Sodium hypochlorite solution: commercial grade, 5%

Sodium hydroxide: technical grade

Sodium hydroxide solution: 1 mol/litre (4 g/100 ml), aqueous

2. Apparatus

Standard laboratory equipment.

3. Procedure (see Fig. A2.4)

Note 1: Solutions of sodium hypochlorite tend to deteriorate and it is therefore essential to check their active chlorine content. The strength of sodium hypochlorite solutions may be given as weight/weight or weight/volume, which is an additional reason for estimating the concentration of available chlorine.

Note 2: Percent (%) available chlorine = mass of chlorine in grams liberated by acidifying 100 g of sodium hypochlorite solution.

Note 3: The sodium hypochlorite solution used for this determination should contain not less than 25 g and not more than 30 g of active chlorine per litre. Assay: pipette 10.00 ml sodium hypochlorite solution into a 100-ml volumetric flask and fill to the mark with distilled water. Pipette 10 ml of the resulting solution into a conical flask containing 50 ml distilled water, 1 g potassium iodide, and 12.5 ml acetic acid (2 mol/litre). Rinse and titrate with 0.1 mol/litre sodium thiosulfate solution, using starch as indicator; 1 ml of 0.1 mol/litre sodium thiosulfate solution corresponds to 3.545 mg active chlorine.

3.1 Solid compound

3.1.1 Dissolve in 4 g/100 ml sodium hydroxide solution to obtain a concentration of not more than 50 mg/100 ml.

3.1.2 Estimate the amount of sodium hypochlorite solution required.

3.1.3 Add at least twice this estimated amount, i.e. approx. 10 ml sodium hypochlorite solution for each 50 mg methotrexate. Allow to react for 30 minutes.

3.1.4 Discard.

3.2 Aqueous solutions, including injectable pharmaceutical preparations

3.2.1 Estimate the amount of methotrexate to be degraded.

3.2.2 Proceed as in 3.1.2 to 3.1.4.

3.3 Glassware

3.3.1 Immerse in sodium hypochlorite solution. Allow to react for 30 minutes.

3.3.2 Discard the solution.

3.4 Spills of solid compound

3.4.1 Isolate the area, and put on suitable protective clothing.

3.4.2 Collect the solid, place it in a beaker, and treat as in 3.1.

3.4.3 Rinse the area with sodium hypochlorite solution and then with water.

3.4.4 Take up the rinse with absorbent material and discard.

Fig. A2.4 Schematic representation of procedure for destruction of methotrexate using aqueous sodium hypochlorite

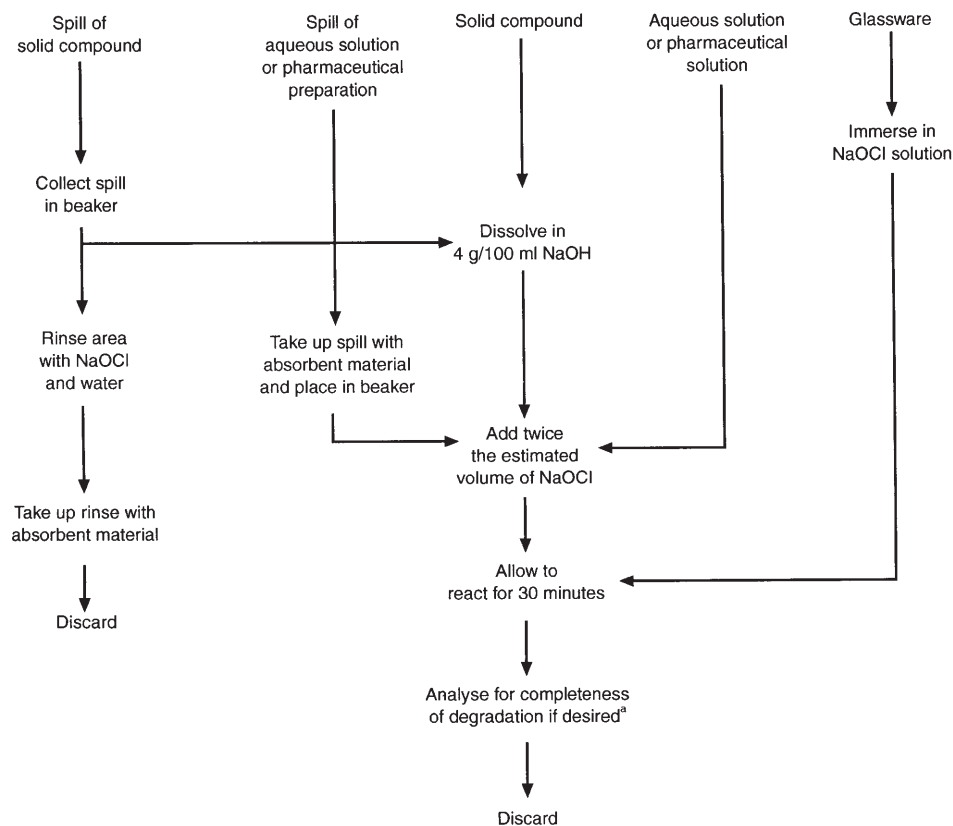

^aDetails of this optional step may be found in IARC Scientific Publication No. 73.

WHO 88537

3.5 Spills of aqueous solutions, including injectable pharmaceutical preparations

- 3.5.1 Isolate the area, and put on suitable protective clothing.
- 3.5.2 Take up the spill with absorbent material. Place the material in a beaker.
- 3.5.3 Proceed as in 3.1.2 to 3.1.4.

Method 5. Destruction of cyclophosphamide and ifosfamide using alkaline hydrolysis in the presence of dimethylformamide

Cyclophosphamide or ifosfamide, 100 mg, in dimethylformamide, 20 ml, is destroyed by 12 g/100 ml sodium hydroxide solution, 10 ml, when refluxed for 4 hours.

1. Reagents

Sodium hydroxide: technical grade

Sodium hydroxide solution: ~10 mol/litre (40 g/100 ml), aqueous
~3 mol/litre (12 g/100 ml), aqueous

Dimethylformamide (DMF): analytical grade

DMF/sodium hydroxide solution: freshly prepared solution containing 2 volumes of DMF and 1 volume of 12g/100ml sodium hydroxide

2. Apparatus

Standard laboratory equipment.

3. Procedure (see Fig. A2.5)

3.1 Solid compounds

3.1.1 For each 100mg of sample, add 30ml DMF/sodium hydroxide solution.

3.1.2 Reflux for 4 hours.

3.1.3 Dilute with water and discard.

3.2 Aqueous solutions and pharmaceutical solutions

3.2.1 Dilute with 40g/100ml sodium hydroxide solution to obtain a maximum cyclophosphamide and/or ifosfamide content of 10g/litre and a minimum sodium hydroxide concentration of 12g/100ml.

3.2.2 Add 2ml DMF for each ml of solution from 3.2.1.

3.2.3 Proceed as in 3.1.2 to 3.1.3.

3.3 Glassware

3.3.1 Rinse with two successive portions of 12g/100ml sodium hydroxide, then two successive portions of water (enough to wet all the glass). Drain completely between each rinse.

3.3.2 Treat rinses as in 3.2.

3.4 Spills of solid compounds

3.4.1 Isolate the area, and put on suitable protective clothing.

3.4.2 Collect the solid, place it in a beaker and treat as in 3.1.

3.4.3 Rinse the area twice with an excess of 12g/100ml sodium hydroxide solution.

3.4.4 Take up the rinse with absorbent material, and immerse the material in a freshly prepared DMF/sodium hydroxide solution.

3.4.5 Repeat steps 3.4.3 and 3.4.4.

3.4.6 Reflux for 4 hours.

3.5 Spills of aqueous solutions

3.5.1 Isolate the area, and put on suitable protective clothing.

3.5.2 Take up the spill with absorbent material, and immerse the material in a freshly prepared DMF/sodium hydroxide solution.

3.5.3 Proceed as in 3.4.3 to 3.4.6.

Fig. A2.5 Schematic representation of procedure for destruction of cyclophosphamide and ifosfamide using alkaline hydrolysis in the presence of dimethylformamide

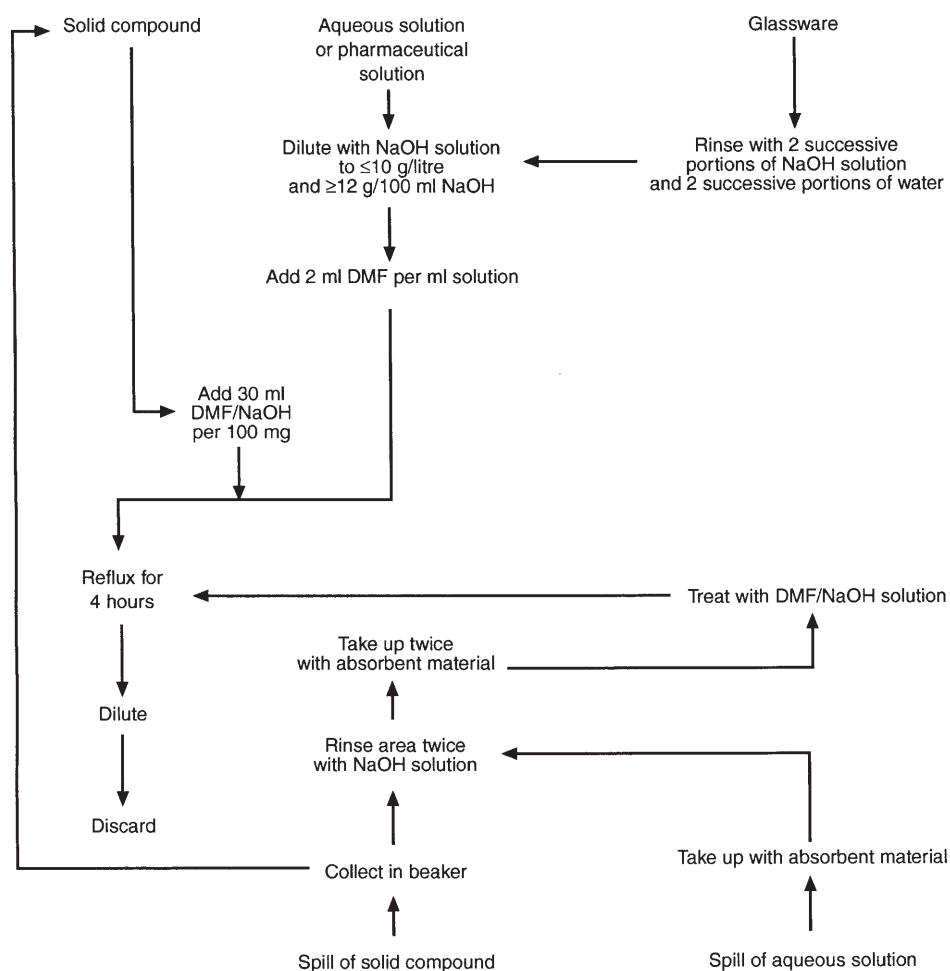

WHO 96539

Method 6. Destruction of cyclophosphamide using acid hydrolysis followed by addition of sodium thiosulfate and alkaline hydrolysis

A sample of 250 mg cyclophosphamide dissolved in 10 ml of 1 mol/litre hydrochloric acid is completely hydrolysed when refluxed for 1 hour. After addition of 1.5 g sodium thiosulfate to the neutralized reaction mixture, the medium is made strongly alkaline with 20 g/100 ml sodium hydroxide solution and the reaction is allowed to proceed for 1 hour.

1. Reagents

- Sodium hydroxide: technical grade
- Sodium hydroxide solution: 5 mol/litre (20 g/100 ml), aqueous
- Sodium thiosulfate: technical grade

Hydrochloric acid (concentrated): relative density 1.19 (~12 mol/litre); technical grade

Hydrochloric acid (dilute): 1 and 2 mol/litre, aqueous

pH paper

2. *Apparatus*

Standard laboratory equipment.

3. *Procedure* (see Fig. A2.6)

3.1 **Solid compound**

3.1.1 For each 250 mg of sample, add 10 ml of 1 mol/litre hydrochloric acid.

3.1.2 Reflux for 1 hour. Allow to cool to room temperature.

3.1.3 Add 20 g/100 ml sodium hydroxide solution until a pH of about 6 is obtained. Allow to cool to room temperature.

3.1.4 Add 1.5 g sodium thiosulfate for each 250 mg cyclophosphamide and make strongly alkaline with 20 g/100 ml sodium hydroxide solution.

3.1.5 Allow to react for 1 hour.

3.1.6 Dilute with water and discard.

3.2 **Aqueous solutions and injectable pharmaceutical preparations**

3.2.1 Dilute if necessary to obtain a maximum cyclophosphamide content of 25 g/litre and add concentrated hydrochloric acid to obtain a 1 mol/litre hydrochloric acid solution.

3.2.2 Proceed as in 3.1.2 to 3.1.6.

3.3 **Glassware**

3.3.1 Rinse with four successive portions of 1 mol/litre hydrochloric acid solution (enough to wet all the glass). Drain completely between each rinse.

3.3.2 Treat rinses as in 3.1.2 to 3.1.6.

3.4 **Spills of solid compound**

3.4.1 Isolate the area, and put on suitable protective clothing.

3.4.2 Collect the solid and place in a beaker.

3.4.3 Rinse the area with four successive portions of enough 1 mol/litre hydrochloric acid to wet it. Take up each rinse with absorbent material. Place the material in the beaker containing the solid from 3.4.2.

3.4.4 Cover the contents of the beaker from 3.4.2 and 3.4.3 with 1 mol/litre hydrochloric acid solution.

3.4.5 Proceed as in 3.1.2 to 3.1.5.

3.4.6 Discard.

3.5 Spills of aqueous solutions

- 3.5.1 Isolate the area, and put on suitable protective clothing.
- 3.5.2 Take up the spill with absorbent material. Place the material in a beaker and cover with 1 mol/litre hydrochloric acid.
- 3.5.3 Rinse the area with four successive portions of enough 1 mol/litre hydrochloric acid to wet it.
- 3.5.4 Take up each rinse with absorbent material, and immediately immerse the material in the beaker containing the residues from 3.5.2.
- 3.5.5 Proceed as in 3.1.2 to 3.1.5.

Fig. A2.6 Schematic representation of procedure for destruction of cyclophosphamide using acid hydrolysis followed by addition of sodium thiosulfate and aqueous hydrolysis

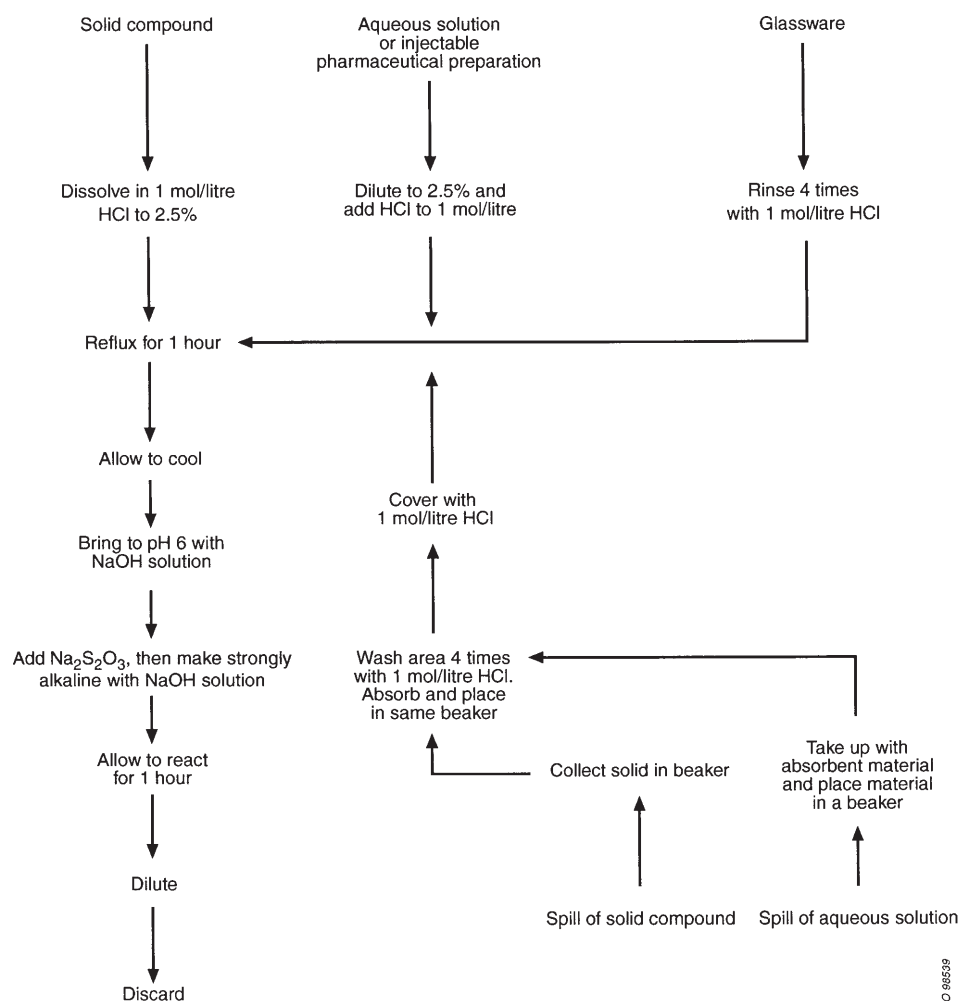

Method 7. Destruction of vincristine sulfate and vinblastine sulfate using potassium permanganate/sulfuric acid

Vincristine sulfate or vinblastine sulfate, 10 mg, in 10 ml of 3 mol/litre sulfuric acid is completely destroyed by 0.5 g of potassium permanganate in 2 hours.

1. Reagents

Potassium permanganate: technical grade

Sulfuric acid (concentrated): relative density 1.84 (~18 mol/litre);
technical grade

Sulfuric acid (dilute): ~3 mol/litre, aqueous

Note: The dilution of concentrated sulfuric acid is an extremely exothermic reaction. Always add the acid to the water, never the reverse, and remove heat by cooling in a cold-water bath.

Potassium permanganate/
sulfuric acid solution to 100 ml of 3 mol/litre sulfuric acid,
add 4.7 g solid potassium permanganate

Note 1: To avoid frothing, add the potassium permanganate in small increments.

Note 2: The reagent should always be freshly prepared on the day of use.

Ascorbic acid or sodium
bisulfite: technical grade

Ascorbic acid solution or
sodium bisulfite solution: ~50 g/litre, aqueous

Sodium hydroxide: technical grade

Sodium hydroxide solution: ~2 mol/litre (~8 g/100 ml), aqueous

Sodium carbonate: technical grade

2. Apparatus

Standard laboratory equipment.

3. Procedure (see Fig. A2.7)

3.1 Solid compounds

3.1.1 Estimate the amount of drug to be destroyed, and dissolve in 3 mol/litre sulfuric acid to obtain a maximum content of 1 mg/ml.

3.1.2 Place flask on a magnetic stirrer; add 0.5 g potassium permanganate per 10 ml of solution from 3.1.1.

3.1.3 Allow to react for 2 hours or more, with stirring.

3.1.4 Neutralize with 8 g/100 ml sodium hydroxide solution and discard.

3.2 Aqueous solutions

- 3.2.1 Estimate the amount of drug to be destroyed, and dilute with water, if necessary, to a maximum content of 1 mg/ml.
- 3.2.2 Add slowly, with stirring, enough concentrated sulfuric acid to obtain a 3 mol/litre solution, and allow to cool to room temperature.
- 3.2.3 Proceed as in 3.1.2 to 3.1.4.

3.3 Pharmaceutical preparations

Note: This method has been tested using the following preparation: 1 mg of compound + 1.275 mg methyl *p*-hydroxybenzoate + 1.225 mg propyl *p*-hydroxybenzoate + 100 mg mannitol.

- 3.3.1 Estimate the amount of drug to be destroyed, and dissolve in 3 mol/litre sulfuric acid to obtain a maximum content of 0.1 mg/ml.
- 3.3.2 Place on a magnetic stirrer; gradually add 0.5 g potassium permanganate per 10 ml of solution.
Note: To avoid frothing, add the potassium permanganate in small increments.
- 3.3.3 Proceed as in 3.1.3 to 3.1.4.

3.4 Glassware

- 3.4.1 Immerse in a freshly prepared solution of potassium permanganate/sulfuric acid. Allow to react for 2 hours or more.
- 3.4.2 Clean the glass by immersion in a solution of ascorbic acid or sodium bisulfite.

3.5 Spills of solid compounds

- 3.5.1 Isolate the area, and put on suitable protective clothing.
- 3.5.2 Collect the solid compound and place it in a beaker.
- 3.5.3 Rinse the area with water. Take up the rinse with absorbent material, and place the material in the beaker from 3.5.2.
- 3.5.4 Cover the contents of the beaker from 3.5.3 with potassium permanganate/sulfuric acid solution. Allow to react for 2 hours. If the purple colour fades, add more potassium permanganate.
- 3.5.5 Discard.

3.6 Spills of aqueous solutions or of solutions of pharmaceutical preparations

- 3.6.1 Isolate the area, and put on suitable protective clothing.
- 3.6.2 Take up the spill with absorbent material and place the material in a beaker. Rinse the area with water. Take up rinse with absorbent material, and place the material in the same beaker.
- 3.6.3 Proceed as in 3.5.4 to 3.5.5.

Fig. A2.7 Schematic representation of procedure for destruction of vincristine sulfate and vinblastine sulfate

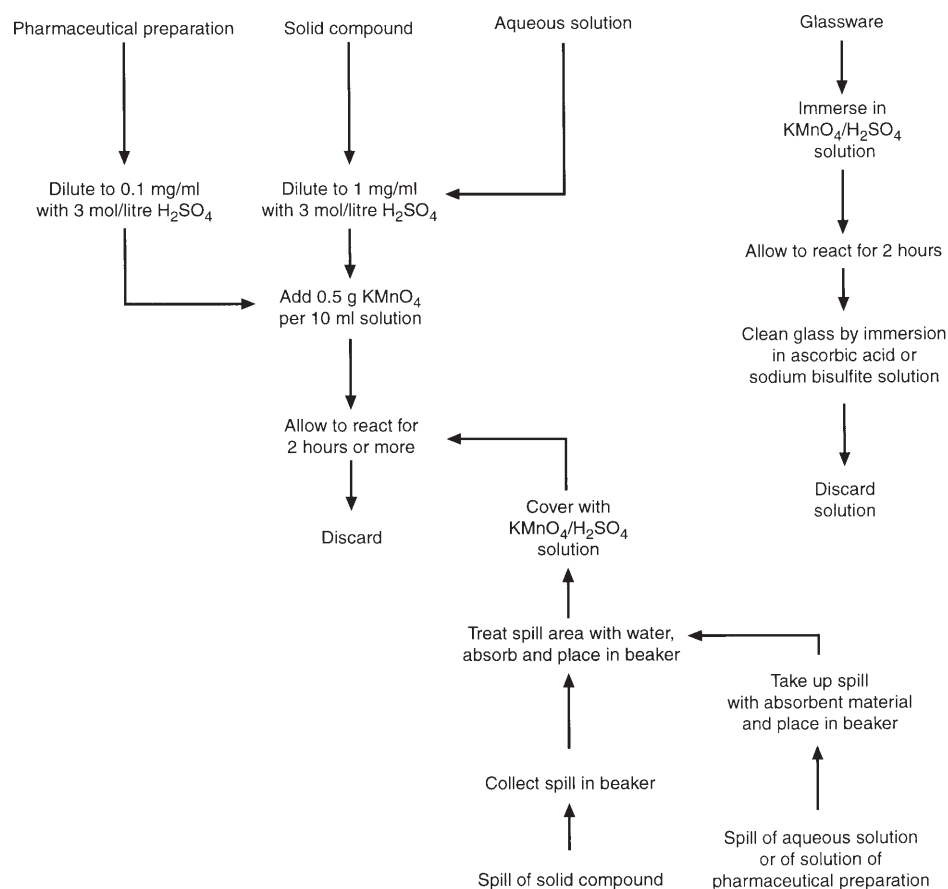

WHO 96540

Method 8. Destruction of 6-tioguanine and 6-mercaptopurine using potassium permanganate/sulfuric acid

6-Tioguanine or 6-mercaptopurine, 18 mg, dissolved in 20 ml of 3 mol/litre sulfuric acid is destroyed by 0.13 g potassium permanganate in 10–12 hours.

1. Reagents

Potassium permanganate: technical grade

Sulfuric acid (concentrated): relative density 1.84 (about 18 mol/litre); technical grade

Sulfuric acid (dilute): ~3 mol/litre, aqueous

Note: The dilution of concentrated sulfuric acid is an extremely exothermic reaction. Always add the acid to the water, never the reverse, and remove heat by cooling in a cold-water bath.

Potassium permanganate/
sulfuric acid solution: to 100 ml of 3 mol/litre sulfuric acid, add 4.7 g solid potassium permanganate

Note 1: To avoid frothing, add the potassium permanganate in small increments.

Note 2: The reagent should always be freshly prepared on the day of use.

Ascorbic acid or sodium bisulfite: technical grade

Ascorbic acid solution or sodium bisulfite solution: ~50 g/litre, aqueous

Sodium hydroxide: technical grade

Sodium hydroxide solution: ~2 mol/litre (~8 g/100 ml), aqueous

Sodium carbonate: technical grade

2. Apparatus

Standard laboratory equipment.

3. Procedure (see Fig. A2.8)

3.1 Solid compound

3.1.1 Estimate the amount of drug to be destroyed and dissolve in 3 mol/litre sulfuric acid to obtain a maximum concentration of 900 mg/litre.

3.1.2 Place flask on a magnetic stirrer; add 0.5 g potassium permanganate per 80 ml of solution from 3.1.1.

3.1.3 Allow to react overnight.

3.1.4 Neutralize with 8 g/100 ml sodium hydroxide solution and discard.

3.2 Aqueous solutions

3.2.1 Estimate the amount of drug to be destroyed and dilute with water if necessary to obtain a maximum concentration of 900 mg/litre.

3.2.2 Add slowly, with stirring, enough concentrated sulfuric acid to obtain a 3 mol/litre solution, and allow to cool to room temperature.

3.2.3 Proceed as in 3.1.2 to 3.1.4.

3.3 Oral preparations

3.3.1 Dissolve in 3 mol/litre sulfuric acid to a maximum concentration of 900 mg/litre.

3.3.2 Place flask on a magnetic stirrer; gradually add 4 g of potassium permanganate per 80 ml of solution.

Note: To avoid frothing, add the potassium permanganate in small increments.

3.3.3 Proceed as in 3.1.3 and 3.1.4.

3.4 Parenteral solutions

Note: This method has been tested using the following two preparations:
7.5 mg 6-tioguanine in 50 ml of 5% dextrose solution, and 10 mg 6-mercaptopurine in 10 ml of 5% dextrose solution.

3.4.1 Add slowly with stirring, enough sulfuric acid to obtain a 3 mol/litre solution and allow to cool to room temperature.

3.4.2 Proceed as in 3.3.2 and 3.3.3.

3.5 Glassware

3.5.1 Immerse in a freshly prepared solution of potassium permanganate/sulfuric acid. Allow to react for 10–12 hours.

Fig. A2.8 Schematic representation of procedure for destruction of 6-tioguanine and 6-mercaptopurine

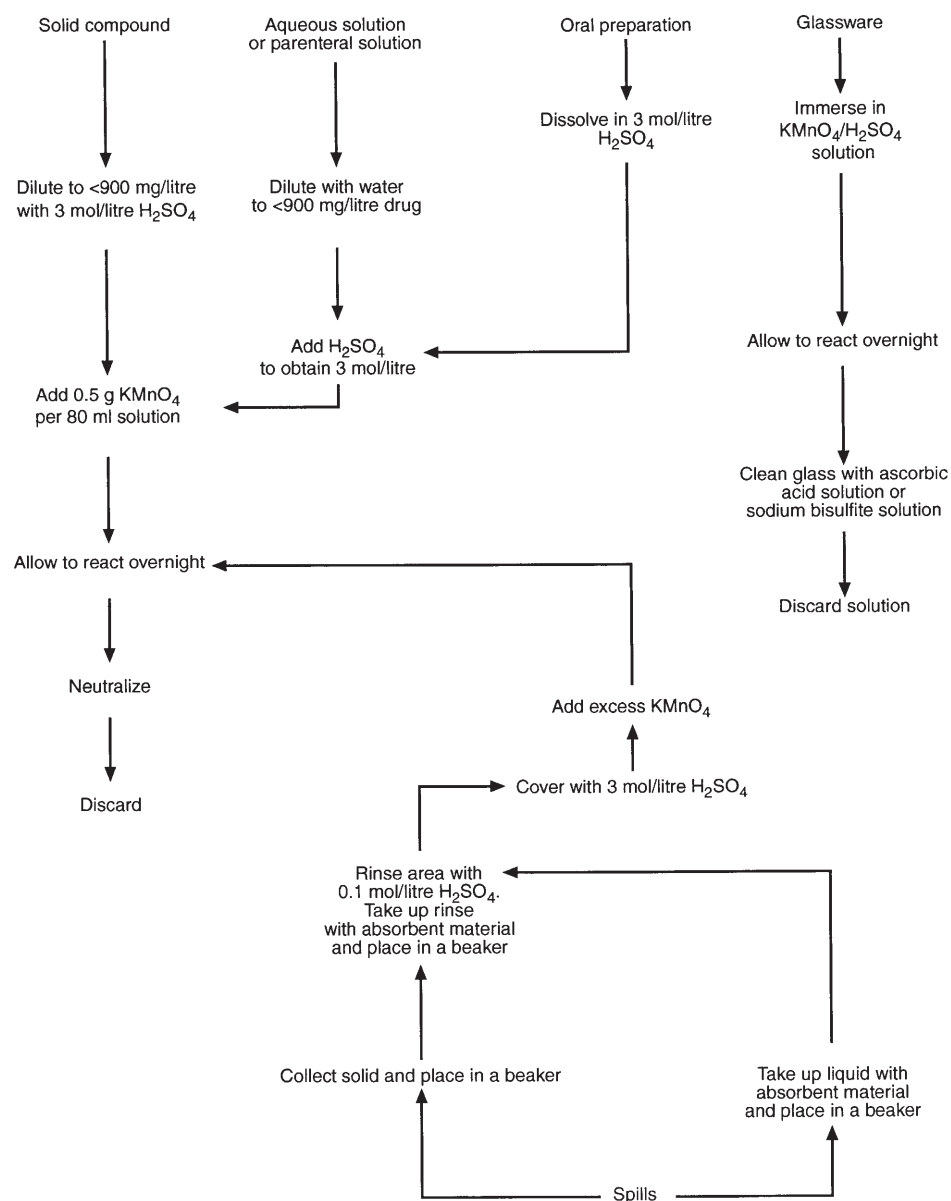

WHO 98641

3.5.2 Clean the glass by immersion in a solution of ascorbic acid or sodium bisulfite.

3.6 Spills

3.6.1 Isolate the area, and put on suitable protective clothing.

3.6.2 Collect the solid, or take up the liquid with absorbent material, and place the material in a beaker.

3.6.3 Rinse the area with 0.1 mol/litre sulfuric acid. Take up the rinse with absorbent material, and place the material in the beaker from 3.6.2.

3.6.4 Cover the contents of the beaker from 3.6.3 with 3 mol/litre sulfuric acid and add, with stirring, an excess of potassium permanganate. Allow to react overnight.

Note: At the end of this period, some purple colour should remain; if not, add more potassium permanganate and continue to react.

3.6.5 Discard.

Method 9. Destruction of cisplatin by reduction with zinc powder

Cisplatin, 30 mg, dissolved in 2 mol/litre sulfuric acid, 50 ml, is destroyed by zinc powder, 1.5 g, in 10–12 hours.

1. Reagents

Sulfuric acid (concentrated): relative density 1.84 (about 18 mol/litre); technical grade

Sulfuric acid (dilute): ~2 mol/litre and ~4 mol/litre, aqueous

Note: The dilution of concentrated sulfuric acid is an extremely exothermic reaction. Always add the acid to the water, never the reverse, and remove heat by cooling in a cold-water bath.

Zinc powder: technical grade

Sodium hydroxide: technical grade

Sodium hydroxide solution: ~2 mol/litre (~8 g/100 ml), aqueous

2. Apparatus

Standard laboratory equipment plus sintered glass funnel (porosity 4 or similar).

3. Procedure (see Fig. A2.9)

3.1 Solid compound

3.1.1 Dissolve in 2 mol/litre sulfuric acid solution to achieve a maximum concentration of 0.6 mg/ml.

3.1.2 Place flask on a magnetic stirrer; add 3 g zinc powder per 100 ml of solution from 3.1.1.

- 3.1.3 Stir overnight.
- 3.1.4 Neutralize with 8g/100ml sodium hydroxide solution.
- 3.1.5 Discard.

3.2 Aqueous solutions and injectable pharmaceutical preparations

Note: This method has been tested using solutions in 5% dextrose or 0.9% saline.

- 3.2.1 Dilute with water to obtain a maximum concentration of 0.6 mg/ml.
- 3.2.2 Add slowly, with stirring, enough concentrated sulfuric acid to obtain a 2 mol/litre solution, and allow to cool to room temperature.
- 3.2.3 Proceed as in 3.1.2 to 3.1.5.

3.3 Glassware

- 3.3.1 Rinse at least four times with enough water to completely wet the glass.
- 3.3.2 Treat rinses as in 3.2.

Fig. A2.9 Schematic representation of procedure for destruction of cisplatin by reduction with zinc powder

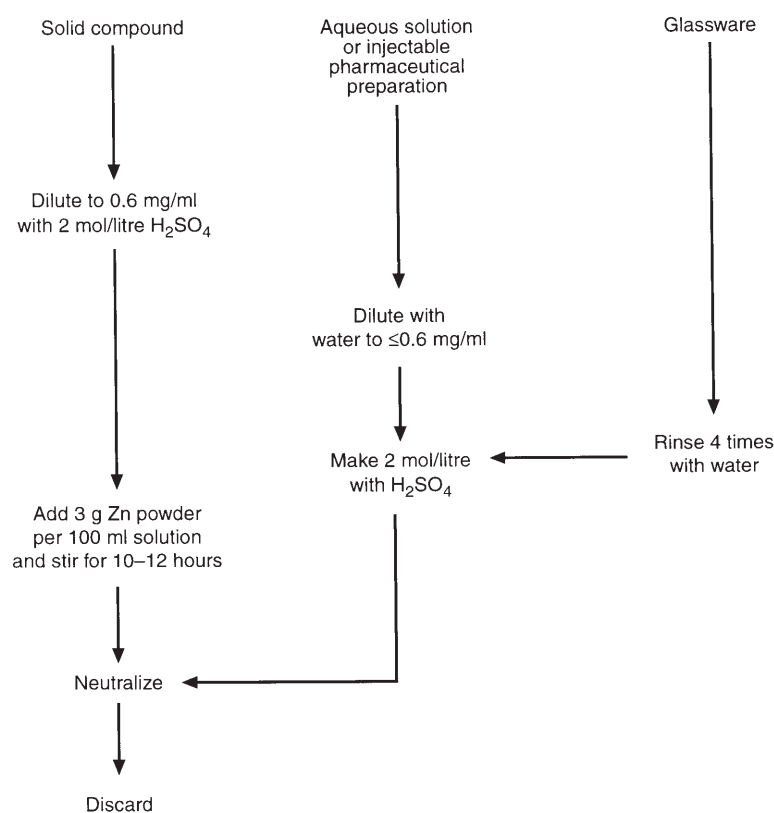

WHO 98542

Method 10. Destruction of cisplatin by reaction with sodium diethyldithiocarbamate

Cisplatin is destroyed by decomposition with sodium diethyldithiocarbamate.

1. Reagents

Sodium diethyldithiocarbamate:	technical grade
Sodium hydroxide:	technical grade
Sodium hydroxide solution:	0.1 mol/litre (0.4 g/100 ml), aqueous
Sodium nitrate:	technical grade
Sodium nitrate solution:	saturated, aqueous
Sodium diethyldithiocarbamate solution:	0.68 mol/litre (~1 g/100 ml) in 0.1 mol/litre sodium hydroxide solution

2. Apparatus

Standard laboratory equipment.

3. Procedure (see Fig. A2.10)

3.1 Solid compound

- 3.1.1 Estimate the amount of drug to be destroyed.
- 3.1.2 Dissolve in water.
- 3.1.3 For every 100 mg cisplatin, add 3 ml sodium diethyldithiocarbamate solution.
- 3.1.4 Add an equal volume of sodium nitrate solution.
Note: A yellow precipitate of the complex of platinum II and diethyldithiocarbamate will form when the platinum concentration is greater than 100 µg/ml.
- 3.1.5 Discard.

3.2 Aqueous solutions, including injectable pharmaceutical preparations

Proceed as in 3.1.

3.3 Glassware

Immerse in a 1:1 mixture of sodium diethyldithiocarbamate solution and sodium nitrate solution.

3.4 Spills

- 3.4.1 Isolate the area, and put on suitable protective clothing.
- 3.4.2 Collect solid, or take up liquid with absorbent material, and place in a beaker.

Fig. A2.10 Schematic representation of procedure for destruction of cisplatin by reaction with sodium diethyldithiocarbamate

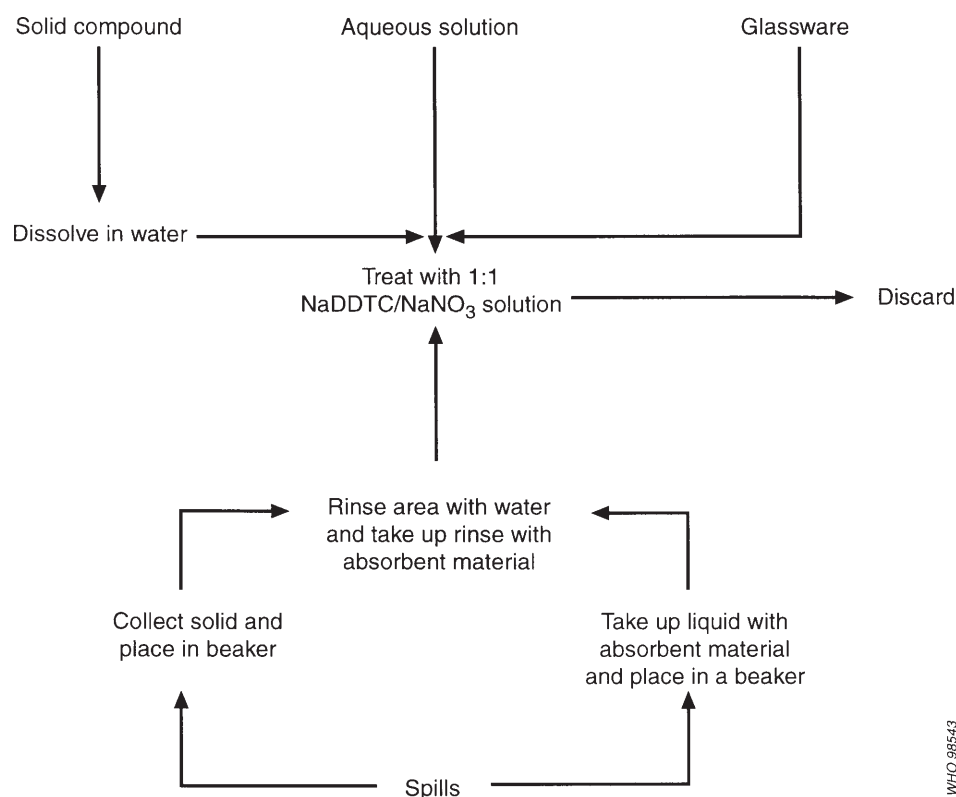

WHO 98543

- 3.4.3 Rinse the area with water and take up the rinse on absorbent material. Place the material in the beaker from 3.4.2.
- 3.4.4 Cover the contents of the beaker from 3.4.3 with a 1:1 mixture of sodium diethyldithiocarbamate solution and sodium nitrate solution.
- 3.4.5 Discard.

Method 11. Destruction of procarbazine in laboratory wastes using potassium permanganate in sulfuric acid

A 25-mg quantity of procarbazine can be degraded by 5 ml of a 0.3 mol/litre solution of potassium permanganate in 3 mol/litre sulfuric acid in 16 hours.

1. Reagents

- Potassium permanganate: technical grade
- Sulfuric acid (concentrated): relative density 1.84 (about 18 mol/litre)
- Sulfuric acid (dilute): 3 mol/litre, aqueous

Note: The dilution of concentrated sulfuric acid is an extremely exothermic reaction. Always add the acid to the water, never the reverse, and remove heat by cooling in a cold-water bath.

Potassium permanganate/
sulfuric acid solution: to 3 mol/litre sulfuric acid, add solid potassium permanganate to obtain a 0.3 mol/litre solution of potassium permanganate

Note 1: To avoid frothing, add the potassium permanganate in small increments.

Note 2: The reagent should always be freshly prepared on the day of use.

Ascorbic acid: analytical grade

2. Apparatus

Standard laboratory equipment.

3. Procedure (see Fig. A2.11)

3.1 Undiluted procarbazine

3.1.1 Dissolve the procarbazine in 3 mol/litre sulfuric acid to obtain a maximum concentration of 5 g/litre. (Sulfate precipitate might form but will redissolve after addition of potassium permanganate in step 3.1.2.)

3.1.2 Add enough potassium permanganate to obtain a 0.3 mol/litre solution and to ensure that the purple colour remains after the reaction.

3.1.3 Allow to react overnight or longer.

3.1.4 Dilute with water and discard.

3.2 Aqueous solutions

3.2.1 Add slowly, with stirring, enough sulfuric acid to obtain a 3 mol/litre solution and a maximal procarbazine concentration of 5 g/litre.

3.2.2 Proceed as in 3.1.2 to 3.1.4.

3.3 Glassware

3.3.1 Rinse glassware with three successive portions of 3 mol/litre sulfuric acid solution. Drain completely between each rinse.

3.3.2 Treat rinses as in 3.1.2 to 3.1.4.

3.4 Spills of aqueous solutions

3.4.1 Isolate the area, and put on suitable protective clothing, including breathing apparatus if considered necessary. Add 3 mol/litre sulfuric acid solution to the spill area.

3.4.2 Take up the spill with an absorbent material, such as blotting paper; place it immediately in a beaker, and add a solution of 0.3 mol/litre potassium permanganate in 3 mol/litre sulfuric acid. Allow to react overnight or longer.

3.4.3 Pour some of the potassium permanganate/sulfuric acid solution over the contaminated area and allow to react overnight or longer; add some ascorbic acid to the area to clear the colour.

Fig. A2.11 Schematic representation of procedure for destruction of procarbazine using potassium permanganate in sulfuric acid

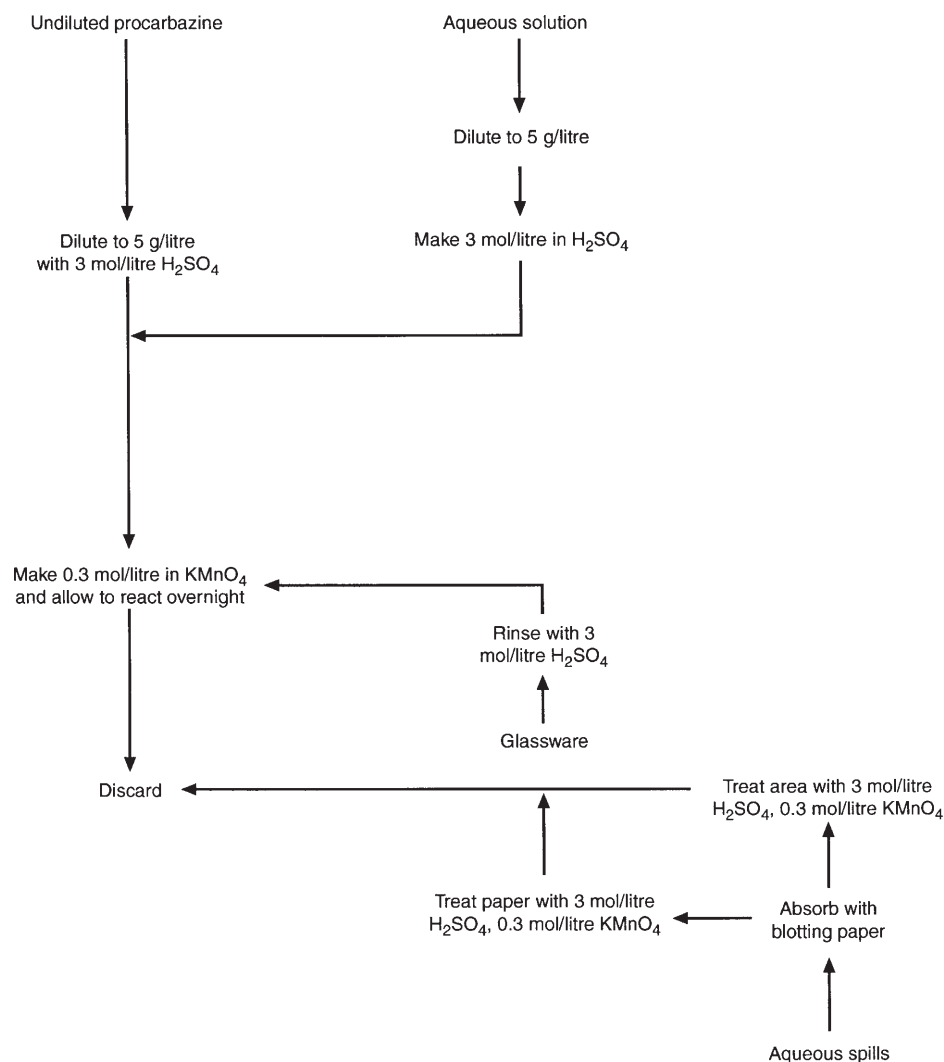

Methods of degradation of cytostatic drugs in hospital formulations

The three following degradation methods have been tested by a number of laboratories, coordinated by IARC, on 32 hospital formulations of cytostatic drugs (see Table A2.1). The efficiency of these methods is summarized in Table A2.2, which also indicates the mutagenic activity of the residues (tested using *Salmonella typhimurium* strains TA97, TA98, TA100, and TA102, with and without mutagenic activity). Degradation using sodium hypochlorite seems the most suitable method for these formulations.

Note: When reaction times were longer than those given in the following procedures, this is noted in Table A2.2.

(Text continues on page 221.)

Table A2.1 Formulation of reconstituted and administration solutions of cytostatic drugs

Note: After reconstitution of the drugs listed in this table, many are further diluted for administration to patients. However, the extent of this further dilution varies from country to country, as is evident from this table, which gives details for formulations used in France and the USA. The degradation methods given in this annex were tested on these formulations, in each instance using the "worst case", i.e. the stronger solution for administration, whenever there was a difference in national practice. It should be noted that the efficiency of degradation may be reduced if a particular method is used for a more concentrated formulation of a given drug.

Drug	Reconstituted solutions: solvents and additives		Drug concentration in reconstituted solution		Dilution for administration: diluent		Drug concentration in solution for administration	
	France	USA	France	USA	France	USA	France	USA
Aclarubicin 20 mg	Saline 0.9%		4 mg/ml		Saline 0.9% or glucose 5%		0.5 mg/ml	
Amsacrine 75 mg (contains 1.5 ml dimethyl acetamide)	Water 13.5 ml + (+)-lactic acid 42.93 mg	Water	5 mg/ml	5 mg/ml	Glucose 5%	Glucose 5%	0.15 mg/ml	0.15 mg/ml
Asparaginase	Water 2.5 ml + glycine 48.6 mg	Water	4000 U/ml	5000 U/ml	Saline 0.9% or glucose 5%	(no further dilution)	200 U/ml	5000 U/ml
Azathioprine ^a	Powder: lactose + starch + stearic acid +magnesium stearate	Water	10 mg/ml		Glucose 5%		2 mg/ml	
Bleomycin 15 mg	Saline 0.9%, 5 ml	Water	3 U/ml	3 U/ml	Saline 0.9% or glucose 5%	(no further dilution)	0.05 U/ml or 3 U/ml	3 U/ml
Carboplatin	Water	Water	10 mg/ml	10 mg/ml	Saline 0.9%	Glucose 5%	1 mg/ml	0.5 mg/ml
Carmustine 100 mg	Ethanol (3 ml) + water (27 ml)	Water	3.3 mg/ml	33.3 mg/ml	Saline 0.9% or glucose 5%	Saline 0.9% or glucose 5%	0.2 mg/ml	0.5 mg/ml
Chlormethine ^a (mustine)	(Formulation contains 2 ml triethylene glycol)	Water	5 mg/ml	1 mg/ml	Saline 0.9% or glucose 5%	Saline 0.9% or glucose 5%	1 mg/ml	0.2 mg/ml
Cisplatin	Mannitol + saline + HCl (10%) to pH 4	Water	1 mg/ml	1 mg/ml	Saline	Saline	0.05 mg/ml	0.5 mg/ml

Cyclophosphamide	Saline 0.9%	Water	20 mg/ml	20 mg/ml	20 mg/ml	Saline 0.9% or glucose 5%	1 mg/ml	4 mg/ml
Cytarabine	Water + methyl <i>p</i> -hydroxybenzoate	Water	20 mg/ml	20 mg/ml	100 mg/ml	Saline 0.9% or glucose 5%	0.5 mg/ml	11 mg/ml
Dacarbazine 100 mg + citric acid 100 mg + mannitol 50 mg	Water (10 ml)	Water	10 mg/ml	10 mg/ml	10 mg/ml	Saline 0.9%	0.02 mg/ml	4 mg/ml
Daunorubicin 20 mg + mannitol	Water	Water	5 mg/ml	5 mg/ml	5 mg/ml	Saline 0.9% or glucose 5%	20 µg/ml	5 mg/ml
Doxorubicin 10 mg + lactose 5 mg	Water	Water	2 mg/ml	2 mg/ml	5 mg/ml	Saline 0.9% or glucose 5%	10 µg/ml	400 µg/ml
Epirubicin 10 mg + lactose	Water or saline 0.9%	Water	2 mg/ml	2 mg/ml	2 mg/ml	Saline 0.9% or glucose 5%	0.2–2 mg/ml	
Etoposide, 20 mg + citric acid, 2 mg + benzyl alcohol, 30 mg + polysorbate 80/Tween 80, 80 mg + PEG 300, 650 mg + alcohol 30.5%, pH 3–4	Water or saline 0.9%	Water	20 mg/ml	20 mg/ml	5 mg/ml	Saline 0.9% or glucose 5%	200 µg/ml	150 µg/ml
Floxuridine	(not commercially available)	Water			100 mg/ml	Saline 0.9% or glucose 5%		0.3 mg/ml
Fludarabine ^a	Water	Water	25 mg/ml	25 mg/ml	10 mg/ml	Saline 0.9% or glucose 5%	1 mg/ml	0.4 mg/ml
5-Fluorouracil	Water (pH adjusted to 8.6–9.4 with NaOH)	Water (pH adjusted to 8.6–9.4 with NaOH)	50 mg/ml	50 mg/ml	50 mg/ml	(no further dilution)	0.01–40 mg/ml	50 mg/ml
Idarubicin ^a 5 mg + lactose 50 mg	Water or saline 0.9%	Water	1 mg/ml	1 mg/ml	1 mg/ml	Saline 0.9% or glucose 5%	0.5 mg/ml	40 µg/ml

Table A2.1 (continued)

Drug	Reconstituted solutions: solvents and additives		Drug concentration in reconstituted solution		Dilution for administration: diluents		Drug concentration in solution for administration	
	France	USA	France	USA	France	USA	France	USA
Ifosfamide	Water	Water	71.4 mg/ml	50 mg/ml	Saline 0.9% or glucose 5%	Saline 0.9% or glucose 5%	1 mg/ml	27 mg/ml
Lomustine—used without dilution. Contains: 40 mg/capsule lactose, talc, magnesium stearate								
6-Mercaptopurine—administered orally		Water		10 mg/ml		Saline 0.9% or glucose 5%		1 mg/ml
Methotrexate	Water + methyl <i>p</i> -hydroxybenzoate + propyl <i>p</i> -hydroxybenzoate	Water	2.5 mg/ml	100 mg/ml	Glucose 5%	Saline 0.9% or glucose 5%	0.5 mg/ml	2 mg/ml
Pirarubicin 10 mg + HCl 1 mol/litre + NaOH 0.2 mol/litre + lactose	Water (adjusted to 5 ml)		2 mg/ml		Glucose 5%		1 mg/ml	
Streptozocin 1 g + citric acid 220 mg	Saline 0.9% or glucose 5%, 9.5 ml	Water	100 mg/ml	100 mg/ml	Saline 0.9% or glucose 5%	Saline 0.9% or glucose 5%	0.1 mg/ml	14 mg/ml
Teniposide 50 mg + benzyl alcohol + dimethylacetamide + castor oil + ethanol	Non-aqueous solvent to 5 ml		10 mg/ml	10 mg/ml	Saline 0.9% or glucose 5%	Saline 0.9% or glucose 5%	500 µg/ml	1.8 mg/ml

Thiotepa 10mg (contains saline and NaHCO ₃)	Water	Water	5mg/ml	10mg/ml	Saline 0.9% or glucose 5%	Glucose 5%	1mg/ml	60µg/ml
Vinblastine sulfate 10mg	Saline 0.9% or glucose 5%	Saline 9mg in 1ml of 0.9% benzyl alcohol in water, pH adjusted to 3-5-5.0	1mg/ml	1mg/ml	Saline 0.9% or glucose 5%	(no further dilution)	0.17mg/ml	1mg/ml
Vincristine sulfate 1mg + methyl <i>p</i> - hydroxybenzoate 1.275mg + propyl <i>p</i> - hydroxybenzoate 0.225mg + acetic acid 0.2mol/litre	Water (adjusted to 1ml)	1.3mg methylparaben in 1ml water adjusted to pH 3.5-5.5	1mg/ml	1mg/ml	Saline 0.9% or glucose 5%	(no further dilution)	0.17mg/ml	1mg/ml
Vindesine sulfate 1mg + mannitol 5mg	Water		0.25mg/ml		Saline 0.9% or glucose 5%		1µg/ml	
Vinorelbine sulfate 10mg	Water		10mg/ml		Saline 0.9% or glucose 5%		100µg/ml	

*Only the US formulations were tested.

Table A2.2 *Efficiency of the degradation methods tested on 32 cytostatic drug formulations*

Drug	Degradation by sodium hypochlorite		Degradation by hydrogen peroxide		Degradation by Fenton reagent	
	Degradation	Mutagenicity	Degradation	Mutagenicity	Degradation	Mutagenicity
Aclarubicin	+	-	-		+	-
Amsacrine	+	-	-		+	-
Asparaginase	+	-	+	-	+	-
Azathioprine	+	-?	-		+	-
Bleomycin, 10mg/ml	+	-	-		+/- ^a	+/- ^a
Carboplatin	+	-	+	-		
Carmustine:						
1 hour	+	+	+	-/T	+	+
4 hours	+	-	+	-/T	Not tested	
Chlormethine (mustine)	+	-	-		-	
Cisplatin	+	-	+	-(+) ^b	+	-
Cyclophosphamide	+	-	+	-	+	-(+) ^c
Cytarabine	+	-	+	-	+	-
Dacarbazine, 10mg/ml	+	+	-		+/- ^d	+/- ^d
Dacarbazine, 4mg/ml	+	-	Not tested		+	+/-
Daunorubicin	+	-	-		+	-
Doxorubicin	+	-	-		+	-
Epirubicin	+	-	+	-	+	-
Etoposide	+	-	-		+	+
Floxuridine	+	-	+	-	+	-
Fludarabine	+	-	+	-	+	-
5-Fluorouracil	+	-	+	Toxic	+	-
Idarubicin	+	-	-		+	-
Ifosfamide	+	-	+	-(+) ^c	+	-
Lomustine, ^e 5mg/ml:						
1 hour	+	+	+	T ^f	+ ^g /-	- ^g
4 hours	+	-	+	T ^f	Not tested	
Lomustine, ^e 1mg/ml:						
1 hour	+	-	+	T ^f	+	-
4 hours	+	-	+	T ^f	Not tested	
6-Mercaptopurine	+	-	+	-	+	-
Methotrexate	+	-	+	-	+	-
Pirarubicin	+	-	+ ^h	-	+	-
Streptozocin:						
NaCl, 0.9%	+	-	+	-	+	-/+
glucose, 5%	+	-	+	-	+/- ⁱ	+ ⁱ
Teniposide	+	-(+) ^c	-		+	-
Thiotepa	+	-	+	-	+	-
Vinblastine sulfate	+	+	+	-	+	+
Vincristine sulfate	+	-	-		+	-
Vindesine sulfate	+	-	-		+	-
Vinorelbine sulfate	+	-	-		+	

^aResidual concentration after degradation, 1.48%.

^bMutagenic activity detected for a US formulation, which was 10 times stronger than a French formulation also tested.

^cMutagenic activity detected when the reaction was performed in the presence of 5% glucose.

^dResidual concentration after degradation, 0.04%.

^eThis drug is formulated as a powder; two concentrations were tested after dilution (5 and 1 mg/ml).

^fToxic activity detected, which may have resulted from a problem in preparation of the sample for mutagenicity testing.

^gIn one experiment, 1.22% residual drug was detected. The sample tested for mutagenicity was >99.5% degraded.

^hA reaction time of 24 hours was found necessary for efficient degradation.

ⁱResidual concentration after degradation, 0.7%.

Degradation by sodium hypochlorite

1. Measure the volume of the solution for administration of the cytostatic drug to be degraded.
2. Add an equivalent volume of a 5% sodium hypochlorite solution.
3. If necessary, shake to achieve complete homogeneity of the solution. (An ultrasound bath may be used for this purpose.)
4. Allow to react at room temperature for at least 1 hour.
5. If necessary, check for completeness of degradation.
6. Discard.

Degradation by hydrogen peroxide

1. Measure the volume of the solution for administration of the cytostatic drug to be degraded.
2. Add an equivalent volume of a 30% hydrogen peroxide solution.
3. If necessary, shake to achieve complete homogeneity of the solution. (An ultrasound bath may be used for this purpose.)
4. Allow to react at room temperature for at least 1 hour.
5. If necessary, check for completeness of degradation.
6. Dilute with water and discard.

Degradation by a Fenton reagent

1. Measure the volume of the solution for administration of the cytostatic drug to be degraded.
2. Place in a flask of at least 10 times the volume of solution to be degraded. Place the flask on ice.
3. Add slowly, with stirring, 0.3 g of ferrous chloride, $\text{FeCl}_2 \cdot 2\text{H}_2\text{O}$.
4. Add dropwise, with stirring, 10 ml of 30% hydrogen peroxide solution.
5. Allow to react at room temperature for at least 1 hour.
6. If necessary, check for completeness of degradation.
7. Dilute and discard.

References

- Barek J et al. (1998). Chemical degradation of wastes of antineoplastic agents. Part 3: amsacrine, azathioprine, asparaginase and thiotepa. *Annals of occupational hygiene*, 42:259–266.
- Castegnaro M et al. (1997). Chemical degradation of wastes of antineoplastic agents. Part 2: six anthracyclines: idarubicin, doxorubicin, epirubicin, pirarubicin, aclarubicin and daunorubicin. *International archives of occupational and environmental health*, 70:378–384.
- Hansel S et al. (1997). Chemical degradation of wastes of antineoplastic agents. Part 1: cyclophosphamide, ifosfamide, melphalan. *International archives of occupational and environmental health*, 69:109–114.

ANNEX 3

Clearance levels for radioactive waste

The material in this annex has been produced by the International Atomic Energy Agency and is based on extracts from the following two publications, used with permission:

IAEA (1996). *Clearance levels for radionuclides in solid materials*. Vienna, International Atomic Energy Agency (TECDOC 855).

IAEA (1998). *Clearance of materials resulting from the use of radionuclides in medicine, industry and research*. Vienna, International Atomic Energy Agency (in press).

Table A3.1 *Generic clearance levels for solid waste*

Radionuclide	Clearance level (Bq/g) for moderate quantities	Radionuclide	Clearance level (Bq/g) for moderate quantities
H-3	1×10^6	Sr-89	1×10^3
C-14	1×10^4	Y-90	1×10^3
Na-22	1×10^1	Mo-99	1×10^2
Na-24	1×10^1	Tc-99	1×10^4
P-32	1×10^3	Tc-99m	1×10^2
S-35	1×10^5	In-111	1×10^2
Cl-36	1×10^4	I-123	1×10^2
K-42	1×10^2	I-125	1×10^3
Ca-45	1×10^4	I-131	1×10^2
Ca-47	1×10^1	Pm-147	1×10^4
Cr-51	1×10^3	Er-169	1×10^4
Fe-59	1×10^1	Au-198	1×10^2
Co-57	1×10^2	Hg-197	1×10^2
Co-58	1×10^1	Hg-203	1×10^2
Ga-67	1×10^2	Tl-201	1×10^2
Se-75	1×10^2	Ra-226	1×10^1
Sr-85	1×10^2	Th-232	1×10^0

Note: The generic clearance levels in Table A3.1 are given for moderate quantities of waste (i.e. less than 3 tonnes of cleared waste per year and per facility). They are identical to the exemption levels of the international basic safety standards for protection against ionizing radiation and for the safety of radiation sources (IAEA, 1996). Clearance levels for large quantities are one-tenth of the levels in Table A3.1.

Table A3.2 *Liquid discharge rates to sewers, rivers, or other large water bodies*

Radionuclide	Annual release rate (Bq/year)	Monthly release rate (Bq/month)	Daily release rate (Bq/day)
H-3	10 ⁹	10 ⁸	10 ⁷
C-14	10 ⁷	10 ⁶	10 ⁵
Na-22	10 ²	10	1
Na-24	10 ⁵	10 ⁴	10 ³
P-32	10 ³	10 ²	10
S-35	10 ⁶	10 ⁵	10 ⁴
Cl-36	10 ⁷	10 ⁶	10 ⁵
Ca-45	10 ⁷	10 ⁶	10 ⁵
Ca-47	10 ⁵	10 ⁴	10 ³
Fe-59	10 ³	10 ²	10
Co-57	10 ⁶	10 ⁵	10 ⁴
Co-58	10 ⁵	10 ⁴	10 ³
Ga-67	10 ⁵	10 ⁴	10 ³
Sr-85	10 ³	10 ²	10 ³
Sr-89	10 ⁶	10 ⁵	10 ⁴
Y-90	10 ⁷	10 ⁶	10 ⁵
Mo-99	10 ⁵	10 ⁴	10 ³
Tc-99	10 ⁷	10 ⁶	10 ⁵
Tc-99m	10 ⁶	10 ⁵	10 ⁴
In-111	10 ⁵	10 ⁴	10 ³
I-123	10 ⁶	10 ⁵	10 ⁴
I-125	10 ⁵	10 ⁴	10 ³
I-131	10 ⁵	10 ⁴	10 ³
Pm-146	10 ⁷	10 ⁶	10 ⁵
Er-169	10 ⁷	10 ⁶	10 ⁵
Au-198	10 ⁵	10 ⁴	10 ³
Hg-197	10 ⁶	10 ⁵	10 ⁴
Hg-203	10 ⁴	10 ³	10 ²
Tl-201	10 ⁵	10 ⁴	10 ³
Ra-226	10 ³	10 ²	10
Th-232	10 ³	10 ²	10

Note 1: Table A3.2 provides annual release rates below which water-miscible liquid waste may be unconditionally discharged with normal wastewater by a pipe to a sewer, river, or other large water body. Since it would not necessarily be appropriate for the whole discharge to be made over a very short time, both monthly and daily limits have also been included. These are based on 1/10 and 1/100 of the annual limits respectively.

Note 2: The derivation of clearance levels for liquid releases is described elsewhere (IAEA, 1998). For discharge to sewers, two extreme possible scenarios were considered:

- no radioactive material is retained in sewage sludge but all is discharged to the water body in liquid form;
- all radioactive material discharged is retained in the sewage sludge at the sewage treatment works.

Radiation doses were calculated for both cases, and the more restrictive levels were used to derive the values in Table A3.2, after being divided by a conservative factor of 1000. This factor is intended to reflect the fact that:

- the models in the reference document (IAEA, 1998) were developed for application in temperate European and North American conditions, and the assumptions of diet, agriculture, and lifestyle may not be universally valid; and

— these models did not consider the transfer of radionuclides to terrestrial foodchains as a result of irrigation or use of sewage sludge in agriculture.

Note 3: Activity from patients' discharges, after diagnostic or therapeutic use of radionuclides, should also be considered. This may be achieved by comparing discharges with the clearance levels.

Note 4: For other radionuclides and higher levels of activity, any discharge made should be specifically authorized by the regulatory authority after assessment of all the relevant conditions.

Note 5: In reality, more than one radionuclide will often be involved. To determine whether a mixture of radionuclides is at or below the clearance level, a simple ratio expression can be used:

$$\sum_{i=1}^n \frac{C_i}{C_{Li}} \leq 1$$

where C_i is the concentration of radionuclide i in the material being considered (Bq/g)
 C_{Li} is the clearance level of radionuclide i in the material (Bq/g)
 n is the number of radionuclides in the mixture.

In the above expression, the ratio of the concentration of each radionuclide to the clearance level is summed over all radionuclides in the mixture. If this sum is less than or equal to 1, the material complies with the clearance requirements.

Table A3.3 Gaseous releases into the open air

Radionuclide	Annual release rate (Bq/year)	Monthly release rate (Bq/month)	Daily release rate (Bq/day)
H-3	10 ⁸	10 ⁷	10 ⁶
C-14	10 ⁷	10 ⁶	10 ⁵
Na-22	10 ³	10 ²	10
Na-24	10 ⁶	10 ⁵	10 ⁴
P-32	10 ⁵	10 ⁴	10 ³
S-35	10 ⁵	10 ⁴	10 ³
Cl-36	10 ⁴	10 ³	10 ²
K-42	10 ⁷	10 ⁶	10 ⁵
Ca-45	10 ⁵	10 ⁴	10 ³
Ca-47	10 ⁶	10 ⁵	10 ⁴
Cr-51	10 ⁶	10 ⁴	10 ³
Fe-59	10 ⁵	10 ⁴	10 ³
Co-57	10 ⁶	10 ⁵	10 ⁴
Co-58	10 ⁶	10 ⁵	10 ⁴
Ga-67	10 ⁷	10 ⁶	10 ⁵
Se-75	10 ⁵	10 ⁴	10 ³
Sr-85	10 ⁵	10 ⁴	10 ³
Sr-89	10 ⁵	10 ⁴	10 ³
Y-90	10 ⁷	10 ⁶	10 ⁵
Mo-99	10 ⁶	10 ⁵	10 ⁴
Tc-99	10 ⁴	10 ³	10 ²

Table A3.3 (continued)

Radionuclide	Annual release rate (Bq/year)	Monthly release rate (Bq/month)	Daily release rate (Bq/day)
Tc-99m	10 ⁸	10 ⁷	10 ⁶
In-111	10 ⁶	10 ⁵	10 ⁴
I-123	10 ⁷	10 ⁶	10 ⁵
I-125	10 ⁵	10 ⁴	10 ³
I-131	10 ⁵	10 ⁴	10 ³
Xe-127	10 ⁸	10 ⁷	10 ⁶
Xe-133	10 ⁹	10 ⁸	10 ⁷
Pm-147	10 ⁷	10 ⁶	10 ⁵
Er-169	10 ⁷	10 ⁶	10 ⁵
Au-198	10 ⁶	10 ⁵	10 ⁴
Hg-197	10 ⁷	10 ⁶	10 ⁵
Hg-203	10 ⁵	10 ⁴	10 ³
Tl-201	10 ⁷	10 ⁶	10 ⁵
Ra-226	10 ³	10 ²	10
Th-232	10 ²	10	1

Note 1: Table A3.3 provides annual release rates below which gaseous waste may be unconditionally discharged via ventilation systems (e.g. from laboratory fume cupboards) or other means to the open air. This may be done only in such a way and in such a position as to prevent the gas from re-entering any building. Since it would not necessarily be appropriate for the entire discharge to be made over a very short time, monthly and daily limits have also been included; these are based on 1/10 and 1/100 of the annual limits respectively.

Note 2: The derivation of clearance levels for gaseous releases is described elsewhere (IAEA, 1998). It assumes that a person lives 20 m from the release point and obtains all crop-based foods from an area at least 100 m from the release point and all animal products from an area at least 800 m from the release point. Values in Table A3.3 were then based on radiation doses calculated from the summation of inhalation, injection, and external exposure pathways. The values in the table include a conservative factor of 1000 to reflect the fact that the models in the reference document (IAEA, 1998) were developed for temperate European and North American conditions and may differ for countries with significantly different diets, agriculture, and lifestyles.

Note 3: For other radionuclides and higher levels of activity, any discharge should be specifically authorized by the regulatory authority after assessment of all the relevant conditions.

Reference

IAEA (1996). *International basic safety standards for protection against ionizing radiation and for the safety of radiation sources*. Vienna, International Atomic Energy Agency (Safety Series, No. 115).

ANNEX 4

Procedure to be followed in the event of accidental contamination by mutagenic and carcinogenic products

The text of this annex has been reproduced, with minor editorial changes, from the following document:

Laboratory handling of mutagenic and carcinogenic products. Geneva, World Health Organization, 1998 (unpublished document WHO/PCS/98.9; IPCS Training Module No. 2).

An accident involving contamination by a mutagenic or carcinogenic substance must be systematically planned for because it can affect the entire staff of a laboratory and the equipment. The substance in question may arise in a number of forms (liquid, solid, gas, volatile product, aerosol, etc.) and every eventuality must be catered for.

In every case:

- Emergency exits must be signposted and emergency telephone numbers (poison control centre, fire service, ambulance service, medical centre) must be prominently displayed.
- The emergency services must be notified of the existence of the hazard and of the proposed protocol.
- Emergency equipment must be to hand and trained first-aiders must be available.

A4.1 Immediate action

In every case, responsible persons, whose names and telephone numbers are clearly displayed on the door to the premises concerned, must be informed.

It is the responsibility of the supervisor to notify the medical service, which must record the accident in the register of accidents at work and contact outside services if necessary together with the health and safety committee/works council.

The immediate action taken by the supervisor has a number of objectives:

- to evacuate personnel quickly in accordance with a pre-arranged plan if the contamination is caused by a gas, volatile product, aerosol, powdery solid, or liquid;
- to avoid air currents: doors must be closed and ventilation hoods switched off if the contaminant is a powder;
- to restrict access to the contaminated area;
- to organize prompt decontamination of exposed personnel using appropriate methods;
- to organize prompt decontamination of the premises and exposed equipment.

Adequate precautions must be taken to prevent contamination of premises, equipment and individuals as far as possible.

A4.2 Evacuation of personnel

Personnel must be evacuated very promptly in serious cases of major contamination and where the contaminating product may easily disperse (in the case of gases, volatile products, or aerosols). This evacuation may require the assistance of persons from outside wearing protective clothing appropriate to the scale and type of contamination (gloves, goggles, cellulose mask, cartridge mask, self-contained breathing apparatus, overalls).

A4.3 Decontamination of personnel

Any signs of acute intoxication and/or of a life-threatening condition (injuries, breathing difficulties) must be attended to immediately. Thereafter, and depending on the type of contamination, there are a number of possible scenarios: in every case, clothing that has been soiled or is thought to have been soiled must be removed for decontamination and placed in special sacks.

Contamination of the skin and mucosa

Copious and immediate washing must be carried out on the spot for 20 minutes using cold or tepid water delivered by a shower, eye bath, or any other suitable method.

Never rub or scrub and never use a solvent, including alcohol, which may facilitate penetration of the contaminant through the skin.

The contaminant is diluted by this first rinsing, and the rinse water must be discarded together with mutagenic waste.

If the suspect products are lipophilic (solubility in water < 0.1%) mild detergents may be used on the skin to complete the decontamination. Use of detergents, however, must remain the exception, because they can make it easier for the contaminant to penetrate the skin or mucosa and they should never be used as the method of first resort.

In severe cases, contamination may be continued in hospital where any systemic effects can be treated.

Absorption by mouth

The process of decontamination follows medical or hospital practice (poison control centres). The mouth may, however, be rinsed out on the spot if the affected individual is conscious.

Never induce vomiting in an accident victim.

Inhalation

Individuals affected by inhalation of a contaminant should be evacuated immediately to a non-contaminated area; the process of decontamination will then require the attention of specialist personnel. Treatment of the toxic effects of the contaminant may require hospitalization.

A4.4 Decontamination of premises and equipment

In every case of contamination:

- The safety service must be notified.
- The contaminated area (floors, bench tops, etc.) must be marked off and isolated using a marker or adhesive tape.
- Appropriate protective clothing must be put on (gloves, cellulose mask or cartridge mask or self-contained breathing apparatus, overalls).
- Nothing must be picked up with the bare hands; decontamination must be carried out.

When the contaminant is a liquid:

Absorbent products (e.g. a universal drying agent) may be spread over the soiled surfaces. These absorbent products must then be disposed of in receptacles set aside for genotoxic materials. The affected area should then be copiously washed and rinsed using a solvent appropriate to the contaminant; rinsing and washing liquids should be disposed of as mutagenic effluent. The final rinsing liquid should be tested for mutagenicity (using a chemical analysis, which is faster than the mutagenicity test), and access to the contaminated area must be prohibited until test results are known.

In every case, solutions must be wiped up working from the outside edge of the soiled area in towards the point of first impact to prevent the hazardous product from spreading. These operations must be performed by a properly protected and competent individual.

When the contaminant is a powder:

All forms of ventilation must be switched off to reduce the risk of dispersion and the contaminated area must be cleaned using paper or a cloth impregnated with solvent. Filters must be changed after decontamination. The contaminated area must be covered by a cloth or compresses soaked in water or a neutralizing solution to prevent the generation of particulates which can be inhaled.

Premises and equipment may also be decontaminated using a wet method—initially, specific solvents, decontaminants, or detergents in an aqueous solution or soapy water. Solvents, decontaminants, or detergents should be spread on absorbent paper and discarded after use in the receptacles reserved for toxic substances. Surfaces should be copiously rinsed before the premises are used again.

In every case, solutions must be wiped up working from the outside edge of the soiled area in towards the point of first impact to prevent the hazardous product from spreading.

Small equipment of low cost may be disposed of without cleaning; alternatively it should be decontaminated using the method described above.

Clothing contaminated by accident or used during cleaning must be incinerated.

A4.5 Emergency stand-by equipment

An eye-bath and a shower should be available near a laboratory that uses mutagenic products.

A stock of latex gloves, cellulose masks, self-contained breathing apparatus, overalls, paper, disposable hooded coats, overshoes, and drying agents must be available to personnel. Ideally, a special spill control kit containing the various items of equipment needed should be assembled.

Lastly, it is vital to have a telephone in the immediate vicinity, with the telephone numbers of the supervisor, the medical service, fire service, ambulance service, poison control centre, etc. prominently displayed. This must not be located in the laboratory itself, but in the corridor outside for example.

A4.6 Acts of vandalism, theft, fire, flood

Procedures must be geared above all to prevention of accidents/incidents. However, the laboratory supervisor must be notified at once of any incident so that appropriate action can be taken. Information must be given at once to emergency teams that may have to be brought in from outside. All personnel must be made aware of any theft or act of vandalism; details should be posted so that everyone is informed of the hazards involved.

A4.7 Notification of accidental contamination

Accidental contamination must be notified using a standard-format document, a copy of which must in every case be sent to the medical service. The document must state:

- the day and date of the accident;
- the names of the persons concerned, including those who helped in the decontamination work;
- the premises and equipment contaminated;
- the name of the product that caused the contamination, its volume, presentation, and concentration;
- a description of the operations that resulted in the accident;
- a description of the actions taken after the accident.

All these details must be entered in the safety register.

A4.8 Responsibility

The laboratory supervisor has a duty to inform persons handling products that are known or suspected mutagens and/or carcinogens of the potential hazards.

Specific procedures must be available for personnel to follow.

In the event of an accident, a subsequent inquiry must determine the causes of the accident and establish means of ensuring that recurrences can be prevented.