

# Natural Products from Plants

Second Edition

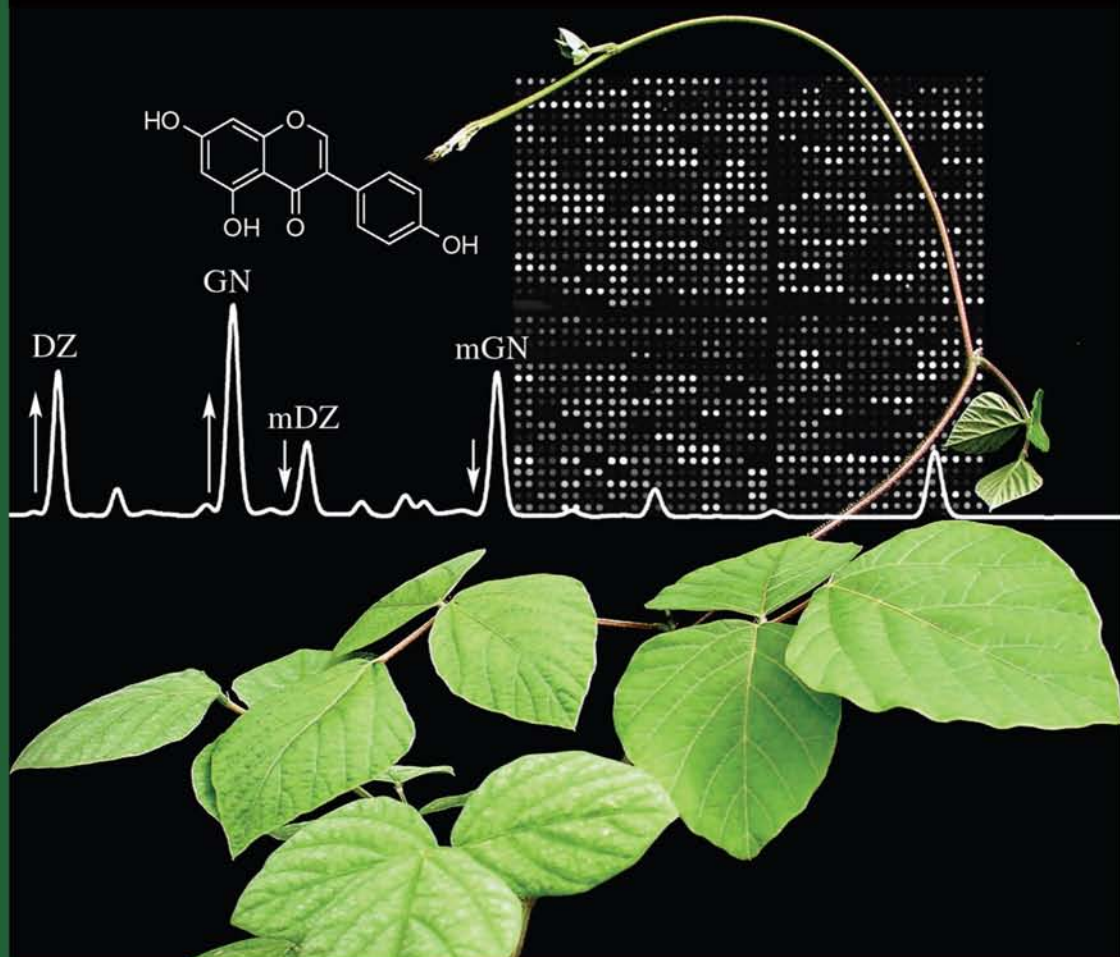

Leland J. Cseke, Ara Kirakosyan, Peter B. Kaufman  
Sara L. Warber, James A. Duke, and Harry L. Brielmann

 Taylor & Francis  
Taylor & Francis Group

# **Natural Products from Plants**

Second Edition



# **Natural Products from Plants**

Second Edition

Leland J. Cseke  
Ara Kirakosyan  
Peter B. Kaufman  
Sara L. Warber  
James A. Duke  
Harry L. Brielmann



**Taylor & Francis**

Taylor & Francis Group

Boca Raton London New York

---

CRC is an imprint of the Taylor & Francis Group,  
an informa business

Published in 2006 by  
CRC Press  
Taylor & Francis Group  
6000 Broken Sound Parkway NW, Suite 300  
Boca Raton, FL 33487-2742

© 2006 by Taylor & Francis Group, LLC  
CRC Press is an imprint of Taylor & Francis Group

No claim to original U.S. Government works  
Printed in the United States of America on acid-free paper  
10 9 8 7 6 5 4 3 2 1

International Standard Book Number-10: 0-8493-2976-0 (Hardcover)  
International Standard Book Number-13: 978-0-8493-2976-0 (Hardcover)  
Library of Congress Card Number 2005056059

This book contains information obtained from authentic and highly regarded sources. Reprinted material is quoted with permission, and sources are indicated. A wide variety of references are listed. Reasonable efforts have been made to publish reliable data and information, but the author and the publisher cannot assume responsibility for the validity of all materials or for the consequences of their use.

No part of this book may be reprinted, reproduced, transmitted, or utilized in any form by any electronic, mechanical, or other means, now known or hereafter invented, including photocopying, microfilming, and recording, or in any information storage or retrieval system, without written permission from the publishers.

For permission to photocopy or use material electronically from this work, please access [www.copyright.com](http://www.copyright.com) (<http://www.copyright.com/>) or contact the Copyright Clearance Center, Inc. (CCC) 222 Rosewood Drive, Danvers, MA 01923, 978-750-8400. CCC is a not-for-profit organization that provides licenses and registration for a variety of users. For organizations that have been granted a photocopy license by the CCC, a separate system of payment has been arranged.

**Trademark Notice:** Product or corporate names may be trademarks or registered trademarks, and are used only for identification and explanation without intent to infringe.

---

#### Library of Congress Cataloging-in-Publication Data

---

Natural products from plants / Leland J. Cseke ... [et al.].-- 2nd ed.  
p. cm.  
Includes bibliographical references and index.  
ISBN 0-8493-2976-0 (alk. paper)  
1. Botanical chemistry. 2. Plant products. I. Cseke, Leland J. II. Title.

QK861.N38 2006  
581.6'3--dc22

2005056059

---

**informa**  
Taylor & Francis Group  
is the Academic Division of Informa plc.

Visit the Taylor & Francis Web site at  
<http://www.taylorandfrancis.com>  
and the CRC Press Web site at  
<http://www.crcpress.com>

---

## *Dedication*

*We dedicate this book to Steven F. Bolling, M.D., the first Gayle Halperin Kahn Professor of Integrative Medicine at the University of Michigan, as well as all the other pioneering individuals who have devoted their lives to the study, application, and conservation of plants.*



---

# *Preface*

---

As a result of teaching many undergraduate and graduate students about plant natural products in a wide range of plant biology courses, the need for a comprehensive yet thorough collection of information on what kinds of natural products plants produce, including why they produce them, became very apparent. Currently, such information is contained within thousands of somewhat disjointed reports about the helpful qualities and toxic effects of different plant species throughout the world. The aim of this second edition of the book is to help bring more unity and understanding to this complicated and often contradictory jumble of information. We updated and revised previously presented information and added more than 50% new topics that deal with plant natural product biochemistry, biotechnology, and molecular biology, as well as new separation techniques and bioassays.

This book is useful to many, including biochemists, natural product chemists, pharmacologists, pharmacists, and molecular biologists; research investigators in industry, federal labs, and universities; physicians, nurses, nurse practitioners, and practitioners of integrative medicine; premedical and medical students; ethnobotanists, ecologists, and conservationists; nutritionists; organic gardeners and farmers; those interested in herbs and herbal medicine; and even lawyers. With the growing interest in this field by professionals and the general public alike, it was important for us to produce a book that encompasses as much information as possible on the natural products produced by plants as well as their importance in today's world. We hope that this book helps to meet this need.

Some of the most compelling reasons for writing a book on natural products in plants include the following:

- While there has been a great deal of progress made in understanding plant natural products, a general lack of knowledge and much misinformation remain about natural products in plants and their uses by people.
- Many of the natural products in plants of medicinal value offer us new sources of drugs that have been used effectively for centuries in traditional medicine. Many compounds used in medicine today have original derivatives that were of plant origin.
- Plants are sources of poisons, addictive drugs, and hallucinogens. These have importance in human medicine and in human social action and behavior.
- Many people are interested in using natural products from plants for preventive medicine, but these people must be made aware of potential harmful effects of such compounds.
- Plants provide us with thousands of novel compounds that give us medicines, fragrances, flavorings, dyes, fibers, foods, beverages, building materials, heavy metal chelators important in bioremediation, biocides, and plant growth regulators.
- Knowledge about how and why plants produce such a vast array of metabolites gives us new insights into how plants use these compounds to deter predators and pathogens, attract and deter pollinators, prevent other plants from competing with themselves for the same resources, and defend themselves against environmental stress.

This book was organized to provide relevant and practical information on each of the above topics. It begins with a discussion of the various types of compounds found in plants (Chapter 1). We then discuss how and why these compounds are made by plants (Chapter 2). In Chapter 3, we consider how the synthesis of these compounds is regulated by environmental stresses, biotic factors, biochemical regulators, and gene expression to provide a better understanding of how these compounds benefit the plants themselves. Seven new chapters following Chapter 3 were added in this new edition of the book: Chapter 4 provides information about plant natural products in the rhizosphere (plant root–soil interface



regions). Chapter 5 covers examples of the molecular biology of natural products. In Chapter 6, we discuss natural product biosynthesis in the pregenomics and genomics eras. A new Chapter 7 deals with plant biotechnology for the production of natural products. Chapters 8, 9, and 10, respectively, guide the reader through analytical and preparative separations of natural products, how natural products are characterized, and bioassays for activity of natural products. In Chapter 11, we discuss the modes of action of natural products at target sites, using classic examples from medicine and cell biology. Chapter 12 includes information on the uses of plant natural products by humans and the risks associated with their use. The principle of synergy between separate kinds of compounds from a single plant source and from more than one plant source is discussed in Chapter 13. Chapter 14 takes a global view of various strategies that are used to conserve plants that produce natural products of value to humans. Finally, in a new Chapter 15, we address the relationship between people and plants.

The individual chapters of this book are organized according to the following format: chapter title, chapter outline, introduction to the chapter, chapter topics and text, conclusions (take-home lessons), and references cited for further reading. In addition, some of the chapters contain boxed essays written by experts in the field to bring diversity to the topics. We chose this format in order to aid the reader in comprehending the material and to stimulate one to probe the chapter topics further. The Appendix to this book (“Information Retrieval on Natural Products in Plants”) helps one to embark on the latter endeavor.

Regarding terminology pertaining to plant metabolites, we often encounter the terms “primary metabolite” and “secondary metabolite” in the literature. Traditionally, *primary metabolite* refers to nucleic acids, amino acids, proteins, lipids, carbohydrates, and various energetic compounds falling within the primary metabolic pathways of each cell. These compounds are essential for plant growth, development, reproduction, and survival. *Secondary metabolite* is a term that was originally coined to describe compounds that were not thought, at the time, to be essential to plant function. This old idea, however, cannot be defended on strictly chemical grounds, because, apparently, all natural products produced by plants have some survival value to the plant. Thus, the modern use of the term “secondary metabolite” typically refers to those compounds of low molecular weight that are often restricted to specific plant families and genera. These compounds may be important for pollination, attraction and deterrence of predators, or defense against pathogenic fungi and bacteria, or they may be essential for plant survival in stressful environments.

In this book, we attempt to avoid the terminology of “primary” and “secondary” by using simply “metabolite,” “product,” or “compound” wherever possible. However, because the traditional terms “primary metabolite” and “secondary metabolite” are still used widely in the literature as acceptable terminology, we continue to use them when we refer to “secondary metabolism” in the traditional sense (see Chapters 4, 6, and 7 for examples).

---

## *The Editors*

---

**Leland J. Cseke, Ph.D.**, earned a doctorate in plant cellular and molecular biology through the Department of Molecular, Cellular, and Developmental Biology at the University of Michigan, Ann Arbor. His dissertation research included the molecular biology, evolution, and biotechnological applications of terpenoid scent compound production in *Clarkia* and *Oenothera* species in the laboratory of Dr. Eran Pichersky. Currently, Dr. Cseke is a research assistant professor in the Department of Biological Sciences at the University of Alabama, Huntsville, where he works in conjunction with Dr. Gopi K. Podila in a large team effort to determine the molecular mechanisms of keystone species in forest ecosystem responses to environmental perturbations. The DOE-funded project represents an “Integrated Functional Genomics Consortium to Increase Carbon Sequestration in Poplar Trees” through the study of aspen Free-Air Carbon dioxide Enrichment (aspen FACE research). In addition, Dr. Cseke investigates the activity of aspen (*Populus tremuloides*) MADS-box genes in wood development. Similarly, Dr. Cseke spent several years as a research assistant professor at Michigan Technological University working to discover the functionality of floral-specific MADS-box genes in aspen flower development. Dr. Cseke was also a postdoctoral fellow in the Department of Plant Sciences at the University of Arizona in the laboratory of Dr. Rich Jorgensen. There, he worked to elucidate the factors involved in functional sense and antisense suppression of genes involved in anthocyanin biosynthesis. Dr. Cseke’s interests include the biosynthesis of plant chemical products, their uses by humans, and the study of the global effects of transgenes on plant metabolism. This led to his coauthoring the first edition of *Natural Products from Plants* (CRC Press, 1999). In addition, Dr. Cseke has done some work in the study of possible methods for improving separation and enhancing the biosynthesis of the cancer-fighting diterpene, taxol, in *Taxus* species in the laboratory of Dr. Peter Kaufman, and his knowledge of such subjects has been directed toward the teaching of classes emphasizing biotechnology and the chemical principles of biology.

**Ara Kirakosyan, Ph.D.**, is associate professor of biology at Yerevan State University, Armenia, and is currently research investigator at the University of Michigan Integrative Medicine program (UMIM). He received a Ph.D. in molecular biology from Yerevan State University, Armenia in 1993. His research fields focus on the phytochemistry and molecular biology of medicinal plants. His research interests include plant cell biotechnology to produce enhanced levels of medicinally important secondary metabolites, and metabolic engineering based on the integration of functional genomics, metabolomics, transcriptomics, and large-scale biochemistry. He carried out postdoctoral research in the Department of Pharmacognosy at Gifu Pharmaceutical University, Gifu, Japan, under the supervision of Prof. Kenichiro Inoue. The primary research topic was molecular biology of glycyrrhizin and a sweet triterpene and unraveling an oxidosqualene synthase gene encoding  $\beta$ -amyrin synthase in cell cultures of *Glycyrrhiza glabra*. In addition, he held several research investigator positions in Germany. The first was under collaborative grant project DLR, at Heinrich-Heine-University, Düsseldorf. The research concerned a lignan anticancer project (the production of cytotoxic lignans from *Linum* [flax]) under the supervision of Prof. Dr. W.A. Alfermann. The second involved a carbohydrate-engineering project, as he was a DAAD Fellow in the Institute of Plant Genetics and Crop Plant Research (IPK) Gatersleben, under the supervision of Prof. Dr. Uwe Sonnewald. Another collaborative grant project on plant cell biotechnology involved the production of dianthrones in cell/shoot cultures of *Hypericum perforatum* (St. John’s wort); this project was carried out with Dr. Donna Gibson at the U.S. Department of Agriculture (USDA), Agricultural Research Service, Plant Protection Research Unit, U.S. Plant, Soil, and Nutrition Laboratory, Ithaca, NY. In 2002, he was a Fulbright Visiting Research Fellow at the University of Michigan, Department of Molecular, Cellular, and Developmental Biology in the Laboratory of Prof. Peter Kaufman. Dr. Kirakosyan is author of several chapters in five books and principal author of more than 50 peer-reviewed research publications. Dr. Kirakosyan is a full member of the Phytochemical Society of

Europe and the European Federation of Biotechnology. He received several awards, fellowships, and research grants from the United States, Japan, and the European Union.

**Peter B. Kaufman, Ph.D.**, is a professor of biology emeritus in the Department of Molecular, Cellular, and Developmental Biology (MCDB) at the University of Michigan and is currently senior scientist, University of Michigan Integrative Medicine program (UMIM). He received his B.Sc. in plant science from Cornell University in Ithaca, New York, in 1949 and his Ph.D. in plant biology from the University of California, Davis, in 1954 under the direction of Professor Katherine Esau. He did postdoctoral research as a Muellhaupt Fellow at Ohio State University, Columbus. He has been a visiting research scholar at the University of Calgary, Alberta, Canada; University of Saskatoon, Saskatoon, Canada; University of Colorado, Boulder; Purdue University, West Lafayette, Indiana; USDA Plant Hormone Laboratory, BARC-West, Beltsville, Maryland; Nagoya University, Nagoya, Japan; Lund University, Lund, Sweden; International Rice Research Institute (IRRI) at Los Baños, Philippines; and Hawaiian Sugar Cane Planters' Association, Aiea Heights. Dr. Kaufman is a fellow of the American Association for the Advancement of Science and received the Distinguished Service Award from the American Society for Gravitational and Space Biology (ASGSB) in 1995. He served on the editorial board of *Plant Physiology* for 10 years and is the author of more than 220 research papers. He has published eight professional books to date and taught popular courses on Plants, People, and the Environment, Plant Biotechnology, and Practical Botany at the University of Michigan. He received research grants from the National Science Foundation (NSF), the National Aeronautics and Space Administration (NASA), the U.S. Department of Agriculture (USDA) BARD Program with Israel, National Institutes of Health (NIH), Xylomed Research, Inc., and Pfizer Pharmaceutical Research. He produced, with the help of Alfred Slote and Marcia Jablonski, a 20-part TV series entitled, "House Botanist." He was past chairman of the Michigan Natural Areas Council (MNAC), past president of the Michigan Botanical Club (MBC), and former Secretary-Treasurer of the American Society for Gravitational and Space Biology (ASGSB). He is currently doing research on natural products of medicinal value in plants at the University of Michigan Medical School in the laboratory of Stephen F. Bolling, M.D., and serves on the research staff of UMIM.

**Sara Warber, M.D.**, is a family physician with a long-standing interest in botanical medicine that predates her entrance into medical school. She completed a combined residency and fellowship in family medicine at the University of Michigan. She was a Robert Wood Johnson Clinical Scholars Program Fellow at the university. She is currently co-director of UMIM (University of Michigan Integrative Medicine program) and assistant professor in the Department of Family Practice Medicine at the University of Michigan. Her interests include research into the safe and efficacious use of herbal medicines. She is collaborating on research and education related to the use of other complementary and alternative modalities in the optimization of health. In addition, Dr. Warber is designing community-oriented research to facilitate improved health through better understanding of cultural dimensions and traditional ways of healing. She lives with her husband and two sons in the Ann Arbor, Michigan area and enjoys spending time in the many remaining wild habitats surrounding the Great Lakes.

**James A. Duke, Ph.D.**, retired from the USDA where he served as an economic botanist for 30 years. In retirement, he served five years with Nature's Herbs and two years with Allherb.com. He is an adviser to or trustee for the Amazon Center for Environmental Education and Research (ACEER), American Botanical Council (ABC), and conducts ecotours in Maine and Peru. He is the author of more than 25 books, the best seller, *The Green Pharmacy* (now in six languages); his most recent, the *CRC Handbook of Medicinal Plants* (second edition); and the *CRC Handbook of Medicinal Spices*. Dr. Duke graduated Phi Beta Kappa from the University of North Carolina at Chapel Hill in 1961 and was awarded a distinguished alumnus award in 2002. Before joining the USDA, he spent several years in Central and South America studying neotropical ethnobotany and living with various ethnic groups while closely observing their deep dependence on forest products. He is very interested in natural foods and nutritional approaches to preventive medicine and spent 2 years advising the Designer Food Program at the National Institutes of Health (NIH) and 5 years with the National Cancer Institute's (NCI) cancer screening

program. He is a popular lecturer on the subjects of ethnobotany, herbs, medicinal plants, and new crops and their ecology, and has taped dozens of TV and radio shows. Dr. Duke is now an emeritus adjunct professor in herbal medicine at the Tai Sophia Institute, which frequently holds classes in his Green Pharmacy Garden, Fulton, Maryland, where he grows more than 300 medicinal plants. The USDA maintains his very useful phytochemical and ethnobotanical databases online ([www.ars-grin.gov/duke/](http://www.ars-grin.gov/duke/)).

**Harry Brielmann, Ph.D.**, received his Ph.D. in synthetic organic chemistry from Wesleyan University, Middletown, Connecticut, in 1994. He spent the following year investigating marine natural products as a postdoctoral fellow for Professor Paul Scheuer. His next postdoctoral position was in the area of organometallic chemistry for Professor John Montgomery at Wayne State University, Detroit. Dr. Brielmann then spent 7 years (1998 to 2005) as a medicinal chemist at Neurogen Corporation in Branford, Connecticut. Dr. Brielmann currently teaches chemistry at Glastonbury High School in Glastonbury, Connecticut.



---

## *Contributors*

**V.S. Bhinu** University of Tsukuba, Tsukuba, Ibaraki, Japan

**Mary Jo Bogenschutz-Godwin** Kaaawa, Hawaii

**Harry L. Brielmann** Gastonbury High School, Gastonbury, Connecticut

**Leland J. Cseke** University of Alabama, Huntsville, Alabama

**Feng Chen** University of Tennessee, Knoxville, Tennessee

**P. Dayanandan** Madras Christian College, Tambaram, Madras, India

**James A. Duke** Green Farmacy Garden, Fulton, Maryland

**James E. Hoyt** University of Michigan, Ann Arbor, Michigan

**Katherine N. Irvine** De Montfort University, Leicester, United Kingdom

**Masilamani Jeyakumar** Cordlars Pte Ltd., Singapore

**Peter B. Kaufman** University of Michigan, Ann Arbor, Michigan

**Ara Kirakosyan** University of Michigan, Ann Arbor, Michigan

**Ari Kornfeld** Humboldt State University, Arcata, California

**Carl Li** State University of New York at Buffalo, Buffalo, New York

**Hong Lin** USDA Agricultural Research Service, Crop Diseases, Pests and Genetics,  
Parlier, California

**Casey R. Lu** Humboldt State University, Arcata, California

**Maureen McKenzie** DENALI BioTechnologies, L.L.C., Soldotna, Alaska

**Kothandarman Narasimhan** National University of Singapore, Singapore

**Sheela Reuben** National University of Singapore, Singapore

**William N. Setzer** University of Alabama in Huntsville, Huntsville, Alabama

**Mitchell Seymour** University of Michigan, Ann Arbor, Michigan

**Kevin Spelman** Tai Sophia Institute, Laurel, Maryland

**Sanjay Swarup** National University of Singapore, Singapore

**Bernhard Vogler** University of Alabama in Huntsville, Huntsville, Alabama

**Sara L. Warber** University of Michigan, Ann Arbor, Michigan

**Joshua S. Yuan** University of Tennessee, Knoxville, Tennessee

---

# Contents

---

<b>1</b>	<b>Phytochemicals: The Chemical Components of Plants</b> .....	<b>1</b>
	<i>Harry L. Brielmann, William N. Setzer, Peter B. Kaufman, Ara Kirakosyan, and Leland J. Cseke</i>	
<b>2</b>	<b>How and Why These Compounds Are Synthesized by Plants</b> .....	<b>51</b>
	<i>Leland J. Cseke, Casey R. Lu, Ari Kornfeld, Peter B. Kaufman, and Ara Kirakosyan</i>	
<b>3</b>	<b>Regulation of Metabolite Synthesis in Plants</b> .....	<b>101</b>
	<i>Leland J. Cseke and Peter B. Kaufman</i>	
<b>4</b>	<b>Plant Natural Products in the Rhizosphere</b> .....	<b>143</b>
	<i>V.S. Bhinu, Kothandarman Narasimhan, and Sanjay Swarup</i>	
<b>5</b>	<b>Molecular Biology of Plant Natural Products</b> .....	<b>165</b>
	<i>Sheela Reuben, Leland J. Cseke, V.S. Bhinu, Kothandarman Narasimhan, Masilamani Jeyakumar, and Sanjay Swarup</i>	
<b>6</b>	<b>The Study of Plant Natural Product Biosynthesis in the Pangenomics and Genomics Eras</b> .....	<b>203</b>
	<i>Feng Chen, Leland J. Cseke, Hong Lin, Ara Kirakosyan, Joshua S. Yuan, and Peter B. Kaufman</i>	
<b>7</b>	<b>Plant Biotechnology for the Production of Natural Products</b> .....	<b>221</b>
	<i>Ara Kirakosyan</i>	
<b>8</b>	<b>Traditional, Analytical, and Preparative Separations of Natural Products</b> .....	<b>263</b>
	<i>Leland J. Cseke, William N. Setzer, Bernhard Vogler, Ara Kirakosyan, and Peter B. Kaufman</i>	
<b>9</b>	<b>Characterization of Natural Products</b> .....	<b>319</b>
	<i>Bernhard Vogler and William N. Setzer</i>	
<b>10</b>	<b>Bioassays for Activity</b> .....	<b>389</b>
	<i>William N. Setzer and Bernhard Vogler</i>	
<b>11</b>	<b>Modes of Action at Target Sites</b> .....	<b>415</b>
	<i>Sara L. Warber, Mitchell Seymour, Peter B. Kaufman, Ara Kirakosyan, and Leland J. Cseke</i>	



<b>12</b>	<b>The Uses of Plant Natural Products by Humans and Risks Associated with Their Use .....</b>	<b>441</b>
	<i>Peter B. Kaufman, Ara Kirakosyan, Maureen McKenzie, P. Dayanandan, James E. Hoyt, and Carl Li</i>	
<b>13</b>	<b>The Synergy Principle at Work with Plants, Pathogens, Insects, Herbivores, and Humans.....</b>	<b>475</b>
	<i>Kevin Spelman, James A. Duke, and Mary Jo Bogenschutz-Godwin</i>	
<b>14</b>	<b>Plant Conservation .....</b>	<b>503</b>
	<i>Mary Jo Bogenschutz-Godwin, James A. Duke, Maureen McKenzie, and Peter B. Kaufman</i>	
<b>15</b>	<b>Relationship between People and Plants.....</b>	<b>535</b>
	<i>Sara L. Warber and Katherine N. Irvine</i>	
<b>Appendix</b>		
	<b>Information Retrieval on Natural Products in Plants.....</b>	<b>547</b>
	<b>Index of Chemicals .....</b>	<b>553</b>
	<b>Index of Plant Species and Common Names .....</b>	<b>575</b>
	<b>Subject Index.....</b>	<b>587</b>

# 1

---

## *Phytochemicals: The Chemical Components of Plants*

---

Harry L. Brielmann, William N. Setzer, Peter B. Kaufman, Ara Kirakosyan,  
and Leland J. Cseke

### CONTENTS

1.1	Introduction .....	2
1.2	Lipids and Derivatives.....	3
1.2.1	Hydrocarbons .....	3
1.2.1.1	Saturated Hydrocarbons.....	4
1.2.1.2	Unsaturated Hydrocarbons.....	4
1.2.2	Functionalized Hydrocarbons .....	6
1.2.2.1	Halogenated Hydrocarbons.....	6
1.2.2.2	Alcohols .....	6
1.2.2.3	Sulfides and Glucosinolates.....	7
1.2.2.4	Aldehydes and Ketones .....	7
1.2.2.5	Esters .....	8
1.2.2.6	Fatty Acids .....	8
1.2.3	Terpenes.....	10
1.2.3.1	Hemiterpenes: C <sub>5</sub> .....	12
1.2.3.2	Monoterpenes: C <sub>10</sub> .....	12
1.2.3.3	Sesquiterpenes: C <sub>15</sub> .....	14
1.2.3.4	Diterpenes: C <sub>20</sub> .....	14
1.2.3.5	Triterpenes: C <sub>30</sub> .....	17
1.2.3.6	Tetraterpenes: C <sub>40</sub> .....	19
1.3	Aromatics .....	19
1.3.1	Tetrapyrroles.....	19
1.3.2	Phenols .....	19
1.3.2.1	Simple Phenols.....	20
1.3.2.2	Phenol Ethers .....	21
1.3.2.3	Phenylpropanoids.....	22
1.3.2.4	Flavonoids .....	22
1.3.2.5	Tannins .....	25
1.3.2.6	Quinones .....	26
1.4	Carbohydrates.....	27
1.4.1	Monosaccharides .....	27
1.4.2	Oligosaccharides .....	28
1.4.3	Polysaccharides .....	29
1.5	Amines and Alkaloids .....	30
1.5.1	Amines.....	30
1.5.1.1	Aliphatic Monoamines.....	30
1.5.1.2	Aliphatic Polyamines .....	30
1.5.1.3	Aromatic Amines .....	30
1.5.2	Alkaloids .....	30
1.6	Amino Acids, Nonprotein Amino Acids, and Proteins .....	36
1.6.1	Amino Acids.....	37
1.6.2	Nonprotein Amino Acids .....	37

1.6.3	Proteins.....	37
1.6.3.1	Storage Proteins, Lectins, and Diet.....	39
1.7	Nucleic Acids, Nucleotides, and Nucleosides.....	40
1.8	Conclusions.....	41
	References.....	42

---

## 1.1 Introduction

**Phytochemicals**, as the word implies, are the individual chemicals from which plants are made. In this chapter, we will look at these materials, specifically, the organic components of higher plants. Numerous journals, individual books, and encyclopedic series of books have been written on this subject. The goal here is to review this area in a concise format that is easily understandable. The reader not familiar with chemistry may be somewhat intimidated by the material presented here. However, we believe that understanding the chemical composition of plants is a prerequisite to understanding many of the remaining topics of this book. This is especially true for material covered in Chapters 2 and 3. For those interested in reviewing a specific area in greater detail, the references section includes numerous citations for each organic group covered.

During the course of this survey, several themes will be emphasized. These include (1) the rich diversity of chemical structures known to be synthesized by plants through an amazingly diverse network of metabolic pathways (see Figure 2.1 in Chapter 2); (2) basic differences in the chemical properties of the compounds; (3) adaptive functions of these compounds for plants; (4) uses of the compounds by humans (see essays below); and (5) examples of typical plants (listed by common name and scientific binomial name) that contain the respective types of compounds. Often, these will be derived from common plants with which most of us are familiar. Some marine algal plants are also included, because they contain many truly unique bioactive molecules.

The general categories of plant natural products are organized very broadly in terms of increasing **oxidation state**. This begins with the lipids, including the simple and functionalized hydrocarbons, as well as the terpenes, which are treated separately. Following this are the unsaturated natural products, including the polyacetylene and aromatic compounds. We then cross over into the realm of the primarily hydrophilic molecules, including the sugars, and continue with those that can form salts, including the alkaloids, the amino acids, and the nucleosides. Overall, this scheme provides a simple organizational pattern for discussing the phytochemicals. It is consistent with the way that chemists often categorize organic chemicals in general and is roughly equivalent to a **normal-phase chromatographic analysis** of a given plant species. Like any organizational scheme for this subject, be it taxonomic, phylogenetic, or biochemical, it should only serve as a rough guide.

---

### Essay on Phytochemicals of Medicinal Value in Plants

In common usage today, many phytochemicals are associated with health benefits. They have a long history, which continues today, as medicines (Rouhi, 2003b). Many, though not all, of these materials are classified as **secondary metabolites**. This terminology suggests, often incorrectly, that they are not essential for the normal growth, development, or reproduction of the plant. Numerous journals, individual books (Robinson, 1991; Bruneton, 1999; Duke, 1992), dictionaries (Buckingham, 2005), and databases (Duke, 2005) were dedicated to plant natural products. Journals in natural products chemistry recognized by the **American Society of Pharmacognosy** include *Chemistry of Natural Compounds* (Russian), *Economic Botany*, *Fitoterapia*, *Journal of Antibiotics*, *Journal of Asian Natural Products Research*, *Journal of Essential Oil Research*, *Journal of Ethnopharmacology*, *Journal of Natural Products*, *Journal of Natural Remedies*, *Natural Products Letters*, *Natural Products Reports*, *Natural Toxins*, *Nigerian Journal of Natural Products and Medicines*, *Pharmaceutical Biology* (note name change from *International Journal of Pharmacognosy*), *Phytochemical Analysis*, *Phytochemistry*, *Phytochemistry Reviews*, *Phytomedicine*, *Phytotherapy*

*Research, Planta Medica, Toxicon, and Zeitschrift für Naturforschung.* Professional societies dedicated to research on phytochemistry include the American Society of Pharmacognosy ([www.phcog.org](http://www.phcog.org)), the Phytochemical Society of Europe ([www.dmu.ac.uk/ln/pse/psetoday.htm](http://www.dmu.ac.uk/ln/pse/psetoday.htm)), AFERP (Association Francaise pour l'Enseignement et al Recherche en Pharmacognosie; [www.aferp.univ-rennes1.fr/aferpnouveau/index.htm](http://www.aferp.univ-rennes1.fr/aferpnouveau/index.htm)), the Phytochemical Society of North America ([www.ucalgary.ca/~dabird/psna](http://www.ucalgary.ca/~dabird/psna)), and the Society of Medicinal Plant Research ([www.ga-online.org](http://www.ga-online.org)), among others.

---

---

### Essay on Natural Products and Commercial Medicines (Rouhi, 2003a)

Natural products have, until recently, been the primary source of commercial medicines and drug leads. A recent survey revealed that 61% of the 877 drugs introduced worldwide can be traced to or were inspired by natural products. However, beginning in the 1990s, natural product drug discovery was virtually eliminated in most big pharmaceutical companies. This was primarily due to the promise of the then-emerging field of combinatorial chemistry (Cseke et al., 2004), whereby huge libraries of man-made small molecules could be rapidly synthesized and evaluated as drug candidates.

Thus far, this approach has led to lukewarm results at best. From 1981 to 2002, no combinatorial compounds became approved drugs, although several are currently in late-stage clinical trials. At the same time, the number of new drugs entering the market has dropped by half, a figure of which the large pharmaceutical corporations are painfully aware. The haystack is larger, but the needle within it is more elusive. This has led only recently to a newfound respect for the privileged structures inherent within natural products (DeSimone et al., 2004).

Of the roughly 350,000 species of plants believed to exist, one-third of those have yet to be discovered. Of the quarter million that have been reported, only a fraction of them have been chemically investigated. Many countries have become aware of the value of the biodiversity within their borders and have developed systems for exploration as well as preservation. At the same time, habitat loss is the greatest immediate threat to biodiversity (Frankel et al., 1995; see also Chapter 14).

---

---

## 1.2 Lipids and Derivatives

**Lipids** are often defined as water-insoluble biomolecules that are soluble in nonpolar solvents (Bruice, 2004). This is a convenient definition because it encompasses a large area of chemical space, including many types of compounds that are otherwise hard to classify. There are two problems with this definition. First, given a large enough hydrocarbon (**hydrophobic**) component, most organic compounds could fall within this scope. Second, many of the classical lipids (for example, the fatty acids) have significant solubility in water.

A more constricted definition of lipids is to simply classify them as fatty acids and their derivatives, and to treat other hydrocarbon-based natural products separately. **Fatty acids** are carboxylic acids that contain a long, hydrocarbon chain. The derivatives of fatty acids may be acylglycerol esters, wax esters, or alcohols such as sterols. Additional acid derivatives include phosphates (glycerophospholipids) or carbohydrates (glycoglycerolipids).

### 1.2.1 Hydrocarbons

Comprising a relatively small group of compounds, the least polar organic natural products are the **hydrocarbons** (see plant examples illustrated in Figure 1.1). Hydrocarbons are simply molecules that contain only hydrogen and carbon atoms. The aliphatic hydrocarbons are straight chain hydrocarbons,

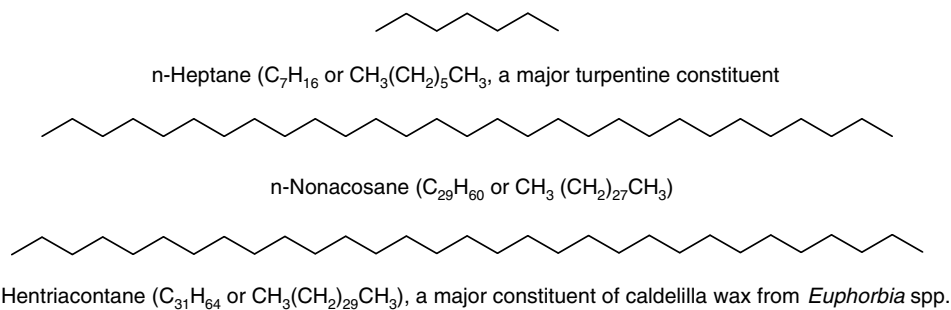

**FIGURE 1.1** Some hydrocarbon natural products in plants.

usually having an odd number of carbon atoms, resulting from the decarboxylation of their fatty acid counterparts (Savage et al., 1996). Devoid of any heteroatoms, these compounds have relatively simple structures. Hydrocarbons, in general, may be either **saturated** or **unsaturated** — the latter contain multiple bonds. Each double bond results in two fewer hydrogen atoms relative to the saturated counterpart (thus, four fewer hydrogen atoms for triple bonds) and is, therefore, in a higher oxidation state. They may contain straight chains, branched chains, as well as rings. Being purely organic in nature, they are highly insoluble in water, that is, they are “greasy.” With rare exceptions, such as highly halogenated compounds, they are less dense than water. Compounds containing aromatic rings generally show increased stability. Highly aromatic compounds may have reduced solubility in common organic solvents, due to stronger intermolecular interactions. Note that those highly branched and often cyclic hydrocarbons derived from isoprene can exist as hydrocarbons; however, these materials (terpenes) will be considered separately in Section 1.2.3.

### 1.2.1.1 Saturated Hydrocarbons

**Saturated hydrocarbons** are the simplest and least polar organic natural products. **Methane** ( $\text{CH}_4$ , sometimes referred to as marsh gas) is an odorless gas that does not occur naturally in plants to any degree. However, it is one of the principal decomposition products, from **methanogens** (methane-producing bacteria). Methane can provide a renewable energy source, something the U.S. Department of Energy, among others, has taken an interest in (Ferry, 1994). Among the gases accumulating in the atmosphere and contributing to the **greenhouse effect** and **global warming**, methane is 21 times as harmful as carbon dioxide, according to the U.S. Environmental Protection Agency (Thorneloe, 1993).

Common hydrocarbon examples, such as hexane,  $\text{CH}_3(\text{CH}_2)_4\text{CH}_3$ , are not generally found in plants, but rather, are derived from fossilized plant and animal matter. **Turpentine**s, commonly used as paint removers, consist of simple hydrocarbons, particularly  **$\alpha$ -** and  **$\beta$ -pinene** as well as ***n*-heptane**  $\text{CH}_3(\text{CH}_2)_5\text{CH}_3$ , as found in conifers, including the Jeffrey pine (*Pinus jeffreyi*) and the gray pine (*P. sabiniana*). These compounds are produced in resin ducts and are found in blister-like bubbles located along the tree trunks. These are natural insecticides that deter feeding by insect predators, such as bark beetles. The **pitch** from the bubbles found on trunks of white fir (*Abies concolor*) is used by Native Americans to treat burns so as to prevent infection, hasten healing, and reduce pain.

In living plants, saturated hydrocarbons are universally distributed as the waxy coatings (cuticular waxes) on leaves and as **cuticle** waxes on the surfaces of fruits (Hamilton, 1995; Eglinton and Hamilton, 1967). Typical examples include ***n*-nonacosane**  $\text{CH}_3(\text{CH}_2)_{27}\text{CH}_3$  and **hentriacontane**  $\text{CH}_3(\text{CH}_2)_{29}\text{CH}_3$ . Several plants are rich in aliphatic hydrocarbons used in vegetable oils. For example, **olive oil**, derived from the fruits of olive (*Olea europea*), contains hydrocarbons ranging from  $\text{C}_{13}$  to  $\text{C}_{28}$  (Dell’Agli and Bosisio, 2002). Branched simple alkanes (again excluding terpenes) rarely occur in significant quantity in plants.

### 1.2.1.2 Unsaturated Hydrocarbons

The simplest **unsaturated hydrocarbon** is **ethylene**,  $\text{H}_2\text{C}=\text{CH}_2$ , an important plant hormone (Davies, 2004). **Plant hormones** such as ethylene are small organic compounds that influence physiological

responses at very low concentrations. Produced by the amino acid **methionine**, ethylene causes trees to lose their leaves (**abscission**), stems to thicken, and fruit to ripen. In the latter case, adding low concentrations of ethylene to the air can artificially promote fruit ripening, as with apples (*Malus* spp.) or pineapple (*Ananas comosus*). Concentrations as low as 0.01 ppm were shown to distort the growth of tomato and marigold plants, causing what is termed **epinasty**. Larger unsaturated hydrocarbons are also common as **plant waxes**. Exceptionally high amounts of alkenes were detected in rye (*Secale cereale*) pollen, rose (*Rosa* spp.) petals, and sugarcane (*Saccharum* spp.). As the chain length and degree of unsaturation increase, the hydrocarbons become waxy and then solid at room temperature. Waxes may be either long-chain hydrocarbons or esters of fatty acids.

#### 1.2.1.2.1 Polyacetylenes

Unsaturated natural products can contain not only double bonds but also triple bonds, either in the form of acetylenes or nitriles. The **polyacetylenes** are a unique group of naturally occurring hydrocarbon derivatives characterized by one or more acetylenic groups in their structures (Wu et al., 2004). The electronic arrangement of the carbon atoms in a triple bond results in a linear shape for this region of the molecule. Typical polyacetylenes (see Figure 1.2 for a listing) often contain a wide variety of additional functional groups. The domestic carrot (*Daucus carota*), for example, contains four polyacetylenes, the major one being **falcarinol** (Lund and White, 1990), which is a mild neurotoxin found only to be present in 2 mg·kg<sup>-1</sup> (dry weight) of carrot roots. Other plants, such as the water dropwort (*Oenanthe crocata*), are commonly found near streams in the Northern Hemisphere and contain several toxic polyacetylenes and should not be consumed (Hansen and Boll, 1986). The water dropwort (*Oenanthe crocata*) contains the violent toxin, **cicutoxin**, which can result in convulsions and respiratory paralysis (Uwai et al., 2000).

Polyacetylenes have a fairly specific distribution in plant families, existing regularly only in the Campanulacae, Asteraceae, Araliaceae, Pittosporaceae, and Apiaceae families. Polyacetylenes are also found in the higher fungi, where their typical chain length is from C<sub>8</sub> to C<sub>14</sub>, whereas the polyacetylenes from higher plants are typically from 14 to 18 carbons in length. Biosynthetically, the polyacetylenes are likely to be derived by enzymatic dehydrogenation from the corresponding olefins. The toxicity of many of the polyacetylenes, including those in the aforementioned water dropwort (*Oenanthe crocata*), as well as fool's parsley (*Aethusa cynapium*), may account for their ability to deter predators in some plants. Similarly, both **wyerone acid** (Nawar and Kuti, 2003) in the broad bean (*Vicia faba*) and **safynol** (Redl et al., 1994) in safflower oil from *Carthamus tinctorius* have been shown to act as natural **phytoalexins**, helping to deter the microorganisms that attack these plants. Several polyacetylenes are shown in Figure 1.2.

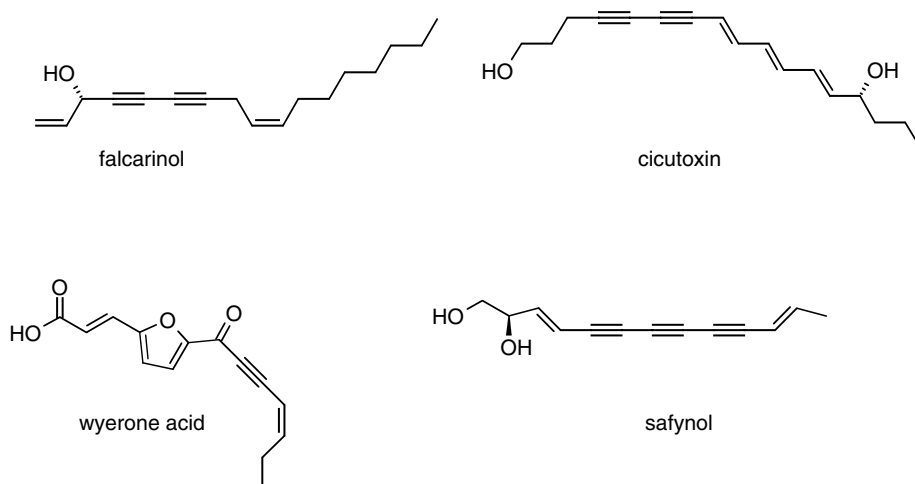

FIGURE 1.2 Some polyacetylenes in plants.

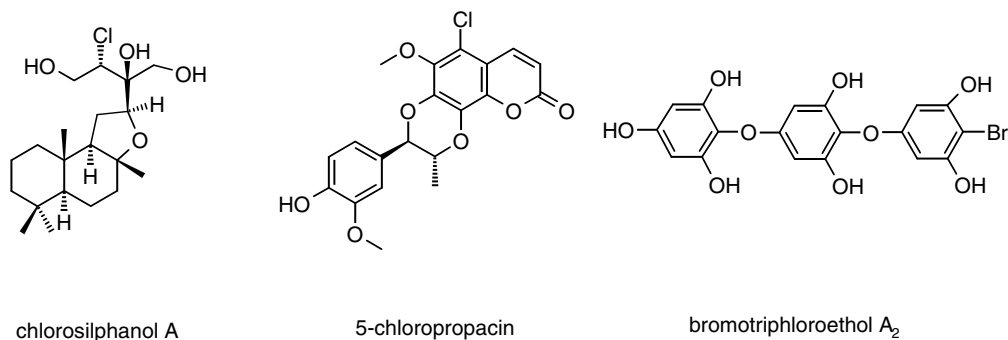

FIGURE 1.3 Halogenated plant natural products.

## 1.2.2 Functionalized Hydrocarbons

Excluding the lipids and the terpenes, simple **functionalized hydrocarbons** are less abundant but not uncommon in plants. Here, we consider these in ascending order from halide, to alcohol and sulfur-containing hydrocarbons, then to aldehydes and ketones, stopping just before the fatty acids.

### 1.2.2.1 Halogenated Hydrocarbons (Scheuer, 1973, 1978)

A **halogen** is any of the group 7A elements found on the periodic table of elements (fluorine, chlorine, bromine, iodine, or astatine). Although virtually unknown among their terrestrial counterparts, the marine environment has long been recognized as a source for natural products that contain both chlorine and bromine (Blunt et al., 2004). Iodinated natural products are rare but have been known since the 1970s, and fluorinated natural products were also identified. In the latter case, the source of fluorine in structures such as **nucleocidin** is believed to be derived from fluoroacetyl Co-A (Shaw, 2001). For the other halogens, **haloperoxidases**, such as vanadium bromoperoxidase, are the primary biogenetic source (Butler and Carter-Franklin, 2004). Beginning in the Scheuer laboratories at the University of Hawaii in the 1960s, thousands of different halogenated natural products have since been isolated, often with exotic structures. Examples of halogenated phytochemicals include the chlorinated labdane diterpenoid, **chlorosilphanol A**, from *Silphium perfoliatum* (Pcolinski et al., 1994); the chlorinated coumarin, **5-chloropropacin**, from *Mondia whitei* (Patnam et al., 2005); and the brominated phlorethol, **bromotriphloroethol A<sub>2</sub>**, from the brown alga *Cystophora congesta* (Koch and Gregson, 1984), shown in Figure 1.3.

As one example of many, the genus *Laurencia* was found to produce a prodigious assortment of halogenated natural products, several of which are shown in Figure 1.4 (Erickson, 1983). All of these natural products have had their structures confirmed by absolute total synthesis. These include **laurencin** (Irie, Susuki, and Masamune, 1965), **rogiloxepane A** (Guella et al., 1992), **laurallene** (Fukuzawa and Kurosawa, 1979), **prepinnaterpene** (Fukuzawa et al., 1985), **laurencial** (Miyashita et al., 1998), and **kumausallene** (Suzuki et al., 1983).

### 1.2.2.2 Alcohols

An **alcohol** can be any of a class of compounds characterized by the presence of a hydroxyl group (–OH group) covalently bonded to a saturated carbon atom. Large varieties of volatile aliphatic **alcohols** occur in small concentrations in plants and were classically referred to within the group of **essential oils**. Their role may be related to their often strong odors, attracting them to insect pollinators and animal seed disseminators (see Chapter 2). All of the straight-chain alcohols from C<sub>1</sub> (methanol) to C<sub>10</sub> were found in plants in either free or esterified form. Several larger alcohols, such as **ceryl alcohol**, CH<sub>3</sub>(CH<sub>2</sub>)<sub>25</sub>OH, are regular constituents of cuticular waxes. Like the terpenes, the aliphatic alcohols, including **cis-3-hexen-1-ol** (leaf alcohol), have characteristic and sometimes attractive odors and are of interest to the fragrance industry (Clark, 1990). The list of alcohols in plants, however, goes on and on, and the reader will notice that the hydroxyl group is associated with many different types of plant molecules.

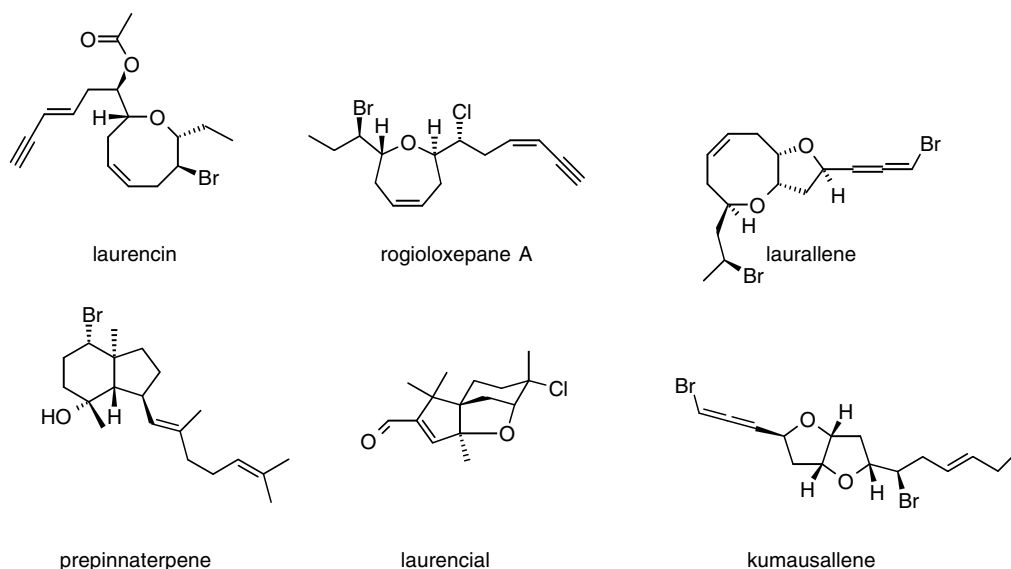

FIGURE 1.4 Halogenated natural products from *Laurencia* species.

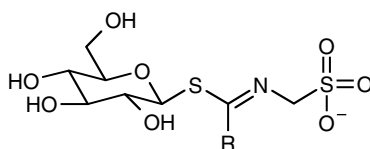

FIGURE 1.5 General structure of glucosinolates.

### 1.2.2.3 Sulfides and Glucosinolates (Host and Williamson, 2004)

Hydrocarbon **sulfides** have at least one sulfur atom and are found in relatively few plants. Those that contain them, such as skunk cabbage (*Symplocarpus foetidus*), are readily recognizable by their obnoxious odors. Sulfides, including the simple hydrocarbon sulfides, are common among the *Allium* species (onions and their relatives), many of which are **lachrymators** (substances that make the eyes water) and have pungent odors. Cyclic examples, such as thiophenes, are limited primarily to the Asteraceae (aster or sunflower family) and are found in association with the polyacetylenes (Christenson et al., 1990).

The **glucosinolates** are sulfur-containing natural products primarily from the Brassicaceae (mustard family). As shown in Figure 1.5, they consist of a thioglucose and sulfonated oxime, with a specific side chain for each of the over 100 glucosinolates that have been identified (Sørensen, 1990; Rosa et al., 1997).

Some epidemiological data support the possibility that glucosinolate breakdown products derived from *Brassica* vegetables (cabbage, broccoli, and relatives) may protect against human cancers, especially in the gastrointestinal tract and lung (Johnson, 2003).

### 1.2.2.4 Aldehydes and Ketones

**Aldehydes** are any of a class of compounds characterized by the presence of a carbonyl group (C=O group) in which the carbon atom is bonded to at least one hydrogen atom. **Ketones**, on the other hand, are compounds where the carbon atom of the carbonyl group is bonded to two other carbon atoms. The citrus fruits, including orange (*Citrus* spp.), lemon (*Citrus limon*), as well as bergamot (*Monarda didyma*), may be cold-pressed to yield terpene-derived essential oils that are rich in aldehyde content, providing them with a unique aroma (Blanco et al., 1995; Lota et al., 2002; Verzera et al., 2003). The aldehyde and ketone components of these oils include **nootkatone**, **citral**, **octanal**, **sinensal** (Moshonas, 1971), and others, as shown in Figure 1.6.



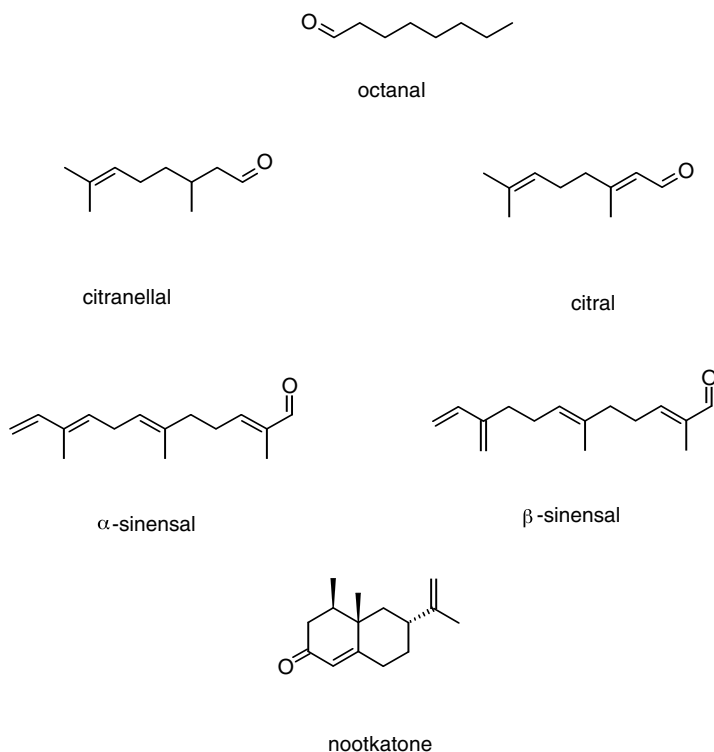

**FIGURE 1.6** Aldehyde and ketone natural products from citrus oils.

**TABLE 1.1**

Volatile Ester (and Other) Components of Strawberries, Apples, and Pineapples

Strawberries	Apples	Pineapples
Ethyl butyrate	Ethyl acetate	Ethyl acetate
Ethyl isovalerate	Ethyl butyrate	Methyl isocaproate
Isoamyl acetate	Ethyl valerate	Methyl isovalerate
Ethyl caproate	Propyl butyrate	Methyl caprylate
2-hexenyl acetate		Nonesters: furaneol
Nonesters:		
Furaneol		
<i>Cis</i> -3-hexenal		
Diacetyl		

### 1.2.2.5 Esters

**Esters** are any class of compounds structurally related to carboxylic acids but in which the hydrogen atom in the carboxyl group ( $-\text{COOH}$  group) was replaced by a hydrocarbon group, resulting in a  $-\text{COOR}$  structure (where R is the hydrocarbon). Thus, esters are formed through the condensation of alcohols (having an  $-\text{OH}$  group) and acids (having a  $-\text{COOH}$  group). They tend to have strong and often pleasant odors. Some of the volatile ester (and other) components present in strawberries (*Fragaria chiloensis*), apples (*Malus* spp.), and pineapples (*Ananas comosus*) are presented in Table 1.1.

### 1.2.2.6 Fatty Acids

As mentioned in the introduction to this section, **fatty acids** are the simplest lipids. They are characterized by a polar hydrophilic head region connected to a long hydrophobic tail. Some lipids, including the fats,

TABLE 1.2

## Common Fatty Acids

Trivial Name	Carbon Atoms	Double Bonds	IUPAC Name	Sources
Butyric acid	4	0	Butanoic acid	Butterfat
Caproic acid	6	0	Hexanoic acid	Butterfat
Caprylic acid	8	0	Octanoic acid	Coconut oil
Capric acid	10	0	Decanoic acid	Coconut oil
Lauric acid	12	0	Dodecanoic acid	Coconut oil
Myristic acid	14	0	Tetradecanoic acid	Palm kernel oil
Palmitic acid	16	0	Hexadecanoic acid	Palm oil
Palmitoleic acid	16	1	9-Hexadecenoic acid	Animal fats
Stearic acid	18	0	Octadecanoic acid	Animal fats
Oleic acid	18	1	9-Octadecenoic acid	Olive oil
Vaccenic acid	18	1	11-Octadecenoic acid	Butterfat
Linoleic acid	18	2	9,12-Octadecadienoic acid	Safflower oil
$\alpha$ -Linolenic acid (ALA)	18	3	9,12,15-Octadecatrienoic acid	Flaxseed (linseed) oil
$\gamma$ -Linolenic acid (GLA)	18	3	6,9,12-Octadecatrienoic acid	Borage oil
Arachidic acid	20	0	Eicosanoic acid	Peanut oil, fish oil
Gadoleic acid	20	1	9-Eicosenoic acid	Fish oil
Arachidonic acid (AA)	20	4	5,8,11,14-Eicosatetraenoic acid	Liver fats
EPA	20	5	5,8,11,14,17-Eicosapentaenoic acid	Fish oil
Behenic acid	22	0	Docosanoic acid	Rapeseed oil
Erucic acid	22	1	13-Docosenoic acid	Rapeseed oil
DHA	22	6	4,7,10,13,16,19-Docosahexaenoic acid	Fish oil
Lignoceric acid	24	0	Tetracosanoic acid	Small amounts in most fats

are used for energy storage, but most are used to form **lipid/protein membranes** (i.e., partitions that divide intracellular compartments and separate the cell from its surroundings).

There are well over one hundred different types of fatty acids, though the most common in plants are **oleic acid** and **palmitic acid**. The hydrocarbon chain may be **saturated**, as in palmitic acid, or **unsaturated**, as in oleic acid. Fatty acids differ from each other primarily in chain length and the locations of multiple bonds. Thus, palmitic acid (16 carbons, saturated) is symbolized 16:0; oleic acid, which has 18 carbons with one *cis* double bond at carbon 9, may be symbolized 18:1<sup>9</sup>; other nomenclature systems may also be used (Davidson and Cantrill, 1985). Double bonds are assumed to be *cis* unless otherwise indicated. Several common fatty acids are shown in Table 1.2.

Although fatty acids are utilized as the building-block components of the saponifiable lipids, only traces occur in the free-acid form in cells and tissues. Normally, these exist in various bound forms and may comprise up to 7% of the weight of dried leaves. They include long-chain esters (**waxes**), triacylglycerols (**fats**), as well as glycerophospholipids and sphingolipids (membrane lipids), as shown in Table 1.3.

Some generalizations can be made concerning the various fatty acids of higher plants. The most abundant have an even number of carbons ranging from C<sub>14</sub> to C<sub>22</sub>. Unsaturated fatty acids predominate in higher plants, with oleic acid (C<sub>18</sub>) being one of the most common. Unsaturated fatty acids have lower melting points than saturated fatty acids of the same chain lengths.

Diets high in saturated fats have been implicated in an increased risk of coronary heart disease (Temple, 1996; De Lorgeril, 1998), cancers (Gallus et al., 2004), and diabetes (Stoeckli and Keller, 2004), and replacement of sources of saturated fats with unsaturated fats was suggested. Some fats have protective properties.  **$\alpha$ -Linolenic acid** is apparently a major cardioprotective nutrient (De Lorgeril and Salen, 2004). It was suggested that a diet with an optimum balance of  $\omega$ -6 and  $\omega$ -3 polyunsaturated fatty acids may delay the onset of neurodegenerative disorders, such as Parkinson's disease and Alzheimer's disease (Youdim et al., 2000). The  $\omega$ -6 and  $\omega$ -3 polyunsaturated fatty acids, including linoleic acid (an  $\omega$ -6 fatty acid) and  $\alpha$ -linolenic acid (an  $\omega$ -3 fatty acid), are essential to human nutrition, while saturated fatty acids (e.g., palmitic and stearic acids) as well as the monounsaturated fatty acids (oleic and palmitoleic

TABLE 1.3

Some Common Fatty Acid Esters (Lipids)

Lipid Type	Examples	Formula
Triacylglycerols (fats)	Tristearin	$\begin{array}{c} \text{H}_2\text{C}-\text{OCOR}_1 \\   \\ \text{HC}-\text{OCOR}_2 \\   \\ \text{H}_2\text{C}-\text{OCOR}_3 \end{array}$
Glycerophospholipids	Phosphatidic acid, lecithin	$\begin{array}{c} \text{H}_2\text{C}-\text{OCOR}_1 \\   \\ \text{HC}-\text{OCOR}_2 \\   \\ \text{H}_2\text{C}-\text{OPO}_3\text{H} \end{array}$

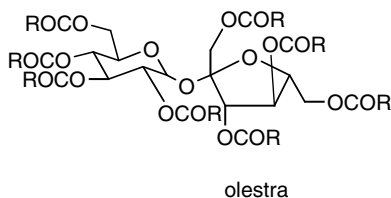

FIGURE 1.7 Olestra®.

acids) are generally classified as non-essential (Cunnane, 2003). The non-essential fatty acids are apparently more easily replaced in tissue lipids than are the essential fatty acids.

The essential fatty acids — linoleic acid and  $\alpha$ -linolenic acid — cannot be synthesized *de novo* by humans. These fatty acids serve as biosynthetic precursors to long-chain polyunsaturated fatty acids (e.g., arachidonic acid, eicosapentaenoic acid, and docosahexaenoic acid) and are necessary for the formation of healthy cell membranes, the proper development and functioning of the brain and nervous system, and the production of eicosanoids (thromboxanes, leukotrienes, and prostaglandins). The primary sources of linoleic acid are seeds, nuts, grains, and legumes.  $\alpha$ -Linolenic acid is found in the green leaves of plants, including phytoplankton and algae, and in flax (*Linum usitatissimum*) seeds, canola (*Brassica napus*) seeds, walnuts (*Juglans* spp.), and soybeans (*Glycine max*).

**Trans-fatty acids** are found in partially hydrogenated vegetable oil, in meats, and in dairy products. There is evidence that the intake of trans-fatty acids should be reduced, because they are associated with an increased risk of coronary heart disease (Wilson et al., 2001). One method of reducing dietary fat intake is to use a nonnutritional synthetic fat substitute, such as **Olestra**® (a mixture of hexa-, hepta-, and octa-fatty acid esters of sucrose; see also Figure 1.7). Its use, however, has been associated with gastrointestinal distress (Barlam and McCloud, 2003) and diminished bioavailability of lipophilic vitamins (Schlagheck et al., 1997).

**Waxes** containing polymeric esters formed by the linking of several  $\Omega$ -hydroxyacids are especially prominent in the waxy coatings of conifer needles. The two most common acids in such waxes are **sabnic acid**,  $\text{HOCH}_2(\text{CH}_2)_{10}\text{CO}_2\text{H}$ , and **juniperic acid**,  $\text{HOCH}_2(\text{CH}_2)_{14}\text{CO}_2\text{H}$ . The lipid constituents of cork and cuticle are known as **suberin** and **cutin**, respectively. Both are composed of high-molecular-weight fatty acid esters (see Chapter 2 for more details).

### 1.2.3 Terpenes

The **terpenes** have been prized for their essential oils and their use as fragrances for over two thousand years (Turner, 1970). An archaeological investigation in Egypt in 1997 unearthed boswellic acids from the resin of frankincense (*Boswellia* spp.) dating from 400 to 700 AD (Van Bergen et al., 1997). Records

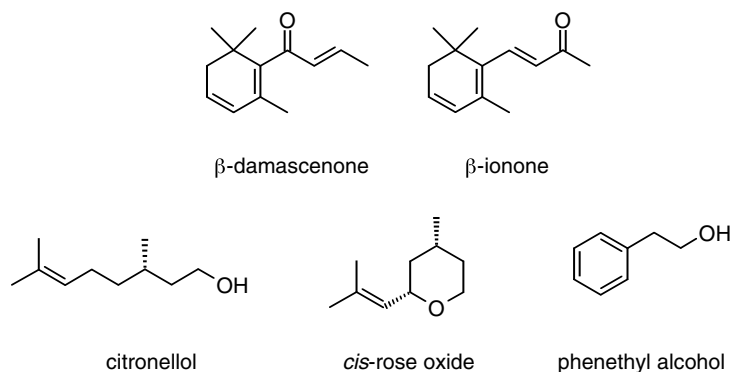
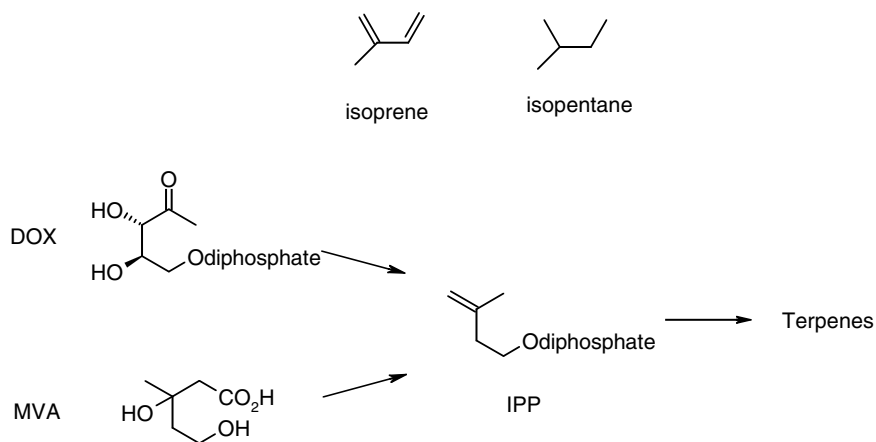

**FIGURE 1.8** The primary olfactory constituents of rose oil.

from the Middle Ages of terpene-based essential oils were preserved, and chemical analysis of the oils began early in the nineteenth century. Commerce in essential oils and **aromatherapy** continues today. For example, rose (*Rosa* spp.) fragrance has enchanted many. Bulgarian rose oil requires over 4000 kg of petals to produce 1 kg of steam-distilled oil (Kovat, 1987). Over 260 constituents have been identified, many of which are olfactory relevant. The five compounds having the highest odor impact, listed in order of priority, are **β-damascenone**, **β-ionone**, **citronellol**, **cis-rose oxide**, and **phenethyl alcohol** (Figure 1.8) (Ohloff, 1994).

It should be apparent that even the simple terpenes found in fragrances have a considerable amount of structural diversity. Fortunately, despite their diversity, the terpenes have a simple unifying feature by which they are defined and by which they may be easily classified. This generality, referred to as the **isoprene rule**, was postulated by Otto Wallach in 1887. This rule describes all terpenes as having fundamental repeating five-carbon isoprene units (Croteau, 1998). Thus, terpenes are defined as a unique group of hydrocarbon-based natural products that possess a structure that may be hypothetically derived from **isoprene**, giving rise to structures that may be divided into isopentane (2-methylbutane) units (Figure 1.9).

The actual biosynthetic route to terpenes is not quite so simple. Two different biosynthetic pathways produce the main terpene building block, **isopentenyl diphosphate (IPP)** (Figure 1.8) (see also Croteau and Loomis, 1975). The first is referred to as either the MEP (methylerythritol phosphate) or DOX (1-deoxy-D-xylulose) pathway. Here, IPP is formed in the chloroplast, mainly for the more volatile mono- and diterpenes. The second biosynthetic route is known as the MVA (**mevalonic acid**) pathway. This takes



**FIGURE 1.9** Isoprene, isopentane, and the biogenetic origin of the terpenes.

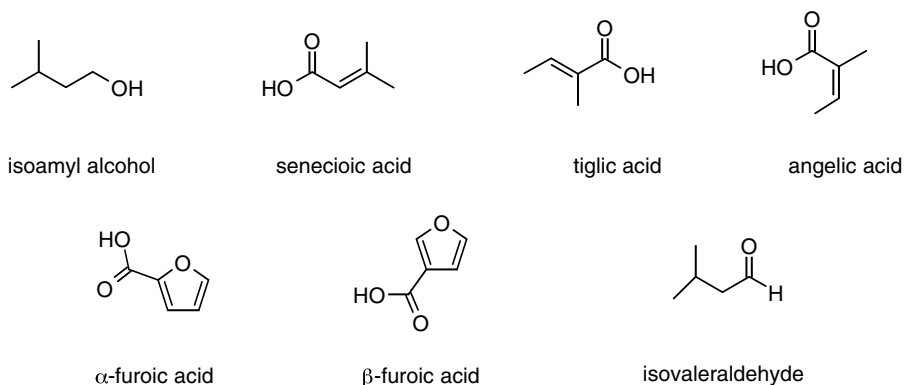

FIGURE 1.10 Assorted hemiterpenes.

place in the cytosol, producing sesquiterpenes (Janses and de Groot, 2004). A simplified outline is shown in Figure 1.9. Detailed reviews are available (Kuzuyama, 2002; Dubey et al., 2003; Eisenreich et al., 2004).

Terpenes are thus classified by the number of five-carbon units they contain:

Hemiterpenes:  $C_5$

Monoterpenes:  $C_{10}$

Sesquiterpenes:  $C_{15}$

Diterpenes:  $C_{20}$

Sesterterpenes:  $C_{25}$  (rare)

Triterpenes:  $C_{30}$

Carotenoids:  $C_{40}$

Like all natural products, within this simple classification lies an enormous amount of structural diversity that leads to a wide variety of terpene-like (or **terpenoid**) compounds. Some 30,000 terpenes were identified thus far (Sacchetti and Poulter, 1997). Note that the simplest examples of the terpenes are technically hydrocarbons, though they are considered separately here because of their common structural features.

The function of terpenes in plants (see Chapter 2) is generally considered to be both ecological and physiological. Many of them inhibit the growth of competing plants (**allelopathy**). Some are known to be insecticidal; others are found to attract insect pollinators (see Chapter 2). Another plant hormone, **abscissic acid**, is one of the sesquiterpenes (Srivastava, 2002). The diterpene **gibberellic acid** is also one of the major plant hormones. More than 130 gibberellins were identified, and new terpene structures continue to be reported each year (Silverstone and Sun, 2000).

### 1.2.3.1 Hemiterpenes: $C_5$

Hemiterpenes are made of one five-carbon unit and are the simplest of all terpenes. **Isoprene** is emitted from the leaves of many plants and contributes to the natural haze (**phytochemical smog**) in some regions, such as the Smoky Mountains (Kang et al., 2001). Numerous five-carbon compounds are known that contain the isopentane skeleton, including **isoamyl alcohol**, **senecioic acid**, **tiglic acid**, **angelic acid**,  **$\alpha$ - and  $\beta$ -furoic acid**, and **isovaleraldehyde** (Figure 1.10). There is evidence that these compounds may assist in plant defense by repelling herbivores or by attracting predators and parasites of herbivores (Holopainen, 2004).

### 1.2.3.2 Monoterpenes: $C_{10}$

A bewildering assortment of isoprene-based decane arrangements exist in nature. This gives the term “terpenoid” a particularly elastic meaning and is reminiscent of some of the current combinatorial efforts

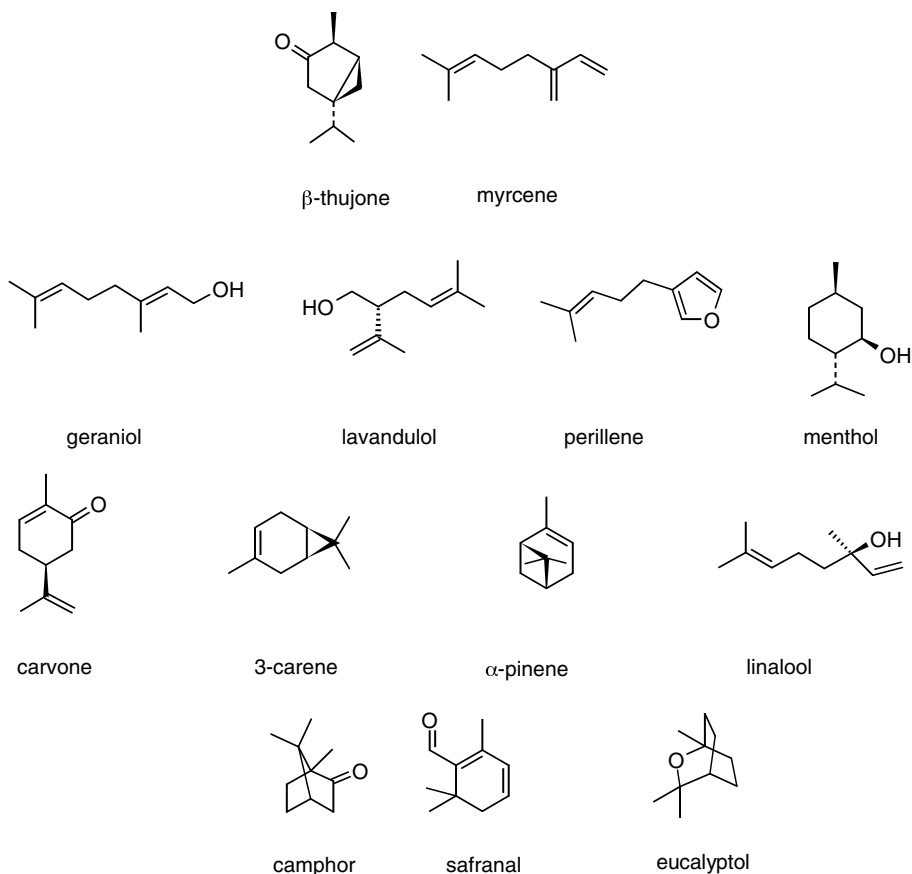

**FIGURE 1.11** Assorted monoterpenes.

employed in the pharmaceutical industry (Liao et al., 2003). The **monoterpenoids** are the major component of many **essential oils** and, as such, have economic importance as flavors and perfumes. Common acyclic examples include **myrcene**, **geraniol**, and **linalool**. Cyclic structures include many well-known compounds, including **menthol**, **camphor**, **pinene**, and **limonene**. A variety of common monoterpenes is shown in Figure 1.11.

Most of the monoterpenes illustrated in Figure 1.11 come from common sources with which most of us are familiar. The **thujone** diastereomers are rapidly metabolized convulsants. They act as noncompetitive blockers of the  $\gamma$ -aminobutyric acid (GABA) gated chloride channel (Sirisoma et al., 2001). **Myrcene** is found in the essential oil of bay leaves (*Laurus nobilis*) as well as hops (*Humulus lupulus*). It is used as an intermediate in the manufacture of perfumes (Opdyke, 1987). **Geraniol**, which is isomeric with linalool, constitutes the major part of the oil of geraniums (*Pelargonium graveolens*) and is also found in essential oils of citronella (*Cymbopogon nardus*) (Temple et al., 1991), lemongrass (*Cymbopogon citratus* or *C. flexuosus*), and others. **Lavandulol** is one of the principal ingredients of oil of lavender (*Lavandula augustifolia*), commonly used in male perfumes (Shellie et al., 2002). **Perillene** can be found in the perilla (*Perilla frutescens*), native to South and East Asia (Yuba et al., 1995). **Menthol** is a well-known monoterpene that is found in the essential oil of peppermint (*Mentha  $\times$  piperita*) and other members of the mint family (Lamiaceae). **Carvone** is a common monoterpene. It is one of the main olfactory components of caraway seed (*Carum carvi*), and it shows antifungal activity (McGeady et al., 2002). **3-Carene** is a cyclopropane containing monoterpene, derivatives of which have shown anesthetic activity (Librowski et al., 2004).  **$\alpha$ -Pinene**, the major ingredient in turpentine, may play a significant role in the activity of hydrocarbon-degrading bacteria in nature (Trudgill, 1994; Hylemon and Harder, 1998). **Linalool** is one of the principle constituents of coriander (*Coriandrum sativum*), a

common spice (Gil et al., 2002). It is also one of the most common floral scent compounds found in flowering plants, and it is a common flavor compound in various teas (Dudareva et al., 1996). **Safranal** is chiefly responsible for the characteristic odor of saffron (*Crocus sativus*) (Kanakakis et al., 2004). **Eucalyptol** (1,8-cineole) is the main component of the essential oil of eucalyptus leaf (*Eucalyptus globulus*). Eucalyptol, along with **camphor**, form the major constituents of **rosemary oil** (Kovar et al., 1987). Recent research showed that eucalyptol is effective in reducing inflammation and pain and in promoting leukemia cell death (Moteki et al., 2002).

### 1.2.3.3 Sesquiterpenes: C<sub>15</sub> (Fraga, 2003)

Derived from three isoprene units, the C<sub>15</sub> sesquiterpenes exist in aliphatic, bicyclic, and tricyclic frameworks. Like the monoterpenes, most of the sesquiterpenes are components of the essential oil of the plant from which they are derived. An important member of this series is **farnesol**, with pyrophosphate that serves as a key intermediate in terpenoid biosynthesis (see Chapter 2). Farnesol has demonstrated cancer chemopreventive activity (Crowell and Gould, 2004). Some common sesquiterpenes are shown in Figure 1.12. A boxed essay on the antimalarial sesquiterpene, **artemisinin**, derived from sweet wormwood (*Artemisia annua*), is presented below.

---

#### Essay on Artemisinin, a Sesquiterpene Derived from Qinghao (*Artemisia annua*)

In China, in 168 BC, the Qinghao plant (*Artemisia annua*) was described in the medical treatise, *52 Remedies*, found in the Mawangdui Tomb (Li and Wu, 2003). In the United States, this plant is known as sweet annie or sweet wormwood. In 340 AD, the antifever properties of Qinghao were first described by Ge Hong of the East Yin Dynasty. The active ingredient of Qinghao was isolated by Chinese scientists in 1972 (Meshnick, 2002). Known as **artemisinin** in the West, it is today a potent and effective antimalarial drug, especially in combination with other medicines. It is presently marketed as a close derivative known as **artemether** and is marketed in several countries as **Artemnam**<sup>®</sup> by Arenco Pharmaceutica, Belgium (Haynes and Vonwiller, 1994). This derivative lacks the lactone ring, resulting in greater stability, better pharmacokinetic properties, and increased potency relative to artemisinin. Drugs of this peroxide class are gaining in importance as parasites are becoming resistant to current treatments such as **mefloquine** (Ploypradith, 2004). The chemical structures of artemisinin and artemether are shown in Figure 1.13.

---

The **cadinenes** (Bordoloi et al., 1989) occur as essential oils derived from juniper and cedar trees. **Santonin** is an antihelmintic that is isolated from wormseed (*Artemisia maritima*). **Caryophyllene**, first synthesized in 1963 (Corey, Mitra, and Uda, 1964), is one of the principal components of oil of cloves (*Eugenia caryophyllata*). **Helenalin** is one of numerous pseudoguaianolide sesquiterpene lactones isolated from arnica oil (*Arnica montana*). It recently demonstrated antitrypanosomal activity (Hoet et al., 2004; Schmidt et al., 2002). **Acorone** is a sesquiterpene diketone present in the essential oil of sweet flag (*Acorus calamus*; Mazza, 1985). Finally, **tetrahydroidentin B** is one of the bitter eudesmolides unique to the common dandelion (*Taraxacum officinale*; Zielinska and Kisiel, 2000).

### 1.2.3.4 Diterpenes: C<sub>20</sub> (Hanson, 2004)

The **diterpenes** are a widely varied group of compounds based on four isoprene groups. Because of their higher boiling points, they are not considered to be essential oils. Instead, they are classically considered to be **resins**, the material that remains after steam distillation of a plant extract. Several diterpenes are shown in Figure 1.14.

Many interesting examples may be mentioned here. The cyclic ether **zoapatanol** is derived from the Mexican zoapatle plant (*Montanoa tomentosa*). It has been used as an abortifacient (Dong et al., 1989;

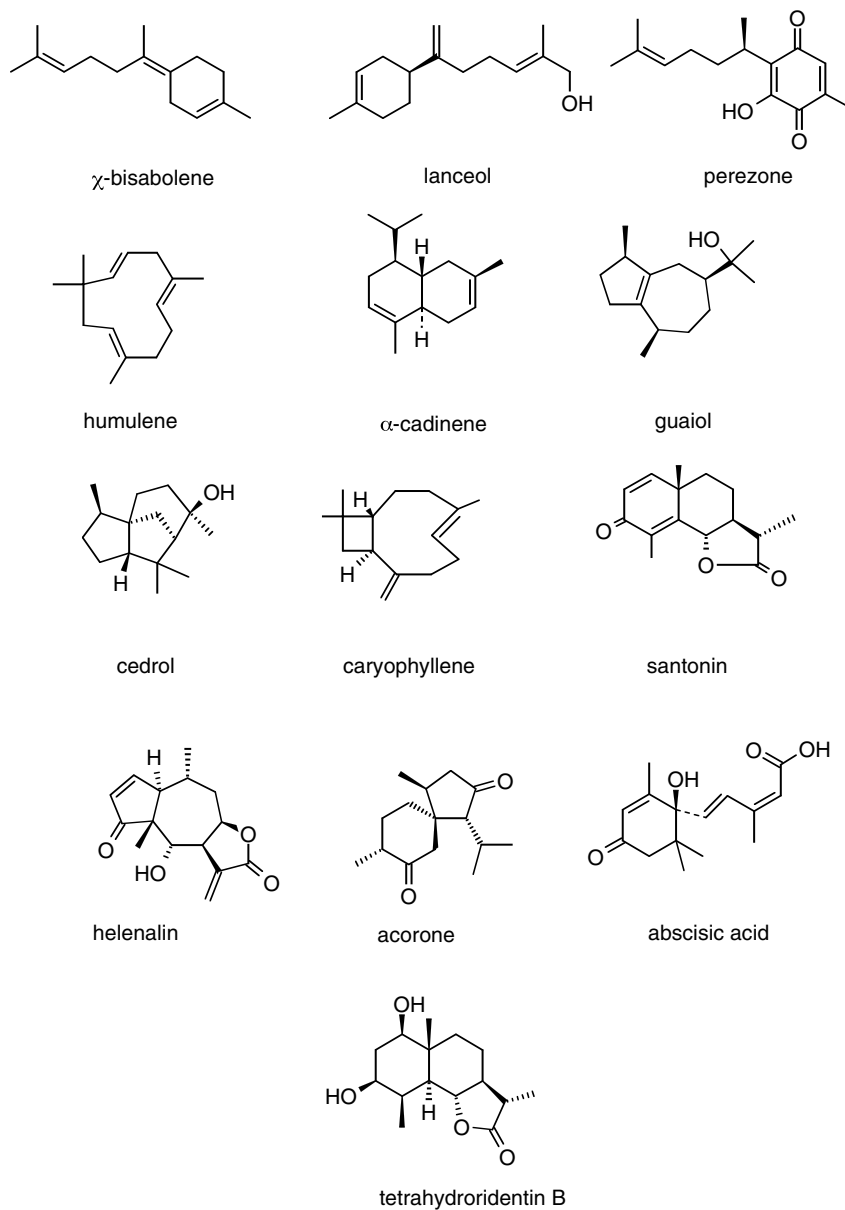

FIGURE 1.12 Assorted sesquiterpenes.

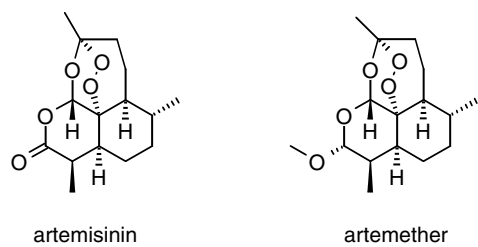

FIGURE 1.13 Artemisinin and artemether.



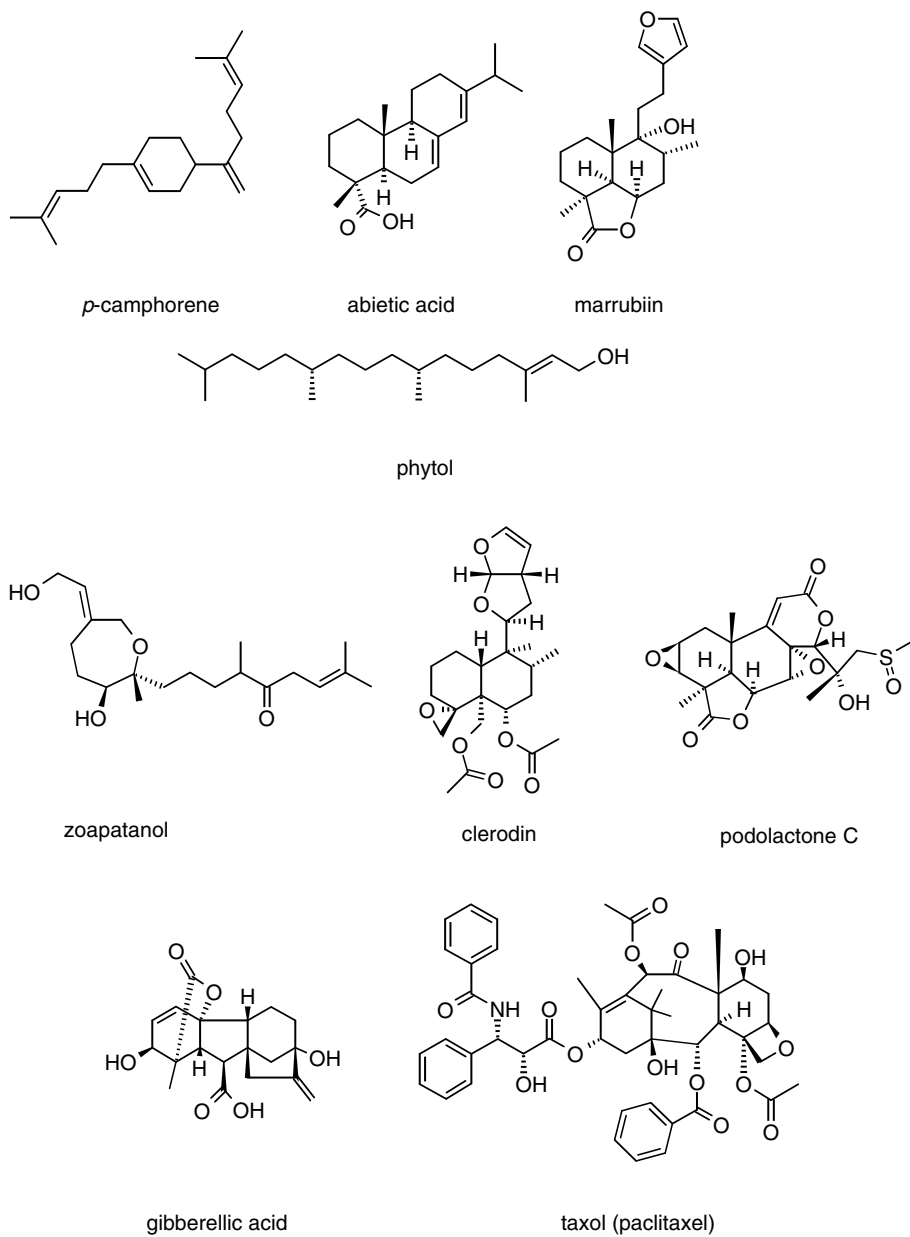

FIGURE 1.14 Assorted diterpenes.

Waller et al., 1987). A number of **clerodanes** were isolated from *Ajuga*, *Salvia*, and *Teucrium* species. They have been found to possess insect antifeedant activity (Krishna Kumari et al., 2003). A variety of cytotoxic lactones were isolated from *Podocarpus* species. These **podolactones** (Barrero et al., 2003) and **nigilactones** (Shrestha et al., 2001) have plant regulatory properties as well as antileukemic activity. The **gibberellins** comprise an important group of widely distributed **plant hormones**. These fall into two series, including a C<sub>20</sub> family represented by gibberellin and a C<sub>19</sub> series for which **gibberellic acid** (GA<sub>3</sub>) (see Figure 1.14) is typical (Hedden and Kamiya, 1997). **Marrubiin** is a diterpene lactone from white horehound (*Marrubium vulgare*). It has been used as a vasorelaxant (El Bardai et al., 2003). **Taxol**<sup>®</sup> or **paclitaxol** (derived from needles and bark of *Taxus* spp., yews) is a wholly unique antimitotic agent used to treat breast cancer (see Section 1.5.3 and Figure 1.14). Chemically, it is made up of a diterpenoid core with an alkaloid side group. It binds to microtubules and stabilizes them, as opposed to all other antimitotics of the tubulin-binding type, such as **vincristine**, the **podophyllotoxins**, and **colchicine** (see Chapter 11 for more information).

### 1.2.3.5 Triterpenes: C<sub>30</sub> (Connolly and Hill, 2004)

The C<sub>30</sub> **terpenes** are based on six isoprene units and are biosynthetically derived from **squalene**. They are often high-melting colorless solids and are widely distributed among plant resins, cork, and cutin. There are several important groups of triterpenes, including common triterpenes, steroids, saponins, sterolins, and cardiac glycosides. Among these is **azadirachtin** (Schmutterer, 1988), a powerful insect antifeedant derived from seeds of the neem tree (*Azadirachta indica*) (see Chapter 12, Section 12.3.2 [by P. Dayanandan] on neem trees in India and the medical uses of azadirachtin). It was first isolated in 1985 from **neem oil**. Several triterpenes are shown in Figure 1.15.

Only a few of the common triterpenes are widely distributed among plants. These include the **amyrins** (Boar and Allen, 1973) and **ursolic** and **oleanic acid** (Liu, 1995), which are common on the waxy coatings on leaves and as a protective coating on some fruits. Other triterpenes include the **limonins** and the **cucurbitacins**, which were found to be potent insect steroid hormone antagonists (Miro, 1995).

#### 1.2.3.5.1 Sterols

Practically all plant steroids are hydroxylated at C-3 and are, in fact, **sterols**. In the animal kingdom, the steroids have profound importance as hormones, coenzymes, and provitamins. However, the role of the **phytosterols** is less well understood. There is evidence that some of the phytosterols are effective against cardiovascular disease (Kris-Etherton et al., 2002).

#### 1.2.3.5.2 Saponins

**Saponins** are high-molecular-weight triterpene glycosides, containing a sugar group attached to either a sterol or other triterpene. They are widely distributed in the plant kingdom (Woitke, Kayser, and Hiller, 1970). Saponins are composed of two parts: the **glycone** (sugar) and the **aglycone** or genin (triterpene). Typically, they have detergent properties, readily form foams in water, have a bitter taste, and are **piscicidal** (toxic to fish). Many of the plants that contain saponins were historically used as **soaps**. These include soaproot (*Chlorogalum pomeridianum*), soapbark (*Quillaja saponaria*), soapberry (*Sapindus saponaria*), and soapnut (*Sapindus mukurossi*) (Hostettman and Marston, 1995). The aglycones may be of the triterpene, steroid, or steroid alkaloid class. Saponins may be mono- or polydesmodic, depending on the number of attached sugar moieties. Representative saponins are presented in Figure 1.16.

Biosynthetically, the saponins are comprised of six isoprene units and are also derived from squalene. Many details, including the cyclase enzymes involved, were recently determined (Haralampidis et al., 2002). Commercially important preparations based on saponins include sarsaparilla root (*Sarsaparillae* spp.), licorice (*Glycyrrhiza* spp.), ivy leaves (*Hedera* spp.), primula root (*Primula* spp.), as well as ginseng (*Panax* spp.). The ammonium and calcium salts of **glycyrrhizic acid** are referred to as the **glycyrrhizins**. They are 50 to 100 times sweeter than sucrose. These active ingredients in licorice root (*Glycyrrhiza glabra*), possess expectorant (Fenwick et al., 1990), bacteriostatic (Bo et al., 2002), and antiviral activity (Utsunomiya et al., 1997). Overuse can lead to excessive sodium secretion. The **ginsenosides** are one of

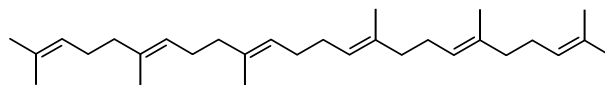

squalene

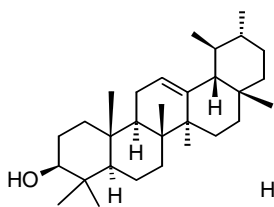
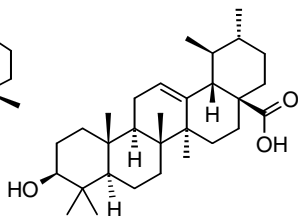
 $\alpha$ -amyrin

ursolic acid

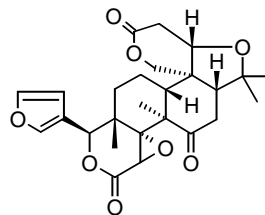

limonin

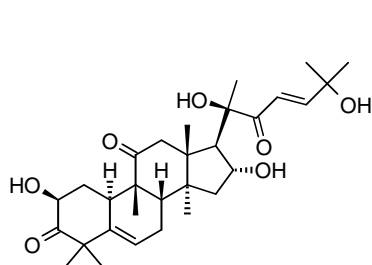

cucurbitacin D

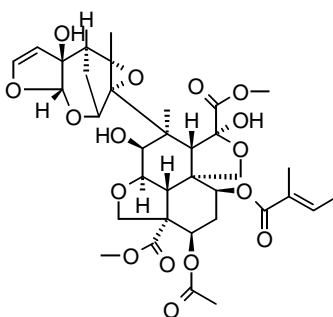

azadirachtin

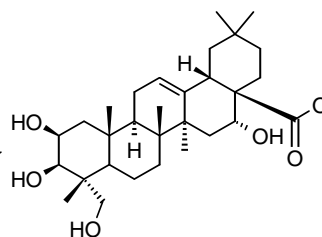

polygalacic acid

FIGURE 1.15 Assorted triterpenes.

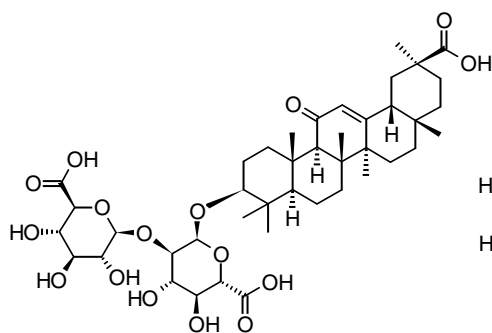

glycyrrhizin

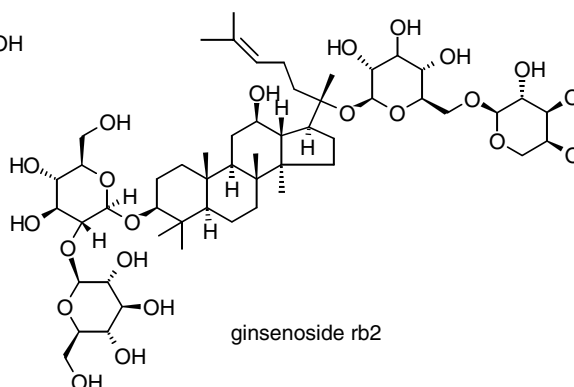

ginsenoside rb2

FIGURE 1.16 Saponins.

many triterpene saponins from ginseng (*Panax ginseng*) believed to be responsible for its immunostimulant and antinociceptive (pain-relieving) properties (Naj et al., 2000).

### 1.2.3.6 Tetraterpenes: $C_{40}$

The most common tetraterpenoids are the **carotenoids** (Britton, 1995), a widely distributed group of  $C_{40}$  compounds. Whereas the structures of the di- and triterpenes can have a wide variety of fascinating structures, the carotenoids are generally derived from **lycopene**. Cyclization at one end gives  **$\gamma$ -carotene** and at both ends provides  **$\beta$ -carotene**. This pigment was first isolated in 1831. It is virtually universal in the leaves of higher plants. As is evident from this polyene structure, numerous double-bond isomers are possible for these basic structures, all of which can provide brightly colored pigments. In plants, carotenoids serve as necessary pigments in photosynthesis, where they are believed to protect plants from overoxidation catalyzed by other light-absorbing pigments, such as the chlorophylls. They are also responsible for colors varying from yellow to red in both flowers and fruits. This coloration attracts **pollinators** (flowers) and serves as a source of food for animal **herbivores** (fruits), thus aiding in **seed dispersal** (see Chapter 2). Selected tetraterpenes are shown in Figure 1.17.

---

## 1.3 Aromatics

Virtually all plants contain natural products that include a carbocyclic or heterocyclic aromatic ring that generally contains one or more hydroxyl substituents. The vivid colors that light up the plants around us are generally composed from three sources: the **tetrapyrroles**, principally, **chlorophyll**; the **terpene-based carotenes** that we just discussed; and the **aromatics**. Several thousand aromatics are known, and new structures are continuously being discovered. In some cases, their functions are well known. For example, the polyphenolic **lignins** serve as structural components of the cell wall. In other cases, including the flavonoids, a variety of functions have been hypothesized, depending on the particular compound being investigated. Aromatic compounds are formed by several biosynthetic routes, including the **polyketide** and **shikimate pathways** (see Chapter 2), as well as from terpenoid origins. Due to the acidity of the phenol functionality ( $pK_a$  of 8 to 11 depending on substituents), phenolic substances tend to have the potential for some water solubility and frequently form ether linkages with carbohydrate residues. Several individual groups exist that will be considered separately.

### 1.3.1 Tetrapyrroles (Warren, 2004)

A **tetrapyrrole** is any compound made up of four **pyrrole** rings — five-membered heterocyclic rings with the structural formula  $C_4H_5N$ . Pyrrole is also the parent compound of all **porphyrin** compounds. The chlorophylls are probably the best known of the tetrapyrroles (Scheer, 1991; Smith and Witty, 2002) and are perhaps the best known of plant constituents. As the primary catalysts of photosynthesis, they occur in several similar cyclic tetrapyrrole forms and are located in the chloroplasts of virtually all photosynthetic plant tissues. The structures of **chlorophylls A** and **B** are shown in Figure 1.18. It should also be noted that chlorophylls are structurally a combination of aromatic compounds and a terpenoid tail. Thus, they are one of the many compounds that cross the chemical categories described in this chapter.

Other porphyrin pigments occur in plants in much smaller amounts. The **cytochromes**, for example, are critical components in the **respiratory chain** of both plants and animals. Finally, the linear tetrapyrroles include **phytochromes** that are involved in flowering, stem elongation, and leaf expansion, and the algal pigments, **phycoerythrin** and **phycocyanin** (Jacobi et al., 2000).

### 1.3.2 Phenols

As mentioned above, the vast majority of plant-based aromatic natural products are phenols. Phenols constitute a large class of compounds in which a hydroxyl group ( $-OH$  group) is bound to an aromatic

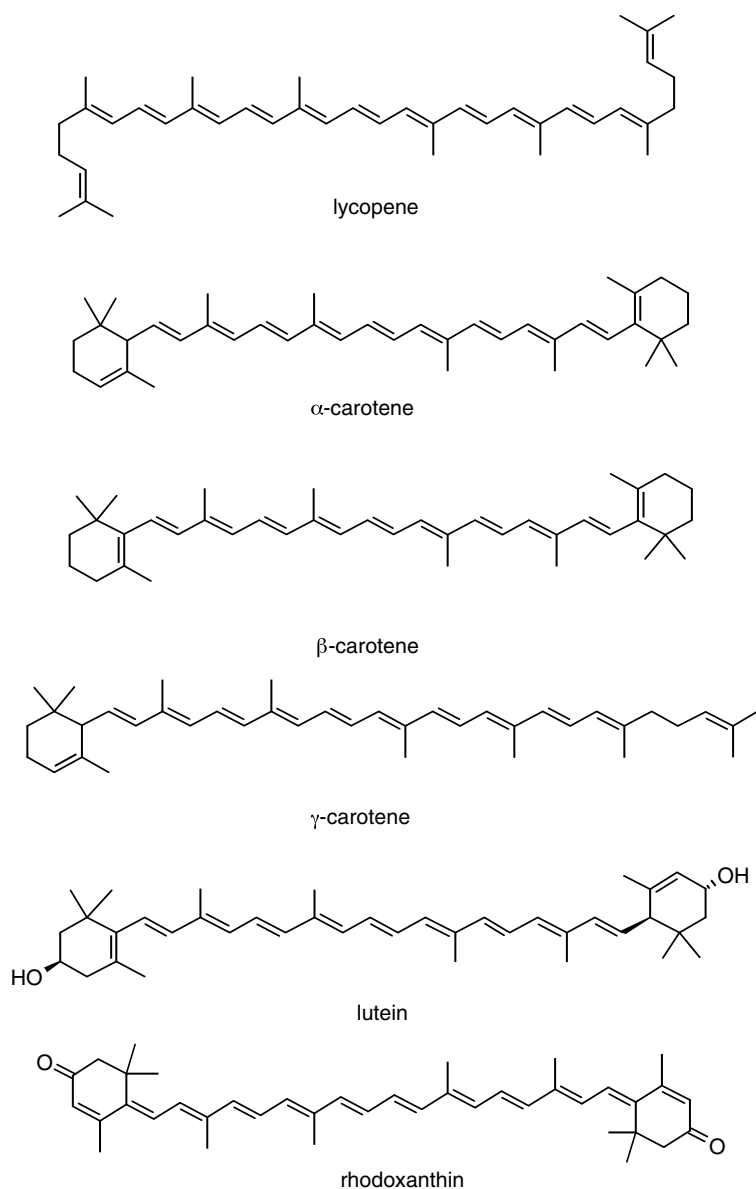
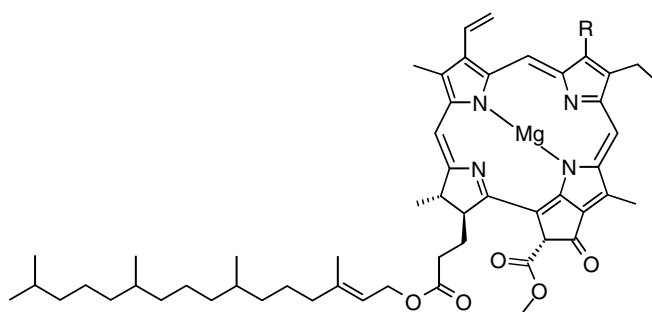

FIGURE 1.17 Examples of common carotenoids (tetraterpenes) in plants.

ring. Numerous categories of these compounds exist, including the **simple phenols**, **phenylpropanoids**, **flavonoids**, **tannins**, and **quinones**.

### 1.3.2.1 Simple Phenols

Most of the **simple phenols** are monomeric components of the polyphenols and acids that make up some plant tissues, including **lignin** and **melanin**. The individual components of these are obtained by acid hydrolysis of plant tissues. These include ***p*-hydroxybenzoic acid**, **protocatechuic acid**, **vanillic**, **syringic**, **salicylic**, and **gallic acids**. Free phenols that do not require degradation of cell-wall polymers are relatively rare in plants. **Hydroquinone**, **catechol**, **orcinol**, and other simple phenols are found in relatively low concentrations (Figure 1.19) (Buckingham, 2005).



chlorophyll A (R = CH<sub>3</sub>)  
chlorophyll B (R = CHO)

FIGURE 1.18 Chlorophylls A and B.

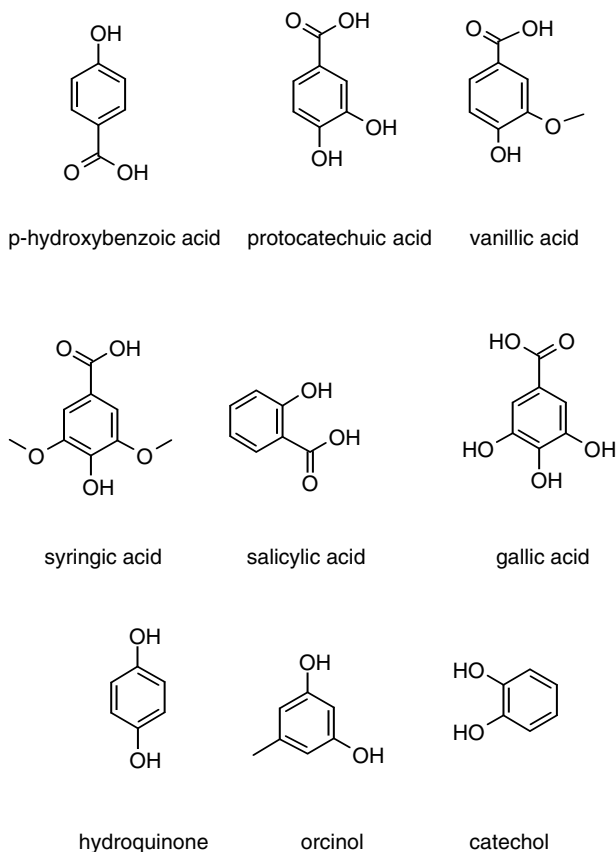

FIGURE 1.19 Simple phenols.

### 1.3.2.2 Phenol Ethers

Many of the phenols also exist as their methyl ethers. For illustration, a few are shown in Figure 1.20. **Khellin** and **visnagin** are the active coumarin derivatives of the ammi visnaga fruit (*Ammi visnaga*). **Trans-anethole** is chiefly responsible for the taste and smell of anise seeds (*Pimpinella anisum*). **Apiole**

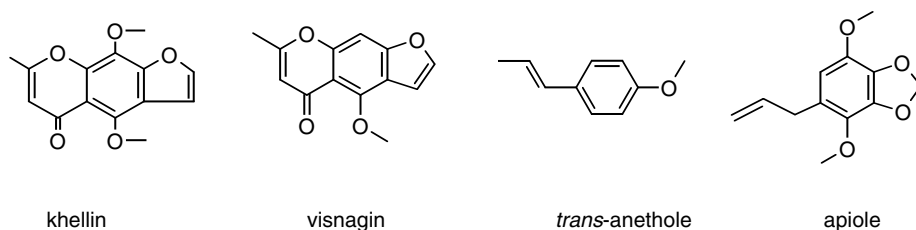

FIGURE 1.20 Phenol ethers.

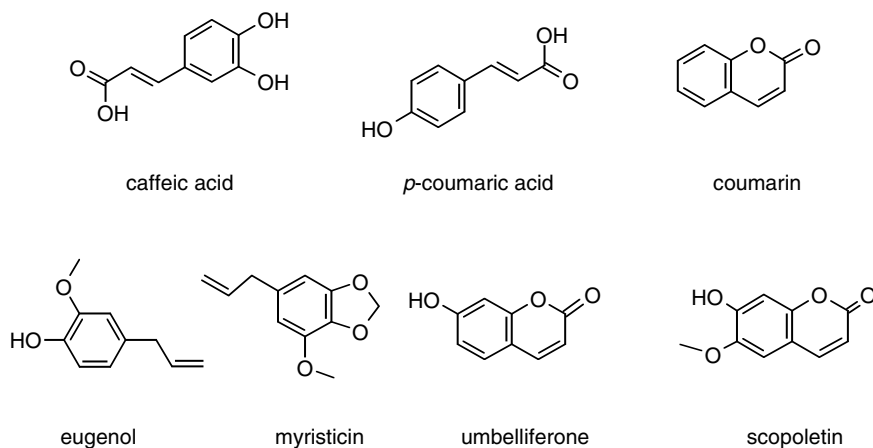

FIGURE 1.21 Phenylpropanoids.

is a major constituent of the essential oil of parsley (*Petroselinum crispum*) seed (Louli et al., 2004) and is a powerful diuretic (Anonymous, 1907).

### 1.3.2.3 Phenylpropanoids

As the name implies, the **phenylpropanoids** contain a three-carbon side chain attached to a phenol (see Figure 1.21). Common examples include the hydroxycoumarins, phenylpropenes, and the lignans. Also common are various types of hydroxycinnamic acids, including the caffeic and coumaric acids. **Coumarin** is common to numerous plants and is the sweet-smelling volatile material that is released from newly mowed hay. The phenylpropenes are important components of many essential oils and include **eugenol**, the major principle of oil of cloves (*Eugenia caryophyllata* or *Syzygium aromaticum*) (Ntamila and Hassanal, 1976). The phenylpropenes also include **anethole** and **myristicin**, the principles of nutmeg (*Myristica fragrans*) (Archer, 1988).

**Caffeic** and ***p*-coumaric acids** are hydroxycinnamic acids present in green and roasted coffee beans (Andrade et al., 1998). **Umbelliferone** and **scopoletin** are coumarin-class phenylpropanoids that have been known since 1884 and are isolated from the roots of *Scopolia japonica* (Anonymous, 1884). The phenylpropene **eugenol** has been isolated from several plant sources and has been used as a dental analgesic (Samuelsson, 1991).

### 1.3.2.4 Flavonoids (Williams and Grayer, 2004)

The **flavonoids** have two benzene rings separated by a propane unit and are derived from **flavone**. They are generally water-soluble compounds. The more conjugated compounds are often brightly colored. They are generally found in plants as their glycosides, which can complicate structure determinations.

The different classes within the group are distinguished by additional oxygen-containing heterocyclic rings and hydroxyl groups. These include the **chalcones**, **flavones**, **flavonols**, **flavanones**, **anthocyanins**, and **isoflavones** (Figure 1.22) (see also structures depicted in Chapter 2).

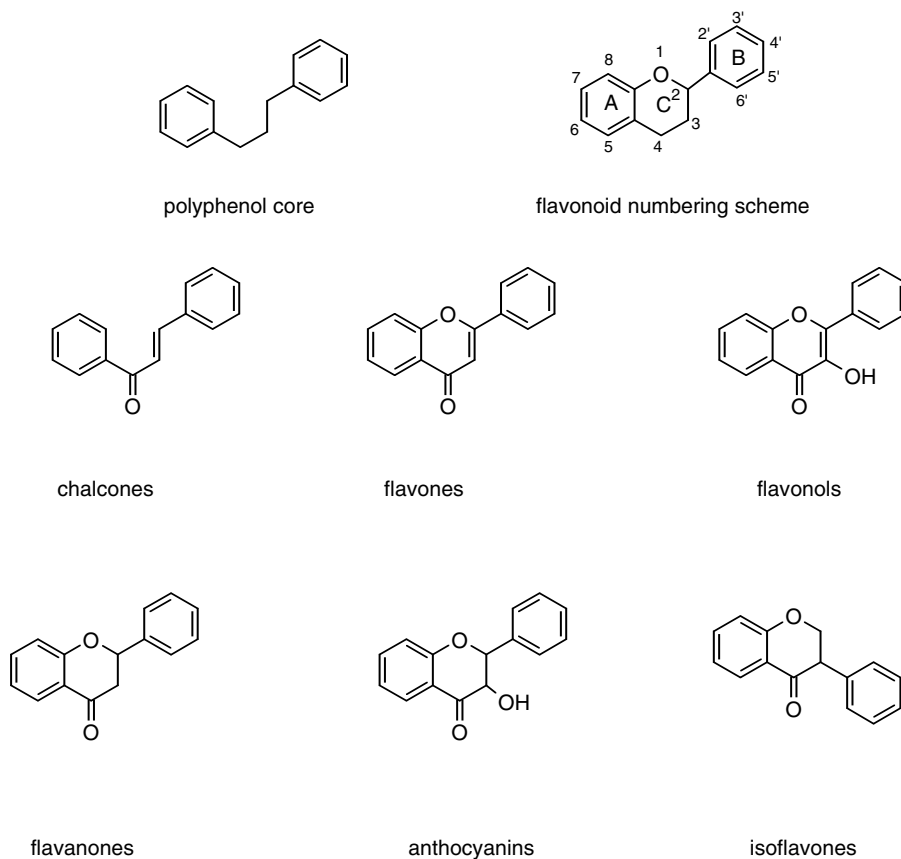

FIGURE 1.22 Flavonoid classes.

Other common flavonoid groups include **aurones**, **xanthenes**, and **condensed tannins**. The **catechins** and **leucoanthocyanidins** are structurally similar and only rarely exist as their **glycosides**. They polymerize to form **condensed tannins**, which help give tea its color. They also are sufficiently prevalent to darken the color of streams and rivers in some woody areas, including the black waters of the Okefenokee Swamp in Georgia and the Suwannee River in Georgia and Florida.

The flavanones and flavanols are rare and normally exist as their glycosides. The **flavones** and **flavonols** are the most widely distributed of all the phenolics. The **anthocyanins** are the common red and rare blue pigments of flower petals and can make up as much as 30% of the dry weight of some flowers. The red pigment of beet (*Beta vulgaris*) is anthocyanin. The anthocyanins exist typically as glycosides. Flavanones often coexist in plants with their corresponding flavones (e.g., **hesperidin** and **diosmin** in the bark of *Zanthoxylum avicenna*). The flavone, **acacetin**, isolated from black locust (*Robinia pseudoacacia*), shows anti-inflammatory activity (Buckingham, 2005). **Galangin**, a flavonol from galanga root (*Alpinia officinarum*), showed antibacterial activity against antibiotic-resistant strains of *Staphylococcus aureus* (Cushnie et al., 2003).

**Isoflavones** possess a rearranged **flavonoid skeleton**. A variety of structural modifications of this skeleton lead to a large class of compounds that includes isoflavones, isoflavanones, and rotenone. The isoflavonoid compounds are common constituents of the legume family Fabaceae (formerly called Leguminosae family) (Geissman and Crout, 1969). These compounds displayed estrogenic, insecticidal, and antifungal activity. Some are potent fish poisons. Thus, for example, the isoflavones **biochanin A** from red clover (*Trifolium pratense*), **genistein** from soybean (*Glycine max*), and **coumestrol** from alfalfa (*Medicago sativa*) are **phytoestrogens** (Cornwell et al., 2004), in addition to exhibiting antifungal activity (Rivera-Vargas et al., 1993). The isoflavanone **rotenone** is the principal insecticidal constituent of the



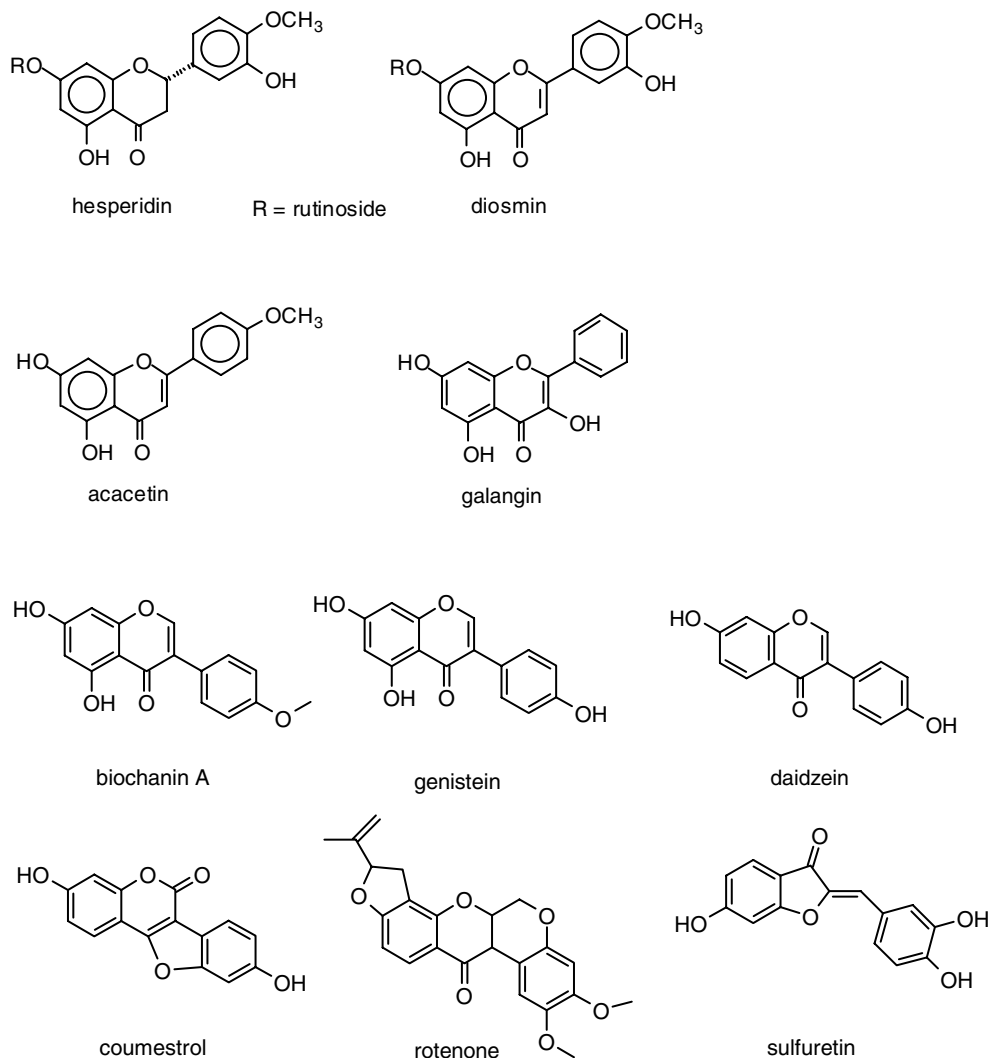

FIGURE 1.23 Flavonoids.

Continued.

piscicidal plants *Derris elliptica* and *Lonchocarpus nicou* (Budavari, 2001). It is a powerful inhibitor of **mitochondrial electron transport**.

The **chalcones**, such as **butein**, lack the pyran ring found in flavonoids, although this is often subject to pH-controlled equilibria. The chalcone is more fully conjugated and normally brightly colored. **Phlorizin** is a strong inhibitor of apple seedling growth. The **aurones** are golden yellow pigments that are common in certain flowers (Geissman and Crout, 1969). **Sulfuretin** is an aurone pigment responsible for the yellow color of certain species of the aster family (Asteraceae), for example, cosmos (*Cosmos sulphureus*) and dahlia (*Dahlia variabilis*) (Budavari, 2001). Several common flavonoids are shown in Figure 1.23.

Many of these phenols come from familiar sources. The condensed biflavonoids **santalins A and B** are the major pigments of red sandalwood (*Pterocarpus santalinus*) (Kinjo et al., 1995). The flowers of the hawthorn tree provide **hyperoside**, one of the principal flavonoids from this source (*Crataegus laevigata*) (Zou et al., 2004). **Neohesperidin** is responsible for the bitter taste of orange peels (*Citrus aurantium*), while the dihydrochalcone derivative is one of the sweetest-tasting chemicals known (DuBois

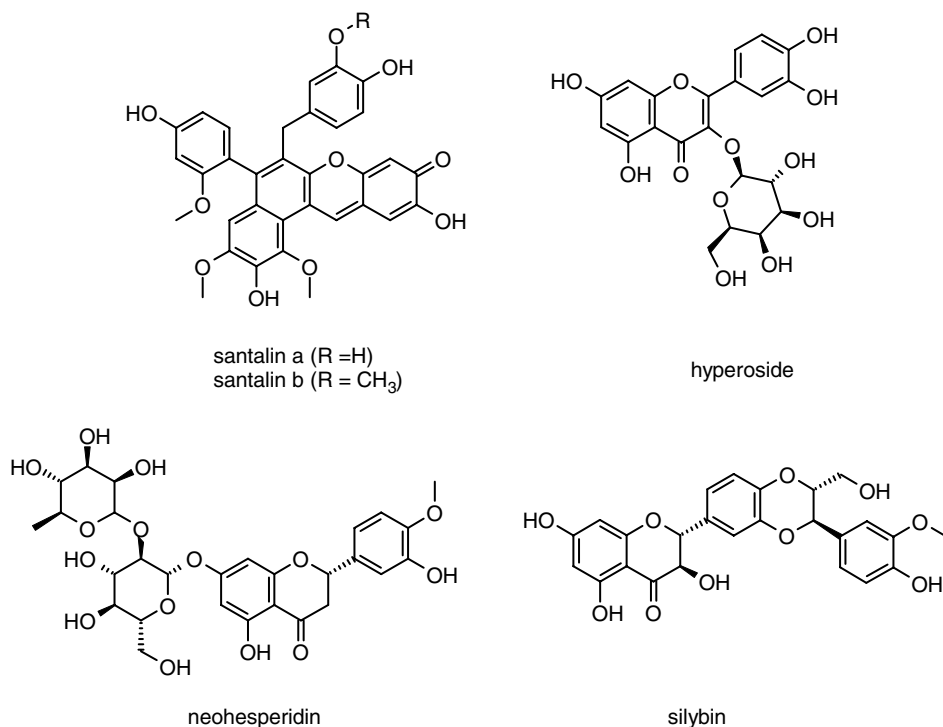
FIGURE 1.23 *Continued.*

et al., 1981). **Quercetin**, a flavonoid present in numerous plants, has antioxidant activity. It is currently popular at health food stores, although any benefits are speculative (Graefe et al., 1999). **Silybin**, one of the **silymarins**, a mixture of various flavanone derivatives (**flavonolignans**), is present in the fruit of the milk thistle (*Silybum marianum*). It is used to treat several liver disorders (Sridar et al., 2004). Similarly, **silymarin** is the active antihepatotoxic complex used for the treatment of liver damage, and it increases the rate of synthesis of ribosomal ribonucleic acids. It is also used to prevent skin cancer (Katiyar, 2005). The secoiridoid glucoside **centapicrin** (Sakina and Aota, 1976) is an ultrabitter (**bitterness value** ca. 4,000,000) secoiridoid glycoside from the century plant (*Centaurium erythraea*). The isoflavones **genistein** and **daidzein** are found in high concentrations in kudzu (*Pueraria montana*), soybeans (*Glycine max*), as well as several other legumes. Both genistein and daidzein have anticancer activity (Kaufman et al., 1997).

### 1.3.2.5 Tannins

**Tannins** are water-soluble **oligomers**, rich in phenolic groups, capable of binding or precipitating water-soluble proteins (see Section 1.6.3.1) (Hagerman and Butler, 1989). The tannins, common to vascular plants, exist primarily within woody tissues but can also be found in leaves, flowers, or seeds. Plant tissues that are high in tannin content have a highly bitter taste and are avoided by most feeders. Tannins may be divided into two groups: either **condensed tannins** or **hydrolyzable tannins**. Condensed tannins are formed biosynthetically by the condensation of flavanols to form polymeric networks. Examples of condensed tannins (proanthocyanidins) are shown in Figure 1.24. Hydrolyzable tannins are esters of a sugar (usually glucose) with one or more trihydroxybenzenecarboxylic acids (**gallic acid**). These materials give insoluble precipitates with albumin, starch, or gelatin. This reaction with proteins is used industrially to convert animal skins into leather (**tanning**). Examples of hydrolyzable tannins (Figure 1.24) include **corilagin**, isolated from leaves of sumac (*Rhus* spp.) and eucalyptus (*Eucalyptus* spp.)

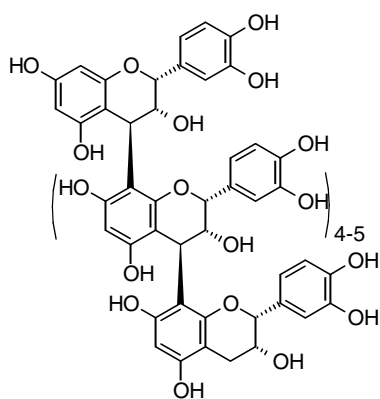
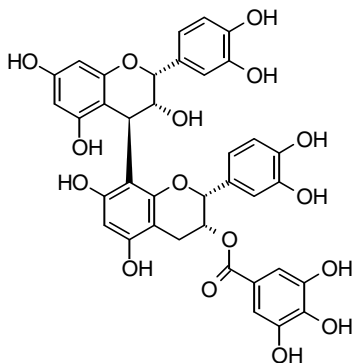
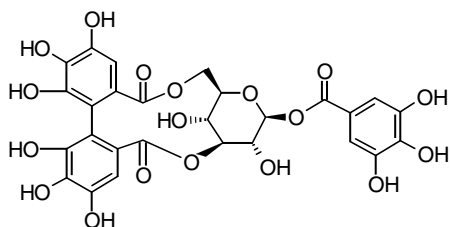
proanthocyanidin from *Sorghum*proanthocyanidin from *Eucalyptus*

corilagin

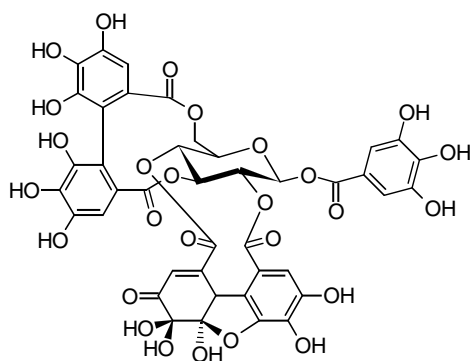

geraniin

FIGURE 1.24 Structures of representative condensed (proanthocyanidins) and hydrolyzable tannins.

(Buckingham, 2005), and **geraniin**, from geranium (*Geranium* spp.) and *Phyllanthus* spp. (Buckingham, 2005). Both corilagin and geraniin show anti-human-immunodeficiency-virus (HIV) activity by inhibiting **reverse transcriptase** (Notka et al., 2004).

### 1.3.2.6 Quinones

The **quinones** are phenolic compounds that typically form strongly colored pigments covering the entire visible spectrum. Typically, however, they are found in the internal regions of the plant and, thus, do not impart a color to the exterior of the plant. Generally, quinones are derived from **benzoquinone**, **naphthoquinone**, or **anthraquinone** structures.

Quinones play an important role in the respiration of plants. They act as electron carriers that function by converting between hydroquinones and quinones, thus acting as redox couples.

Hydroquinone (1,4-benzenediol) appears to play several roles, including chemical defense and leaf growth reduction. Ubiquinone (coenzyme Q) specifically serves as an electron carrier on the inner mitochondrial membrane by transferring electrons in order to complete a proton pump in the respiratory chain. This makes the quinones important components of most plant respiratory and photosynthetic electron transfer processes.

Quinones play a key role in photosynthetic membranes. A dual function is ascribed to plastoquinones as they act as both photochemical and non-photochemical quenchers of energy in photosynthesis.

## 1.4 Carbohydrates

**Carbohydrates** are the most abundant class of organic compounds found in plants. They are the primary products of photosynthesis and are essential as a source of energy to plants. The **photosynthetic process** that produces carbohydrates is an endothermic reductive condensation of carbon dioxide requiring light energy and the pigment chlorophyll:

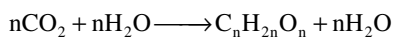

Because of the general molecular formula of carbohydrates shown above, they were originally thought of a “hydrates of carbon.” Despite the simplicity of their empirical formula, there are many types of carbohydrates in plants. The energy that carbohydrates provide is stored as **starch** or **fructan**, used as **sucrose**, and polymerized to form **cellulose**, the primary cellular structural material of plants. Finally, they combine to form **glycosides** of many fundamental groups of natural products, as we have seen, including terpenes (to form saponins), phenols, and alkaloids.

**Sugars** are optically active aliphatic polyhydroxylated compounds that are readily water soluble. This is due to the hydrophilic nature of the hydroxyl functionality and does not involve the salt formation that we observed for the phenolics and alkaloids. The sugars are classified into three groups depending on their size: the **monosaccharides**, such as glucose; the **oligosaccharides**, including sucrose; and the **polysaccharides**, including large molecules like cellulose.

### 1.4.1 Monosaccharides

The **monosaccharides** are colorless, crystalline solids that contain a single aldehyde or ketone functional group. This forms the basis for the two types of monosaccharides: **aldoses** (aldehyde-based) and **ketoses** (ketone-based). They are also classified by their chain lengths, which vary from three (**triose**) to seven (**heptose**) carbon units. For example, the structure of **D-glyceraldehyde** is shown in Figure 1.25A.

With only one exception, the monosaccharides are optically active compounds. Both D and L isomers are possible. However, most of the monosaccharides found in nature are in the D configuration. The

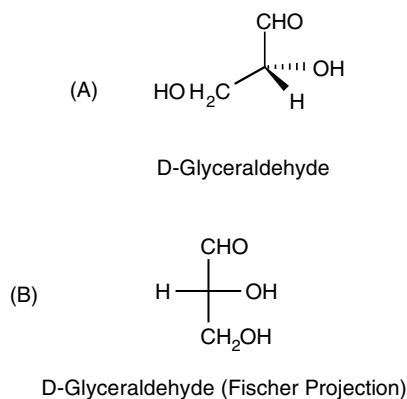
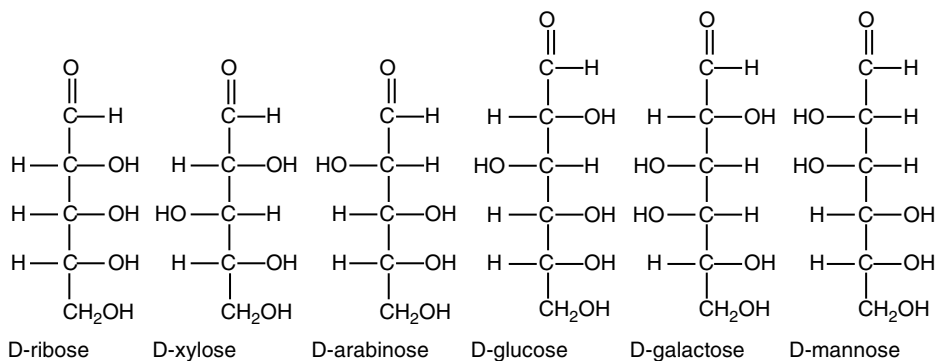

FIGURE 1.25 (A) D-Glyceraldehyde. (B) D-Glyceraldehyde (Fischer Projection).

## Aldose Monosaccharides



## Ketose Monosaccharides

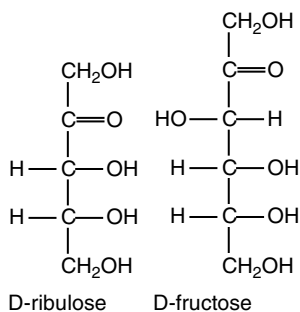

FIGURE 1.26 Fischer Projections of different aldose and ketose monosaccharides.

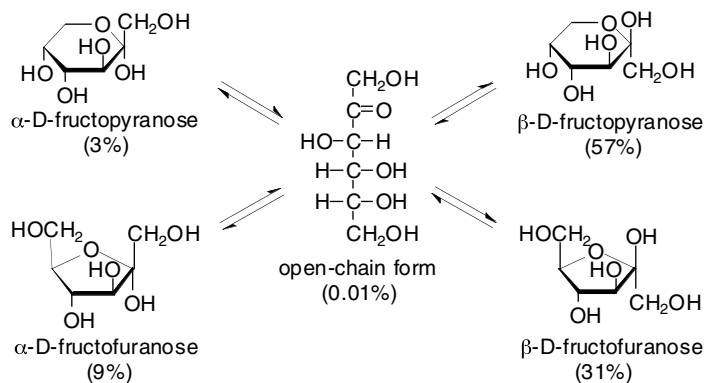

FIGURE 1.27 The principal forms of D-fructose in equilibrium in aqueous solution.

stereochemistry may also be shown using a Fischer Projection (Figure 1.25B). Fischer projections for some of the more common monosaccharides are shown in Figure 1.26.

The larger monosaccharides exist in equilibrium with their **cyclic tautomers**. For example, D-fructose forms both six-membered (pyranose) and five-membered (furanose) rings. These result in formation of a stereogenic center (the anomeric carbon) that may be either alpha or beta (Figure 1.27).

### 1.4.2 Oligosaccharides

When a compound is formed by connecting two of the same types of compounds with a covalent bond, the compound is then said to be an “oligo.” **Oligosaccharides** or **disaccharides** are formed by condensing

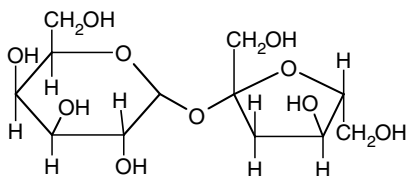

FIGURE 1.28 Chemical structure of the disaccharide, sucrose.

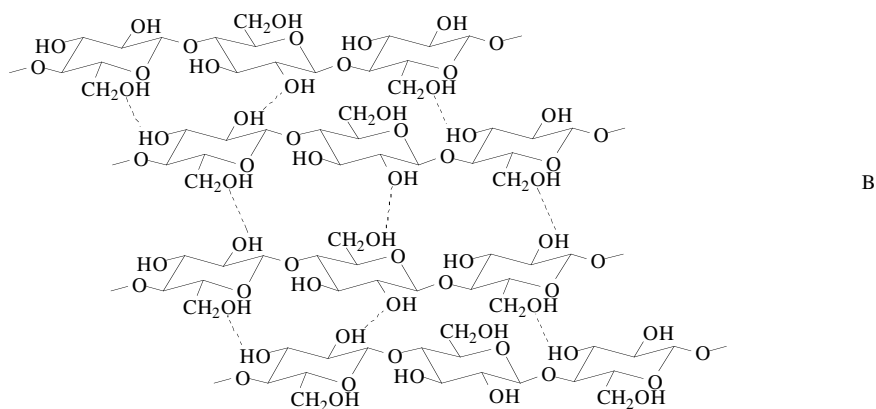
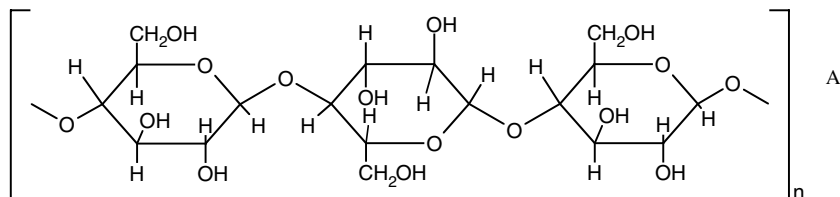

FIGURE 1.29 The structure of cellulose. (A) The way that D-glucose units form  $\beta$ -1,4 linkages to form linear chains of cellulose. (B) Interstrand hydrogen bonding.

a pair of monosaccharides. Perhaps the most common example is sucrose, shown in Figure 1.28. Sucrose is the sweetest of the disaccharides. It is roughly three times as sweet as maltose and six times as sweet as lactose. In recent years, sucrose has been replaced in many commercial products by corn syrup, which is obtained when the polysaccharide, starch, in corn starch is enzymatically hydrolyzed to its hexose monomer. Corn syrup is composed primarily of glucose, which is only about 70% as sweet as sucrose. Fructose, however, is about two and a half times as sweet as glucose. A commercial process has been developed that uses an isomerase enzyme to convert about half of the glucose in corn syrup into fructose. This high-fructose corn sweetener is just as sweet as sucrose and is used extensively in soft drinks.

The oligosaccharides normally include from two to five saccharide (or sugar) units. These are joined by any of three possible ether linkages that can complicate structure elucidation.

### 1.4.3 Polysaccharides

Most of the carbohydrates found in plants occur as **polysaccharides** of high molecular weight. The polysaccharides (or **glycans**) fulfill a wide variety of functions in plants. **Cellulose** serves as a structural material in plant cell walls, whereas in animals, **keratin** and **collagen** serve similar structural roles in hair and muscle, respectively. Cellulose is the most abundant organic material on earth. A partial view of a cellulose chain is shown in Figure 1.29A and B.

Cellulose is a major component of wood. Cellulose fibers in wood are bound to **lignin**, a complex polymer (see Chapter 2). Paper making involves treating wood pulp with alkalis or bisulfites to disintegrate the lignin and then pressing the pulp to mat the cellulose fibers together. A simple straight-chain polymer without branching is formed, using  $\beta$ -(1,4) ether linkages (Figure 1.29A). It forms the main structural polysaccharide of the cell wall. **Amylose** (straight-chain starch), which is used as a storage rather than a structural glucan, uses  $\alpha$ -(1,4) linkages. **Amylopectin** (branched-chain starch) uses  $\alpha$ -(1,4) and  $\alpha$ -(1,6) linkages. The linkages of cellulose form straight ribbons that line up side-by-side held together by interchain hydrogen bonds (Figure 1.29B), forming a polymer of high mechanical strength and limited extensibility. Other structural cell-wall polysaccharides include the **polygalacturonans** (pectic polysaccharides), **xylans**, **glucomannans**, **chitins**, and the **glycosaminoglycans**.

---

## 1.5 Amines and Alkaloids

Compounds that contain nitrogen (structurally derived from ammonia) as part of their structure can generally be classified as **amines** or **alkaloids**. For amines, the nitrogen is usually (but not always) incorporated into a chain rather than a ring structure. For alkaloids, the nitrogen is often incorporated into a ring structure derived from an amino acid (see Section 1.6). The position of the nitrogen within the compound imparts the chemical nature to the molecule, including how it behaves in a biological system.

### 1.5.1 Amines

The common plant amines can be subdivided into aliphatic monoamines, aliphatic polyamines, and aromatic amines. Occasionally, these materials are classified as alkaloids rather than amines.

#### 1.5.1.1 Aliphatic Monoamines

Simple **aliphatic amines** exist as low-boiling liquids and include most of the primary amines from **methylamine**,  $\text{CH}_3\text{NH}_2$ , through **hexylamine**,  $\text{CH}_3(\text{CH}_2)_5\text{NH}_2$ . These molecules typically have strong, fish-like aromas. In the case of cow parsnip (*Heracleum sphondylium*), they are believed to act as insect attractants by simulating the smell of carrion.

#### 1.5.1.2 Aliphatic Polyamines

Common polyamines include **putrescine**,  $\text{NH}_2(\text{CH}_2)_4\text{NH}_2$ , the guanidine-containing **agmatine**,  $\text{NH}_2(\text{CH}_2)_4\text{NHC}(=\text{NH})\text{NH}_2$ , **spermidine**,  $\text{NH}_2(\text{CH}_2)_3\text{NH}(\text{CH}_2)_4\text{NH}_2$ , and **spermine**,  $\text{NH}_2(\text{CH}_2)_3\text{NH}(\text{CH}_2)_4\text{NH}(\text{CH}_2)_3\text{NH}_2$ . Both putrescine and *s*-adenosylmethionine are used for the formation of spermine and spermidine. These polyamines are thought to have many functions, including acting as plant hormones, and are invariably found complexed with nucleic acids, including both DNA and RNA (see Section 1.7) (Tabor and Tabor, 1984; Cohen, 1998).

#### 1.5.1.3 Aromatic Amines

Many of the known aromatic amines are physiologically active. One well-known member of this class is **mescaline**. It is the active principle of the flowering heads of the peyote cactus or mescal button (*Lophophora williamsii*). It is a potent hallucinogen. Similarly, three compounds critical to brain metabolism in animals are **noradrenaline**, **histamine**, and **serotonin** (Figure 1.30). All three occur in common plants (Brenner, 2002).

### 1.5.2 Alkaloids (Cordell, 1981)

Alkaloids are nitrogen-containing compounds widely distributed in different plant groups. Nearly all alkaloids are alkaline, and most are optically active. **Alkaloids** are classically defined as being plant-derived, pharmacologically active, basic compounds derived from amino acids that contain one or more

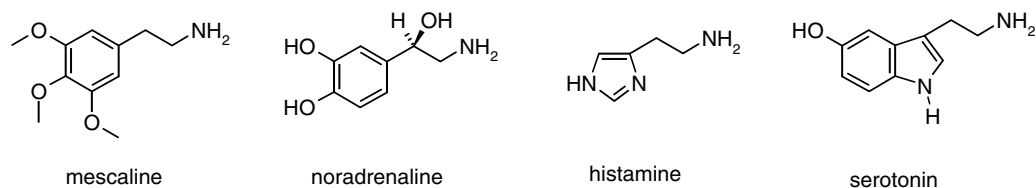

FIGURE 1.30 Common aromatic amines.

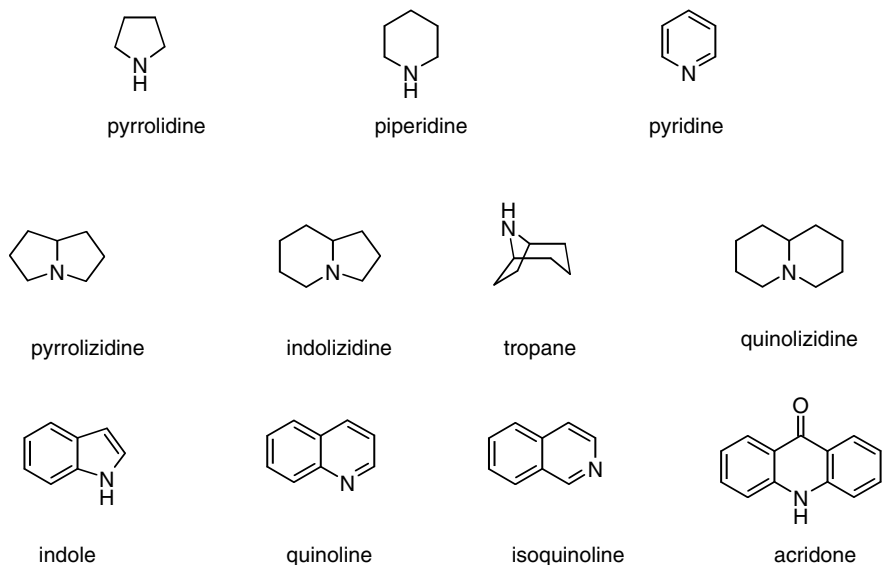

FIGURE 1.31 Alkaloid classes.

heterocyclic nitrogen atoms. In practice, most nitrogen-containing secondary metabolites are considered alkaloids, unless they may be readily classified otherwise, for example, as amines or glucosinolates. The word “alkaloid” is derived from the Arabic, *al-qali* (an early form of soda ash), from which the term “alkali” is derived.

Alkaloids are normally grouped on the basis of the ring system present. Several common ring systems, including indolizidine- and quinolizidine-based systems (Michael, 2003) and quinoline-, quinazoline-, and acridone-based systems (Michael, 2004) were recently reviewed, including their biosynthesis (Herbert, 2003). Many of the alkaloids are directly derived from the aromatic amino acids, phenylalanine, tyrosine, and tryptophan. A sampling of alkaloid classes is shown in Figure 1.31.

Notable indole alkaloids include **reserpine**, an antihypertensive alkaloid from Indian snakeroot (*Rauwolfia serpentina*), and **vinblastine**, one of the antitumor alkaloids, from the rosy periwinkle (*Catharanthus roseus*). Many alkaloids have a bitter taste, and a large number of them exhibit potent physiological effects on mammals. For example, **morphine** shows narcotic effects; **reserpine** is an antihypertensive agent; **atropine** is a smooth muscle relaxant; **cocaine** is a local anesthetic and a potent central nervous system stimulant; and **strychnine** is a nerve stimulant.

Alkaloids in plants serve as chemoprotective antiherbivory agents or as growth regulators, such as the well-known plant hormone, **indole-3-acetic acid, IAA** (an indole derivative synthesized from tryptophan — see Buchanan et al., 2000).

People have been using alkaloids in the form of plant extracts for poisons, narcotics, stimulants, and medicines for several thousand years. Thus, many of the common drugs used (and abused) today are alkaloid based. Common examples include **caffeine**, **quinine**, and **nicotine**. More potent examples include **cocaine**, **morphine**, and **strychnine**. Biosynthetically, they may be derived from amino acids, terpenes, or aromatics, depending on the specific alkaloid structure. Much of the structure-based natural



products research that began around 150 years ago was focused on the alkaloids, or “vegetable alkalis,” as they were known. Isolation techniques developed primarily by British and German chemists enabled the isolation of analytically pure samples that had pronounced biological effects, but the chemical structures were unknown. Efforts to determine the chemical structures of the alkaloids began in the middle of the nineteenth century and continue today. As the figures in this section attest, the alkaloids have highly varied and often complex three-dimensional chemical structures. The structure of cocaine was determined in 1898, quinine in 1944 (Kaufmann, 2004), and morphine was synthesized in 1956 (Taber et al., 2002). Because of this chemical complexity, the alkaloids are often obtained from the plant source rather than produced synthetically. Several of the more commonly known alkaloids are shown in Figure 1.32.

**Caffeine** (Weinberg and Bealer, 2002) is one of the world’s most popular addictive drugs, isolated primarily from tea, coffee beans, and cocoa. **Quinine** is derived from the bark of *Cinchona* trees (*Cinchona ledgeriana* and *C. succirubra* or their hybrids) and has been used to treat malaria (Honigsbaum, 2002). Its use has largely been replaced by the use of synthetic derivatives, including **chloroquine** and **mefloquine**. An alternative antimalarial agent is **artemisinin** (see its structure in Figure 1.13 and boxed essay on artemisinin in Section 1.2.3.3), derived from sweet annie (*Artemisia annua*). It has fewer adverse side effects than quinine or the above synthetic derivatives. **Nicotine** is also an addictive drug, one of the more than 4000 chemicals found in the smoke of tobacco (*Nicotiana tabacum*) products, including cigarettes. A relatively small liquid alkaloid, it has been in use for at least 6000 years, and the chemical structure was determined in 1893 (Pinner, 1893). **Cocaine** is a well-known tropane alkaloid and a potent central nervous system stimulant present in coca leaves (*Erythroxolon coca*) (Flynn, 1991). **Morphine** is the principal alkaloid of the opium poppy (*Papaver somniferum*), which may contain 9 to 14% opium by weight. It is a potent narcotic analgesic used extensively for the treatment of moderate to severe pain (Bercovitch et al., 1999). After **heroin**, morphine has the greatest dependence liability of the narcotic analgesics in common use. The chemical structure of **strychnine** was determined in 1945. A strong poison, the primary source is the plant *Strychnos nux vomica*. It is used today as a pesticide, primarily to kill rodents.

“No other pain is more severe than this, not iron screws, nor cords, not the wound of a dagger, nor burning fire,” were the words used by the Greek physician, Arataeus, when describing gout, caused by uric acid crystallization in joints. **Colchicine** has been used to treat the inflammation associated with gout for 2000 years. This alkaloid, present in the autumn crocus (*Colchicum autumnale*), is being investigated for the treatment of cancer (Jordan, 2002; Nakagawa-Goto et al., 2005).

**Protopine** (Budavari, 2001) has been known to exist in opium in small quantities since 1871. It also has been found in several species within the families Papaveraceae and Fumariaceae. Protopine is spasmolytic, anticholinergic, antiarrhythmic, and increases GABA receptor binding (Ustunes et al., 1988; Paul et al., 2003). It has also shown promise in the treatment of morphine withdrawal.

**Atropine** (Icon Health Publishers, 2004) is a parasympatholytic alkaloid with a long history. During the Renaissance, fashionable ladies would drop belladonna extract (from *Atropa belladonna*) into their eyes to attempt to make themselves appear more attractive. Atropine may be administered just prior to surgery, and it was used to dilate the pupil before eye examinations. It is used to treat exposure to chemical warfare nerve agents (Bajgar, 2004). Finally, atropine has become an accepted alternative to eye patching for the treatment of **amblyopia** (lazy eye), which affects approximately 2% of children (Pediatric Eye Disease Investigator Group, 2002). Several additional alkaloids are shown in Figure 1.33.

**Chelidone** is one of the many alkaloids present in celandine poppy (*Chelidonium majus*) (Nui and He, 1991). **Lycodopine** is the principal alkaloid (with more than 100 other alkaloids present) isolated from the staghorn club moss (*Lycopodium clavatum*). The biosynthesis, which involves lysine, was extensively investigated (Humphrey and O’Hagan, 2001). **Senecionine**, with its unique 12-membered ring, is one of several hemostyptic (wound-healing) alkaloids from senecio (*Senecio nemorensis*). Like many of the pyrrolizidine alkaloids, it is hepatotoxic, with a  $LD_{50}$  of  $64 \text{ mg}\cdot\text{kg}^{-1}$  (Azadbakht and Talavaki, 2003). Pyrrolizidine toxicity in humans can lead to severe liver damage from electrophilic metabolites of pyrrolizidine alkaloids produced in the liver (Prakash et al., 1999). Pyrrolizidine alkaloid toxicity to farm animals during grazing is a serious agricultural hazard (Seaman, 1987; Odriozola et al., 1994), but this risk was reduced somewhat with modern herbicides and by preventing overgrazing.

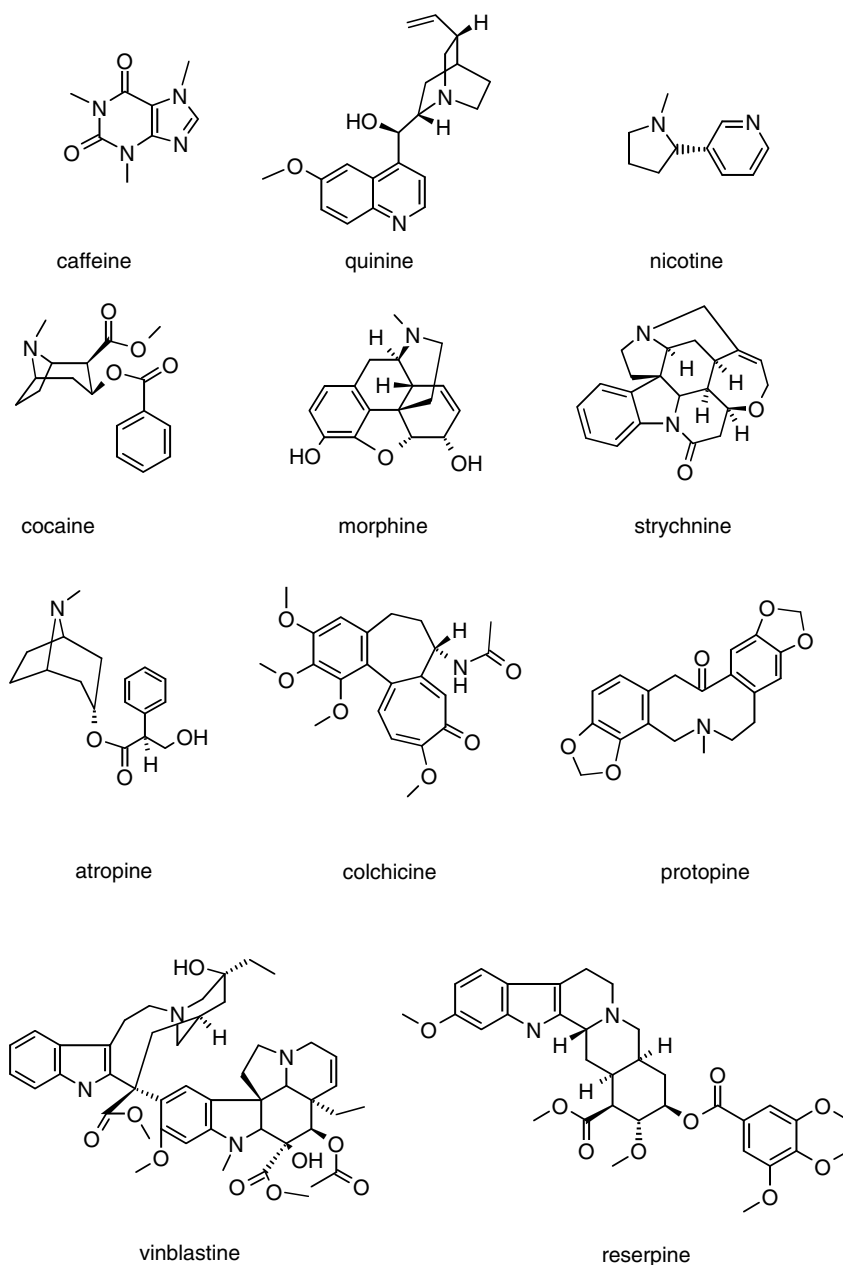

FIGURE 1.32 Common alkaloids.

**Intermedine** is one of several pyrrolizidine alkaloids present in comfrey root (*Commiphora abyssinica*) (Rode, 2002) and borage (*Borago officinalis*) (Larson et al., 1984). **Hygrine** is a simple example of a pyrrolidine alkaloid.

**Scopolamine** is one of the most fascinating, and at the same time disturbing, alkaloids, with a long history of use and, unfortunately, abuse. It exists in various members of the nightshade family (*Solanaceae*), including henbane (*Hyoscyamus niger*) and jimson weed (*Datura stramonium*), among others. The daturas are a frighteningly powerful group of plants that are commonly associated with vague accounts of sorcery and witchcraft dating back over 4000 years (Boyd and Dering, 1996). Scopolamine is a potent **tropane alkaloid** with a structure similar to the neurotransmitter, **acetylcholine**, and so can

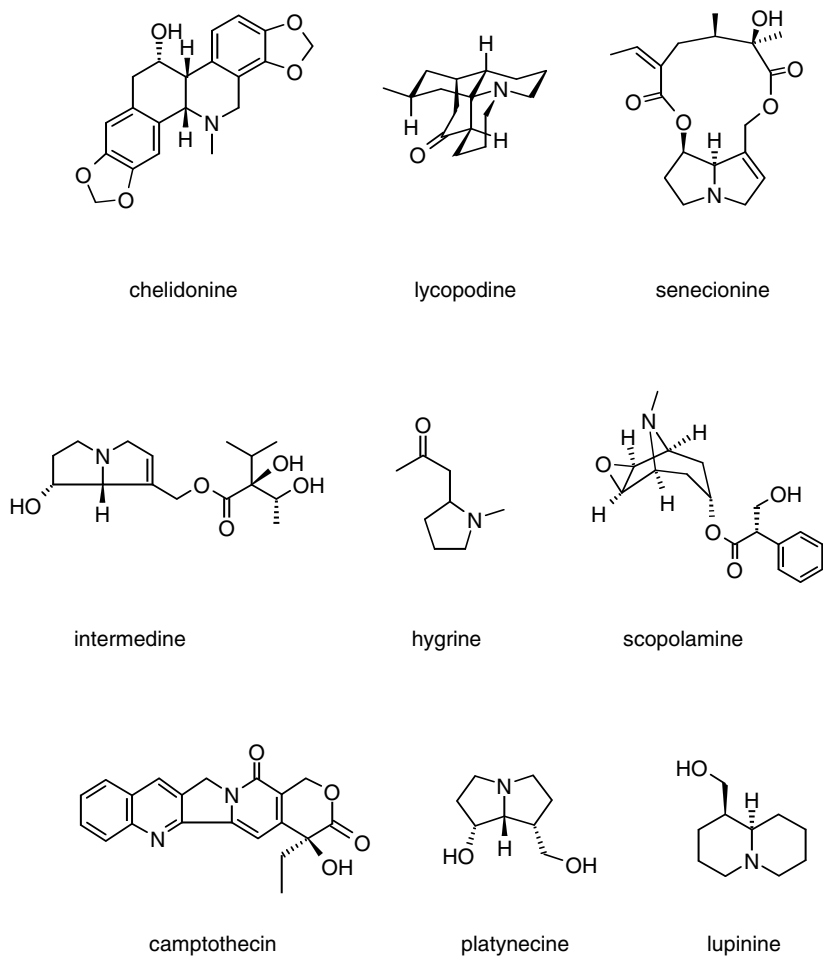

FIGURE 1.33 Additional alkaloids — part 1.

Continued.

act as an anticholinergic. In the Middle Ages, *Datura* (jimson weed) concoctions were used for various religious, sacrilegious, and nefarious activities. The complete determination of its chemical structure occurred in 1952. It was used throughout the 1950s in combination with morphine to induce “twilight sleep” during childbirth. It was later found to cause neonatal depression. About the same time, it was used as a “truth drug” by various intelligence agencies. It was subsequently found to be hallucinogenic; so, the truth was distorted. Alarmingly, it is presently abused as a “date-rape” and kidnapping (Negruz and Gaensslen, 2003) drug, because it can cause **retrograde amnesia**. As a result, the victim often cannot recall events. It is legally prescribed for motion sickness, to ease the trauma of intubation, for preanesthetic sedation, and as an antiarrhythmic (Golding and Stott, 1997; Bailey et al., 1997; Loper et al., 1989).

On a brighter note, **camptothecin** (CPT) is a quinoline alkaloid from the Chinese tree of joy, *Camptotheca accuminata* (see also Chapter 3, Section 3.2). On May 29, 1996, the U.S. Food and Drug Administration (FDA) approved a close derivative, *topotecan*, as a treatment for advanced ovarian cancers that have resisted other chemotherapy drugs. Topotecan<sup>®</sup>, which worked as well as or better than Taxol<sup>®</sup> (see Essay on Taxol<sup>®</sup> and chemical structure of taxol in Figure 1.34) in clinical trials, is manufactured by SmithKline Beecham Pharmaceuticals and is sold under the trade name Hycamtin<sup>®</sup>. Camptothecin and its congeners are topoisomerase I inhibitors. The topoisomerases wind and unwind DNA (see Section 1.7). By keeping the DNA wound tight, the camptothecin class of drugs helps prevent the rapid cell

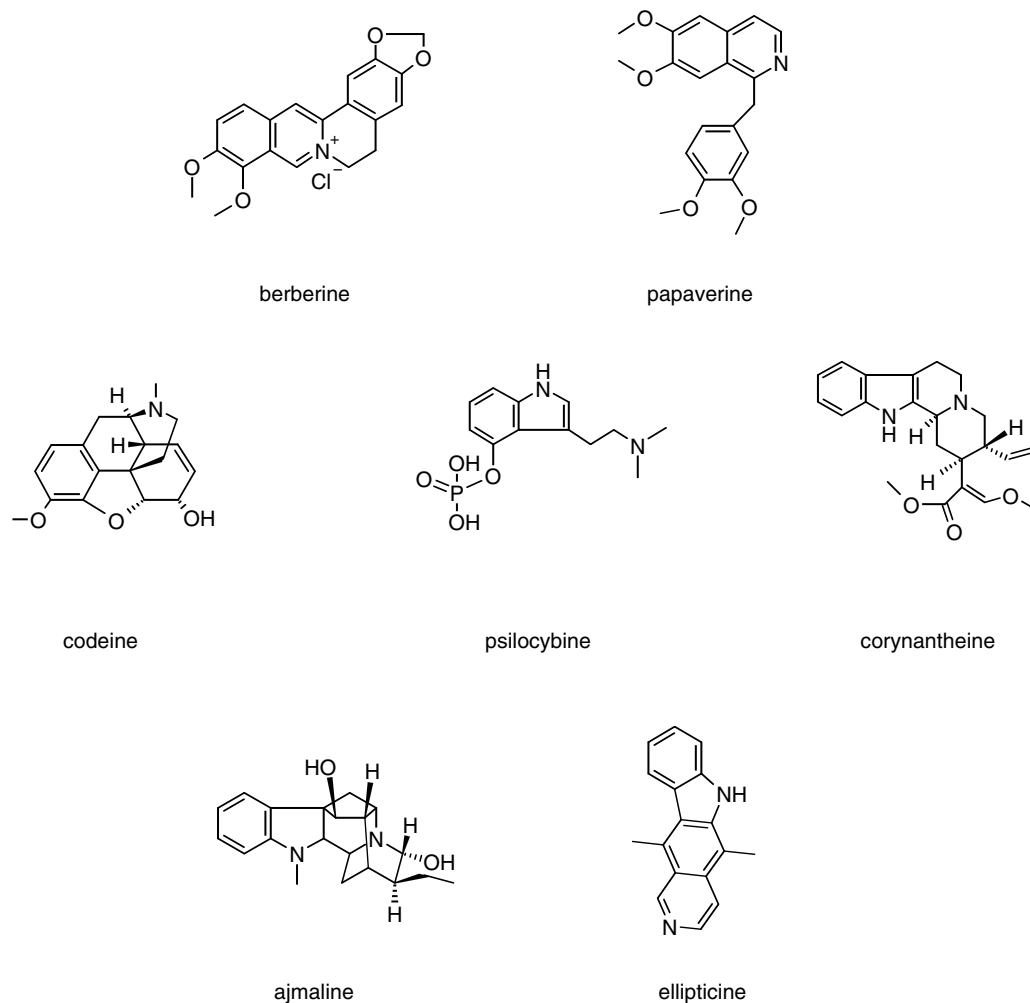
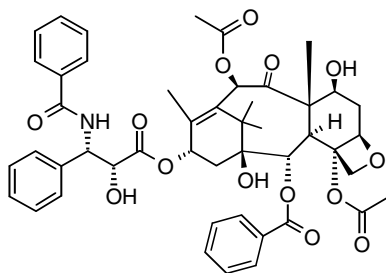

FIGURE 1.33 (Continued.) (B) Additional alkaloids — part 2.

growth and reproduction characteristic of cancer (Potmesil and Pinedo, 1995; Pommier, 2004; Thomas et al., 2004).

**Berberine** is a relatively nontoxic alkaloid found in several plants, including goldenseal (*Hydrastis canadensis*), barberry (*Berberis vulgaris*), Oregon grape (*Berberis aquifolium*), and goldthread (*Coptis trifolia*). It has a long history and is most commonly used as an antibacterial agent (Birdsall and Kelly, 1997; Taylor and Greenough, 1989). **Papaverine** is used as a vasodilator under the trade name Para-Time® SR and is used orally to treat erectile dysfunction (Kalsi et al., 2002). **Codeine** is said to be the most widely used naturally occurring narcotic in medical treatment. Derived from morphine, it has far milder effects (though overdose can be fatal) (Lee et al., 2004) and is typically used for the treatment of pain and as a cough suppressant. **Psilocybine** is a tryptamine-class alkaloid with potent hallucinogenic effects, similar to those of LSD, but generally lasting for shorter times. It is present in liberty cap mushrooms (*Psilocybe semilanceata*, also known as magic mushrooms). It acts as a prodrug by dephosphorylation to the active psilocine. **Psilocine** then mimics **serotonin** in the brain, operating as a serotonin receptor agonist (Vollenweider et al., 1998). **Ajmaline** is a class Ia antiarrhythmic drug used in several European countries and Japan as first-line treatment for ventricular tachyarrhythmia (Kiesecker et al., 2004). Finally, **ellipticine** is used in cancer treatment, as it is believed to act through DNA intercalation and inhibition of topoisomerase II (Stiborova et al., 2004).



taxol (paclitaxel)

FIGURE 1.34 Taxol® (paclitaxel).

---

### Essay on Taxol® (Paclitaxel) from Yew (*Taxus* spp.)

Beginning in 1958, the U.S. National Cancer Institute in collaboration with the U.S. Department of Agriculture conducted a massive collection (>35,000 samples) of plants for anticancer activity. Four years later, of the thousands of samples collected, one included about 15 lb of the needles and bark of the pacific yew (*Taxus brevifolia*). By 1971, it was determined that an individual component of the yew has remarkable anticancer activity. However, obtaining sufficient amounts of the substance, temporarily known as compound 17, remained elusive. Interest in this material greatly increased in 1979, when it was found that the anticancer activity was not only potent, but, more importantly, was preceded by a unique mechanism of action involving tubulin stabilization. Phase I (safety in humans) clinical trials began in 1983, and Phase II (efficacy) trials began in 1985. Finally, the first of several FDA approvals for various uses for Taxol® was announced in 1992. Today, it is one of the world's most widely used cancer treatments. On April 23, 2003, the discoveries of Taxol® and camptothecin (see Section 1.5.2 for a discussion) were designated national historic chemical landmarks at the Research Triangle Institute by the American Chemical Society. The chemical structure of Taxol®, an alkaloid with a diterpenoid core, is shown in Figure 1.34.

---

## 1.6 Amino Acids, Nonprotein Amino Acids, and Proteins

Much of the genetic information contained within every cell of plants and animals is expressed in the form of **proteins**. Proteins are made up individually from large chains of **amino acids**. Smaller proteins (made from shorter oligomers of amino acids) are called **peptides**. Proteins play an enormous variety of roles. Some carry out the transport and storage of small molecules, while others make up a large part of the structural framework of cells and tissues. Perhaps the most important class of proteins are the **enzymes**, the catalysts that promote the enormous variety of reactions that channel metabolism into essential pathways (see Chapter 2). Individual types of cells may contain several thousand kinds of proteins, and many of these proteins have additional chemical modifications that cause them to cross over the lines of the chemical categories of compounds that we discuss in this chapter. There are protein modifications that include the attachment of just about all of the categories of phytochemicals described so far, including lipids, aromatics, and carbohydrates. Such modifications are outside the scope of this chapter, but some are discussed in Section 1.6.3.

### 1.6.1 Amino Acids

Like other amines, amino acids contain a nitrogen group as part of the chain of their structure. However, they also possess a carboxyl group that can act as an acid when free in solution and, hence, the name “amino acid.” Amino acids also possess side chains called R-groups that have differing structures and character that give each amino acid residue its chemical properties. The protein amino acids are normally considered to be 20 in number for plants. The amino acids are high-melting, water-soluble, zwitterionic colorless solids. Because they have both basic (amine) and acidic (acid) functionalities, the amino acids have specific  $pK_a$ s unique to each amino acid. The 20 principal amino acids are shown in Figure 1.35.

### 1.6.2 Nonprotein Amino Acids

There are also a wide range of amino acids that are not incorporated into proteins. These amino acids often possess special functions within the plant. For example, **L-canavanine** is a highly toxic nonprotein amino acid analog of L-arginine (Figure 1.26) found in some leguminous seeds such as jack bean (*Canavalia ensiformis*) and alfalfa (*Medicago sativa*) (Rosenthal, 1977). Because of its structural similarity to L-arginine, L-canavanine acts as an antimetabolite. If ingested, L-canavanine can be incorporated in place of L-arginine during polypeptide biosynthesis and, thereby, disrupt critical reactions of RNA and DNA metabolism as well as protein synthesis (Rosenthal and Dahlman, 1986). Thus, L-canavanine alters essential biochemical reactions and is a highly toxic phytochemical. L-Canavanine exhibits potent insecticidal properties and likely evolved as an allelochemic agent that deters herbivory. Because of its toxic properties, L-canavanine is also a promising antitumor agent (Bence and Crooks, 2003). Another nonprotein amino acid that is regularly found in plants is **D-aminobutyric acid** (Figure 1.36). Several hundred others are known, although no others have been found to be more or less ubiquitous. Additionally, atypical amino acids, peptides, and proteins exist that are constructed from nonribosomal processes that are also essential to the life of a plant. This is a more recent field that is currently popular with natural product chemists (Mabry, 2001; Pan et al., 1997; Rozan et al., 2001).

### 1.6.3 Proteins

First named by Berzelius, **proteins** are one of the classes of biomacromolecules, alongside polysaccharides and nucleic acids, that make up the primary constituents of living things, including plants. **Proteins** are generally high-molecular-weight polymers of amino acids, having molecular masses of up to one million or more. They are synthesized based on the triplet base code of DNA. DNA is transcribed to yield messenger RNA (mRNA), which serves as a template for translation by **ribosomes**. Because the individual amino acids that make up proteins in plants and animals exist each as a single enantiomer, the polypeptide will take on a specific nonsuperimposable three-dimensional shape. The two ends of this polypeptide chain are referred to as the **carboxy terminus** (C-terminus) and the **amino terminus** (N-terminus) based on the nature of the free group on each extremity. However, proteins also have varying amounts of flexibility and conformational lability that are dependent on the medium and interactions with other molecules. Biochemists have identified five components of the shape of a protein:

1. **Primary structure:** the amino acid sequence
2. **Secondary structure:** folding — this can yield, for example, structures such as sheets or helices
3. **Tertiary structure:** the overall shape of a single protein molecule, as a result of the sequence and secondary structures within the entire protein
4. **Quaternary structure:** the shape or structure that results from the union of more than one protein molecule
5. **Post-translational modifications:** the addition of other chemical groups to the protein (the product of translation), which give many proteins their final cellular function

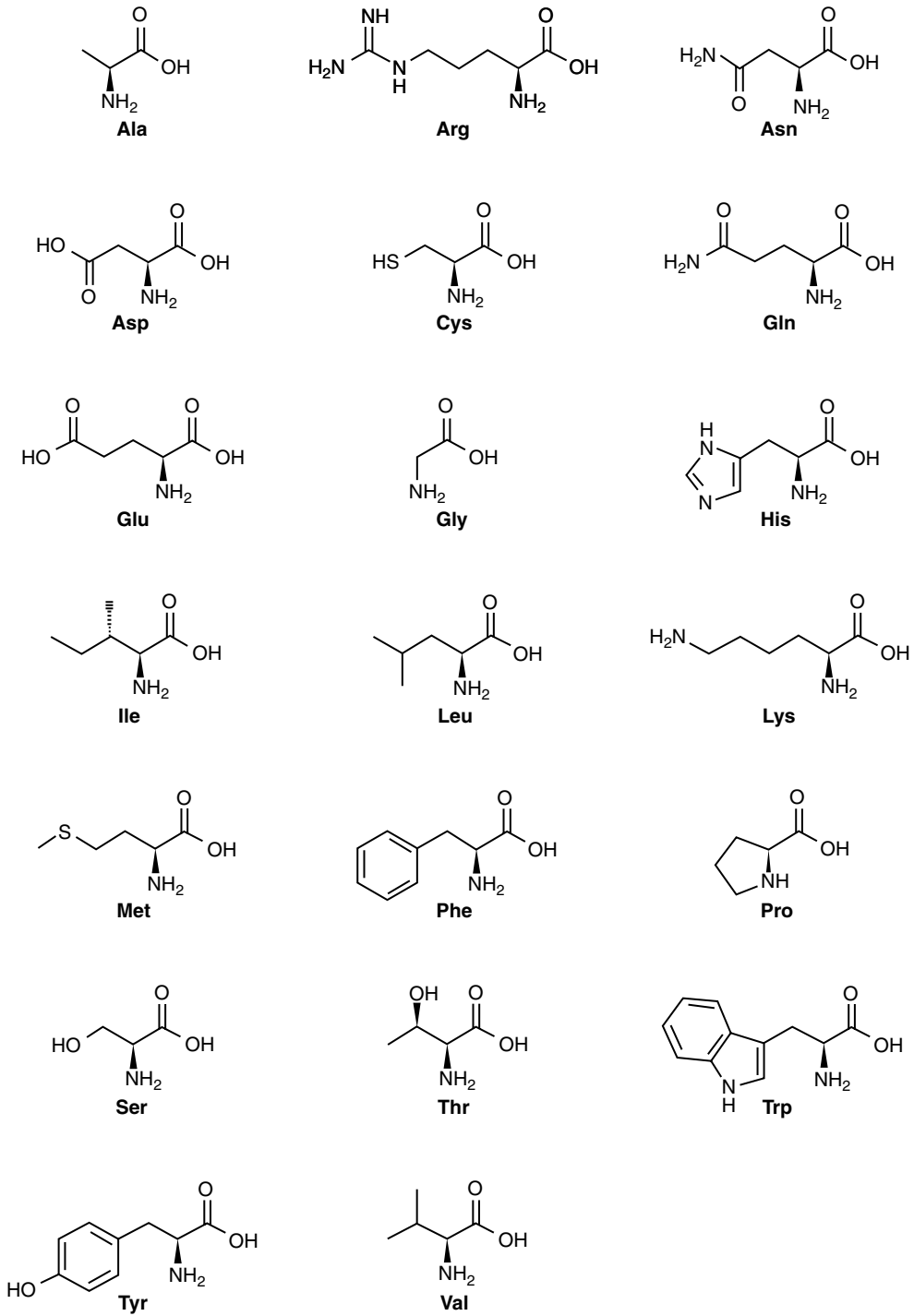

FIGURE 1.35 The 20 amino acids that are incorporated into proteins.

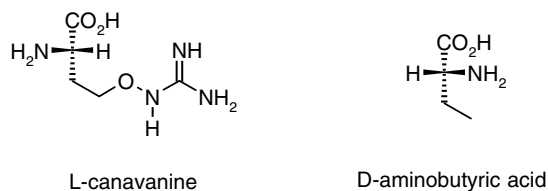

FIGURE 1.36 Nonprotein amino acids.

Because of the flexible nature of proteins, they may shift between several different structures in performing their biological function. These transitions are called **conformational changes**. The primary structure is held together by intramolecular covalent peptide bonds that are made during the process of **translation**. The secondary structures are held together primarily by intramolecular hydrogen bonds of the amide groups. The tertiary structure of a protein is the result of intramolecular interactions of the various R-groups of the amino acids, including hydrophobic interactions, hydrogen bonding, ionic interactions (salt bridges), and disulfide bonds. The final function of a protein, however, greatly depends on its interactions with other molecules within the cell. These interactions may be permanent modifications, such as association with additional proteins (the quaternary structure), or there may be various post-translational modifications where other molecules are covalently linked to the polypeptide chain.

The function of proteins involves practically every function performed by a huge variety of cell types, including structural proteins that provide the cell with a framework to proteins that regulate cellular functions such as signal transduction and metabolism. As mentioned in the introduction to Section 1.6, some proteins act as enzymes or catalysts for chemical reactions. Other proteins act as receptors that change conformation when they come in contact with specific molecules. For such enzymatic and receptor proteins, various molecules and ions may bind to specific sites (binding sites) on proteins, thus acting as **ligands**. The strength of ligand–protein binding is a measure of the affinity of the ligand to the binding site, and some of the receptor proteins with such binding sites allow each cell to interact with its environment across the cellular membrane and cell wall.

The solubility of proteins can vary. While many enzymatic and regulatory proteins are generally considered to be water-soluble plant components, there are a large number of proteins (structural, enzymatic, and receptor proteins) that are associated with the various lipid membranes found within each cell type (see Chapter 2 for more information). Many types of proteins are also found within the network of complex carbohydrates found in the cell walls of plants. One type of cell-wall proteins, called **glycoproteins**, contains carbohydrate side chains on certain amino acids (one type of post-translational modification). Such modified proteins are found in all layers of the plant cell wall, but they are more abundant in the primary wall layer. In addition to **hydroxyproline**, cell-wall proteins are often high in the amino acids **proline** and **lysine**. Another type of structural cell-wall protein is called **extensin**. In extensin, tyrosine residues are evenly spaced and can wrap around other cell-wall constituents, “knitting” the wall together.

### 1.6.3.1 Storage Proteins, Lectins, and Diet

**Seed storage proteins** constitute another class of proteins that act as an energy reserve for the cell. They are synthesized and stored in **protein bodies** in cells of developing seeds/fruits during **fruit ripening** (called **pod-fill** in legumes and **grain-fill** in cereals). In soybeans (*Glycine max*), for example, the main seed storage proteins are **glyceollins**, found mainly in the cotyledons of the seeds. In rice (*Oryza sativa*), we encounter four classes of seed storage proteins based on differences in their solubility in water and alcohol: **prolamin**, **albumin**, **globulin**, and **glutelin**. These storage proteins are found mainly in the **aleurone layer** surrounding the endosperm tissue of the seed, which is present in **brown rice** but absent in polished **white rice** (Juliano, 1985).

**Lectin**-type proteins are also found in seeds. Plant lectins (also called **phytohemagglutinins**) are a group of proteins, widely distributed in nature, that have the ability to agglutinate **erythrocytes** (red blood cells) and many other types of cells through specific sugar-binding properties. Chemically, they



are glycoproteins. The molecular weights of lectins vary between 17,000 and 400,000. Well-known plant lectins include **concanavalin A** from jack bean (*Canavalia ensiformis*), **ricin** (a highly toxic protein from castor bean, *Ricinus communis*), **soybean agglutinin** (SBA), and **wheat germ agglutinin** (WGA). The function of many of the lectin proteins in plants is unknown, but their functions in recognition interactions have been determined (see Chapter 2).

Such stored proteins greatly influence the diets of both animals and humans. Human bodies can make use of all amino acids normally obtained from food for synthesizing new proteins. Many of these amino acids come from the breakdown of proteins in our diets. The nonessential amino acids are those that need not be supplied by the diet because they can be synthesized from other amino acids within our bodies. However, proteins differ in their ability to provide all eight of the amino acids that humans cannot produce themselves (**threonine, valine, tryptophan, isoleucine, leucine, lysine, phenylalanine, and methionine**). Research has shown that the body maintains amino acid pools that only need to be replaced once every few days. Human protein requirements are much lower than was once assumed. Peanuts (*Arachis hypogaea*), soybean (*Glycine max*), and other edible bean-type legumes; the alga, *Spirulina*; and certain grains (e.g., tef [*Eragrostis tef*]; finger millet [*Eleusine coracana*]; fonio [*Digitaria exilis* and *D. iburua*]; and pearl millet or bajra [*Pennisetum glaucum*]) are examples of edible food crops that are relatively rich in storage proteins (10 to 45 percentage of dry weight depending on the taxon and cultivar) in their seeds.

Protein deficiency can be a serious problem. Symptoms may include fatigue, insulin resistance, hair loss, loss of hair pigment (hair that should be black becomes reddish), loss of muscle mass (proteins repair muscle tissue), low body temperature, and hormonal irregularities. Severe protein deficiency, encountered only in times of famine, is fatal. Excess protein can cause problems as well. For example, it can overstimulate the immune system and, in severe cases, can lead to liver dysfunction from increased toxic residues and bone loss due to increased acidity in the blood, and has also been linked to obesity.

---

## 1.7 Nucleic Acids, Nucleotides, and Nucleosides

**Nucleic acids** are most commonly thought of as the repositories of genetic information for every cell, tissue, and organism. There are two major nucleic acids within each living cell: **deoxyribonucleic acid** (DNA) and **ribonucleic acid** (RNA). These are very long chain-like macromolecules that store and transfer genetic information. They are major components of all cells, comprising up to 15% of their dry weight, and the term “nucleic” comes from the fact that they were first discovered in the nucleus of each cell. DNA and RNA are polymers comprised of five different monomeric units: **adenine, thymine** (DNA only), **uracil** (RNA only), **cytosine**, and **guanine**. DNA contains two **pyrimidine bases** (cytosine and thymine) and two **purine bases** (adenine and guanine). RNA has the same nitrogenous bases except that uracil replaces thymine. These individual monomers are composed of (1) a nitrogenous heterocyclic purine or pyrimidine base, (2) a pentose sugar (ribose for RNA, deoxyribose for DNA), and (3) a molecule of phosphoric acid. Thus, nucleic acids are one of many classes of compounds that fall within several chemical categories of compounds at the same time. When the individual monomer contains all three components (sugar, base, and phosphate), it is referred to as a **nucleotide**, and when it lacks the phosphate, it is referred to as a **nucleoside** (Figure 1.37). With the help of enzymes called polymerases, the nucleotides come together to form polymers of DNA and RNA, thus generating the genetic code.

The five primary nucleotides can be isolated in significant amounts from plant cells. However, numerous other purine and pyrimidine derivatives have also been isolated from plant tissues. The free purines and pyrimidines as well as the free nucleosides occur only in trace amounts in most plant cells, but a number of unusual bases with closely related structures can be easily isolated in plants. **5-Methylcytosine**, for example, is found in the DNA of wheat germ. The pyrimidine glycosides, **vicine** and **convicine**, are found in certain legume seeds. The methylated purines, **theobromine** and **caffeine**, occur regularly in plants and are valued for their stimulant effects. Substituted purines constitute the **cytokinins** (e.g., **zeatin**) that act as plant growth regulators and initiators of cell division. These naturally occurring purines and pyrimidines are shown in Figure 1.38. While many of the free nucleic acids seem to act as precursors during the biosynthesis of other compounds within the cell, the function of most of

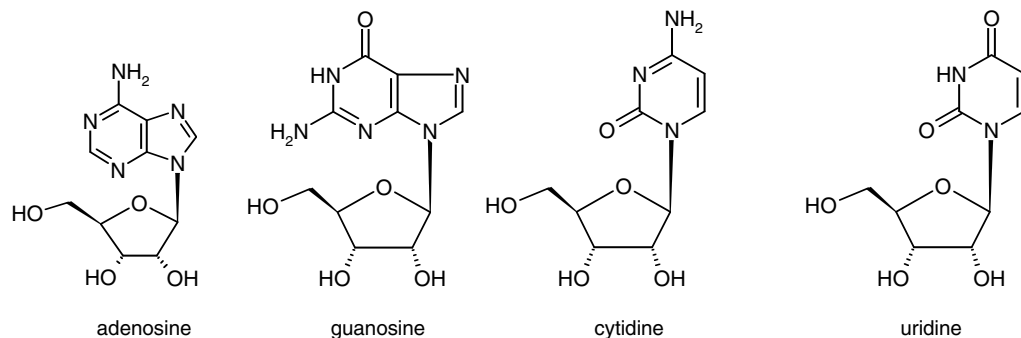

FIGURE 1.37 The nucleosides that can be obtained from RNA.

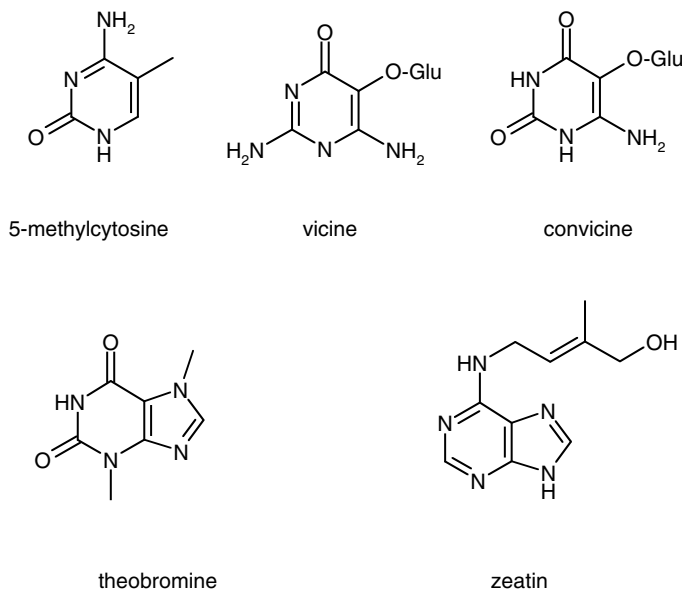

FIGURE 1.38 Naturally occurring purines and pyrimidines.

the rare bases is not well understood, though it was found that transfer RNA may contain up to 10% of these minor components.

## 1.8 Conclusions

Plants produce an amazing array of organic chemicals with an enormous diversity of structural types. Many of these phytochemicals are essential for plant growth and development and are widely used by humans and other animals as food sources. They include a wide variety of 3-C, 4-C, 5-C, 6-C, and 7-C sugars; polysaccharides such as cellulose, starch, and fructans; the polyphenol, lignin; fatty acids and lipids; proteins such as enzymes and structural components in cell membranes; and nucleic acids such as DNA and RNA. Many more have undoubtedly evolved in response to ecological pressures of competition, including plant-to-plant competition for light and space, herbivory from marauding insects and other fauna, as well as bacterial and fungal infections (e.g., phytoalexins). These biologically active compounds are not only necessary for the well-being, survival, and evolution of the plants that produce them, but also for humans, who have exploited them for industrial (e.g., ethanol from corn and sugarcane as an alternative energy source and, currently, pharmaceutical biotechnology and nanotechnology),

construction (e.g., houses, bridges, barrels, baseball bats, fences, insulation), fuel (e.g., crop residues, wood chips, and sawdust), agricultural (e.g., fruits, vegetables, herbs and spices, wine and beer products, animal feeds, forest and horticultural products, and landscape plants), medical/pharmaceutical, recreational, and even spiritual/religious purposes. In succeeding chapters of this book, you will learn a great deal more about these uses of natural products from plants.

---

## References

- Andrade, P.B., R. Leitao, R.M. Seabra, M.B. Oliveira, and M.A. Ferreira. (1998). 3,4-Dimethoxycinnamic acid levels as a tool for differentiation of *Coffea canephora* var. *robusta* and *Coffea arabica*. *Food Chem* 61: 511–514.
- Anonymous. (1884). Pharmacology and therapeutics. *Lancet* 124: 558–560.
- Anonymous. (1907). Celery. *Lancet* 170: 1337.
- Archer, A.W. (1988). Determination of saffrole and myristicin in nutmeg and mace by high-performance liquid chromatography. *J Chromatogr* 438: 117–121.
- Armstrong, R.W., J.M. Beau, S.H. Cheon, W.J. Christ, H. Fujioka, W.H. Ham, L.D. Hawkins, H. Jin, S.H. Kang, Y. Kishi, M.J. Martinelli, W.W. McWhorter, M. Mizuno, M. Nakata, A.E. Stutz, F.X. Talamas, M. Taniguchi, J.A. Tino, K. Ueda, J. Uenushi, J.B. White, and M. Yonaga. (1989). Total synthesis of palytoxin carboxylic acid and palytoxin amide. *J Am Chem Soc* 111: 7530–7533.
- Azadbakht, M. and M. Talavaki. (2003). Qualitative and quantitative determination of pyrrolizidine alkaloids of wheat and flour contaminated with senecio in mazandaran province farms. *Iran J Pharm Res* 2: 179–183. <http://www.ijpr-online.com/Docs/20033/IJPR147.pdf>.
- Bailey, P.L., J.B. Streisand, N.L. Pace, S.J.M. Bubbers, K.A. East, S. Mulder, and T.H. Stanley. (1997). Transdermal scopolamine reduces nausea and vomiting after outpatient laparoscopy. *Anesthesiology* 72: 977–980.
- Bajgar, J. (2004). Organophosphates/nerve agent poisoning: mechanism of action, diagnosis, prophylaxis, and treatment. *Adv Clin Chem* 38: 151–216.
- Barlam, T.F. and E. McCloud. (2003). Severe gastrointestinal illness associated with olestra ingestion. *J Pediatr Gastroenterol Nutr* 37: 95–96.
- Barrero, A.F., J.F. Quilez, and M. Herrador. (2003). Podolactones: a group of biologically active norditerpenoids. *Stud Nat Prod Chem* 28: 453–516.
- Bence, A.K. and P.A. Crooks. (2003). The mechanism of L-canavanine cytotoxicity: arginyl tRNA synthetase as a novel target for anticancer drug discovery. *J Enzyme Inhib Med Chem* 18: 383–394.
- Bercovitch, M., A. Waller, and A. Adunsky. (1999). High dose morphine use in the hospice setting. A database survey of patient characteristics and effect on life expectancy. *Cancer* 86: 871–877.
- Birdsall, T. and G. Kelly. (1997). Berberine: therapeutic potential of an alkaloid in several medicinal plants. *Altern Med Rev* 2: 94–103. [http://www.thorne.com/pdf/journal/5-2/berberine\\_monograph.pdf](http://www.thorne.com/pdf/journal/5-2/berberine_monograph.pdf).
- Blanco, T.C., E.E. Stashenko, M.Y. Combariza, and J.R. Martinez. (1995). Comparative study of Colombian citrus oils by high-resolution gas chromatography and gas chromatography-mass spectrometry. *J Chromatogr A* 697: 501–513.
- Blunt, J., B.R. Copp, M.H.G. Munro, P.T. Northcote, and M.R. Prinsep. (2004). Marine natural products. *Nat Prod Rep* 21: 1–49.
- Bo, T., K.A. Li, and H. Liu. (2002). Fast determination of flavonoids in *Glycyrrhiza radix* by capillary zone electrophoresis. *Anal Chim Acta* 458: 345–354.
- Boar, R.B. and J. Allen. (1973).  $\beta$ -Amyrin triterpenoids. *Phytochemistry* 12: 2571–2578.
- Bordoloi, M., V.S. Shukla, S.C. Nath, and R.P. Sharma. (1989). Naturally occurring cadinenes. *Phytochemistry* 28: 2007–2037.
- Boyd, C. and J. Dering. (1996). Medicinal and hallucinogenic plants identified in the sediments and pictographs of the Lower Pecos, Texas. *Archaic Antiquity* 70: 256–275.
- Brenner, E.D. (2002). Drugs in the plant. *Cell* 109: 680–681.
- Britton, G. (1995). Structure and properties of carotenoids in relation to function. *FASEB J* 9:1551–1558. See also: The importance of the pigments of life. <http://www.unine.ch/chim/ecsoc-3/introduction.html>.

- Bruice, P.Y. (2004). *Organic Chemistry*, 4th ed., chap. 26. Prentice Hall, Upper Saddle River, New Jersey.
- Bruneton, J. (1999). *Pharmacognosy, Phytochemistry, Medicinal Plants*, 2nd ed. Lavoisier Publishers, Andover, United Kingdom.
- Buchanan, R.B., W. Gruissem, and R.L. Jones. (2000). *Biochemistry and Molecular Biology of Plants*. American Society of Plant Physiologists, Rockville, Maryland.
- Buckingham, J. (2005). *Dictionary of Natural Products* on CD-ROM, v. 13:1. Chapman & Hall/CRC Press, Boca Raton, Florida.
- Budavari, S. (Ed.). (2001). *The Merck Index*. 13th ed. Merck & Co, Whitehouse Station, New Jersey.
- Butler, A. and J. Carter-Franklin. (2004). The role of vanadium bromoperoxidase in the biosynthesis of halogenated marine natural products. *Nat Prod Rep* 21: 180–188.
- Christensen, L.P., J. Lam, and T. Thomasen. (1990). Thiophene derivatives and polyacetylenes from *Dahlia tubulata*. *Phytochemistry* 29: 3153–3154.
- Clark, G.S. (1990). Leaf alcohol. *Perfumer & Flavorist* 15: 47–52.
- Cohen, S.S. (1998). *A Guide to the Polyamines*. Oxford University Press, New York.
- Connolly, J.D. and R.A. Hill. (2004). Triterpenoids. *Nat Prod Rep* 20: 640–659.
- Cordell, G. (1981). *Introduction to Alkaloids: A Biogenetic Approach*. Wiley and Sons, New York.
- Corey, E.J., R.N. Mitra, and H. Uda. (1964). Total synthesis of dl-caryophyllene and dl-isocaryophyllene. *J Am Chem Soc* 86: 485–492.
- Cornwell, T., W. Cohick, and I. Raskin. (2004). Dietary phytoestrogens and health. *Phytochemistry* 65: 995–1016.
- Croteau, R. (1998). The discovery of terpenes. *Discoveries in Plant Biol* 1: 329–343.
- Croteau, R.L. and W.D. Loomis. (1975). Biosynthesis and metabolism of monoterpenes. *Int Flavours and Food Additives* 6: 292–296.
- Crowell, P.L. and M.N. Gould. (2004). Cancer chemopreventive activity of monoterpenes and other isoprenoids. *Cancer Chemoprevention* 1: 371–378.
- Cseke, L.J., P.B. Kaufman, G.K. Podila, and C.-J. Tsai. (2004). *Molecular and Cellular Methods in Biology and Medicine*, 2nd ed., CRC Press, Boca Raton, Florida.
- Cunnane, S.C. (2003). Problems with essential fatty acids: time for a new paradigm? *Prog Lipid Res* 42: 544–568.
- Cushnie, T.P., V.E. Hamilton, and A.J. Lamb. (2003). Assessment of the antibacterial activity of selected flavonoids and consideration of discrepancies between previous reports. *Microbiol Res* 158: 281–289.
- Davidson, B.C. and R.C. Cantrill. (1985). Fatty acid nomenclature. A short review. *S Afr Med J* 67: 633–634.
- Davies, P.J. (Ed.). (2004). *Plant Hormones. Physiology, Biochemistry, and Molecular Biology*, 3rd ed. Springer, New York.
- De Lorgeril, M. (1998). Mediterranean diet in the prevention of coronary heart disease. *Nutrition* 14: 55–57.
- De Lorgeril, M. and P. Salen. (2004). Alpha-linolenic acid and coronary heart disease. *Nutr Metab Cardiovasc Dis* 14: 162–169.
- Dell'Agli, M. and E. Bosisio. (2002). Minor polar compounds of olive oil: composition, factors of variability, and bioactivity. *Stud Nat Prod Chem* 27: 697–734.
- DeSimone, R.W., K.S. Currie, S.A. Mitchell, J.W. Darrow, and D.A. Pippin. (2004). Privileged structures: applications in drug discovery. *Comb Chem High Throughput Screen* 7: 473–493.
- Dong, X., M.O. Hamburger, G.A. Cordell, and H.H.S. Fong. (1989). Studies on zoapatle. IX. HPLC analysis of *Montanoa* species for pharmacologically active constituents. *Planta Medica* 55: 185–187.
- Dubey, V.S., R. Bhalla, and R. Luthra. (2003). An overview of the non-mevalonate pathway for terpenoid biosynthesis in plants. *J Biosci* 28: 637–646. <http://www.ias.ac.in/jbiosci/sep2003/637.pdf>.
- DuBois, G.E., G.A. Crosby, and R.A. Stephenson. (1981). Dihydrochalcone sweeteners. A study of the atypical temporal phenomena. *J Med Chem* 24: 408–428.
- Dudareva, N., L. Cseke, V.M. Blanc, and E. Pichersky. (1996). Evolution of floral scent in *Clarkia*: novel patterns of S-linalool synthase gene expression in the *C. breweri* flower. *The Plant Cell* 8(7): 1137–1148.
- Duke, J.A. (1992). *Handbook of Biologically Active Phytochemicals and Their Activities*. CRC Press, Boca Raton, Florida.
- Duke, J.A. (2005). James Duke's phytochemical database. <http://www.ars-grin.gov/duke>.
- Eglinton, G. and R. Hamilton. (1967). Leaf epicuticular waxes. *Science* 156: 1322–1335.
- Eisenreich, W., A. Bacher, D. Arigoni, and F. Rohdich (2004). Biosynthesis of isoprenoids via the non-mevalonate pathway. *Cell Mol Life Sci* 61:1401–1426.

- El Bardai, S., N. Morel, M. Wibo, N. Fabre, G. Llabres, B. Lyoussi, and J. Quetin-Leclercq. (2003). The vasorelaxant activity of marrubenol and marrubiin from *Marrubium vulgare*. *Planta Medica* 69: 75–77.
- Erickson, K.L. (1983). Constituents of *Laurencia*. In *Marine Natural Products: Chemical and Biological Perspectives*, P. Scheuer (Ed.). Academic Press, New York, pp. 131–257.
- Fenwick, G.R., J. Lutomski, and C. Nieman. (1990). Liquorice, *Glycyrrhiza glabra* L.—Composition, uses and analysis. *Food Chem* 38: 119–143.
- Ferry, J. (1994). *Methanogenesis: Ecology, Physiology, Biochemistry, and Genetics*. Chapman & Hall, New York.
- Flynn, J. (1991). *Cocaine: An In-depth Look at the Facts, Science, History, and Future of the World's Most Addictive Drug*. Birch Lane, New York. See also: The tropane alkaloids. <http://www.people.vcu.edu/~asnedentropane%20alkaloids.pdf>.
- Fraga, B.M. (2003). Natural sesquiterpenoids. *Nat Prod Rep* 20: 392–413.
- Frankel, O.H., A.H. Brown, and J.J. Burdon. (1995). *The Conservation of Plant Biodiversity*. Cambridge University Press, New York.
- Fukuzawa, A. and E. Kurosawa. (1979). Constituents of marine plants. Part XXXVI. Laurallene, a new bromoallene from the marine red alga *Laurencia nipponica* Yamada. *Tet Lett* 30: 2797–2800.
- Fukuzawa, A. et al. (1985). Structure of a new bromoditerpene, prepinnaterpene, from the red alga *Laurencia pinnata* Yamada. *Chem Lett* 8: 1263.
- Gallus, S., C. Bosetti, and C. La Vecchia. (2004). Mediterranean diet and cancer risk. *Eur J Cancer Prev* 13: 447–452.
- Geissman, T.A. and D.H.G. Crout. (1969). *Organic Chemistry of Secondary Plant Metabolism*. Freeman-Cooper, San Francisco, California.
- Gil, A., E.B. De La Fuente, A.E. Lenardis, M. Lopez Pereira, S.A. Suarez, A. Bandoni, C. Van Baren, P. Di Leo Lira, and C.M. Ghersa. (2002). Coriander essential oil composition from two genotypes grown in different environmental conditions. *J Agric Food Chem* 50: 2870–2877.
- Golding, J.F. and J.R.R. Stott. (1997). Comparison of the effects of a selective muscarinic receptor antagonist and hyoscine (scopolamine) on motion sickness, skin conductance and heart rate. *Br J Clin Pharmacol* 43: 633–637.
- Graefe, E.U., H. Derendorf, and M. Veit. (1999). Pharmacokinetics and bioavailability of the flavonol quercetin in humans. *Int J Clin Pharmacol Ther* 37: 219–233.
- Guella, G., I. Mancini, G. Chiasera, and F. Pietra. (1992). On the unusual propensity by the red seaweed *Laurencia microcladia* of Il Rogiolo to form C<sub>15</sub> oxepanes: isolation of rogioloxepane A, B, and C, and their likely biogenetic acyclic precursor, prerogioloxepane. *Helv Chim Acta* 75: 310–322.
- Hagerman, A.E. and L.G. Butler. (1989). Choosing appropriate methods and standards for assaying tannin. *J Chem Ecol* 15: 1795–1810.
- Hamilton, R. (1995). *Waxes: Chemistry, Molecular Biology, and Functions*. Oily Press, Dundee, United Kingdom.
- Hansen, L. and P.M. Boll. (1986). Polyacetylenes in Araliaceae: their chemistry, biosynthesis and biological significance. *Phytochemistry* 25: 285–293.
- Hanson, J.R. (2004). Diterpenoids. *Nat Prod Rep* 21: 785–793.
- Haralampidis, K., M. Trojanowska, and A. Osbourn. (2002). Biosynthesis of triterpenoid saponins in plants. In *Advances in Biochemical Engineering/Biotechnology*, T. Scheper (Ed.). Springer-Verlag, Berlin, pp. 31–50. <http://www.jic.bbsrc.ac.uk/sainsbury-lab/ao/AdvBiochem.PDF>.
- Haynes, R.K. and S.C. Vonwiller. (1994). Extraction of artemisinin and artemisinic acid: preparation of artemether and new analogues. *Transactions of the Royal Society of Tropical Medicine and Hygiene*. 88 (Suppl. 1): 23–26. See also: Antimalarial medications. U.S. Navy Environmental Health Center, <http://www.vnh.org/Malaria/app4.html>.
- Hedden, P. and Y. Kamiya. (1997). Gibberellin biosynthesis: enzymes, genes and their regulation. *Annu Rev Plant Physiol Plant Mol Biol* 48: 431–460.
- Herbert, R.B. (2003). The biosynthesis of plant alkaloids and nitrogenous microbial metabolites. *Nat Prod Rep* 20: 494–508.
- Hoet, S., F. Opperdoes, R. Brun, and J. Quetin-Leclercq. (2004). Natural products active against African trypanosomes: a step towards new drugs. *Nat Prod Rep* 21: 353–364.
- Holopainen, J.K. (2004). Multiple functions of inducible plant volatiles. *Trends in Plant Sci* 9: 529–533. <http://www.uku.fi/~holopain/Holopainen-Trends-2004-revised.pdf>.

- Honigsbaum, M. (2002). *The Fever Trail: In Search of the Cure for Malaria*. Farrar, Straus, and Giroux, New York.
- Horwitz, S.B. (2004). Personal recollections on the early development of taxol. *J Nat Prod* 67: 136–138. See also: The Taxol® (paclitaxel) story. <http://www.taxol.com/timeli.html>.
- Host, B. and G.A. Williamson. (2004). A critical review of the bioavailability of glucosinolates and related compounds. *Nat Prod Rep* 21: 425–427.
- Hostettman, K. and A. Marston. (1995). *Saponins*. Cambridge University Press, United Kingdom.
- Humphrey, A.J. and D. O'Hagan. (2001). Tropane alkaloid biosynthesis. A century old problem unresolved. *Nat Prod Rep* 18: 494–502.
- Hylemon, P.B. and J. Harder. (1998). Biotransformation of monoterpenes, bile acids, and other isoprenoids in anaerobic ecosystems. *FEMS Microbiol Rev* 22: 475–488.
- Icon Health Publishers. (2004). *Atropine: A Medical Dictionary, Bibliography, and Annotated Research Guide To Internet References*. Icon Health Publishers, San Diego, California.
- Irie, T., M. Suzuki, and T. Masamune. (1965). Constituents from marine plants. II. Laurencin, a constituent from *Laurencia* species. *Tet Lett* 16: 1091–1092.
- Jacobi, P.A., R.W. DeSimone, I. Ghosh, J. Guo, S.H. Leung, and D. Pippin. (2000). New syntheses of the C,D-rings of pyromethenones of phytochrome and phycocyanin. *J Org Chem* 65: 8478–8489.
- Janses, B.J.M. and A. de Groot. (2004). Occurrence, biological activity, and synthesis of drimane sesquiterpenoids. *Nat Prod Rep* 21: 449–477.
- Johnson, I.T. (2003). Glucosinolates in the human diet. Bioavailability and implications for health. *Phytochem Rev* 1: 183–188.
- Jordan, M.A. (2002). Mechanism of action of antitumor drugs that interact with microtubules and tubulin. *Curr Med Chem Anti-Canc Agents* 2: 1–17.
- Juliano, B.O. (1985). *Rice Chemistry and Technology*. American Association of Cereal Chemists, St. Paul, Minnesota.
- Kalsi, J., S. Celtek, A. Muneer, P. Kell, D. Ralph, and S. Minhas. (2002). Current oral treatments for erectile dysfunction. *Expert Opin Pharmacother* 3: 1613–1629.
- Kanakis, C.D., D.J. Daferera, P.A. Tarantilis, and M.G. Polissiou. (2004). Qualitative determination of volatile compounds and quantitative evaluation of safranal and 4-hydroxy-2,6,6-trimethyl-1-cyclohexene-1-carboxaldehyde (HTCC) in Greek saffron. *J Agric Food Chem* 52: 4515–4521.
- Kang, D., V.P. Aneja, R. Mathur, and J.D. Ray. (2001). Nonmethane hydrocarbons and ozone in three rural southeast United States national parks: a model sensitivity analysis and comparison to measurements. *J Geophys Res* 108: 4604.
- Katiyar, S. (2005). Silymarin and skin cancer prevention: anti-inflammatory, antioxidant and immunomodulatory effects (Review). *Int J Oncol* 26: 169–176.
- Kaufman, P.B., J.A. Duke, H. Briemann, J. Boik, and J.E. Hoyt. (1997). A comparative survey of leguminous plants as sources of the isoflavones, genistein and daidzein: implications for human nutrition and health. *J Altern Complement Med* 3: 7–12.
- Kaufmann, G.B. (2004). On Robert B. Woodward and the total synthesis of quinine. *Chem Educator* 9: 172–176. <http://chemeducator.org/letters/0009003/930172erac1.pdf>.
- Kiesecker, C., E. Zitron, S. Luck, R. Bloehs, E.P. Scholz, S. Kathofer, D. Thomas, V.A. Kreye, H.A. Katus, W. Shoels, C.A. Karle, and J. Kiehn. (2004). Class Ia anti-arrhythmic drug ajmaline blocks HERG potassium channels: mode of action. *Naunyn Schmiedebergs Arch Pharmacol* 370: 423–435.
- Kinjo, J., H. Uemura, T. Nohara, M. Yamashita, N. Marubayashi, and K. Yoshihira. (1995). Novel yellow pigment from *Pterocarpus santalinus*: biogenetic hypothesis for santalin analogs. *Tetrahedron Lett* 36: 5599–5602.
- Koch, M. and R.P. Gregson. (1984). Brominated phloretols and nonhalogenated phlorotannins from the brown alga *Cystophora congesta*. *Phytochemistry* 23: 2633–2637.
- Kovar, K.A., B. Gropper, D. Friess, and H.P. Ammon. (1987). Blood levels of 1,8-cineole and locomotor activity of mice after inhalation and oral administration of rosemary oil. *Planta Med* 53: 315–318.
- Kovat, E. (1987). Composition of essential oils, part 7. Bulgarian oil of rose (*Rosa damascena* Mill.). *J Chromatogr A* 406: 185–222.
- Kris-Etherton, P.M., K.D. Hecker, A. Bonanome, S.M. Coval, A.E. Binkoski, K.F. Hilpert, A.E. Griel, and T.D. Etherton. (2002). Bioactive compounds in foods: their role in the prevention of cardiovascular disease and cancer. *Am J Med* 113 (Suppl 9B): 71S–88S.

- Krishna Kumari, G.N., S. Aravind, J. Balachandran, M.R. Ganesh, S. Soundarya Devi, S.S. Rajan, R. Malathi, and K. Ravikumar. (2003). Antifeedant neo-clerodanes from *Teucrium tomentosum* Heyne (Labiatae). *Phytochemistry* 64: 1119–1123.
- Kumari, G.W.K., S. Aravind, J. Balachandran, M.R. Ganesh, S.S. Devi, S.S. Rajan, R. Malathi, and K. Ravikumar. (2003). Antifeedant neo-clerodanes from *Teucrium tomentosum* Heyne (Labiatae). *Phytochemistry* 64: 1119–1123.
- Kuzuyama, T. (2002). Mevalonate and nonmevalonate pathways for the biosynthesis of isoprene units. *Biosci Biotechnol Biochem* 66: 1619–1627.
- Larson, K.M., M.R. Roby, and F.R. Stermitz. (1984). Unsaturated pyrrolizidines from borage (*Borago officinalis*), a common garden herb. *J Nat Prod* 47: 747–748.
- Lee, A.C., R. Chan, and K.T. So. (2004). A case of probable codeine poisoning in a young infant after the use of a proprietary cough and cold medicine. *Hong Kong Med J* 10: 285–287.
- Li, Y. and Y.L. Wu. (2003). An over four millennium story behind qinghaosu (artemisinin) — a fantastic antimalarial drug from a traditional Chinese herb. *Curr Med Chem* 10: 2197–2230.
- Liao, Y., Y. Hu, J. Wu, Q. Zhu, M. Donovan, R. Fathi, and Z. Yang. (2003). Diversity oriented synthesis and branching reaction pathway to generate natural product-like compounds. *Curr Med Chem* 10: 2285–2316.
- Librowski, T., J. Vetulani, and I. Nalepa. (2004). Carane derivative stereoisomers of different local anaesthetic and antiplatelet activity similarly potentiate forskolin-stimulated cyclic AMP response and bind to beta-adrenoceptors in the rat brain cortex. *J Pharm Pharmacol* 56: 1429–1434.
- Liu, J. (1995). Pharmacology of oleanolic and ursolic acid. *J Ethnopharmacol* 49: 57–68.
- Loper, K.A., L.B. Ready, and B.H. Dorman. (1989). Prophylactic transdermal scopolamine patches reduce nausea in postoperative patients receiving epidural morphine. *Anesthesia Analgesia* 68: 144–146.
- Lota, M.L., S.D. de Rocca, F.L. Tomi, C. Jacquemond, and J. Casanova. (2002). Volatile components of peel and leaf oils of lemon and lime. *J Agric Food Chem* 50: 796–805.
- Louli, V., G. Folas, E. Voutsas, and K. Magoulas. (2004). Extraction of parsley seed oil by supercritical CO<sub>2</sub>. *J Supercrit Fluids* 30: 163–174.
- Lund, E. and J. White. (1990). Polyacetylenes in normal and water-stressed Orlando Gold Carrots (*Daucus carota*). *J Sci Food Agric* 51: 507–516.
- Mabry, T.J. (2001). Selected topics from forty years of natural products research: betalains to flavonoids, antiviral proteins, and neurotoxic nonprotein amino acids. *J Nat Prod* 64: 1596–1604.
- Mazza, G. (1985). Gas chromatographic and mass spectrometric studies of the constituents of the rhizome of calamus I. The volatile constituents of the essential oil. *J Chromatogr A* 328: 179–194.
- McGeady, P., D.L. Wansley, and D.A. Logan. (2002). Carvone and perillaldehyde interfere with the serum-induced formation of filamentous structures in *Candida albicans* at substantially lower concentrations than those causing significant inhibition of growth. *J Nat Prod* 65: 953–955.
- Meshnick, S.R. (2002). Artemisinin: mechanisms of action, resistance and toxicity. *Int J Parasitol* 32: 1655–1660.
- Michael, J. (2004). Quinoline, quinazoline, and acridone alkaloids. *Nat Prod Rep* 21: 650–668.
- Michael, J.P. (2003). Indolizidine and quinolizidine alkaloids. *Nat Prod Rep* 20: 458–475.
- Miro, M. (1995). Cucurbitacins and their pharmacological effects. *Phytother Res* 9: 159–168.
- Miyashita, K., A. Tanaka, H. Shintaku, and C. Iwata. (1998). Regiospecific bromination-cyclization of spirocyclic cyclohexanones and its application to the synthesis of (+)-laurencial. *Tetrahedron* 54: 1395–1406.
- Moshonas, M.G. (1971). Analysis of carbonyl flavor constituents from grapefruit oil. *J Agric Food Chem* 19: 769–770.
- Moteki, H., H. Hibasami, Y. Yamada, H. Katsuzaki, K. Imai, and T. Komiya. (2002). Specific induction of apoptosis by 1,8-cineole in two human leukemia cell lines, but not in a human stomach cancer cell line. *Oncol Rep* 9: 757–760. See also: 1,8-Cineole. [http://www.chemistry.org/portal/a/c/s/1/acsdisplay.html?DOC=HomeMolecule%5Carchive%5Cmotw\\_1\\_8\\_cineole\\_arch.html#](http://www.chemistry.org/portal/a/c/s/1/acsdisplay.html?DOC=HomeMolecule%5Carchive%5Cmotw_1_8_cineole_arch.html#).
- Naj, J.J., J.H. Hahn, S. Chung, Y.I. Kim, and S.Y. Nah. (2000). Effects of ginsenosides, active components of ginseng, on capsaicin-induced pain-related behavior. *Neuropharmacology* 39: 2180–2184.
- Nakagawa-Goto, K., C.X. Chen, E. Hamel, C.C. Wu, K.F. Bastow, A. Brossi, and K.H. Lee. (2005). Antitumor agents. Part 236: synthesis of water-soluble colchicine derivatives. *Bioorg Med Chem Lett* 15: 235–238.
- Nawar, H.F. and J.O. Kuti. (2003). Weyerone acid phytoalexin synthesis and peroxidase activity as markers for resistance of broad beans to chocolate spot disease. *J Phytopathol* 151: 564–570.

- Negrusz, A. and R.E. Gaensslen. (2003). Analytical developments in toxicological investigation of drug-facilitated sexual assault. *Anal Bioanal Chem* 376: 1192–1197.
- Notka, F., G. Meier, and R. Wagner. (2004). Concerted inhibitory activities of *Phyllanthus amarus* on HIV replication *in vitro* and *ex vivo*. *Antiviral Res* 64: 93–102.
- Ntamila, M.S. and A. Hassanali. (1976). Isolation of oil of clove and separation of eugenol and acetyl eugenol. An instructive experiment for beginning chemistry undergraduates. *J Chem Educ* 53: 263.
- Nui, C.Q. and L.Y. He. (1991). Determination of isoquinoline alkaloids in *Chelidonium majus* L. by ion-pair high-performance liquid chromatography. *J Chromatogr A* 542: 193–199.
- Oberlies, N.H. and D.J. Kroll. (2004). Camptothecin and taxol: historic achievements in natural products research. *J Nat Prod* 67: 129–135.
- Odriozola, E., C. Campero, A. Casaro, T. Lopez, G. Olivieri, and O. Melucci. (1994). Pyrrolizidine alkaloidosis in Argentinian cattle caused by *Senecio selloi*. *Vet Hum Toxicol* 36: 205–208.
- Ohloff, G. (1994). *Scent and Fragrances. The Fascination of Odors and Their Chemical Perspectives*. Springer-Verlag, Berlin.
- Opdyke, D. (1987). Monographs on fragrance raw materials. Myrcene. *Food and Cosmet Toxicol* 14: 687–689.
- Pan, M., T.J. Mabry, J.M. Beale, B.M. Mamiya. (1997). Nonprotein amino acids from *Cycas revoluta*. *Phytochemistry* 45: 517–519.
- Patnam, R., S.S. Kadali, K.H. Koumaglo, and R. Roy. (2005). A chlorinated coumarolignan from the African medicinal plant, *Mondia whitei*. *Phytochemistry* 66: 683–686.
- Paul, L.D., D. Springer, R.F. Staack, T. Kraemer, and H.H. Maurer. (2003). Cytochrome P450 isoenzymes involved in rat liver microsomal metabolism of californine and protopine. *Eur J Pharmacol* 485: 69–79.
- Pcolinski, M.J., R.W. Duskotch, A.Y. Lee, and J. Clardy. (1994). Chlorosilphanol A and silphanepoxol, labdane diterpenes from *Silphium perfoliatum*. *J Nat Prod* 57: 776–783.
- Pediatric Eye Disease Investigator Group. (2002). A randomized trial of atropine vs. patching for treatment of moderate amblyopia in children. *Arch Ophthalmol* 120: 268–278.
- Pinner, A. (1893). Ueber Nicotin. *Arch Pharmacol* 231: 378–448.
- Ploypradith, P. (2004). Development of artemisinin and its structurally simplified trioxane derivatives as antimalarial drugs. *Acta Tropica* 89: 329–342. See also: Infectious disease diagnosis and treatment in southeast Asia. [http://www.pacificbridgemedical.com/publications/Infectious\\_Disease\\_SEA\\_1998.pdf](http://www.pacificbridgemedical.com/publications/Infectious_Disease_SEA_1998.pdf).
- Pommier, Y. (2004). Camptothecins and topoisomerase I: a foot in the door. Targeting the genome beyond topoisomerase I with camptothecins and novel anticancer drugs: importance of DNA replication, repair and cell cycle checkpoints. *Curr Med Chem Anti-Canc Agents* 4: 429–434.
- Potmesil, M. and H. Pinedo. (1995). *Camptothecins: new anticancer agents*. CRC Press, Boca Raton, Florida.
- Prakash, A.S., T.N. Pereira, P.E. Reilly, and A.A. Seawright. (1999). Pyrrolizidine alkaloids in human diet. *Mutat Res* 443: 53–67.
- Redl, K., W. Brey, and B. Davis. (1994). Anti-inflammatory active polyacetylenes from *Bidens campylotheca*. *Planta Medica* 60: 58–62.
- Rivera-Vargas, L.I., A.F. Schmitthenner, and T.L. Graham. (1993). Soybean flavonoid effects on and metabolism by *Phytophthora sojae*. *Phytochemistry* 32: 851–857.
- Robinson, T. (1991). *The Organic Constituents of Higher Plants*. Cordus Press, Amherst, Massachusetts.
- Rode, D. (2002). Comfrey toxicity revisited. *Trends Pharmacol Sci* 23: 497–499.
- Rosa, E.A.S., R.K. Heancy, G.R. Fenwick, and C.A.M. Portas. (1997). Glucosinolates in crop plants. *Hort Rev* 19: 99–215.
- Rosenthal, G.A. (1977). The biological effects and mode of action of L-canavanine, a structural analogue of L-arginine. *Q Rev Biol* 52: 155–178.
- Rosenthal, G.A. and D.L. Dahlman. (1986). L-Canavanine and protein synthesis in the tobacco hornworm *Manduca sexta*. *Proc Natl Acad Sci USA* 83: 14–18.
- Rouhi, A.M. (2003a). Rediscovering natural products. *Chem and Eng News* 81: 77–78, 82–83, 86, 88–91.
- Rouhi, A.M. (2003b). Betting on natural products for cures. *Chem and Eng News* 81: 93–94, 96–98, 100–103.
- Rozan, P., Y.H. Kuo, and F. Lambein. (2001). Amino acids in seeds and seedlings of the genus *Lens*. *Phytochemistry* 58: 281–289.
- Sacchetini, J.C. and C.D. Poulter. (1997). Creating isoprenoid diversity. *Science* 277: 1788–1789.
- Sakina, K. and K. Aota. (1976). Studies on the constituents of *Erythraea centaurium*. I. The structure of centapicrin, a new bitter secoiridoid glucoside. *Yakugaku Zasshi* 96: 683–688.



- Samuelsson, G. (2001). *Drugs of Natural Origin: A Textbook of Pharmacognosy*. 4th ed., Swedish Pharmaceutical Press, Stockholm, Sweden, p. 149.
- Savage, T.J., B.S. Hamilton, and R. Croteau. (1996). Biochemistry of short-chain alkanes. Tissue-specific biosynthesis of *n*-heptane in *Pinus jeffreyi*. *Plant Physiol* 110: 179–186.
- Scheer, H. (1991). *Chlorophylls*. CRC Press, Boca Raton, Florida.
- Scheuer, P.J. (1973). *The Chemistry of Marine Natural Products*. Academic Press, New York.
- Scheuer, P.J. (Ed.). (1978–1985). *Marine Natural Products: Chemical and Biological Perspectives*. Vols. 1–5. Academic Press, New York.
- Schlagheck, T.G., K.A. Riccardi, N.L. Zorich, S.A. Torri, L.D. Dugan, and J.C. Peters. (1997). Olestra dose response on fat-soluble and water-soluble nutrients in humans. *J Nutr* 127(Suppl. 8):1646S–1665S.
- Schmidt, T.J., R. Brun, G. Willuhn, and S.A. Khalid. (2002). Anti-trypanosomal activity of helenalin and some structurally related sesquiterpene lactones. *Planta Medica* 68: 750–751.
- Schmutterer, H. (1988). Potential of azadirachtin-containing pesticides for integrated pest control in developing and industrialized countries. *J Insect Physiol* 34: 713–719.
- Seaman, J.T. (1987). Pyrrolizidine alkaloid poisoning of sheep in New South Wales. *Aust Vet J* 64: 164–167.
- Shaw, J. (2001). Natural products with halogen-bearing stereogenic centers: natural origin and synthesis. [http://daecr1.harvard.edu/pdf/smnr\\_2001-2002\\_Shaw\\_Dr.%20Jared.pdf](http://daecr1.harvard.edu/pdf/smnr_2001-2002_Shaw_Dr.%20Jared.pdf).
- Shellie, R., L. Mondello, P. Marriott, and G. Dugo. (2002). Characterisation of lavender essential oils by using gas chromatography–mass spectrometry with correlation of linear retention indices and comparison with comprehensive two-dimensional gas chromatography. *J Chromatogr A* 970: 225–234.
- Shrestha, K., A.H. Banskota, S. Kodata, S.P. Shrivastava, G. Strobel, and M.B. Gewali. (2001). An antiproliferative norditerpene dilactone, Nagilactone C, from *Podocarpus neriifolius*. *Phytomedicine* 8: 489–491.
- Silverstone, A.L. and T. Sun. (2000). Gibberellins and the green revolution. *Trends Plant Sci* 5: 1–2.
- Sirisoma, N.S., K.M. Hold, J.E. Casida. (2001).  $\alpha$ - and  $\beta$ -thujones (herbal medicines and food additives): synthesis and analysis of hydroxyl and dehydro metabolites. *J Agric Food Chem* 49: 1915–1921.
- Smith, A.G. and M. Witty. (2002). *Heme, Chlorophyll, and Bilins: Methods and Protocol*. Humana Press, Totowa, New Jersey.
- Sørensen, H. (1990). Glucosinolates: structure, properties, function. In *Canola and Rapeseed. Production, Chemistry, Nutrition and Processing Technology*, F. Shahidi (Ed.). Van Nostrand Reinhold, New York, pp. 149–172.
- Sridar, C., T.C. Goosen, U.M. Kent, J.A. Williams, and P.F. Hollenberg. (2004). Silybin inactivates cytochromes P450 3A4 and 2C9 and inhibits major hepatic glucuronosyltransferases. *Drug Metab Dispos* 32: 587–594.
- Srivastava, L. (2002). *Plant Growth and Development: Hormones and Environment*. Academic Press, San Diego. See also: Plant-hormone information. <http://www.plant-hormones.info/index.htm>.
- Stiborova, M., J. Sejbál, L. Borek-Dohalska, D. Aimova, J. Poljakova, K. Forsterova, M. Rupertova, J. Wiesner, J. Hudecek, M. Wiessler, and E. Frei. (2004). The anticancer drug ellipticine forms covalent DNA adducts, mediated by human cytochromes P450, through metabolism to 13-hydroxyellipticine and ellipticine N<sup>2</sup>-oxide. *Cancer Res* 64: 8374–8380.
- Stoeckli, R. and U. Keller. (2004). Nutritional fats and the risk of type 2 diabetes and cancer. *Physiol Behav* 83: 611–615.
- Suffness, M. (Ed.). 1995. *TAXOL®: Science and Applications*. CRC Press, Boca Raton, Florida. See also: Stephenson F. A tale of taxol. <http://www.research.fsu.edu/researchr/fall2002/taxol.html>.
- Suzuki, T., K. Koizumi, M. Suzuki, and E. Kurosawa. (1983). Constituents of marine plants. 56. Kumausallene, a new bromoallene from the marine red alga *Laurencia nipponica* Yamada. *Chem Lett* 10: 1639–1641.
- Taber, D.F., T.D. Neubert, and A.L. Rheingold. (2002). Synthesis of (-)-morphine. *J Am Chem Soc* 124: 12416–12417. <http://www.emsb.qc.ca/laurenhill/science/morphine.pdf>.
- Tabor, C.W. and H. Tabor. (1984). Polyamines. *Annu Rev Biochem* 53: 749–790.
- Taylor, C.E. and W.B. Greenough. (1989). Control of diarrheal diseases. *Annu Rev Public Health* 10: 221–244.
- Temple, N.J. (1996). Dietary fats and coronary heart disease. *Biomed Pharmacother* 50: 261–268.
- Temple, W., N. Smith, and M. Beasley. (1991). Management of oil of citronella poisoning, *J Toxicol Clin Toxicol* 29: 257–262.
- Thomas, C.J., N.J. Rahier, and S.M. Hecht. (2004). Camptothecin: current perspectives. *Bioorg Med Chem* 12: 1585–1604.

- Thorneloe, S. (1993). Landfill gas and its influence on global climate change, EPA/600/A-93/240. National Technical Information Service, U.S. Department of Commerce, Washington, D.C.
- Trudgill, P.W. (1994). Microbial metabolism and transformation of selected monoterpenes. In *Biochemistry of Microbial Degradation*, C. Ratledge (Ed.). Kluwer, Dordrecht, pp. 33–61.
- Turner, A. (1970). Terpenoids and steroids. *Annu Rep on the Prog of Chem, Sect B: Org Chem* 66: 389–411.
- Ustunes, L., G.M. Laekeman, B. Gozler, A.J. Vlietinck, A. Ozer, and A.G. Herman. (1988). *In vitro* study of the anticholinergic and antihistaminic activities of protopine and some derivatives. *J Nat Prod* 51: 1021–1022.
- Utsunomiya, T., M. Kobayashi, R.B. Pollard, and F. Suzuki. (1997). Glycyrrhizin, an active component of licorice roots, reduces morbidity and mortality of mice infected with lethal doses of influenza virus. *Antimicrob Agents Chemother* 41: 551–556.
- Uwai, K., K. Ohashi, Y. Takaya, T. Ohta, T. Tadano, K. Kisara, K. Shibusawa, R. Sakakibara, and Y. Oshima. (2000). Exploring the structural basis of neurotoxicity in C<sub>17</sub> polyacetylenes isolated from water hemlock. *J Med Chem* 43: 4508–4515.
- Van Bergen, P., M.K. Peakman, E.C. Leigh-Fribank, and R. Evershed. (1997). Chemical evidence for archaeological frankincense: boswellic acids and their derivatives in solvent soluble and insoluble fractions of resin-like material. *Tetrahedron Lett* 38: 8409–8412.
- Verzera, A., A. Trozzi, F. Gazea, G. Ciccirello, and A. Cotroneo. (2003). Effects of rootstock on the composition of bergamot (*Citrus bergamia* Risso et Poiteau) essential oil. *J Agric Food Chem* 51: 206–210.
- Vollenweider, F.X., M.F. Vollenweider-Scherpenhuyzen, A. Babler, H. Vogel, and D. Hell. (1998). Psilocybin induces schizophrenia-like psychosis in humans via a serotonin-2 agonist action. *Neuroreport* 9: 3897–3902.
- Waller, D.P., A. Martin, Y. Oshima, and H.H. Fong. (1987). Studies on zoapatle. V. Correlation between *in vitro* uterine and *in vivo* pregnancy interruption effects in guinea pigs. *Contraception* 35: 147–153.
- Warren, M. (2004). *Tetrapyrroles*. Landes Bioscience, Georgetown, Texas.
- Weinberg, B. and B. Bealer. (2002). *The World of Caffeine: The Science and Culture of the World's Most Popular Drug*. Routledge, New York.
- Williams, C.A. and R.J. Grayer. (2004). Anthocyanins and other flavonoids. *Nat Prod Rep* 21: 539–573.
- Wilson, T.A., M. McIntyre, and R.J. Nicolosi. (2001). Trans fatty acids and cardiovascular risk. *J Nutr Health Aging* 5: 184–187.
- Woitke, H.D., J.P. Kayser, and K. Hiller. (1970). Triterpenesaponins, a review. *Pharmazie* 25: 213–241.
- Wu, L.W., Y.M. Chiang, H.C. Chuang, S.Y. Wang, G.W. Yang, Y.H. Chen, L.Y. Lai, and L.F. Shyur. (2004). Polyacetylenes function as anti-angiogenic agents. *Pharm Res* 21: 2112–2119.
- Youdim, K.A., A. Martin, and J.A. Joseph. (2000). Essential fatty acids and the brain: possible health implications. *Int J Dev Neurosci* 18: 383–399.
- Yuba, A., G. Honda, Y. Koezuka, and M. Tabata. (1995). Genetic analysis of essential oil variants in *Perilla frutescens*. *Biochem Genet* 33: 341–348. See also: Gernot Katzers Spice Dictionary. Perilla. [http://www-wang.kfunigraz.ac.at/~katzner/engl/generic\\_frame.html?Peri\\_fru.html](http://www-wang.kfunigraz.ac.at/~katzner/engl/generic_frame.html?Peri_fru.html).
- Zielinska, K. and W. Kisiel. (2000). Sesquiterpenoids from roots of *Taraxacum laevigatum* and *Taraxacum disseminatum*. *Phytochemistry* 54: 791–794.
- Zou, Y., Y. Lu, and D. Wei. (2004). Antioxidant activity of a flavonoid-rich extract of *Hypericum perforatum* L. *in vitro*. *J Agric Food Chem* 52: 5032–5039.



# 2

## *How and Why These Compounds Are Synthesized by Plants*

Leland J. Cseke, Casey R. Lu, Ari Kornfeld, Peter B. Kaufman, and Ara Kirakosyan

### CONTENTS

2.1	Introduction .....	52
2.2	Primary Metabolic Pathways in Plants .....	52
2.3	Generalized View of a Plant Cell and Its Subcellular Compartments .....	54
2.4	How and Where Some of the Well-Known Plant Metabolites Are Synthesized in Plant Cells .....	58
2.4.1	Lipids, Proteins, and Nucleotides .....	58
2.4.2	Cellulose and Cellulose Biosynthesis .....	61
2.4.3	Lignin and Lignin Biosynthesis .....	63
2.4.4	Biogenic Silica and Silicification .....	63
2.4.5	Starch and Starch Biosynthesis .....	66
2.4.6	Fructans and Fructan Biosynthesis .....	68
2.4.7	Gum, Mucilage, and Dietary Fiber .....	70
2.4.8	Chlorophyll and Chlorophyll Biosynthesis .....	70
2.4.9	Carotenoids and Carotenoid Biosynthesis .....	73
2.4.10	Anthocyanins and Anthocyanin Biosynthesis .....	76
2.4.11	Alkaloids and Alkaloid Biosynthesis .....	78
2.5	Synthesis of Plant Metabolites in Specialized Structures or Tissues .....	81
2.5.1	Synthesis of Monoterpenes in the Leaves of Peppermint ( <i>Mentha piperita</i> ) .....	81
2.5.2	Synthesis of Monoterpenes in the Petals of Flowers .....	81
2.5.3	Synthesis of Oleoresin Terpenes in Conifers .....	85
2.5.4	Synthesis of Polyketides in Multicellular Cavities of <i>Hypericum perforatum</i> .....	86
2.5.5	Secretion of Sodium and Potassium Chloride from Salt Glands of Plants That Grow in Saline Environments (Halophytes) .....	89
2.6	Adaptive Functions of Metabolites in Plants .....	89
2.6.1	Sources of Metabolic Energy and Energy Transfer .....	89
2.6.2	Cellular Building Blocks and Structural Support .....	90
2.6.3	Sources of Genetic Information .....	90
2.6.4	Catalysts of Metabolic Reactions .....	91
2.6.5	Deterrence of Predators and Pathogens via Poisons and Venoms .....	91
2.6.6	Attraction and Deterrence of Pollinators .....	93
2.6.7	Allelopathic Action .....	95
2.6.8	Attraction of Symbionts .....	96
2.6.9	Food for Pollinators, Symbionts, Herbivores, Pathogens, and Decomposers .....	97
2.7	Conclusions .....	97
	References .....	98

---

## 2.1 Introduction

In Chapter 1, we presented a compilation of the many types of chemical compounds that plants produce. Now the question arises: How do plants synthesize these compounds, and why do plants synthesize such a vast array of compounds? These are the primary topics of this chapter, and in the process of exploring the answers, we hope to shed some light on the factors that drive the evolution of the biosynthetic pathways that produce these compounds. For example, the simple fact that plants have roots results in very different selective pressures than those driving the evolution of animal metabolism. After all, very few plants have the ability to run away when another organism sees them as food. Consequently, plants have evolved ways to repel or, in some cases, attract other organisms. Their lack of movement also allows them to produce rigid compounds (such as cellulose or lignin) that, among other things, allow them to grow upward into new environmental niches.

To make such compounds as sugars, waxes, lignin, starch, pigments, or alkaloids, plants utilize specific enzymes, each of which catalyzes a specific metabolic reaction. **Enzymes** are proteins that act as **organic catalysts**. They are coded by specific genes in the plant's DNA and are made via processes we call transcription (conversion of DNA to RNA via the enzyme RNA polymerase) and translation (conversion of RNA to protein via the enzymatic action in complex structures called **ribosomes**). When there is a series of enzymatically catalyzed reactions in a well-defined sequence of steps, we have what is termed a **metabolic pathway**. Some enzymes may be involved in metabolic pathways requiring just a few enzymatic steps (as in synthesis of starch from the sugar nucleotide, **adenosine diphosphate [ADP]-glucose**) or many enzymatic steps (as in the synthesis of **gibberellin** hormones from **mevalonic acid**). Some enzymes may be involved in pathways that break down compounds (as in the hydrolysis of starch to sugars by  $\alpha$ - and  $\beta$ -amylases). Still other enzymes may be involved in making storage forms of given compounds, such as glucosides, amides, or esters of the plant hormone **indole-3-acetic acid (IAA)**. These different enzymatic pathways involved in the synthesis, breakdown, and creation of storage forms of a compound regulate the level of the given compound. The regulation of each pathway and of each of its enzymes is, however, extremely complicated. More will be said about this and other modes of regulation of enzyme activities in particular metabolic pathways in Chapter 3. Please note that not all proteins are enzymes. Many proteins within a given cell may be purely structural in function.

In the sections that follow, we aim to give the reader an understanding of the primary biosynthetic pathways that are known to occur in plants. We then give an overview of what is known about some of the best-known plant compounds and how they function within the plant. It should be noted, however, that there is a vast amount of information on these subjects, and new discoveries continue to be made.

---

## 2.2 Primary Metabolic Pathways in Plants

To make some sense out of the various “highways and byways” of plant metabolism, we put together the scheme shown in Figure 2.1. It depicts the interrelationships between the major metabolic pathways that occur in plants. Similar schemes were produced for the major pathways for mammalian and microbial metabolism. Some pathways are unique to plants, such as the **carbon reduction cycle** in photosynthesis and the **shikimic acid pathway** that produces, among other things, essential amino acids (like tryptophan) that animals cannot live without. These aromatic amino acids are also required for the production of many plant-specific nitrogen-containing and phenolic compounds. Microbes and mammals also have their own unique pathways, such as those involved in steroid hormone production, but common to plants, microbes, and mammals are the **pentose phosphate pathway**, **glycolysis**, and the **tricarboxylic acid (TCA) cycle** that are concerned with aerobic respiration and **adenosine triphosphate (ATP)** biosynthesis — the key energy molecule of the cell.

The scheme shown in Figure 2.1 for plant metabolic pathways will be an essential reference when we discuss individual metabolic pathways and sites where they are known to occur in plant cells. This scheme does not indicate where these pathways occur in plant cells; that will be covered in the next section. It also does not show the individual enzymatic steps that occur in each of the pathways shown.

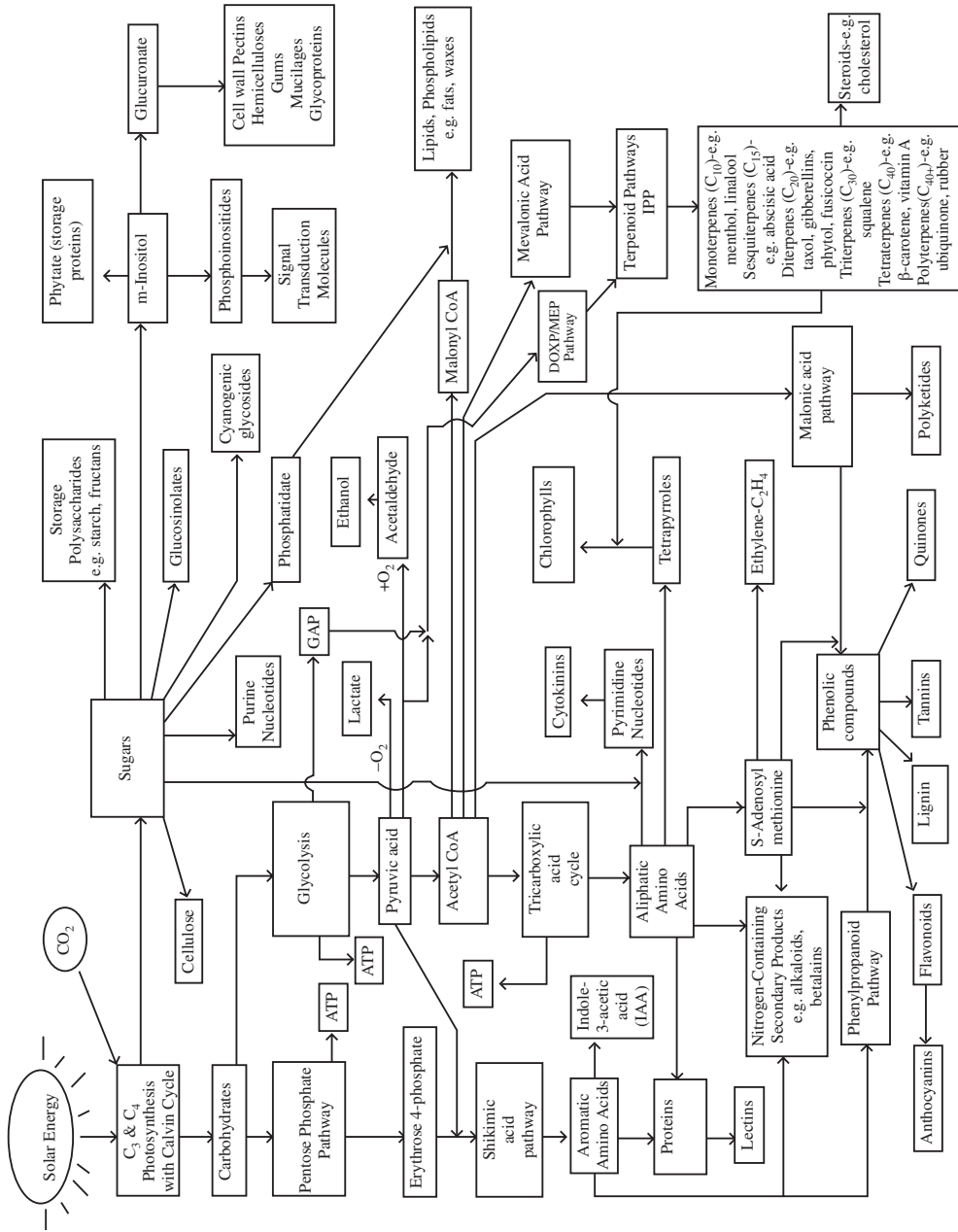

FIGURE 2.1 Primary metabolic pathways in plants.

What it does show, however, are (1) the major kinds of metabolites produced by plants (most are indicated around the right and bottom fringes of this scheme); (2) the interrelationships among each of the major metabolic pathways; and (3) the molecule, carbon dioxide, which when fixed in photosynthesis leads to the formation of all the other kinds of molecules shown in the diagram. We tried to show that the larger categories of all plant products are few in number. The majority of all essential products are made from sugars, acetyl CoA (coenzyme A), or amino acids (which make up all the proteins in the plant, including the all-important enzymes involved in each biochemical pathway). The same holds for products having somewhat less of an impact on the growth and development of the plant. These are generally considered to fall into three categories — terpenoids, nitrogen-containing compounds, and phenolic compounds. Some of these compounds require the addition of some soil nutrients, such as nitrogen or sulfur, and many are the building blocks for higher organisms, and thus, are absolutely necessary for life on this planet. Therefore, the fact that plants can utilize the energy of the sun to convert carbon dioxide into more complex compounds is the primary factor that makes plants so essential and so interesting.

It is important to note a major change that was made in Figure 2.1 from the first edition of this book. This change refers to how terpenoids are synthesized in plant and microbial cells. The main precursor molecule that leads to synthesis of terpenoids is **IPP, isopentenyl diphosphate** (see Chapter 1 for details). There are two pathways that lead to the synthesis of IPP (see Figure 24.6 on p. 1257 in Buchanan et al., 2000): (1) in the **cytosol**, IPP is formed from pyruvic acid via acetyl-CoA and mevalonic acid, whereas (2) in **plastids**, it is synthesized from pyruvic acid and glyceraldehyde-3-phosphate (GAP) via 1-deoxy-D-xylulose-5-phosphate (DOXP) and 2-C-methyl-D-erythritol-4-phosphate (MEP) (Eisenreich et al., 1998, 2004; Hampel et al., 2005). This more recent evidence is based on feeding cell fractions with glucose radioactively labeled at the C-1 position, then tracing the labeled carbons in the products that are subsequently formed. The C-1 and C-5 positions of IPP are labeled in the plastid DOXP/MEP pathway, whereas C-2, C-4, and C-5 positions of IPP are labeled in the cytosolic acetate/mevalonate pathway. Thus, some of the terpenoid classes shown in Figure 2.1 are actually derived from quite different pathways.

Such examples bring up an important point about the study of plant natural products: None of us understands the full complexity of the pathways behind what plants can produce. For example, despite the fact that the green pigments of plants are perhaps the longest-studied class of compounds in the history of society, it was only very recently that the genes controlling chlorophyll biosynthesis were fully characterized in any plant (Beale, 2005). As new discoveries are made, our understanding of the biosynthesis of plant products changes. This is especially true in the new fields of genomics, proteomics, and metabolomics, where many thousands of genes and gene products can be studied simultaneously (see Chapter 6).

---

### 2.3 Generalized View of a Plant Cell and Its Subcellular Compartments

Before considering individual compartments within plant cells where plant metabolites are synthesized and stored, we must first examine how a typical plant cell is organized, and how its various components are related to one another (Dey and Harborne, 1997). For this purpose, we will refer to the cell illustrated in Figure 2.2 and the images shown in Figure 2.3 through Figure 2.7. The “jacket” that encloses this cell is the **cell wall**. It is composed of cellulose and other polysaccharides, as well as lignin, forming a rigid structure that both shapes the cell and protects it from the environment. The cell wall is the primary site for polymerization of amorphous silica gel in plants that accumulate this polymer. Just inside the cell wall is the **plasma membrane** that surrounds the organelles, cytosol, and nucleus. Plant organelles include chloroplasts, other plastids, mitochondria, endoplasmic reticulum, Golgi bodies (also called dictyosomes), microbodies such as peroxysomes and glyoxysomes, vacuoles, and ribosomes. The cytosol is the aqueous portion of the cell that contains (1) the majority of the ribosomes involved in protein synthesis (the other main location of ribosomes is on the endoplasmic reticulum); (2) microtubules and microfilaments that provide a physical skeleton for the cell and also act in cellular trafficking of proteins and organelles; and (3) all the water-soluble substances of the cell not found within membrane-bound organelles or within membranes. The nucleus is the information center of the cell. It is surrounded by a double membrane

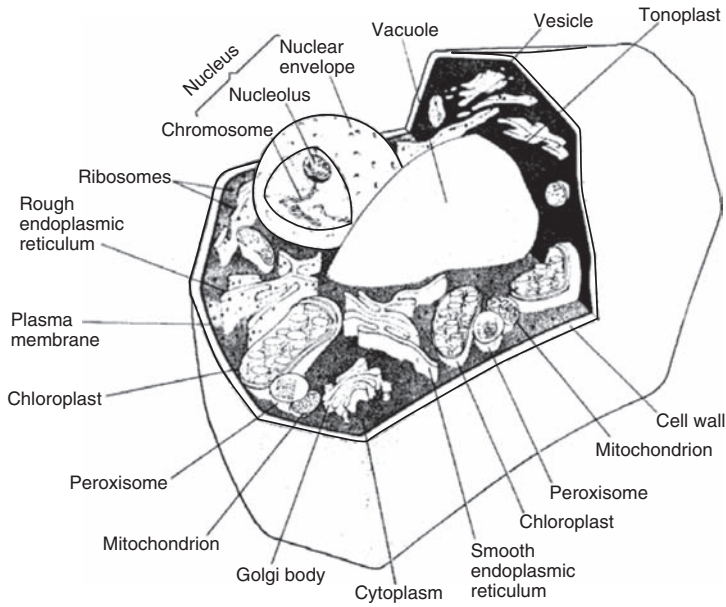

FIGURE 2.2 A plant cell and its constituent organelles.

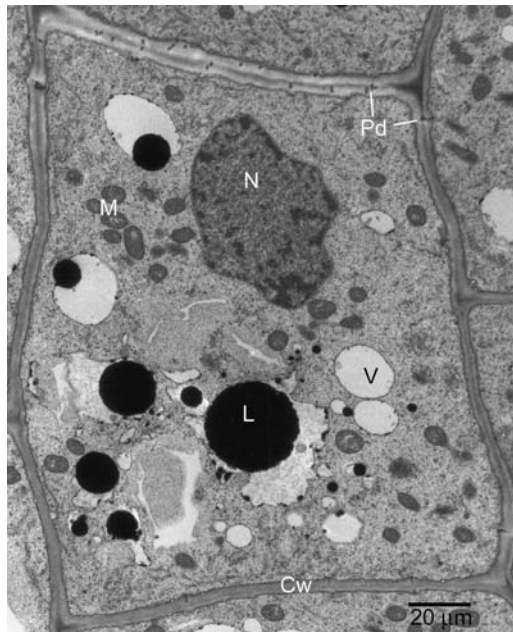
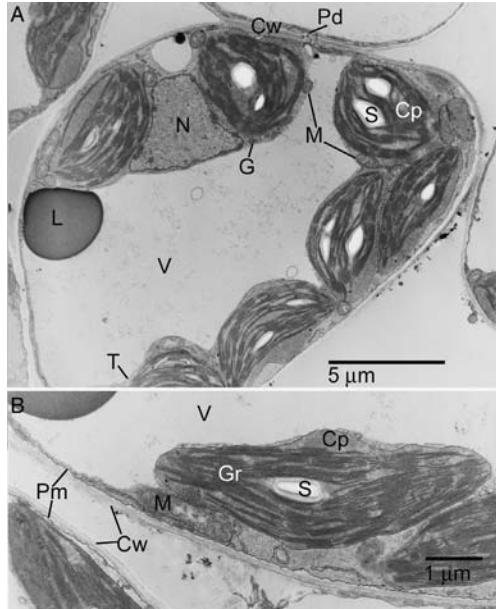

FIGURE 2.3 Transmission electron micrograph of a plant cell from the root of a germinating peanut (*Arachis hypogaea*) seed. Cells in this early stage of development are filled with cytosol, organelles, and a nucleus. The central vacuole has not yet developed. The identified structures are as follows: N, nucleus; M, mitochondrion; Pd, plasmodesmata; L, lipid droplet; V, vacuole; and Cw, cell wall.

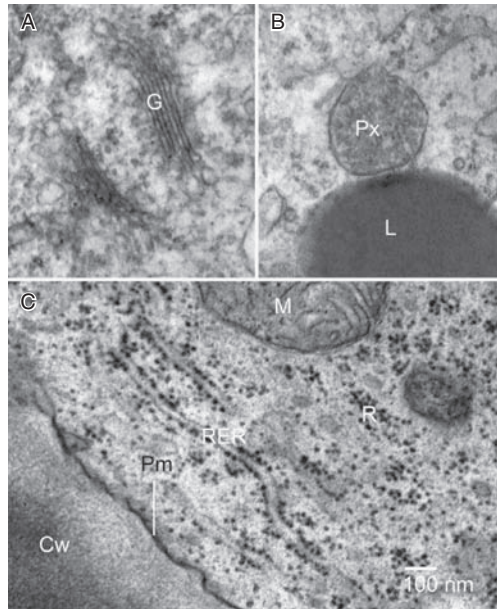



**FIGURE 2.4** Transmission electron micrographs showing a mesophyll cell from a leaf of *Hypericum perforatum* (St. John's wort) derived from *in vitro* shoot cultures (A), and a close-up of chloroplasts and associated structures (B). Mesophyll cells are dominated by a central vacuole. All other organelles are squeezed against the cell wall between the plasma membrane and the vacuole's tonoplast membrane. The identified structures are as follows: N, nucleus; M, mitochondria; Pd, plasmodesmata; L, lipid droplet; V, vacuole; T, tonoplast; Cp, chloroplast; Pm, plasma membrane; Cw, cell wall; S, starch grain; Gr, granna; and G, Golgi body.



**FIGURE 2.5** Transmission electron micrograph of guard cells and stoma from a leaf of *Hypericum perforatum* (St. John's wort) derived from *in vitro* shoot cultures. Guard cells, which regulate the plant's access to air for photosynthesis and respiration, are among the most active cells in a mature plant. This fact is reflected in the abundance of mitochondria and stored fuel, such as starch and lipids, seen inside the cells. The identified structures are as follows: N, nucleus; Nu, nucleolus; M, mitochondria; Cp, chloroplast; V, vacuole; Pm, plasma membrane; Cw, cell wall; S, starch grain; L, lipid droplet; Px, peroxisome; and St, stoma.



**FIGURE 2.6** Transmission electron micrographs of (A) Golgi bodies and (B) peroxysome from a leaf of *Hypericum perforatum* (St. John's wort) derived from *in vitro* shoot cultures. (C) Rough endoplasmic reticulum from *Arachis hypogaea*, peanut root cell. The identified structures are as follows: G, Golgi body; Px, peroxysome; L, lipid; M, mitochondrion; RER, rough endoplasmic reticulum; R, free ribosomes; Pm, plasma membrane; and Cw, cell wall.

and contains the genetic material (DNA) needed to create proteins within the cell. Within the nucleus of each cell is the information needed to create the entire organism. Figure 2.3, Figure 2.4A, and Figure 2.5 show various plant cells as imaged by a transmission electron microscope (TEM).

Each kind of organelle has many biochemical functions, but the generally accepted function of each major class of organelles is as follows: The **chloroplasts** (Figure 2.4B) of a plant cell are organelles bound by a double membrane. Chlorophyll and proteins bound to the stacked thylakoids (grana) use the energy in light to build simple sugars from  $\text{CO}_2$  and water in the stroma via a process known as **photosynthesis**. Excess sugar may be converted to starch in order to store the energy for later use. There are, however, other types of plastids, such as those found in the petals of flowers and in roots (chromoplasts or leucoplasts), that do not contain the “machinery” to carry out photosynthesis, yet still act as locations for the production of many plant products (Figure 2.7). **Mitochondria**, also surrounded by a double membrane (Figure 2.3, Figure 2.4, Figure 2.5, and Figure 2.6), are sites of the TCA (tricarboxylic acid) cycle, the electron transport chain, and oxidative phosphorylation, all of which are central to the production of ATP (adenosine triphosphate). The **endoplasmic reticulum** (ER) (Figure 2.6C) is a system of membrane-bound tubes and flattened sacs that spread throughout the cell and work in conjunction with **Golgi bodies** (dictyosomes) (Figure 2.6A) to produce and secrete various compounds as well as to deliver specific proteins and membrane lipids to their proper locations within the cell. **Microbodies**, such as **peroxysomes** (Figure 2.6B) play a very important role in detoxifying peroxides, a necessary product of other metabolic pathways that would otherwise kill the cell. Peroxysomes are also involved in the photorespiration pathway. **Glyoxysomes**, another type of microbody, are found only in the early stages of plant development in oil-storing seeds. They contain the enzymes necessary for the conversion of lipids to carbohydrates during seed germination, where photosynthesis is not yet possible. **Microtubules** (composed of tubulin), **intermediate filaments** (composed of keratin in animal systems), and **microfilaments** (composed of actin filaments) make up the cytoskeleton, which forms an internal scaffolding for organelle placement. Figure 2.7 shows a cell undergoing division, with microtubules present. Microtubules are involved in chromosome movement into daughter cells and provide a “railroad track” for delivery of new cell-wall materials to the developing cell plate. The **vacuole** is a liquid-filled compartment in the plant cell enclosed by a single membrane known as the **tonoplast**. Vacuoles play a

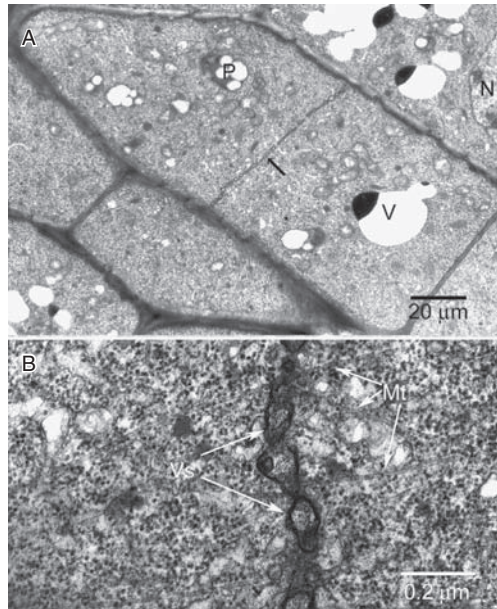

**FIGURE 2.7** Transmission electron micrographs of a soybean (*Glycine max*) root cell undergoing cell division (A). The newly forming cell plate (black arrow in top image) can be seen as well as vesicles bringing new cell-wall components to the cell plate via microtubules. The identified structures are as follows: V, vacuole; P, plastid; Vs, vesicle; and Mt, microtubule. The numerous black dots shown in Figure 2.7B are ribosomes.

wide variety of roles in cellular metabolism, acting as digestive chambers, storage chambers, or “waste bins,” and they play a very important role as a support structure. High solute concentration inside the vacuoles causes water to move into the vacuoles of each plant cell, through the process of osmosis, resulting in the buildup of pressure, called **turgor**. This pressure allows non-woody plants to remain standing against the force of gravity. Without an adequate supply of water, a plant will wilt.

Remember that what you see in Figure 2.2 through Figure 2.7 represents only a static view of the cell at only one point in time. Most of the cell’s contents are in a continuous state of motion (**cyclosis** or cytoplasmic streaming and **Brownian movement**). So, each living cell of even the most solid looking of plants is actually a dynamic system of complex biochemical pathways within different cellular membrane and cell-wall systems, which, when linked together, not only result in the organisms that we see, but also define and regulate the interaction that the plant has with its environment. We will now discuss the individual components of a plant cell and some of the kinds of biosynthetic pathways known to occur in each structure.

## 2.4 How and Where Some of the Well-Known Plant Metabolites Are Synthesized in Plant Cells

### 2.4.1 Lipids, Proteins, and Nucleotides

All living organisms produce three major categories of compounds: (1) **lipids** that make up the plasma membrane and the membranes of all internal compartments and organelles; (2) **proteins** that make up structural units of the cell, such as microtubules, and all the enzymes of every biochemical process; and (3) **nucleic acids** and **nucleotides** that code for all proteins, act as metabolic energy molecules such as ATP and biochemical regulators such as GTP or cAMP, and in some cases, work in conjunction with proteins to produce specific activities. **Ribosomes**, for example, consist of both protein and RNA, the combination of which allows for the production of all other proteins. Because all organisms produce



TABLE 2.1

Some Long-Chain Saturated Acids and Alcohols Found Free or Esterified in Plant Waxes

Number of Carbons	Acid	Alcohol
24	Lignoceric acid	Lignoceryl ( <i>n</i> -tetrocosanol)
26	Cerotic acid	Ceryl ( <i>n</i> -hexacosanol)
28	Montanic acid	Octacosyl ( <i>n</i> -octacosanol)
30	Melissic acid	<i>n</i> -Myricyl ( <i>n</i> -triacontanol)
32	Lacceroic acid	<i>n</i> -Lacceryl ( <i>n</i> -dotriacontanol)
34	<i>n</i> -Tetratriacontanoic acid	Tetratriacontyl ( <i>n</i> -tetratriacontanol)

TABLE 2.2

Some Common Components of Plant Cuticular Waxes

Compound Type	Structural Formula	Usual Range of Chain Lengths
<i>n</i> -Alkanes	$\text{CH}_3(\text{CH}_2)_n\text{CH}_3$	$\text{C}^{25}\text{--}\text{C}^{35}$
Iso-alkanes	$\begin{array}{c} \text{CH}_3 \\   \\ \text{CH}_3\text{CH}(\text{CH}_2)_n\text{CH}_3 \end{array}$	$\text{C}^{25}\text{--}\text{C}^{35}$
Alkenes	$\text{CH}_3(\text{CH}_2)_n\text{CH}=\text{CH}(\text{CH}_2)_m\text{CH}_3$	$\text{C}^{17}\text{--}\text{C}^{33}$
Monoketones	$\begin{array}{c} \text{O} \\    \\ \text{CH}_3(\text{CH}_2)_n\text{C}(\text{CH}_2)_m\text{CH}_3 \end{array}$	$\text{C}^{24}\text{--}\text{C}^{33}$
$\beta$ -Diketones	$\begin{array}{c} \text{O} \quad \text{O} \\    \quad    \\ \text{CH}_3(\text{CH}_2)_n\text{CCH}_2\text{C}(\text{CH}_2)_m\text{CH}_3 \end{array}$	$\text{C}^{31}\text{--}\text{C}^{31}$
Secondary alcohols	$\begin{array}{c} \text{OH} \\   \\ \text{CH}_3(\text{CH}_2)_n\text{CH}(\text{CH}_2)_m\text{CH}_3 \end{array}$	$\text{C}^{20}\text{--}\text{C}^{33}$
Wax esters	$\begin{array}{c} \text{O} \\    \\ \text{CH}_3(\text{CH}_2)_n\text{C}-\text{O}(\text{CH}_2)_m\text{CH}_3 \end{array}$	$\text{C}^{30}\text{--}\text{C}^{60}$
Primary alcohols	$\text{CH}_3(\text{CH}_2)_n\text{CH}_2\text{OH}$	$\text{C}^{12}\text{--}\text{C}^{36}$
Normal fatty acids	$\begin{array}{c} \text{O} \\    \\ \text{CH}_3(\text{CH}_2)_n\text{COH} \end{array}$	$\text{C}^{12}\text{--}\text{C}^{36}$
$\omega$ -hydroxy acids	$\begin{array}{c} \text{OH} \quad \text{O} \\   \quad    \\ \text{CH}_2(\text{CH}_2)_n\text{COH} \end{array}$	$\text{C}^{10}\text{--}\text{C}^{34}$

very important storage forms of lipids (fats and oils) as energy reserves in fruits and seeds, such as the fats and oils found in avocados, olives, soybeans, sunflower seeds, and peanuts. In some cases, these reserves may also serve as rewards for animals that disperse the plant's seeds. These stored lipids are often found in the cytoplasm of either cotyledon or endosperm cells in organelles known as spherosomes (also called lipid bodies), which, like vesicles, bud off of the ER.

The production of proteins is completely dependent on the presence of the amino acids from which they are made as well as nucleotides, because every protein is coded by nucleic acids (DNA and RNA) made from nucleotides (see Chapter 1 for more details). In eukaryotic cells, most proteins are initially produced in the cytosol and then transported to their final destinations in the cells where they will perform their specific functions. Organelles, such as chloroplasts and mitochondria, can also make proteins specific to these organelles. We mentioned that proteins may be enzymatic or structural in function, but plants produce storage forms of proteins, like **phytate**, to provide a reserve of amino acids and energy, especially in the process of seed germination. Some of these storage proteins can be **lectins**, which are highly toxic and serve as herbivore deterrents (see Section 2.6.5 as well as Chapter 1), but their ability to bind sugars gives them function in recognition of symbionts, pathogens, and species-specific pollen grains as well.

The purine and pyrimidine nucleotides that allow the synthesis of nucleic acids (DNA or RNA) are made in the cytoplasm from sugars and aliphatic amino acids. Purine nucleotides are made from ribose-5-phosphate, a modified ribose sugar, while pyrimidine nucleotides also require glutamine. So, a nucleotide is simply one of several different nitrogen-containing ring compounds linked to a five-carbon sugar (either ribose or deoxyribose) that carries a phosphate group (see Chapter 1 for more details). Nucleotides are also salvaged within the cell from the degradation or breakdown of nucleic acids (usually RNA). Please remember that all biochemical processes are ultimately controlled by the timing of the expression of the genes encoded by DNA.

## 2.4.2 Cellulose and Cellulose Biosynthesis

**Cellulose** is the world's most common naturally synthesized polymer. It makes up the majority of all the biomass on the planet and is the primary component of all plant cell walls (Figure 2.9). This homopolymer is made from the glucose molecules produced by photosynthesis and is organized as glucan chains of  $\beta$ -1,4-linked glucose units in which every other glucose unit is rotated  $180^\circ$  with respect to its neighbor (Delmer and Amor, 1995; Dey and Harborne, 1997). The glucan chains in primary walls of growing plant cells aggregate into fibers called **cellulose microfibrils**. In secondary walls, laid down after cell growth has ceased, the cellulose microfibrils are organized into macrofibrils or bundles (Delmer and Amor, 1995). Cells that expand more or less equally in all directions have cellulose microfibrils oriented in a random pattern; in contrast, cells that expand by elongation growth (e.g., fibers, pollen tubes, root hairs, and conducting cells of the vascular system) have cellulose microfibrils oriented parallel to each other, lying at right angles to the direction in which the cell elongates. These patterns of orientation of cellulose microfibrils help govern the specific function of a given cell and can be determined microscopically by the use of crossed polarizers and a red filter placed diagonally to the crossed polarizers.

The synthesis of cellulose occurs at the plasma membrane, which is located at the interface between the cell wall and the cytoplasm. The monomeric unit that donates glucose units to a growing cellulose chain is **UDPG (uridine diphosphate glucose)**. The glucose in UDPG comes from the hydrolysis of the disaccharide sugar, sucrose, catalyzed by the enzyme, **SuSy (sucrose phosphate synthase)**. An elegant hypothetical model of a cellulose synthase complex in the plasma membrane is provided in an excellent review article by Delmer (1999) on cellulose biosynthesis.

The cell wall in plants provides structural support for the plant. This structural support is provided not only by cellulose, but also, by other polymers, such as hemicellulose and pectic polysaccharides. Like cellulose, these are chains of sugars, but their many varieties differ from cellulose in the kinds of sugars present, how they are linked together, and how many branches they have in their chains. Hemicellulose and pectins are not made at the plasma membrane. Instead, they appear to be made in the secretory system of the ER and Golgi apparatus. They are then transported to the cell wall via vesicles. In woody plants, such as vines, trees, and shrubs, the cell walls become lignified through deposition of the polymer, **lignin** (see Section 2.4.3). Cellulose combined with lignin is the primary plant product involved in support and provides the physical structure that allows such plants as trees to grow very tall. In vascular plants, such as grasses, sedges, and scouring rushes (*Equisetum* spp.), as well as in diatoms (one type of algae), the cell walls become infiltrated with **amorphous silica gel** that, like lignin, provides structural support (see Section 2.4.4).

In epidermal cells of plant shoots, the cell walls can also become infiltrated and covered on their outer surfaces with a waxy lipid coating called the **cuticle**, made up of a polymer called **cuticular wax** or

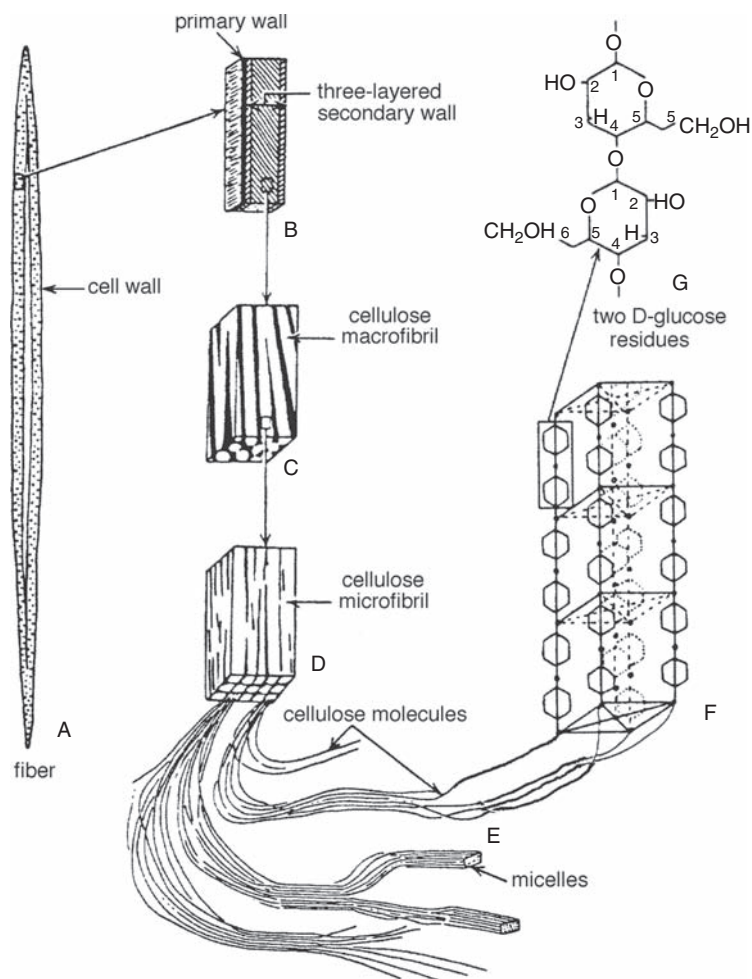

**FIGURE 2.9** (A) Interpretation of plant cell-wall structure in a fiber cell. (B) The structure of the primary wall. (C) A cellulose macrofibril. (D) A cellulose microfibril. (E) A crystalline micelle of cellulose. (F) The molecular architecture of repeating, ordered D-glucose units that make up cellulose. (G) Two D-glucose residues connected by  $\beta$ -1,4-glycosidic bonds. (Modified from Esau, K. (1965). *Plant Anatomy*. 2nd ed., John Wiley & Sons, New York.)

**cutin**, made and secreted by the ER of epidermal cells combined with a wide variety of saturated and unsaturated acids as well as many forms of alcohols (Table 2.1 and Table 2.2). This “waterproofing” of the surface of the shoot (leaves and stems, flowers, and fruits) prevents excess water loss from the plant and consequent desiccation. In some species, such as those living at high altitudes, the cuticle is very white, which helps reflect damaging ultraviolet (UV) light. Cellulose infiltrated with lignin or cuticular wax provides a physical barrier that greatly deters most potential herbivores because of the toughness of the polymers. In contrast, roots do not produce a cuticular wax layer on their outer surfaces, but they synthesize a wax known as **suberin** in an interior layer of cells called the **endodermis** that prevents leakage of ions and metabolites out of the vascular cylinder in the center of the root. Such differences in cuticular layers also provide researchers with a means to study the natural products released from the roots that control plant and soil interactions (see Chapter 4 for more details).

In commerce, cellulose is important in fabric made from cotton or other plant fibers, in softwood fibers (derived from conifers) that make up paper and cardboard, and in purified or modified forms as a matrix used in column and thin-layer chromatography to purify compounds such as plant pigments and enzymes (e.g., DEAE cellulose = diethylaminoethyl cellulose). Obviously, it is a major structural component of wood derived from trees used to make lumber. Figure 2.10 illustrates a cross-section of



**FIGURE 2.10** Peter Kaufman and Mike Messler examining a cut stump of a California redwood (*Sequoiadendron sempervirens*) tree that has wood (secondary xylem) that is made primarily of lignified cellulose. The diameter of this tree at the cut surface is about 5 m. (Photo courtesy of Casey Lu, Humboldt State University, Arcata, CA.)

the trunk of a coast redwood tree (*Sequoia sempervirens*) that has wood (secondary xylem tissue) that is mostly composed of cellulose but that is also lignified (see lignin and lignification discussed in the following section).

### 2.4.3 Lignin and Lignin Biosynthesis

**Lignin** is a complex polymer (Figure 2.11) that exists as a three-dimensional matrix around the polysaccharides of secondary cell walls found in plant fibers and in the tracheids and vessel elements of secondary xylem (wood). It is composed of varying amounts of the aromatic **phenylpropanoid subunits (monolignols)**, **p-coumaryl alcohol**, **coniferyl alcohol**, and **sinapyl alcohol** made via the **shikimic acid pathway** (Figure 2.1). These monolignols are usually synthesized from the amino acid L-phenylalanine, although tyrosine can also be used. Subsequent steps in the monolignol biosynthetic pathway are shown in Figure 2.12. These monolignols appear to be made in the ER and Golgi bodies, but the polymerization of lignin occurs outside the plasma membrane.

Lignin makes up to 35% of the dry weight of woody tissue (Hopkins and Hüner, 2004) and it acts to provide additional rigidity and compressive strength to cell walls. Because lignin is hydrophobic, it also makes cell walls that become lignified impermeable to water (Whetten and Sederoff, 1995). In plants, there are simple histochemical tests available for testing for the presence of lignin in cell walls. They basically involve the use of phloroglucinol/HCl or para-rosaniline HCl. In either case, the cell walls stain deep reddish brown in color. We used these reactions to demonstrate that, in cereal grasses, bundles of fibers associated with vascular bundles show excellent lignin staining in mature stems and leaf sheaths that make up stiff straw. In contrast, it is totally absent in strands of fiber-like collenchyma cells associated with vascular bundles in the swollen leaf sheath bases (**leaf sheath pulvini**) of cereal grass shoots that are sites for upward bending (**negative gravitropic curvature**) of lodged shoots prostrated by the action of wind, torrential rain, or hail (Kaufman et al., 1995). So, while lignin may provide support, help prevent water loss, and even resist herbivores, it is not a benefit to plant tissues that need to grow or to bend.

### 2.4.4 Biogenic Silica and Silicification

Some plants have developed the ability to absorb inorganic constituents from their environment and use them for their benefit. **Biogenic silica** is a polymer of biological origin that is characteristically found in the cell walls of diatoms, scouring rushes (*Equisetum* spp.) or horsetails, grasses (all members of the Poaceae or grass family), members of the rush family (Juncaecae), and members of the sedge family (Cyperaceae). Silica found in these silica-accumulating plants originates from silicates found in soil minerals. It is taken up as **monosilicic acid, Si(OH)<sub>4</sub>**, via the roots (or cell membrane in the case of the single-cell diatoms), from which it moves up the plant in the xylem-conducting elements. This upward movement of monosilicic acid with water and other mineral compounds occurs as a result of



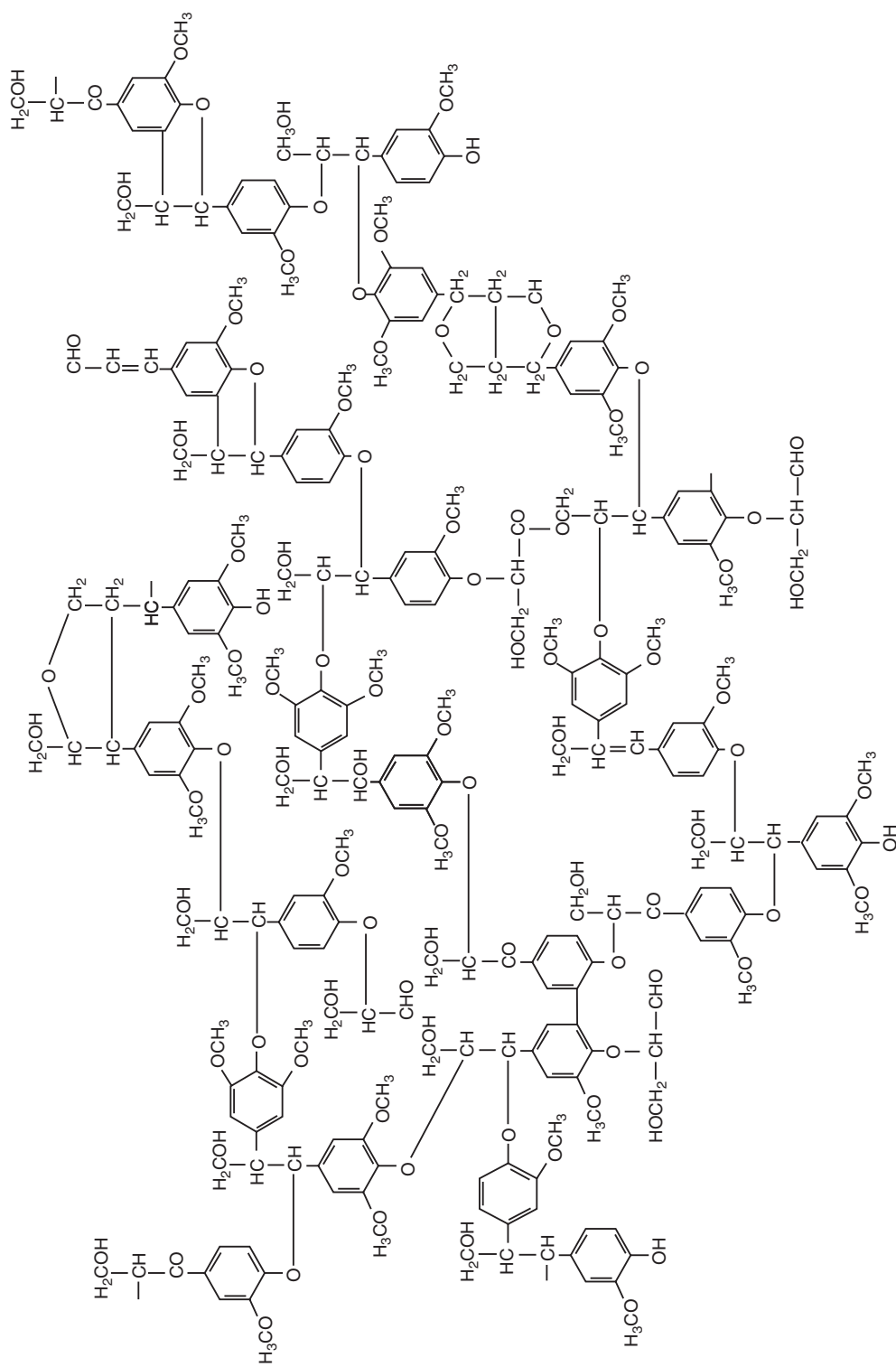

**FIGURE 2.11** Partial polymeric structure of a lignin molecule made up of phenylpropane (C<sub>6</sub>-C<sub>3</sub>) monolignol alcohol units (see Figure 2.12).

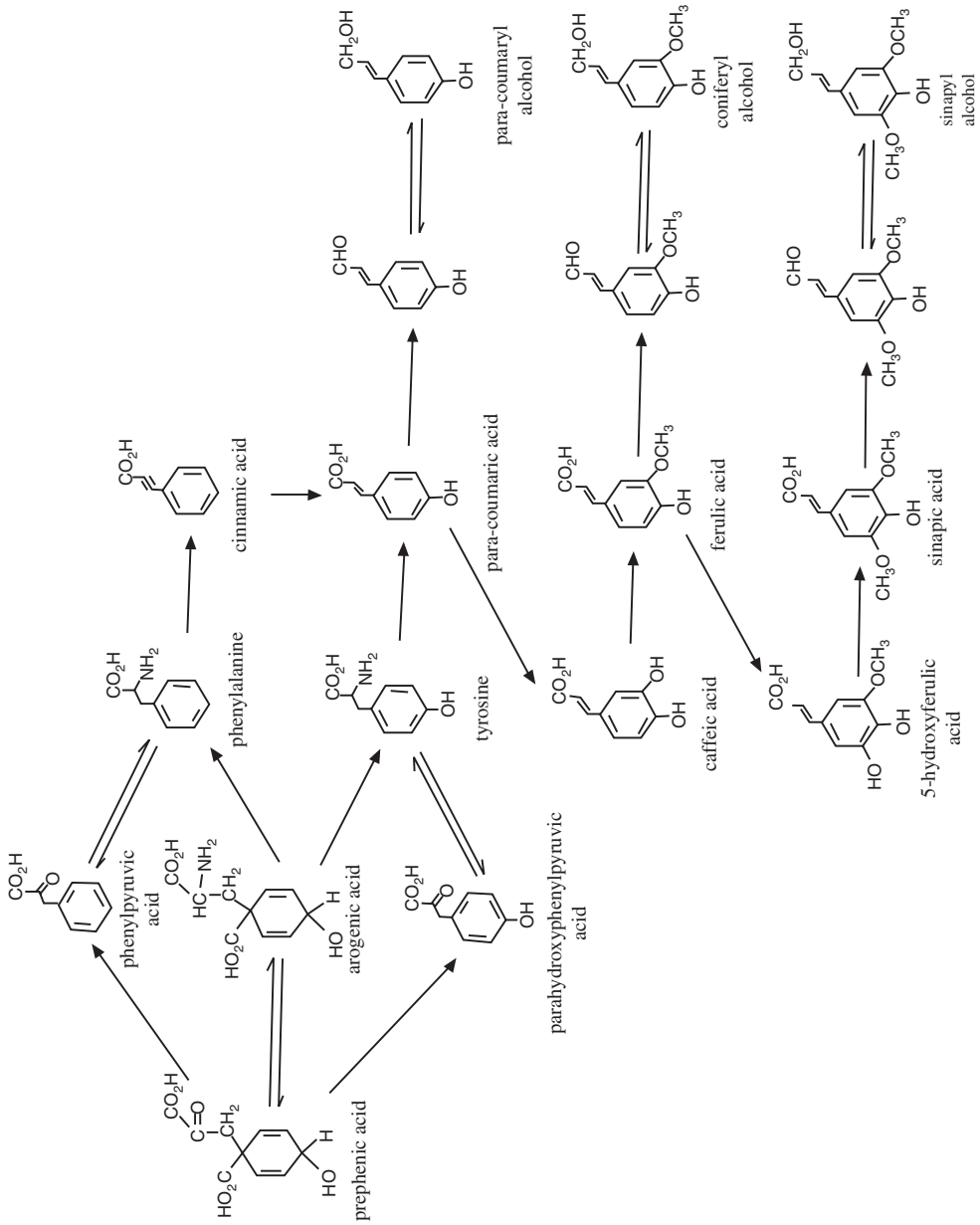

FIGURE 2.12 The biosynthesis of monolignols, *p*-coumaryl alcohol, coniferyl alcohol, and sinapyl alcohol.

“**transpirational pull**” mediated by transpirational loss of water from stomates (pores) located in the epidermal tissues of leaves and stems. Once monosilicic acid arrives in stems and leaves where transpiration is occurring, it irreversibly polymerizes as **amorphous silica gel**,  $\text{SiO}_2 \cdot n\text{H}_2\text{O}$ , mostly in cell walls, that are hydrogen bonded to cellulose molecules. However, in grasses, within specialized silica cells located in the epidermis of leaves and floral bracts, it can also polymerize directly in the cytoplasm after breakdown of all cell organelles has occurred (Kaufman et al., 1983). Silica can also be deposited in specialized structures, such as the hairs (trichomes) on leaves of grasses.

The annual scouring rush, *Equisetum arvense*, can produce up to 20% of its dry weight as silica. A classical experiment done at the California Institute of Technology (Kaufman et al., 1983) showed that these plants, grown in silicon-free hydroponic nutrient solutions became very weak and appeared collapsed. Adding silicon as **sodium metasilicate** to the hydroponic nutrient solution at only 80 ppm yielded plants with shoots that were upright and appeared strong and robust. This indicated that silica provided direct support for the shoot and, hence, is considered an essential element for normal growth and development in these types of plants. So, the primary role of silica in the cell wall is to provide support to the shoot in addition to that provided by cellulose and lignin. Aside from providing support to shoots of grasses, sedges, rushes, and *Equisetum* spp., amorphous silica gel that gets deposited in outer cell walls of the epidermal tissue of leaves and stems forms very hard and often very sharp tissue that can deter attack by predacious animals, insects, and disease-causing fungi. In fact, the mouth parts of many insects that attack rice plants (e.g., green and brown leaf hoppers that transmit tungro virus pathogens) get worn down and rendered ineffective in piercing the leaves of the rice plants. Likewise, the teeth of sheep get worn down significantly by eating pasture grasses with high silica content. Fortunately, these animals can replace their worn-down teeth with new teeth.

It should also be noted that silicon (mostly as  $\text{Si}(\text{OH})_4$  or monosilicic acid) is not the only inorganic constituent that plant roots can absorb. Marine algae can absorb calcium in the form of **calcium carbonate**, which they deposit on their surfaces as crusty support compounds, much like biogenic silica, which seems to prevent the plants from getting damaged by crashing waves. Some plants can absorb toxic elements, such as **selenium (Se)** or **bromine**, that help ward off herbivores. For example, *Astragalus* (loco weed) accumulates Se and incorporates it into certain amino acids and proteins. The plant can distinguish if a protein has Se, so there is no toxic effect to the plant. However, the animal metabolism cannot distinguish proteins that contain Se from those that do not, and the effect is toxic. The fact that Se is toxic to most other plants also allows *Astragalus* to avoid competition in soils that contain Se. These soils often occur around uranium deposits; so *Astragalus* has been used as an indicator species in botanical prospecting. Other plants, such as alpine penny-cress (*Thalspi caerulea*), will take up elements such as zinc and cadmium, making them very useful when planted in polluted areas needing **bioremediation** (see Chapter 4).

### 2.4.5 Starch and Starch Biosynthesis

Starch is the most common storage polysaccharide found in plants, and it serves as a primary food source for humans, domestic animals, birds, insects, and microbes. **Starch** is essentially comprised of monomers of sugars linked end to end in long chains through  $\alpha$ -1,4 linkages along the chain with  $\alpha$ -1,6 linkages as branch points. Martin and Smith (1995) and Dey and Harborne (1997) present excellent reviews of how starch is synthesized in plants. A scheme from their review article depicting amylopectin (branched chains of starch molecules with  $\alpha$ -1,4- and  $\alpha$ -1,6-linked glucan), starch granule formation, and the biosynthetic pathway for starch biosynthesis is shown in Figure 2.13. The other configuration of the starch molecule is that of **amylose**, which is unbranched. It is composed exclusively of  $\alpha$ -1,4-linked glucan. In rice grains, for example, varying amounts of **amylose** (straight-chain starch) and **amylopectin** (branched-chain starch) are found, depending on the cultivar. In sticky, short-grain rice (*Japonica* cultivars), amylopectin predominates. Such rice is better for soups and for eating with chopsticks. In non-sticky, long-grain rice (*Indica* cultivars), amylose starch predominates. Both forms of starch are made in the endo-sperm tissue of the seeds.

A large amount of free sugar in a cell will cause the cytosol to become thick and syrupy. This causes a hypertonic osmotic condition in the cell that will result in excessive water uptake and potential damage.

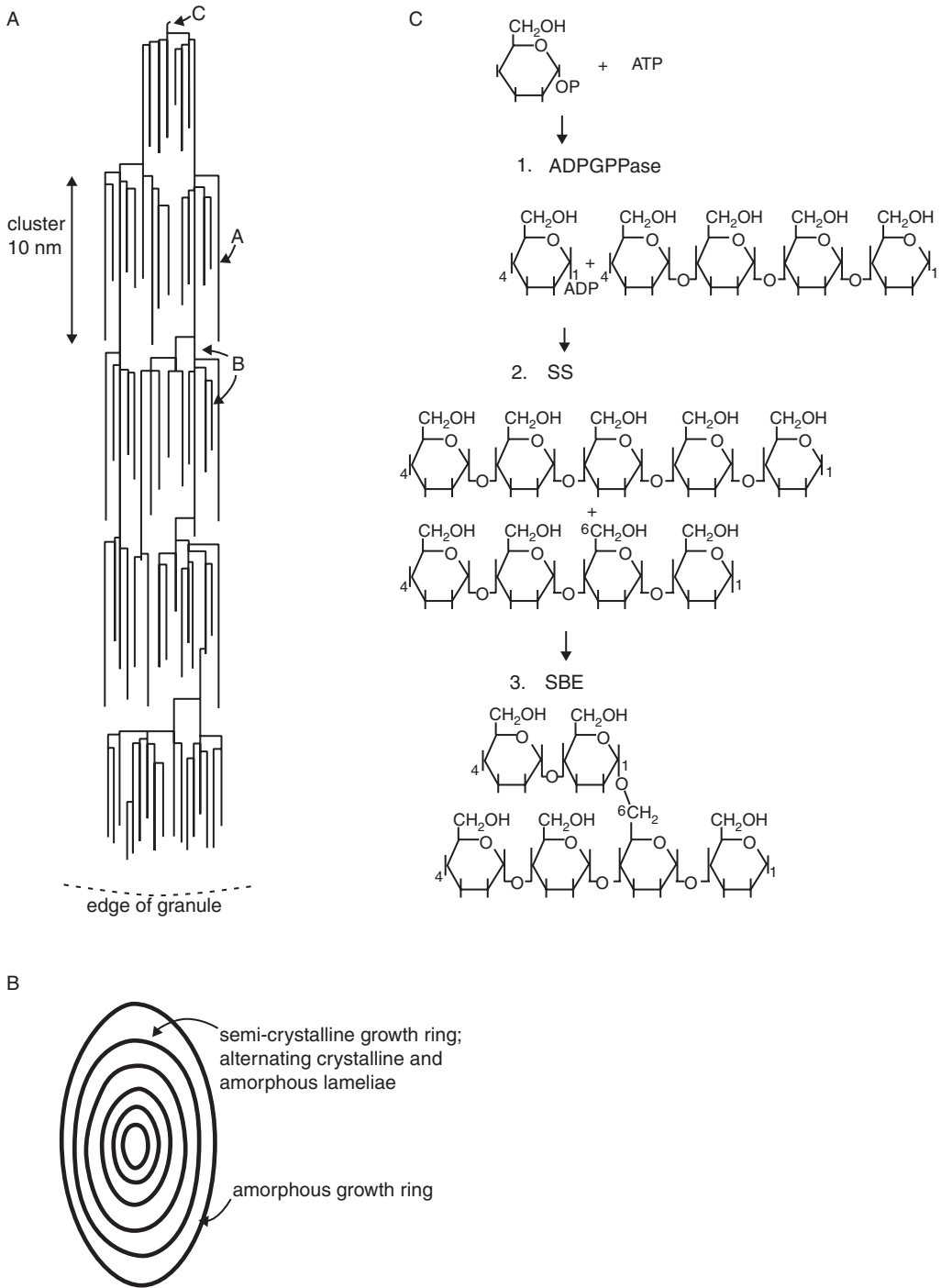

**FIGURE 2.13** (A) Amylopectin structure, (B) starch granule form, and (C) starch biosynthesis. 1. ADPGPPase — adenosine diphosphate glucose pyrophosphorylase; 2. SS — starch synthase; 3. SBE — starch branching enzyme. (From Martin, C. and A.M. Smith. (1995). *The Plant Cell* 7: 971–985. With permission.)

One of the primary benefits of producing starch is to make sugars osmotically inactive by making them insoluble within the cell. The starch produced by chloroplasts is, in most species, the primary storage form that is mobilized into sugars for translocation to other plant parts during night periods. It often aggregates into starch grains that typically occur as several granules lying between grana membrane stacks inside the chloroplasts (Figure 2.4). This starch can be hydrolyzed to D-glucose that can be used for ATP synthesis via aerobic respiration to maintain turgor pressure in growing cells via its osmotic effects and for synthesis of cellulose and other polysaccharides in the cell wall. Translocated sugars and starch are also important in the development of storage organs, such as the above rice grains.

Large quantities of starch can be found in storage organs, such as tubers and tuberous roots, taproots, stems located above ground, as well as seeds. These tissues are termed “**sinks**” by physiologists and agronomists. They allow the plant to survive on stored energy for long periods of winter or drought. In potatoes, under warm weather conditions, starch typically gets hydrolyzed to sugar used for growth of new shoots. Starch also occurs in the root caps located at the tips of growing roots in the soil. It is stored in specialized colorless plastids in root-cap cells called **amyloplasts**. The starch-filled amyloplasts are dense, heavy bodies that fall downward in the root-cap cells when a root is placed horizontally (gravistimulated). These serve as **gravisensors** that trigger signal transduction events that result in asymmetric growth of the root downward. Why is this so? It has been shown that if the root caps are removed from corn roots, the roots will not curve down when placed horizontally, and thus, will not grow into the soil where nutrients are located; when the root caps are replaced, gravisensitivity is restored. The gravitropic curvature response is much lower (Kaufman et al., 1995) in *Arabidopsis* mutants that have a lesion in starch biosynthesis that results in poorly formed, small starch grains in the amyloplasts. The starch grains in chloroplasts, as in amyloplasts of root caps, can serve as gravisensors in prostrated stems of plants. When this starch is depleted artificially, by placing the shoots in the dark for 4 to 5 d, the stems no longer respond to gravity; but, when fed sucrose, starch is resynthesized, and gravisensitivity is restored (Kaufman et al., 1995).

Humans eat starch in products such as potatoes, cereal grains, taro, and tapioca. It is also important in beer brewing as a modified barley substrate used in secondary fermentations. What happens here is that starch in barley is hydrolyzed to **maltose** (a **disaccharide**) and eventually to D-glucose. This hexose is used as a substrate (food) for beer fermenting yeast which, under anaerobic conditions, converts the sugar to ethyl alcohol (ca. 3.5 to 4.5%) and carbon dioxide. Starch is easily visualized in storage organs, such as potatoes, or in swollen joints (pulvini) of cereal grass stems by the use of a simple histochemical test. Fresh sections of plant tissue are placed in a 1% solution of **iodine-potassium iodide** (1:1), and the resulting stained starch grains appear blue-black in the light microscope (Figure 2.14).

#### 2.4.6 Fructans and Fructan Biosynthesis

**Fructans** are soluble storage polysaccharides found in the vacuoles of cells of plants known to be fructan accumulators. They are made predominantly from the sugar **fructose** (hence, the name), but glucose sugars may also be present in the chain. Classic examples include temperate-zone monocots, such as grasses, lilies, and irises, and dicots, such as dahlias and Jerusalem artichokes. A complete compilation of families of monocots and dicots in which fructans are known to occur is cited in Suzuki and Chatterton (1993). In dahlia and Jerusalem artichoke, the fructan is referred to as **inulin**, and here, the polysaccharide is composed mostly or exclusively of 2–1 fructosyl–fructose linkages (a glucose is allowed but not necessary). In the temperate-zone grasses, the fructan is termed either **graminan**, which has both 2–1 and 2–6 fructosyl–fructose linkages, or **phlein**, which contain mostly or exclusively 2–6 fructosyl–fructose linkages (Suzuki and Chatterton, 1993). As with inulin, glucose is allowed in the chain but is not necessary in the structure of graminan- and phlein-type fructans.

The basic pathway of synthesis of inulin-type fructans in plant cells was summarized by Edelman and Jefford (1968) and is discussed in detail in Dey and Harborne (1997). It involves the following three steps, as summarized by Suzuki and Chatterton (1993):

- Conversion of sucrose to trisaccharide in the cytosol by the enzyme **sucrose-sucrose fructosyl transferase (SST)**

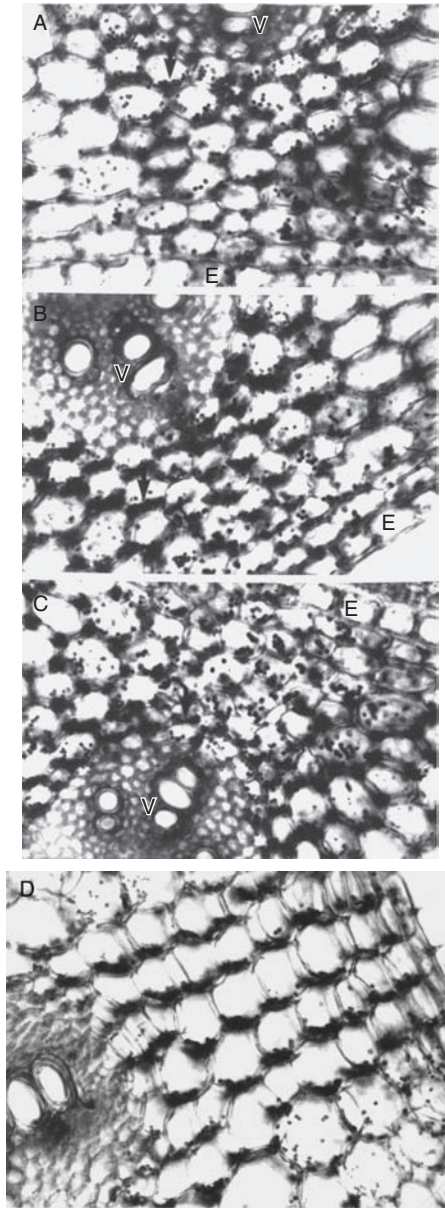

**FIGURE 2.14** Starch grains stained with I<sub>2</sub> KI in chloroplasts of oat (*Avena sativa*) cells located in the graviresponsive swollen leaf sheath pulvini of the shoot. Arrows indicate the direction of the gravity vector; E = epidermis; V = vascular bundle. Note that the starch-containing chloroplasts lie at the bottom of the cells after shoots of this oat plant were gravistimulated (placed horizontally). Normally, in upright (vertical) shoots, the starch-containing chloroplasts are scattered throughout the cytosol compartment of each cell where they occur. (Parts A, B, and C, original magnification  $\times 100$ ; part D, original magnification  $\times 200$ .) (Photo courtesy of Casey Lu and Peter Kaufman.)

- Transfer of the terminal fructosyl moiety of this trisaccharide in the cytosol to sucrose in the vacuole by the enzyme, **fructan:fructan fructosyl transferase (FFT)**, which is possibly located on the tonoplast membrane surrounding the vacuole
- Continued transfers by FFT of terminal fructosyl groups from the resulting molecules of **trisaccharide** (e.g., kestose or **isokestose**) in the vacuole to the extending fructan chain, resulting in the formation of inulin molecules

Fructan's primary role in plants is that of a reserve carbohydrate similar to starch. Temperate, cold-tolerant grasses like oats, barley, wheat, and rye typically contain fructans and sucrose as the primary carbohydrate reserves. Tropical, warm-loving, and cold-intolerant grasses, such as maize, contain starch and sucrose as the primary reserve carbohydrates. It is interesting that in the shoots of temperate-zone grasses and in the tubers of Jerusalem artichoke (*Helianthus tuberosus*), fructan synthesis accelerates under the low-temperature conditions of autumn. Then, the stored fructans become hydrolyzed through the action of **fructan hydrolase** in the spring, when temperatures warm and shoot and root growth begins. This appears to provide the plant with a source of energy for a head start on growth in the early spring.

Jerusalem artichoke tubers are frequently eaten by humans as a potato substitute (but not starch substitute). Humans cannot digest the inulin fructan present in these tubers because of the absence of the gene that makes the fructan-specific hydrolase in humans. Furthermore, the ubiquitous intestinal colon bacterium, *Escherichia coli*, cannot hydrolyze fructan. This would make one think that these tubers would be perfect food for dieters. However, there is recent evidence from Japanese studies that *Bifidobacteria*, found in intestinal microflora, can digest fructan; in fact, when fructans are eaten, populations of this microbe in the large intestine increase significantly. This being the case, enrichment of the human diet with fructans from plants such as rye (*Secale cereale*), onions (*Allium cepa*), Jerusalem artichoke tubers, and garlic (*Allium sativum*) may be beneficial, not because they are hydrolyzed in the small intestine, but because they are hydrolyzed in the large intestine. There is also evidence that fructans from plant sources may be beneficial in the diets of swine and poultry (see "Fructans in Human and Animal Diets" by Farnworth in Suzuki and Chatterton, 1993).

#### 2.4.7 Gum, Mucilage, and Dietary Fiber

Plants produce other forms of polysaccharides that include **gum** and **mucilage**. These are highly branched heteropolysaccharides (related to hemicellulose and pectic polysaccharides) that contain acidic residues, thus making them very hydrophobic, insoluble within the plant cell, and often difficult for animals to digest. One benefit to the plant that produces indigestible polymers is that it reduces the reward for herbivores. In other words, the animal spends its time eating, yet gets nothing out of the process. For the plant, these polysaccharides can function as a storage reserve for carbohydrates, but they are also found as part of the matrix that surrounds the cell walls of some cells. This matrix is called the **glycocalyx** and is mostly seen on the surfaces of roots, where it may serve to protect the plant against microbial invasion. Glycocalyx secretions are not unique to plants. They are also found in bacteria and in animals, where, as in plants, they act in cell-cell recognition of symbionts or pathogens. Another function of mucilage is seen in carnivorous plants like sundew (*Drosera rotundifolia*), where a substance called **mucin** is produced to catch unwary insects in nutrient-poor environments. Gums are also useful in the sealing of wounds in leaves and stems. For example, when a cherry tree is injured, it will produce a thick substance called **gum arabic** that fills in the wound, thus preventing infection. This also acts as a human cosmetic.

Cellulose, pectin, lignin, waxes, gums, and mucilages are some of the many types of **dietary fiber**. Fiber is simply the insoluble polymers of plants, and most come from cell walls. Fiber stimulates the gastrointestinal tract and acts as a laxative. Fiber-containing pectins reduce blood cholesterol by adsorbing cholesterol molecules. Fiber, in general, appears to inhibit many cancers, especially colon cancer, by binding the carcinogens and preventing them from entering the body while they pass through the system. One problem, however, is that fiber may also adsorb vitamins, thus carrying them out of the body before they can be absorbed. So, a balance of fiber in the diet is essential.

#### 2.4.8 Chlorophyll and Chlorophyll Biosynthesis

There are three main locations of pigments within the cell: (1) plastids, (2) vacuoles, and (3) cell walls. The chemistry of the pigments varies with the location. **Chlorophyll** is a porphyrin that constitutes the primary photoreceptor pigment for the process of photosynthesis in plants. It is produced in the chloroplasts and is responsible for the green appearance of leaves and stems, aerial and prop roots, many kinds of floral bracts, and green fruits before they ripen. The chlorophyll molecule is made up of four

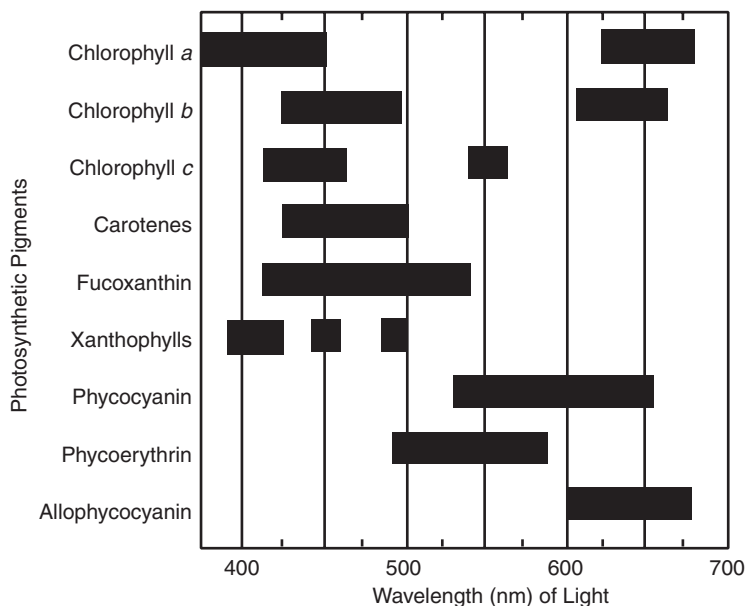

**FIGURE 2.15** Absorption of different wavelengths of light by various photosynthetic pigments in plants.

pyrrole rings, made from aliphatic amino acids (designated I to IV), that are ligated to form a **tetrapyrrole** ring with a magnesium atom in its center (see Section 1.3.1). Ring IV is esterified with a hydrophobic long-chain **phytol** molecule ( $C_{20}H_{39}$ ) made in the terpenoid pathway (von Wettstein et al., 1995; Smith and Witty, 2002). For light harvesting, plants use two forms of chlorophyll — *a* and *b*. Chlorophyll *a* is in all plants and is the only chlorophyll at the reaction centers. It has a methyl group at C3. Chlorophyll *b*, found in most plants, has a formyl group at this position and, like other accessory pigments, functions to absorb the energy from wavelengths of light that differ from chlorophyll *a* (Figure 2.15). The chemical structures of chlorophylls *a* and *b* are shown in Figure 2.16.

The biosynthesis of the chlorophylls is complex and has only recently been worked out in detail within the model plant angiosperm, *Arabidopsis thaliana* (Beale, 2005). It starts with the synthesis of L-glutamic acid 1-semialdehyde from L-glutamyl-tRNA through the action of the enzyme glutamyl-tRNA reductase. This is then converted to  $\delta$ -aminolevulinic acid through the enzymatic activity of glutamate 1-semialdehyde aminotransferase. These are critical steps, because the porphyrin ring containing conjugated double bonds is assembled in the chloroplast from eight molecules of  $\delta$ -aminolevulinic acid (see Figure 2.16). Subsequent steps lead to the formation of protochlorophyllide, insertion of a  $Mg^{2+}$  ion in the center of the tetrapyrrole ring, and addition of the phytol tail to form **chlorophyll *a*** and **chlorophyll *b***. These steps are illustrated in Figure 2.16, and the enzymes controlling each step are listed in Table 2.3 (Beale, 2005). Please note that it is not uncommon for each plant species to have more than one copy of a given gene, as illustrated in Table 2.3. The presence of such redundant genes is common in plants and provides the plants with backup copies of important genes if something should happen to one copy (see Chapter 3, Section 3.5.3 for an example focusing on MADS-box transcription factors). The reviews by von Wettstein et al. (1995), Dey and Harborne (1997), and Smith and Witty (2002) are also useful in understanding the biosynthesis of chlorophyll.

In the chloroplasts, the chlorophyll pigments are bound to proteins of the photosynthetic membranes. (Stacks of thylakoid membranes inside chloroplasts are called **grana** stacks.) These proteins, called chlorophyll *a/b* binding proteins, are arranged into large complexes with many other proteins, cytochromes, and quinones to form the photosynthetic electron-transport chain that, as its primary function, produces the ATP required to fix carbon dioxide. The pigment chlorophyll absorbs the energy of the sun and shuttles resulting free electrons to this all-important series of chemical events.

Chlorophyll absorbs photons of light energy from the sun or from artificial lamps (e.g., incandescent lamps, high-pressure lamps, light-emitting diodes) in the red and blue portions of the electromagnetic



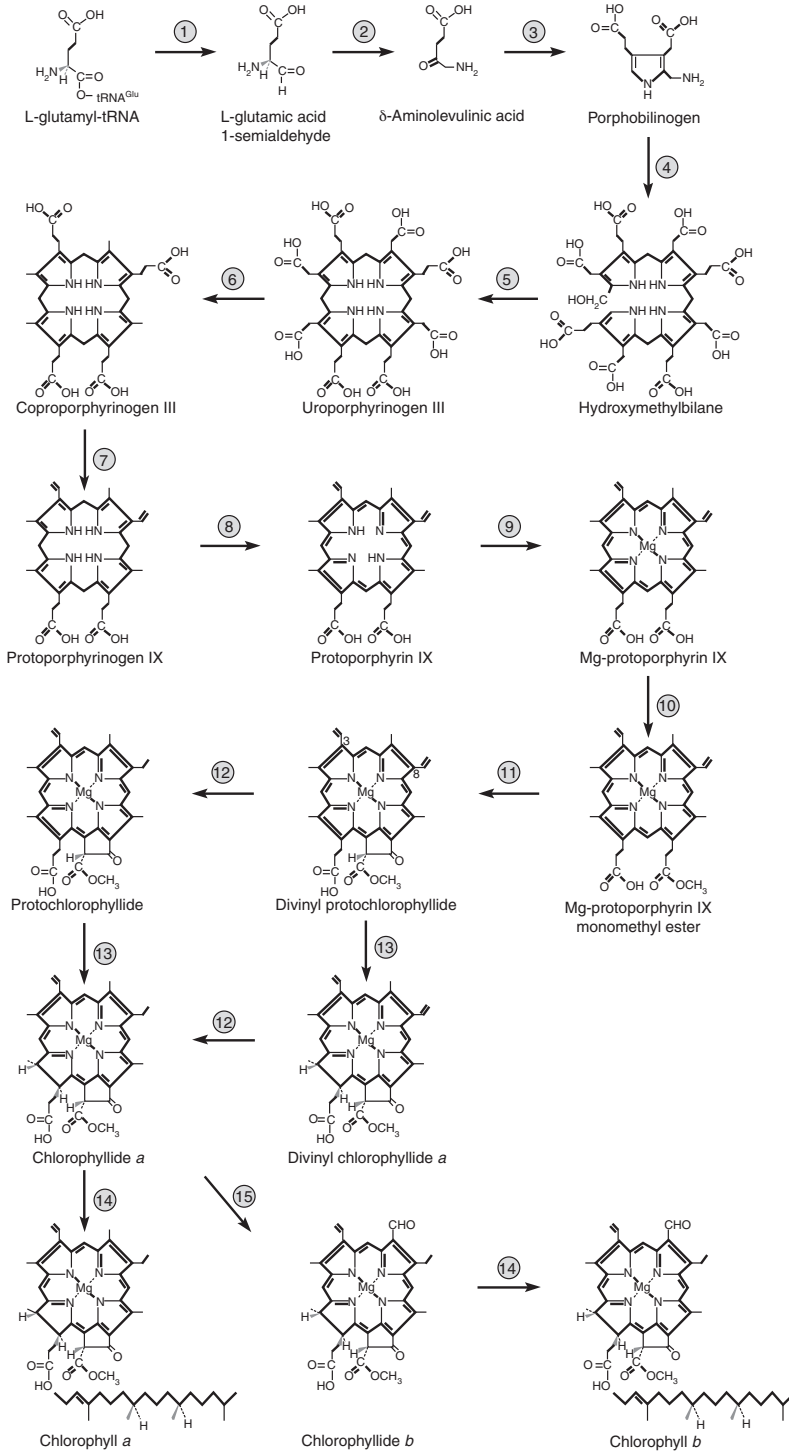

**FIGURE 2.16** The chlorophyll biosynthetic pathway in angiosperms. Numbered arrows refer to the enzymes listed in Table 2.3. Reactions 12 and 13 can occur in either order, depending on the availability of substrates. Reaction 14 can use either of the two substrates indicated. The position numbers of the two vinyl groups are indicated for 3,8-divinyl protochlorophyllide. Note also the formyl group substitution at the methyl group in the upper-right corner of the chlorophyll *a* molecule; such a substitution gives one the structure of chlorophyll *b*. (From Beale, S.I. (2005). *Trends in Plant Sci* 10: 309–312. © Elsevier Inc. With permission.)

TABLE 2.3

Genes Encoding the Enzymes of Chlorophyll Biosynthesis

Step Shown in Figure 2.16	Gene Name from <i>Arabidopsis thaliana</i>	Enzyme Name
1	<i>HEMA1</i> <i>HEMA2</i> <i>HEMA3</i>	Glutamyl-tRNA reductase
2	<i>GSA1</i> or <i>HEML1</i> <i>GSA2</i> or <i>HEML2</i>	Glutamate 1-semialdehyde aminotransferase
3	<i>HEMB1</i> <i>HEMB2</i>	Porphobilinogen synthase
4	<i>HEMC</i>	Hydroxymethylbilane synthase
5	<i>HEMD</i>	Uroporphyrinogen III synthase
6	<i>HEME1</i> <i>HEME2</i>	Uroporphyrinogen decarboxylase
7	<i>HEMF1</i> <i>HEMF2</i>	Coproporphyrinogen oxidative decarboxylase
8	<i>HEMG1</i> <i>HEMG2</i>	Protoporphyrinogen oxidase
9	<i>CHLD</i> <i>CHLH</i> <i>CHLI1</i> <i>CHLI2</i>	Mg chelatase D subunit Mg chelatase H subunit Mg chelatase I subunit
10	<i>CHLM</i>	Mg-protoporphyrin IX methyltransferase
11	<i>CRD1</i> or <i>ACSF</i>	Mg-protoporphyrinogen IX monomethylester cyclase
12	<i>DVR</i>	Divinyl reductase
13	<i>PORA</i> <i>PORB</i> <i>PORC</i>	NADPH:protochlorophyllide oxidoreductase
14	<i>CHLG</i>	Chlorophyll synthase
15	<i>CAO</i> or <i>CHL</i>	Chlorophyllide <i>a</i> oxygenase

Reproduced with permission, from Beale, S.I., *Trends in Plant Sci* 10: 309–312. © Elsevier Inc.

spectrum, with peaks of maximal absorption occurring at 660 and 450 nm, respectively. This is called its **absorption spectrum**. Absorption spectra are commonly used to characterize pigment types. Maximal rates of photosynthesis (measured by the rate of CO<sub>2</sub> uptake or O<sub>2</sub> evolution) also occur in the red and blue portions of the electromagnetic spectrum. This is called its **action spectrum**. When the action spectrum peaks, like that for photosynthesis, matches the absorption spectrum for a given pigment, like that for chlorophylls, one can deduce that the pigment is essential for the absorption of light for the particular process under consideration. Another way to prove pigment type is to find plants that lack the pigment of interest and determine which processes are functional. For example, albino mutants and parasitic plants such as Indian pipe (*Monotropa uniflora*), which are devoid of chlorophyll pigments, cannot carry out photosynthesis. Also, please note that not all plants photosynthesize. **Parasitic plants** feed off the nutrients and sugars provided by their hosts.

#### 2.4.9 Carotenoids and Carotenoid Biosynthesis

**Plant carotenoids** (Figure 2.17) are responsible for the red, orange, and yellow pigments found in fruits and roots, including tomatoes, red peppers, pumpkins, and carrots. They can be seen in the petals of many flowers and are the primary pigments responsible for the fall coloration of deciduous trees. Carotenoids are synthesized in the terpenoid pathway as C<sub>40</sub> tetraterpenes derived from the condensation of eight isoprene units starting with isopentenyl diphosphate (Figure 2.18; Bartley and Scolnik, 1995; Britton, 1995; McGarvey and Croteau, 1995; Dey and Harborne, 1997). There are two basic types of carotenoids: (1) **carotenes** that contain no oxygen atoms and (2) **xanthophylls** that contain oxygen (Figure 2.17). At the center of each carotenoid molecule, the linkage order is reversed, resulting in a molecule that is symmetrical. A set of double bonds in the molecule is responsible for the absorption

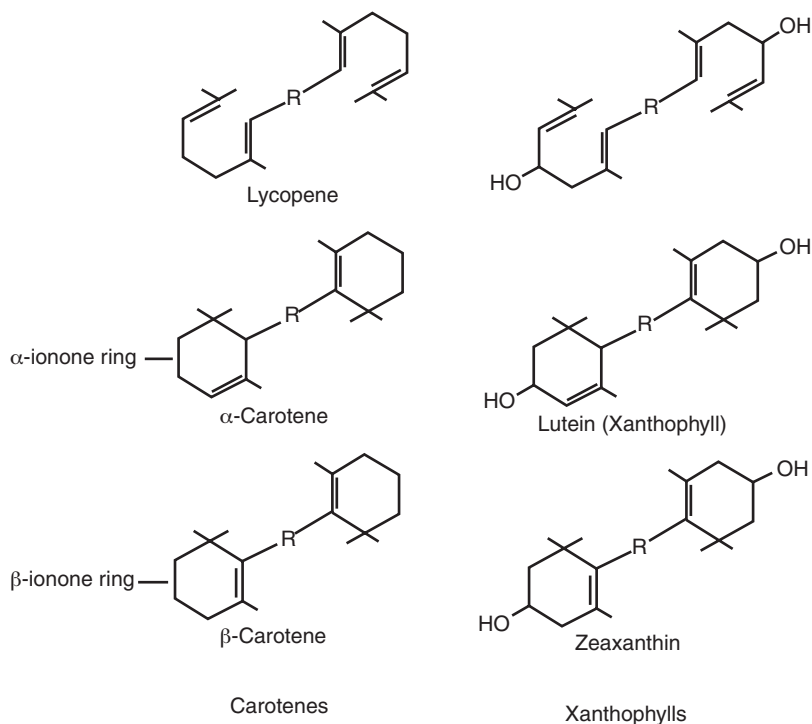
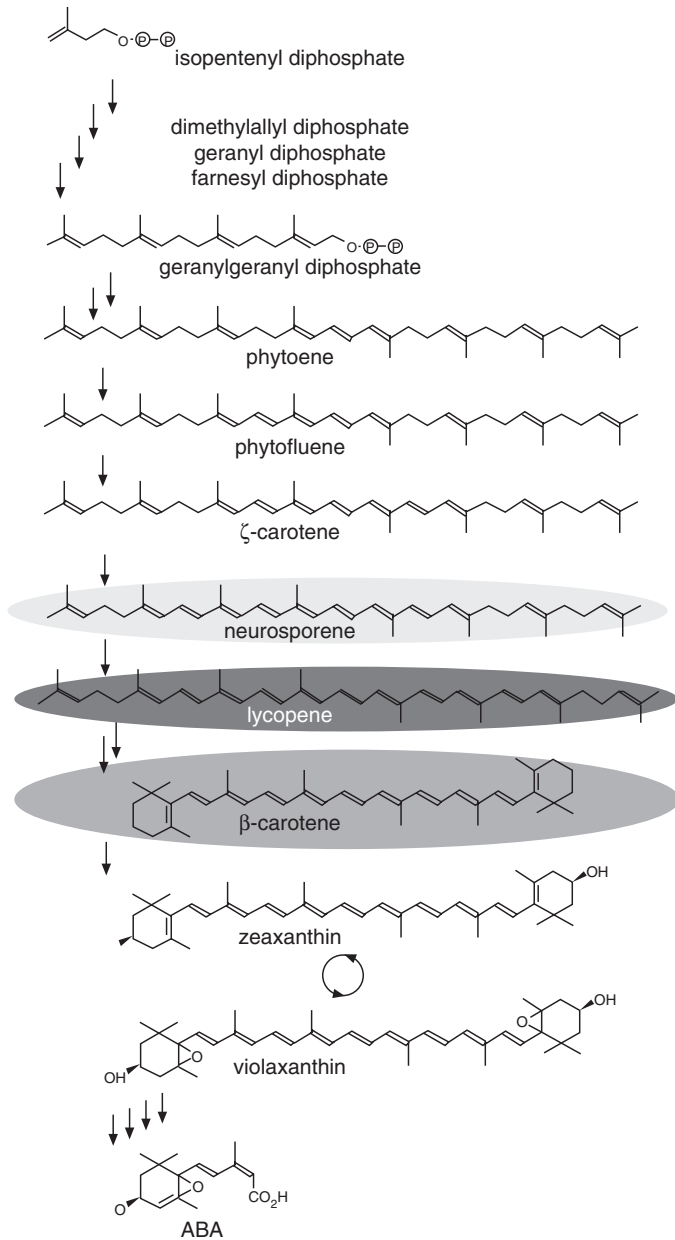

**FIGURE 2.17** Examples of carotenoid and xanthophyll pigments from plants.

of light in the visible portion of the spectrum (Bartley and Scolnik, 1995). As mentioned above, this has an important impact on the absorption of a wider range of light wavelengths for use in photosynthesis (see Figure 2.15). Consequently, in photosynthetic organisms, carotenoids are an integral structural component of photosynthetic antenna and reaction center complexes, but they also protect against the harmful effects of photooxidation processes (Bartley and Scolnik, 1995). Like chlorophyll, carotenoids are found in the thylakoids of green leaves and stems. In fruits and flowers, they are also found in plastids, but these plastids have structural differences and are referred to as **chromoplasts** to indicate that they contain pigments other than chlorophyll.

**β-carotene** is the orange pigment in carrot (*Daucus carota*) roots, sweet potato (*Ipomoea batatas*) tuberous roots, pumpkin (*Cucurbita Pepo*) fruits, leaves of deciduous trees, and some flower petals. Zeaxanthin and violaxanthin are found in autumn-colored leaves and flower petals and are responsible for the bright yellows that are sometimes seen. Coloration of flowers is very important to the survival success of the plants producing them. The color of the flowers is one of the primary factors involved in attracting pollinators. For more information on the attraction of pollinators, see Section 2.6.6. β-carotene is important in the human diet because of its purported anticancer activity, its use as a food coloring, and it is an important source of **vitamin A** (an alicyclic alcohol), which is synthesized from β-carotene and other carotenoids. Vitamin A produced by animals is, in turn, converted to the pigment, **retinal**. This pigment is one of the essential components in the light receptors of the eye that allow us to see.

Carotenoid pigments can also function in fruit and seed dispersal by attracting animals, which, in turn, spread seeds. Most fruits produce odor compounds, such as **monoterpenes**, to help attract these organisms, and the sugars produced and stored in the fruits act as a positive reward. In ripening fruits, as in leaves turning color in autumn, chlorophyll pigments gradually break down in chloroplast thylakoid membranes, revealing the carotenoid pigments that were masked by the chlorophyll pigments. During ripening, there is significant synthesis of new carotenoid pigments. In the case of ripening tomatoes and peppers, for example, the unripe fruits are characteristically bright green. As ripening progresses (triggered by the plant hormone, **ethylene**), various carotenoid pigments appear and, newly synthesized, account for the color of the ripe fruits. **Lycopene** is the red pigment seen in mature tomato and red



**FIGURE 2.18** Carotenoid biosynthesis pathway in plants. (From Bartley, G.E. and P.A. Scolnik. (1995). *The Plant Cell* 7: 1027–1028. With permission.)

pepper fruits. Tomatoes (*Lycopersicon esculentum*) can have both red and yellow fruits depending on the genotype of the parent. In some peppers, ripe fruits are green (sold as sweet bell peppers) but turn red or yellow at maturity (*Capsicum frutescens* var. *grossum*). Other ripe peppers, often very “hot” to the taste (“hot” due to the presence of the alkaloid, **capsaicin**), may be green, orange, yellow, or red at maturity, depending again on the genotype of the parents. Similar types of color changes occur in ripening cucurbit fruits (squash, gourds, and pumpkins in the Cucurbitaceae family) and in the fruits of eggplant (*Solanum melongena* var. *esculentum*).

Some plants, such as red maple (*Acer rubrum*) trees, produce red-colored flowers or leaves, yet they are wind pollinated. It is obvious that these plants do not have to attract pollinators — so, why the color?

One interesting theory behind why they expend their energy to do this is that the pigments help to warm the flowers in early spring or the leaves during early spring or late fall. This extra heat would greatly aid seed development and photosynthetic processes in early spring, allowing the plant to get a head start on growth over other plants as well as providing a longer period during which to produce energy reserves in the fall. Red coloration in many plants is not due to carotenoids, but rather, to anthocyanin pigments found in the vacuoles of plant cells.

#### 2.4.10 Anthocyanins and Anthocyanin Biosynthesis

**Anthocyanins** are flavonoid-type compounds responsible for most of the red, pink, purple, and blue pigments found in roots, stems, leaves, flowers, seeds, and fruits (Williams and Grayer, 2004). Examples include the red anthocyanins in red radish (*Raphanus sativa*), the red leaves of some Norway maple cultivars (e.g., *Acer saccharum* cv. ‘Schwedleri’), the red fruits of some peppers (*Capsicum frutescens*), apples (*Malus sylvestris*), and Acerola cherry (*Malpighia glabra*, said also to contain the highest content of vitamin C, ascorbic acid, of any fruit), and the red, pink, purple, and blue flowers of *Rhododendron*, *Hibiscus*, and *Fuchsia*, to name a few. Anthocyanin pigments occur in the vacuoles of plant cells (Koes et al., 2005). They are synthesized from the aromatic amino acid, phenylalanine, in the phenylpropanoid pathway (Figure 2.19) (see also Koes et al., 2005). This is the same pathway responsible for the synthesis of tannins; flavan derivatives (Figure 2.20); isoflavones like genistein, daidzein, and pterocarpans; lignin; lignans; and coumarin (Burbulis et al., 1996; Dey and Harborne, 1997).

The primary enzyme that commits the pathway to biosynthesis of the anthocyanin pigments is **chalcone synthase (CHS)**. There is a whole gene family of CHS genes within most plants. Some of the genes are expressed in specific tissues. CHS(A), for example, is expressed only in the petals and stamens of flowers that produce anthocyanins. This, and subsequent enzymes in the pathway, have been well characterized (Dey and Harborne, 1997). In petunia, genetic loci controlling the synthesis of most of these enzymes were located, with the exception of 5GT (5-glucosyl transferase; Holton and Cornish, 1995). The different colored anthocyanins arise from precursors that include dihydrokaempferol (a precursor of the orange-to-red anthocyanin, pelargonidin), dihydroquercetin (a precursor of the purplish-red anthocyanin, cyanidin), and dihydromyricetin (a precursor of the bluish-purple anthocyanin, delphinidin) (see Figure 2.21). These anthocyanidins are converted to their **glucosides**, such as pelargonidin-3-glucoside, cyanidin-3-glucoside, and delphinidin-3-glucoside, which affords them better solubility in the aqueous solution of the vacuole.

The glucosyl moieties are typically D-glucose and D-rhamnose sugars. The color of anthocyanins is affected by the number of hydroxyl and methoxyl groups in the B ring of the anthocyanidin, but apart from structure, color is affected by the presence of chelating metals (such as iron and aluminum), the presence of flavone or flavonol copigments, and the vacuolar pH at which these pigments are stored (Table 2.4) (Taiz and Zeiger, 2002; Dey and Harborne, 1997; Buchanan et al., 2000). As one example, in hydrangea (*Hydrangea* spp.) flowers, where the vacuolar pH is acidic, the flower petals appear blue; where it is alkaline, they appear pink. The vast variety of coloration of many leaves, flowers, and fruits is often the result of several different pigments — chlorophylls, carotenoids, and anthocyanins.

Anthocyanins serve many diverse functions in plants, including attraction of insect and bird pollinators to flowers and dispersal of seeds and fruits by birds and mammals. In some cases, they are feeding deterrents, and like other flavonoids, they can protect the plant against damage from UV irradiation (Holton and Cornish, 1995).

Anthocyanins have great economic importance in expression of the wide array of flower colors in plants grown as ornamentals. In fact, attempts to obtain blue roses, chrysanthemums, and carnations are now possible with transgenic plants. In these plants, synthesis of the blue pigment, delphinidin-3-glucoside, does not normally occur, because the 3,5-hydroxylase, is not normally expressed. In the transgenic plants, this gene, obtained from other plants like petunia, is expressed, resulting in the synthesis of the blue delphinidin-3-glucoside anthocyanoid pigment. One interesting application in the use of naturally occurring anthocyanin pigments comes from the pigment present in the red roots of radish, *Raphanus sativus*. This water-soluble pigment is extracted from these roots and is currently used to dye

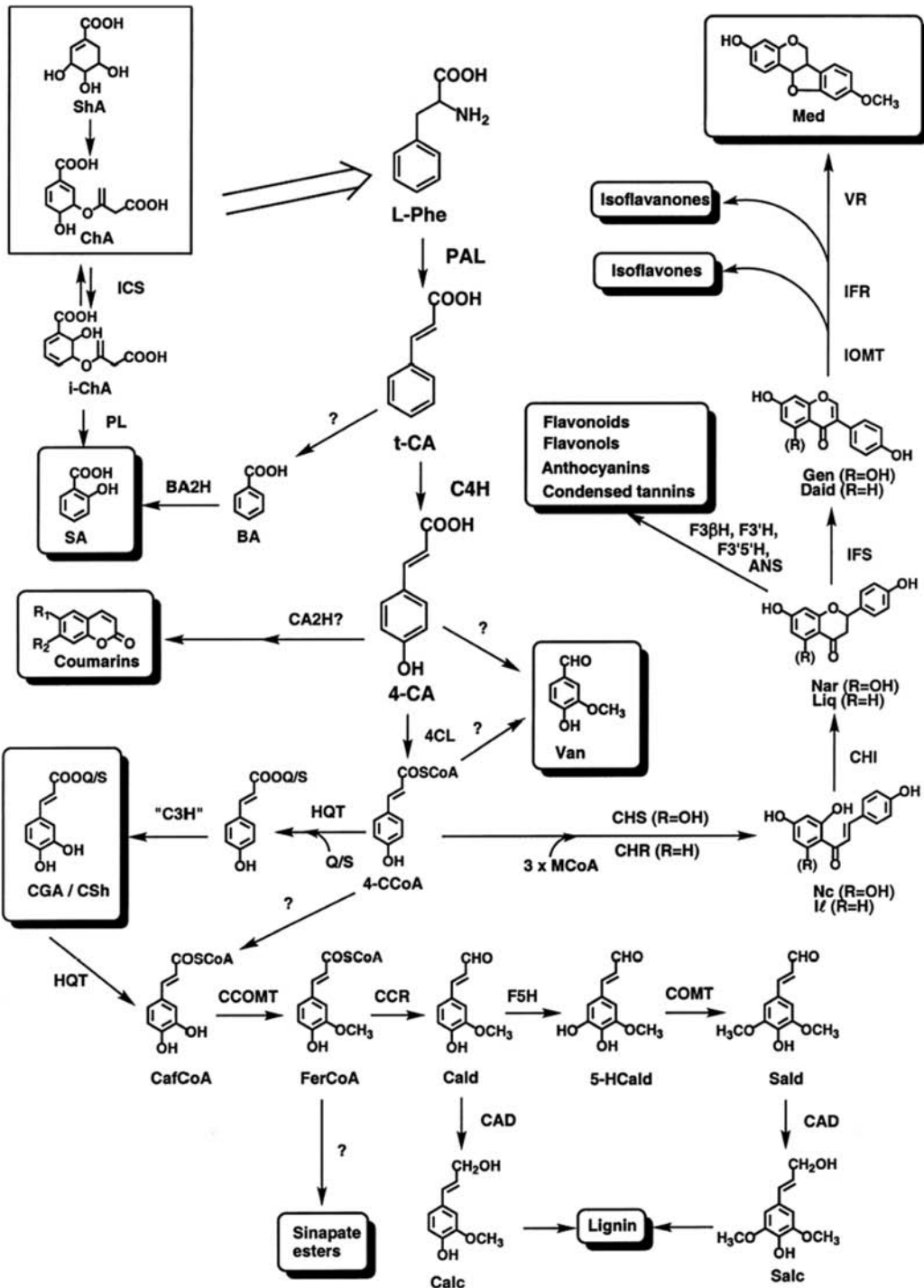

FIGURE 2.19 The general phenylpropanoid and flavonoid branch pathways. (From Dixon, R.A. et al. (2002). *Mol Plant Pathol* 3: 371–390. © Blackwell Publishing. With permission.)

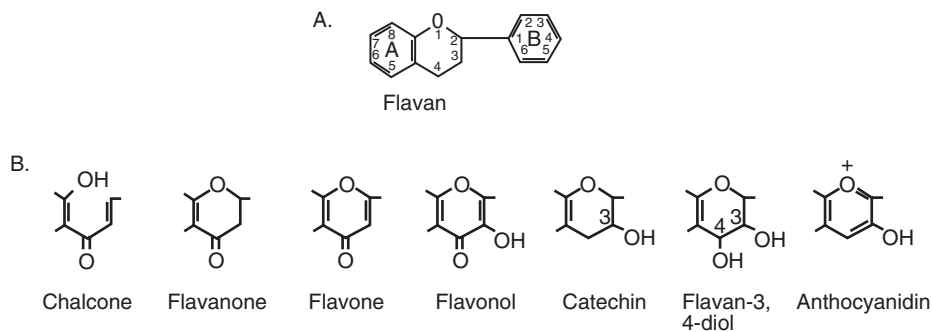

FIGURE 2.20 Survey of several flavan derivatives (B), based on the basic flavan skeleton (A).

Marashino cherries bright red instead of using a synthetic red dye as was done previously. This process was developed by horticulturists at Oregon State University in Corvallis, OR.

### 2.4.11 Alkaloids and Alkaloid Biosynthesis

So far, we tried to touch upon each of the major categories of products produced by plants in general. We discussed the biosynthesis of the major cellular components found in the majority of plants, including primary storage compounds and key compounds that start the carbon fixation process (chlorophylls). We used carotenoids to demonstrate the production of terpenoids and anthocyanins to give examples of phenolic compounds. Now we will say a few words about nitrogen-containing compounds, which will be represented by the alkaloids.

Most of these products are not considered to be essential to the growth and development of the plant, but some, such as pyrimidine nucleotides and tetrapyrroles, are essential (see Chapter 1 and Section 2.6.3). This is why we separated these compounds from the rest of the nitrogen-containing compounds in Figure 2.1.

There are thousands of different plant products that have nitrogen in their structures. Perhaps the most diverse of these types of compounds (found in 20 to 30% of vascular plants) are the **alkaloids** that, like most other nitrogen-containing compounds, are synthesized from amino acids (Herbert, 2003). Alkaloids are especially interesting because they are toxic to both herbivores and humans; yet they have some very important medicinal properties for humans. The nitrogen atom, which in these substances is almost always part of a heterocyclic ring origin, is found innately in the structure of the amino acids from which they came or are the result of the circularization of the given amino acid. This is the case with aspartic acid that combines with glyceraldehyde-3-phosphate in the production of nicotinic acid (a precursor of the alkaloid, nicotine) in plants such as tobacco (*Nicotiana tabacum*). Nicotine is well known as a toxic component of tobacco smoke. There are many categories of alkaloids, including pyrrolidine, tropane, piperidine, pyrrolizidine, quinolizidine, isoquinoline, and indole alkaloids (Michael, 2003, 2004). Much of the carbon skeleton of some of these alkaloids is derived from the mevalonic acid pathway, but it is beyond the scope of this chapter to go into the details of the biosynthesis of all types of alkaloids. Figure 2.22 shows the major alkaloid classes and the biosynthetic precursors.

An old idea about the function of alkaloids in plants depicted them as waste products of plant metabolism. However, plants are energetically efficient organisms. They simply do not waste their energy in the production of compounds that they do not need — there always seems to be a reason for their production. The predominant activity of alkaloids in plants seems to be the deterrence of **herbivores**. Many livestock deaths are caused by ingestion of alkaloid-containing plants such as lupines (*Lupinus* spp.), larkspur (*Delphinium* spp.), and groundsel (*Senecio* spp.). They were also shown to be toxic to insects, bacteria, and fungi.

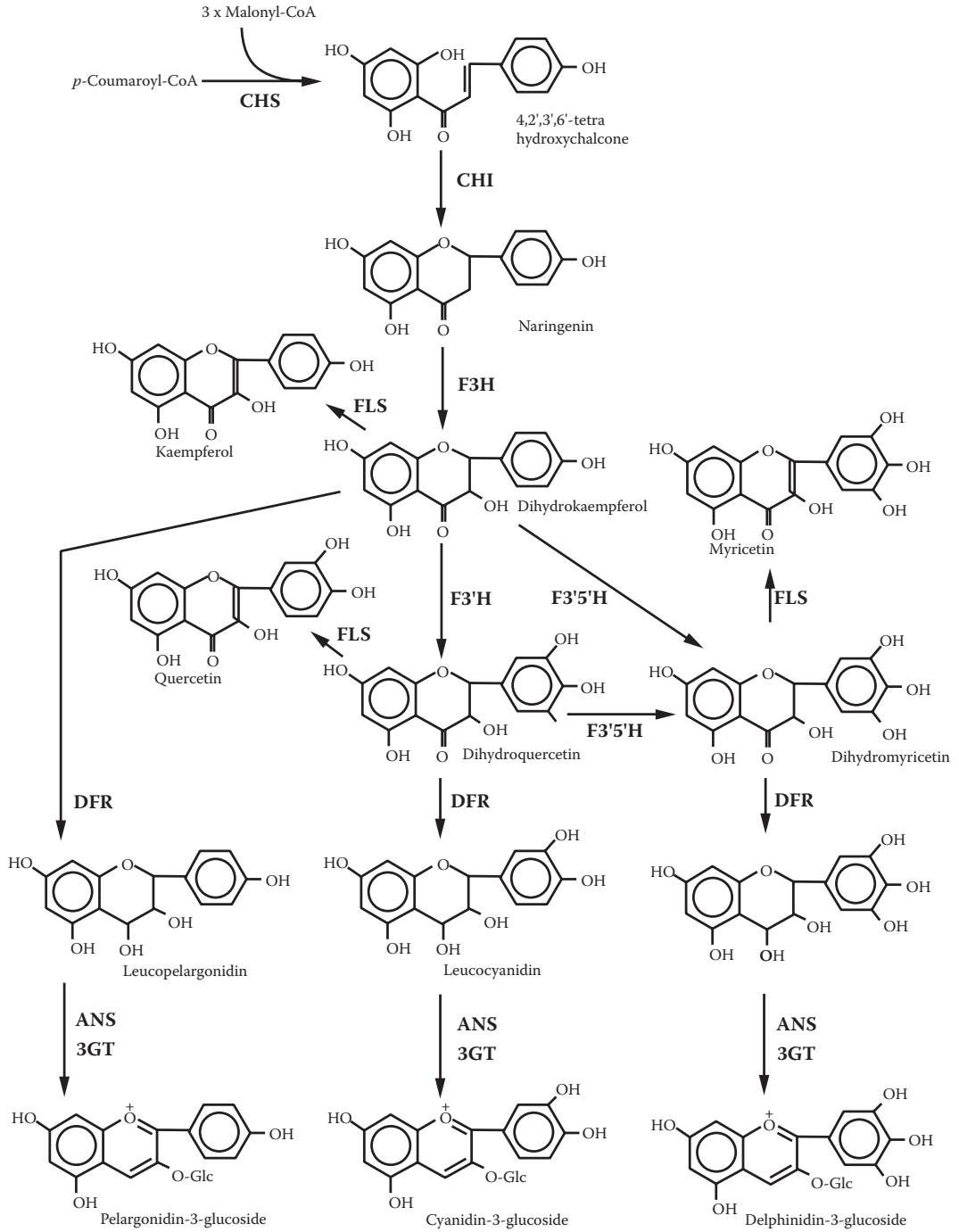

**FIGURE 2.21** Anthocyanin and flavanol biosynthetic pathway. (From Holton, T.A. and E.C. Cornish. (1995). *The Plant Cell* 7: 1071–1083. With permission.)



TABLE 2.4

## Factors Controlling Cyanic Color in Flowers

Hydroxylation pattern of the anthocyanidins (i.e., based on pelargonidin, cyanidin, or delphinidin) <sup>a</sup>
Pigment concentration
Presence of flavone or flavonol co-pigment (may have bluing effect)
Presence of chelating metal (bluing effect)
Presence of aromatic acyl substituent (bluing effect)
Presence of sugar on B-ring hydroxyl (reddening effect)
Methylation of anthocyanidins (small reddening effect)
Presence of other types of pigments (carotenoids have browning effect)

<sup>a</sup> In approximate order of importance. There are other minor factors, including pH and physical phenomena.



Alkaloid Class	Structure	Biosynthetic Precursor	Examples
Pyrrolidine		Aspartic acid	Nicotine
Tropane		Ornithine	Atropine, cocaine
Piperidine		Lysine (oracetate)	Conline
Pyrrolizidine		Ornithine	Retrorsine
Quinolizidine		Lysine	Lupinine
Isoquinoline		Tyrosine	Codeine, morphine
Indole		Tryptophan	Psilocybin, reserpine, strychnine

FIGURE 2.22 Major classes of alkaloids, their chemical structures, their biosynthetic precursors, and well-known examples of each class.

Alkaloids are not solely defensive substances. Some red and yellow alkaloids, called **betalains**, like carotenoids and anthocyanins, act as attractants in flowers and fruits of cacti (e.g., prickly pear cactus, *Opuntia* spp.). It is interesting to note that plant families that contain betalain pigments (e.g., in the goosefoot family, Chenopodiaceae, with a familiar example being the root of the garden beet, *Beta vulgaris*) never contain anthocyanins (see Robinson, 1991). Some pyrrolizidine alkaloids act as attractants by mimicking such compounds as the sexual **pheromones** normally produced by some insects like butterflies. These compounds trick the insect into visiting the flower and spreading the plant's pollen, but alkaloids, in general, are toxic. When taken in sufficient quantity, alkaloids are dangerously toxic to

humans, but at lower doses, many are helpful — **morphine**, **codeine**, **atropine**, and **ephedrine**, to name a few (Bercovitch et al., 1999; Taber et al., 2002). Other alkaloids, including **nicotine**, **caffeine**, and **cocaine**, are popular non-medicinal stimulants or sedatives, but they too have their toxic effects (Weinberg and Bealer, 2002).

---

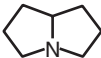
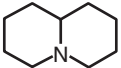
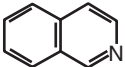
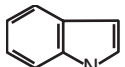
## 2.5 Synthesis of Plant Metabolites in Specialized Structures or Tissues

Plants do not always produce their metabolic products in every cell of the organism. Often, plants have developed tissue-specific locations for synthesis of certain compounds. This not only accentuates the compound's specific function, but also, perhaps helps the plant to avoid the toxic effects that the compound may have on it. This is the case for all plant products within each cell of every plant, but the plant as a whole must have a system for dealing with potentially hazardous substances. The following are a few examples.

### 2.5.1 Synthesis of Monoterpenes in the Leaves of Peppermint (*Mentha piperita*)

It was shown by Croteau and Winters (1982) at Washington State University that leaves can synthesize a variety of **monoterpenes** from **geranyl pyrophosphate** (GPP), as shown in Figure 2.23. GPP production in the terpenoid pathway is the universal precursor of all monoterpenes. Monoterpenes, as well as some **sesquiterpenes**, in general, serve as antiherbivore agents that have significant insect toxicity but negligible toxicity to mammals. Mixtures of these low-molecular-weight volatiles, called **essential oils**, are what give plants, such as peppermint, lemon (*Citrus limon*), basil (*Ocimum basilicum*), and sage (*Salvia officinalis*), their characteristic odors, and many are commercially important in flavoring foods and in making perfumes.

Of particular interest in peppermint is the pathway of *l*-menthone metabolism, as illustrated in Figure 2.24. The branch of this pathway at the top of the figure shows the biosynthesis of *l*-menthol and *l*-menthyl acetate from *l*-menthone. These substrates and the enzymes that lead to their biosynthesis occur in the **glandular hairs** that arise from leaf epidermal tissue. The products are stored in a modified extracellular space between the cuticle and the cell wall. Well known to repel insects, menthol at the very surface of the leaves (in hairs) seems to deter herbivores before they even get a chance to take a trial bite. In contrast, the branch in the pathway at the bottom of the figure that leads to the synthesis of *d*-neomenthol and *d*-neomenthol glucosides occurs not in the epidermal hairs, but rather, in the photosynthetic mesophyll tissue of the leaves that lies inside the epidermis. The ultimate product, *d*-neomenthol glucoside, is then translocated from the leaf mesophyll tissue to the phloem in the leaf vascular bundles, and from there, to the roots of the plant, where it is stored. This difference in cell/tissue compartmentation for monoterpene biosynthesis in peppermint leaves is of particular interest to biochemists, physiologists, and cell biologists as a model for the control of gene expression in different tissues and for the study of translocation of compounds within the plant. For the plant, it most likely evolved this bifurcation in the *l*-menthone biosynthetic pathway in response to predation pressures by insects and herbivores that prey on both the leaves/stems and roots of these plants. However, not all monoterpenes and sesquiterpenes are repellents. Sometimes their primary function is to attract.

### 2.5.2 Synthesis of Monoterpenes in the Petals of Flowers

Apart from the coloration factors discussed above and in Section 2.6.6, the flowers of many plant species attract pollinators by producing different complex mixtures of volatile compounds within the various floral organs (i.e., stigma, style, ovary, filaments, petals, or sepals). The combinations of the constituents of this scent mixture give each flowering plant species a unique fragrance (Dodson et al., 1969; Galen, 1985). The fact that insects can distinguish between these different floral scent mixtures is the key to the reason that many specific plant species often have specific pollinator species. For example, plants that make flowers that produce **linalool** (a monoterpene) often attract moth pollinators during the night, while species that may look similar and live in the same area, but do not produce

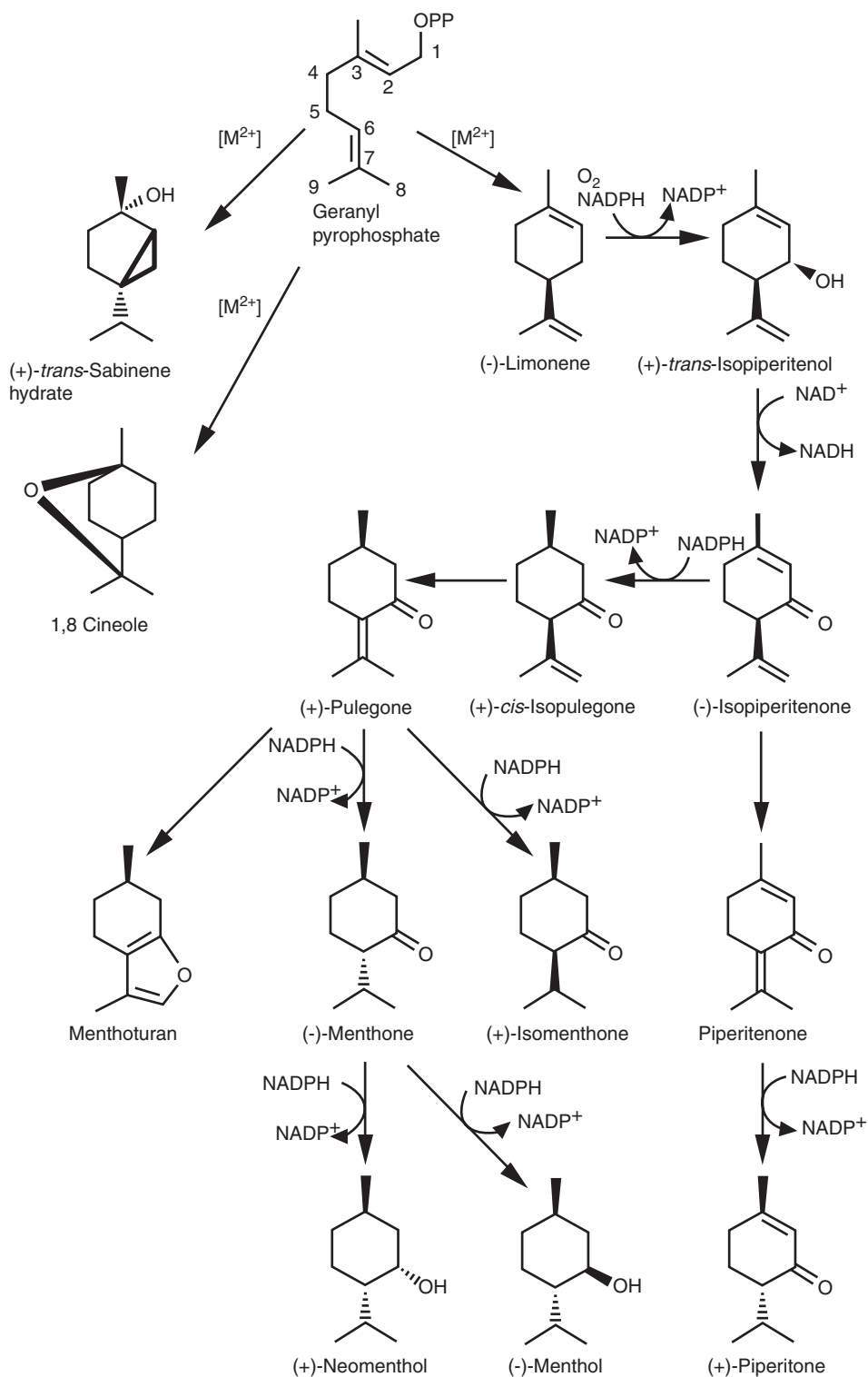

**FIGURE 2.23** Major pathways and cofactor requirements for monoterpene biosynthesis in peppermint (*Mentha spicata*).  $[Mg^{2+}]$  is the divalent metal ion cofactor (either  $Mg^{2+}$  or  $Mn^{2+}$  required by monoterpene cyclases). (From McCaskill, D., J. Gershenzon, and R. Croteau. (1992). *Planta* 187: 445–454. With permission.)

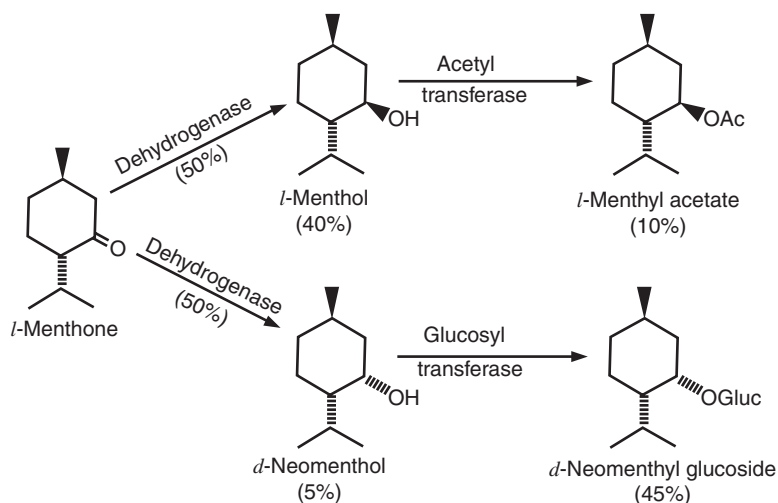

**FIGURE 2.24** Pathways of *l*-menthone metabolism in peppermint (*Mentha spicata*). The percentages indicate the approximate distribution of the products derived from menthone in mature leaf tissue. (From Croteau, R. and J.N. Winters. (1982). *Plant Physiol* 69: 975–977. With permission.)

linalool, do not attract moths (Raguso et al., 1996). They are pollinated by other insects, usually bees or butterflies, during the daytime. Thus, the components of a floral scent have important implications for the pollination success of the plants that produce them (Dodson, 1993; Galen and Kevan, 1983; MacSwain et al., 1973; Pellmyr, 1986).

Although floral scent production is crucial, it was only recently addressed by the biochemical and molecular biology disciplines. Consequently, few of the biochemical pathways that produce the vast array of scent compounds have been elucidated, and although many of these compounds are monoterpenes, only a handful of the enzymes that directly produce a monoterpene floral scent compound have been identified. **Linalool synthase** (LIS), for example, catalyzes the conversion of GPP directly to linalool (Figure 2.25). Linalool is a common acyclic monoterpene floral scent compound pro-

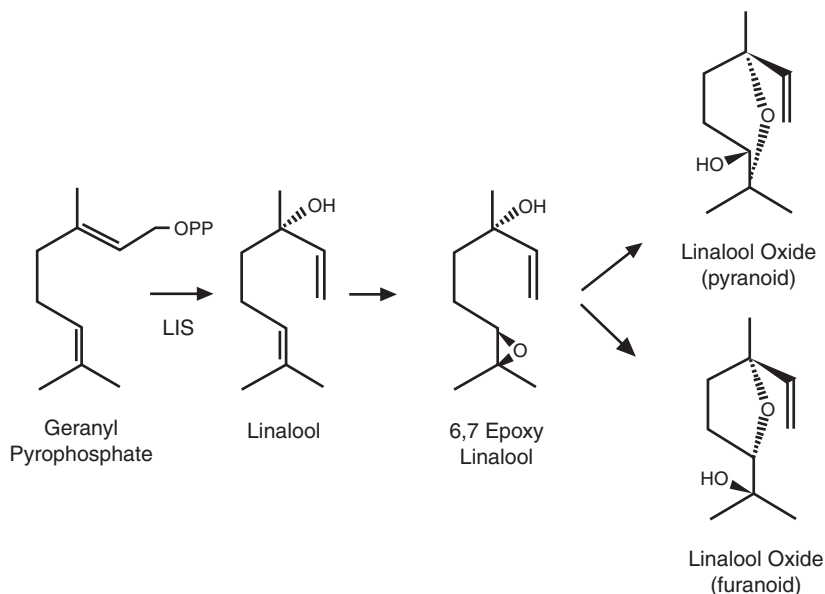

**FIGURE 2.25** The linalool and linalool oxides pathway. (Courtesy of Eran Pichersky and Leland Cseke.)

duced by the flowers of many plant species (Dodson, 1993; MacSwain et al., 1973; Pellmyr, 1986; Pichersky et al., 1994, 1995; Raguso and Pichersky, 1995; Crowell et al., 2002). In *Clarkia breweri* plants (a small annual plant native to California), LIS enzyme is produced predominantly by the epidermal cells of the petals, which are responsible for the majority of linalool emission from the flower (Dudareva et al., 1996). Linalool has its oxide forms that are produced through a suspected epoxide intermediate by an as-yet-unidentified epoxidase (see Figure 2.25). These oxides are produced predominantly in the transmitting tissue of the stigma and style of each flower, where pollen tubes grow during pollination. The oxides, however, are a minor component of the floral scent mixture. Linalool and its oxides are produced only when the flower is open, beginning as soon as the flower opens and ending just after the flower is pollinated. This timing has a distinct advantage for the plant because it avoids wasting energy by producing compounds only when they are needed. Linalool is known to be toxic to some insects, such as fleas. There is also evidence from transgenic studies that linalool production is toxic to young plant tissue. Thus, producing linalool only when a more mature tissue, such as a flower, has developed may help avoid other toxic effects within the plant. In any case, the primary activity of linalool seems to be to attract a specific moth pollinator (a hawkmoth) that lives in the same region as *C. breweri*. The oxides may also play a part in this role, but it seems likely from their expression patterns that linalool oxides have potential roles (1) in directing the visiting insect specifically to the stigma, where it is most advantageous for the plant to have pollen placed; or (2) in inhibiting pollen tube growth of other species or the stimulation of pollen tube growth from the same species. The true function of the oxides, however, is not known. Like other monoterpenes, linalool is important in industry as a starting material in the production of perfumes and as a flavoring compound in food and drink (Croteau and Karp, 1991; Crowell et al., 2002). Its study not only helps us understand how plants communicate with insects, but may also benefit industry and agriculture — especially with the potential for the modification of scent production through transgenic plants or crop plants that are grown outside of their natural pollinator's living range, and thus, suffer from lower crop yields.

Another interesting part of the *Clarkia* example deals with the general question of how the ability to produce linalool changes over evolutionary time (Cseke et al., 1998). As mentioned above, species that produce linalool are generally pollinated by moths, while species that do not produce linalool are pollinated predominantly by bees and butterflies. This part of the study focuses on the differences in the molecular genetics and biochemistry of scent production between *Clarkia* and *Oenothera* (evening primrose) species that determine the differences in primary pollinators. *Oenothera* and *Clarkia* are in the same family (Onagraceae) and are thus closely related. Most *Oenothera* produce scent, including linalool; yet only two species within the *Clarkia* genus, *C. concinna* and *C. breweri*, produce linalool (Pichersky et al., 1994, 1995; Raguso and Pichersky, 1995). Flowers of *C. concinna*, like those of all other *Clarkia* species, are odorless to the human nose. However, linalool and its pyranoid and furanoid oxides were detected in *C. concinna* stigmas using gas chromatography/mass spectrometry (GC-MS), but at levels 1000-fold less than in *C. breweri*. Additionally, chromosomal, morphological, and genetic data suggest that *C. breweri* evolved relatively recently from *C. concinna* (MacSwain et al., 1973; Raguso and Pichersky, 1995).

These observations raise at least two questions: (1) What is the function of the linalool pathway in nonscented plants, such as *C. concinna*; and (2) What is the mechanism of evolution that allows the scent trait to be switched off and on over evolutionary time? This evolution could occur through several mechanisms — enzymatic, morphological, or genetic — but research so far has narrowed the possibilities for differential scent production between *C. breweri* and *C. concinna* to control at the level of transcription (Cseke et al. 1998; Dudareva et al., 1996). It is generally accepted that *Oenothera* and *Clarkia* species share a common ancestor; yet, they show a surprising diversity in the ability to produce linalool. By characterizing the expression and regulation of genes that encode enzymes, such as linalool synthase, researchers can uncover how scented species, such as *Oenothera*, evolve into non-scented species, such as most *Clarkia* species, and yet retain the ability to evolve into scented species again — as *C. breweri* has done.

### 2.5.3 Synthesis of Oleoresin Terpenes in Conifers

**Oleoresin** is a mixture of terpenoid compounds in the tissues of many species, but is best characterized in conifers. Oleoresin from pine trees, also known as **pitch**, is composed mainly of monoterpene olefins (turpentine) and diterpene resin acids (rosin) (Funk et al., 1994). So-called constitutive oleoresin is synthesized in epithelial cells surrounding resin ducts in the needles and stems (Esau, 1965) as well as in resin blisters on the bark of the tree trunk. In contrast, induced resin arises from non-specialized cells located adjacent to sites of injury that are not normally associated with oleoresin biosynthesis (Johnson and Croteau, 1987). This resin is secreted in response to physical wounding or attack by fungal pathogens and insects such as bark beetles. Resins, however, are not all related to gum, which may have the same function in other species. This defense reaction by conifers is adaptively important to the survival of conifers in natural habitats, because the oleoresins are antifungal and toxic to bark beetles. Wounded areas in the bark of a tree trunk or branch physically become sealed by the solidification of the resin acids after the turpentine has evaporated (Johnson and Croteau, 1987). This may also serve to prevent loss of water.

The traditionally referenced biosynthetic pathway for the synthesis of monoterpene olefins and abietic acid (the primary diterpenoid resin of grand fir, *Abies grandis*) is shown in Figure 2.26 (Funk et al., 1994). However, this pathway is actually a good example of the type of controversy that can arise when attempting to elucidate the true biosynthetic pathways found in plants. Note that the starting substrate in the pathway is **acetyl-CoA**. From it, oleoresin biosynthesis proceeds stepwise via mevalonate, isopentenyl pyrophosphate, dimethylallyl pyrophosphate, farnesyl pyrophosphate, and geranyl-geranyl pyrophosphate (GGPP) in the same biochemical processes that produce the precursors of menthol and linalool (Crowell et al., 2002). The GPP leads directly to synthesis of monoterpene olefins such as  $\alpha$ -

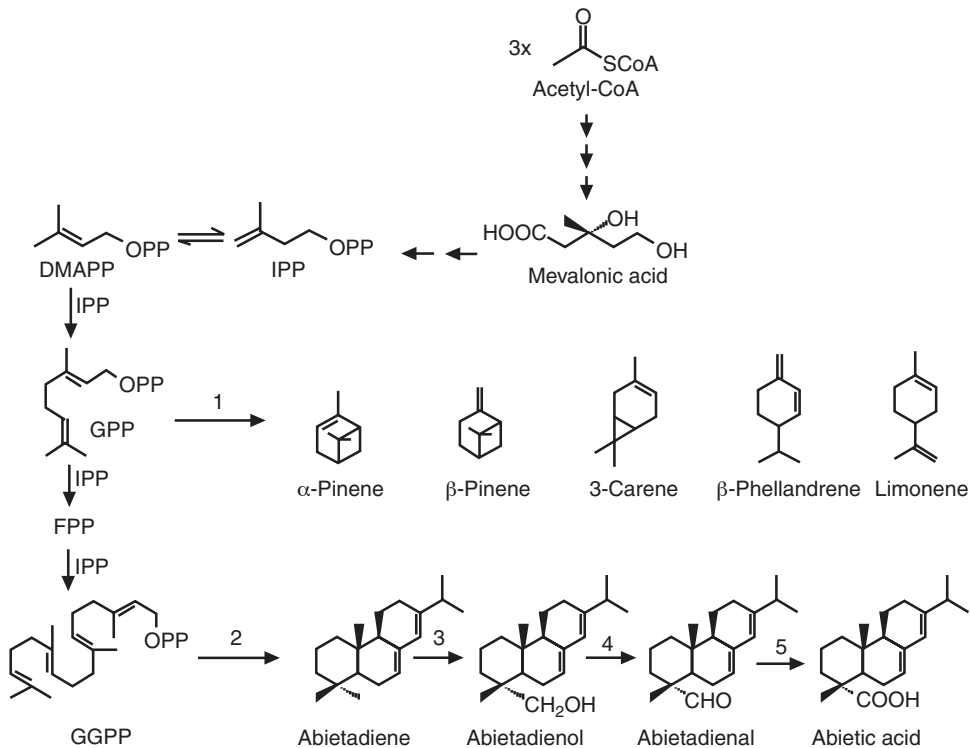

**FIGURE 2.26** Outline of the biosynthesis of monoterpene olefins and abietic acid, the principal diterpenoid resin of grand fir (*Abies grandis*) oleoresin. IPP, isopentenyl pyrophosphate; DMAPP, dimethylallyl pyrophosphate; GPP, geranyl pyrophosphate; FPP, farnesyl pyrophosphate; GGPP, geranyl-geranyl pyrophosphate; 1, monoterpene cyclases; 2, abietadiene cyclase; 3, abietadiene hydroxylase; 4, abietadienol hydroxylase; 5, abietadienal dehydrogenase. (From Funk, C. et al. (1994). *Plant Physiol* 106: 999–1005. With permission.)

and  $\beta$ -pinene, 3-carene,  $\beta$ -phellandrene, and limonene catalyzed by monoterpene cyclases. The substrate, GGPP, leads to the synthesis of the diterpenoid resin, abietic acid, through four enzymatic steps involving a single cyclase, two hydroxylases, and a dehydrogenase. Each of these enzymes was isolated and assayed for the production of respective products by **liquid scintillation spectrometry** using [1(2)-  $^{14}\text{C}$ ] acetic acid as the starting substrate (Funk et al., 1994).

However, as we pointed out in Section 2.2, there are actually two biosynthetic pathways leading to isopentenyl diphosphate (IPP). In the cytosol, IPP is formed from pyruvic acid via acetyl-CoA and mevalonic acid, as shown in Figure 2.26. However, in plastids, IPP is synthesized from pyruvic acid and glyceraldehyde-3-phosphate via 1-deoxy-D-xylulose-5-phosphate (DOXP) and 2-C-methyl-D-erythritol-4-phosphate (MEP) (Eisenreich et al., 1998, 2004; Kuzuyama, 2002; Dubey et al., 2003). Using a similar precursor labeling approach as that described in Section 2.2, Hampel and associates (2005) were able to clearly show that monoterpenes are biosynthesized exclusively via the 1-deoxy-D-xylulose/2-C-methyl-D-erythritol-4-phosphate (DOXP/MEP) pathway, whereas sesquiterpenes are generated by the classical mevalonic acid pathway as well as by the DOXP/MEP route. While these experiments were performed using a carrot model system, there are usually not many differences in the behavior of biosynthetic pathways between different plant species. Therefore, it would seem that the first part of Figure 2.26 (where IPP comes from the mevalonic acid pathway and leads to monoterpene production) is most likely incorrect, and it may be more likely that the monoterpene olefins are actually derived from the DOXP/MEP pathways. In any case, we use this contradiction as an example of the types of problems that can arise when attempting to make the often necessary assumptions required to elucidate the downstream steps in the biosynthetic pathways of plant compounds. Often, the pathways are so complex that the missing information can lead researchers astray.

#### 2.5.4 Synthesis of Polyketides in Multicellular Cavities of *Hypericum perforatum*

Polyketides are naturally occurring compounds that contain multiple ketone groups, most frequently reported from bacteria and fungi. However, plants and marine invertebrates also produce a variety of polyketide structures. Polyketides can be classified into three diverse groups: polycyclic aromatics, macrolides, and polyethers. Among the members of this family of compounds are well-known antibiotics such as tetracycline, erythromycin, and avermectin, produced by *Streptomyces* sp., and important immunosuppressants, such as rapamycin and FK506 (O'Hagan, 1995). In addition, cancer-causing agents, such as aflatoxins (Chang et al., 1995), and cholesterol-lowering drugs, such as lovastatin (Hendrickson et al., 1999), are both products of fungal polyketide biosynthesis. In plants, aromatic polyketides range from compounds that act as **phytoalexins** (plant defense compounds) and colorants to compounds such as the bioactive ingredients in phytomedicinal crops.

St. John's wort (*Hypericum perforatum* L.) is considered to be an important source of pharmaceuticals, the bulk of which occur in the aerial parts of the plant. The three major medicinal phytochemicals of *H. perforatum* are **hypericin**, **pseudohypericin**, and **hyperforin** (Figure 2.27). These compounds possess antidepressive, anticancer, antiviral, and antibiotic activities (see Section 7.3.2 in Chapter 7 and references cited therein). Such compounds, however, are not produced in all tissues of the plant but are accumulated in special structures. Biosynthesis of hypericins is connected with the morphogenesis and formation of dark-red-colored oil glands in the leaves and flowers of mature plants (Cellárová et al., 1995). Likewise, the hyperforins are localized in the reproductive structures of the plant. In addition, two types of secretory structures are known for *H. perforatum*: (1) translucent spheroidal cavities in which essential oils accumulate and (2) multicellular nodules containing hypericin and related compounds (Figure 2.28). The reason for the accumulation of such compounds in specialized regions is likely based on their potential toxicity to normal cellular functions in other types of tissues.

The family of hypericins consists of anthraquinones that are most likely formed via the polyketide pathway (Torsell, 1997; Eckerman et al., 1998). Even though polyketides are chemically diverse, the chemical mechanism by which they are synthesized is one of the most widespread routes used in nature. Using enzymes called **polyketide synthases (PKSs)**, polyketides are produced in the cytosol via the

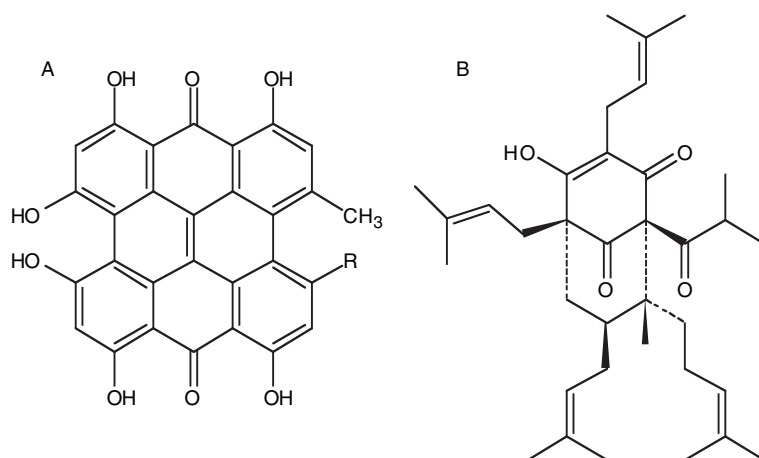

**FIGURE 2.27** Chemical structures for hypericin (A, R=CH<sub>3</sub>), pseudohypericin (A, R=CH<sub>2</sub>OH), and hyperforin (B). (From Kirakosyan et al. (2004). *Biotechnol Appl Biochem* 39: 71–81. © Portland Press Ltd. With permission.)

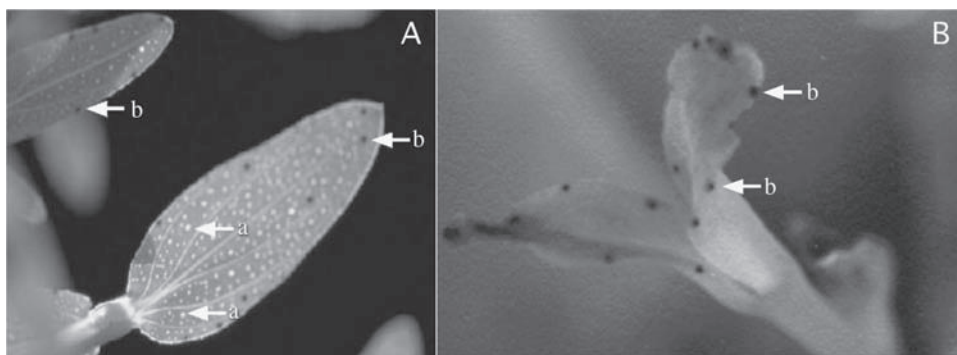
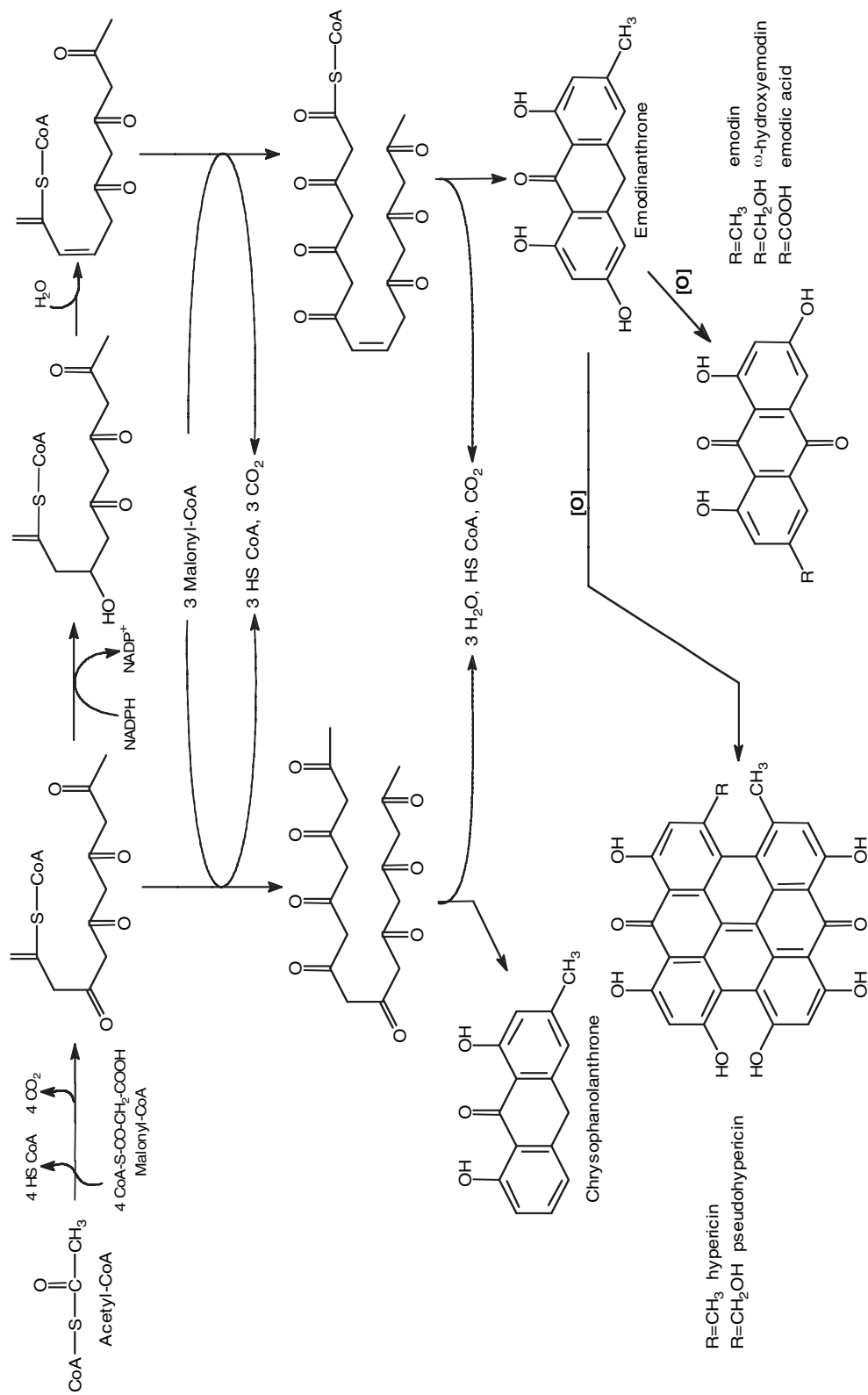

**FIGURE 2.28** (See color insert following page 256.) *Hypericum perforatum* leaves. (A) the leaves of intact plants. (B) the leaves of shoot cultures. Arrows show: (a) translucent spheroid cavities, (b) dark-red-colored glands containing hypericin.

acetate pathway through the condensation of a starter (usually acetyl CoA) and extensor molecules (usually malonyl CoA), resulting in a chain with carbonyl groups present. These enzymes catalyze the initial steps in polyketide formation. Acetate, propionate, and sometimes butyrate units are used as the building blocks, which are subsequently linked to a specific starter substrate (for reviews, see Hopwood, 1997; Khosla et al., 1999; Shen, 2000 and the papers cited therein). The units are attached to a growing chain bound to the PKS. Chemical variation occurs, because PKSs control the number and type of units added as well as the extent of reduction and stereochemistry of the  $\alpha$ -keto group at each condensation. Other enzymes can modify the polyketide to produce an array of chemical diversity (Hopwood, 1997; Shen, 2000). Hypericin, for example, is thought to originate from emodinanthrone (a product of the polyketide pathway), which is dimerized and further oxidized to protohypericin and finally to hypericin (Torsell, 1997) (see Figure 2.29 for the proposed pathway).

Of the PKSs from plants characterized to date, all have been classified as iterative type I PKSs, as exemplified by **chalcone synthase (CHS)** and **stilbene synthase (STS)**. Structurally, the simplest form of PKS exists as an iterative, homodimeric enzyme that directly uses acyl CoA esters and catalyzes multistep processes (Kirakosyan et al., 2004, and references cited therein). Plant PKSs typically do not contain an acyl carrier protein (ACP) domain. Thus, they directly catalyze the condensation of acyl CoA units. Both CHS and STS are structurally similar and share approximately 70% sequence homology. Both use acyl CoA esters to produce flavonoids, stilbenes, and other related aromatic polyketides in plants (for reviews, see Hopwood, 1997; Khosla et al., 1999; Shen, 2000).





**FIGURE 2.29** The proposed polyketide pathway for hypericin biosynthesis. (From Kirakosyan et al. (2004), *Biotechnol Appl Biochem* 39: 71–81. © Portland Press Ltd. With permission.)

## 2.5.5 Secretion of Sodium and Potassium Chloride from Salt Glands of Plants That Grow in Saline Environments (Halophytes)

Over evolutionary time, plants developed mechanisms that allow them to survive in a given environment that has specific conditions. Sometimes these environmental conditions are harsh. A number of plants that are tolerant of, and grow in, saline environments secrete salts from their leaves using specialized salt glands. The leaves taste salty because of these saline secretions. One such plant is salt grass, *Distichlis spicata*, which grows in such areas as the “playas” or salt flats near the Great Salt Lake and the Bonneville Salt Flats in Utah or in the saline soils of the Sacramento Valley of California. Scanning electron micrographs of the surfaces of the leaves of salt grass reveal glands and toothpaste-like secretions that emanate from these glands. If one makes x-ray analysis maps for sodium, potassium, and chlorine of the same area imaged with the scanning electron microscope, the images seen on the **CRT (cathode ray tube)** will reveal bright-dot images over each toothpaste-like secretion (Hanson et al., 1976). This tells researchers which elements are present in the secretions. From this information, it was shown that these secretions are **potassium chloride** and **sodium chloride**, corresponding to the predominant salts in the soil or in brackish water in which these plants grow. To avoid possible damage due to the osmotic effects of salt, these plants simply secrete the salt that is taken up by the roots, thus keeping it out of the plant’s cells.

---

## 2.6 Adaptive Functions of Metabolites in Plants

### 2.6.1 Sources of Metabolic Energy and Energy Transfer

Without a source of metabolic energy or the ability to transfer the energy obtained from the environment through metabolic pathways, a living organism will die. This is why plants devote so much of their time and energy to the production of pools of compounds that ultimately store the energy of the sun. Plants have several such sources of metabolic energy derived from stored metabolites or from **ATP**. The stored metabolites include starch (universal in green vascular plants), fructan (in grass family [Poaceae], lily family [Liliaceae], amaryllis family [Amaryllidaceae], aster family [Asteraceae], and in other families), other polysaccharides (gums and mucilage), and stored lipids and proteins (as in the fats, oils, and protein bodies of seeds and fruits). Each of these polymers may be broken down by specific enzymes when the need for energy arises, such as during the night when sunlight is not available or during seed germination. The units of these polymers (sugars, amino acids, or acetyl CoA) then enter the mainstream of the plant’s metabolism, where they can once again help produce ATP. ATP is produced in the electron transport cascade during **photosynthetic photophosphorylation** in chloroplasts and **oxidative phosphorylation** in mitochondria.

Plants have evolved two major pathways of photosynthetic carbon fixation (see Buchanan et al., 2000): in **C-3 plants** (which are represented by most plant species), the primary product is phosphoglyceric acid (PGA), which is used for synthesis of 4-, 5-, 6-, and 7-carbon sugars in the **Calvin cycle**. In C-3 plants, typically, 30% of the fixed carbon is lost as carbon dioxide through **photorespiration** (a process that liberates CO<sub>2</sub> and constitutes a significant energetic drain). In contrast, in **C-4 plants** (such as sugarcane, corn, and many fast-growing weeds, such as *Chenopodium album* and *C. rubrum*, as well as *Amaranthus* spp.) the primary products are both the 3-carbon acid, PGA, as well as the 4-carbon acids, malate and aspartate; the former is produced in chloroplasts in leaf mesophyll tissue, whereas the latter are produced in chloroplasts of vascular bundle sheath cells. What is especially interesting is that there is little or no photorespiration in C-4 plants, so that total carbon fixed is, on average, 30% higher than in C-3 plants. The reason for this difference is that in the process of shuttling carbon from mesophyll to bundle sheath cells, a much higher concentration of carbon dioxide is generated in the bundle sheath cells. This elevated CO<sub>2</sub> partial pressure in bundle sheath cells suppresses RUBP (ribulose biphosphate) oxygenation. This is the first step in photorespiration. The enzyme involved here (**RUBISCO**) has both carboxylase and oxygenase catalytic activity. The higher level of CO<sub>2</sub> inhibits this enzyme’s oxygenase activity.

## 2.6.2 Cellular Building Blocks and Structural Support

By **cellular building blocks**, we are referring primarily to the polysaccharides that make up the cell walls of plants — cellulose (a polymer made up of  $\beta$ -1,4-linked glucose units), hemicellulose (glucomanan, xylan, xyloglucan, and mixed linkage —  $\beta$ -1,3-linked and  $\beta$ -1,4-linked glucan), and pectins (polygalacturonans, based on polymers of galacturonic acid coupled to different sugar moieties, such as rhamnose and fucose) (see Dey and Harborne, 1997). As mentioned above, these polysaccharides constitute the majority of all biomass on this planet. Animal cells do not have cell walls; each cell is circumscribed by a plasma membrane alone. It is this structural support provided by cell walls of plants, along with the additional structural support provided by such processes as **lignification** and **silicification** of these cell walls, that turns the plant into a type of scaffold upon which to “hang” its photosynthetic tissues (leaves or stems) in the best possible orientation to absorb carbon dioxide and the energy of the sun. Without this support, terrestrial plants would not be able to support the weight of their leaves, and consequently, the leaves would not achieve optimal exposure to the sun for photosynthesis. Interestingly, many aquatic plants do not have this problem. They are supported in the water by air cavities in their tissues (**aerenchyma**), and usually do not produce additional support compounds such as lignin. In some cases, these cellular building blocks allow for the development of massive plant bodies. This is most dramatically exemplified by coast redwood (*Sequoia sempervirens*) and giant sequoia trees (*Sequoiadendron giganteum*) (see Figure 2.10). Please remember, however, that the other major contributors to the structure of plants and their cells are lipids (especially membrane lipids such as phospholipids) and proteins (such as those in membranes, microtubules, and microfilaments).

## 2.6.3 Sources of Genetic Information

We described the importance of the nucleic acids, DNA and RNA, in the storage and transfer of genetic information for living organisms, including plants (see Chapter 1 and Section 2.4.1). In plant cells, such genetic information resides in their nuclei, chloroplasts, mitochondria, and ribosomes. All of the proteins of the cell, including structural proteins and enzymes, are encoded by these nucleic acids. Most of the proteins synthesized in plant cells are encoded by nuclear DNA; on the other hand, many of the proteins that occur in mitochondria or in chloroplasts are synthesized on ribosomes within these respective organelles. Some of these proteins are structural components of membranes and membrane channels; others are enzymatic. Many proteins that occur in organelles are also coded for by DNA in the nucleus. How do nuclear-encoded proteins find their way to the proper cell organelle? **Signal peptides** (specific amino acid sequences also encoded by DNA) occur on these proteins to target the proteins to the membranes of specific organelles, such as peroxysomes, glyoxysomes, Golgi (dictyosomes), mitochondria, or plastids. Once the protein gets targeted to the proper organelle, it is then transported into the organelle across the membrane(s) enclosing that organelle (this involves different mechanisms for targeting and for transport). In most cases, the signal peptide gets cleaved off by a specific **peptidase** that produces a functional protein that (1) may act as a monomeric enzyme, (2) may become associated with other proteins to form multimeric complexes, or (3) may become a structural component of a membrane. Some proteins exist as **glycoproteins** or as **lipoproteins** that have carbohydrate or lipid components, respectively, attached. These may also be involved in targeting or intercalation of the protein onto the inner or outer surface of a given membrane, such as the **tonoplast** membrane that surrounds the vacuole or the **plasmalemma** that surrounds the cytoplasm and lies just inside the cell wall.

All the information for production, localization, and functionality of every protein is ultimately contained on a strand of DNA. The ability to pass this information onto offspring is one of the key factors that determines if a species of organism will survive in a given environment. The fact that genetic information can change (mutate) over evolutionary time is what allows organisms, in general, to adapt to ever-changing environments. This change (**evolution**) is always occurring and produces new combinations that may or may not work in that environment, but only the individuals that have the combinations that work will survive to the next generation. This variation between individuals is critical to the survival of each species of plant (or animal). Thus, plants have evolved various methods of sexual reproduction, such as pollination, that allow the sharing of genetic information among

individuals of a given species. This holds the benefit of spreading combinations of enzymatic reactions that work throughout a population.

#### 2.6.4 Catalysts of Metabolic Reactions

By now, it has become apparent how important enzymes are in catalyzing metabolic reactions in different compartments of plant cells. These proteins, coded for by the plant's genetic information and placed in the proper locations within cells of tissues held in the correct positions by the plant's cellular building blocks, allow not only the production of, but also, the utilization of the metabolic energy compounds that run the biochemical reactions that control the processes of life. In such reactions, binding of the substrate to the active site of the enzyme to form the **enzyme–substrate complex** is a prerequisite to catalytic action of the enzyme. Enzymes act to lower the amount of free energy required to make a reaction proceed to the formation of the product of the reaction that is released following separation of the enzyme from the enzyme–substrate complex. Without this interaction of enzyme with substrate, the reaction would proceed very slowly or not at all under normal conditions of temperature and pressure. So, **enzymes** act as organic catalysts by speeding up the rate of a given metabolic reaction.

Some of these enzymes act to cause hydrolysis of substrates and are called **hydrolases**, like amylase which hydrolyzes starch, invertase which hydrolyzes sucrose, and fructan hydrolase which hydrolyzes fructan. Other enzymes, called **synthases** or **transferases**, are involved in synthesis, as for example, UDP-glucose transferase that makes cellulose or callose (depending on concentrations of  $Mg^{2+}$  cofactor and substrate concentration) or ADP-glucose transferase that makes starch. Still others are involved in cyclicization reactions and are called **cyclases**. They make linear molecules circular, as in the conversion of GPP to cyclic monoterpenes. In photosynthesis, you remember the substrate, RUBP; it is acted upon by a single enzyme (RUBISCO) that has **carboxylase** as well as **oxygenase** activity connected with photosynthetic carbon fixation from  $CO_2$  and with photorespiration, respectively. There are important enzymes involved in signal transduction processes related to hormone action in plant and animal cells. These include **phosphorylases**, **phosphatases**, and many kinds of **protein kinases**. Then, there are enzymes called **dehydrogenases**, such as mannitol dehydrogenase, which catalyzes the formation of D-mannose from mannitol. **Chaperones** are a group of enzymes that promote the folding of proteins into their correct (i.e., active) forms, hold proteins that are to be transported to organelles in an unfolded form, and help maintain protein integrity during heat stress, and thus, prevent denaturation. These are the main classes of enzymes, but the list goes on.

Finally, we need to mention the concept of **isozymes**. These refer to the same type of enzyme that (1) may exist in different cellular compartments, (2) have different pH optima for the same substrate, or (3) at the molecular level, have different nucleotide sequences for the signal peptides of the enzyme. A good example is **invertase** (a  $\beta$ -fructofuranosidase) that hydrolyzes sucrose to D-glucose and D-fructose. There are several known isozymes of invertase: (1) intracellular soluble invertase located in the cell vacuole, and possibly the cytosol, with pH optima from slightly alkaline (pH 7.5) to acidic (pH 4.5), and (2) insoluble forms ionically bound to the cell wall with pH optima of 4.0 and 5.3 (Sturm and Crispeels, 1990; Jones and Kaufman, 1975).

#### 2.6.5 Deterrence of Predators and Pathogens via Poisons and Venoms

Plants have evolved a vast array of chemical defenses that effectively deter herbivores and pathogens from attacking them. These have obvious selective and survival value for plants because plants are almost always stuck in one spot and thus can fall easy prey to wandering animals out to consume plant nutrients. This brings up several questions: What is the nature of these chemical defense strategies? How do they work? Which came first, the chemical deterrent evolution in different groups of plants or the predator/pathogen-dictated selective pressure for plants to evolve new chemical defense strategies? How effective are human-designed chemical defense strategies, as in transgenic plants, as compared to the multifaceted strategies plants have evolved and continue to evolve to deter predators or pathogens? These questions are addressed in four excellent references (Taiz and Zeiger, 2002; Larcher, 1995; Zipf, 1996; Becerra, 1997).

Here, we will consider some of the more important ways plants defend themselves against attack by insect predators, herbivores, pathogenic fungi, bacteria, and viruses. These methods are based on the classification scheme of Becerra (1997) as follows:

- **Structural defense strategies:** These include lignification, silicification, callose formation, and wax deposition. We alluded to these processes in more detail in the preceding sections of this chapter. The chemical polymers act as a sort of armor and prevent fungi, bacteria, or viruses with a physical barrier through which to penetrate or prevent insects or herbivores a hard surface through which to chew.
- **Chemical defense strategies:** These include almost all compounds that, based on their chemical nature, deter attack. There are many fascinating stories behind the mechanisms of each of these compounds, but let it suffice to say that each of these compounds can interfere (usually in a species-specific manner) with at least one critical biochemical pathway within the attaching organism, thus killing this organism or making it sick. There are literally thousands of examples of chemical defense, including the following:
  - Alkaloids (e.g., nitrogen-containing, heterocyclic ring compounds)
  - Active oxygen species, such as  $H_2O_2$ ,  $O_2$  (superoxide anion), and  $OH$  (hydroxyl radical)
  - Proteins, including cell-wall glycoproteins (hydroxyproline-rich, proline-rich, and glycine-rich glycoproteins); inhibitory proteins (many are induced and include endogenous antiviral proteins, antifungal lipid transfer proteins, antibacterial  $\alpha$ -thionins); lectins (which are carbohydrate-binding proteins); antioomycete pathogenesis-related protein, and antifungal defensin proteins; extracellular hydrolases (e.g., cellulases, pectinases, chitinases, ribonucleases, proteases, and lipid acyl hydrolases such as patatins); and ribosome-inactivating proteins such as trichosanthin in the Chinese cucumber plant, *Trichosanthes kirilowii*
  - Saccharides and polysaccharides, such as callose and pectins, effusive gums, mucilage, cardiac glycosides, cyanogenic glycosides, and glucosides of organic nitrogen-containing compounds consisting of a sugar moiety linked to a cyanide or nitrite, respectively
  - Phenolics and coumarins
  - Polyphenolics, such as suberins, lignins, and tannins (both hydrolyzable and condensed [see Figure 2.30])
  - Flavonoids and isoflavonoids, quinones and isoquinones
  - Terpenoid/steroid compounds, such as cardiac glycosides, leguminous saponins (often glycosylated), gossypiol-related terpenoids, aphid alarm pheromones, brassinosteroids (insect hormone mimicking compounds), and phytoecdysones (insect molting hormone mimics)
  - Cyanide-releasing compounds that release hydrogen cyanide on ingestion and block electron transport during respiration, and include cyanogenic glycosides and the glucosinolates (mustard oil glycosides that release isothiocyanates)
  - Organic acids, including the salts of oxalic acid (as found in aroids such as *Dieffenbachia*, *Symplocarpus*, and *Monstera*, as well as the leaf blades of rhubarb, *Rheum* spp.), monofluoroacetic acid, and L-DOPA (3,4-dihydroxyphenylalanine)
  - Long-chain carbon compounds, such as antimicrobial polyacetylene, antifungal alkenes, antimammalian polyacetylene toxins, and fatty acid/lipid-containing waxes, oils, and cutin

Defense is very diverse and often very complex. It is also important to note that not all toxins act in an acute or immediate manner. Some act as **chronic toxins**, having a noticeable effect only after a long period of time.

There is an interesting connection between tannins and their possible role in deterring attack by the chestnut blight pathogen (*Endothia parasitica*) that has caused the near demise of the American chestnut tree in eastern North America. It was shown by Hebard and Kaufman (1978) that in callus cultures of five clones of chestnut, the callus clones of “resistant” American chestnut trees (*Castanea dentata*) and of resistant chestnuts (*C. crenata* and *C. mollissima*), as compared with susceptible *C. dentata*, had much

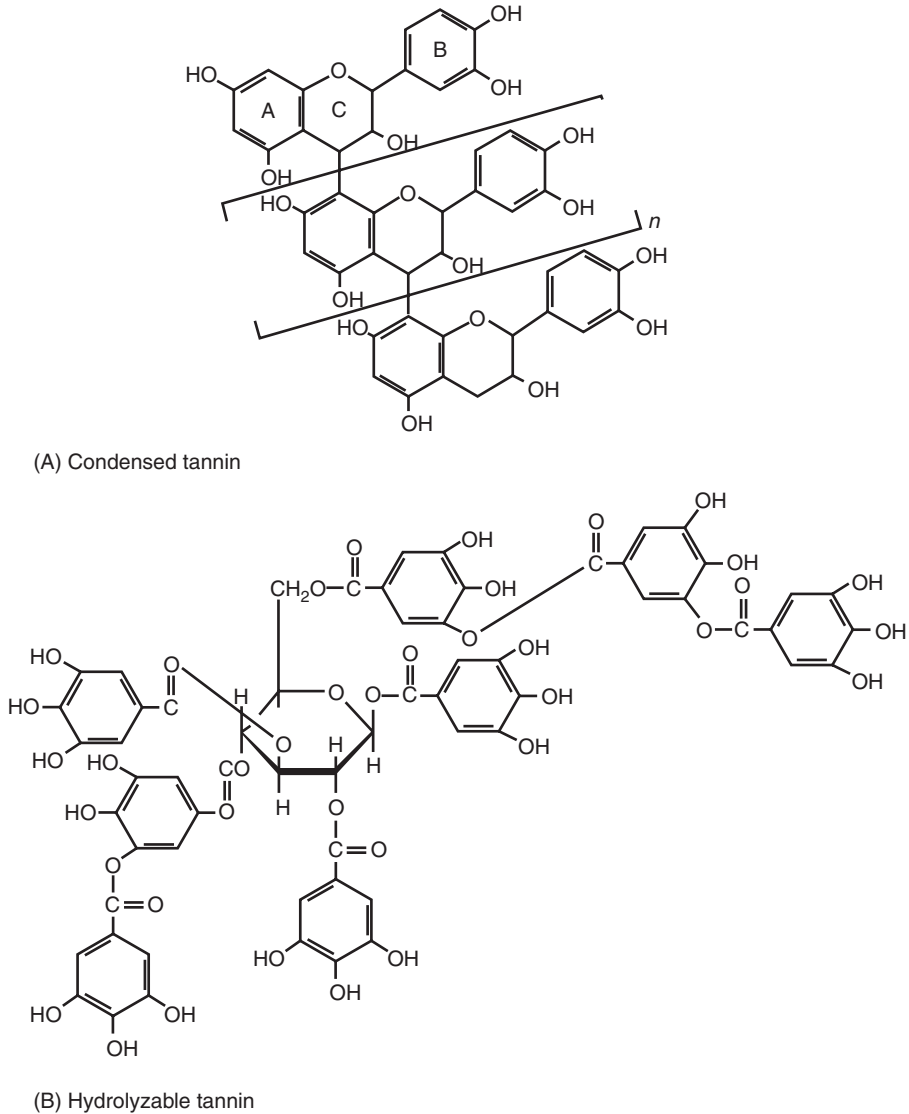

**FIGURE 2.30** Chemical structures of condensed (A) and hydrolyzable (B) tannins.

higher levels of hydrolyzable tannins (galloyl esters and ellagitannins) in clones from resistant trees than in clones from susceptible trees. Challenging the respective callus cultures with virulent strains of the fungal pathogen showed that calli from susceptible chestnuts were overgrown by the pathogen, while calli from resistant strains were not affected and remained healthy. The conclusion from these findings is that the levels of hydrolyzable tannins in chestnut trees are correlated with resistance to the American chestnut blight fungal pathogen, but the correlation does not prove that condensed tannins are responsible for resistance to the pathogen either in culture or in chestnut trees. A question to ponder is this: What experiments are necessary to show this kind of proof? (Hint: one must find a way to prevent the synthesis of tannins in cells that normally produce them.)

## 2.6.6 Attraction and Deterrence of Pollinators

As with the example of linalool production in *Clarkia breweri* plants seen in Section 2.5.2, many species of flowering plants have evolved the ability to produce various compounds that appeal to the visual,

TABLE 2.5

Chemical Basis of Flower Color in Angiosperms (Flowering Plants)

Color	Pigments Responsible	Examples
White, ivory, cream	Flavones (e.g., luteolin) or flavonols (e.g., quercetin)	95% of white flowered spp.
Yellow	Carotenoid alone	Majority of yellows
	Yellow flavonol alone	<i>Primula, Gossypium</i>
	Anthochlor alone	<i>Linaria, Oxalis, Dahlia</i>
	Carotenoid + yellow flavonoid	<i>Coreopsis, Rudbeckia</i>
Orange	Carotenoid alone	<i>Calendula, Lilium</i>
	Pelargonidin + aurone	<i>Antirrhinum</i>
Scarlet	Pure pelargonidin	Many, including <i>Salvia</i>
	Cyanidin + carotenoid	<i>Tulipa</i>
Brown	Cyanidin on carotenoid background	<i>Cheiranthus</i> , many <i>Orchidaceae</i>
Magenta, crimson	Pure cyanidin	Most reds, including <i>Rosa</i>
Pink	Pure peonidin	Peony, <i>Rosa rugosa</i>
Mauve, violet	Pure delphinidin	Many, including <i>Verbena</i>
Blue	Cyanidin + copigment/metal	<i>Centaurea</i>
	Delphinidin + copigment/metal	Most blues, <i>Gentiana</i>
Black (purple black)	Delphinidin at high concentration	Black tulip, pansy
Green	Chlorophylls	<i>Helleborus</i>

olfactory, and taste senses of insects or animals. Because many flowering plants are strictly dependent on a mobile organism to visit its flowers and pass its pollen to another plant of the same species, there is a distinct adaptive advantage to the plant that can attract a pollinator that will visit the same plant species over and over, rather than spread pollen around at random. One must remember that the pollinators are also evolving the ability to distinguish the plant species that provide the best rewards (food) over those that do not. This is in their best interest. A system of reward plays a critical role in the plant's pollination success.

Attraction of pollinators to flowers is achieved by several mechanisms. As discussed in Section 2.4.9 and Section 2.4.10, coloration is a critical factor for attracting insects and animals that come out during the day. The color of flowers may be due to carotenoids in biomembranes (as in chromoplast membranes); brown phlobaphenes and black melanins in the cell walls; or red, yellow, pink, blue, and deep violet flavonoids, betacyanins, and betaxanthines in the cell vacuole (Table 2.5).

Many of these colors are dependent on possible complexes with  $\text{Fe}^{3+}$  and  $\text{Al}^{3+}$  as well as on pH. Different pollinators are attracted to different colors (Table 2.6). Birds are generally attracted to red. Moths are attracted to white or light yellow flowers, because these flowers are more visible at night when the moths are active. Flies prefer greens and browns. Butterflies tend to visit brightly colored flowers — yellow, blue, reddish — while bees prefer yellow and blue. Bees do not usually visit red flowers. This is most likely due to the fact that a bee's spectrum of vision includes very little red. It is shifted toward the ultraviolet range. Consequently, bees preferentially pollinate flowers that produce ultraviolet nectar guides (usually present on petals) that are invisible to the human eye and are the result

TABLE 2.6

Color Preferences of Different Pollinators

Animal	Flower Color Preferences	Comments
Bats	White or drab colors, e.g., greens and pale purples	Mostly color blind
Bees	Yellow and blue intense colors, also white	Can see in UV, but not sensitive to red
Beetles	Dull, cream, or greenish color	Poor color sense
Birds	Vivid scarlets, also bicolors (red–yellow)	Sensitive to red
Butterflies (Lepidoptera)	Vivid colors, including reds and purples	—
Moths (Heterocera)	Reds and purples, white, or pinks	Mostly pollinate at night
Flies	Dull, brown, purple, or green	Checkered pattern may be present
Wasps	Browns	—

of the biosynthesis of specific phenolic compounds (certain flavonoids) in specific patterns that are apparently discernible to different insects.

Odoriferous substances that attract insects, birds, and mammals to flowers are usually produced as soon as the flower opens and help potential pollinators find the flower during the day and at night. These compounds include **monoterpenes** (e.g., linalool, limonene, geraniol), **sesquiterpenes** (e.g.,  $\beta$ -ionone and  $\alpha$ -(-)-bisabolol), **aromatics** (e.g., vanillin, eugenol, methyl eugenol), **aliphatics** (e.g., pentadecane, *i*-octanol), **monoamines** (e.g., methylamine, ethylamine, propylamine, butylamine, amylamine, hexylamine), **diamines** (e.g., putrescine and cadaverine), and **indoles** (e.g., indole and skatole). The various amines and indoles just listed have unpleasant odors and attract pollinators, such as flies and fungal gnats. Some plants, such as Skunk Cabbage (*Symplocarpus foetidus*) and Voodoo Lily (*Sauromatum guttatum*), benefit from photorespiration, because while the plant loses stored energy, it creates heat, which better volatilizes the amines, allowing them to be released more quickly and with a stronger odor (Mauseth, 2003). The other compounds, in general, produce pleasant odors that attract pollinators such as bees, butterflies, moths, and bats. The chemical attractants may be produced in special scent glands (called **osmophores**) produced by various organs of flowers, by epidermal cells along the upper sides of the petals, or, in some cases, by glandular hairs on leaves. Excellent discussions of these different pollination-attractant syndromes are found in Larcher (1995) and Harborne (1998). As mentioned in Section 2.5.2, the mixture of these chemicals produced by flowers permits insects to distinguish between different species of plants, but there can be one specific scent component that determines which pollinator will pollinate a specific species of plant.

The rewards for pollination in plant flowers usually come in the form of sugar-rich solutions (sucrose, D-fructose, and D-glucose are the most common) that are secreted into the **nectaries** of flowers. They act in much the same way that the sugars, fats, and proteins found in mature fruits act to reward animals to disperse plant seeds (good examples here include squirrels that “forget” where they buried the acorn and birds that spread seeds all over your freshly washed car). Nectaries are located in different locations in different species, but they are almost always located at the junction between two different flower organs, such as petals and ovary. The nectar held in the nectaries is not usually just sugar and water. It may also contain pigments such as anthocyanins, scents such as monoterpenes, and in some cases, toxins.

Some compounds in flowers that are known to attract certain pollinators can also repel potential pollinators. Indole, for example, can deter bees from pollinating alfalfa (*Medicago sativa*) flowers (Raguso, 1997). Skatole, monoamines, and the offensive-smelling diamines (putrescine and cadaverine) seem to serve similar functions in other flowers. Why would a plant “want” to repel a potential pollinator? The answer may lie in the fact that some insects and animals can cue in on plant attractants (odor, for example) and take the reward produced by that plant without dispersing the plant’s pollen. To repel such a visitor would save the plant’s energy in producing rewards. So, flowering plants undergo distinct selective pressures to produce the specific compounds that will attract the best pollinators living in a specific environment.

### 2.6.7 Allelopathic Action

**Allelopathy** refers to plants that give off chemical substances that are injurious to other plants or prevent other plants from becoming established in the vicinity of the plant that gives off the allelopathic chemicals (also called **allomones**) (Larcher, 1995). Such chemicals have an obvious advantage to the plant that produces them by preventing the growth of other plant species that may compete for soil nutrients, carbon dioxide, or sunlight. **Allelopathic chemicals** include short-chain fatty acids, essential oils, phenolic compounds, alkaloids, steroids, and derivatives of coumarin. A classic example is the compound naphthalene glucoside, produced by leaves and roots of walnut (*Juglans* spp.). This compound is not allelopathic; it must undergo hydrolysis and oxidation by soil microorganisms to produce hydrojuglone, and finally, the active compound, **juglone**. Juglone prevents the germination of seeds of many, but not all, plant species. This is why it is a bad idea to plant a wildflower garden in the same area as walnut trees. Another good example is the release of carboxyphenolic acids and hydroxycinnamic acids by heath family (Ericaceae) members that grow in such places as Scotland. Scotland was once covered with pine trees, but it was stripped to provide fuel for the growing industrial revolution. Now there is a



problem with attempts at reforestation, because the heath plants inhibit the association of mycorrhizal fungi with young pine roots. These fungi are essential symbionts for pines (see Section 2.6.8). The seedlings eventually die. There are many more examples, including cases with *Calluna* (a heather) and *Arctostaphylos uva-ursi* (bearberry) that inhibit the growth of grasses (Poaceae family) and herbs; the release of terpenes and water-soluble phenolics by plants that inhabit steppes and arid shrub communities (*Parthenium* or guayule, *Encelia*, and *Artemisia* or sagebrush in the Asteraceae family and members of the Lamiaceae, Myrtaceae, Rutaceae, and Rosaceae families); and the release of orcinol depsides and usnic acid by **lichens** (plants that have algal and fungal partners living in association mutualistically) that exert an alleopathic effect on conifer seedlings and have an antibiotic effect on fungi, which again may be symbionts.

### 2.6.8 Attraction of Symbionts

Not all plants are capable of getting enough nutrients out of the soils in which they live. Bacteria and fungi are sometimes much better at absorbing and producing some of the nutrients that plants require. Consequently, it is often the case that plants will form a partnership between themselves and specific bacterial or fungal symbionts. A classic case illustrating this concept is that of the establishment of a mutualistic association between a host plant and **rhizobia nitrogen-fixing bacteria** (see Buchanan et al., 2000). The bacteria become associated with the roots of the host plants and trigger the formation of nodules that provide the bacteria with a safe place to live (as well as some plant nutrients and water) while they supply the host plant with reduced nitrogen in the form of  $\text{NH}_4^+$  that is derived from atmospheric nitrogen,  $\text{N}_2$ . The reduced nitrogen is then used by the plant for synthesis of amino acids via **amination reactions**. At the start of this scenario, flavonoids were synthesized in significant amounts within the root systems of leguminous plants (e.g., the isoflavonoid, **daidzein**, in soybean, *Glycine max*; and the flavonoid, **luteolin**, in clovers, *Trifolium* spp.). These flavonoids play a key role in the establishment of the infection of host roots by nitrogen-fixing bacteria, signaling the bacteria to bind to the plant roots after recognition of specific factors contained in the root glycocalyx (see Section 2.4.7). During the infection process, the flavonoids produced by the host plant upregulate the expression of so-called **nod genes** in the bacterial cells. These **nod genes** are required for three key steps in the infection process: (1) synthesis of a lipooligosaccharide molecule that induces root hair curling (**root hairs** are the sites for entry of the bacteria into the host root system); (2) formation of an **infection thread** of bacterial cells in the host root hairs (this thread allows the bacteria into the plant tissue); and (3) the cell divisions in root cortical cells that give rise to root nodules.

Plants other than legumes can develop symbiotic relationships with nitrogen-fixing organisms. The deciduous tree alder (*Alnus* spp.) can produce similar nodules upon infection. Grasses can form associations with soil bacteria, but they do not produce root nodules. Here, the bacteria seem to be anchored to the root surfaces. Fungi are also elicited for nutritional help. As mentioned, this is common in pine trees, which require an interaction with **mycorrhizal fungi**. **Mycorrhizae** are symbiotic and mutualistic relationships between fungi and terrestrial plant roots. Mycorrhizae are also critical to the terrestrial ecosystems because approximately 85% of all plant species form and are dependent on mycorrhizae. For example, it was estimated that mycorrhizae fix more nitrogen than the worldwide chemical fertilizer industry. During these plant–fungal interactions, the fungus takes over the role of the plant’s root hairs and acts as an extension of the root system. Once the symbiosis is established, both the plant and fungus benefit. The plant benefits from increased nutrient absorption (increased phosphorus and nitrogen uptake, increased micronutrients and water uptake, and sometimes increased resistance to root pathogens). The fungus benefits from the carbohydrates (sugars) and growth factors donated by the plant. (See Figure 2.31.)

**Mycorrhizal plants** often display higher tolerance to heavy metal toxicity, high soil temperatures, and various soil pathogens. There are two major classifications of mycorrhizae: (1) **ectomycorrhizae (ECM)** form an association with tree roots in which the fungus is located outside of the root, while (2) **arbuscular mycorrhizae (AM)** form an association with terrestrial plants in which the fungus is located inside the root. Because mycorrhizae are always beneficial to the growth of a plant, their potential use to humans in agriculture, horticulture, and forestry is immense. Each of these examples (including the bacterial examples described above) has its own series of communicational signaling events between



**FIGURE 2.31** (See color insert following page 256.) (Left) Aspen tree growth is significantly altered through interaction with *Laccaria bicolor*. The Aspen tree on the left is growing without mycorrhizal symbiosis and suffers from stunted growth. The Aspen tree on the right is growing with mycorrhizal symbiosis, and its growth is greatly enhanced. (Right) Ectomycorrhizae of a fungus and a tree root. The roots have a sheath/mantle of fungal tissue that makes the root appear to be swollen with stubby ends. The root is also surrounded by extraradical mycelium, which is seen as fuzzy extensions (arrow).

the plant and its specific symbiont. Currently, we know little about the signaling and genetics of mycorrhizal formation in plants.

### 2.6.9 Food for Pollinators, Symbionts, Herbivores, Pathogens, and Decomposers

We must say something about the adaptive value of plant metabolites to other organisms. As we emphasized throughout this chapter, plants' ability to fix carbon from  $\text{CO}_2$  into more complex storage forms of metabolic energy makes plants crucial to the survival of all other organisms, including humans. Plants provide organisms with most of the food necessary for their growth and reproduction. Witness the following examples:

- Pollinators foraging in flowers to find food rewards in the form of sugars produced in nectaries located near the sites of insertion of the floral organs
- Other pollinators, for example, the blastophaga wasp in fig fruits (synconia), that lay their eggs inside the developing fruit and whose larvae hatch out to use the inside portion of the fleshy fruit as a food source before they metamorphose into adult wasps
- Symbiotic associations that benefit bacteria or fungi as well as the plant, e.g., algal/fungal partners in lichens, nitrogen-fixing bacteria in nodules of leguminous and other plants, nitrogen-fixing blue-green algae, such as *Nostoc* and *Anabaena* in fronds of ferns such as *Azolla* spp.
- Birds that devour whole fruits and regurgitate the flesh to their young while dispersing seeds along the way
- Cows grazing on grasslands and later providing milk, which builds strong bones in human offspring
- Fungal and bacterial pathogens that invade plant cells and cause all sorts of plant diseases, including blights
- Shelf fungi, edible and toxic mushrooms, slime molds, and soil bacteria that feed off the plants even after the plants have long ceased to fix carbon

This is only the very beginning of the diversity that we see due to the food supplied by plants.

---

## 2.7 Conclusions

Plants synthesize thousands of metabolites that are used for their growth and development, reproduction, defense against attack by many different kinds of organisms, and survival in often harsh and ever-

changing environments. It all starts with photosynthetic carbon fixation using carbon dioxide and energy supplied by the sun. The synthesis of the various metabolites proceeds along metabolic pathways located in one or more cell compartments (e.g., cell walls, membrane systems, the cytosol, and various cellular organelles) within tissues that are often specialized for particular tasks. Most metabolites produced by these pathways never leave the plant, but occasionally, plant compounds, some of which attract and some of which repel, are the basis for a complex type of communication between plants and animals. The specific enzymes that catalyze the respective steps in each metabolic pathway are encoded in nuclear, chloroplast, and mitochondrial genomes by specific genes. We will explore in the next chapter what factors influence the expression and regulation of these genes.

---

## References

- Bartley, G.E. and P.A. Scolnik. (1995). Plant carotenoids: pigments for photoprotection, visual attraction, and human health. *The Plant Cell* 7: 1027–1038.
- Beale, S.I. (2005). Green genes gleaned. *TRENDS in Plant Sci* 10: 309–312.
- Becerra, J.X. (1997). Insects on plants: macroevolutionary chemical trends in host use. *Science* 276: 253–256.
- Bercovitch, M., A. Waller, and A. Adunsky. (1999). High dose morphine use in the hospice setting. A database survey of patient characteristics and effect on life expectancy. *Cancer* 86: 871–877.
- Britton, G. (1995). Structure and properties of carotenoids in relation to function. *FASEB J* 9:1551–1558. See also: The importance of the pigments of life. <http://www.unine.ch/chim/ecsoc-3/introduction.html>.
- Bruice, P.Y. (2004). *Organic Chemistry*, 4th ed., chap. 26. Prentice Hall, Upper Saddle River, New Jersey.
- Buchanan, B.B., W. Gruissem, and R.L. Jones. (2000). *Biochemistry and Molecular Biology of Plants*. American Society of Plant Physiologists (now, American Society of Plant Biologists), Rockville, Maryland.
- Burbulis, I.E., M. Iacobucci, and B.W. Shirley. (1996). A null mutation in the first enzyme of flavonoid biosynthesis does not affect male fertility in *Arabidopsis*. *The Plant Cell* 8: 1013–1025.
- Cellárová, E., K. Kimakova, Z. Daxnerova, and P. Martonfi. (1995). *Hypericum perforatum* (St. John's Wort): *In vitro* culture and production of hypericin and other secondary metabolites. In *Biotechnology in Agriculture and Forestry*. Vol. 33, *Medicinal and Aromatic Plants VIII*, Y.P. Bajaj (Ed.). Springer-Verlag, Heidelberg, pp. 261–275.
- Chang, P., J. Cary, J. Yu, D. Bhatnagar, and T. Cleveland. (1995). The *Aspergillus parasiticus* polyketide synthase gene *pksA*, a homolog of *Aspergillus nidulans* *wA*, is required for aflatoxin B-1 biosynthesis. *Mol Gen Genet* 248: 270–277.
- Croteau, R. and F. Karp. (1991). Origin of natural odorants. In *Perfume: Art, Science and Technology*, P. Muller and D. Lamparsky (Ed.). Elsevier Applied Sciences, New York, pp. 101–126.
- Croteau, R. and J.N. Winters. (1982). Demonstration of the intercellular compartmentation of *l*-menthone metabolism in peppermint (*Mentha piperita*) leaves. *Plant Physiol* 69: 975–977.
- Crowell, A.L., D.C. Williams, E.M. Davis, M.R. Wildung, and R. Croteau. (2002). Molecular cloning and characterization of a new linalool synthase. *Arch Biochem Biophys* 405: 112–121.
- Cseke, L., N. Dudareva, and E. Pichersky. (1998). Structure and evolution of linalool synthase. *Mol Biol Evol* 15: 1491–1498.
- Delmer, D.P. (1999). Cellulose biosynthesis: exciting times for a difficult field of study. *Ann Rev Plant Physiol and Plant Mol Biol* 50: 245–276.
- Delmer, D.P. and Y. Amor. (1995). Cellulose biosynthesis. *The Plant Cell* 7: 987–1000.
- Dey, P.M. and J.B. Harborne. (1997). *Plant Biochemistry*. Academic Press, London.
- Dixon, R.A., L. Achnine, P.I. Kota, C.-J. Liu, M.S.S. Reddy, and L. Wang. (2002). The phenylpropanoid pathway and plant defence — a genomics perspective. *Mol Plant Pathol* 3: 371–390.
- Dodson, C., R. Dressler, H. Hills, R. Adams, and N. Williams. (1969). Biologically active compounds in orchid fragrances. *Science* 164: 1243–1249.
- Dodson, H.E.M. (1993). Floral volatiles in insect biology, In *Insect-Plant Interaction*, Vol. V, E. Bernays (Ed.). CRC Press, Boca Raton, Florida, pp. 47–81.

- Dubey, V.S., R. Bhalla, and R. Luthra. (2003). An overview of the non-mevalonate pathway for terpenoid biosynthesis in plants. *J Biosci* 28: 637–646. <http://www.ias.ac.in/jbiosci/sep2003/637.pdf>.
- Dudareva, N., L. Cseke, M.B. Blanc, and E. Pichersky. (1996). Evolution of floral scent in *Clarkia*: novel patterns of *S*-linalool synthase gene expression in the *C. breweri* flower. *The Plant Cell* 8: 1137–1148.
- Eckerman, S., G. Schröder, J. Schmidt, D. Strack, R.A. Erada, Y. Helariutta, P. Elomas, M. Kotilainen, I. Kilpeläinen, P. Proksch, T.H. Teeri, and J. Schröder. (1998). New pathway to polyketides in plants. *Nature* 396: 387–390.
- Edelman, J. and T.G. Jefford. (1968). The mechanism of fructosan metabolism in higher plants as exemplified in *Helianthus tuberosus* L. *New Phytol* 67: 517–531.
- Eisenreich, W., A. Bacher, D. Arigoni, and F. Rohdich. (2004). Biosynthesis of isoprenoids via the non-mevalonate pathway. *Cell Mol Life Sci* 61:1401–1426.
- Eisenreich, W., M. Schwarz, A. Cartayrade, D. Arigoin, M.H. Zenk, and A. Bacher. (1998). The deoxylulose phosphate pathway of terpenoid biosynthesis in plants and microorganisms. *Chem Biol* 5: R221–R233.
- Esau, K. (1965). *Plant Anatomy*, 2nd ed. John Wiley & Sons, New York.
- Funk, C., E. Lewinsohn, B. Stofer Vogel, C.L. Steele, and R. Croteau. (1994). Regulation of oleoresinosis in grand fir (*Abies grandis*): coordinate induction of monoterpene and diterpene cyclases and two cytochrome P450-dependent diterpenoid hydroxylases by stem wounding. *Plant Physiol* 106: 999–1005.
- Galen, C. (1985). Regulation of seed set in *Polemonium viscosum*: floral scents, pollination and resources. *Ecology* 66: 792–797.
- Galen, C. and P. Kevan. (1983). Bumblebee foraging and floral scent dimorphism: *Bombus kirbyellus* and *Polemonium viscosum*. *Can J Zool* 61: 1207–1213.
- Hampel, D., A. Mosandl, and M. Wüst. (2005). Biosynthesis of mono- and sesquiterpenes in carrot roots and leaves (*Daucus carota* L.): metabolic cross talk of cytosolic mevalonate and plastidial methylerythritol phosphate pathways. *Phytochemistry* 66: 305–311.
- Hanson, D.J., P. Dayanandan, P.B. Kaufman, and J.D. Brotherson. (1976). Ecological adaptations of saltmarsh grass, *Distichlis spicata* (Gramineae), and environmental factors affecting its growth and distribution. *Amer J Bot* 63: 635–650.
- Harborne, J.B. (1988). *Introduction to Ecological Biochemistry*, 3rd ed. Academic Press, New York.
- Hebard, F.V. and P.B. Kaufman. (1978). Chestnut callus-cultures: tannin content and colonization by *Endothia parasitica*. In *Proceedings of the American Chestnut Symposium*, J. McDonald, Ed., Morgantown, West Virginia, pp. 63–70.
- Hendrickson, L., C.R. Davis, C. Roach, D.K. Nguyen, T. Aldrich, P.C. McAda, and C.D. Reeves. (1999). Lovastatin biosynthesis in *Aspergillus terreus*: characterization of blocked mutants, enzyme activities, and a multifunctional polyketide synthase gene. *Chem and Biol* 6: 429–439.
- Herbert, R.B. (2003). The biosynthesis of plant alkaloids and nitrogenous microbial metabolites. *Nat Prod Rep* 20: 494–508.
- Holton, T.A. and E.C. Cornish. (1995). Genetics and biochemistry of anthocyanin biosynthesis. *The Plant Cell* 7: 1071–1083.
- Hopkins, W.G. and N.P.A. Hüner. (2004). *Introduction to Plant Physiology*. 3rd ed. John Wiley & Sons, New York.
- Hopwood, D.A. (1997). Genetic contribution to understanding polyketide synthases. *Chem Rev* 97: 2465–2497.
- Johnson, M. and R. Croteau. (1987). Biochemistry of conifer resistance to bark beetles and their fungal symbionts. In *Ecology and Metabolism of Plant Lipids*, G. Fuller and W.D. Nes (Eds.). ACS Symposium Series 325, American Chemical Society, Washington, D.C., pp. 76–91.
- Jones, R.A. and P.B. Kaufman. (1975). Multiple forms of invertase in developing oat internodes. *Plant Physiol* 55: 114–119.
- Kaufman, P.B., P. Dayanandan, Y. Takeoka, W.C. Bigelow, J.D. Jones, and R. Iler. (1983). Silica in shoots of higher plants. In *Silicon and Siliceous Structures in Biological Systems*, T. Simpson and B.E. Volcani (Eds.). Springer-Verlag, Heidelberg, pp. 409–499.
- Kaufman, P.B., L.-L. Wu, T.G. Brock, and D. Kim. (1995). Hormones and the orientation of growth. In *Plant Hormones, Physiology, Biochemistry and Molecular Biology*, P.J. Davies (Ed.). Kluwer Academic, Dordrecht, pp. 547–571.
- Khosla, C., R.S. Gokhale, J.R. Jacobsen, and D.E. Cane. (1999). Tolerance and specificity of polyketide synthases. *Annu Rev Biochem* 68: 219–253.

- Kirakosyan, A., T.M. Sirvent, D.M. Gibson, and P.B. Kaufman. (2004). The production of hypericins and hyperforin by *in vitro* cultures of St. John's wort (*Hypericum perforatum*). *Biotechnol Appl Biochem* 39: 71–81.
- Koes, R., W. Verweij, and F. Quattrocchio. (2005). Flavonoids: a colorful model for the regulation and evolution of biochemical pathways. *Trends in Plant Sci* 10: 236–242.
- Kuzuyama, T. (2002). Mevalonate and nonmevalonate pathways for the biosynthesis of isoprene units. *Biosci Biotechnol Biochem* 66: 1619–1627.
- Larcher, W. (1995). Ecophysiology and stress physiology of functional groups. In *Physiological Plant Ecology*, 3rd ed., W. Larcher, Ed., Springer-Verlag, New York, pp. 19–31.
- MacSwain, J., P. Raven, and R. Thorp. (1973). Comparative behavior of bees and Onagraceae. IV. *Clarkia* bees of the western United States. *Univ Calif Publ Entomol* 70: 1–80.
- Martin, C. and A.M. Smith. (1995). Starch biosynthesis. *The Plant Cell* 7: 971–985.
- Mauseth, J.D. (2003). *Botany. An Introduction to Plant Biology*. Jones and Bartlett, Sudbury, Massachusetts.
- McGarvey, D.J. and R. Croteau. (1995). Terpenoid metabolism. *The Plant Cell* 7: 1015–1026.
- Michael, J. (2004). Quinoline, quinazoline, and acridone alkaloids. *Nat Prod Rep* 21: 650–668.
- Michael, J.P. (2003). Indolizidine and quinolizidine alkaloids. *Nat Prod Rep* 20: 458–475.
- O'Hagan, D. (1995). Biosynthesis of fatty acid and polyketide metabolites. *Nat Prod Rep* 12:1–32.
- Pellmyr, O. (1986). Three pollination morphs in *Cimicifuga simplex*: incipient speciation due to inferiority in competition. *Oecologia* 78: 304–307.
- Pichersky, E., E. Lewinsohn, and R. Croteau. (1995). *S*-linalool synthase from *Clarkia* flowers: purification and characterization. *Arch Biochem Biophys* 316: 803–807.
- Pichersky, E., R.A. Raguso, E. Lewinsohn, and R. Croteau. (1994). Flower scent production in *Clarkia* (*Onagraceae*). I. Localization and modulation of emission of monoterpenes and of linalool synthase activity. *Plant Physiol* 106: 1533–1540.
- Raguso, R.A. (1997). Personal communication.
- Raguso, R.A. and E. Pichersky. (1995). Floral volatiles from *Clarkia breweri* and *C. concinna* (*Onagraceae*): recent evolution of floral scent and moth pollination. *Plant System Evol* 194: 55–67.
- Raguso, R.A., D.M. Light, and E. Pichersky. (1996). Electroantennogram responses of *Hyles lineata* (Sphingidae: Lepidoptera) to volatile compounds from *Clarkia breweri* (*Onagraceae*) and other moth-pollinated flowers. *J Chem Ecol* 22: 1735–1766.
- Robinson, T. (1991). *The Organic Constituents of Higher Plants*. Cordus Press, North Amherst, Massachusetts.
- Shen, B. (2000). Biosynthesis of aromatic polyketides. *Top Curr Chem* 209: 1–51.
- Smith, A.G. and M. Witty. (2002). *Heme, Chlorophyll, and Bilins: Methods and Protocol*. Humana Press, Totowa, New Jersey.
- Sturm, A. and M.J. Crispeels. (1990). cDNA cloning of carrot extracellular  $\beta$ -fructosidase and its expression in response to wounding and bacterial infection. *The Plant Cell* 2: 1107–1119.
- Suzuki, M. and N.J. Chatterton. (1993). *Science and Technology of Fructans*. CRC Press, Boca Raton, Florida.
- Taber, D.F., T.D. Neubert, and A.L. Rheingold. (2002). Synthesis of (-)-morphine. *J Am Chem Soc* 124: 12416–12417.
- Taiz, L. and E. Zeiger. (2002). *Plant Physiology*, 3rd ed. Sinauer Associates, Sunderland, Massachusetts.
- Torsell, K.B.G. (1997). *Natural Product Chemistry: A Mechanistic, Biosynthetic and Ecological Approach*, 2nd ed. Swedish Pharmaceutical Press, Stockholm.
- Von Wettstein, D., S. Gough, and C.G. Kannangara. (1995). Chlorophyll biosynthesis. *The Plant Cell* 7: 1039–1057.
- Weinberg, B. and B. Bealer. (2002). *The World of Caffeine: The Science and Culture of the World's Most Popular Drug*. Routledge, New York.
- Whetten, R. and R. Sederoff. (1995). Lignin biosynthesis. *The Plant Cell* 7: 1001–1013.
- Williams, C.A. and R.J. Grayer. (2004). Anthocyanins and other flavonoids. *Nat Prod Rep* 21: 539–573.
- Zipf, A. (1996). Plant defenses and defensive compounds. *Plant Growth Regul Soc Amer Quart* 24: 188–200.

# 3

---

## *Regulation of Metabolite Synthesis in Plants*

---

Leland J. Cseke and Peter B. Kaufman

### CONTENTS

3.1	Introduction .....	101
3.2	Regulation by Environmental Stresses .....	102
3.3	Regulation by Biotic Stresses .....	109
3.4	Biochemical Regulation .....	110
3.4.1	Metabolite Feeds and Radioactive Precursors .....	110
3.4.2	Substrate Activation .....	110
3.4.3	Enzyme Activity Regulation by Protein Phosphorylation/Dephosphorylation and Cytosolic Calcium in Signal Transduction Pathways .....	110
3.4.4	Regulation by Acetylation, Prenylation, and Glycosylation .....	111
3.4.5	Activation with Fungal Elicitors and Plant Growth Regulators .....	112
3.4.6	End-Product Inhibition .....	113
3.4.7	Direct Inhibition of Enzyme Activity .....	113
3.5	Molecular Regulation .....	113
3.5.1	Regulation of Gene Expression in Plants Occurs on Many Levels .....	113
3.5.2	How Plant Genes Are Turned On and Off .....	114
3.5.3	Transcription Factors Involved in Pathway Regulation .....	116
3.5.4	Gene Silencing by RNAi .....	120
3.6	Role of Biologically Active Molecules in Plant Growth and Development .....	121
3.6.1	Flavonoids as Endogenous Regulators of Plant Metabolite Biosynthesis .....	121
3.6.2	Elicitor Molecules as Exogenous Regulators of Plant Metabolite Biosynthesis .....	121
3.6.3	Plant Hormones as Endogenous Regulators of Plant Metabolite Biosynthesis .....	122
3.7	Conclusions .....	133
	References .....	134

---

### 3.1 Introduction

In Chapter 2, we pointed out the importance of knowing the sequence of substrates and the respective enzymes involved in the biochemical pathways that lead to the synthesis of given metabolites in plants. Now, we need to consider the primary known environmental, biochemical, and molecular mechanisms that upregulate or downregulate the expression of genes and enzymes that control the synthesis of these metabolites. Such information will help us understand how plants respond to environmental and biotic stresses affecting their survival and show how plant metabolism can be altered to favor the synthesis of a particular metabolite of medicinal or economic value. First, we will explore how metabolite biosynthesis is increased or decreased by environmental and biotic stresses.



**FIGURE 3.1** Author, Peter Kaufman, standing in a plantation of tree of joy (*Camptotheca accuminata*) trees planted in southern Louisiana at the Citrus Experiment Station, located near Port Sulfur, LA, as part of a research project sponsored by the Agricultural Experiment Station of the Louisiana State University at Baton Rouge, LA, and Xylo Med Research, Inc. (Photo provided by Tracy Moore, President of Xylo Med Research, Inc.)

---

## 3.2 Regulation by Environmental Stresses

A host of environmental factors is involved in the regulation of metabolite biosynthesis in plants. The need for this control of synthesis stems from the fact that plants must be able to adjust the production of metabolites according to changing factors if they are to survive. Light is obviously a key factor in the ultimate production of many compounds, because it supplies the energy needed to fix carbon. It is also more directly necessary for the biosynthesis of compounds, such as chlorophylls, as mentioned in Chapter 2. Here, photons trigger the enzymatic conversion of protochlorophyllide and phytol to chlorophylls *a* and *b* and, hence, to chlorophyll–protein complexes in chloroplasts (Mohr and Schopfer, 1995). Light also catalyzes the synthesis of anthocyanin pigment, via the plant pigment **phytochrome**, in many tissues of many plants, such as cotyledon (seed leaf) epidermal cells and hypocotyl (stem portion below the cotyledons) subepidermal cells in mustard seedlings (Mohr and Schopfer, 1995). Light intensity plays an important role in the biosynthesis of medicinally important metabolites. An excellent case in point is the **tree of joy** (*Camptotheca accuminata*) (Figure 3.1), where levels of the antiprostata cancer drug, **camptothecin** (an alkaloid metabolite), significantly increase as the amount of light reaching the tops of the plants decreases.

Temperature is another important factor that regulates plant metabolism. At reduced temperatures around 0°C, most enzymes are inactive, but as the temperature increases, the rate of enzyme activity increases up to about 40°C, above which most plant enzymes become inactivated and even permanently damaged. Many enzymes are always present in plant cells at a certain level, but specific temperatures can trigger a dramatic change in these levels. For example, levels of **heat shock proteins (HSPs)**, constitutively present as chaperones, rapidly increase at temperatures of 40°C and above for most organisms. At this point, HSPs act to help repair enzymes that may have been damaged due to the excess heat. Please note that not all organisms have enzymes that are only active between the temperatures of 0 and 40°C. Some **thermophilic bacteria**, for example, thrive at high temperatures in excess of 95°C (O'Brien, 1996).

Carbon dioxide gas is the fundamental carbon source for all plant metabolites (see Figure 2.1). Its levels can vary depending on the environment, and this variation causes changes in biosynthetic output. For example, elevated carbon dioxide levels in the earth's atmosphere due to increased burning of fossil fuels and burning of tropical rainforests worldwide, together with elevated temperatures (**global warming**) due to elevated levels of **greenhouse gases** are currently causing increases in total photosynthate produced in temperate-zone plants (Teeri, 1997). This is especially true for plants with C-4 photosynthesis. These plants are adapted to higher temperature regimes and have little or no loss of carbon through

**photorespiration** (ca. 30%). However, the ultimate impact of such climatic perturbations on the biosynthesis of compounds other than photosynthetically produced sugars is unknown.

**Flooding** of plant root systems for variable periods of time is another kind of environmental stress. The stress imposed here is mainly due to oxygen deprivation to the roots. For terrestrial plants, too much water results in the stunting of shoot growth, reduced chlorophyll biosynthesis in the leaves, and enhanced ethylene biosynthesis. However, aquatic plants, such as rice (*Oryza sativa*) and cattail (*Typha* spp.), can tolerate continuous flooding, because they have **air passages** in the root and shoot systems that allow atmospheric oxygen to permeate into the cells of their flooded roots. Where nonaquatic plants are periodically flooded by irrigation, after the soil has dried out, plant growth and chlorophyll biosynthesis are not impaired but, rather, are stimulated. In the case of the tree of joy, *Camptotheca accuminata*, such periodic flooding episodes result in greatly enhanced growth of new shoots that have significantly higher levels of **camptothecin** (CPT) than the shoots of plants that were not irrigated and have only old-growth shoots (Liu et al., 1997).

It is also known that the **acidity (pH)**, **salinity**, and **nutrient** conditions of the plant environment have a huge impact on the growth of plants. For example, the dependence of the structure and ionization states of many molecular constituents of the cell ensure that cellular processes are sensitive to pH. Different plant species differ in their responses to pH conditions. Most plants grow well in soil that is neutral, mildly acidic, or mildly basic. However, **acidic** stress usually induces changes in the cellular biochemistry and physiology of the whole plant (Gerendas and Raticliffe, 2000). The biological effects often include visible symptoms of injury, including chlorosis, necrosis, or reduction in root and shoot growth. Other effects are invisible, such as the presence of high concentrations of H<sup>+</sup> and Al<sup>3+</sup> ions, effects on membrane and ion transport systems, reduced photosynthesis, altered water balance, and variation in enzyme activities (Velikova et al., 2000). In addition, acid stress is accompanied by changes in endogenous hormones that, in turn, cause changes in related physiological processes. Similarly, many plants develop severe chlorosis when grown in **alkaline** soils due to the reduced availability of iron and manganese at high pH. Other species, however, are well adapted to such conditions at the extremes of pH. Thus, the biological effects are numerous and complex, and similar effects occur under conditions of high salinity or low levels of both macro- and micronutrients. Many research efforts are under way to characterize how certain plants are able to tolerate such environmental stresses while others are not.

---

### Essay on the Effects of Different Light Intensities on the Production of Camptothecin in the Tree of Joy (*Camptotheca accuminata*)

In the following experimental example, University of Michigan biology students, Atul Rustgi, Ashish Goyal, and Kathryn Timberlake provide an essay on their bachelor's degree research project covering the effects of different light intensities on camptothecin levels in tree of joy plantlets.

#### Objective

In previous experiments, it was shown that a decrease in light intensity will increase the production of **camptothecin** (CPT) (Liu and Adams, 1996). The objective of the following example was to test such effects of light intensity on the production of CPT in tree of joy plants.

#### Materials and Methods

Three trays containing seedlings of *Camptotheca accuminata* were grown in a greenhouse. Each tray contained plants of the same age and height. Each tray of plants was exposed to a particular light intensity different from that of the other two trays. In each tray, the seedlings were arranged in two rows. The first tray received no shading and had a light intensity at the top of the plants of 3000  $\mu\text{E}\cdot\text{m}^{-2}\cdot\text{s}^{-1}$ . The second received





**FIGURE 3.2** Photograph of students Ashish Goyan, Kathryn Timberlake, and Atul Rustgi measuring light intensity with a photo flux density meter (Ly-Cor, Inc.) in their shading experiment with seedlings of tree of joy, *Camptotheca accuminata*. (Photo courtesy of David Bay.)



**FIGURE 3.3** Shading experiment with tree of joy (*Camptotheca accuminata*) seedlings grown at three different light intensities in the greenhouse at the University of Michigan. (Photo courtesy of David Bay.)

1× shading by means of a thin wire screen that was held above the plants by four posts at each corner of the tray. The light intensity measured at the top of this set of plants was  $750 \mu\text{E}\cdot\text{m}^{-2}\cdot\text{s}^{-1}$ . The third tray received 2× shading by means of two wire screens. The light intensity measured at the top of this set of plants was 300 to 400  $\mu\text{E}\cdot\text{m}^{-2}\cdot\text{s}^{-1}$  (see Figure 3.2 and Figure 3.3).

At the time of setup, a random sampling of the largest top leaves of the plants was taken. This was done in order to get a measurement of the initial concentration (T0) of CPT in these seedlings before any experimental variables were induced. The following procedure was used to determine the concentration of CPT in the T0 samples and in successive samples:

1. Freeze leaves in liquid nitrogen
2. Crush to a powder using mortar and pestle
3. Add 1 g of crushed leaves to a beaker containing 50 ml of methanol (MeOH)
4. Cover beaker for 24 h
5. Vacuum filter
6. Transfer liquid portion to a clean beaker

7. Air dry
8. Add 0.01 g of dried filtrate to 400  $\mu$ l of refrigerated MeOH in order to avoid evaporation
9. Cover using Parafilm™
10. Use a sonicator to fully dissolve the residue
11. Analyze 10  $\mu$ l of sample by **high-performance liquid chromatography (HPLC)** (Liu et al., 1997).

For HPLC analysis, 10  $\mu$ l injections were run on a C-18 column using a gradient of 20 to 80% acetonitrile (ACN) as the mobile phase over the course of 60 min. The wavelength used for detection of CPT was 347 nm, the temperature was 40°C, and the flow rate was 1 ml per min. The chart printer was set to an attenuation of nine in order to get the best chromatograph. In order to determine which peak on the chromatograph from the HPLC represented CPT, a sample of T0 was spiked with extra CPT. For this run, 0.015 g of the air-dried filtrate and 0.0004 g of CPT were added to 500  $\mu$ l of MeOH. When the graph obtained for this run was compared to a run without the extra CPT (see Figure 3.4), one peak was noticeably larger (see Figure 3.5), thus indicating this peak to be the one representing CPT. For that peak, the given area under it represented the amount of CPT in a given injection.

At T1 (week 1), six leaves were taken from each of the three trays. The six leaves were a collection of the largest top three leaves of two different plants in the same row of a particular tray. For the next 4 weeks, leaves were taken from the tops of the plants of a new row so as to avoid getting young buds from a plant with leaves that were removed the preceding week. The six leaves were then used in the procedure described above in order to obtain data. The CPT peaks for the chromatographs of these successive trials could be identified by comparing the new chromatographs to that of T0 and searching for similarities in the shape of and the time of elution of the CPT peak. Standard curves using purified CPT were also run during each analysis.

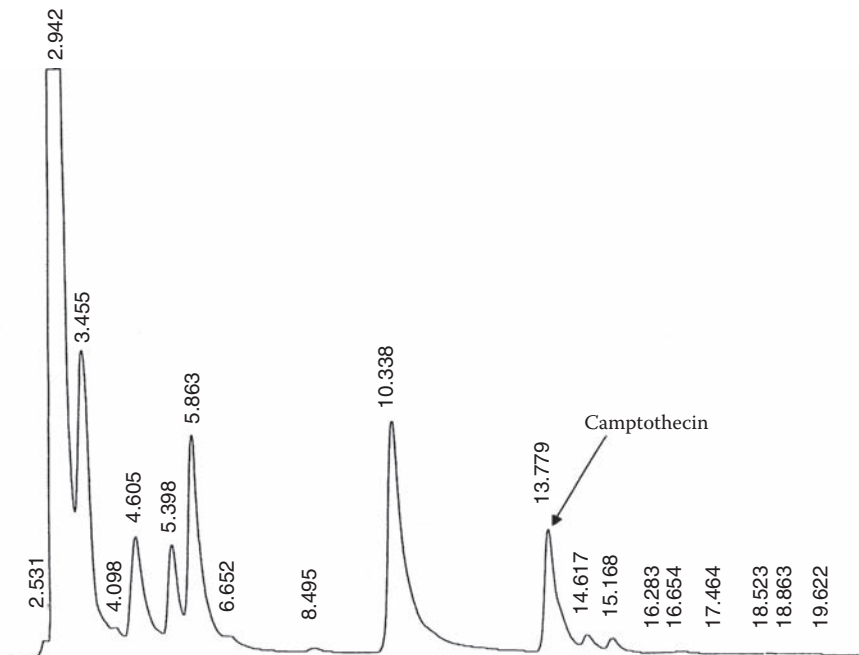

**FIGURE 3.4** High-pressure liquid chromatography trace illustrating camptothecin peak from nonspiked sample extract from tree of joy (*Camptotheca acuminata*) seedlings.

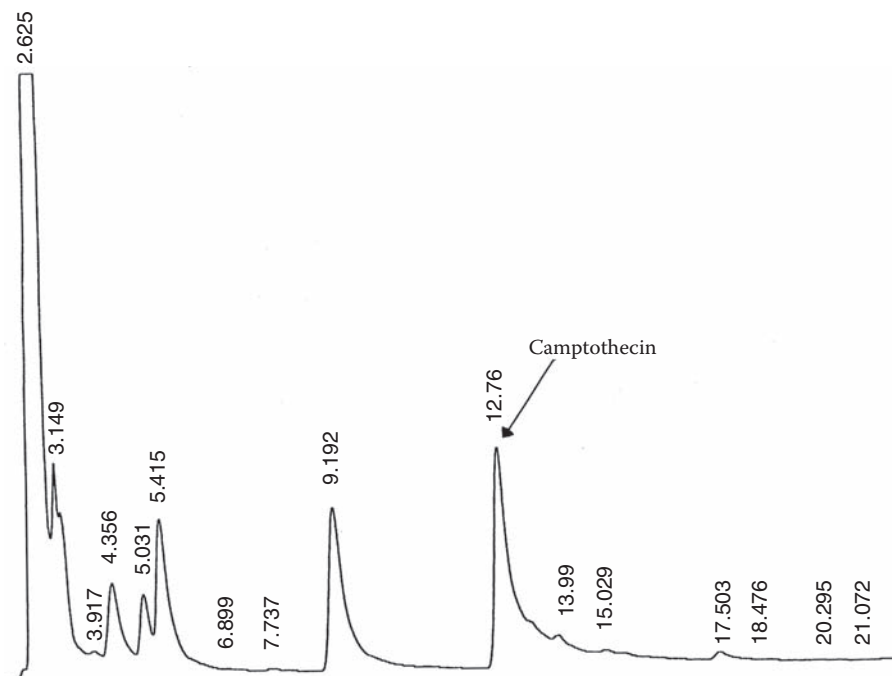

**FIGURE 3.5** High-pressure liquid chromatography trace illustrating camptothecin peak from a camptothecin-spiked sample extract from tree of joy (*Camptotheca accuminata*) seedlings.

**TABLE 3.1**

Data on Areas under Curves for Respective Camptothecin Concentrations

Area under the Curve	Amount of Camptothecin (moles)
11,348	2.87E-06
183,077	2.87E-05
952,883	2.87E-04
6,196,572	2.87E-03

*Note:* Also used for the calculation of the standard curve for camptothecin in Figure 3.6.

## Results

With a standard curve, the amount of CPT in unknown samples can be determined. A sample chromatogram for 2.87E-03M sample is shown in Figure 3.4. The standard curve results and a graphical representation are shown in Table 3.1 and Figure 3.6, respectively.

The results for the three different amounts of shading are shown in Table 3.2, Table 3.3, and Table 3.4.

A sample chromatograph of the first run (T1) is presented in Figure 3.5. A graphical representation of a comparison of all three runs is shown in Figure 3.7.

## Conclusions

The data show that Run 1, which had no shading, had a slow decrease in the amount of CPT production up to week 1. Thereafter, there was a continuous slow rise in the

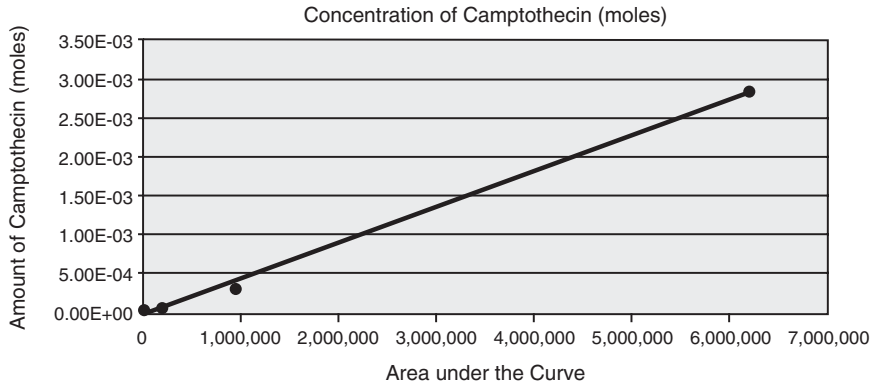

**FIGURE 3.6** Standard curve for concentration of camptothecin plotted against areas under the high-pressure liquid chromatography peaks.

**TABLE 3.2**

Time-Course Changes in Camptothecin Levels in Tree of Joy Seedlings Grown without Artificial Shading

No Shading (Run 1)		
Time (days)	Area under the Curve	Amount of Camptothecin (moles)
0 (T0)	2,469,311	1.10E-03
7 (T1)	2,384,273	1.06E-03
14 (T2)	2,101,377	9.22E-04
21 (T3)	2,311,930	1.02E-03
28 (T4)	3,031,237	1.36E-03
35 (T5)	4,062,633	1.85E-03

Note: Simulated full sunlight conditions.

**TABLE 3.3**

Time-Course Changes in Camptothecin Levels in Tree of Joy Seedlings Grown under 1× (Partial) Shading Conditions

1× Shading (Run 2)		
Time (days)	Area under the Curve	Amount of Camptothecin (moles)
0 (T0)	2,469,311	1.10E-03
7 (T1)	1,887,101	8.21E-04
14 (T2)	2,530,378	1.12E-03
21 (T3)	5,339,954	2.45E-03
28 (T4)	5,370,632	2.47E-03
35 (T5)	7,592,100	3.51E-03

**TABLE 3.4**

Time-Course Changes in Camptothecin Levels of Tree of Joy Seedlings Grown under 2× (Deep) Shading Conditions

2× Shading (Run 3)		
Time (days)	Area under the Curve	Amount of Camptothecin (moles)
0 (T0)	2,469,311	1.10E-03
7 (T1)	5,153,219	2.36E-03
14 (T2)	4,425,086	2.02E-03
21 (T3)	2,546,829	1.13E-03
28 (T4)	3,770,064	1.71E-03
35 (T5)	7,230,344	3034E-03

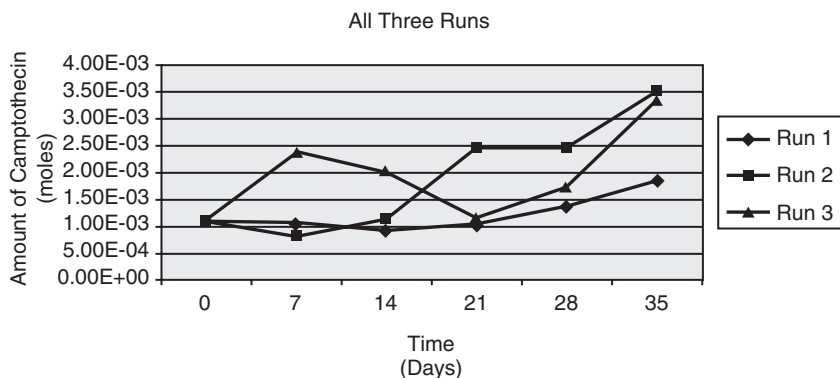

**FIGURE 3.7** Time-course changes in camptothecin levels in tree of joy (*Camptotheca accuminata*) seedlings grown under conditions of no shade (Run 1), 1× shading (Run 2), and 2× shading (Run 3). See text for the respective light intensities at the tops of the tree of joy seedlings for these three different light level regimes.

production. The rise in production is likely due to the effects of leaf growth. Run 2, which had 1× shading, showed an initial decrease in production of CPT, but then after week 1, there was a dramatic increase in production. The dramatic increase in production of CPT must be due to the shading effect. Run 3, which had 2× shading, showed a continued increase in the production of CPT after the onset of the run but started to decrease production after week 1 until week 3. This decrease is likely due to poor leaf growth. After week 3, Run 3 showed an increase in CPT production, which was due to new leaf growth. Going into week 5, both Runs 2 and 3 were producing the same amount of CPT, but Run 2 showed greater potential because its new growth was due to the shading effect.

A result that was surprising was the fact that Run 3 had an initial rise in the production of CPT, while the other two runs showed an initial decrease in production. As was expected, no shading produces the least amount of CPT. In the short run, it seems that 2× shading produces the largest amount of CPT. In the long run, it also seems that both 1× and 2× shading produce the same amount of CPT, but 2× shading has more potential to produce greater amounts of CPT. Some of these effects may be due to differences in how quickly the plants responded to the different levels of shading.

### Social Benefits

CPT is known to be an anticancer agent. CPT has shown activity against such cancers as ovarian tumors, leukemia, and lung cancer. CPT inhibits the growth of cancer by hampering DNA's ability to unwind and replicate (O'Brien, 1996). It is, therefore, beneficial to cancer research to be able to produce CPT in high amounts. One such way is to understand what environmental conditions allow CPT biosynthesis to be maximized.

This experiment showed that CPT is produced at higher levels under conditions of shading. It was also shown that CPT is produced at different levels under varying degrees of shading. These results can thus be used (along with other criteria) to maximally produce CPT and help in the fight against cancer.

### 3.3 Regulation by Biotic Stresses

Unlike environmental stresses, which are predominantly the result of nonliving components of a plant's environment, biotic stresses are the result of living components of the environment. **Herbivory** (a process where herbivorous animals, insects, and mollusks eat plants as a food source) is one such biotic stress. According to Larcher (1995), biosynthesis of defense metabolites in plants is often induced or enhanced by herbivory. For example, intensively grazed grasses (members of the grass family, Poaceae) frequently contain more biogenic silica than grasses in nongrazed areas. Further, damage to plants elicited by herbivores causes an increase in the amounts (per unit dry weight) of polyphenols, tannins, and terpenes. Such increases occur within the tissues of many plant species, such as birch (*Betula* spp.) and poplar (*Populus* spp.) trees, which show increases in the levels of such metabolites after attack by insects and mollusks (Larcher, 1995). Larcher indicated that such upregulation in the biosynthesis of these metabolites (defense compounds) occurs at the expense of biomass (dry matter) production in plants that are exposed to such stresses. So, defense against herbivory comes at a cost. It is best for the plant if it can downregulate the production of defense compounds during times when the plant is not under attack.

Humans can make use of biotic stresses, such as herbivory, to increase yields of desired plant metabolites. As cited in Section 3.2, Liu and Adams (1996) showed that bark tissue contains significantly higher amounts of the medicinal metabolite, **camptothecin** (CPT), than wood tissue by a factor of two in both roots and stems. As these trees grow larger in diameter, the proportion of bark tissue decreases substantially. Because bark tissue contains significantly more CPT per unit dry weight, Liu and Adams said that it is desirable to grow smaller-diameter trees with many branches present, because the ratio of bark to wood is much greater in such shoots. To achieve this condition, simulated herbivory, using **coppicing** (cutting of trees at ground level to stimulate the development of new, vigorous shoot growth ["sucker" sprouts]), will induce the trees to regenerate plants with multiple, small shoots. These shoots can then be collected for the extraction of higher yields of CPT.

In Chapter 2, we mentioned that conifers secrete oleoresin (turpentine and rosin) in response to wounding and attack by insects (e.g., bark beetles) and fungal pathogens. This is well documented in the classic work by Funk et al. (1994) on the occurrence of **oleoresinosis** in grand fir (*Abies grandis*) elicited by physical wounding. The wounding treatments simulate the wounding that occurs after an attack on stem bark tissues by bark beetles. This wounding is achieved by making a series of 1 mm cuts approximately 3 mm apart along the entire stem on opposite sides of 6-week-old saplings. The extent of upregulation of oleoresin biosynthesis by these treatments is substantial. Over a 20-day period, one finds an accumulation of a viscous mass of resin acids and the release of volatile monoterpenes at the sites of wounding. In response to an attack by the bark beetle (*Scolytus ventralis*), these oleoresins deter further attack by the beetles and act directly to kill eggs and larvae of the insect as well as to seal its wound (Funk et al., 1994).

There are some very interesting stories dealing with the action of volatile compounds produced in response to herbivory. These compounds do not always act directly on the attacking organism. For example, during the wounding caused by beet armyworm caterpillars feeding on plant leaves, the insect may produce an oral secretion of a recently discovered fatty-acid-based elicitor/signal called **volicitin** (*N*-(17-hydroxylinolenoyl)-*l*-glutamine). This elicitor, when applied to damaged leaves of corn (*Zea mays*) seedlings, induces the seedlings to release a mixture of volatile compounds (octadecanoid-jasmonate signal complex) that attract females of parasitic or predatory wasps (natural enemies). These wasps then kill the feeding caterpillars, thus removing the biotic stress from the plants (Alborn et al., 1997).

There are, of course, many other forms of biotic stresses that plants may encounter. Plants need to deal with attack not just from animals and insects, but also, from pathogenic bacteria, fungi, and even some parasitic plant species. Under certain circumstances, plants need to deal with the waste products of various organisms, including those from large herds of herbivores, large flocks of birds, and especially, human activity. Some of these biotic stresses overlap with the environmental stresses as different living organisms slowly change their environment. Changes may occur in pH (as is seen from the acidification activity of sphagnum mosses in bogs) or the nutrient content of the soil (as is seen in developing forests, where generations of trees slowly alter the soil). Plants have developed an elaborate network of

biochemical pathways that allow them to respond and deal with all of these changes, whether caused by bacteria or humans.

---

## 3.4 Biochemical Regulation

Apart from environmental and biotic factors, which influence the synthesis of plant metabolites, there are also factors or conditions acting within the plant that influence the activity of the biochemical pathways. An understanding of these factors and how they influence the individual steps of metabolic pathways holds significant benefits for humans. Some examples are given in the following sections.

### 3.4.1 Metabolite Feeds and Radioactive Precursors

One of the traditional ways by which researchers study the pathways for synthesis of plant metabolites is to use  $^{14}\text{C}$ -labeled metabolites, especially those that are known precursors in a given metabolic pathway. This not only helps one to identify intermediate substrates in a given pathway, but also, helps one to determine the **rate-limiting step** of that pathway. If the rate-limiting step in a pathway that produces a metabolite of interest can be discovered, it is possible to upregulate the synthesis of that metabolite by (1) upregulating gene expression for the enzyme that catalyzes the rate-limiting step (see Section 3.5.2), (2) enhancing enzyme activity (in effect, lowering the **K<sub>m</sub>** or affinity of the enzyme for its substrate) by feeding cells with the rate-limiting enzyme's preferred substrate or by increasing substrate concentration (see Section 3.4.2), and (3) removing the end product of the rate-limiting step to stimulate flux through the pathway (see Section 3.4.6). A study illustrating the use of isotopes to help understand where and how upregulation of metabolite biosynthesis occurs is that of Funk et al. (1994). Here, they focused on the oleoresin biosynthetic pathway using *in vivo* [ $^{14}\text{C}$ ] acetate feeding and analysis of intermediates produced by their respective enzyme activities. Two cytochrome P450-dependent diterpenoid hydroxylases involved in the synthesis of (–)-abietic acid (the principal resin acid in grand fir, *Abies grandis*) increase their activities 5- to 100-fold in wounded stems over the levels in nonwounded stems 10 d after wounding, after which time activity declines. As mentioned in Section 3.3, such resin acids are very effective in the control of bark beetle attack.

### 3.4.2 Substrate Activation

In the biochemist's toolbox, one strategy used to enhance end-product biosynthesis is to elevate substrate concentration. This has the potential of enhancing the rate of a given enzyme's activity. A case in point is the hydrolysis of sucrose to D-glucose and D-fructose, mediated by the enzyme invertase ( $\beta$ -fructofuranosidase). When the photosynthetically produced sucrose level increases in source cells (green leaves and stems), invertase activity increases in these cells as long as end products are also being removed or metabolized. One of the consequences of this action, especially in the case of sucrose, is that other metabolic pathways are also upregulated. The elevation in D-fructose levels leads to enhanced synthesis of the storage metabolite, **fructan**, found in cell vacuoles (see Chapter 2). Further, the parallel increases in the amount of D-glucose lead to enhanced synthesis of cell-wall **cellulose** ( $\alpha$ -1,4-linked glucan polymer) and the storage polysaccharide, **starch** ( $\alpha$ -1,4 [amylose] or  $\alpha$ -1,4 + -1,6-linked [amylopectin] glucan polymer), found in chloroplasts and colorless plastids called **amyloplasts** (as found in root-cap cells) (see Chapter 2 for more details).

### 3.4.3 Enzyme Activity Regulation by Protein Phosphorylation/Dephosphorylation and Cytosolic Calcium in Signal Transduction Pathways

Other biochemical factors that influence the production of metabolites act upon the structures of enzymes. For example, in plant cells, there are enzymes called **protein kinases** that act to **phosphorylate** (using a phosphate contained in **ATP**) other enzymes at particular amino acid residues. The additional phosphate

group changes the conformation of the enzyme to which it is attached, thus either activating or, in some cases, inhibiting the enzyme. The phosphorylated enzyme can return to its original state through the action of other enzymes called **phosphatases**, which release the inorganic phosphates attached by the kinases. Such mechanisms are very important in carbon fixation through photosynthesis via **RuP2-Case (Rubisco or ribulose biphosphate carboxylase)** in chloroplasts and dark fixation of carbon dioxide via **PEP carboxylase** (phosphoenolpyruvate carboxylase). Signal transduction cascades involving calmodulin- $\text{Ca}^{2+}$  activation of protein kinases and phosphates, involved in protein **phosphorylation/dephosphorylation reactions** downstream in these cascades, are one of the primary mechanisms for enzyme activation (Anderson and Beardall, 1991). One of the key players here is **cytosolic calcium** ( $\text{Ca}^{2+}$ ). Once it is released from the **endoplasmic reticulum (ER)**, it can bind to the calcium-binding protein, **calmodulin**, which in turn, can activate specific protein kinases involved in protein phosphorylation reactions. This is of current interest to plant biologists, because the control of cytosolic calcium plays a key role in **gravitropic response** mechanisms in roots and shoots, where one of the key metabolites is the plant protein, calmodulin.

### 3.4.4 Regulation by Acetylation, Prenylation, and Glycosylation

Regulation of gene expression at the level of transcription and protein stability are two of the primary consequences of **acetylation reactions** involving the acetyl group,  $\text{CH}_3\text{-C=O}$ . How does this work? In the case of DNA, histone acetylation increases the access of **transcription factors** to DNA in the nucleosome by causing weak internucleosomal interactions, whereby histone tails do not constrain DNA. In contrast, **deacetylation reactions** bring about strong internucleosomal interactions, whereby histone tails constrain the wrapping of DNA on the nucleosome surface. In connection with protein stability, acetylation of the N-terminus of a protein by acetylation of the  $\alpha$ -amino group is thought to increase the life of a protein by protecting it from proteolysis (Buchanan et al., 2000). The mechanism by which this occurs is currently unknown.

Regulation by **prenylation** refers to the addition of the 15-carbon farnesyl group or the 20-carbon geranyl-geranyl group to acceptor proteins, both of which are isoprenoid compounds derived from the cholesterol biosynthetic pathway. The isoprenoid groups are attached to cysteine residues at the carboxy terminus of proteins in a thioether linkage (C-S-C). A common consensus sequence at the C-terminus of prenylated proteins was identified and is composed of **CAAX**, where C is cysteine, A is any aliphatic amino acid (except alanine), and X is the C-terminal amino acid. In order for the prenylation reaction to occur, the three C-terminal amino acids (AAX) are first removed, and then the cysteine is activated by methylation in a reaction utilizing *S*-adenosylmethionine as the methyl donor. Important examples of prenylated proteins include the oncogenic GTP-binding and hydrolyzing protein **Ras** and the g-subunit of the visual protein **transducin**, both of which are farnesylated. Numerous GTP-binding and hydrolyzing proteins (termed **G-proteins**) in the signal transduction cascades have g-subunits modified by geranyl-geranylation. In plants, the biosynthesis of the monoterpene olefins and abietic acid constituents of **diterpenoid resin** (also known as **pitch**) from grand fir, *Abies grandis*, also involves prenylation reactions (see Figure 2.26 and Funk et al., 1994, referenced in Chapter 2).

**Glycosylation reactions** are involved in the formation of **glycolipids** and **glycoproteins** by enzymes termed **glycosyl transferases** (see Chapter 5 for more details on these enzymes). The glycolipids may include those localized in plastid membranes, where they contain high amounts of  $\text{C}_{16}$  polyunsaturated fatty acids (as in peas, *Pisum sativum*), or in the endoplasmic reticulum (ER) membranes, where they contain high amounts of  $\text{C}_{18}$  polyunsaturated fatty acids (as in spinach, *Spinacea oleracea*).

Many cell surface proteins and secretory proteins carry polysaccharide moieties that are either used as signaling devices within the biosynthetic pathway (e.g., N-linked glycosylation) or are involved in the **extracellular matrix (ECM)** function of proteins (e.g., O-linked glycosylation). Glycosylation of newly synthesized membrane and secretory proteins is part of the sorting mechanism within the cell and transport to their final destination. The cellular locations of glycosylation are the lumen of the ER and Golgi (dictyosome) membrane stacks as well as the grana and intergranal membranes of plastids.

Glycosylation reactions are also important in **IAA (indole-3-acetic acid)** metabolism, where glycosyl derivatives include **IAA-glucose** and **myo-inositol-linked IAA**. Both are considered to be "storage



forms” of IAA that release “free IAA” via deglycosylation reactions. Another example is found in the seeds of edible legumes. In the seeds, most of the isoflavones are stored as glucosyl conjugates, such as **genistin** and **daidzin**. When the seeds germinate, the respective aglycones, **genistein** and **daidzein**, are released via the action of  $\beta$ -glucosidases. Genistein is an important receptor molecule in root hairs, where nitrogen fixation by rhizobacteria is initiated. It is also very important in deterring attack of legume seedlings by pathogenic fungi (see below). In humans, it is important in preventing the development of colon cancer and osteoporosis (see discussion in Kaufman et al., 1997).

### 3.4.5 Activation with Fungal Elicitors and Plant Growth Regulators

During the course of evolution, plants evolved intriguing defense strategies against attack by fungal pathogens that cause disease. When the fungus attacks the plant, it may synthesize and secrete into the plant’s cells various fungal **cell-wall polysaccharides** (e.g., **chitin**, made up of N-acetyl-D-glucosamine) that we call **elicitors**. Such elicitors can act to upregulate the synthesis of specific plant metabolites called **phytoalexins** (compounds that kill attacking fungal pathogens). Two such phytoalexins are the isoflavonoids, genistein and daidzein. In seedlings of soybeans and other members of the bean family (Fabaceae), the levels of these compounds increase dramatically when the plant is attacked by a fungal pathogen. They are toxic to the fungal pathogen and act to kill the fungus. This has an application with miso and tempeh, both fermented soybean food products. **Miso** is made by culturing soybean curd with the fungus, *Aspergillus oryzae*. The fungus secretes fungal elicitors that cause the soybean to synthesize significantly higher levels of genistein and daidzein. This, in turn, produces the food’s distinct flavor. It is also of interest that these two isoflavonoids are very important in preventing colon cancer and in treating patients suffering from alcoholism (Duke, 1995).

Naturally occurring or synthetic plant growth regulators were used to upregulate the biosynthesis of enzymes that produce useful metabolites either in intact plants or in plant cell cultures. A few of the classic examples are as follows:

- The induction of synthesis and rate of flow of **latex** (made up mostly of **polyterpenes** found in the latex of the stems) from wounds in the bark of Brazilian rubber trees (*Hevea brasiliensis*) by the naturally occurring plant hormone/growth regulator, ethylene (Schery, 1972; Weaver, 1972).
- The induction of synthesis of invertase ( $\beta$ -fructofuranosidase) by the naturally occurring plant hormone/growth regulator, gibberellic acid ( $GA_3$ ), in elongating stems of cereal grasses (Kaufman and Dayanandan, 1983).
- The induction of synthesis of  $\alpha$ -amylase in germinating seeds of cereal grains by the plant hormone,  $GA_3$ , which triggers the hydrolysis of starch to sugar (D-glucose); this action by  $GA_3$  on  $\alpha$ -amylase activity is utilized in beer brewing, using modified barley (*Hordeum vulgare*) substrate (the D-glucose derived from starch stored in the grains) (Jacobsen et al., 1995).
- The upregulation of synthesis of **shikonin** (a red naphthoquinone pigment used as a medicine, dye, and cosmetic) in cell cultures of *Lithospermum erythrorhizon* in a **two-stage bioreactor** by kinetin (a synthetic cytokinin plant hormone, 6-furfurylaminopurine) and by IAA (the naturally occurring auxin-type plant hormone, indole-3-acetic acid); and the downregulation of shikonin biosynthesis by the synthetic auxin-type plant growth regulators, 2,4-D (2,4-dichlorophenoxyacetic acid) and  $\alpha$ -NAA (1-naphthaleneacetic acid) (Tabata and Fujita, 1985).
- Induction of vanillic acid formation with the plant growth regulator, kinetin, in cell suspension cultures of the vanilla orchid, *Vanilla planifolia* (Funk and Brodelius, 1992); the key to this upregulation of vanillin biosynthesis is the enhancement in the activities of several enzymes in the phenylpropanoid biosynthetic pathway that leads to vanillin production, namely, phenylalanine ammonia lyase (PAL), 4-hydroxycinnamate:coenzyme A ligase, and uridine 5-diphosphate-glucose:transcinnamic acid glucosyl transferase.

### 3.4.6 End-Product Inhibition

If end-products begin to accumulate in significant levels at the sites where metabolite synthesis is occurring, this can result in repression of enzyme activity for the last and preceding enzymes in a given biosynthetic pathway. In the example we cited earlier with invertase-mediated hydrolysis of sucrose, the accumulation of the end products, D-glucose and D-fructose, can cause significant repression of invertase activity (Kaufman et al., 1973). For the plant, this prevents the non-stop production of D-glucose and D-fructose, which would use up the supply of sucrose needed for the production of many other metabolites. For humans, the strategy of feeding end-products to whole plants or cell cultures was used to cause plants that have **branched metabolic pathways** to stop producing one type of metabolite at the end of one of the branches. This, in turn, causes the amount of end-product of the other branch to increase significantly.

### 3.4.7 Direct Inhibition of Enzyme Activity

Enzymes are inhibited by various molecules within the cell in two primary ways: (1) by **competitive inhibition** and (2) by **noncompetitive inhibition** (Anderson and Beardall, 1991). In competitive inhibition, the inhibitor acts by binding to the **active site** of the enzyme, and in so doing, prevents the binding of normal substrate. To do this, the competitive inhibitor must resemble the enzyme's normal substrate. In noncompetitive inhibition, the inhibitor molecule binds to the enzyme, but it does not compete with the substrate for the active site. A good example of competitive inhibition is that between carbon dioxide and oxygen for the active site on the photosynthetic enzyme complex, RuP2-Case or ribulose-1,5-P2 carboxylase/oxygenase. If oxygen is occupying the active site, then CO<sub>2</sub> cannot be fixed. An example of noncompetitive inhibition is that manifested by the herbicide, **glyphosate**. It competes with phosphoenolpyruvate (PEP) for the PEP-binding site on the enzyme, 5-enolpyruvylshikimate-3P synthase (EPSP synthase), but it does not interfere with the actual active site on EPSP synthase (Anderson and Beardall, 1991).

One relevant enzyme inhibition case involving medicinal natural products is that in which the glucoside of the isoflavonoid, daidzein, called **daidzin** (found in high levels in the seeds of soybean [*Glycine max*] and pinto bean [*Phaseolus vulgaris*]), inhibits the enzymes, alcohol dehydrogenase and NAD-dependent alcohol aldehyde dehydrogenase. These enzymes work to catalyze the oxidation of acetaldehyde, the primary product of alcohol metabolism (Duke, 1995; Kaufman et al., 1997). When daidzin is present, alcohol levels increase in the bloodstream and cannot be metabolized via alcohol dehydrogenase and alcohol aldehyde dehydrogenase. An important consequence of this is that alcoholics soon lose their appetite for alcohol. Another isoflavonoid produced in high amounts in soybeans (*Glycine max*), fermented soybean products, and **kudzu** vine (*Pueraria Montana*) roots is **genistein**. It acts as an anticancer agent in humans, in part, by inhibiting DNA topoisomerase that is functional in DNA synthesis and replication — especially in rapidly growing neoplastic tissues such as tumors (Boik, 1996).

---

## 3.5 Molecular Regulation

Because the production of every enzyme, along with the enzyme's location and function within the cells of a given plant, are ultimately controlled by the sequence of nucleotides on strands of DNA, one last category of factors that influence metabolite biosynthesis will be considered. These factors interact with the DNA molecules to regulate the activity of the genes that govern the individual enzymes of each pathway.

### 3.5.1 Regulation of Gene Expression in Plants Occurs on Many Levels

Gene expression can be considered at several levels, including the production of mRNA, the production of protein, or the production of a final product. Often, each of these levels is under the control of its own molecular regulatory mechanisms. Such mechanisms can be complicated, and they often vary significantly from gene to gene. While a full discussion of such mechanisms goes well outside the scope

of this book, we cover some examples of the different levels of molecular regulation in Chapter 5. Here, we focus on the basics.

The steps of gene expression that take place in the nucleus to produce messenger RNA (DNA → gene → primary DNA transcript → mature mRNA) are known as **transcription**. The steps of gene expression that take place in the cytoplasm to form polypeptide chains from this mRNA (mRNA on the ribosomes → synthesis of polypeptides → formation of functional protein) are called **translation**. These primary steps are depicted in Figure 3.8, along with a partial list of factors that may influence both transcription and translation at differing times and under differing conditions within differing tissues. For example, as depicted in Figure 3.8, degradation of DNA, mRNA, and functional proteins can occur when the appropriate hydrolases are present (DNAases, RNAases, or proteases). Synthesis and degradation of DNA, mRNA, and functional proteins are very important processes in gene regulation and are known as **turnover**. When the rate of synthesis exceeds the rate of degradation, there is a net synthesis of DNA, RNA, or protein; when the converse occurs, there is a net loss of DNA, RNA, or protein. This has a direct impact on the amount of production of a given enzyme within a given pathway, as well as the resulting production of a final product.

Also shown in Figure 3.8 are a variety of **post-translational** modifications that may be required prior to the production of a functional protein (see Section 1.6.3 for a discussion of protein folding). As described in Sections 3.4.3 and 3.4.4, these may include the addition of permanent or temporary chemical modifications through the processes of phosphorylation, acetylation, phenylation, glycosylation, or methylation. Each of these processes is also under its own form of molecular regulation. Likewise, each protein is only functionally active within a specific location in the cells of specific tissues, and there are many regulatory mechanisms that govern the proper localization of each protein to its appropriate cellular compartment. Sometimes, the functional activity of a protein also requires interaction with other protein components, and there are factors that control such interactions in space and time. In addition, synthesized mRNA and protein can be stored within the cells for later use, when changing environmental conditions trigger their activation (e.g., long-lived mRNA in seeds and animals eggs; storage proteins in seeds). Thus, the absolute level of gene expression in a cell or tissue is not only dependent on the levels of synthesis, degradation, and storage of DNA, mRNA, and protein, but also, on the timing of chemical modifications, protein–protein interactions, and proper spacial localization. Only then can the gene perform its destined function in metabolite production. We refer to this complex system of regulation of the steady-state level of such metabolites in cells as **homeostasis**.

### 3.5.2 How Plant Genes Are Turned On and Off

As described above, regulation of gene expression can occur at the level of transcription (DNA to RNA), post-transcription (initial RNA transcript to mRNA, translation mRNA to polypeptide), or post-translation (polypeptide to functional protein). These levels of regulation are controlled by a wide range of environmental and developmental signals. The mechanisms of regulation are often complex and diverse; so it is a purpose of this section to give the reader an appreciation of this diversity.

What are some of the environmental and developmental signals that regulate gene expression in plants? Basically, they can be any of the environmental, biotic, and biochemical factors that we discussed in Sections 3.2, 3.3, and 3.4. Fundamentally, plants respond to each of these factors at a molecular level by altering the levels of expression of various genes. For example, the presence of light may upregulate the synthesis of the mRNA of light-harvesting complexes involved in photosynthesis. This is mediated by the phytochrome system involving red and far-red wavelengths of light. On the other hand, reduced levels of light may increase the biosynthesis of **camptothecin (CPT)** due to an increase in the expression of genes within this pathway (see essay in Section 3.2). Other signals are stresses elicited by such factors as ultraviolet light, wounding, or pathogen attack, which can upregulate, at the level of transcription, the synthesis of such enzymes as PAL that leads to synthesis of phenylpropanoid compounds. The expression of other enzymes, however, is reduced by the same stresses. Still other signals can be attributed to plant hormones that are bound by protein transcription factors within the cell. For example, in germinating cereal grass seeds, gibberellins (GAs) can cause *de novo* synthesis of mRNAs for  $\alpha$ -amylase that break down starch to sugar and of proteases that can break down stored proteins in seeds. In contrast,

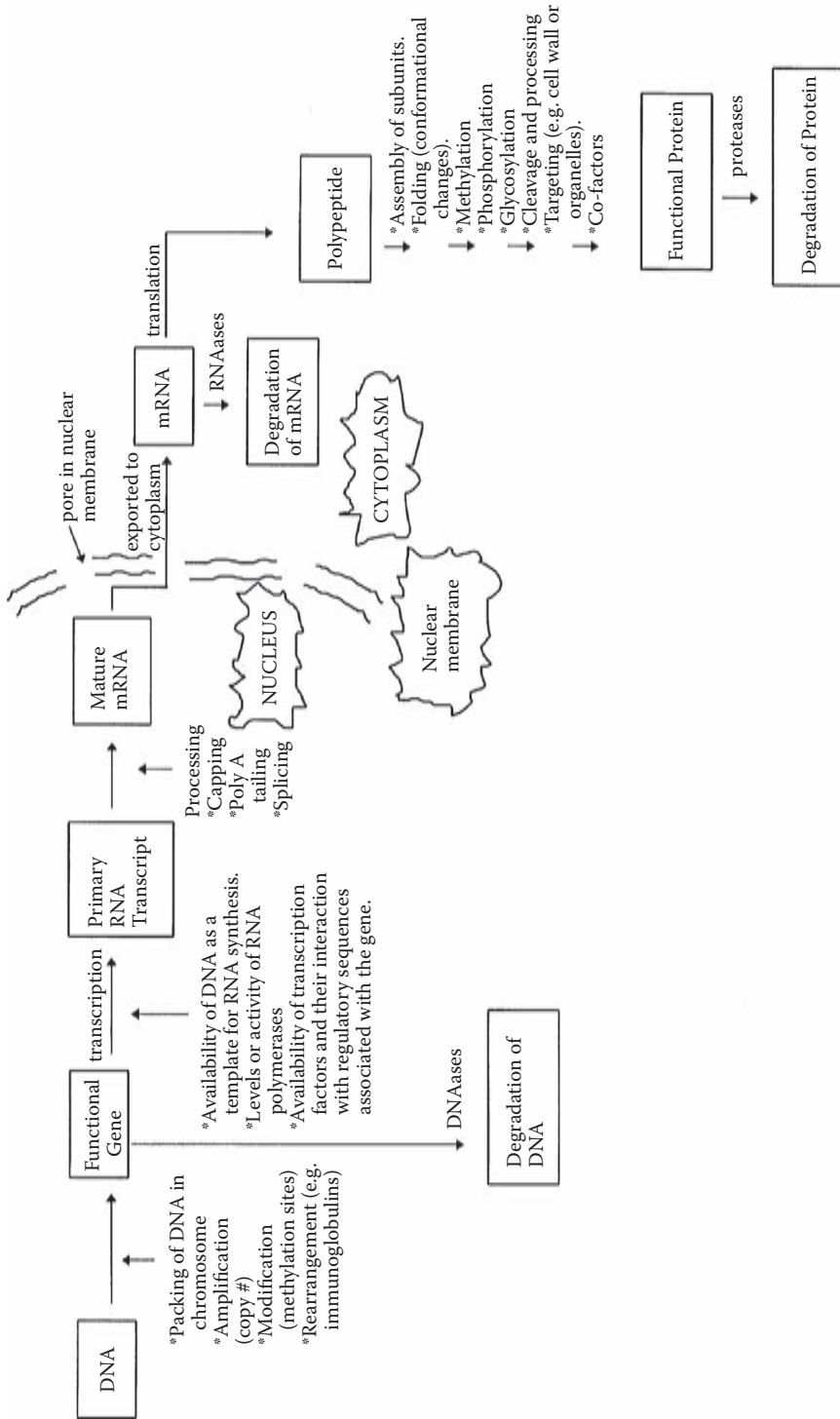

FIGURE 3.8 The primary steps in gene expression and the control points that occur at steps leading from DNA to mRNA and protein synthesis in cells.

the plant hormone, abscisic acid (ABA) turns off such gene expression in germinating seeds and is partly responsible for the dormancy of these seeds as well as the dormancy of the buds of temperate-zone trees.

The precise mechanisms by which environmental or developmental signals act to control gene expression are not yet completely understood. But, research so far has allowed several mechanisms to be promulgated, including the following (some of these examples are expanded upon in Chapter 5):

- The signal (such as GA, gibberellin, or ABA, abscisic acid) could stimulate the synthesis of a protein regulatory factor that binds to particular **trans-acting** (other proteins) or **cis-acting** (DNA sequence) elements located upstream in the promoter region of a gene to turn the gene on (as in the case of GA) or off (as in the case of ABA) in gene expression.
- The signal (such as a cytokinin plant hormone that acts to stimulate red-light-induced synthesis of RuP2-Case and light-harvesting complex [LHCP] in greening tissues of duckweed, *Lemna gibba*) may act to stabilize particular mRNA species, retarding the degradation of the initial RNA transcripts or mRNA produced from a given gene (Anderson and Beardall, 1991).
- The signal may fail to act when plants are genetically engineered using constructs that have the gene of interest in the antisense or reverse orientation. For example, the plant hormone ethylene causes ripening in fruits due to enhanced activities of pectinases (a class of cell-wall-loosening enzymes, more properly known as polygalacturonases, which hydrolyze pectins or polygalacturonans, the cementing substances located mostly in the middle lamella between primary cell walls). The antisense technology has the effect of producing RNA molecules that are complementary to the normal (correct orientation) RNA. Because mRNA is single stranded, when these two molecules bind together through their mutual affinity, the normal mRNA will not function properly. The **FLAVR SAVR™ tomato** is one such genetically engineered product where the gene for pectinase was introduced into tomato plants in an antisense orientation to knock out gene expression of the plant's pectinase (Redenbaugh et al., 1992).

To produce such transgenic plants as the FLAVR SAVR™ tomato, there is a specific order of questions and answers that must be elucidated. In natural products research, one of the first important biochemical questions to ask is “how is the metabolite of interest synthesized?” Another is “what are the enzymes for the respective steps in the pathway?” These are not easy questions to answer, but once these enzymes are isolated and purified, then the molecular biologist can potentially clone the genes that make these enzymes, determine their nucleotide sequences, and characterize their expression patterns within the various plant tissues (see Chapter 5). At this point, the pathway for the metabolite of interest will be well understood, and a new question arises. How can the expression of the gene(s) for the **rate-limiting enzyme(s)** in the biosynthetic pathway be upregulated, or downregulated, so as to make more, or less, of the metabolite of interest through genetic engineering protocols? These protocols include the use of constitutive or super promoters attached upstream of the gene, the use of constructs to suppress gene expression, and the use of genetic transformation to express the gene of interest in organisms that normally do not express this gene. If all of the biochemistry is done properly, including (1) the purification of the proteins of interest, (2) the characterization of any isozymes or gene family members for the particular enzyme being studied and their ultimate site(s) of action in the cell, and (3) the elucidation of the function of the enzymes in cell metabolism, then the above-outlined molecular biology work is not only feasible, but also, allows one to turn specific genes on or off in a particular metabolic pathway, thus changing the production of specific metabolites. In doing this kind of work, **risk assessments** are absolutely necessary to determine if a particular transgenic plant can have any detrimental effect on human health or on the environment. These are discussed in detail in Redenbaugh et al. (1992), Rissler and Mellon (1996), Krinsky and Wrubel (1996), as well as in Chapters 7 and 12.

### 3.5.3 Transcription Factors Involved in Pathway Regulation

Regulatory proteins called **transcription factors** function by binding to the **promoter** of a gene, and in some cases, to additional regions called **enhancer** and **repressor regions**. Binding to the promoter

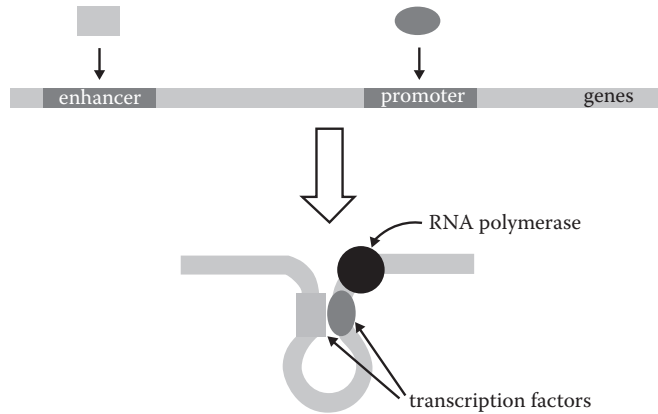

**FIGURE 3.9** A stretch of DNA containing enhancer, promoter, and gene regions. Transcription factors are represented by the rectangle and the oval. Once they bind to the DNA, they can help form loop structures that allow RNA polymerase to find the start of the gene.

can have either a stimulatory effect or a suppressive effect on gene activity. In addition, enhancer regions may be located at a distance from the gene that they stimulate. Many transcription factors are necessary for RNA polymerase to attach just prior to transcription. In many cases, transcription begins when the factors at the promoter region bind with the factors at the enhancer region, creating a loop in the DNA. An example of this looping is depicted in Figure 3.9.

Hundreds of different transcription factors have been discovered; each recognizes and binds with a specific nucleotide sequence in DNA. In many cases, a specific combination of transcription factors is necessary to activate each given gene. A good example of this is the MADS-box class of transcription factors that control flower development in plants (see below).

Transcription factors are also regulated by signals produced from other molecules. For example, hormones can activate transcription factors, and thus, enable the activation and transcription of certain genes. In connection with the hormone, **indole-3-acetic acid (IAA)** or auxin, Nemhauser and Chory (2005) summarized recent work from several labs that led to the discovery of the long-sought-after **auxin-binding** or **receptor protein**. The scenario goes like this: When IAA is present in zero or low amounts, **transcriptional repressor proteins (Aux/IAA)** remain bound to an **auxin response transcription factor (ARF)**. As a result, target genes of auxin action remain switched off, and the developmental process (e.g., embryogenesis in *Arabidopsis*) does not occur. However, if auxin is present in higher amounts, it interacts with leucine-rich repeat **F-box proteins** called **TIR1/AFBs**, which are involved in ubiquitin-mediated **protein degradation**. When Aux/IAA proteins bind to auxin-modified TIR1/AFBs, the ARF auxin response transcription factor is no longer repressed. As a consequence, the expression target genes for embryogenesis are turned on, and embryogenesis ensues.

---

### Essay on MADS-Box Transcription Factors

Consistent with their function in regulating the expression of other genes, the MADS-box genes encode transcription factors present in animals, fungi, and plants. The term **MADS-box** is derived from the first four genes characterized in this large and important gene family: *mcm1*, *ap3*, *defA*, *srf* (Schwarz-Sommer et al., 1990). The MADS-box class of transcription factors is one of the largest families of plant regulators, along with the MYB and AP2/ERF transcription factors (Folter et al., 2004). MADS-box proteins are involved in the development of plant tissues as diverse as flowers and root nodules, and in recent years, MADS-box genes were strongly implicated in the regulation of vegetative growth through overexpression and suppression studies (Alvarez-Buylla et al., 2000a, 2000b; Zhang and Forde, 1998; Prakash and Kumar, 2002;

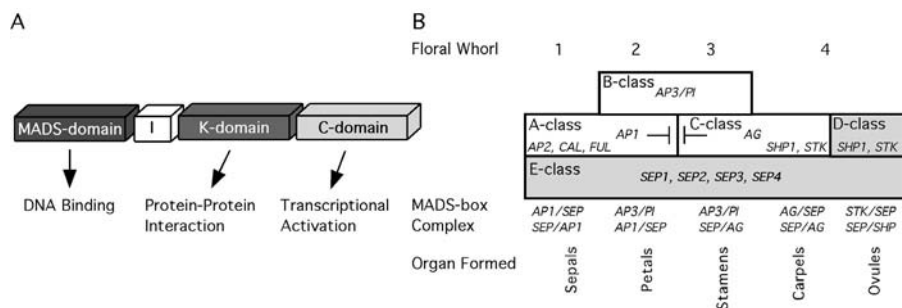

**FIGURE 3.10** MADS-box protein function. (A) The four functional domains found in the typical MIKC-type MADS-box protein. (B) The old version of the ABC model (white boxes) compared to the new version that includes new classes of MADS-box proteins (gray boxes). Also included are the known MADS-box protein interactions that control the development of each floral organ.

Rosin et al., 2003). In addition, genome level studies on several plant species indicate that there are a large number of as-yet-uncharacterized MADS-box genes with vegetative-specific expression patterns, and it is now suggested that these transcription factors may be one of the most important regulatory elements of vegetative development (Parenicova et al., 2003; Zik and Irish, 2003). However, despite their apparent activity in whole plant development, and the biosynthetic processes that govern such development, very little is known about their activity in vegetative growth, other than the role of some in the maintenance of primary meristems (see review by Cseke and Podila, 2004).

In plants, the MADS-box proteins encoded by these genes fall into five structural groups (MIKC, M $\alpha$ , M $\beta$ , M $\delta$ , M $\gamma$ ); however, only members of the MIKC group have been studied in any detail in plants (reviewed in Kaufmann, Melzer, and Theissen, 2005). The MIKC-type MADS-box genes typically contain four functional domains (Figure 3.10A). Beginning with the amino-terminal end of the protein, these domains include the MADS-domain, the L- or I-domain, the K-domain, and the C-domain. Two of these domains, the MADS-domain and the K-domain, are highly conserved among all MIKC-type MADS-box genes. In their role as transcription factors, the MADS-box gene proteins bind DNA, often requiring interaction with other MADS-box proteins, to cause either an activation or suppression of their target genes. The MADS-domain and the L-domain were shown to be both necessary and sufficient for DNA binding and dimerization *in vitro* (Mizukami et al., 1996). While both domains are required for these functions, it appears that the MADS-domain is primarily involved with binding DNA. The K-domain, named for its sequence similarity to the coil-forming region of the intermediate filament protein keratin, was shown to facilitate interaction with other proteins involved with transcription (Mizukami et al., 1996). Finally, the carboxyl end or C-domain of some MADS-box proteins carries an “activation” domain that may be involved in either the activation or suppression of the target gene recognized by the transcription factor (Moon et al., 1999).

MADS-box transcription factors are, by far, best known for their function in regulating the development of flower organs in many plant species. **Floral development** is a three-step process in most herbaceous plants (most trees have four steps, including winter dormancy). First, there is a transition from an extended period of vegetative growth to the reproductive phase. This is followed by initiation of floral primordia, which then leads to the development of the various floral organs. In addition, the transition from the vegetative phase to the reproductive phase takes place in response to external signals, such as changes in photoperiod and temperature, growth regulators like the gibberellins, as well as internal signals from various developmental genes. For

example, the flowering time genes such as *FPA*, *LD*, and *FCA* from *Arabidopsis* promote flowering independent of environmental conditions, whereas *CO*, *FHA*, and *FWA* promote flowering in response to long day conditions (Pineiro and Coupland, 1998).

The initial switch from **vegetative meristem** to a **floral meristem** is under the control of meristem identity genes, such as *LFY* (*LEAFY*), *CAL* (*CAULIFLOWER*), and *AP1* (*APETALA1*) in *Arabidopsis* (*FLO* and *SQUA* in *Antirrhinum*). *AP1* and *CAL* are MIKC-type MADS-box genes. The subsequent conversion of the floral meristems into the various floral organs is coordinated by a set of MIKC-type MADS-box organ identity genes that fall into three classes commonly referred to as A, B, and C. In the original ABC model, the organ identity genes *AP1*, *AP2* (*APETALA2*), *AP3* (*APETALA3*), *PI* (*PISTILLATA*), and *AG* (*AGAMOUS*) act in a concerted fashion to define the boundaries of the different floral organs. *AP1* (perhaps in association with *AP2*, which is not a MADS-box gene) defines the development of sepals, whereas when *AP1* is expressed in tissues along with *AP3* or *PI*, petals are formed. It is interesting to note that several of these types of genes (such as *AP1*) have dual functions in controlling floral meristem transition and organ identity. When *AP3*, *PI*, and *AG* are expressed together, stamens are formed, and when *AG* is expressed alone, carpels are formed.

However, in recent years, much attention has turned to new classes of MADS-box genes that are changing how researchers think about the traditional ABC model. Now there are D-class genes, such as *SHP* (*SHATTERPROOF*) and *STK* (*SEEDSTICK*), that are expressed during ovule development within the carpels, as well as E-class genes, such as *SEP1*, 2, 3, and 4 (*SEPALLATA1*, 2, 3, 4), that were only recently shown to be necessary for the development of the organ in all floral whorls (Cseke et al., 2005; Ditta et al., 2004). The MADS-box proteins encoded by these genes come together in protein "quartets," where four separate proteins are needed to have the proper function in controlling the formation of the correct organ (reviewed in Kaufmann et al., 2005) (Figure 3.10).

One of the problems encountered during the study of MADS-box genes is that their functional analysis is often inhibited by the presence of redundant gene family members having multiple protein-protein interactions within each plant tissue or organ (Vandenbussche et al., 2003; Ditta et al., 2004; Folter et al., 2005; Moore et al., 2005). Such redundant, multifunctional genes often make the traditional "one gene at a time" approach to functional analysis impractical. The determination of the true function of such genes thus requires the suppression of all members of the gene family. Using examples from the study of floral development, researchers learned that most of the classes of plant MADS-box genes have redundantly functional members (Folter et al., 2005; Moore et al., 2005; reviewed in Kaufmann et al., 2005). This includes A-class genes with homologues of *AP1*, *CAL*, and *FUL*; C- and D-class genes with homologues of *AG*, *SHP*, and *STK*; and E-class genes such as *SEP1*, 2, 3, and 4. Perhaps the best example of problematic functional analyses of redundant genes comes from the *SEP* or E-class genes. Here, the functions of the *SEP* gene family are so interconnected that only the quadruple mutant of *Arabidopsis* was able to confirm their function in all four floral whorls (Ditta et al., 2004). We found similar redundant functions of *SEP*-class genes (*PTM3*, 4, and 6) in the two-whorled flowers of aspen trees (Cseke et al., 2005), and our analysis of the poplar genome suggests that most MADS-box gene families have members with redundant functions.

The function of MADS-box transcription factors is not, however, limited to flowers. MADS-box gene expression was described in roots, stems, and leaves, and in developing ovules and embryos (Rounsley et al., 1995; Huang et al., 1995; Alvarez-Buylla et al., 2000a). As an example of the diversity of these genes, a study of *Rhizobium* nodulation of alfalfa roots indicated that MADS-box genes also play a role in differentiation and development of cells involved in the nodulation process (see Section 3.6.1). Heard and Dunn (1995) used reverse-transcription polymerase chain reaction



(RT-PCR) to clone cDNA fragments representing MADS-box genes expressed in *Rhizobium*-infected alfalfa roots. Characterization of the expression pattern of the resultant MADS-box clone, *nmh7*, showed that expression was specific for infected root nodules. Furthermore, *in situ* hybridization experiments indicated that the gene was expressed only in plant-bacterial symbiotic cells, suggesting that this MADS-box gene functions in the differentiation and development of these symbiotic cells within alfalfa root nodules. More recently, they identified another MADS-box gene, *ngl9*, from alfalfa root nodules. This gene is an interaction partner to *nmh7* during root nodule development.

Some MADS-box genes were implicated in the regulation of vegetative growth through overexpression and suppression studies. These include *ANR1* from *Arabidopsis*, which is required for root development in response to nutrients, as well as *PkMADS1* from *Paulownia kawakamii* trees and *POTM1* from potato, which are active in lateral shoot morphogenesis (Zhang and Forde, 1998; Prakash and Kumar, 2002; Rosin et al., 2003). *PkMADS1* is also expressed in the provascular strands of leaves, and it is a member of the StMADS11-class of MADS-box genes potentially involved in vascular development (Carmona et al., 1998). As mentioned above, genome level studies indicate that there are a large number of as-yet-uncharacterized MADS-box genes with vegetative-specific expression patterns. Even in plant species as thoroughly studied as *Arabidopsis*, when considering the fact that there are 107 MADS-box genes known to exist in *Arabidopsis*, and the majority of these genes are expressed in vegetative tissues, and 83% of these genes have completely unknown function (Parenicova et al., 2003), a strong case is presented for a likely function of MADS-box transcription factors in whole plant development. It is also likely that they are one of the genetic factors helping to control the biosynthesis of a variety of plant compounds.

### 3.5.4 Gene Silencing by RNAi

**RNA interference (RNAi)** refers to a natural process of gene suppression and regulation common to most organisms, including plants, which triggers **post-transcriptional gene silencing (PTGS)**, a mechanism important for defense against viral pathogens that attack plants and animals (Waterhouse et al., 2001; Colbère-Garapin et al., 2005). Some recent and powerful uses were found for this mechanism, in that it allows researchers to specifically target the suppression of genes through sequence-specific RNA degradation. This allows for the function of the targeted genes to be assessed through loss-of-function phenotypes (this and other forms of gene suppression are discussed as molecular tools in Chapter 5).

PTGS was first described in transgenic *Petunia*. The goal of the original research was to produce *Petunia* plants with improved flower colors. To achieve this goal, additional copies of a gene encoding a key enzyme for anthocyanin flower pigmentation (**chalcone synthase [CHS]**) were introduced into transgenic *Petunia* (Jorgensen et al., 1996). Surprisingly, a percentage of the *Petunia* plants carrying additional copies of this gene did not show the expected deep purple or deep red flowers, but carried fully white or partially white flowers. Further characterization revealed that both types of genes, the endogenous and the newly introduced transgenes, were turned off. Because of this observation, the phenomenon was first named “cosuppression of gene expression,” but the molecular mechanism remained unknown.

Later plant virologists made a similar observation. In their research, they aimed toward improvement of resistance of plants against plant viruses (Waterhouse et al., 1998). At that time, it was known that plants expressing virus-specific proteins have enhanced tolerance against viral infection. However, Waterhouse and associates made the surprising observation that plants carrying only short regions of viral RNA sequences (not coding for any viral protein) showed the same effect. They concluded that viral RNA produced by transgenes could also attack incoming viruses and stop them from multiplying and spreading throughout the plant. They did the reverse experiment and put short pieces of plant gene sequences into plant viruses. After infection of plants with these modified viruses, the expression of the targeted plant gene was suppressed. Later, this phenomenon became known as **post-transcriptional gene silencing** or, simply, **PTGS**.

One of the best modern methods with which to assess the function of a gene is to knock out its expression and characterize the phenotypic changes that occur as a result of gene suppression. Many of the new suppression techniques are now based on expression of **double-stranded RNA (dsRNA)** to induce **PTGS** and have proven to be extremely effective in transgenic plants (Hamilton et al., 1998; Groenewald et al., 2000; Chuang and Meyerowitz, 2000). It was clearly shown that using inverted repeats containing a loop to produce dsRNA within the plant are the most effective constructs at suppressing genes in as much as 99% of plant transformants through the stimulation of PTGS mechanisms (Chuang and Meyerowitz, 2000; Waterhouse et al., 2001; Helliwell and Waterhouse, 2003). Such constructs are known to target genes having as little as 75% overall nucleic acid identity through the production of 21 to 23 bp fragments (Chuang and Meyerowitz, 2000; Waterhouse et al., 2001). These **short-interfering RNAs (siRNAs)** are subsequently assembled into **active RNA-induced silencing complexes (RISCs)** that seek out and cleave the specific mRNA targets. While PTGS is a natural plant process for defense against viruses that inject their RNA into the plant cell during infection, the phenomenon does not occur in only one cell. The suppression signal begins in the infected cell and then spreads to all cells within the plant, sometimes reaching maximal suppression of the genes in the offspring of the parent plant one or two generations later. Hence, this is a highly effective mechanism for the downregulation of genes within the plant.

---

## 3.6 Role of Biologically Active Molecules in Plant Growth and Development

### 3.6.1 Flavonoids as Endogenous Regulators of Plant Metabolite Biosynthesis

One of the classic cases cited for gene regulation in plants involves signaling in a symbiotic relationship between a **bacterial symbiont** and its **leguminous plant host** in the process of **nitrogen fixation** (Loh and Stacey, 2003). It was described as follows: **bacterial symbionts (rhizobia)** include the following genera: *Rhizobium*, *Mesorhizobium*, *Azorhizobium*, *Sinorhizobium*, and *Bradyrhizobium*. They have the ability to infect the roots of leguminous plants, causing the formation of a nodule and establishing a **nitrogen-fixing symbiosis**. Infection of the plant requires the products of the **bacterial nodulation genes**, which encode for the production of a **lipochitin nodulation signal (Nod)**. This **Nod gene signal**, upon recognition by the plant, induces *de novo* nodule formation. The bacteria invade the root through **root hairs** and penetrate inside a plant-produced **infection thread**. Upon **endocytosis** into an infected cortical cell, the bacteria are enclosed in membrane-bound **bacteroids** that are capable of fixing N<sub>2</sub> into a form that the plant can utilize. In return, the bacteroids are supplied with an environment rich in carbon as an energy source.

Loh and Stacey (2003) described the molecular basis for the nodulation process in an important review paper (see also references cited therein) in slightly modified form as follows: **Bacterial nodulation genes (*nod*, *nol*, *noe*)** encode a key set of proteins involved in the establishment of the symbiotic relationships. The ***nod* genes** are expressed specifically in response to plant-produced **flavonoid inducer compounds** (e.g., the isoflavones, **genistein and daidzein**, as well as the isoflavones conjugates, **6-O-malonyldaidzin and 6-O-malonyl genistin**). Central to the regulation of the *nod* genes is **NodD**, a **LysR-type regulator**. It activates *nod* gene expression only in the presence of the flavonoid inducer. The NodD protein binds to the *nod* box sequence upstream of the *nod* genes and induces DNA bending, leading to **transcriptional activation** upon recognition of the inducer. The **chaperonin GroESL** system is necessary for proper **folding** of NodD into its DNA-binding-competent form. In addition, binding of NodD to the promoter is increased in the presence of flavonoids. In general, the ***nod* box** contains highly conserved regions consisting of 7, 5, and 25 bp. DNA bending of *nod* promoters was also reported to involve a **histone-like protein, Px**, in *Rhizobium leguminosarum*. In this case, the association of Px with the *nod* promoter leads to increased *nod* gene transcription by NodD.

### 3.6.2 Elicitor Molecules as Exogenous Regulators of Plant Metabolite Biosynthesis

**Elicitation** in plants refers to the process in plants whereby various signal molecules act through signal transduction pathways to upregulate gene expression in response to abiotic and biotic stresses (see also

Chapter 7). The signal molecules are mainly cell-wall polysaccharides like **chitin** (N-acetylglucosamine) and **cell-wall oligomeric fragments** of bacterial, fungal, or higher plant origin (see Chapter 7). These molecules activate several different kinds of signal transduction pathways, including **GTP binding proteins**; ion fluxes and **Ca<sup>2+</sup> signaling**; cytoplasmic acidification; oxidative burst and production of **reactive oxygen species (ROS)**; **IP3 (inositol 1,3,5-triphosphates)** and cyclic nucleotides; **salicylic acid** and **nitric oxide (NO)**; the **jasmonate pathway**; the **ethylene pathway**; and **abscisic acid (ABA)** signaling (Zhao et al., 2005; Pozo et al., 2005). What is particularly interesting here is that there is considerable **cross talk** between the different signaling pathways. Examples include elicitor and jasmonate; jasmonate and ethylene; jasmonate and other pathways; reactive oxygen species (ROS) and other pathways; as well as abiotic elicitors and oxylipin pathways (see review by Zhao et al., 2005, for more details). These integrative actions in multiple signal transduction pathways are mediated by **transcription factors** (the action of which we discussed in Section 3.5.3).

Ultimately, the action of the elicitor molecules can lead to **systematic acquired resistance (SAR)** on the part of a host plant that is attacked by a bacterial or fungal pathogen or mammalian herbivore in the case of biotic stresses. Similar events occur during the response of plants to abiotic stresses, like flooding, drought, cold, ozone pollution, or toxic heavy metal overload in the soil.

### 3.6.3 Plant Hormones as Endogenous Regulators of Plant Metabolite Biosynthesis

Plant hormones play an important regulatory role in the synthesis of plant metabolites (see Buchanan et al., 2000). A classic example is the elicitation of *de novo* biosynthesis of  **$\alpha$ -amylase** by **gibberellins (GAs)** in barley (*Hordeum vulgare*) and other cereals. The hydrolysis of **starch** reserves in the endosperm tissue of the seed is triggered by the release of endogenous gibberellins from the embryo. At their **target sites**, the GAs activate the expression of  **$\alpha$ -amylase** genes in the **aleurone layer** (protein jacket) that surrounds the endosperm of the seed.  **$\alpha$ -Amylase** is then released into the starch-filled **endosperm** of the seed, where it hydrolyzes the starch to **glucose**. This released glucose is then phosphorylated by hexokinase and is converted to sucrose in the **scutellum** tissue (cotyledon) of the seed for transport to the developing embryo and utilization in metabolism.

How do the GAs act to upregulate  **$\alpha$ -amylase** gene expression? Gibberellin stimulates **transcription** according to the following modified sequence delineated by Stephen G. Saupé (2004):

GA binds to a membrane receptor  $\Rightarrow$

This receptor interacts with a protein complex (**heterotrimeric G protein**)  $\Rightarrow$

This, in turn, activates a GA signaling intermediate  $\Rightarrow$

The intermediate turns off a repressor  $\Rightarrow$

This stimulates transcription of **GA-MYB mRNA**  $\Rightarrow$

This is followed by translation in cytosol to make **GA-MYB protein**  $\Rightarrow$

The GA-MYB protein returns to nucleus and binds to the  **$\alpha$ -amylase** gene promoter region  $\Rightarrow$

This activates transcription of  **$\alpha$ -amylase mRNA**  $\Rightarrow$

The  **$\alpha$ -amylase** protein is translated by **ribosomes** on **rough endoplasmic reticulum (RER)**  $\Rightarrow$

The protein is then transported to the **Golgi**  $\Rightarrow$

The  **$\alpha$ -amylase** protein is finally released from secretory vesicles at the plasma membrane

This last step is apparently regulated by a calcium-dependent mechanism that was also activated by the heterotrimeric G protein complex. It is important to mention here that this action of GAs in mobilizing starch in germinating barley seeds is utilized in the commercial brewing process during the **malting** stage in making **beer**.

Examples abound on the elicitation of plant metabolite biosynthesis by other plant hormones. However, because the mechanisms of action at many target sites have not yet been elucidated to the extent seen in the GA and  **$\alpha$ -amylase** gene expression example, we will defer this discussion until more evidence is available.

### Essay on Cloned Genes Involved in Isoprenoid Biosynthesis

As an example of the complexity of gene regulation within even well-characterized biosynthetic pathways, Figure 3.11 illustrates the pathways of **isoprenoid** (also called **terpenoid**) biosynthesis in plants; Table 3.5 provides a key to the enzymes that operate at each of the respective numbered steps in these pathways (Scolnick and Bartley, 1996b). In addition, we took the time to review a small selection of the genes that were cloned for many of the enzymes in the isoprenoid biosynthetic pathways, indicated in Table 3.6. Natural product researchers will often search the **GenBank** database for

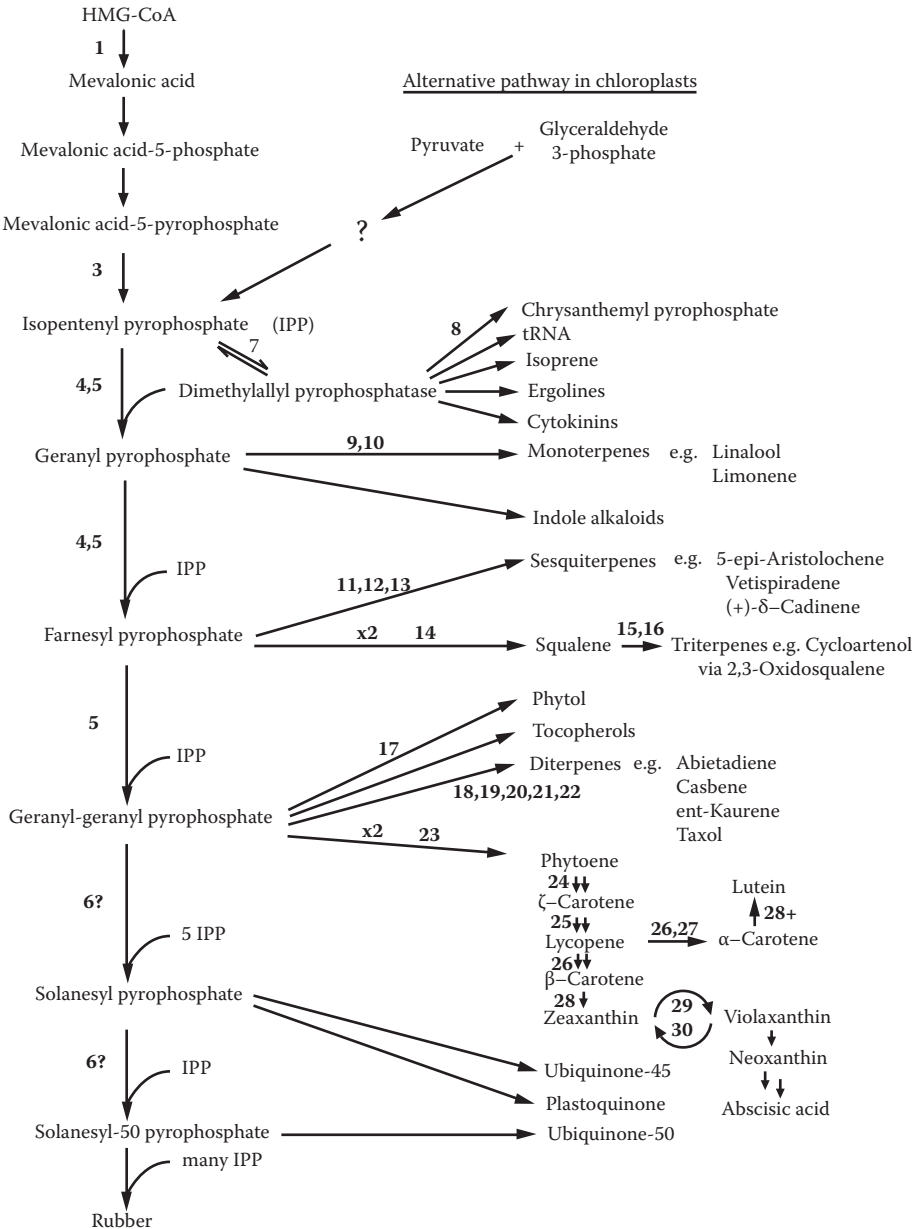

**FIGURE 3.11** Pathways of isoprenoid biosynthesis. The enzymatic steps are numbered according to the key in Table 3.2. (From Scolnick, P.A. and G.E. Bartley. (1996). *Plant Mol Biol Rep* 14: 305. With permission.)

TABLE 3.5

Key to Enzymatic Steps Shown in Figure 3.11

Step	Enzyme
1	3-Hydroxy-3-methyl glutaryl coenzyme A reductase
2	Mevalonic acid kinase
3	Mevalonate 5-pyrophosphate decarboxylase
4	Farnesyl pyrophosphate synthase
5	Geranyl-geranyl pyrophosphate synthase
6	Hexaprenyl pyrophosphate synthase-related protein
7	Isopentenyl pyrophosphate isomerase
8	Chrysanthemyl pyrophosphate synthase
9	<i>s</i> -Linalool synthase
10	4 <i>s</i> -Limonene synthase
11	5- <i>epi</i> -Aristolochene synthase
12	Vetispiradiene synthase
13	(+)- $\delta$ -Cadinene synthase
14	Squalene synthase
15	Squalene epoxidase
16	Oxidosqualene cyclase (cycloartenol synthase)
17	Geranyl-geranyl pyrophosphate hydrogenase
18	Abietadiene synthase
19	Casbene synthase
20	ent-Copalyl pyrophosphate synthase A
21	ent-Kaurene synthase
22	Taxadiene synthase
23	Phytoene synthase
24	Phytoene desaturase
25	$\zeta$ -Carotene desaturase
26	Lycopene cyclase ( $\beta$ )
27	Lycopene cyclase ( $\epsilon$ )
28	$\beta$ -Carotene hydroxylase
29	Zeaxanthin epoxidase
30	Violaxanthin de-epoxidase

Source: From Scolnik, P.A. and G.E. Bartley. (1996). *Plant Mol Biol Rep* 14: 305–319. With permission.

these cloned genes to obtain the nucleotide sequences of such genes ([www.ncbi.nlm.nih.gov/gquery/gquery.fcgi](http://www.ncbi.nlm.nih.gov/gquery/gquery.fcgi)). The information obtained can then be used to tackle the problem of increasing or decreasing the production of a specific metabolite within the plant. Additional information can be obtained from a wide variety of online tools and databases (see Chapter 5 and the Appendix).

Let us take as an example the synthesis of natural rubber, which comes from plants such as the Brazilian rubber tree (*Hevea brasiliensis*) and guayule (*Parthenium argentatum*). This example focuses on the following question: How can the levels of natural rubber be increased in these plants? According to Cornish and Siler (1996), natural rubber is made up of isoprene units derived from isopentenyl pyrophosphate (see Figure 3.11). The polymerization step is catalyzed by the enzyme, rubber transferase, that requires allylic pyrophosphate to initiate the process. Cornish and Siler focused their attention on identifying, isolating, and manipulating rubber transferase and its two substrates, isopentenyl pyrophosphate and allylic pyrophosphate. Their results suggest the possibility that by raising the level of the initiator (through upregulated gene expression of the enzyme that makes allylic pyrophosphate), they can enhance rubber production up to six times (Potera, 1996).

TABLE 3.6

Some Cloned Plant Genes Involved in Isoprenoid Biosynthesis Found Using the NCBI GenBank Database (Correlated to Table 3.5)

Enzyme	Organism	Gene	Clone Type		Accession Number	Ref.
			Genomic	cDNA		
Abietadiene synthase	<i>Abies grandis</i>	<i>Ac22</i> <i>pAGg22-3</i>	+		U50768 AF326516	Submitted, 1996 Trapp and Croteau, 2001
	<i>Picea abies</i>	<i>Tps-las</i>		+	AY473621	Martin, Faldt, and Bohlmann, 2004
5-epi-Aristolochene synthase	<i>Nicotiana tabacum</i>	<i>Str319</i>		+	Y08847	Submitted, 1996
				+	AF272244	Mandujano-Chavez et al., 2000
	<i>Nicotiana attenuata</i>	<i>Hrr8</i> <i>5eas</i> <i>NaEAS12</i>		+	AB196435	Sugimoto et al., 2004
				+	AF542544	Submitted, 2002
				+	AF484123	Bohlmann et al., 2002
				+	AF484124	Bohlmann et al., 2002
		<i>NaEAS34</i>		+	AF484124	Bohlmann et al., 2002
	<i>NaEAS37</i>		+	AF484125	Bohlmann et al., 2002	
<i>Oryza sativa</i>	<i>P0031G09</i>	+		AC092211	Submitted, 2002	
(+)δ-Cadinene synthase	<i>Gossypium arboreum</i>	<i>Cad-XC14</i>		+	U23205	Chen et al., 1995
		<i>Cad-XC1</i>		+	U23206	Chen et al., 1995
		<i>Cad1-A</i>		+	X96429	Chen et al., 1996
		<i>Cad1-B</i>	+		X95323	Chen et al., 1996
		<i>Cad1-A</i>		+	U27535	Chen et al., 1996
		<i>Cad1-A</i>	+		Y18484	Submitted, 1998
		<i>Cad1-C2</i>		+	Y16432	Meng et al., 1999
	<i>Cad1-C1</i>	+		AF174294	Tan et al., 2000	
	<i>Gossypium hirsutum</i>	<i>Cdn1</i>		+	U88318	Davis et al., 1998
		<i>Cdn1-C4</i>		+	AF270425	Townsend et al., 2005
<i>Cdn1-C5</i>		+		AY800106	Townsend et al., 2005	
	<i>Cdn1-D1</i>	+		AY800107	Townsend et al., 2005	
ζ-Carotene desaturase	<i>Arabidopsis thaliana</i>	<i>Zds</i>		+	U38550	Scolnik and Bartley, 1995
		<i>T9J14.1</i>	+		AC009465	Submitted, 2001
	<i>Beta vulgaris</i>			+	BI095871	Submitted, 2001
	<i>Helianthus annuus</i>	<i>Zds</i>		+	AJ438587	Conti et al., 2004
β-Carotene hydroxylase	<i>Arabidopsis thaliana</i>	<i>Chyb1</i>		+	U58919	Sun, Gantt, and Cunningham, 1996
		<i>At5g52570</i>	+		AY117225	Submitted, 2002
β-Carotene ketolase	' <i>Chlorella</i> '	<i>Bkt/crto</i>		+	AY772713	Submitted, 2004
		<i>Bkt/crto</i>	+		AY772714	Submitted, 2004
	<i>Haematococcus pluvialis</i>	<i>Bkt1</i>		+	D45881	Kajiwara et al., 1995
		<i>Bkt2</i> <i>Bkt3</i>	+		AY334016 AY603347	Submitted, 2003 Submitted, 2004
Chrysanthemyl pyrophosphate synthase	<i>Artemisia tridentata</i>	<i>Fds-5</i>		+	AY308478	Hemmerlin et al., 2003
β-Cyclohexenyl carotenoid epoxidase	<i>Capsicum annuum</i>	<i>GT11</i>		+	X91491	Bouvier et al., 1996

Continued.

TABLE 3.6 (Continued)

Some Cloned Plant Genes Involved in Isoprenoid Biosynthesis Found Using the NCBI GenBank Database (Correlated to Table 3.5)

Enzyme	Organism	Gene	Clone Type		Accession Number	Ref.	
			Genomic	cDNA			
Farnesyl pyrophosphate synthase	<i>Arabidopsis thaliana</i>			+	X75789	Delourme, Lacroute, and Karst, 1994	
		<i>Fps1</i>	+		L46367	Cunillera et al., 1996	
			<i>Fps2</i>		+	L46349	Cunillera et al., 1996
			<i>Fps2</i>	+		L46350	Cunillera et al., 1996
	<i>Artemisia annua</i>	<i>Fps1</i>		+		U36376	Matsushita et al., 1996
	<i>Capsicum annuum</i>	<i>Fps</i>		+		X84695	Huguency et al., 1996
	<i>Hevea brasiliensis</i>			+		Z49786	Adiwilaga and Kush, 1996
	<i>Humulus lupulus</i>	<i>Fpps</i>		+		AB053487	Submitted, 2001
		<i>Fpps</i>	+			AB053486	Submitted, 2001
	<i>Lupinus albus</i>	<i>Fps1</i>		+		U15777	Attucci et al., 1995
				+		U20771	Attucci et al., 1995
	<i>Mentha x piperita</i>			+		AF384040	Lange et al., 2000
	<i>Musa acuminata</i>	<i>Fpps</i>		+		AF470318	Submitted, 2002
	<i>Parthenium argentatum</i>	<i>Fps1</i>		+		X82542	Pan, Herickhoff, and Backhaus, 1996
		<i>Fps2</i>		+		X82543	Pan, Herickhoff, and Backhaus, 1996
	<i>Prunus dulcis</i>			+		BU645476	Submitted, 2003
<i>Zea mays</i>	<i>Fps</i>		+		L39789	Li and Larkins, 1995	
Geranyl-geranyl pyrophosphate hydrogenase	Only predicted clones are available						
Geranyl-geranyl pyrophosphate synthase	<i>Arabidopsis thaliana</i>	<i>Ggps</i>		+	L25813	Scolnik and Bartley, 1994	
		<i>Ggps2</i>		+	U44876	Scolnik and Bartley, 1996	
		<i>Ggps3</i>		+	AK117933	Submitted, 2002	
		<i>Ggps2</i>		+	NM_119845	Submitted, 2003	
		<i>Ggps6</i>		+	NM_103841	Submitted, 2003	
		<i>Ggps1</i>		+	NM_119845	Submitted, 2004	
		<i>At3g32040</i>		+	AK221451	Submitted, 2005	
	<i>Capsicum annuum</i>		+		X80267	Badillo et al., 1995	
	<i>Catharanthus roseus</i>	<i>Ggpps</i>	+		X92893	Bantignies, Liboz, and Ambid, 1996	
	<i>Cistus creticus</i>	<i>Ggpps1</i>		+		AF492022	Submitted, 2002
		<i>Ggpps2</i>		+		AF492023	Submitted, 2002
	<i>Croton sublyratus</i>			+		AB034249	Submitted, 1999
	<i>Gentiana lutea</i>	<i>GENggpps</i>		+		AB028667	Submitted, 1999
	<i>Helianthus annuus</i>	<i>Ggps</i>		+		AF020041	Submitted, 1998
	<i>Lupinus albus</i>	<i>Ggps1</i>		+		U15778	Aitken et al., 1995
	<i>Plectranthus barbatus</i>			+		AY515700	Engprasert et al., 2004
	<i>Scoparia dulcis</i>			+		AB034250	Submitted, 1999
	<i>Sinapis alba</i>	<i>Ggps</i>		+		X98795	Bonk et al., 1997
<i>Taxus canadensis</i>			+		AF081514	Hefner, Ketchum, and Croteau, 1998	

TABLE 3.6 (Continued)

Some Cloned Plant Genes Involved in Isoprenoid Biosynthesis Found Using the NCBI GenBank Database (Correlated to Table 3.5)

Enzyme	Organism	Gene	Clone Type		Accession Number	Ref.	
			Genomic	cDNA			
Hexaprenyl-pyrophosphate synthase	Found in many bacterial genomes						
Isopentenyl-pyrophosphate isomerase	<i>Adonis palaestina</i>	<i>IpiAa1</i>		+	AF188060	Cunningham and Gantt, 2000	
	<i>Arabidopsis thaliana</i>	<i>Ipi1</i>		+	U48961	Blanc, Mullin, and Pichersky, 1996	
		<i>Ipp1</i>	+		U47324	Campbell et al., 1998	
		<i>Ipp2</i>		+	U49259	Campbell et al., 1998	
		<i>IpiAt1</i>		+	AF188066	Cunningham and Gantt, 2000	
					+	AY093749	Submitted, 2002
		<i>Brassica oleracea</i>	<i>Ipi</i>		+	AF236092	Submitted, 2000
		<i>Chlamydomonas reinhardtii</i>	<i>IpiCr1</i>		+	AF082869	Sun, Cunningham, and Gantt, 1998
		<i>Clarkia breweri</i>	<i>Ipi1</i>		+	X82627	Blanc and Pichersky, 1995
			<i>Ipi2</i>	+		U48963	Blanc, Mullin, and Pichersky, 1996
		<i>Clarkia xantiana</i>	<i>Ipi2</i>	+		U48962	Blanc, Mullin, and Pichersky, 1996
		<i>Haematococcus pluvialis</i>	<i>IpiHp1</i>		+	AF082325	Sun, Gantt, and Cunningham, 1996
			<i>IpiHp2</i>		+	AF082326	Sun, Cunningham, and Gantt, 1998
		<i>Hevea brasiliensis</i>	<i>Ipi1</i>		+	AF111842	Submitted, 1998
			<i>Ipi2</i>		+	AF111843	Submitted, 1998
		<i>Lactuca sativa</i>	<i>IpiLs1</i>		+	AF188062	Cunningham and Gantt, 2000
		<i>Melaleuca alternifolia</i>	<i>Idi1</i>		+	AF483191	Shelton, Leach, and Henry, 2004
			<i>Idi2</i>		+	AF483190	Shelton, Leach, and Henry, 2004
		<i>Nicotiana tabacum</i>	<i>Ipi</i>		+	Y09634	Submitted, 1996
		<i>Pueraria montana</i>	<i>Ipi</i>		+	AY315650	Sharkey et al., 2005
	<i>Zea mays</i>			+	AF330034	Submitted, 2000	
ent-Kaurene synthase	<i>Arabidopsis thaliana</i>	<i>GA2</i>		+	AF034774	Yamaguchi et al., 1998	
		<i>GA1</i>		+	NM_116512	Submitted, 2004	
		<i>GA2</i>		+	NM_106594	Submitted, 2004	
	<i>Cucumis sativus</i>	<i>CsKSI</i>		+	AB045310	Submitted, 2000	
	<i>Cucurbita maxima</i>			+	U43904	Yamaguchi et al., 1996	

Continued.



TABLE 3.6 (Continued)

Some Cloned Plant Genes Involved in Isoprenoid Biosynthesis Found Using the NCBI GenBank Database (Correlated to Table 3.5)

Enzyme	Organism	Gene	Clone Type		Accession Number	Ref.	
			Genomic	cDNA			
	<i>Hordeum vulgare</i>	<i>Ksl1</i>		+	AY551436	Spielmeyer et al., 2004	
	<i>Lactuca sativa</i>	<i>LsKS1</i>		+	AB031205	Submitted, 1999	
	<i>Oryza sativa</i>	<i>OsKS1A</i>		+	AY347876	Margis-Pinheiro et al., 2005	
		<i>OsKS1B</i>		+	AY347877	Margis-Pinheiro et al., 2005	
		<i>OsKS1C</i>		+	AY347878	Margis-Pinheiro et al., 2005	
	<i>Pisum sativum</i>	<i>LS</i>		+	U63652	Ait-Ali et al., 1997	
4s-Limonene synthase	<i>Abies grandis</i>	<i>AG10</i>		+	AF006193	Bohlmann, Steele, and Croteau, 1997	
			+		AF326518	Trapp and Croteau, 2001	
	<i>Mentha spicata</i>			+	L13459	Colby et al., 1993	
	<i>Perilla frutescens</i>			+	D49368	Yuba et al., 1996	
s-Linalool synthase	<i>Arabidopsis thaliana</i>	<i>Atlg61120</i>		+	BT001960	Submitted, 2002	
	<i>Clarkia breweri</i>	<i>Lis1</i>		+	U58314	Dudareva et al., 1996	
		<i>Lis1</i>	+		AF067601	Cseke, Dudareva, and Pichersky, 1998	
		<i>Lis2</i>		+	AF067603	Cseke, Dudareva, and Pichersky, 1998	
Lycopene cyclase (β)	<i>Adonis palaestina</i>	<i>Lcyb</i>		+	AF321534	Cunningham and Gantt, 2001	
	<i>Arabidopsis thaliana</i>	<i>Lyc</i>		+	L40176	Scolnik and Bartley, 1995	
				+	U50739	Cunningham et al., 1996	
				+	AF117256	Submitted, 1998	
			<i>Lyc</i>		+	NM_111858	Submitted, 2003
	<i>Capsicum annuum</i>	<i>crtL</i>			+	X86221	Huguency et al., 1995
	<i>Citrus maxima</i>				+	AY217103	Submitted, 2003
	<i>Citrus sinensis</i>	<i>Lcyb</i>		+	AF240787	Submitted, 2001	
				+	AY094582	Submitted, 2002	
				+	AY679167	Submitted, 2004	
				+	AY679168	Submitted, 2004	
			<i>Lycb</i>	+	AY644699	Submitted, 2004	
	<i>Lycium barbarum</i>	<i>Lycb</i>			+	AY906864	Submitted, 2005
	<i>Lycopersicon esculentum</i>	<i>CrtL-1</i>			+	X86452	Cunningham et al., 1996
					+	AF254793	Ronen et al., 2000
	<i>Narcissus pseudonarcissus</i>	<i>Lyc</i>			+	X98796	Al-Babili, Hobeika, and Beyer, 1996
<i>Nicotiana tabacum</i>	<i>CrtL-1</i>			+	X81787	Cunningham et al., 1996	
<i>Sandersonia aurantiaca</i>				+	AF489520	Submitted, 2002	
<i>Tagetes erecta</i>				+	AF251017	Moehs et al., 2001	
		<i>Lcy-b</i>		+	AY099484	Submitted, 2002	
<i>Zea mays</i>	<i>PS1</i>		+		AY206862	Singh et al., 2003	

TABLE 3.6 (Continued)

Some Cloned Plant Genes Involved in Isoprenoid Biosynthesis Found Using the NCBI GenBank Database (Correlated to Table 3.5)

Enzyme	Organism	Gene	Clone Type		Accession Number	Ref.	
			Genomic	cDNA			
Lycopene cyclase (ε)	<i>Adonis palaestina</i>	<i>Lcye</i>		+	AF321535	Cunningham and Gantt, 2001	
		<i>Lcye</i>		+	AF321536	Cunningham and Gantt, 2001	
	<i>Arabidopsis thaliana</i>			+	BD232168	Submitted, 2002	
					U50738	Cunningham et al., 1996	
				+	AF117257	Submitted, 1998	
		<i>At5g57030</i>		+	NM_125085	Submitted, 2004	
	<i>Citrus maxima</i>			+	AY994158	Submitted, 2005	
	<i>Citrus x paradisi</i>			+	AF486650	Submitted, 2002	
	<i>Citrus sinensis</i>	<i>Elcy</i>		+	AY533827	Submitted, 2004	
	<i>Lactuca sativa</i>	<i>Lcye</i>		+	AF321538	Cunningham and Gantt, 2001	
	<i>Lycopersicon esculentum</i>	<i>CrtL-e-1</i>			Y14387	Submitted, 1997	
	<i>Spinacia oleracea</i>	<i>Lec</i>		+	AF463497	Submitted, 2001	
	<i>Tagetes erecta</i>			+	AF251016	Moehs et al., 2001	
		<i>Lcy-e</i>		AY099485	Submitted, 2002		
Mevalonate 5-pyrophosphate decarboxylase	<i>Arabidopsis thaliana</i>			+	H36293	Submitted, 1994	
	Found in many bacterial and vertebrate genomes						
Mevalonate kinase	<i>Arabidopsis thaliana</i>	<i>Mk</i>		+	X77793	Riou et al., 1994	
		<i>Mk</i>	+		L77688	Submitted, 1998	
		<i>Mvk</i>	+		AF141853	Lluch et al., 2000	
		<i>At5g27450</i>		+	BT002104	Submitted, 2002	
		<i>Mk</i>		+	NM_122627	Submitted, 2003	
	<i>Hevea brasiliensis</i>			+	AF429384	Submitted, 2001	
Oxidosqualene cyclase (cycloartenol synthase)	<i>Abies magnifica</i>	<i>Cas1</i>		+	AF216755	Submitted, 1999	
	<i>Allium macrostemon</i>	<i>ALLOsc1</i>		+	AB025353	You et al., 1999	
	<i>Arabidopsis thaliana</i>	<i>Cas1</i>			+	U02555	Corey, Matsuda, and Bartel, 1993
		<i>AtLup1</i>			+	U87266	Husselstein-Muller, Schaller, and Benveniste, 2001
		<i>At1g66960</i>			+	AF489920	Submitted, 2002
		<i>Lup1</i>			+	NM_106546	Submitted, 2005
		<i>Lup1</i>			+	NM_179572	Submitted, 2005
		<i>Cas1</i>			+	NM_126681	Submitted, 2005
	<i>Betula platyphylla</i>	<i>CasBpX1</i>			+	AB055509	Submitted, 2001
		<i>CasBpX2</i>			+	AB055510	Submitted, 2001
	<i>Centella asiatica</i>	<i>OscCCS</i>			+	AY520819	Submitted, 2004
	<i>Costus speciosus</i>	<i>CsOSC1</i>			+	AB058507	Kawano, Ichinose, and Ebizuka, 2002

Continued.

TABLE 3.6 (Continued)

Some Cloned Plant Genes Involved in Isoprenoid Biosynthesis Found Using the NCBI GenBank Database (Correlated to Table 3.5)

Enzyme	Organism	Gene	Clone Type		Accession Number	Ref.
			Genomic	cDNA		
	<i>Cucurbita pepo</i>	<i>Cpx</i>		+	AB116237	Submitted, 2003
	<i>Glycyrrhiza glabra</i>	<i>GgCAS1</i>		+	AB025968	Hayashi et al., 2000
	<i>Luffa cylindrica</i>	<i>LcCAS1</i>		+	AB033334	Hayashi et al., 1999
		<i>LcOSC2</i>		+	AB033335	Hayashi et al., 2000
	<i>Panax ginseng</i>	<i>OscPNZ1</i>		+	AB009031	Submitted, 1997
		<i>OscPNX1</i>		+	AB009029	Kushiro, Shibuya, and Ebizuka, 1998
	<i>Pisum sativum</i>	<i>CasPEA</i>		+	D89619	Morita et al., 1997
	<i>Taraxacum officinale</i>	<i>Trv</i>		+	AB025346	Shibuya et al., 1999
Phytoene desaturase	<i>Arabidopsis thaliana</i>			+	L16237	Scolnik and Bartley, 1993
		<i>Pds</i>		+	NM_202816	Submitted, 2005
	<i>Chlamydomonas reinhardtii</i>	<i>Pds</i>		+	AY604703	McCarthy, Kobayashi, and Niyogi, 2004
	<i>Citrus x paradisi</i>			+	AF364515	Submitted, 2001
	<i>Citrus unshiu</i>	<i>CitPDS1</i>		+	AB046992	Kita et al., 2001
	<i>Crocus sativus</i>	<i>Pds</i>		+	AY183118	Submitted, 2002
	<i>Gentiana lutea</i>	<i>SGENPds</i>		+	AB028665	Submitted, 1999
		<i>HGENPds</i>		+	AB028666	Submitted, 1999
	<i>Glycine max</i>	<i>Pds1</i>		+	M64704	Bartley et al., 1991
	<i>Haematococcus pluvialis</i>	<i>Pds</i>	+		AY768691	Submitted, 2004
	<i>Hydrilla verticillata</i>	<i>Pds</i>		+	AY639658	Michel et al., 2004
	<i>Lycopersicon esculentum</i>	<i>Pds</i>		+	M88683	Giuliano, Bartley, and Scolnik, 1993
	<i>Momordica charantia</i>	<i>Pds</i>		+	AY494790	Submitted, 2003
	<i>Prunus armeniaca</i>			+	AY822065	Submitted, 2004
	<i>Tagetes erecta</i>	<i>Pds</i>		+	AF251014	Moehs et al., 2001
		<i>Pds</i>		+	AY099483	Submitted, 2002
	<i>Zea mays</i>	<i>Pds</i>		+	L39266	Hable and Oishi, 1995
		<i>Pds</i>		+	U37285	Li et al., 1996

TABLE 3.6 (Continued)

Some Cloned Plant Genes Involved in Isoprenoid Biosynthesis Found Using the NCBI GenBank Database (Correlated to Table 3.5)

Enzyme	Organism	Gene	Clone Type		Accession Number	Ref.
			Genomic	cDNA		
Phytoene synthase	<i>Arabidopsis thaliana</i>	<i>Psy</i>		+	L25812	Bartley and Scolnik, 1994
		<i>Psy</i>	+		AF009954	Submitted, 1997
		<i>At5g17230</i>		+	BT002084	Submitted, 2002
		<i>Psy</i>		+	NM_121729	Submitted, 2003
	<i>Chlamydomonas reinhardtii</i>	<i>At5g17230</i>		+	AK221142	Submitted, 2005
		<i>Psy-LTS1</i>	+		AY604701	McCarthy, Kobayashi, and Niyogi, 2004
		<i>Psy-LTS1</i>	+		AY604702	McCarthy, Kobayashi, and Niyogi, 2004
	<i>Citrus x paradisi</i>	<i>Psy</i>		+	AF152892	Submitted, 2001
	<i>Citrus unshiu</i>	<i>Psy1</i>		+	AF220218	Submitted, 1999
				+	AB037975	Ikoma et al., 2001
	<i>Daucus carota</i>	<i>Psy</i>		+	AB032797	Submitted, 1999
	<i>Dunaliella bardawil</i>			+	U91900	Submitted, 1997
	<i>Dunaliella salina</i>			+	AY601075	Submitted, 2004
				+	AY547325	Submitted, 2004
	<i>Haematococcus pluvialis</i>			+	DQ057355	Submitted, 2005
	<i>Lycium barbarum</i>			+	AY920918	Submitted, 2005
	<i>Lycopersicon esculentum</i>	<i>Psy1</i>		+	M84744	Bartley et al., 1992
		<i>Psy2</i>		+	L23424	Bartley and Scolnik, 1993
	<i>Momordica charantia</i>	<i>Psy</i>		+	AY494789	Submitted, 2003
	<i>Oncidium Gower Ramsey</i>	<i>Psy</i>		+	AY496865	Submitted, 2003
	<i>Oryza sativa</i>	<i>Psy</i>	+		AY024351	Gallagher et al., 2004
		<i>Psy</i>		+	AY445521	Gallagher et al., 2004
<i>Tagetes erecta</i>	<i>Psy</i>		+	AY099482	Submitted, 2002	
<i>Zea mays</i>	<i>Y1</i>	+		U32636	Buckner et al., 1995	
	<i>Psy1</i>	+		AY324431	Gallagher et al., 2004	
	<i>Psy2</i>	+		AY325302	Gallagher et al., 2004	
	<i>Y1</i>	+		AY455286	Palaisa et al., 2004	
Squalene epoxidase	<i>Arabidopsis thaliana</i>	<i>Sqp1,1</i>		+	NM_122320	Submitted, 2005
		<i>Sqp1,2</i>		+	NM_122321	Submitted, 2005
		<i>Sqp2</i>		+	NM_122319	Submitted, 2005
	<i>Panax ginseng</i>			+	AB003516	Submitted, 1997
				+	AB122078	Submitted, 2004

Continued.

TABLE 3.6 (Continued)

Some Cloned Plant Genes Involved in Isoprenoid Biosynthesis Found Using the NCBI GenBank Database (Correlated to Table 3.5)

Enzyme	Organism	Gene	Clone Type		Accession Number	Ref.
			Genomic	cDNA		
Squalene synthase	<i>Arabidopsis thaliana</i>	<i>Erg9</i>		+	D29017	Nakashima et al., 1995
		<i>Sqs1</i>		+	X86692	Kribii et al., 1997
		<i>Sqs1</i>		+	NM_119630	Submitted, 2005
		<i>Sqs2</i>		+	NM_119631	Submitted, 2005
	<i>Artemisia annua</i>		+	AY445506	Submitted, 2003	
	<i>Capsicum annuum</i>	<i>SS</i>	+	AF124842	Lee et al., 2002	
	<i>Centella asiatica</i>	<i>Sqs</i>	+	AY787628	Submitted, 2004	
	<i>Lotus corniculatus</i>		+	AB102688	Submitted, 2003	
	<i>Nicotiana benthamiana</i>		+	U46000	Hanley et al., 1996	
	<i>Panax ginseng</i>	<i>Pss</i>	+	AB115496	Lee et al., 2004	
Taxadiene synthase	<i>Taxus baccata</i>	<i>Tasy</i>	+		AJ320538	Submitted, 2001
		<i>Txs</i>		+	AY424738	Submitted, 2003
	<i>Taxus brevifolia</i>	<i>Tdc1</i>		+	U48796	Submitted, 1996
	<i>Taxus canadensis</i>		+	+	AY364469	Submitted, 2003
	<i>Taxus chinensis</i>		+	+	AY007207	Wang et al., 2002
	<i>Taxus x media</i>	<i>Txs</i>	+	+	AY365032	Submitted, 2005
Vetispiradiene synthase	<i>Lycopersicon esculentum</i>	<i>LeVS2</i>	+		AF171216	Submitted, 1999
		<i>Hyoscyamus muticus</i>	<i>cVS1</i>		+	U20188
		<i>cVS2</i>		+	U20189	Back and Chappell, 1995
		<i>cVS3</i>		+	U20190	Back and Chappell, 1995
	<i>Solanum tuberosum</i>	<i>VS1</i>		+	AF042382	Submitted, 1998
		<i>Pvs1</i>		+	AB022598	Yoshioka, Yamada, and Doke, 1999
		<i>Pvs2</i>		+	AB022719	Yoshioka, Yamada, and Doke, 1999
		<i>Pvs3</i>		+	AB022720	Yoshioka, Yamada, and Doke, 1999
	<i>Pvs4</i>		+	AB023816	Yoshioka, Yamada, and Doke, 1999	

**TABLE 3.6 (Continued)**

Some Cloned Plant Genes Involved in Isoprenoid Biosynthesis Found Using the NCBI GenBank Database (Correlated to Table 3.5)

Enzyme	Organism	Gene	Clone Type		Accession Number	Ref.	
			Genomic	cDNA			
Violaxanthin de-epoxidase	<i>Arabidopsis thaliana</i>	<i>AVde1</i>		+	U44133	Bugos, Hieber, and Yamamoto, 1998	
	<i>Camellia sinensis</i>	<i>Vde</i>		+	AF462269	Submitted, 2001	
	<i>Lactuca sativa</i>	<i>Vde1</i>		+	U31462	Bugos and Yamamoto, 1996	
	<i>Nicotiana tabacum</i>	<i>TVde1</i>		+	U34817	Bugos, Hieber, and Yamamoto, 1998	
	<i>Oryza sativa</i>	<i>RVde1</i>		+	AF468689	Submitted, 2001	
		<i>RVde1</i>		+	AF288196	Submitted, 2001	
		<i>RVde1</i>		+	AF411133	Submitted, 2001	
	<i>Spinacia oleracea</i>	<i>SVde1</i>		+	AJ250433	Emanuelsson, Eskling, and Akerlund, 2003	
	<i>Triticum aestivum</i>	<i>WVde</i>		+	AF265294	Submitted, 2000	
	Zeaxanthin epoxidase	<i>Arabidopsis thaliana</i>		+		AF134577	Submitted, 1999
					+	AF281655	Submitted, 1999
<i>Zep</i>					+	AF283761	Submitted, 2000
<i>Zep</i>			+			AF134578	Submitted, 2000
<i>At5g67030</i>					+	BT002560	Submitted, 2002
<i>Chlamydomonas reinhardtii</i>		<i>Zep</i>			+	NM_126103	Submitted, 2005
		<i>Zep1</i>		+		AY212923	Baroli et al., 2003
		<i>Zep1</i>	+			AY211267	Baroli et al., 2003
<i>Citrus unshiu</i>		<i>Cit-ZEP</i>			+	AB075547	Submitted, 2001
		<i>Nicotiana plumbaginifolia</i>	<i>Aba2</i>		+	X95732	Marin et al., 1996
<i>Oryza sativa</i>		<i>OsABA2</i>		+	AB050884	Agrawal et al., 2001	
<i>Thellungiella halophila</i>		<i>Zep</i>		+	AY842302	Submitted, 2004	
<i>Vitis vinifera</i>		<i>Zep</i>		+	AY337615	Soar et al., 2004	

Note: There are currently many more sequences available from large-scale genomic sequencing projects. The sequences in this table are only a partial listing.

### 3.7 Conclusions

We covered the primary ways by which metabolite biosynthesis is regulated by environmental, biotic, biochemical, and molecular signals. These mechanisms mostly impinge on the regulation of rates of enzyme activity or on the regulation of gene expression for particular enzymes. Also of importance in such regulation is the concept of DNA, RNA, and protein (enzyme) turnover, where one must consider rates of synthesis versus rates of degradation. Metabolite homeostasis refers to all the inputs and outputs that affect the level of a given metabolite in plant cells. The inputs refer to the rates of synthesis of a given metabolite. The outputs refer to the rates of degradation of the metabolite to other metabolites or oxidation products as well as to the rates of formation of conjugates of the metabolite (e.g., glucosyl, amide-linked conjugates, of myoinositol ester conjugates, as seen with the plant hormone, indole-3-acetic acid). All of these inputs and outputs affect the level of a given metabolite. Once research provides an understanding of the above factors, as well as an understanding of the enzymes controlling the biosynthetic pathways leading to the production of specific metabolites, steps can be taken to either

increase or decrease the levels of these metabolites produced by plants. These steps include controlled environmental conditions, simulated herbivory, metabolite feeds, use of plant growth regulators and fungal elicitors, and transgenic overexpression and gene-suppression technology. However, finding the best way to adjust the production of a given metabolite is by no means an easy task. Each individual biosynthetic pathway is regulated by a vast array of environmental, biotic, biochemical, and molecular factors. These factors allow for the incredible variety of metabolite activities that control the overall growth and development and environmental interactions of each plant.

---

## References

- Adiwilaga, K. and A. Kush. (1996). Cloning and characterization of cDNA encoding farnesyl diphosphate synthase from rubber tree (*Hevea brasiliensis*). *Plant Mol Biol* 30: 935–946.
- Agrawal, G.K., M. Yamazaki, M. Kobayashi, R. Hirochika, A. Miyao, and H. Hirochika. (2001). Screening of the rice viviparous mutants generated by endogenous retrotransposon Tos17 insertion. Tagging of a zeaxanthin epoxidase gene and a novel ostatic gene. *Plant Physiol* 125: 1248–1257.
- Ait-Ali, T., S.M. Swain, J.B. Reid, T. Sun, and Y. Kamiya. (1997). The LS locus of pea encodes the gibberellin biosynthesis enzyme ent-kaurene synthase A. *Plant J* 11: 443–454.
- Aitken, S.M., S. Attucci, R.K. Ibrahim, and P.J. Gulick. (1995). A cDNA encoding geranylgeranyl pyrophosphate synthase from white lupin. *Plant Physiol* 108(2): 837–838.
- Al-Babili, S., E. Hobeika, and P. Beyer. (1996). A cDNA encoding lycopene cyclase from *Narcissus pseudonarcissus* L. (PGR96-107). *Plant Physiol* 112: 1398.
- Alborn, H.T., T.C.J. Turlings, T.H. Jones, G. Stenhagen, J.H. Loughrin, and J.H. Tumlinson. (1997). An elicitor of plant volatiles from beet armyworm oral secretion. *Science* 276: 945–949.
- Alvarez-Buylla, E.R., S.J. Liljegren, S. Pelaz, S.J. Gold, C. Burgeff, G.S. Ditta, F. Vergara-Silva, and M.F. Yanofsky. (2000a). MADS-box gene evolution beyond flowers: expression in pollen, endosperm, guard cells, roots and trichomes. *Plant J* 24: 457–466.
- Alvarez-Buylla, E.R., S. Pelaz, S.J. Liljegren, S.J. Gold, C. Burgeff, G.S. Ditta, L. Ribas de Pouplana, L. Martínez-Castilla, and M.F. Yanofsky. (2000b). An ancestral MADS-box duplication occurred before the divergence of plants and animals. *Proc Nat Acad Sci USA* 97: 5328–5333.
- Anderson, J.W. and J. Beardall. (1991). Enzymes and post-translational enzyme regulation. In *Molecular Activities of Plant Cells. An Introduction to Plant Biochemistry*. Blackwell Scientific, Oxford, pp. 61–82.
- Attucci, S., S.M. Aitken, R.K. Ibrahim, and P.J. Gulick. (1995). A cDNA encoding farnesyl pyrophosphate synthase in white lupin. *Plant Physiol* 108: 835–836.
- Back, K. and J. Chappell. (1995). Cloning and bacterial expression of a sesquiterpene cyclase from *Hyoscyamus muticus* and its molecular comparison to related terpene cyclases. *J Biol Chem* 270: 7375–7381.
- Badillo, A., J. Steppuhn, J. Deruere, B. Camara, and M. Kuntz. (1995). Structure of a functional geranylgeranyl pyrophosphate synthase gene from *Capsicum annum*. *Plant Mol Biol* 27: 425–428.
- Bantignies, B., T. Liboz, and C. Ambid. (1996). Nucleotide sequence of a *Catharanthus roseus* geranylgeranyl pyrophosphate synthase gene (Accession No. X92893). *Plant Physiol* 110: 336.
- Baroli, I., A.D. Do, T. Yamane, and K.K. Niyogi. (2003). Zeaxanthin accumulation in the absence of a functional xanthophyll cycle protects *Chlamydomonas reinhardtii* from photooxidative stress. *Plant Cell* 15: 992–1008.
- Bartley, G.E. and P.A. Scolnik. (1993). cDNA cloning, expression during development, and genome mapping of PSY2, a second tomato gene encoding phytoene synthase. *J Biol Chem* 268: 25718–25721.
- Bartley, G.E., P.V. Viitanen, K.O. Bacot, and P.A. Scolnik. (1992). A tomato gene expressed during fruit ripening encodes an enzyme of the carotenoid biosynthesis pathway. *J Biol Chem* 267: 5036–5039.
- Bartley, G.E., P.V. Viitanen, I. Pecker, D. Chamovitz, J. Hirschberg, and P.A. Scolnik. (1991). Molecular cloning and expression in photosynthetic bacteria of a soybean cDNA coding for phytoene desaturase, an enzyme of the carotenoid biosynthesis pathway. *Proc Natl Acad Sci USA* 88: 6532–6536.
- Blanc, V.M. and E. Pichersky. (1995). Nucleotide sequence of a *Clarkia breweri* cDNA clone of Ipi1, a gene encoding isopentenyl pyrophosphate isomerase. *Plant Physiol* 108(2): 855–856.
- Blanc, V.M., K. Mullin, and E. Pichersky. (1996). Nucleotide sequences of Ipi genes from *Arabidopsis* and *Clarkia*. (Accession Nos. U48961, U48962, U48963) (PGR96-036). *Plant Physiol* 111: 652.

- Bohlmann, J., E.J. Stauber, B. Krock, N.J. Oldham, J. Gershenzon, and I.T. Baldwin. (2002). Gene expression of 5-epi-aristolochene synthase and formation of capsidiol in roots of *Nicotiana attenuata* and *N. sylvestris*. *Phytochemistry* 60: 109–116.
- Bohlmann, J., C.L. Steele, and R. Croteau. (1997). Monoterpene synthases from grand fir (*Abies grandis*). cDNA isolation, characterization, and functional expression of myrcene synthase, (-)-(4S)-limonene synthase, and (-)-(1S,5S)-pinene synthase. *J Biol Chem* 272(35): 21784–21792.
- Boik, J. (1996). Dietary non-nutrient factors and their effects on cancer. In *Cancer and Natural Medicine. A Textbook of Basic Science and Clinical Research*, chap. 14. Oregon Medical Press, Princeton, Minnesota.
- Bonk, M., B. Hoffmann, J. Von Lintig, M. Schledz, S.W. Al-Babili, E. Hobeika, H. Kleinig, and P. Beyer. (1997). Chloroplast import of four carotenoid biosynthetic enzymes *in vitro* reveals differential fates prior to membrane binding and oligomeric assembly. *Eur J Biochem* 247: 942–950.
- Bouvier, F., A. d'Harlingue, P. Huguency, E. Marin, A. Marion-Poll, and B. Camara. (1996). Xanthophyll biosynthesis. Cloning, expression, functional reconstitution, and regulation of beta-cyclohexenyl carotenoid epoxidase from pepper (*Capsicum annuum*). *J Biol Chem* 271(46): 28861–28867.
- Buchanan, B.B., W. Gruissem, and R.L. Jones. (2000). *Biochemistry and Molecular Biology of Plants*. Amer. Soc. Plant Physiol., Rockville, MD.
- Buckner, B., P.S. Miguel, D. Janick-Buckner, and J.L. Bennetzen. (1996). The *y1* gene of maize codes for phytoene synthase. *Genetics* 143: 479–488.
- Bugos, R.C. and H.Y. Yamamoto. (1996). Molecular cloning of violaxanthin de-epoxidase from romaine lettuce and expression in *Escherichia coli*. *Proc Natl Acad Sci USA* 93: 6320–6325.
- Bugos, R.C., A.D. Hieber, and H.Y. Yamamoto. (1998). Xanthophyll cycle enzymes are members of the lipocalin family, the first identified from plants. *J Biol Chem* 273: 15321–15324.
- Campbell, M., F.M. Hahn, C.D. Poulter, and T. Leustek. (1998). Analysis of the isopentenyl diphosphate isomerase gene family from *Arabidopsis thaliana*. *Plant Mol Biol* 36(2): 323–328.
- Carmona, M.J., N. Ortega, and F. Garcia-Maroto. (1998). Isolation and molecular characterization of a new vegetative MADS-box gene from *Solanum tuberosum* L. *Planta* 207: 181–188.
- Chen, X.Y., Y. Chen, P. Heinstein, and V.J. Davisson. (1995). Cloning, expression, and characterization of (+)-delta-cadinene synthase: a catalyst for cotton phytoalexin biosynthesis. *Arch Biochem Biophys* 324: 255–266.
- Chen, X.Y., M. Wang, Y. Chen, V.J. Davisson, and P. Heinstein. (1996). Cloning and heterologous expression of a second (+)-delta-cadinene synthase from *Gossypium arboreum* *J Nat Prod* 59: 944–951.
- Chuang, C.F. and E.M. Meyerowitz. (2000). Specific and heritable genetic interference by double-stranded RNA in *Arabidopsis thaliana*. *Proc Natl Acad Sci USA* 97: 4985–4999.
- Colbère-Garapin, F., B. Blondel, A. Saulnier, I. Pelletier, and K. Labadie. (2005). Silencing viruses by RNA interference. *Microbes and Infection* 7: 767–775.
- Colby, S.M., W.R. Alonso, E.J. Katahira, D.J. McGarvey, and R. Croteau. (1993). 4S-limonene synthase from the oil glands of spearmint (*Mentha spicata*). cDNA isolation, characterization, and bacterial expression of the catalytically active monoterpene cyclase. *J Biol Chem* 268: 23016–23024.
- Conti, A., S. Pancaldi, M. Fambrini, V. Michelotti, A. Bonora, M. Salvini, and C. Pugliesi. (2004). A deficiency at the gene coding for zeta-carotene desaturase characterizes the sunflower nondormant-1 mutant. *Plant Cell Physiol* 45: 445–455.
- Corey, E.J., S.P. Matsuda, and B. Bartel. (1993). Isolation of an *Arabidopsis thaliana* gene encoding cycloartenol synthase by functional expression in a yeast mutant lacking lanosterol synthase by the use of a chromatographic screen. *Proc Natl Acad Sci USA* 90: 11628–11632.
- Cornish, K. and D.J. Siler. (1996). Characterization of *cis*-prenyl transferase activity localized in a buoyant fraction of rubber particles from *Ficus elastica* latex. *Plant Physiol Biochem* 34: 337–384.
- Cseke, L., N. Dudareva, and E. Pichersky. (1998). Structure and evolution of linalool synthase. *Mol Biol Evol* 15: 1491–1498.
- Cseke, L.J. and G.K. Podila. (2004). MADS-box genes in Dioecious Aspen II: A review of MADS-box genes from trees and their potential in forest biotechnology. *Physiol and Mol Biol Plants* 10: 7–28.
- Cseke, L.J., J. Zheng, and G.K. Podila. (2003). Characterization of *PTM5* in aspen: a MADS-box gene expressed during woody vascular development. *GENE* 318: 55–67.
- Cseke, L.J., S.B. Cseke, N. Ravinder, L.C. Taylor, B. Sen, D.F. Karnosky, G.K. Podila. (2005). *SEP*-class genes in *Populus tremuloides* and their likely role in reproductive survival of poplar trees. *GENE* 358: 1–16.
- Cunillera, N., M. Arro, D. Delourme, F. Karst, A. Boronat, and A. Ferrer. (1996). *Arabidopsis thaliana* contains two differentially expressed farnesyl-diphosphate synthase genes. *J Biol Chem* 271: 7774–7780.



- Cunningham, Jr., F.X. and E. Gantt. (2000). Identification of multi-gene families encoding isopentenyl diphosphate isomerase in plants by heterologous complementation in *Escherichia coli*. *Plant Cell Physiol* 41(1): 119–123.
- Cunningham, Jr., F.X. and E. Gantt. (2001). One ring or two? Determination of ring number in carotenoids by lycopene varepsilon-cyclases. *Proc Natl Acad Sci USA* 98: 2905–2910.
- Cunningham, Jr., F.X., B. Pogson, Z. Sun, K.A. McDonald, D. DellaPenna, and E. Gantt. (1996). Functional analysis of the beta and epsilon lycopene cyclase enzymes of *Arabidopsis* reveals a mechanism for control of cyclic carotenoid formation. *Plant Cell* 8: 1613–1626.
- Davis, E.M., Y.-S. Chen, M. Essenberg, and M.L. Pierce. (1998). cDNA sequence of a (+)-delta-cadinene synthase gene (Accession No. U88318) induced in *Gossypium hirsutum* L. by bacterial infection (PGR98-040). *Plant Physiol* 116: 1192.
- Delourme, D., F. Lacroute, and F. Karst. (1994). Cloning of an *Arabidopsis thaliana* cDNA coding for farnesyl diphosphate synthase by functional complementation in yeast. *Plant Mol Biol* 26: 1867–1873.
- Ditta, G., A. Pinyopich, P. Robles, S. Pelaz, and M.F. Yanofsky. (2004). The *SEP4* gene of *Arabidopsis thaliana* functions in floral organ and meristem identity. *Curr Biol* 14: 1935–1940.
- Dudareva, N., L. Cseke, V.M. Blanc, and E. Pichersky. (1996). Evolution of floral scent in *Clarkia*: novel patterns of S-linalool synthase gene expression in the *C. breweri* flower. *Plant Cell* 8: 1137–1148.
- Duke, J. (1995). Commentary — novel psychotherapeutic drugs: a role for ethnobotany. *Psychopharm Bull* 31: 177–182.
- Emanuelsson, A.K., M. Eskling, and H.E. Akerlund. (2003). Chemical and mutational modification of histidines in violaxanthin de-epoxidase from *Spinacia oleracea*. *Physiol Plantarum* 119: 97–104.
- Engprasert, S., F. Taura, M. Kawamukai, and Y. Shoyama. (2004). Molecular cloning and functional expression of geranylgeranyl pyrophosphate synthase from *Coleus forskohlii* Briq (er). *BMC Plant Biol* 4: 18.
- Folter, S., J. Busscher, L. Colombo, A. Losa, and G.C. Angenent. (2004). Transcript profiling of transcription factor genes during silique development in *Arabidopsis*. *Plant Mol Biol* 56: 351–366.
- Folter, S.D., R.G.H. Immink, M. Kieffer, L. Parenicova, S.R. Henz, D. Weigel, M. Busscher, M. Kooiker, L. Colombo, M.M. Kater, B. Davies, and G.C. Angenent. (2005). Comprehensive interaction map of the *Arabidopsis* MADS box transcription factors. *The Plant Cell* 17: 1424–1433.
- Funk, C. and P.E. Brodelius. (1992). Phenylpropanoid metabolism in suspension cultures of *Vanilla planifolia* Andr. IV. Induction of vanillic acid formation. *Plant Physiol* 99: 256–262.
- Funk, C., E. Lewinsohn, B. Stofer Vogel, C.L. Steele, and R. Croteau. (1994). Regulation of oleoresinosis in grand fir (*Abies grandis*): coordinate induction of monoterpene and diterpene cyclases and two cytochrome P450-dependent diterpenoid hydroxylases by stem wounding. *Plant Physiol* 106: 999–1005.
- Gallagher, C.E., P.D. Matthews, F. Li, and E.T. Wurtzel. (2004). Gene duplication in the carotenoid biosynthetic pathway preceded evolution of the grasses. *Plant Physiol* 135: 1776–1783.
- Gerendas, J. and R.G. Raticliffe. (2000). Intracellular pH regulation in maize root tips exposed to ammonium at high external pH. *J Exp Bot* 51: 207–219.
- Giuliano, G., G.E. Bartley, and P.A. Scolnik. (1993). Regulation of carotenoid biosynthesis during tomato development. *Plant Cell* 5: 379–387.
- Groenewald, J.H., N.F. Hiten, and F.C. Botha. (2000). The introduction of an inverted repeat to the 5-UTR leader sequence of trans gene strongly inhibits gene expression. *Plant Cell Rep* 19: 1098–1101.
- Hable, W.E. and K.K. Oishi. (1995). Maize phytoene desaturase maps near the viviparous5 locus. *Plant Physiol* 108: 1329–1330.
- Hamilton, A.J., S. Brown, H. Yuanhai, M. Ishizuka, A. Lowe, A.-G. Alpuche Solis, and D. Grierson. (1998). A transgene with repeated DNA causes high frequency, post-transcriptional suppression of ACC-oxidase gene expression in tomato. *Plant J* 15: 737–746.
- Hanley, K.M., O. Nicolas, T.B. Donaldson, C. Smith-Monroy, G.W. Robinson, and G.M. Hellmann. (1996). Molecular cloning, *in vitro* expression and characterization of a plant squalene synthetase cDNA. *Plant Mol Biol* 30: 1139–1151.
- Hayashi, H., N. Hiraoka, Y. Ikeshiro, T. Kushiro, M. Morita, M. Shibuya, and Y. Ebizuka. (2000). Molecular cloning and characterization of a cDNA for *Glycyrrhiza glabra* cycloartenol synthase. *Biol Pharm Bull* 23: 231–234.
- Hayashi, H., N. Hiraoka, Y. Ikeshiro, K. Yazaki, S. Tanaka, T. Kushiro, M. Shibuya, and Y. Ebizuka. (1999). Molecular cloning of a cDNA encoding cycloartenol synthase from *Luffa cylindrical*. *Plant Physiol* 121: 1383.

- Hayashi, H., N. Hiraoka, Y. Ikeshiro, K. Yazaki, S. Tanaka, T. Kushiro, M. Shibuya, and Y. Ebizuka. (2000). Nucleotide sequence of a cDNA encoding putative oxidosqualene cyclase from *Luffa cylindrica* (Accession No. AB033335) (PGR00-046). *Plant Physiol* 122: 1459.
- Heard, J. and K. Dunn. (1995). Symbiotic induction of a MADS-box gene during development of alfalfa root nodules. *Proc Natl Acad Sci USA* 92: 5273–5277.
- Hefner, J., R.E. Ketchum, and R. Croteau. (1998). Cloning and functional expression of a cDNA encoding geranylgeranyl diphosphate synthase from *Taxus canadensis* and assessment of the role of this prenyltransferase in cells induced for taxol production. *Arch Biochem Biophys* 360: 62–74.
- Helliwell, C. and P. Waterhouse. (2003). Constructs and methods for high-throughput gene silencing in plants. *Methods* 30: 289–295.
- Hemmerlin, A., S.B. Rivera, H.K. Erickson, and C.D. Poulter. (2003). Enzymes encoded by the farnesyl diphosphate synthase gene family in the big sagebrush *Artemisia tridentata* ssp. *Spiciformis*. *J Biol Chem* 278: 32132–32140.
- Huang, H., M. Tudor, C.A. Weiss, Y. Hu, and H. Ma. (1995). The *Arabidopsis* MADS-box gene *AGL3* is widely expressed and encodes a sequence-specific DNA-binding protein. *Plant Mol Biol* 28: 549–567.
- Huguene, P., A. Badillo, H.C. Chen, A. Klein, J. Hirschberg, B. Camara, and M. Kuntz. (1995). Metabolism of cyclic carotenoids: a model for the alteration of this biosynthetic pathway in *Capsicum annuum* chromoplasts. *Plant J* 8: 417–424.
- Huguene, P., F. Bouvier, A. Badillo, J. Quennemet, A. d'Harlingue, and B. Camara. (1996). Developmental and stress regulation of gene expression for plastid and cytosolic isoprenoid pathways in pepper fruits. *Plant Physiol* 111: 619–626.
- Husselstein-Muller, T., H. Schaller, and P. Benveniste. (2001). Molecular cloning and expression in yeast of 2,3-oxidosqualene-triterpenoid cyclases from *Arabidopsis thaliana*. *Plant Mol Biol* 45(1): 75–92.
- Ikoma, Y., A. Komatsu, M. Kita, K. Ogawa, M. Omura, M. Yano, and T. Moriguchi. (2001). Expression of a phytone synthase gene and characteristic caroteno accumulation during citrus fruit development. *Physiol Plantarum* 111: 232–238.
- Jacobsen, J.V., F. Gubler, and P.M. Chandler. (1995). Gibberellin action in germinated cereal grains. In *Plant Hormones, Physiology, Biochemistry and Molecular Biology*, chap. D-3, P.J. Davies (Ed.). Kluwer Academic, Dordrecht, The Netherlands, pp. 246–271.
- Jorgensen, R.A., P.D. Cluster, J. English, Q. Que, and C.A. Napoli. (1996). Chalcone synthase cosuppression phenotypes in petunia flowers: comparison of sense vs. antisense constructs and single-copy vs. complex T-DNA sequences. *Plant Mol Biol* (Aug. 31) (5): 957–973.
- Kajiwara, S., T. Kakizono, T. Saito, K. Kondo, T. Ohtani, N. Nishio, S. Nagai, and N. Misawa. (1995). Isolation and functional identification of a novel cDNA for astaxanthin biosynthesis from *Haematococcus pluvialis*, and astaxanthin synthesis in *Escherichia coli*. *Plant Mol Biol* 29: 343–352.
- Kaufman, P.B. and P. Dayanandan. (1983). Gibberellin-induced growth in *Avena* internodes. In *The Biochemistry and Physiology of Gibberellins*, Vol. I, A. Crosier (Ed.). Praeger, New York, pp. 129–157.
- Kaufman, P.B., J.A. Duke, H. Briemann, J. Boik, and J.E. Hoyt. (1997). A comparative survey of leguminous plants as sources of the isoflavones, genistein and daidzein: implications for human nutrition and health. *J Altern Complem Med* 3: 7–12.
- Kaufman, P.B., N.S. Ghosheh, J.D. LaCroix, S.L. Soni, and H. Ikuma. (1973). Regulation of invertase levels in *Avena* stem segments by gibberellic acid, sucrose, glucose, and fructose. *Plant Physiol* 52: 221–228.
- Kaufmann, K., R. Melzer, and G. Theissen. (2005). MIKC-type MADS-domain proteins: structural modularity, protein interactions and network evolution in land plants. *Gene* 347: 183–198.
- Kawano, N., K. Ichinose, and Y. Ebizuka. (2002). Molecular cloning and functional expression of cDNAs encoding oxidosqualene cyclases from *Costus speciosus*. *Biol Pharm Bull* 25: 477–482.
- Kita, M., A. Komatsu, M. Omura, M. Yano, Y. Ikoma, and T. Moriguchi. (2001). Cloning and expression of CitPDS1, a gene encoding phytoene desaturase in citrus. *Biosci Biotechnol Biochem* 65: 1424–1428.
- Kribii, R., M. Arro, A. Del Arco, V. Gonzalez, L. Balcells, D. Delourme, A. Ferrer, F. Karst, and A. Boronat. (1997). Cloning and characterization of the *Arabidopsis thaliana* SQS1 gene encoding squalene synthase — involvement of the C-terminal region of the enzyme in the channeling of squalene through the sterol pathway. *Eur J Biochem* 249: 61–69.
- Krinsky, S. and R. Wrubel. (1996). *Agricultural Biotechnology and the Environment. Science, Policy, and Social Issues*. University of Illinois Press, Urbana.

- Kushiro, T., M. Shibuya, and Y. Ebizuka. (1998). Beta-amyrin synthase — cloning of oxidosqualene cyclase that catalyzes the formation of the most popular triterpene among higher plants. *Eur J Biochem* 256: 238–244.
- Lange, B.M., M.R. Wildung, E.J. Stauber, C. Sanchez, D. Pouchnik, and R. Croteau. (2000). Probing essential oil biosynthesis and secretion by functional evaluation of expressed sequence tags from mint glandular trichomes. *Proc Natl Acad Sci USA* 97: 2934–2939.
- Larcher, W. (1995). Chemical interactions mediated by bioactive plant substances. In *Physiological Plant Ecology*, 3rd ed., Springer-Verlag, New York.
- Lee, J.H., Y.H. Yoon, H.Y. Kim, D.H. Shin, D.U. Kim, I.J. Lee, and K.U. Kim. (2002). Cloning and expression of squalene synthase cDNA from hot pepper (*Capsicum annuum* L.). *Mol Cells* 13: 436–443.
- Lee, M.H., J.H. Jeong, J.W. Seo, C.G. Shin, Y.S. Kim, J.G. In, D.C. Yang, J.S. Yi, and Y.E. Choi. (2004). Enhanced triterpene and phytosterol biosynthesis in *Panax ginseng* overexpressing squalene synthase gene. *Plant Cell Physiol* 45: 976–984.
- Li, C.P. and B.A. Larkins. (1996). Identification of a maize endosperm-specific cDNA encoding farnesyl pyrophosphate synthetase. *Gene* 171: 193–196.
- Li, Z.H., P.D. Matthews, B. Burr, and E.T. Wurtzel. (1996). Cloning and characterization of a maize cDNA encoding phytoene desaturase, an enzyme of the carotenoid biosynthetic pathway. *Plant Mol Biol* 30: 269–279.
- Liu, Z. and J. Adams. (1996). Camptothecin yield and distribution within *Camptotheca accuminata* trees cultivated in Louisiana. *Can J Bot* 74: 360–365.
- Liu, Z., S.B. Carpenter, and R.J. Constantin. (1997). Camptothecin production in *Camptotheca accuminata* seedlings in response to shading and flooding. *Can J Bot* 75: 368–373.
- Lluch, M.A., A. Masferrer, M. Arro, A. Boronat, and A. Ferrer. (2000). Molecular cloning and expression analysis of the mevalonate kinase gene from *Arabidopsis thaliana*. *Plant Mol Biol* 42: 365–376.
- Loh, J. and G. Stacey. (2003). Nodulation gene regulation in *Bradyrhizobium japonicum*: a unique integration of global regulatory circuits. *Appl and Environ Microbiol* 69: 10–17.
- Mandujano-Chavez, A., M.A. Schoenbeck, L.F. Ralston, E. Lozoya-Gloria, and J. Chappell. (2000). Differential induction of sesquiterpene metabolism in tobacco cell suspension cultures by methyl jasmonate and fungal elicitor *Arch Biochem Biophys* 381: 285–294.
- Margis-Pinheiro, M., X.R. Zhou, Q.H. Zhu, E.S. Dennis, and N.M. Upadhyaya. (2005). Isolation and characterization of a Ds-tagged rice (*Oryza sativa* L.) GA-responsive dwarf mutant defective in an early step of the gibberellin biosynthesis pathway. *Plant Cell Rep* 23: 819–833.
- Marin, E., L. Nussaume, A. Quesada, M. Gonneau, B. Sotta, P. Huguency, A. Frey, and A. Marion-Poll. (1996). Molecular identification of zeaxanthin epoxidase of *Nicotiana plumbaginifolia*, a gene involved in abscisic acid biosynthesis and corresponding to the ABA locus of *Arabidopsis thaliana*. *EMBO J* 15: 2331–2342.
- Martin, D.M., J. Faladt, and J. Bohlmann. (2004). Functional characterization of nine norway spruce TPS genes and evolution of gymnosperm terpene synthases of the TPS-d subfamily *Plant Physiol* 135: 1908–1927.
- McCarthy, S.S., M.C. Kobayashi, and K.K. Niyogi. (2004). White mutants of *Chlamydomonas reinhardtii* are defective in phytoene synthase. *Genetics* 168: 1249–1257.
- Meng, Y.L., J.W. Jia, C.J. Liu, W.Q. Liang, P. Heinstein, and X.Y. Chen. (1999). Coordinated accumulation of (+)-delta-cadinene synthase mRNAs and gossypol in developing seeds of *Gossypium hirsutum* and a new member of the cad1 family from *G. arborium*. *J Nat Prod* 62: 248–252.
- Michel, A., R.S. Arias, B.E. Scheffler, S.O. Duke, M. Netherland, and F.E. Dayan. (2004). Somatic mutation-mediated evolution of herbicide resistance in the nonindigenous invasive plant hydrilla (*Hydrilla verticillata*). *Mol Ecol* 13: 3229–3237.
- Mizukami, Y., M. Tudor, Y. Hu, and H. Ma. (1996). Functional domains of the floral regulator AGAMOUS: characterization of the DNA binding domain and analysis of dominant negative mutations. *Plant Cell* 8: 831–845.
- Moehs, C.P., L. Tian, K.W. Osteryoung, and D. Dellapenna. (2001). Analysis of carotenoid biosynthetic gene expression during marigold petal development. *Plant Mol Biol* 45: 281–293.
- Mohr, H. and P. Schopfer. (1995). Biosynthetic metabolism. In *Plant Physiology*, chap. 18. Springer-Verlag, New York.
- Moon, Y.H., H.G. Kang, J.Y., Jung, J.S. Jeon, S.K. Sung, and G. An. (1999). Determination of the motifs responsible for interaction between the rice APETALA/AGL9 family proteins using a yeast two-hybrid system. *Plant Physiol* 120: 1193–1203.

- Moore, R.C., S.R. Grant, and M.D. Purugganan. (2005). Molecular population genetics of redundant floral-regulatory genes in *Arabidopsis thaliana*. *Mol Biol Evol* 22: 91–103.
- Morita, M., M. Shibuya, M.S. Lee, U. Sankawa, and Y. Ebizuka. (1997). Molecular cloning of pea cDNA encoding cycloartenol synthase and its functional expression in yeast. *Biol Pharm Bull* 20: 770–775.
- Nakashima, T., T. Inoue, A. Oka, T. Nishino, T. Osumi, and S. Hata. (1995). Cloning, expression, and characterization of cDNAs encoding *Arabidopsis thaliana* squalene synthase. *Proc Natl Acad Sci USA* 92: 2328–2332.
- Nemhauser, J.L. and J. Chory. (2005). A new FronTIR in targeted protein degradation and plant development. *Cell* 121: 970–972.
- O'Brien, J. (1996). The tree of life. *Your Health* 6: 60–63.
- Pace, N.R. (1997). A molecular view of microbial diversity and the biosphere. *Science* 276: 734–740.
- Palaisa, K., M. Morgante, S. Tingey, and A. Rafalski. (2004). Long-range patterns of diversity and linkage disequilibrium surrounding the maize Y1 gene are indicative of an asymmetric selective sweep. *Proc Natl Acad Sci USA* 101: 9885–9890.
- Pan, Z., L. Herickhoff, and R.A. Backhaus. (1996). Cloning, characterization, and heterologous expression of cDNAs for farnesyl diphosphate synthase from the guayule rubber plant reveals that this prenyl-transferase occurs in rubber particles. *Arch Biochem Biophys* 332: 196–204.
- Parenicova, L., S. Folter, M. Kieffer, D.S. Horner, C. Favalli, J. Busscher, H.E. Cook, R.M. Ingram, M.M. Kater, B. Davies, G.C. Angenent, and L. Colombo. (2003). Molecular and phylogenetic analyses of the complete MADS-box transcription factor family in *Arabidopsis*: new openings to the MADS world. *Plant Cell* 15: 1538–1551.
- Pineiro, M. and G. Coupland. (1998). The control of flowering time and floral identity in *Arabidopsis*. *Plant Physiol* 117: 1–8.
- Potera, C. (1996). Genetic engineering improves natural rubber. *Genet Eng News* 16: 1.
- Pozo, M.J., L.C. Van Loon, and C.M.J. Pieterse. (2005). Jasmonates signals in plant microbe interactions. *J Plant Growth Regul* 23: 211–222.
- Prakash, A.P. and P.P. Kumar. (2002). *PkMADS1* is a novel MADS box gene regulating adventitious shoot induction and vegetative shoot development in *Paulownia kawakamii*. *Plant J* 29: 141–151.
- Redenbaugh, K., W. Hiatt, B. Martineau, M. Kramer, R. Sheehy, R. Sanders, C. Houck, and D. Emlay. (1992). *Safety Assessment of Genetically Engineered Fruits and Vegetables. A Case Study of the FLAVR SAVR™ Tomato*. CRC Press, Boca Raton, Florida.
- Riou, C., Y. Tourte, F. Lacroute, and F. Karst. (1994). Isolation and characterization of a cDNA encoding *Arabidopsis thaliana* mevalonate kinase by genetic complementation in yeast. *Gene* 148: 293–297.
- Rissler, J. and M. Mellon. (1996). *The Ecological Risks of Engineered Crops*. The Massachusetts Institute of Technology Press, Cambridge.
- Ronen, G., L. Carmel-Goren, D. Zamir, and J. Hirschberg. (2000). An alternative pathway to beta-carotene formation in plant chromoplasts discovered by map-based cloning of beta and old-gold color mutations in tomato. *Proc Natl Acad Sci USA* 97: 11102–11107.
- Rosin, F.M., J.K. Hart, H. Van Onckelen, and D.J. Hannapel. (2003). Suppression of a vegetative MADS-box gene of potato activates axillary meristem development. *Plant Physiol* 131: 1613–1622.
- Rounsley, S.D., G.S. Ditta, and M.F. Yanofsky. (1995). Diverse roles for MADS box genes in *Arabidopsis* development. *Plant Cell* 7: 1259–1269.
- Saupe, S.G. (2004). <http://www.employees.csbsju.edu/saupe/bid.327/Lecture/gibberellim.htm>.
- Schery, R.W. (1972). Latex products. In *Plants for Man*, 2nd ed., chap. 8. Prentice-Hall, Englewood Cliffs, New Jersey.
- Schwarz-Sommer, Z., P. Huijser, W. Nacken, H. Saedler, and H. Sommer. (1990). Genetic control of flower development: homeotic genes in *Antirrhinum majus*. *Science* 250: 931–936.
- Scolnik, P.A. and G.E. Bartley. (1993). Phytoene desaturase from *Arabidopsis*. *Plant Physiol* 103: 1475.
- Scolnik, P.A. and G.E. Bartley. (1994a). Nucleotide sequence of an *Arabidopsis* cDNA for phytoene synthase. *Plant Physiol* 104: 1471–1472.
- Scolnik, P.A. and G.E. Bartley. (1994b). Nucleotide sequence of an *Arabidopsis* cDNA for geranylgeranyl pyrophosphate synthase. *Plant Physiol* 104: 1469–1470.
- Scolnik, P.A. and G.E. Bartley. (1995). Nucleotide sequence of zeta-carotene desaturase (GenBank U38550) from *Arabidopsis* (PGR95-111). *Plant Physiol* 109: 1499.

- Scolnik, P.A. and G.E. Bartley. (1996a). Two more members of an *Arabidopsis* geranylgeranyl pyrophosphate synthase gene family (Accession Nos. U44876 and U44877). (PGR96-014). *Plant Physiol* 110: 1435.
- Scolnik, P.A. and G.E. Bartley. (1996b). A table of some cloned plant genes involved in isoprenoid biosynthesis. *Plant Mol Biol Rep* 14: 305–319.
- Sharkey, T.D., S. Yeh, A.E. Wiberley, T.G. Falbel, D. Gong, and D.E. Fernandez. (2005). Evolution of the isoprene biosynthetic pathway in kudzu. *Plant Physiol* 137: 700–712.
- Shelton, D.A., D.N. Leach, and R. Henry. (2004). Isopentenyl pyrophosphate isomerases from *Melaleuca alternifolia* (Cheel) and their role in isoprenoid biosynthesis. *J Hortic Sci Biotechnol* 79: 289–292.
- Shibuya, M., H. Zhang, A. Endo, K. Shishikura, T. Kushiro, and Y. Ebizuka. (1999). Two branches of the lupeol synthase gene in the molecular evolution of plant oxidosqualene cyclases. *Eur J Biochem* 266: 302–307.
- Singh, M., P.E. Lewis, K. Hardeman, L. Bai, J.K. Rose, M. Mazourek, P. Chomet, and T.P. Brutnell. (2003). Activator mutagenesis of the pink scutellum1/viviparous7 locus of maize. *Plant Cell* 15: 874–884.
- Soar, C.J., J. Speirs, S.M. Maffei, and B.R. Loveys. (2004). Gradients in stomatal conductance, xylem sap ABA and bulk leaf ABA along canes of *Vitis vinifera* cv Shiraz: biochemical and molecular biological evidence indicating their source. *Funct Plant Biol* 31: 659–669.
- Spielmeier, W., M. Ellis, M. Robertson, S. Ali, J.R. Lenton, and P.M. Chandler. (2004). Isolation of gibberellin metabolic pathway genes from barley and comparative mapping in barley, wheat and rice. *Theor Appl Genet* 109: 847–855.
- Sugimoto, M., Y. Yamaguchi, K. Nakamura, Y. Tatsumi, and H. Sano. (2004). A hypersensitive response-induced ATPase associated with various cellular activities (AAA) protein from tobacco plants *Plant Mol Biol* In press.
- Sun, Z., F.X. Cunningham, Jr., and E. Gantt. (1998). Differential expression of two isopentenyl pyrophosphate isomerases and enhanced carotenoid accumulation in a unicellular chlorophyte. *Proc Natl Acad Sci USA* 95: 11482–11488.
- Sun, Z., E. Gantt, and F.X. Cunningham, Jr. (1996). Cloning and functional analysis of the beta-carotene hydroxylase of *Arabidopsis thaliana*. *J Biol Chem* 271: 24349–24352.
- Tabata, M. and Y. Fujita. (1985). Production of shikonin by plant cell cultures. In *Biotechnology in Plant Science: Relevance to Agriculture in the Eighties*, M. Zaitlin, P. Day, and A. Hollaender (Eds.). Academic Press, New York, pp. 207–218.
- Tan, X.P., W.Q. Liang, C.J. Liu, P. Luo, P. Heinsteint, and X.Y. Chen. (2000). Expression pattern of (+)-delta-cadinene synthase genes and biosynthesis of sesquiterpene aldehydes in plants of *Gossypium arboreum* L. *Planta* 210: 644–651.
- Teeri, J.A. (1997). Personal communication.
- Townsend, B.J., A. Poole, C.J. Blake, and D.J. Llewellyn. (2005). Antisense suppression of a (+)-{delta}-cadinene synthase gene in cotton prevents the induction of this defense response gene during bacterial blight infection but not its constitutive expression. *Plant Physiol* 138: 516–528.
- Trapp, S.C. and R.B. Croteau. (2001). Genomic organization of plant terpene synthases and molecular evolutionary implications *Genetics* 158: 811–832.
- Vandenbussche, M., J. Zethof, E. Sourer, R. Koes, G.B. Tornielli, M. Pezzotti, S. Ferrario, G.C. Angenent, and T. Gerats. (2003). Toward the analysis of the *Petunia* MADS box gene family by reverse and forward transposon insertion mutagenesis approaches: B, C, and D floral organ identity functions required *SEPALLATA*-like MADS box genes in *Petunia*. *Plant Cell* 15: 2680–2693.
- Velikova, V., I. Yordanov, and E. Dreva. (2000). Oxidative stress and some antioxidant system in acid rain treated bean plants. *Plant Sci* 151: 15–66.
- Wang, W., Q. Shi, T. Ouyang, P. Zhu, and K. Cheng. (2002). Cloning, expression, and characterization of taxadiene synthase, a diterpene cyclase from *Taxus chinensis*. *Acta Bot Sin* 44: 181–187.
- Waterhouse, P.M., M.W. Graham, and M.-B. Wang. (1998). Virus resistance and gene silencing in plants can be induced by simultaneous expression of sense and antisense RNA. *Proc Natl Acad Sci USA* 95: 13959–13964.
- Waterhouse, P.M., M.B. Wang, and T. Lough. (2001). Gene silencing as an adaptive defence against viruses. *Nature* 411: 833–842.
- Weaver, R.J. (1972). Size control and related phenomena. In *Plant Growth Substances in Agriculture*, chap. 11. W.H. Freeman, San Francisco, California.
- Wu, W., M.J. Welsh, P.B. Kaufman, and H.H. Zhang. (2004). *Methods in Gene Biotechnology*, 2nd ed. CRC Press, Boca Raton, Florida.

- Yamaguchi, S., T. Saito, H. Abe, H. Yamane, N. Murofushi, and Y. Kamiya. (1996). Molecular cloning and characterization of a cDNA encoding the gibberellin biosynthetic enzyme ent-kaurene synthase B from pumpkin (*Cucurbita maxima* L.). *Plant J* 10: 203–213.
- Yamaguchi, S., T. Sun, H. Kawaide, and Y. Kamiya. (1998). The GA2 locus of *Arabidopsis thaliana* encodes ent-kaurene synthase of gibberellin biosynthesis. *Plant Physiol* 116: 1271–1278.
- Yoshioka, H., N. Yamada, and N. Doke. (1999). cDNA cloning of sesquiterpene cyclase and squalene synthase, and expression of the genes in potato tuber infected with *Phytophthora infestans*. *Plant Cell Physiol* 40: 993–998.
- You, S., N. Kawano, K. Ichinose, X. Yao, and Y. Ebizuka. (1999). Molecular cloning and sequencing of an *Allium macrostemon* cDNA probably encoding oxidosqualene cyclase. *Plant Biotechnol* 16: 311–314.
- Yuba, A., K. Yazaki, M. Tabata, G. Honda, and R. Croteau. (1996). cDNA cloning, characterization, and functional expression of 4S-(-)-limonene synthase from *Perilla frutescens*. *Arch Biochem Biophys* 332: 280–287.
- Zhang, H. and B.G. Forde. (1998). An *Arabidopsis* MADS box gene that controls nutrient-induced changes in root architecture. *Science* 279: 407–409.
- Zhao, J., L.C. Davis, and R. Verpoorte. (2005). Elicitor signal transduction leading to production of plant secondary metabolites. *Biotechnol Adv* 23: 283–333.
- Zik, M. and V.F. Irish. (2003). Global identification of target genes regulated by APETALA3 and PISTILLATA floral homeotic gene action. *Plant Cell* 15: 207–222.



# 4

---

## *Plant Natural Products in the Rhizosphere*

---

V.S. Bhinu, Kothandarman Narasimhan, and Sanjay Swarup

### CONTENTS

4.1	Introduction .....	143
4.2	Natural Products in the Rhizosphere .....	145
4.2.1	Collection and Processing of Plant Root Exudates.....	145
4.2.1.1	Collection Techniques.....	146
4.2.1.2	Processing of Root Exudates.....	147
4.2.2	Analytical Techniques to Study Natural Products in the Rhizosphere.....	148
4.2.3	<i>Arabidopsis</i> as a Model to Study Plant Root Exudates.....	149
4.2.4	Rhizosphere Metabolomics.....	150
4.3	Degradation of Plant Natural Products by Rhizosphere Microbes.....	150
4.3.1	Biosynthesis of Natural Products in Plants and Their Degradation by Microbes.....	151
4.3.2	Intracellular and Extracellular Degradation by Microbes.....	152
4.3.3	Microbes That Degrade Phytochemicals.....	152
4.3.4	Substrate Diversity and Specificity.....	154
4.3.5	Genetic Organization of Phenylpropanoid-Degrading Microbes.....	155
4.4	Transferring Genes from Plants to Rhizosphere Microbes and Vice Versa.....	156
4.4.1	Transfer of Degradative Pathways.....	156
4.4.2	Examples of Microbial Gene Transfer Associated with Degradative Pathways in Plants.....	156
4.5	Applications of Natural Products in Rhizoengineering.....	157
4.6	Rhizoremediation .....	158
4.7	Conclusions .....	159
	References.....	159

---

### 4.1 Introduction

Plants support various forms of life on earth. Their ability to adapt to various environments defines their survival, and in turn, has an impact on crop productivity. This adaptation is largely manifested by the three-way interactions between the roots as well as the biotic abiotic components of the soil. The interactions are governed typically by plant root secretions that can lead to symbiotic or defense outcomes for the plant. Studies on such interactions focus primarily on those occurring in the aerial parts of the plants or the **phyllosphere** (microenvironment region surrounding the leaves). Several of these processes involving root–soil interactions (via plant secretions) are confined to a narrow region surrounding the root tissue. This region is termed the **rhizosphere**. In this microenvironment, there is a constant exchange of energy, nutrients, and molecular signals between the plant roots and microbes that affect their mutual interactions (Mathesius et al., 2003; Walker et al., 2003a; Pinton, Varanini, and Nannipieri, 2001), rendering the rhizosphere a highly dynamic, yet less understood, soil environment due to its poor accessibility (Figure 4.1).



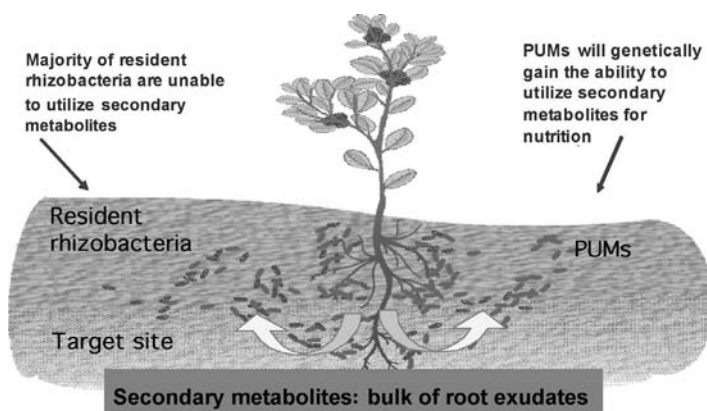

**FIGURE 4.1** (See color insert following page 256.) Effect of phytochemicals released by plant roots and some of the responses by soil organisms. Phenylpropanoid metabolite utilizing microbes (PUMs) have a selective advantage in colonizing plant roots because they can utilize the secondary metabolites released from the plant.

The dynamic and numerous interactions that occur in the soil environment inadvertently affect the biology of plants in diverse ways. Processes such as **allelopathy** and nutrient uptake determine plant or vegetation types, while **plant growth-promoting rhizobacteria (PGPR strains)** influence plant nutrition (availability), and ultimately, plant growth. The dynamics of the exudates composition is affected by the action of both plants and microbes. Contribution by plants to root exudates was estimated in some studies, and nearly 30 to 60% of photosynthetically fixed carbon is released into the rhizosphere (Lijeroth et al., 1994; Lynch and Whipps, 1990; Shepherd and Davies, 1994). Natural products found in the rhizosphere normally range from low-molecular-weight root exudates to high-molecular-weight humic substances. Among the multitude of organic compounds present in the rhizosphere, those released by plant roots are the most important from a qualitative and quantitative point of view, as they significantly impact the microenvironment.

In this chapter, we focus on some of the recent and interesting developments in collection, identification, and quantification procedures as well as the function of natural products in the rhizosphere. We also describe applications in this field; for instance, the ability to engineer rhizobacterial populations, an area termed **rhizoengineering**, has been really rewarding and holds good potential to improve interactions and outcomes within the soil environment. These applications were made possible due to the characterization of the biologically rich exudates, which, as mentioned earlier, was facilitated by the adoption of modern analytical methods. Technological advancements in the fields of chromatography, mass spectrometry, and magnetic resonance spectroscopy were applied to characterize unknown compounds, leading to the elucidation of a plethora of exuded molecules (refer to Chapter 9 for details). As many of the biological molecules are maintained in a balance in nature, huge amounts of exudates are channeled through various life forms. While some organisms are associated with the biosynthesis of molecules, other life forms degrade the same molecules. Hence, as expected, there are several beneficial microorganisms known to cause breakdown of natural products or even degradation of simple sugars that are recycled for other anabolic reactions. Many of these plant products are terminal metabolites of biosynthetic events in plants, and it is common to have bacteria that start utilizing these end-products for energy generation. For example, **phenylpropanoid** compounds such as flavonoids are exuded in the rhizosphere, and there are microbes that degrade these compounds. Their metabolic pathways are described in detail in Section 4.3.

An enormous amount of information is available due to advancements in analytical techniques, biochemistry of enzymes, genetic engineering, and biotechnological approaches. This wealth of knowledge has generated interest in finding applications, such as transferring traits across species or larger domains. Transferring genes from plants to microbes and vice versa is not a recent technology. A **heterologous transfer of genes** provides avenues for manipulating metabolic events. Although this is beneficial, there are some growing concerns on transfer issues, such as horizontal gene transfer, gene

flow across genera, and more. Amid these concerns, enormous applications were reported that include the directed use of phytochemicals in the rhizosphere to create a biased rhizosphere, applications in **phytoremediation**, bioaugmentation or repression of antagonist microbes through root exudates. Creation of a **biased rhizosphere** enables partitioning the rhizosphere by selectively nurturing preferred microbes. Phytoremediation helps in the removal of specific contaminants using plant varieties known to absorb these contaminants and, thereby, clean them up. **Bioaugmentation** refers to enhanced availability of a substrate using specific microbes. Some other applications include cleanup strategies such as **rhizoremediation** that are discussed in later sections.

---

## 4.2 Natural Products in the Rhizosphere

Natural products are exuded from plant roots through **rhizodeposition** and **rhizosecretion**. Root exudates are rich in metabolites and other organic compounds, such as amino acids and proteins, osmolites, phenolics, phytohormones and bioregulators, sugars and organic acids, vitamins, **volatile organic carbons (VOCs)**, leaf pigments, and nucleic acids and derivatives (see Walker et al., 2003a, 2003b, and references cited therein). The process of root exudation ensures the survival of endemic as well as introduced microorganisms of interest in the soil environment. These exuded compounds play a major role in plant–plant, plant–insect, plant–microbe, and plant–nematode communications, some of which are beneficial, while others can lead to detrimental effects on the plants. Genetics together with gene manipulation techniques can be used to regulate and modify the quantity, the quality, and the type of products released into the rhizosphere. Root exudates, therefore, may represent enriched sources of natural products (Rao, 1990). As root exudates are less investigated compared with metabolites within the plant tissues, and as they represent a sizable proportion of the fixed carbon, a deeper understanding of the rhizosphere chemical composition and its effects will be beneficial for many areas. One such area is in the creation of a biased rhizosphere. A better understanding of secondary metabolism is required to create a biased rhizosphere. This can be achieved using genetic as well as transgenic technologies to overproduce specific types of metabolites that affect rhizosphere biotic populations. Studies on phytochemicals exuded by plant roots focus on metabolites involved in plant–microbe interactions, such as **isoflavone** compounds (Paiva, 2000), **allelopathic** compounds (Park et al., 2001), and those with **nematicidal activity** (Akhtar and Mahmood, 1994). Those phytochemicals that adversely impact other competing plants are known as **allelopathic chemicals** (Bais et al., 2004) and **phytoanticipin–antimicrobial** compounds (Singer et al., 2004; Wittstock and Gerschenon, 2002).

The major class of exuded phytochemical compounds in root exudates belongs to secondary metabolites. Based on our studies, as well as those of other research groups, exudates were shown to be rich in secondary metabolites (Narasimhan et al., 2003; Singer et al., 2004). These compounds in the rhizosphere were implicated in a variety of functions associated with competition for plants of the same species as well as resistance against pathogenic microbes. Compounds such as **opines** were engineered for attracting specific types of microbes. The above compounds are potential compounds that could also be used to create a biased rhizosphere. They could also be used for biocontrol purposes (Oger et al., 1997; Savka and Farrand, 1997).

### 4.2.1 Collection and Processing of Plant Root Exudates

Plant root exudates are less investigated as compared with metabolites within the plant tissues. Previous studies show an abundance of secondary metabolites in shoots and floral organs. However, there has not yet been a comprehensive, systematic analysis of the composition of root exudates. Root exudates are complex in nature and not easy to obtain in large quantities. However, numerous methods are now in practice for collecting and processing the exudates. Biochemical analysis methods were developed based on liquid chromatography techniques, such as **reverse-phase high-performance liquid chromatography (RP-HPLC)**, and mass spectrometry approaches, such as **electrospray ionization mass spectrometry (ESI-MS)** (see Chapter 9). Recently, **nuclear magnetic resonance** spectroscopy (NMR)

(see Chapter 9) was also applied in the study of root exudates. These techniques are especially used to examine the changes in the phenolic composition in root exudates. Study of phenolic compounds in the exudates of several plants, including both monocot and dicot plants, was performed by various research groups. This led to a renewal in an area now known as **metabolic profiling**. Metabolic profiling of various phenylpropanoid pathway intermediates led to the development of methods to further manipulate these compounds in root exudates (Narasimhan et al., 2003). We describe here some of the major recent developments in techniques used to collect, process, and analyze root exudates. In order to analyze the exudates both quantitatively and qualitatively, samples must be obtained in pure forms and in large quantities. Due to the complex nature and chemistry of plant exudates, it becomes necessary to isolate, purify, and process them before further studies can be performed. We also describe the composition of root exudates and the factors affecting them. Last, we describe the emerging field of **rhizosphere metabolomics**.

#### 4.2.1.1 Collection Techniques

Many methods to collect root exudates were developed to suit various purposes and scale of collection. Simple methods using filter papers can be used to collect exudates from specific areas of the roots. For localized exudate sampling using the filter paper method, the root systems are spread on the surface of a moist fleece covered with a layer of moist filter paper. The advantage using this method is that the exudates can be collected from a chosen area of the roots, such as the root tip, or from an actively growing area of the root (Neumann and Römheld, 1999). More sophisticated systems, such as the **two-compartment system**, are used to simultaneously study exudates and gases from roots (Hodge et al., 1996; Kuzyakov and Siniakina, 2001). The innovation of this method lies in the use of a membrane pump to drive the movement of air, and simultaneously, the circulation of water according to the siphon principle. In another development, pulse labeling through  $^{14}\text{C}$  isotope dilution was used to study rhizodeposition using the two-compartment system. Another study used steady-state  $^{13}\text{C}$  labeling to investigate carbon assimilation in root exudates of perennial rye (*Lolium perenne*) (Thornton et al., 2004). In this study, roots were bathed in a nutrient solution exposed to a continuous flow of  $^{13}\text{C}$  labeled  $\text{CO}_2$ . Such studies are helpful in monitoring the assimilation and exudation of carbon. In yet another variation of the experimental setup, elicitors were applied followed by collection of root exudates of lupine (*Lupinus luteus*) plants that showed an increase in the levels of **genistein**, an isoflavone (Kneer et al., 1999). In this case, a hydroponic model was employed to test this system, and samples thus collected in the liquid medium were directly used for liquid separation analysis.

The above methods are mainly geared toward collecting small amounts of exudates. In comparison, **mini-rhizotrons** can be used in the collection of a large amount of root exudates. In mini-rhizotrons, sterile root exudates are collected from hydroponically grown plants. One common method for root exudates collection is the hydroponic method described earlier. This is widely used in many types of elicitor studies. This setup allows the exudates to be filter sterilized. Samples collected in the liquid medium are directly used for liquid separation analysis or other downstream studies.

Another technique, based on the **aeroponic method** used for collection of root exudates, is also practiced. This is a preferred method in cases where least disruption of the roots is of primary concern. Here, plants are grown by delivering a nutrient mist to the roots. By doing so, one of the biggest advantages is that roots contain large amounts of well-developed root hairs that are well oxygenated and are subjected to a uniform and microbe-free environment. Such an environment or a clean background is required in order to analyze the exudates thoroughly, thus minimizing the influence of biotic and abiotic variables. Additionally, effects of starvation for a particular nutrient, non-interference of changes in the concentrations of other nutrients, temperature, and pH can be studied. The collection of root exudates in the latter case is done by dipping the sufficiently grown root mass in water. An autoclavable, all-glass system for studying microbial dynamics at permeable surfaces was developed using similar ideas (Odham et al., 1986).

We outline here the minimum requirements for studying the exudation process and exudates, which researchers can consider while adopting or evaluating a particular collection method. These requirements include the following:

1. The exuding surface should be permeable to relevant molecules and exhibit a well-defined pore size. It should produce uniform and reproducible flows and exudation characteristics, and it must prevent microorganisms from entering the exudate reservoir.
2. The surface should be inert toward living organisms.
3. The area of the exuding surface and the total volume of the system should allow for studies of initial attachment processes at natural substrate concentration and flows.
4. The chemical signatures for microbial biomass and community structure should be easily extractable from the various system environments with aqueous or organic solvents.
5. The system should permit increased levels of complexity in both biological and physical parameters, such as the use of soil instead of a liquid surrounding the medium.
6. The delivery system should allow for controlled variations in the levels of exudate flow through the semipermeable surface.
7. The system should be easily autoclavable.

As seen from the methods that are currently available, users have many choices, and the above criteria can be considered to suit the objectives of their work and the resources available. It is important to remember that root exudates are normally present in a soluble or particulate form after the collection stage. It is, therefore, common to remove particulate impurities from the collected exudates and concentrate the exudates by vacuum-drying or freeze-drying (**lyophilization**) before processing them for determination of total organic carbon, as well as other extraction procedures, in order to extract specific compounds of interest. Purified root exudates may also be stored at  $-80^{\circ}\text{C}$  for a period of 6 months to 1 year. Repeated thawing, however, deteriorates the quality of the exudates and should be avoided.

---

### Essay on Root Exudate Collection from *Arabidopsis* Plants

The weed-like plant, *Arabidopsis*, is a widely used model for research. Hence, we present a brief description of its root exudate collection, using simple methods that were used successfully in our laboratory (Narasimhan et al., 2003). In one such method, *Arabidopsis* seeds can be used to collect exudates by growing them on 0.8% water agar poured in petri plates that are placed vertically to avoid the penetration of roots into the agar (Figure 4.2A). In our system, root exudates are harvested after 20 d by gently flooding the roots with 2 ml sterile water. In another method, also practiced in our laboratory, petri plates are kept in an inverted position once the seeds have germinated. This method facilitates the growth of roots in an aeroponic-like fashion (Figure 4.2B). The emerging roots are kept submerged for nearly 1 h in 2 ml of water for collection of root exudates. During root exudate collection, care is taken to avoid injuring the roots, as this would cause non-specific leakage of metabolites. Once these root exudates are carefully collected, they are usually processed using one of the methods described below.

---

#### 4.2.1.2 Processing of Root Exudates

Root exudate impurities can include particulate matter and solid particles. Harvested root exudates are centrifuged at 8000-g for 15 min to remove any particulate impurities. Solid-phase extraction can be used to extract phenolic compounds from root exudates. Once the impurities are removed, the root exudates are again concentrated. This can be achieved by using one of the commercially available columns, for example, Supelco™ LC-18 SPE tubes for **solid-phase extraction** or by **liquid-phase extraction**. Samples concentrated through one of these methods can be directly loaded onto a HPLC column for separation, as used for acid-hydrolysis experiments, LC-MS, or NMR studies (more details on NMR are discussed in Chapter 9). There are a few other possible techniques used, but these are based on liquid-phase extraction. Choice of solid-phase extraction columns, as well as the solvents to elute

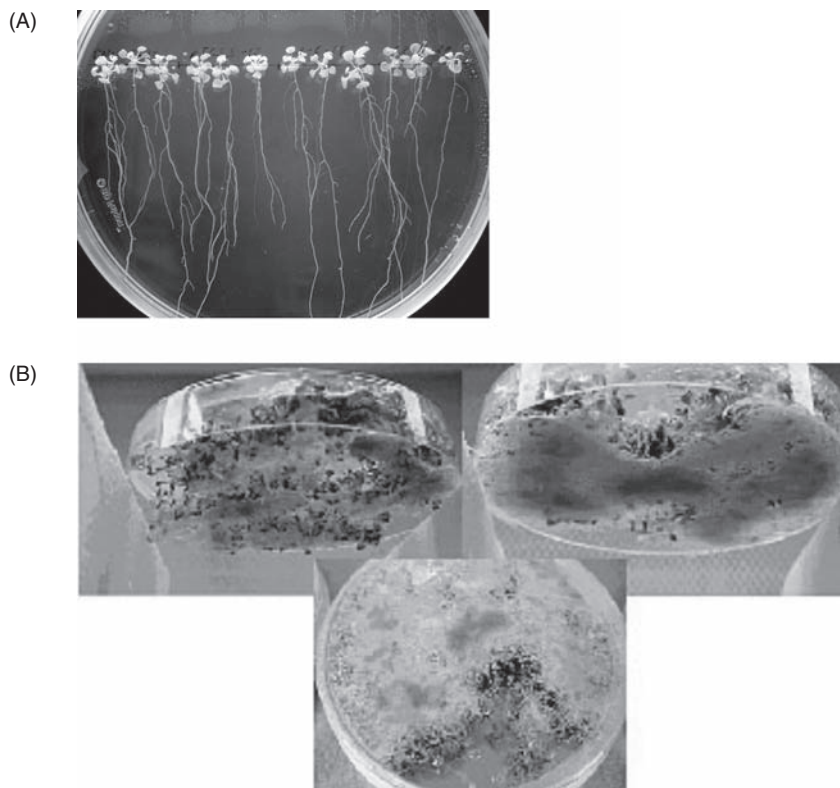

**FIGURE 4.2** (See color insert.) Root exudate collection techniques. (A) *Arabidopsis* plants germinated on 0.8% water agar and kept in a vertical position to prevent penetration of roots into the agar. Roots exudates are collected by washing the roots with water (supplied by Dr. Leland Cseke). (B) *Arabidopsis* plants grown in petri plates kept in an inverted position (aerobic type). Using these techniques, approximately  $59 \pm 1.47$  mg roots were harvested per plant. (From the American Society of Plant Biologists, Rockville, Maryland, 2003. With permission.)

bound compounds, or use of liquid-phase extractions usually depends on the types of compounds of interest. (Refer to Chapter 8 for additional information on extraction procedures.)

#### 4.2.2 Analytical Techniques to Study Natural Products in the Rhizosphere

The concentrated and processed root exudates (for example, hydrolyzed, purified, HPLC-resolved fractions) can be analyzed using several currently available and sensitive techniques. The first step usually involves determining the **total organic carbon (TOC) content**. Most methods used for TOC analysis are independent of the type of molecule/composition of root exudates, and therefore, provide an excellent basis on which to quantify the amount of exudation. To determine TOC, root exudate samples are concentrated using a rotary evaporator. This is helpful if the TOC in the sample is very low, such as in the case of *Arabidopsis* plants. One could use a standard TOC analyzer. We routinely use a **combustion-TOC analyzer** (Analytical Model 1020A, Shimadzu, Japan) for determining TOC values. Carbon content in root exudates is typically determined in nanogram levels per 100  $\mu\text{l}$  of root exudates injected. From here, one can proceed to determine the major classes of exudates using specific tests. Plant phenolics, *per se*, constitute a major component in most of the plant root exudates, and it is therefore useful to quantitate the phenolic compounds as well. Total phenolic content in the root exudates can be determined using standard methods such as the **Folin-phenol method**, with **rutin** or other phenolics as standards (van Sumere, 1989). From our studies on *Arabidopsis* root exudates, we observed that total phenolics accounted for about  $7 \text{ ng}\cdot\text{mg}^{-1}$  wet weight (50% of TOC) of *Arabidopsis* roots.

With data from TOC analysis and phenolic composition, it is possible to decide how to proceed with other techniques (e.g., the use of **thin-layer chromatography [TLC]**) for lipids, amino acids, carbohydrates, natural pigments, phenolics, vitamins, nucleic acid derivatives, steroids and terpenoids, and pharmaceuticals (Pothier, 1996). It may be interesting to note that some studies using TLC and HPLC on root exudates reported the identification of phytotoxic compounds that act as **photosystem II (PSII)** inhibitors in sorghum (*Sorghum* spp.) (Kagan, Rimando, and Dayan, 2003) and inhibitory **hydroquinones** in *Striga asiatica* (Erickson et al., 2001). Additional profiling of the exudate compounds is possible by using **nuclear magnetic resonance (NMR) spectroscopy** and **mass spectrometry (MS)**. (Refer to Chapter 9 for more details.) The use of such techniques has been invaluable. For example, such studies demonstrated the role of wheat (*Triticum* spp.) and barley (*Hordeum vulgare*) exudate **metal ion ligands (MIL)** in the acquisition of cadmium (Fan et al., 2001). Use of such techniques is advantageous considering the small amounts of processed exudates available for analysis. NMR-based analyses require minimal sample preparation, with no loss of unknown compounds and reduced net analysis time. NMR also helps in structure-based analysis for universal detection and identification. Furthermore, it aids in simultaneous analysis of a large number of constituents in a complex mixture. As expected, considering the advantages offered by the use of NMR technology, many studies using NMR were reported, especially for the analysis of **allelochemicals** (Dayan et al., 2003) (see also Chapter 9, Section 9.2). These studies provide valuable insights into the complexities of exudates.

A more recent addition to ultrasensitive analytical technologies is **Fourier-transform Raman spectroscopy (FTRS)**. The coupling of FT Raman and FT infrared (FTIR) and <sup>1</sup>H-NMR spectroscopy with **differential scanning calorimetry (DSC)** was successfully applied to the characterization of root exudates from two cultivars of gladiolus ('Spic Spa' and 'White Prosperity', probable hybrids of *Gladiolus* spp.) that have different degrees of resistance and susceptibility to the fungal pathogen *Fusarium oxysporum gladioli* (Taddei et al., 2002). The point to note is that two closely related ornamental cultivars with varying susceptibility to pathogens are expected to have minute changes that are easily captured by these techniques. Another very powerful analytical technique recently being used for root exudates analysis is **mid-infrared synchrotron radiation**. Although this technique was used to visualize rhizosphere chemistry of legumes (Raab and Martin, 2001), it is now also being used for root exudate analysis with other plants. Other notable advancements in synchrotron IR spectromicroscopy, therefore, perfectly complement existing root imaging techniques. To date, mid-IR synchrotron radiation is one of the most powerful visualization techniques used to analyze the rhizosphere and associated environments.

### 4.2.3 *Arabidopsis* as a Model to Study Plant Root Exudates

The model plant *Arabidopsis* belongs to the crucifer family (Brassicaceae), and it is rich in various types of secondary metabolites. A short life span, the ease of growing it in petri dishes under **axenic** (sterile) conditions, as well as the convenience of manipulating both biotic as well as abiotic factors makes it an ideal model plant for studying root exudates. *Arabidopsis* has a genome comprising 125 million nucleotide bases and comprises more than 26,000 genes. Prior to the *Arabidopsis* genome sequencing, it was thought that this plant species could serve as a model only for as few as 36 secondary metabolites that were thought to be secreted by this weed plant (Chapple et al., 1994). However, a much more comprehensive picture emerged from the completion of the *Arabidopsis* genome, as described in the next section. From the genomic studies, as well as the AraCyc project (described in Chapter 5), about 221 pathways are currently described in *Arabidopsis*. These include information on compounds, intermediates, cofactors, reactions, genes, proteins, and protein subcellular locations (Mueller et al., 2003). The availability of biosynthetic mutants affected in various steps of the biosynthetic pathways, such as the phenylpropanoid pathway, makes it an ideal model for investigating the effect of mutations on the quantitative and qualitative expression of different types of metabolites in root exudates. Broadly speaking, they are useful in studying metabolic pathways by perturbing them and monitoring the associated changes. Because this plant is genetically well characterized, it makes a good model with which to study the effect of genes on the exudation process. The gene products affected could sometimes play a direct role,

as in the case of the exudation pump for **indole-3-acetic acid (IAA)** in *tt4* mutant plants (Brown et al., 2001; Murphy et al., 2000). Similar studies with the model *Arabidopsis* plants can therefore help to explain the functions as well as the genetic basis for exudate composition. A list of Web-based utilities including *Arabidopsis* links is included in the Appendix of this book.

#### 4.2.4 Rhizosphere Metabolomics

The primary aim of “omics” technologies was the non-targeted identification of all gene products (including transcripts, proteins, and metabolites) present in a specific biological sample (Weckwerth, 2003) (also refer to Chapter 6). Profiling coupled with the identification of metabolites released into the rhizosphere through plant roots constitutes **rhizosphere metabolomics** (Narasimhan et al., 2003). Studies on rhizosphere metabolites (Walker et al., 2003b), especially in *Arabidopsis*, led to the identification of a wide array of **phenylpropanoids**, mainly flavonols and monomers of the **lignin biosynthetic pathway**, and **indole compounds** in the root exudates of *Arabidopsis* (Narasimhan et al., 2003). Here, we briefly discuss rhizosphere metabolomics of *tt* (transparent testa) mutants of *Arabidopsis*. More specifically, the wild-type (*Landsberg erecta*) and mutant profiles based on **RP-HPLC** and **electrospray ionization mass spectrometry (ESI-MS)** are discussed.

A careful examination of the profiles showed the presence of a distinctive biochemical fingerprint characteristic of wild-type plant and mutants (these mutants are specifically blocked at different steps in the phenylpropanoid biosynthetic pathway) (Narasimhan et al., 2003). Mutations in structural and regulatory loci affected the biochemical profiles, especially in the number of HPLC peaks representative of different types of major phenylpropanoid compounds (flavones). Studies on root exudates conducted mostly in our laboratory revealed that the profiles of root exudates changed according to the gene modifications, as expected and observed previously in the leaf and root profiles of *Arabidopsis* (Pelletier et al., 1999). For example, the *tt4* mutant defective in the **CHS gene (chalcone synthase)**, due to a single base-pair mutation, resulted in the shutdown of flavone biosynthesis. However, the exudates from *tt4* roots had an abundance of several other phenylpropanoid compounds. The *ttg* mutant accumulates both flavones and their conjugates in higher amounts in the roots. The mutant *tt8* mutant (Nesi et al., 2000) largely accumulates aglycones of flavones (Pelletier et al., 1999). HPLC profiles of root exudates from the *tt8* mutant were distinct from the wild type by virtue of the absence of any conjugation. However, in another mutant, *ttg*, root exudates, in addition to glucoside and rhamnoside conjugation, showed an abundance of conversion of glucopyranoside conjugates to the respective aglycones, **quercetin** and **naringenin**. Metabolites, when not being processed or blocked due to gene mutation or impairment, are diverted to other pathways or channels to maintain a physiological balance (**homeostasis**). Identification of such alternate channels and diversions are interesting. These brief results discussed here indicate the utility of a metabolomics approach for the study of gene regulation using a suite of analytical techniques.

---

### 4.3 Degradation of Plant Natural Products by Rhizosphere Microbes

Many plant metabolites are terminal products of metabolic events. These products are, therefore, channeled to other life forms via nutrient uptake or other means. Hence, it is not surprising to find microorganisms that are capable of uptake of these end-products and use for energy-building processes. As such, microorganisms can evolve altered genes more rapidly than higher organisms due to their rapid growth rates. They can, therefore, produce novel enzymes for degrading compounds of natural and anthropogenic origin (See Figure 4.3 for an overview of some phenylpropanoid types of natural compounds from plants). The evolution of newer genes in existing microorganisms capable of degrading molecules intractable to breakdown makes the degradation process a continuous one. Now, with the aid of genetic manipulation, it is possible to accelerate the process of natural evolution in a more directed manner. However, before the principles of gene manipulation can be successfully used, it is essential that we understand the aspects involved in the biosynthesis of plant metabolites and their consequent

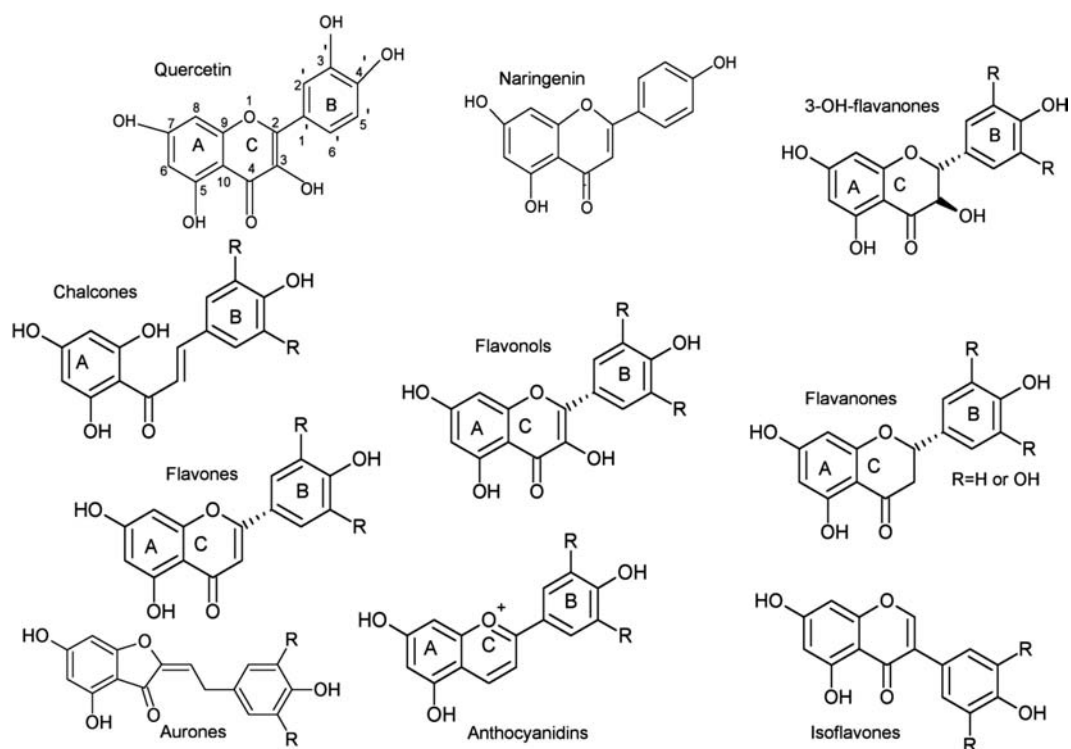

**FIGURE 4.3** An overview of some phenylpropanoid types of natural compounds from plants. Note that these compounds are usually multiringed (commonly three rings) and rich in carbon content. This abundance of carbon could also be a driving force for microbes to evolve ways to tap them as energy resources.

degradation by microbial enzymes; otherwise, it will be difficult to direct these efforts successfully. In order to understand some of the biochemistry involved in the enzyme-driven catabolism and anabolism reactions mentioned above, it is essential to discuss the substrate specificity and diversity of these enzymes. A brief note on their genetics is also provided.

### 4.3.1 Biosynthesis of Natural Products in Plants and Their Degradation by Microbes

Natural products in the rhizosphere originate because of their high relative rates of biosynthesis in plants. An abundance of biosynthetic pathways in plants and microbes has evolved over time, resulting in the formation of diverse metabolites from plants and an equally interesting population of enzymes involved in their breakdown. A balanced relationship between biosynthetic and degradation pathways seems vital to maintain the carbon and energy flow in the rhizosphere. Biosynthesis of diverse plant metabolites belonging to major groups, such as **terpenoids**, **alkaloids**, and **phenylpropanoids**, involves a limited number of building blocks to form a basic carbon skeleton, and when a few modifications to this template occur, this diversity results. It is known, for example, that the complete diversity of terpenoids is based on the same five-carbon precursor, **isopentenyl pyrophosphate**, while most alkaloids are derived from **ornithine** and **lysine**. All phenylpropanoids are derived from the aromatic amino acids **phenylalanine** and **tyrosine** (and in some cases, the **acetate pathway** as well). Thus, starting with some of the main building blocks, carbon and nitrogen are added selectively via a number of typical building blocks: for example, C1 units are added via *S*-adenosylmethionine; C2 units are added via acetyl-CoA or malonyl-CoA; C3 and C4 units are added via simple sugars; C5 units are added via isopentenyl pyrophosphate; C6C3 units from phenylalanine or tyrosine (after deamination via side-chain degradation) yield C6C2 and C6C1 units; C6-C-2N units come from decarboxylated phenylalanine, or tyrosine indole units from tryptophan; C4-N units are derived from ornithine; and C5-N units come from lysine (Nesi et al., 2000).



In general, there appears to be a reversal of trends in the biosynthesis (in plants) and degradation (in microbes) of at least some of the plant natural products. Phenylpropanoid biosynthesis begins in plants with the conversion of **phenylalanine** to **cinnamate** and **coumarate** by **cinnamate 4-hydroxylase** and to **naringenin chalcone** mediated by **chalcone synthase**. The addition of a hydroxyl group to this chalcone molecule by **chalcone isomerase** forms **naringenin**, a **flavone**. Further hydroxylation mediated by **flavanone 3-hydroxylase** and **flavonoid 3-hydroxylase** results in formation of **dihydrokaempferol** and **dihydroquercetin** compounds that are further channeled to form **anthocyanins**. In comparison, the microbial degradation pathway involves an initial step of conversion of quercetin back to naringenin, which is then finally broken down into small forms for funneling into the Krebs cycle for energy production (Pillai and Swarup, 2002). Likewise, transgenic plants that express the bacterial *nahG* gene (the structural gene for **salicylate hydroxylase**) were shown to accumulate very little **salicylic acid** and to be defective in their ability to induce **systemic acquired resistance (SAR)** (Friedrich et al., 1995). Some of these topics are expanded upon further in later sections.

### 4.3.2 Intracellular and Extracellular Degradation by Microbes

Plant root exudates are cycled through microbial biomass by assimilation into their metabolism and are released as metabolic products. Rhizosphere compounds are acted upon by two types of microbial enzymes — the extracellular or intracellular types. **Intracellular enzymes** operate only within the confines of the cell membrane, and these proteins remain attached in some way to the cell membrane. An **extracellular enzyme** is excreted (secreted) outside the cell into the medium in which that cell is living in order to perform its activity. Extracellular enzymes usually convert large substrate molecules (i.e., food for the cell or organism) into smaller molecules that can then be more easily transported into the cell.

It is common to classify a membrane-localized enzyme as intracellular or extracellular depending on which side of the membrane the active site is located. While intracellular enzymes tend to be less stable when exposed to extremes of temperature, salt concentrations, or pH, and possess an open, flexible shape for optimum activity, the extracellular enzymes tend to have a more compact, stable shape because they are designed to work in a less controlled environment. Each type carries signal sequences, usually on the **N-terminal** end of the protein, that direct them to their correct destination inside or outside the cell. In higher organisms, extracellular enzymes are mostly **glycosylated**; that is, they have simple sugars or oligosaccharides attached. An example of extracellular enzymes secreted in the culture media containing **polyhydroxyalkanoates (PHA)** is that of *Pseudomonas picketti*, which possesses **polyhydroxyalkanoates depolymerases** (Yamada et al., 1993) and the soluble **quinoprotein ethanol dehydrogenase (QEDH)** (Görisch, 2003). Enzymes from metabolic pathways are mostly intracellular. A few examples include the **mono-** and **dioxygenase** types of microbial enzymes that degrade diverse complex compounds (Martin and Mohn, 1999; O’Keefe et al., 1991; Trower et al., 1992). A soil-inhabiting *Pseudomonas* capable of **quercetin** degradation showed that quercetin was transformed to **naringenin**, **3,4-dihydroxy cinnamic acid**, **protocatechuate**, and **phloroglucinol** (see Figure 4.4 and Pillai and Swarup, 2002). Protocatechuate, a central metabolite in many pathways, is subsequently channeled into the TCA cycle for energy metabolism.

Enzymes involved in degradation, therefore, consist of extra- or intracellular types. Due to the diversity of microbes and plant natural products, such as those that occur in root exudates, it is no wonder that various kinds of enzymes are involved in these pathways. We discuss related aspects in the sections that follow.

### 4.3.3 Microbes That Degrade Phytochemicals

Microbial enzymes with wide substrate specificity are certain to provide survival benefits to those microbes harboring the enzymes than those that do not. As a rule of nature, the more competent, capable, and fit survive. The same applies to microbes. Therefore, we can hypothesize that efficient utilization of plant metabolites by microbes can lead to a positive selection of the utilizers. It is, therefore, plausible that several phytochemical degraders have been reported (Pillai and Swarup, 2002). Many microbes are known to participate in the breakdown of phytochemicals that are aromatic and complex in nature. These were reported from two ecological niches — soil and intestines. Those from the soil, represented by

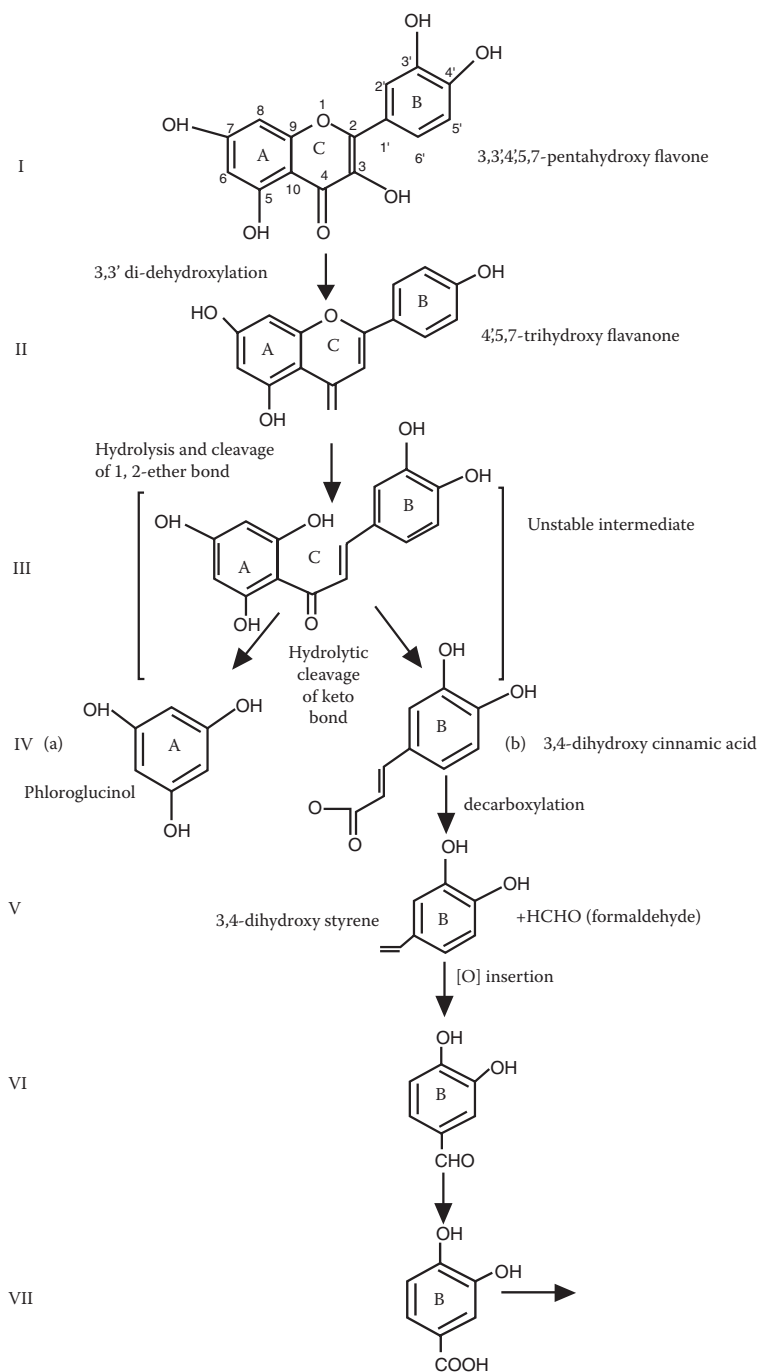

**FIGURE 4.4** Quercetin degradation pathway in *Pseudomonas putida* strain PML2. (I) Quercetin (3,3,4,5,7-pentahydroxy flavone); (II) naringenin (4,5,7-trihydroxy flavanone); (III) unstable intermediate-transient product, detected by mass spectrometry; (IVa) phloroglucinol; (IVb) 3,4-dihydroxy cinnamic acid; (V) 3,4-dihydroxy styrene; (VI) protocatechuic aldehyde; and (VII) protocatechuic acid. The identity of all compounds, except compounds III, V, and VI, was confirmed by nuclear magnetic resonance spectroscopy. All compounds were detected in the wild-type strain PML2 but not in mutant strains and are stably formed except for compound III. Hydrolysis and cleavage of ether and keto bonds and the presence of an unstable intermediate (compounds III) were inferred based on the structures of compounds II and IV. (From the American Society for Microbiology, Washington, D.C., 2002. With permission.)

*Rhizobia* and *Agrobacterium*, are capable of degrading **nod gene-inducing flavonoids** (Rao and Cooper, 1994); a plant growth-promoting rhizobacterial, soil-inhabiting bacterium, *Pseudomonas putida*, is capable of **quercetin** and **naringenin** degradation (Pillai and Swarup, 2002); a thermophilic *Bacillus* sp. is capable of oxidation of **aromatic acids** (Buswell and Clark, 1976); soil pseudomonads are capable, not only of **styrene** degradation (Baggi et al., 1983), but also of hydroxylation of the A-ring of **taxifolin** (Jeffrey et al., 1972) and oxidative fission of the A-ring of **dihydrogossypetin** (Jeffrey et al., 1972); and, a *Rhodococcus rhodochrous* strain was described as being capable of styrene degradation (Warhurst et al., 1994). Some commonly reported fungal strains in these two niches include *Aspergillus niger* (Sakai, 1977), which can degrade phenylpropanoids, and *Phanerochaete chrysosporium*, which can degrade lignin by non-specific enzymes (Ulmer et al., 1983). Others from the anoxic environment of the intestine include *Clostridium* strains (Schoefer et al., 2003; Winter et al., 1991), *Eubacterium* species (Krumholz et al., 1987), and a *Butyrivibrio* species (Krishnamurthy et al., 1970). These latter examples indicate that plant metabolites forming part of dietary components influence **intestinal microbiota**.

From the wide spectra of microbes that were identified in these two niches alone, it is convincing that certain microbes possess enzymes (acting either on specific or diverse substrates) that can degrade phytochemicals. These microbes not only degrade natural products, but also seem to transform these compounds into metabolites that have survival benefits. This leads to additional questions, such as, do the microbes have specific genes that direct them to recognize and degrade compounds that are difficult to break down? The answer may be affirmative.

#### 4.3.4 Substrate Diversity and Specificity

As discussed in Section 4.2, the rhizosphere is an extremely dynamic environment in the sense that the enormity of diverse metabolite types led to formation of an equally diverse range of microbial enzymes that act on these compounds. For instance, the breakdown of predominant sugars (6C) feeds into the **Embden–Meyerhof pathway (EMP)** or the **glycolysis pathway** for oxidation of glucose, leading to the formation of pyruvate. Alternatives to the EMP pathways include the **pentose phosphate pathway (hexose monophosphate shunt; phosphogluconate pathway)** that is used to metabolize 5C sugars and to generate reducing power in the form of **NADPH**. These alternative pathways operate simultaneously with glycolysis in some bacteria, such as *Bacillus subtilis*, *Escherichia coli*, *Enterococcus faecalis*, and *Leuconostoc mesenteroides*. Additionally, the **Entner–Doudoroff (ED)** pathway operates in other Gram-negative bacteria, such as *Pseudomonas*, *Rhizobium*, and *Agrobacterium* spp. Likewise, amino acids, before they can be catabolized, are converted via **transamination, decarboxylation, and dehydrogenation** to various intermediates that enter the Krebs cycle; lipids get hydrolyzed by **lipases** into **glycerol** and **fatty acids**. Several fatty acids and hydrocarbons are catabolized by  **$\beta$ -oxidation** that can be further broken down via glycolysis and the **Krebs cycle** reactions.

Aromatic and complex natural compounds are degraded by microbes involving aerobic and anaerobic metabolic pathways. Under aerobic conditions, aromatic compounds pass through the  **$\beta$ -keto adipate pathway** and are transformed by **monooxygenases** and **dioxygenases** into a few central intermediates, such as **catechol**, **protocatechuate**, and **gentisate**, which are commonly referred to as **funneling pathways** (see Harwood and Parales [1996] for a detailed review). There are diverse types of compounds that are metabolized, such as **phenanthrene**, **cinnamate**, **tryptophan**, and **salicylate**, that lead to **catechol** formation. Another subset of intermediates, involving at least these simple ring compounds, like **4-coumerate**, **shikimate**, **quininate**, **ferulate**, **vanillate**, and **conferyl alcohol**, are dihydroxylated, making them favorable for an oxidative cleavage of the aromatic ring. Under anaerobic conditions, aromatic compounds have to be transformed by other means than by oxygenases. This is because the aromatic ring structures, especially those with low molecular weights, are reductively attacked (Evans and Fuchs, 1988).

The existence of the bacterial enzymes, **oxidoreductases**, that convert aromatic compounds through several electron-transfer pathways, suggests that these enzymes have very wide substrate specificity. The ability to convert a range of aromatic compounds to a metabolizable form requires several unique features. One of the most common features includes the Radical-SAM signature. **Radical SAM** is an ancient and diverged group with 645 unique sequences from 126 species that was found recently in all

three domains of life. At least half of the proteins are of unknown activity (Sofia et al., 2001). The superfamily (Radical-SAM) provides evidence that **radical-based catalysis** is important in a number of previously well-studied but unresolved pathways and reflects an ancient conserved mechanistic approach to difficult chemistries. Radical-SAM proteins catalyze diverse reactions, including unusual **methylations, isomerization, sulfur insertion, ring formation, anaerobic oxidation, and protein radical** formation. Currently, several mathematical models and programs to predict SAM are available. However, they need refinement.

We can summarize this section by saying that root exudates are highly complex in nature because they possess both unique and chemical moieties. Nature maintains a balance by helping microbes in the rhizosphere evolve capabilities, via synthesis of new enzymes or by modification of existing ones that have a wide substrate range to act upon, rather than be specific to one or a limited few. To put it in simple terms, the more diverse the compounds produced in nature are, the more diverse will be the existing enzymes, increasing their range so as to utilize the hydrolyzed phytochemicals that were previously not possible.

Some degradative pathways for natural products in the rhizosphere are described below.

### 4.3.5 Genetic Organization of Phenylpropanoid-Degrading Microbes

Acquisition of knowledge about numerous plant metabolism pathways, and an equally diverse number of microbial pathways involved in phytochemical degradation, triggered interest in the molecular biology of these pathways. However, the genetic organization of such degradation genes in microbes is still being examined. Novel genes involved in the degradation of phytochemicals and associated events, including rhizosphere-responsive genes, are continually being discovered at a rapid rate. Biosynthesis and degradation of two nodule-specific *Rhizobium loti* compounds in *Lotus* nodules act as molecular signals to trigger establishment of symbioses with bacteria in *Rhizobiaceae* (Rao et al., 1991). There are flavonoids that are known to interact with *nodD* gene products of *Rhizobia* to activate subsequent transcription of other *nod* genes (Peters et al., 1986) (see also Chapter 3). Diverse substrates, low specificity of enzymes, and complex signaling events are expected to lead to exciting findings.

Biotransformation studies of a **pentahydroxy flavone, quercetin**, reported quercetin catabolism in an arabinose-based medium via a novel form of ring cleavage, yielding **phloroglucinol** and **protocatechuic acid** (Rao et al., 1991). Conservation of A and B rings of the flavone suggested that a chalcone could be formed as a transient product in the membrane. Catabolism of the *nod* gene-inducing flavonoids by *Rhizobia* via C-ring fission was also reported (Rao and Cooper, 1994). Degradation of **catechin** by *Bradyrhizobium japonicum* occurs via ring cleavage by **catechin oxygenase** to form **phloroglucinol-carboxylic acid** and protocatechuic acid as the initial products. These were further decarboxylated to phloroglucinol and dehydrated to **resorcinol** (Hopper and Mahadevan, 1991). Some dietary flavonoids are ligands of the **aryl hydrocarbon receptor (AhR)** and arrest the cell cycle (Reiners et al., 1999).

Phenylpropanoid degradation can be caused by soil pseudomonads that possess new oxygenases for the degradation of **flavones** and **flavonones** (Schultz et al., 1974). Degradation of flavonoids by *Pseudomonas putida* occurs when there is a fission in the A-ring via hydroxylation at C-8. A generally accepted pathway for the degradation of flavones and flavonones by *Pseudomonas putida* converts such compounds to protocatechuate and catechol, which are further cleaved via the  **$\beta$ -keto adipate pathway**, resulting in the formation of **oxaloacetic acid**. Oxaloacetate is then routed through the TCA cycle for further metabolism and energy generation. A schematic pathway is shown in Figure 4.4. Details on the organization and complete nucleotide sequence of a gene cluster specifying **3-chlorocatechol** degradation in *Pseudomonas* spp. are available elsewhere (Frantz and Chakrabarty, 1987). These genes are found in a **transposon** that resides on a self-transmissible **plasmid**. In the degradation cascade, the aromatic ring of these compounds is opened during reactions catalyzed by dioxygenase enzymes in which both atoms of oxygen from O<sub>2</sub> are incorporated into the substrate. **Protocatechuate 3,4-dioxygenase** [EC1.13.1.3] was among the first of the Fe(III) dioxygenases to be recognized (Fujisawa and Hayashi, 1968). In addition, various intermediates were identified with different phenolics as carbon sources in the environment. **Phenolic degradation pathways** produce acids that are partly subjected to further degradation. The phenolics detected over time may not be consistent. Jeffrey and co-workers (1972) showed

degradation of **taxifolin** involving hydroxylation of its A-ring in a pseudomonad and also the oxidative fission of the A-ring of another compound, **dihydrogossypetin**. This shows that different metabolisms exist for different compounds, all in a single bacterial species. Such versatility of the soil microbes allows speculation about the existence of novel metabolic regulatory pathways in these strains.

Recently, the crystal structure of the copper-containing **quercetin 2,3-dioxygenase** enzyme from *Aspergillus japonicus* was determined (Fusetti et al., 2002). This enzyme catalyzes the insertion of molecular oxygen into **polyphenolic flavonols**, thus forming several stable and transient metabolic intermediates. Our detailed studies on *P. putida* PML2 strain showed that an **Fe-S oxidoreductase**-type enzyme is involved in the breakdown of **quercetin** to **naringenin** (Pillai and Swarup, 2002).

There is an increasing amount of information on genetic organization of phenylpropanoid genes. This variety of new genes will be helpful in manipulating them for targeted applications involving the use of biotechnology. Some of these applications are discussed in the sections that follow.

---

## 4.4 Transferring Genes from Plants to Rhizosphere Microbes and Vice Versa

The use of recombinant DNA technology to manipulate metabolic processes in a cell provides important contributions to agriculture and medicine. Several aspects of plant and microbial metabolism were targets of genetic manipulation over the years. Plant metabolism is a particularly attractive target for the improvement of desirable products without markedly affecting basic cellular functions. Some efforts toward the transfer of genes include overexpression of heterologous genes/enzymes in the pathway and **antisense RNA-mediated suppression** of genes; others include rerouting of plant metabolic pathways by the use of enzymes from other organisms, such as bacteria and fungi, that are involved in an opposite activity. All of this is done with the sole objective of manipulating existing pathways or metabolic cascades. While this advancement no doubt has tremendous benefits, it also comes with some concerns in the use and dispersal of **genetically modified organisms (GMOs)**.

### 4.4.1 Transfer of Degradative Pathways

Genetic approaches provide a means by which to determine the complex biochemical pathways involved in the synthesis and regulation of metabolites and to manipulate pathways to increase or initiate the production of economically desirable metabolites.

Many plant genes have been expressed in microbial systems. Although it sounds like a commonly adopted strategy for production of recombinant proteins, one not-so-well-known example is briefly mentioned. In this study, the enzyme **caffeine synthase** from young tea leaves that catalyzes the final two steps in the **caffeine biosynthesis pathway** was successfully expressed in the *E. coli* system and characterized. This plant gene was successfully used in transgenic plant production. What were the consequences? This study opened up the possibility of creating tea (*Camelia sinensis*) and coffee (*Coffea arabica*) plants that are naturally deficient in caffeine (Kato et al., 2000). This successful case encourages the notion that manipulation of metabolic pathways in plants is possible using several approaches, and that no single approach may be suitable for all types of applications. Some of the molecular techniques available for pathways manipulation are described in Chapter 5.

### 4.4.2 Examples of Microbial Gene Transfer Associated with Degradative Pathways in Plants

The abundance of natural compounds in the rhizosphere sparked great interest for researchers to manipulate or engineer the levels of specific compounds. Understanding the genes involved in natural product synthesis or exudation from plants and the degradation genes in microbes has provided us with tools for further applications. One of the classical cases frequently referred to involves the transfer of the bacterial **nahG gene** to plants to alter salicylate content (Friedrich et al., 1995).

The expression of bacterial genes in transgenic plants has proven to be effective in introducing new pathways to increase the accumulation of desired compounds (Fecker et al., 1993; Siebert et al., 1996). **Salicylic acid** content in *Arabidopsis thaliana* could be manipulated by expressing an engineered bacterial **salicylate synthase** by the fusion of two bacterial genes *pchA* and *pchB*, from the human pathogen *Pseudomonas aeruginosa*, that encode **isochorismate synthase** and **isochorismate pyruvate-lyase** expressed under a constitutive promoter (Mauch et al., 2001). It was previously shown that salicylate was involved in SAR by the production of transgenic plants expressing the *nahG* gene from the soil bacterium, *P. putida*. The *nahG* gene encodes **salicylate hydroxylase**, which converts salicylate to **catechol**. Also, the *hrp* genes from the plant pathogen, *P. syringae*, were successfully transferred to plants that are known to elicit a hypersensitive response in disease-resistant plants (Gopalan et al., 1996). Another study reported that transient expression of a bacterial avirulence gene elicits **hypersensitive cell death** in plants (Tabakaki et al., 1999). All of these studies established the successful expression of bacterial genes in plant systems to manipulate various traits.

One interesting study reported the rerouting of plant **phenylpropanoid pathway** by expression of a novel bacterial **enoyl-CoA hydratase/lyase** enzyme function (Mayer et al., 2001). The gene for a bacterial **enoyl-CoA hydratase (crotonase) homolog (HCHL)** that was previously shown to convert **4-coumaroyl-CoA**, **caffeoyl-CoA**, and **feruloyl-CoA** to the corresponding hydroxybenzaldehydes (Mitra et al., 1999) *in vitro* was used to subvert the plant phenylpropanoid pathway and channel carbon flux through **4-hydroxybenzaldehyde** and **4-hydroxy-3-methoxybenzaldehyde**. HCHL plants exhibited increased accumulation of transcripts for **phenylalanine ammonia-lyase (PAL)**, **cinnamate-4-hydroxylase**, and **4-coumarate: CoA ligase**. This study, exploiting the ability of a bacterial gene to divert plant secondary metabolism, provides insight into how plants modify inappropriately accumulated metabolites and reveals some consequences of depleting the major phenolic pools.

All of these examples established the successful expression of bacterial genes in plant systems to manipulate various traits influencing plant metabolism and exudation. The ability to manipulate plant metabolic pathways and its products can be exploited in **rhizoengineering** so that a biased or controlled environment favoring particular groups could be created.

---

## 4.5 Applications of Natural Products in Rhizoengineering

Increasing evidence suggests that natural products released through root exudates might initiate and manipulate biological and physical interactions between roots and soil organisms, and thus, play an active role in root–root and root–microbe communication. These exotic compounds include several types of signal molecules, as the case of isoflavones in the legume–*Rhizobium* relationship, that are critical for agriculture. Among the most widely studied compounds in root exudates are these signal molecules, because they initiate a wide range of interactions between plants, as well as between plants and microorganisms, and between nematodes and plants. A typical example is the role of isoflavones in the legume–*Rhizobium* relationship in fixing atmospheric nitrogen (N<sub>2</sub>) in soil. In this case, both the plants and microbes benefit. This process is called **symbiosis** (see Chapters 2 and 3 for more details).

Compounds produced in plant metabolism are unique and are not utilized by the majority of the microbes in the soil environment. Only certain groups of microbes, such as *Pseudomonas*, have acquired the ability to degrade complex plant metabolites through coevolution. **Coevolution** describes the adaptation by two different (unrelated) species that have acquired the properties to depend on each other for mutual benefit. Consider plants and soil microbes: there is little evidence that allows us to determine whether plant metabolites arose for the purpose of preventing microbes from colonizing the plant roots. Certain plants may have produced certain compounds as waste products, and microbes could have colonized those plants so that they could digest these metabolites successfully. This trait could have been made possible through a change in the genetic composition of one species (or group) in response to a genetic change in another. In more general terms, the idea of some reciprocal evolutionary change in interacting species is a strict definition of coevolution.

As plants exude a wide spectrum of metabolites into the rhizosphere, the selection of metabolites is crucial for the purpose of **rhizoengineering**. We list two characteristics these compounds should possess:

(1) they should be beneficial to one group of microbes, but at the same time, be harmful to others; and (2) the structures of these compounds should be complex because microbes with specialized enzymes should selectively be able to metabolize these compounds. Among the very few compounds that fit into these criteria include flavones and lignins.

Compounds involved in the lignin pathway as well as the flavonoid pathway are ideal targets for rhizoengineering purposes. The advantage of these groups of metabolites is that they are synthesized by all tissues in the plant, and they are complex and not easily metabolized by most microbes. Compounds that belong to this group are, to an extent, antimicrobial to most rhizobacteria. Because the majority of plants exude secondary metabolites in one form or another into the rhizosphere, they are ideal candidates for rhizoengineering. Hence, a detailed investigation of different types of phytochemicals is required in order to analyze the potential target compounds to be used for the purpose of rhizoengineering.

A rhizosphere that has a bias to one group of microbes based on nutrition partitioning is called a **biased rhizosphere**. This phenomenon of biased rhizosphere based on nutritional bias could be created using two different approaches: by utilizing endogenously synthesized metabolites in root exudates or by introducing a foreign gene capable of producing the exotic nutrient. Compounds exuded by plant roots could be manipulated to create a biased rhizosphere. Survival and competition of introduced microbes over the resident microbes depends on the ability of the microbes to metabolize exotic compounds in the rhizosphere.

Several groups have successfully shown evidence for both of the above cases. Studies on the role of opines (which are small amino acid and sugar conjugates) showed that they play a major role in *Agrobacterium*–plant interaction. Those microbes that could use these opines were shown to have an added advantage in colonizing the plants. This is supported by the occurrence of natural biases, such as those generated by **opine-like molecules**, by **calestegins**, or by **mimosine**. Opine-mediated biases allowed several investigators to favor the growth of opine-degrading bacteria or communities under sterile or axenic environments or in microcosms nearly mimicking field conditions (Oger et al., 1997). This phenomenon was also shown to be independent of both soil type and plant species (Mansouri et al., 2002). This interaction promotes the growth of the inoculants (microbes) in the plant environment. The establishment of the microbes on the plant surface is a typical case for the creation of a biased rhizosphere. Work from the laboratory of Savka and Farrand (1997) also used the opine concept to improve root colonization by rhizobacteria.

Transgenic plants that produce foreign metabolites were also used to create biased rhizospheres (Oger et al., 1997; Savka and Farrand, 1997). Engineering root exudation of *Lotus* spp. toward the production of two novel carbon compounds resulted in the selection of distinct microbial populations in the rhizosphere (Oger et al., 1997). Another way to favor a given microbe consists in impeding the growth of competing microorganisms.

---

## 4.6 Rhizoremediation

Worldwide, contamination of soil and groundwater is a severe problem. The search for alternative methods to excavation and incineration to clean polluted sites has resulted in the development of **bioremediation techniques**. The use of plants to support pollutant-degrading bacteria has a number of advantages because plants exude up to half of their photosynthetically fixed carbon into the rhizosphere through root exudates (Lynch and Whipps, 1990).

This approach was shown to be successful in several cases, as reported for *Pseudomonas putida* strain PCL1444, which degrades **naphthalene** and utilizes ryegrass (*Lolium multiflorum*) cultivar, ‘Barmultra’ root exudates (Kuiper et al., 2002). Kuiper, Bloemberg, and Lugtenberg (2001) also demonstrated selective rhizostimulation by using a plant-microbe pair to stimulate degradation of soil polluted by **polycyclic aromatic hydrocarbon (PAH)**. Using a novel procedure, the authors successfully showed the selection of a microbe–plant pair for the stable and efficient degradation of naphthalene. They used the rationale that root exudates are the best nutrient source available in the soil. Ryegrass cultivar ‘Barmultra’ was selected because of its ability to produce a highly branched root system, root deeply, and carry a high population of bacteria, namely *Pseudomonas* spp., on its roots. Starting with a mixture

of total rhizobacteria from grass-like vegetation collected from a heavily polluted site, and selecting for stable naphthalene degradation as well as for efficient root colonization, a *Pseudomonas putida* strain, PCL1444, was isolated. This strain's ability to degrade naphthalene was shown to be stable in the rhizosphere. Moreover, it was found to have superior root-colonizing properties, because after the inoculation of grass seedlings, it appeared to colonize the root tips up to one hundred times better than the efficient root colonizer, *Pseudomonas fluorescens* WCS365. Strain PCL1444 uses root exudate as the dominant nutrient source because the presence of grass seedlings in the soil results in up to a tenfold increase in the number of PCL1444 cells (Kuiper et al., 2001).

A second example comes from our studies, using nonrecombinant strains, where we found that a majority of **PCBs (polychlorinated biphenyls)** were degraded by *P. putida* associated with *Arabidopsis* roots (Narasimhan et al., 2003).

The major benefit of using plants to assist in the biodegradation of organic pollutants is the increase in population densities of degrader organisms in the rhizosphere, especially because of nutrients released into the rhizosphere through root exudates (Karthikeyan and Kulakow, 2003; Olson et al., 2003; Tsao, 2003). In certain other cases involving rhizoremediation, exudates derived from the plant can help to stimulate the survival and action of bacteria, which subsequently results in a more efficient degradation of pollutants. The root systems of plants can help to spread bacteria through the soil by penetrating otherwise impermeable soil layers. Likewise, the inoculation of pollutant-degrading bacteria onto plant seeds can be an important additive to improve the efficiency of phytoremediation or bioaugmentation (Kuiper et al., 2004).

Plant–bacterial combinations can increase contaminant degradation in the rhizosphere, but the role played by indigenous root-associated bacteria during plant growth in contaminated soils is unclear. To address this issue, Siciliano et al. (2001) showed that selective enhancement of specific endophytic bacterial genotypes by plants occurs in response to soil contamination. Plant-assisted rhizoremediation in the long run will turn into an effective mode for rhizoremediation of toxic organic pollutants. At petroleum hydrocarbon-contaminated sites, two genes encoding hydrocarbon degradation, **alkane monooxygenase (alkB)** and **naphthalene dioxygenase (ndoB)**, were two and four times more prevalent in bacteria extracted from the root interiors (**endophytic bacteria**) than from the bulk soil and sediment, respectively. These results indicate that the enrichment of catabolic genotypes in the root interior is both plant- and contaminant-dependent.

---

## 4.7 Conclusions

It is known that close to half of the carbon fixed by photosynthesis can eventually find its way into the rhizosphere by way of exudation of metabolites from the roots of plants (rhizosecretion). Root exudates can then be acted upon by microbes that possess a variety of enzyme systems to further modify or degrade such exuded metabolites. Taken together, such processes lead to a high degree of diversity in the types of natural products found in the rhizosphere. Recent trends in analytical chemistry instrumentation have made highly sensitive detection methods amenable to use by biologists. Hence, a wide variety of such natural products can be studied for their roles in the rhizosphere interactions between plants, microbes, and the soil. Studies of these interactions are highly desirable and useful in creating biased rhizospheres. Hence, natural products of the rhizosphere can help in improving the populations of desirable microbes, while at the same time, reducing those of the undesirable ones such as pathogenic species. Another application of studying rhizosphere compounds is to discover microbial enzyme systems that can be expressed in plants or other microbes for metabolic pathway engineering for industrial or agricultural use.

---

## References

- Akhtar, M. and I. Mahmood. (1994). Potentiality of phytochemicals in nematode control. *Bioresour Technol* 48: 189–201.
- Alexander, M. (1981). Biodegradation of chemicals of environmental concern. *Science* 211: 132–138.



- Baggi, G., M.M. Boga, D. Catelani, E. Galli, and V. Treccani. (1983). Styrene catabolism by a strain of *Pseudomonas fluorescens*. *Syst and Appl Microbiol* 4: 141–147.
- Bais, H.P., S.-W. Park, T.L. Weir, R.M. Callaway, and J.M. Vivanco. (2004). How plants communicate using the underground information superhighway. *Trends Plant Sci* 9: 26–32.
- Boudet, A.-M. (1998). A new view of lignification. *Trends Plant Sci* 3: 67–71.
- Boudet, A.-M. and J. Grima-Pettenati. (1996). Lignin genetic engineering. *Mol Breeding* 2: 25–39.
- Brown, D.E., A.M. Rashotte, A.S. Murphy, J. Normanly, B.W. Tague, W.A. Peer, L. Taiz, G.K. Muday, and K. Gloria. (2001). Flavonoids act as negative regulators of auxin transport *in vivo* in *Arabidopsis*. *Plant Physiol* 126: 524–535.
- Brunner, W., F.H. Sutherland, and D.D. Focht. (1985). Enhanced degradation of polychlorinated biphenyls in soil by analog enrichment and bacterial inoculation. *J Environ Qual* 14: 324–328.
- Buswell, J.A. and J.S. Clark. (1976). Oxidation of aromatic acids by a facultative thermophilic *Bacillus* sp. *J Gen Microbiol* 96: 209–213.
- Chapple, C., B. Shirley, M. Zook, R. Hammerschmidt, and S. Somerville. (1994). Secondary metabolism in *Arabidopsis*. In *Arabidopsis*, E. Meyerowitz and C. Somerville (Eds.). Cold Spring Harbor Laboratory Press, Cold Spring Harbor, New York, pp. 989–1030.
- Dayan, F.E., I.A. Kagan, and A.M. Rimando. (2003). Elucidation of the biosynthetic pathway of the allelochemical sorgoleone using retrobiosynthetic NMR analysis. *J Biol Chem* 278: 28607–28611.
- De Freitas, J.R. and J.J. Germinda. (1992). Growth promotion of winter wheat by fluorescent pseudomonads under field conditions. *Soil Biol and Biochem* 24: 1137–1146.
- Erickson, J., D. Schott, T. Reverri, W. Muhsin, and T. Ruttledge. (2001). GC-MS analysis of hydrophobic root exudates of sorghum and implications on the parasitic plant *Striga asiatica*. *J Agric and Food Chem* 49: 5537–5542.
- Evans, W.C. and G. Fuchs. (1988). Anaerobic degradation of aromatic compounds. *Annu Rev Microbiol* 42: 289–317.
- Fan, T.W., A.N. Lane, M. Shenker, J.P. Bartley, D. Crowley, and R.M. Higashi. (2001). Comprehensive chemical profiling of gramineous plant root exudates using high-resolution NMR and MS. *Phytochemistry* 57: 209–221.
- Fecker, L.F., C. Rugenhausen, and J. Berlin. (1993). Increased production of cadaverine and anabasine in hairy root cultures of *Nicotiana tabacum* expressing a bacterial lysine decarboxylase gene. *Plant Mol Biol* 23: 11–21.
- Frantz, B. and A.M. Chakrabarty. (1987). Organization and nucleotide sequence determination of a gene cluster involved in 3-chlorocatechol degradation. *Proc Natl Acad Sci USA* 84: 4460–4464.
- Friedrich, L., B. Vernooj, T. Gaffney, A. Morse, and J. Rylas. (1995). Characterisation of tobacco plants expressing a bacterial salicylate hydroxylase gene. *Plant Mol Biol* 29: 959–968.
- Fujisawa, H. and O. Hayashi. (1968). Protocatechuate 3,4-dioxygenase: crystallization and characterization. *J Biol Chem* 243: 2673–2681.
- Fusetti, F., K.H. Schröter, R.A. Steiner, P.I. van Noort, T. Pijning, H.J. Rozeboom, K.H. Kalk, M.R. Egmond, and B.W. Dijkstra. (2002). Crystal structure of the copper-containing quercetin 2,3-dioxygenase from *Aspergillus japonicus*. *Structure* 10: 259–268.
- Gopalan, S., D. Bauer, J. Alfano, A. Loniello, S.Y. He, and A. Collmer. (1996). Expression of the *Pseudomonas syringae* avirulence protein AvrB in plant cells alleviates its dependence on the hypersensitive response and pathogenicity (Hrp) secretion system in eliciting genotype-specific hypersensitive cell death. *Plant Cell* 8: 1095–1105.
- Görisch, H. (2003). The ethanol oxidation system and its regulation in *Pseudomonas aeruginosa*. *Biochim Biophys Acta* 1647: 98–102.
- Hain, R., H.J. Reif, E. Krause, R. Langebartels, H. Kindl, B. Vornam, W. Wiese, E. Schmelzer, P.H. Schreier, R.H. Stocker, and K. Stenzel. (1993). Disease resistance results from foreign phytoalexin expression in a novel plant. *Nature* 361: 153–156.
- Hamill, J.D., R.J. Robins, A.J. Parr, D.M. Evans, J.M. Furze, and M.J.C. Rhodes. (1990). Over-expression of a yeast ornithine decarboxylase gene in transgenic roots of *Nicotiana rustica* can lead to enhanced nicotine accumulation. *Plant Mol Biol* 15: 27–38.
- Hang, T.-P., L. Bassie, G. Safwat, P. Trung-Nghia, P. Christou, and T. Capell. (2002). Expression of a heterologous S-adenosylmethionine decarboxylase cDNA in plants demonstrates that changes in S-adenosyl-L-methionine decarboxylase activity determine levels of the higher polyamines spermidine and spermine. *Plant Physiol* 29: 1744–1754.

- Harwood, C.S. and R.E. Parales. (1996). The  $\beta$ -ketoacid pathway and the biology of self-identity. *Annu Rev Microbiol* 50: 553–590.
- Hodge, A., S.J. Grayston, and B.G. Ord. (1996). A novel method for characterization and quantification of plant root exudates. *Plant and Soil* 184: 97–104.
- Hopper, W. and A. Mahadevan. (1991). Utilization of catechin and its metabolites by *Bradyrhizobium japonicum*. *Appl Microbiol Biotechnol* 35: 411–415.
- Humphrey, A.J. and D. O'Hagan. (2001). Tropane alkaloid biosynthesis. A century old problem unresolved. *Nat Prod Rep* 18: 494–502.
- Istatkova, R. and S. Philipov. (2004). Alkaloids from *Isopyrum thalictroides* L. *Nat Prod Rep* 18: 259–263.
- Jeffrey, A.M., M. Knight, and W.C. Evans. (1972a). The bacterial degradation of flavonoids: hydroxylation of the A-ring of taxifolin by a soil pseudomonad. *Biochem J* 130: 373–380.
- Jeffrey, A.M., D.M. Jerina, R. Self, and W.C. Evans. (1972b). The bacterial degradation of flavonoids: oxidative fission of the A-ring of dihydrogossypetin by a *Pseudomonas* sp. *Biochem J* 130: 383–390.
- Kagan, I.A., A.M. Rimando, and F.E. Dayan. (2003). Chromatographic separation and *in vitro* activity of sorgoleone congeners from the roots of *Sorghum bicolor*. *J Agric and Food Chem* 51: 7589–7595.
- Karthikeyan, R. and P.A. Kulakow. (2003). Soil plant microbe interactions in phytoremediation. *Adv Biochem Eng and Biotech* 78: 51–74.
- Kato, M., K. Mizuno, A. Crozier, T. Fujimura, and H. Ashihara. (2000). Caffeine synthase gene from tea leaves. *Nature* 406: 956–957.
- Kneer, R., A. Poulev, A. Olesinski, and I. Raskin. (1999). Characterization of the elicitor-induced biosynthesis and secretion of genistein from roots of *Lupinus luteus* L. *J Exp Bot* 50: 1553–1559.
- Krishnamurthy, H.G., K.-J. Cheng, G.A. Jones, F.J. Simpson, and J.E. Watkin. (1970). Identification of products produced by the anaerobic degradation of rutin and related flavonoids by *Butyrivibrio* sp. C3. *Can J Microbiol* 16: 759–767.
- Krumholz, L.R., R.L. Crawford, M.E. Hemling, and M.P. Bryant. (1987). Metabolism of gallate and phloroglucinol in *Eubacterium oxidoreducens* via 3-hydroxy-5-oxohexanoate. *J Bacteriol* 169: 1886–1890.
- Kuiper, I., G.V. Bloemberg, and B.J. Lugtenberg. (2001). Selection of a plant–bacterium pair as a novel tool for rhizostimulation of polycyclic aromatic hydrocarbon-degrading bacteria. *Mol Plant Microbe Interaction* 14: 1197–1205.
- Kuiper, I., L.V. Kravchenko, G.V. Bloemberg, and B.J. Lugtenberg. (2002). *Pseudomonas putida* strain PCL1444, selected for efficient root colonization and naphthalene degradation, effectively utilizes root exudate components. *Mol Plant Microbe Interaction* 15: 734–741.
- Kuiper, I., E.L. Lagendijk, G.V. Bloemberg, and B.J.J. Lugtenberg. (2004). Rhizoremediation: a beneficial plant–microbe interaction. *Mol Plant Microbe Interaction* 17: 6–15.
- Kuzyakov, Y. and S.V. Siniakina. (2001). A novel method for separating root-derived organic compounds from root respiration in non-sterilized soils. *J Plant Nutr and Soil Sci* 164: 511–517.
- Lijeroth, E., P. Kuikman, and J.A.V. Veen. (1994). Carbon translocation to the rhizosphere of maize and wheat and influence on the turnover of native soil organic matter at different soil nitrogen levels. *Plant and Soil* 161: 233–242.
- Lugtenberg, B.J., L.A. De Weger, and J.W. Bennett. (1991). Microbial stimulation of plant growth and protection from disease. *Curr Opinion in Biotechnol* 2: 457–464.
- Lynch, J.M. and J.M. Whipps. (1990). Substrate flow in the rhizosphere. *Plant and Soil* 129: 1–24.
- Mansouri, H., A. Petit, P. Oger, and Y. Dessaux. (2002). Engineered rhizosphere: the trophic bias generated by opine-producing plants is independent of the opine type, the soil origin and the plant species. *Appl and Environ Microbiol* 69: 2562–2566.
- Marschner, H. (1995). Mineral nutrition of higher plants. Yield and the source–sink relationships. In *Nutritional Physiology*, Part I, H. Marschner (Ed.). Academic Press, New York, pp. 131–183.
- Martin, J.J.V. and W.W. Mohn. (1999). A novel aromatic ring-hydroxylating dioxygenase from the diterpenoid-degrading bacterium *Pseudomonas abietaniphila* BKME-9. *J Bacteriol* 181: 2675–2682.
- Mathesius, U., S. Mulders, M. Gao, M. Teplitski, G. Caetano-Anolles, B.G. Rolfe, and W.D. Bauer. (2003). Extensive and specific responses of a eukaryote to bacterial quorum sensing signals. *Proc Natl Acad Sci USA* 100: 1444–1449.
- Mauch, F., B. Mauch-Mani, C. Gaille, B. Kull, D. Haas, and C. Reimann. (2001). Manipulation of salicylate content in *Arabidopsis thaliana* by the expression of an engineered bacterial salicylate synthase. *Plant J* 25: 67–77.

- Mayer, M.J., A. Narbad, A.J. Parr, M.L. Parker, N.J. Walton, F.A. Mellon, and A.J. Michael. (2001). Rerouting the plant phenylpropanoid pathway by expression of a novel bacterial enoyl-CoA hydratase/lyase enzyme function. *Plant Cell* 13: 1669–1682.
- Mitra, A., Y. Kitamura, M.J. Gasson, A. Narbad, A.J. Parr, J. Payne, M.J.C. Rhodes, C. Sewter, and M.J. Walton. (1999). 4-Hydroxycinnamoyl-CoA hydratase/lyase (HCHL): an enzyme of phenylpropanoid chain cleavage from *Pseudomonas*. *Arch Biochem Biophys* 365: 10–16.
- Mueller, L.A., P. Zhang, and S.Y. Rhee. (2003). AraCyc: a biochemical pathway database for *Arabidopsis*. *Plant Physiol* 132: 453–460.
- Murphy, A., W.A. Peer, and L. Taiz. (2000). Regulation of auxin transport by aminopeptidases and endogenous flavonoids. *Planta* 211: 315–324.
- Narasimhan, K., C. Basheer, V.B. Bajic, and S. Swarup. (2003). Enhancement of plant–microbe interactions using a rhizosphere metabolomics-driven approach and its application in the removal of polychlorinated biphenyls. *Plant Physiol* 132: 146–153.
- Nesi, N., I. Debeaujon, C. Jond, G. Pelletier, M. Caboche, and L. Lepiniec. (2000). The tt8 gene encodes a basic helix-loop-helix domain protein required for expression of DFR and BAN genes in *Arabidopsis* siliques. *Plant Cell* 12: 1863–1878.
- Neumann, G. and V. Römheld. (1999). Root excretion of carboxylic acids and protons in phosphorus-deficient plants. *Plant and Soil* 211: 121–130.
- Odham, G., A. Tunlid, A. Valeur, P. Sundein, and C.W. White. (1986). Model system for studies of microbial dynamics at exuding surfaces such as the rhizosphere. *Appl and Environ Microbiol* 51: 191–196.
- Oger, P., A. Petit, and Y. Dessaux. (1997). Genetically engineered plants producing opines alter their biological environment. *Nature Biotechnol* 15: 369–372.
- O’Keefe, D.P., K.J. Gibson, M.H. Emptage, R. Lenstra, J.A. Romesser, P.J. Little, and C.A. Omer. (1991). Ferridoxins from two sulfonyleurea herbicide monooxygenase systems in *Streptomyces griseolus*. *Biochem* 30: 447–455.
- Oliveira, E.J., D.G. Watson, and M.H. Grant. (2002). Metabolism of quercetin and kaempferol by rat hepatocytes and the identification of flavonoid glycosides in human plasma. *Xenobiotica* 32: 279–287.
- Olson, P.E., T. Wong, M.B. Leigh, and J.S. Fletcher. (2003). Allometric modeling of plant root growth and its application in rhizosphere remediation of soil contaminants. *Environ Sci and Technol* 37: 638–643.
- Paiva, N.L. (2000). An introduction to the biosynthesis of chemicals used in plant–microbe communication. *J Plant Growth Regul* 19: 131–143.
- Park, S.-U., M. Yu, and P.J. Facchini. (2002). Antisense RNA-mediated suppression of benzophenanthridine alkaloid biosynthesis in transgenic cell cultures of California poppy. *Plant Physiol* 128: 696–706.
- Park, Y.G., M.S. Choi, J.K. Yang, and K.H. Park. (2001). Allelopathic potential and substances from cork tree (*Phellodendron amurense* Rupr.). *J Korean Wood Sci and Technol* 29: 92–98.
- Pelletier, M.K., A.E. Burbulis, and B.W. Shirley. (1999). Disruption of specific flavonoid genes enhances the accumulation of flavonoid enzymes and end-products in *Arabidopsis* seedlings. *Plant Mol Biol* 40: 45–54.
- Peters, N.K., J.W. Frost, and S.R. Long. (1986). A plant flavone luteolin induces expression of *Rhizobium meliloti* nodulation genes. *Science* 233: 977–979.
- Pillai, B.V.S. and S. Swarup. (2002). Elucidation of the flavonoid catabolism pathway in *Pseudomonas putida* PML2 strain by comparative metabolic profiling. *Appl and Environ Microbiol* 68: 143–151.
- Pinton, R., Z. Varanini, and P. Nannipieri. (2001). The rhizosphere as a site of biochemical interactions among soil components, plants and microorganisms. In *The Rhizosphere*, R. Pinton, Z. Varanini, and P. Nannipieri (Eds.). Marcel Dekker, New York, pp. 1–17.
- Pothier, J. 1996. Practical thin-layer chromatography: A multidisciplinary approach. In *Thin-Layer Chromatography in Plant Sciences*, J. Sherma and B. Fried (Eds.). CRC Press, Boca Raton, Florida, pp. 33–50.
- Raab, T.K. and M.C. Martin. (2001). Visualizing rhizosphere chemistry of legumes with mid-infrared synchrotron radiation. *Planta* 213: 881–887.
- Rao, A.S. (1990). Root flavonoids. *Bot Rev* 56: 1–84.
- Rao, R.J. and J.E. Cooper. (1994). *Rhizobia* catabolize nod gene-inducing flavonoids via C-ring fission mechanisms. *J Bacteriol* 176: 5409–5413.
- Rao, R.J., N.D. Sharma, J.T.G. Hamilton, D.R. Boyd, and J.E. Cooper. (1991). Biotransformation of the pentahydroxy flavone quercetin by *Rhizobium loti* and *Bradyrhizobium* strains (Lotus). *Appl and Environ Microbiol* 57: 1563–1565.

- Reiners, Jr., J.J., R. Clift, and P. Mathieu. (1999). Suppression of cell cycle progression by flavonoids: dependence on the aryl hydrocarbon receptor. *Carcinogenesis* 20: 1561–1566.
- Sakai, S. (1977). Degradation of the plant flavonoid phellamurin by *Aspergillus niger*. *Appl and Environ Microbiol* 34: 500–505.
- Sato, F., T. Hashimoto, A. Hachiya, K. Tamura, K.-B. Choi, T. Morishige, H. Fujimoto, and Y. Yamada. (2001). Inaugural article: metabolic engineering of plant alkaloid biosynthesis. *Proc Natl Acad Sci USA* 98: 367–372.
- Savka, M. and S.K. Farrand. (1997). Modification of rhizobacterial populations by engineering bacterium utilization of a novel plant-produced resource. *Nat Biotechnol* 15: 363–368.
- Schoefer, L., R. Mohan, A. Schwiertz, A. Braune, and M. Blaut. (2003). Anaerobic degradation of flavonoids by *Clostridium orbiscindens*. *Appl and Environ Microbiol* 69: 5849–5854.
- Schultz, E., F.E. Engle, and J.M. Wood. (1974). New oxygenases in the degradation of flavones and flavonones by *Pseudomonas putida*. *Biochemistry* 13: 1768–1776.
- Shepherd, T. and C.B.V. Davies. (1994). Effect of exogenous amino acids, glucose and citric acid on the patterns of short-term amino acid accumulation and loss of amino acids in the root-zone of sand-cultured forage rape (*Brassica napus* L.). *Plant and Soil* 158: 111–118.
- Siciliano, S., N. Fortin, A. Mihoc, G. Wisse, S. Labelle, D. Beaumier, D. Ouellette, R. Roy, L.G. Whyte, M.K. Banks, P. Schwab, K. Lee, and C.W. Greer. (2001). Selection of specific endophytic bacterial genotypes by plants in response to soil contamination. *Appl and Environ Microbiol* 67: 2469–2475.
- Siebert, M., S. Sommer, S.-M. Li, Z.-W. Wang, K. Severin, and L. Heide. (1996). Genetic engineering of plant secondary metabolism: accumulation of 4-hydroxybenzoate glucosides as a result of the expression of the bacterial *ubiC* gene in tobacco. *Plant Physiol* 112: 811–819.
- Singer, A.C., I.P. Thompson, and M.J. Bailey. (2004). The tritrophic trinity: a source of pollutant-degrading enzymes and its implications for phytoremediation. *Curr Opin Microbiol* 7: 1–6.
- Sofia, H.J., G. Chen, B.G. Hetzler, J.F. Reyes-Spindola, and N.E. Miller. (2001). Radical SAM, a novel protein superfamily linking unresolved steps in familiar biosynthetic pathways with radical mechanisms: functional characterization using new analysis and information visualization methods. *Nucleic Acids Res* 29: 1097–1106.
- Tabakaki, A., M. Bastaki, J. Mansfield, and N.J. Panopoulos. (1999). Transient expression of a bacterial avirulence gene elicits hypersensitive cell death in plants. *Proc Hellenic Sic Biochem and Mol Biol* 46: 270–276.
- Taddei P., V. Tugnoli, G. Bottura, E. Dallavalle, and Z.A. D'Aulerio. (2002). Vibrational, <sup>1</sup>H-NMR spectroscopic, and thermal characterization of gladiolus root exudates in relation to *Fusarium oxysporum* f. sp. gladioli resistance. *Biopolymers* 67: 428–439.
- Thornton, B., E. Paterson, J.A. Midwood, A. Sim, and M. Shona. (2004). Pratt contribution of current carbon assimilation in supplying root exudates of *Lolium perenne* measured using steady-state <sup>13</sup>C labeling. *Physiol Plantarum* 120: 434–441.
- Trower, M.K.R., R. Lenstra, C. Omer, S.E. Buchholz, and F.S. Sariaslani. (1992). Cloning, nucleotide sequence determination and expression of the genes encoding cytochrome P-450<sub>soy</sub> (*soyC*) and ferridoxin<sub>soy</sub> (*soyB*) from *Streptomyces griseus*. *Mol Microbiol* 6: 2125–2134.
- Tsao, D.T. (2003). Overview of phytotechnologies. *Adv in Biochem Eng and Biotechnol* 78: 1–50.
- Ulmer, D.C., M.S.A. Leisola, B.H. Schmidt, and A. Fiechter. (1983). Rapid degradation of isolated lignins by *Phanerochaete chrysosporium*. *Appl and Env Microbiol* 45: 1795–1801.
- van Der Heijden, R., D.I. Jacobs, W. Snoeijs, D. Hallard, and R. Verpoorte. (2004). The *Catharanthus* alkaloids: pharmacognosy and biotechnology. *Curr Med Chem* 11: 607–628.
- van Sumere, C.F. (1989). Phenols and phenolic acids. In *Methods in Plant Biochemistry*, P.M. Dey and J.B. Harborne (Eds.). Academic Press, New York, pp. 29–74.
- Walker, A.R., P.A. Davison, A.C.B. Winfield, C.M. James, N. Srinivasan, T.L. Blundell, J.J. Esch, D.M. Marks, and J.C. Gray. (1999). The transparent testa glabra1 locus, which regulates trichome differentiation and anthocyanin biosynthesis in *Arabidopsis*, encodes a WD40 repeat protein. *Plant Cell* 11: 1337–1349.
- Walker, T.S., H.P. Bais, E. Grotewold, and J.M. Vivanco. (2003a). Root exudation and rhizosphere biology. *Plant Physiol* 132: 44–51.
- Walker, T.S., H.P. Bais, K.M. Halligan, F.R. Stermitz, and J.M. Vivanco. (2003b). Metabolic profiling of root exudates of *Arabidopsis thaliana*. *J Agric and Food Chem* 51: 2548–2554.

- Walker, T.S., H.P. Bais, E. Deziel, H.P. Schweizer, L.G. Rahme, R. Fall, and J.M. Vivanco. (2004). *Pseudomonas aeruginosa*-plant root interactions. Pathogenicity, biofilm formation, and root exudation. *Plant Physiol* 134: 320–331.
- Warhurst, A.M., K.F. Clarke, R.A. Hill, R.A. Holt, and C.A. Fewson. (1994). Metabolism of styrene by *Rhodococcus rhodochrous* NCIMB 13259. *Appl and Environ Microbiol* 60: 1137–1145.
- Weckwerth, W. (2003). Metabolomics in systems biology. *Annu Rev Plant Physiol and Plant Mol Biol* 54: 669–689.
- Winter, J., M.R. Popoff, P. Grimont, and V.D. Bokkenheuser. (1991). *Clostridium orbiscindens* sp. nov., a human intestinal bacterium capable of cleaving the flavonoid C-ring. *Int J Syst Bacteriol* 41: 355–357.
- Wittstock, U. and J. Gershenzon. (2002). Constitutive plant toxins and their role in defence against herbivores and pathogens. *Curr Opin in Plant Biol* 5: 300–307.
- Yamada, K., K. Mukai, and Y. Doi. (1993). Enzymatic degradation of poly (hydroxyalkanoates) by *Pseudomonas pickettii*. *Int J Biol and Macromolecules* 15: 215–220.
- Yu, O., J. Shi, A.O. Hession, C.A. Maxwell, B. McGonigle, and J.T. Odell. (2003). Metabolic engineering to increase isoflavone biosynthesis in soybean seed. *Phytochemistry* 63: 753–763.
- Yun, D.-J., T. Hashimoto, and Y. Yamada. (1992). Metabolic engineering of medicinal plants: transgenic *Atropa belladonna* with an improved alkaloid composition. *Proc Natl Acad Sci USA* 89: 11799–11803.

# 5

## *Molecular Biology of Plant Natural Products*

Sheela Reuben, Leland J. Cseke, V.S. Bhinu, Kothandarman Narasimhan,  
Masilamani Jeyakumar, and Sanjay Swarup

### CONTENTS

5.1	Introduction .....	166
5.2	Genes Involved in the Biosynthetic Pathways of Plants .....	167
5.3	Families of Metabolic Genes and Enzymes .....	169
5.3.1	Gene Families and Their Evolution .....	169
5.3.2	Cytochrome P450 Genes .....	170
5.3.2.1	Cytochrome P450s in the Phenylpropanoid Pathway .....	170
5.3.2.2	Cytochrome P450s in Signaling .....	170
5.3.2.3	Cytochrome P450s in Glucosinolate, Auxin, and Tryptophan Pathways .....	171
5.3.2.4	Cytochrome P450s and Metabolic Engineering .....	171
5.3.3	Acyl Transferases and Their Role in Secondary Metabolism .....	172
5.3.3.1	Acyl Transferases in the Cysteine Pathway .....	172
5.3.3.2	Acyl Transferases in the Anthocyanin Pathway .....	172
5.3.3.3	Acyl Transferases in the Alkaloid Pathway .....	172
5.3.3.4	Acyl Transferases in the Regulation of Phenylpropanoids .....	172
5.3.4	Glycosyltransferases and Their Role in Secondary Metabolism .....	173
5.3.5	Section Summary .....	173
5.4	Expression of Metabolism Genes .....	173
5.4.1	Gene Regulation .....	174
5.4.1.1	Transcriptional Regulation .....	174
5.4.1.2	RNA-Based Post-Transcriptional Gene Regulation .....	176
5.5	Structure and Function of Enzymes Involved in Metabolism .....	177
5.5.1	Structures of Biosynthetic Enzymes .....	177
5.5.2	Methyl Transferases and Structure Elucidation .....	177
5.5.3	Terpene Cyclases and Their Structures .....	178
5.5.4	Enzyme Complexes and Protein Interactions in Phenylpropanoid Metabolism .....	178
5.6	Molecular Biology Tools Used in Natural Product Research .....	179
5.6.1	Techniques for Gene Identification .....	179
5.6.2	Tools to Study Gene Expression .....	180
5.6.2.1	Qualitative Single-Gene Expression Analysis .....	180
5.6.2.2	Quantitative Single-Gene Analysis .....	180
5.6.2.3	Expressed Sequence Tags .....	181
5.6.2.4	Gene Microarray .....	182
5.6.3	Tools Used to Study Gene Function .....	182
5.6.3.1	Loss-of-Function Approaches to Study Gene Function .....	182
5.6.3.2	Gain-of-Function Approaches to Study Gene Function .....	186
5.6.4	Section Summary .....	186
5.7	Applications of Molecular Biology Approaches to Natural Products .....	187
5.7.1	Studying Interactions of Metabolic Pathways and Their Cross-Talk .....	187
5.7.2	Feedback Mechanisms and Bottlenecks in Pathways .....	187
5.7.3	Lignin Manipulation .....	189

5.7.4	Flavonoid Manipulation .....	190
5.7.5	Bioactive and Nutraceutical Compound Manipulation .....	191
5.7.6	Section Summary .....	191
5.8	Bioinformatics Resources for Metabolic Pathways.....	192
5.8.1	<i>Arabidopsis thaliana</i> Biochemical Pathways (AraCyc).....	192
5.8.2	Kyoto Encyclopedia of Genes and Genomes (KEGG).....	193
5.8.3	Dragon Plant Biology Explorer (DPBE).....	193
5.9	Conclusions .....	194
	References .....	195

---

## 5.1 Introduction

Traditionally, natural product research has been approached from a chemical point of view, where the primary goal is to identify the chemical structure of a specific compound. It is only relatively recently that the field of molecular biology has begun to take footing as a critical collection of techniques required for a broad understanding of the processes of natural product biosynthesis. Modern molecular techniques, such as high-throughput screens, more sensitive detection methods, and improved instrumentation for purification and structural elucidation, have paved the way for a better understanding of the plant **metabolome**, the totality of the metabolite complement of plants. Many metabolites and natural products isolated from higher plants and microorganisms have been studied for their roles in cellular biochemistry and physiology as well as for providing novel, clinically active drugs. Natural product discovery programs have, therefore, been a focal point, and research in this field has greatly increased due to the interest arising from the high chemical diversity found in plants. The structural diversity in secondary metabolites is enormous, and over 30,000 **terpenoids**, 12,000 **alkaloids**, 2500 **phenylpropanoids**, and 2500 other metabolites were described along with their structures (De Luca and St. Pierre, 1996). More details on the chemical diversity and the different natural products are included in Chapter 1.

Knowledge of molecular biology and genomes has become essential for a good understanding of the biology, chemistry, and application of metabolic pathways. The sum total of all genes constitutes the **genome** of an organism. Genes that play a role in metabolism can participate either directly by encoding primary as well as secondary metabolic enzymes or indirectly by regulating the enzyme-encoding genes. Genes involved in “secondary” metabolism give rise to a wide range of enzymes, which form a complex network of metabolic pathways. Hence, it is essential to understand the functioning of the genes and proteins involved in these pathways. With the advances in **genomics** (the study of the genome), description of the genes involved in metabolism is helping researchers obtain a nearly complete list of genes involved in the control, regulation, and function of complex metabolic processes. Such a complete list is one of the first steps toward understanding the interactions of the gene products and in eventually unraveling the interdependence of metabolic pathways.

Advances in genomics are useful in gaining knowledge about the function of genes and proteins on a genome-wide basis. This field, also known as **functional genomics**, allows researchers to better understand the coordination of complex pathways. In functional genomics, both experimental and computational approaches play an equally strong role. The experimental tools used in functional genomics include stocks of mutants for genetic studies, gene microarrays, and mass spectrometry for studying proteins and metabolites in cells and tissues. An integrated (systems) approach involving a combination of data from such platforms is often needed for efficient understanding and manipulation of the metabolic pathways. The data produced from such studies can be enormous, and it becomes imperative to use bioinformatics tools to relate these data to the genome function. In Chapter 6, we give an overview and define all of these concepts, including how they fit together in more integrated approaches.

This chapter focuses on the modern molecular biology of metabolic pathways in plants, briefly discussing specific examples with special reference to secondary metabolism. It also highlights some of the molecular tools that are useful in these studies, the applications of molecular biology techniques in understanding the cross-talk between pathways, protein–protein interactions, enzyme complexes, and

**TABLE 5.1**

List of Major Ongoing Plant Genome Projects

Alfalfa	Douglas fir	<i>Prunus</i>
Apple	Eucalyptus	Rice
<i>Arabidopsis</i>	Flax	Rye
Asparagus	Grape	Sesbania
Barley	Legumes	<i>Sorghum</i>
Bean	Lettuce	Soybean
Blueberry	Maize	Spinach
<i>Brassica</i>	Mungbean	Strawberry
Cabbage	Oats	Sugarcane
Carrot	Onion	Sunflower
<i>Chlamydomonas</i>	Pea	Sweet potato
<i>Chrysanthemum</i>	Peach	Sweetclover
<i>Citrus</i>	Peanut	Tobacco
Cotton	Pepper	Tomato
Cucumber	<i>Petunia</i>	Wheat
<i>Cuphea</i>	Pine	Wild rice

Source: [www.nal.usda.gov/pgdic/Probe/v4n3\\_4/pgtab3.html](http://www.nal.usda.gov/pgdic/Probe/v4n3_4/pgtab3.html); [www.ncbi.nlm.nih.gov/genomes/PLANTS/PlantList.html#SEQ](http://www.ncbi.nlm.nih.gov/genomes/PLANTS/PlantList.html#SEQ).

metabolic engineering. Additionally, this chapter highlights the bioinformatics resources available for the study of metabolic pathways.

## 5.2 Genes Involved in the Biosynthetic Pathways of Plants

Approximately 20,000 to 50,000 genes have been attributed to the metabolite diversity in plants. It is predicted that this figure will go up to or even exceed 200,000 genes, when considering all plant species (Hall et al., 2002). In the three plant genomes completed so far, namely, *Arabidopsis thaliana*, rice (*Oryza sativa*), and poplar trees (*Populus trichocarpa*), the largest category of genes is involved in metabolism. In the *A. thaliana* genomes, the number of metabolism genes stands close to 4000, comprising nearly 25% of the genome (*Arabidopsis* genome initiative, 2000). Although we provide several examples from *Arabidopsis*, the rice and poplar tree genomes carry a similar trend in most respects, and readers are directed to some of the resource sites provided in the appendix of this book for further details.

Large-scale sequencing projects are also underway for many crop plants. Table 5.1 lists most of the major ongoing efforts of genome sequencing. Due to impediments like large genome size, the ploidy of the genome, and the funding required, large-scale sequencing projects are difficult to initiate, and only partial sequence information is available for many of these genomes. Some of the complete organelle genomes, like those of chloroplast and mitochondrion, were also sequenced for some plants. For example, chloroplast genomes of *Saccharum officinarum* (sugarcane), *Nymphaea alba* (white water lily), and *Atropa belladonna* (belladonna), and mitochondrial genomes of *Nicotiana tabacum* (tobacco) and *Brassica napus* (rapeseed) are available. In addition to the genome sequence information, maps of genes and molecular markers are available for a larger number of plants. Some of these maps are also available through the Web sites provided in Table 5.1.

Genes encoding a variety of biosynthetic enzymes were also isolated and studied. A partial list is given in Table 5.2 to provide an appreciation for the vast coverage of the pathways (see also Table 3.6 in Chapter 3 for an example of genes cloned in the isoprenoid pathway).

Although genome sequencing is now advancing at a fast pace, our understanding of the biochemistry of the gene products is still quite poor. For example, in the case of the completed genomes of *Arabidopsis* and rice, not all of the genes have been functionally characterized. Nearly 25% of genes in the fully sequenced and annotated *Arabidopsis* genome have structures that are predicted by computer algorithms



TABLE 5.2

Some Recently Studied Biosynthetic Genes

Biosynthetic Pathway	Genes Studied	Ref.
Anthocyanin biosynthesis	Flavanone 3-hydroxylase (F3H) Dihydroflavonol reductase (DFR) Anthocyanidin synthase (ANS) Chalcone synthase (CHS)	Kim and Walbot, 2003; Farzad et al., 2003; Honda et al., 2002
Phenylpropanoid pathway	UDP glucose: flavonoid 3- <i>O</i> -glucosyltransferase Hydroxycinnamoyl-coenzyme A shikimate/quinatase Hydroxycinnamoyltransferase Phenylalanine ammonia lyase and peroxidases Cinnamate 4-hydroxylase 4-coumarate: coenzyme A ligase	Hoffmann et al., 2004; Gomez-Vasquez et al., 2004; Ro et al., 2001; Cukovic et al., 2001
Alkaloid biosynthesis	( <i>S</i> )- <i>N</i> -methylcoclaurine 3'-hydroxylase Berberine bridge enzyme (BBE) Codeinone reductase (COR) TaBx2-TaBx5	Huang and Kutchan, 2000 Nomura et al., 2003
Benzoxazinones biosynthesis		
Carotenoid biosynthesis	Crocus zeaxanthin 7,8(7',8')-cleavage dioxygenase gene ( <i>CsZCD</i> ) Crocus carotenoid 9,10(9',10')-cleavage dioxygenase gene ( <i>CsCCD</i> ) Phytoene synthase (CitPSY) Phytoene desaturase (CitPDS) $\zeta$ -Carotene ( <i>car</i> ) desaturase (CitZDS) Carotenoid isomerase (CitCRTISO) Lycopene $\beta$ -cyclase (CitLCYb) $\beta$ -Ring hydroxylase (CitHYb)	Bouvier et al., 2003; Kato et al., 2004
Methylbenzoate biosynthesis	<i>S</i> -adenosyl-L-methionine:benzoic acid carboxyl methyltransferase (BAMT)	Kolosova et al., 2001
Biosynthesis of stilbenes	Resveratrol synthase gene ( <i>VstI</i> )	Grimmig et al., 2002
Brassinosteroid biosynthesis	BR-6-oxidase (BR6ox2) gene	Shimada et al., 2003
Sinapate ester biosynthesis	Ferulate 5 hydroxylase	Reugger et al., 1999
Sesquiterpenes biosynthesis	Terpene synthase1 ( <i>tps1</i> )	Schnee et al., 2002
Tocopherol biosynthesis	Tocopherol cyclases	Sattler et al., 2003
Camptothecin biosynthesis	Strictosidine synthase (OpSTR)	Yamazaki et al., 2002
Taxol biosynthesis	Taxadiene synthase Taxadien-5 $\alpha$ -ol- <i>O</i> -acetyltransferase Taxadien-5 $\alpha$ -yl acetate 10 $\beta$ -hydroxylase, 10-deacetylbaicatin III-10 $\beta$ - <i>O</i> -acetyltransferase Taxane 2 $\alpha$ - <i>O</i> -benzoyltransferase	Walker and Croteau, 2001
Benzylisoquinoline alkaloid biosynthesis	( <i>S</i> )-norcoclaurine-6- <i>O</i> -methyltransferase (6OMT) ( <i>S</i> )-3'-hydroxy- <i>N</i> -methylcoclaurine-4'- <i>O</i> -methyltransferase (4'OMT), ( <i>S</i> )-coclaurine <i>N</i> -methyltransferase (CNMT)	Facchini and Park, 2003
Tropane and pyridine-type alkaloids	Putrescine: SAM <i>N</i> -methyltransferase (PMT)	Moyano et al., 2004
Glucosinolate biosynthesis	Tandem 2-oxoglutarate-dependent dioxygenases 2-( $\omega$ -methylthioalkyl) malate synthase	Kliebenstein et al., 2001; Falk et al., 2004
Lignin biosynthesis	Cinnamoyl-CoA reductase (CCR) Caffeic/5-hydroxy ferulic acid- <i>O</i> -methyltransferase I and cinnamoyl-coenzyme A reductase Caffeoyl-coenzyme A (CoA) <i>O</i> -methyltransferase (CCoAOMT) Caffeoyl-coenzyme A 3- <i>O</i> -methyltransferase (CCoAOMT)	McInnes et al., 2002; Pincon et al., 2001; Meyermans et al., 2000
Ginkgolide biosynthesis	Levopimaradiene synthase	Schepmann et al., 2001

with no support from either nucleic acid or protein homologs from other species or expressed sequence matches from *Arabidopsis* (Xiao et al., 2002). Some of these hypothetical genes were tested and found to be represented in cDNA preparations, while others are yet to be analyzed. Studies on plant natural products and metabolic pathways will, therefore, improve our understanding of genome function.

---

### 5.3 Families of Metabolic Genes and Enzymes

Metabolic pathways in different plant species often possess several conserved features and employ a conserved set of biochemical reactions. Genome sequencing and studies of genes involved in metabolism are valuable tools for understanding the relatedness of genes within and among different plant species. Comparison of genes from various species shows that many biosynthetic genes occur in families or groups of related sequences. For example, in *Arabidopsis* alone, a large gene family, with an estimated 70 members, encodes enzymes for **acyl transferases** involved in the synthesis of various scent, pigment, and defense compounds (Pichersky and Gang, 2000). In the *Arabidopsis* genome, 60 genes for **glycosyl transferases** can be found, most of which are probably involved in protein glycosylation or metabolite catabolism. Another example of multigene families are the **cytochrome P450s**, involved in the synthesis of a wide array of plant products, such as **phenylpropanoids**, **alkaloids**, **terpenoids**, **lipids**, **cyanogenic glycosides**, and **glucosinolates**, and plant growth regulators, such as **gibberellins**, **jasmonic acid**, and **brassinosteroids**. These gene families are involved in multiple functions and form the backbone of metabolic pathways. They govern the regulation of different pathways and highlight the importance of cross-talk among the different pathways.

#### 5.3.1 Gene Families and Their Evolution

The presence of gene families is a result of evolutionary conservation of gene functions. This evolutionary aspect of the biosynthetic genes has attracted much attention, as it provides insight into the processes that lead to the formation of novel metabolic products, such as diverse groups of secondary metabolites. An understanding of this process also accounts for some of the differences in gene functions among the various plant genomes. In secondary metabolism, repeated evolution appears to be common (Pichersky and Gang, 2000). **Repeated evolution** is a special form of convergent evolution in which new genes with the same function evolve independently in separate plant lineages from a shared pool of related enzymes with similar but not identical functions. Genes for secondary metabolism may, in turn, be derived from the genes of primary metabolism by **gene duplication** and divergence or by allelic divergence. In the *Arabidopsis* genome, nearly 70% of the genome seems to be comprised of duplicated sequences (Walbot, 2000). An example of evolutionary divergence following gene duplication is the  **$\beta$ -amyrin synthase gene**, *AsbAS1*, in graminaceous plants (Qi et al., 2004). This gene seems to have arisen by duplication and divergence of a **cycloartenol-synthase**-like gene, and its properties have been changed since the divergence of oats (*Avena sativa*) and wheat (*Triticum* spp.). The biosynthetic genes for **benzoxazinones** production also seem to have been rearranged during the evolution of Triticeae species (Nomura et al., 2003). A similar theme is also seen in two genes in the **glucosinolate biosynthetic pathway**. Genes encoding two oxoglutarate-dependent dioxygenases, *AOP2* and *AOP3*, map to the same position on chromosome 4 in *Arabidopsis* and result from apparent gene duplication. *AOP2* enzyme catalyzes the conversion of methylsulfinylalkyl glucosinolates to alkenyl glucosinolates, whereas the *AOP3* enzyme catalyzes the formation of hydroxyalkyl glucosinolates (Kliebenstein et al., 2001).

**Domain swapping** also appears to play a role in the evolution of new genes. In this process, different functional domains of different genes become linked together. If the resulting combination finds use in the organism with such a mutation, then the “new” gene can be passed on to the offspring. For example, plant **terpene synthases** constitute a group of evolutionarily related enzymes. Investigation of the structure of the gene encoding **linalool synthase (LIS)**, an enzyme that uses **geranyl pyrophosphate** as a substrate and catalyzes the formation of **linalool**, revealed that only the region encoding roughly the last half of the *LIS* gene has a gene structure similar to that of many other terpenoid synthase genes (Cseke et al., 1998). On the other hand, in the first part of the *LIS* gene, *LIS* gene structure is essentially

identical to that found in the first half of the gene encoding **copalyl diphosphate synthase (CPS)**. Thus, *LIS* appears to be a composite gene that might have evolved from a recombination event between two different types of terpene synthases. (See Chapter 2 for more information on linalool synthase.) The combined evolutionary mechanisms of duplication followed by divergence or domain swapping may explain the extraordinarily large diversity of proteins found in the plant terpene synthase family.

In the following sections, we will discuss three major gene families involved in plant metabolic pathways, namely, **cytochrome P450s**, **acyl transferases**, and **glycosyl transferases** and their roles in secondary metabolism in plants.

### 5.3.2 Cytochrome P450 Genes

**Cytochrome P450 enzymes** belong to a superfamily of heme-thiolate proteins, which are found in all living organisms. These enzymes form the terminal oxidases in a multi-component electron-transfer chain known as the **P450 monooxygenase system**. These enzymes are involved in the biotransformation of a diverse range of **xenobiotics** (chemical substances that are foreign to the biological system) and **endobiotics** (naturally occurring antibiotics). Human P450 isoforms, which are mainly expressed in the liver, play a central role in drug metabolism (see Chapter 11). In animals, xenobiotic detoxification and sterol biosynthesis are the major functions of P450s. However, P450-mediated reactions in plants encompass a much broader spectrum, including biosynthesis of plant hormones and signal molecules, biosynthesis of primary metabolites necessary for growth and development, defense-related chemicals, natural products, and herbicide detoxification (Feldmann, 2001).

The *Arabidopsis* genome, for example, encodes at least 273 P450 genes ([www.p450.kvl.dk/](http://www.p450.kvl.dk/)), highlighting the important biochemical roles of P450-mediated reactions that have evolved in plants. Many techniques were used in the identification and characterization of these genes. Reverse-genetic protocols that use expedient pooling and hybridization strategies to identify individual transfer-DNA insertion lines were used to isolate *Arabidopsis* lines containing insertional mutations in individual cytochrome P450 genes. See Chapter 6 for more information on genetic approaches.

In the following sections, we will discuss the role of cytochrome P450s with reference to some of the secondary metabolic pathways, and also the role of cytochrome P450s in metabolic engineering. Cytochrome P450 enzymes are involved in diverse plant metabolic pathways, including biosynthesis of phenylpropanoids, glucosinolates, auxins, and tryptophans, as well as in the production of signaling molecules.

#### 5.3.2.1 Cytochrome P450s in the Phenylpropanoid Pathway

One of the important enzymes in the phenylpropanoid pathway, **ferulate-5-hydroxylase (F5H)**, is a cytochrome P450-dependent monooxygenase of the phenylpropanoid pathway. The *fah1* mutant of *Arabidopsis* is defective in the accumulation of **sinapic-acid**-derived metabolites, including the **guaiacyl-syringyl lignin** typical of angiosperms and the *FAH1* locus that encodes ferulate-5-hydroxylase (F5H). The sequence identity of this enzyme with previously sequenced P450s was only 34%. F5H is, therefore, classified under a new P450 subfamily that was designated **CYP84** (Meyer et al., 1996). **Hydroxylation** and **methoxylation** are important processes in the biosynthesis of secondary metabolites, and these processes are also catalyzed by cytochrome P450s. Cinnamate hydroxylase is an enzyme involved in the hydroxylation of 4-, 3-, and 5-positions of the aromatic ring, which converts **trans-cinnamic acid** to **p-coumaric acid**. This enzyme is one of the three enzymes originally proposed to catalyze such hydroxylations. This cinnamate hydroxylase enzyme is an archetypal plant P450 monooxygenase.

#### 5.3.2.2 Cytochrome P450s in Signaling

**Allene oxide synthase (AOS)** is a cytochrome P-450 (CYP74A) that catalyzes the first step in the conversion of **13-hydroperoxy linolenic acid** to **jasmonic acid** and related signaling molecules in plants. Molecular cloning and characterization led to the identification of a novel AOS-encoding cDNA (*LeAOS3*) from tomato. The predicted amino acid sequence of *LeAOS3* classifies it as a member of the CYP74C subfamily. The enzyme transforms 9- and 13-hydroperoxides of **linoleic acid** and **linolenic**

acid to  $\alpha$ -ketol,  $\gamma$ -ketol, and cyclopentenone compounds that arise from spontaneous hydrolysis of unstable allene oxides (Itoh et al., 2002).

### 5.3.2.3 Cytochrome P450s in Glucosinolate, Auxin, and Tryptophan Pathways

Cytochrome P450 enzymes of the CYP79 family catalyze the conversion of amino acids to oximes in the biosynthesis of glucosinolates. **Glucosinolates** are amino-acid-derived natural products that upon hydrolysis release **isothiocyanates**, which have many biological activities. Glucosinolates play an important role in plant defense as attractants and deterrents against herbivores and pathogens and are found throughout the Capparales order of plants. The different cytochrome P450s belonging to the CYP79 family are involved in the formation of various types of glucosinolates. The enzyme CYP79A1 catalyzes the conversion of **L-tyrosine** to **p-hydroxyphenylacetaldoxime**, the first step in the biosynthetic pathway of the **cyanogenic glucoside dhurrin** in *Sorghum bicolor* (sorghum) (Petersen et al., 2001). Leucine-derived **cyanoglucosides** in barley (*Hordeum vulgare*) are formed by the initial action of the CYP79 family converting **L-leucine** into **Z-3-methylbutanal oxime** and subsequent action of a less-specific CYP71E enzyme converting the oxime into **3-methylbutyronitrile** and mediating hydroxylations at the  $\alpha$ - as well as  $\beta$ - and  $\gamma$ -carbon atoms (Nielsen and Moller, 2000).

Some of the cytochrome P450 enzymes are more restricted to one biosynthetic pathway, as mentioned above, whereas others may be involved in the regulation of more than one pathway. Two cytochrome P450s, CYP83A1 and CYP83B1, from *Arabidopsis* are involved not only in oxime metabolism in the biosynthesis of glucosinolates, but also, in altering the auxin levels. An auxin-overproducing mutant *sur2* was identified within a transposon-mutagenized population. The *SUR2* gene was cloned and shown to encode the CYP83B1 protein, which was previously implicated in glucosinolate biosynthesis. Analysis of **indole-3-acetic acid (IAA)** synthesis and metabolism in *sur2* mutant plants indicates that the mutation causes a conditional increase in the pool size of IAA through upregulation of IAA synthesis (Barlier et al., 2000). *Arabidopsis* cytochrome P450 CYP83B1 mutations were also found to activate the tryptophan biosynthetic pathway. Cytochrome CYP83B1 mutants were characterized as having defects in IAA homeostasis due to perturbation of tryptophan secondary metabolism. This study indicates that the upregulation of tryptophan pathway genes might also contribute to the over-accumulation of IAA in mutant plants. CYP83B1 mutants were shown to have lesion-mimic phenotypes, suggesting that multiple stress pathways are activated by the loss of CYP83B1 function (Smolen and Bender, 2002). Study of such enzymes is, therefore, pivotal in providing deeper insight into secondary metabolic pathways and their cross-talk.

### 5.3.2.4 Cytochrome P450s and Metabolic Engineering

Plant cytochrome P450s are useful targets in **metabolic engineering**, as they catalyze extremely diverse reactions in biosynthesis or aid in catabolism of plant bioactive molecules. Engineered P450 expression is needed for low-cost production of antineoplastic drugs, such as **Taxol**<sup>®</sup> or **indole alkaloids**, and offers the possibility to increase the content of nutraceuticals, such as **phytoestrogens** and **antioxidants** in plants. Herbicides, pollutants, and other xenobiotics are metabolized by some plant P450 enzymes. Hence, they are potential tools to modify herbicide tolerance (Morant et al., 2003).

Insight into the metabolic networks helped in altering **glucosinolate** profiles to improve nutritional value and pest resistance. Targeted production of glucosinolates can be achieved by altering levels of endogenous CYP79s and by introducing exogenous CYP79s. High biosynthetic capacity of the postoxime enzymes combined with a low substrate-specificity of the postoxime enzymes in *A. thaliana* provide a highly flexible system for metabolic engineering of glucosinolate profiles, including new (non-endogenous) glucosinolates derived from oximes introduced into the plant, for example, by transformation with CYP79 homologues. For example, introduction of CYP79A1 into *Arabidopsis thaliana* results in the production of the tyrosine-derived glucosinolate **p-hydroxybenzylglucosinolate (p-OHBG)**, not found in wild-type *A. thaliana* (Bak et al., 1999). Another example is the expression of CYP79D2 from cassava (*Manihot esculenta* Crantz.) in *Arabidopsis*, which resulted in the production of valine- and isoleucine-derived glucosinolates not normally found in this plant (Mikkelsen et al., 2003).

**2-Hydroxyisoflavone synthase** (CYP93C) and the **indole-3-acetaldoxime N-hydroxylase** (CYP83B1) genes, which catalyze the formation of **isoflavones** and glucosinolates, respectively, are also important for generating crop protectants and natural medicinal products (Feldmann, 2001). Isothiocyanates produced from the valine- and isoleucine-derived glucosinolates are volatile. Metabolically engineered plants producing these glucosinolates have great potential for improving resistance to herbivorous insects and **biofumigation** (Mikkelsen and Halkier, 2003). These examples, therefore, demonstrate the importance of cytochrome P450s and how their manipulation can be used to engineer pathways of interest.

### 5.3.3 Acyl Transferases and Their Role in Secondary Metabolism

**Acyl transferases** are a group of enzymes that transfer an **acyl group (RCO-)** to molecules like carboxylate and phosphate, amines, thiols, and alcohols. They are involved in diverse pathways and play an important role in controlling metabolite levels. Four examples from the cysteine pathway, anthocyanin pathway, alkaloid biosynthesis pathway, and regulation of the phenylpropanoid pathway are discussed here.

#### 5.3.3.1 Acyl Transferases in the Cysteine Pathway

**Serine acyltransferase** catalyzes the first step in the **cysteine pathway** and is one of the best studied of the acyltransferases. **L-Serine** is the amino acid precursor of **L-cysteine**, which is first acetylated at its  $\beta$ -hydroxyl by acetyl CoA to give **O-acetyl-L-serine (OAS)**. This reaction is catalyzed by the enzyme serine acetyltransferase. Serine acetyltransferase is regulated by feedback inhibition by the end-product, L-cysteine, which acts by binding to the serine residue in the active site, inducing a conformational change that prevents reactant binding (Johnson et al., 2005).

#### 5.3.3.2 Acyl Transferases in the Anthocyanin Pathway

**Anthocyanin 5-aromatic acyltransferase** catalyzes the transfer of the **p-coumaric acid** and **caffeic acid** from their CoA esters to the 5-glucosyl moiety of **anthocyanidin 3,5-diglucosides**. This acylation results in the anthocyanin becoming bluer and more stable. The expression of this gene was found to be coordinately expressed along with the anthocyanin biosynthetic genes. This transferase was studied from *Gentiana triflora* (Gentian) (Fujiwara et al., 1997). Another acyltransferase, **hydroxycinnamoyl-CoA: anthocyanin 3-O-glucoside-6-O-acyltransferase (3AT)** was also identified from *Perilla frutescens* (wild basil) (Yonekura-Sakakibara et al., 2000). These acyltransferases contribute to the variations in the flower color by the addition of acyl groups to anthocyanins.

#### 5.3.3.3 Acyl Transferases in the Alkaloid Pathway

Alkaloid acyl transferases belong to a unique subfamily of a plant acyl-CoA-dependent acyltransferase gene family. An acyltransferase from *Lupinus albus* is involved in the final step in **quinolizidine alkaloid** biosynthesis. It is called **tigloyl-CoA:(-)-13 $\alpha$ -hydroxymultiflorine/(+)-13 $\alpha$ -hydroxylupanine O-tigloyltransferase**. It catalyzes the acyl-transfer reaction from **tigloyl-CoA** to **(-)-13 $\alpha$ -hydroxymultiflorine** and **(+)-13 $\alpha$ -hydroxylupanine**. **Benzoyl-CoA** serves as an acyl donor for these hydroxylated alkaloids (Okada et al., 2005). Another acyl transferase cDNA was recently cloned from *Taxus chinensis*, which is involved in the Taxol biosynthetic pathway (Tu et al., 2004) (see also Section 6.2.3 in Chapter 6).

#### 5.3.3.4 Acyl Transferases in the Regulation of Phenylpropanoids

Acyl transferases are not only responsible for biosynthetic activity, but they also play a role in regulation of biosynthetic genes by **differential expression**. One example is the differential production of metastable phenylpropanoids in sweet basil (Gang et al., 2002). The **hydroxycinnamoyl acyltransferases** in sweet basil transfers a *p*-coumaroyl group to hydroxyl functional groups on either **shikimic acid** or **4-hydroxyphenyllactic acid**. Two acyltransferases, ***p*-coumaroyl-CoA:shikimic acid *p*-coumaroyltransferase (CST)** and a ***p*-coumaroyl-CoA:4-hydroxyphenyllactic acid *p*-coumaroyl transferase (CPLT)** were identified in sweet basil. These enzymes, CST and CPLT, are specific for their substrates and are expressed differentially in basil tissues. CST activity is much higher in tissues that are actively producing **eugenol** (i.e., in the **petate glands** of basil lines producing eugenol) than in tissues that are not, and CPLT

activity is higher in whole leaf tissue than in peltate glands. Hence, acyl transferases are involved in diverse pathways and play an important role in controlling the metabolite levels.

### 5.3.4 Glycosyltransferases and Their Role in Secondary Metabolism

Glycosylation of natural products is one of the key mechanisms that plants utilize in order to maintain **metabolic homeostasis**. **Glycosylation** is the addition of carbohydrate moieties to organic molecules. The addition of such moieties results in a wide range of effects, including increased water solubility, improved chemical stability, and altered biological activity. Secondary metabolites are glycosylated by enzymes known as **glycosyltransferases**. These enzymes use nucleotide-activated sugars as substrates. Many glycosylated products were identified, including 5000 different flavonoids, including 300 glycosides of **quercetin**, a flavonol (Vogt and Jones, 2000).

Glycosyltransferases play a very important role in regulating the activity of other enzymes by controlling their exit from the cytosol. Glycosylation and **deglycosylation** can be a regulatory mechanism altering the levels of metabolites. The addition of a sugar residue onto an **aglycone** (non-sugar component of a glycoside molecule) can lead to a change in bioactivity and a change in its cellular location. If the compound is hydrophobic and can diffuse across lipid bilayers, glycosylation of the aglycone can make it more hydrophilic, retaining the glycoside of the molecule in specific compartments, like the **vacuole** and other cell organelles, or extracellularly in the **cell-wall matrix**. The importance of glycosylation in the stabilization of secondary metabolites is particularly evident with the **glucosinolates** and **cyanogenic glycosides**. In these cases, the attachment of a glucose moiety is an absolute requirement for stability and prevents spontaneous degradation to **cyanide**, **aldehydes**, or **isothiocyanates**. Therefore, glycosylation enables the storage of potent toxic and aggressive chemicals in high concentrations within compartments, which are later released toward a putative pathogen or herbivore upon deglycosylation. Thus, glucosylation plays a crucial role in the maintenance of cellular homeostasis in plants through regulating the level, activity, and location of key cellular metabolites, and glycosyltransferases might, in fact, have an important role in plant defense and stress tolerance.

As mentioned above, glycosyltransferases require nucleotide-based activation of sugars to serve as substrates for transfer. Some of the glycosyltransferases require nucleotide cofactors like **uridine diphosphate (UDP)** to get activated. Uridine diphosphate (UDP) glycosyltransferases (UGTs) mediate the transfer of glycosyl residues from activated **nucleotide sugars** to acceptor molecules (aglycones), thus regulating properties of the acceptors, such as their bioactivity, solubility, and transport within the cell and throughout the organism. A superfamily of more than 100 genes encoding UGTs, each containing a 42-amino-acid consensus sequence, was identified in *Arabidopsis*. At this time, very little is known about the regulation of plant UGT genes or the localization of the enzymes they encode at the cellular and subcellular levels (Lim and Bowles, 2004).

Glycosyltransferases involved in the lignin biosynthetic pathway are discussed in Section 5.7.3.

### 5.3.5 Section Summary

Knowledge of gene families is very useful in translating information gained from model species to the non-model medicinal plants. Basic gene discoveries can be done in one species and related genes obtained from other species using a variety of molecular biology techniques, as described later in this chapter. The metabolic levels in each pathway are governed not only by the presence of the genes or gene families, but also, by the transcriptional rate of the gene and post-transcriptional modifications. Hence, gene expression and gene regulation play a primary role in the natural product synthesis pathways. The following section describes gene expression analysis and gene regulatory factors.

---

## 5.4 Expression of Metabolism Genes

The study of RNA levels (or the amount of specific transcripts present) provides direct insight into gene expression and regulation within any given tissue. However, parallel analyses of RNA and proteins are

often central to the modern functional genomic initiatives, allowing correlations to be made at the different levels of gene expression. Experimental validation of the expression of selected genes is also critical in testing the relationships between pathways, as suggested by the functional genomics approaches. Gene expression can be studied for single genes, small sets of gene families, or for the whole genome, and the expression of even rare transcripts can be studied by amplifying the mRNA of the selected gene. Such expression can also be studied in a qualitative or quantitative way. This is described in Section 5.6.2.

RNA expression of single genes can be studied using techniques such as **Northern blot analysis** or **reverse-transcription polymerase chain reaction (RT-PCR)** technology, which make use of electrophoresis separation techniques (described in Chapter 8). An example is the terpene synthase genes involved in the biosynthesis of **floral volatiles**, which could be identified by tissue-specific mRNA analysis (Chen et al., 2003). Quantitative gene expression studies can be done using techniques such as real-time polymerase chain reaction (PCR) or competitive PCR. For example, analysis of the variable pattern of expression of chalcone synthase (CHS) genes in different tissues after **tissue-specific gene silencing** was studied using quantitative amplification of mRNA (Tuteja et al., 2004). In addition, genome-wide expression analysis can be carried out using expression profiling or gene microarray techniques. Using this method, it is possible to analyze the differential expression of the different genes under varying conditions. The above-mentioned techniques are described in Section 5.6 in more detail.

### 5.4.1 Gene Regulation

**Gene regulation** can occur at various levels in the genome. The regulation can be at the transcriptional level (involving the production of RNA from DNA) or the post-transcriptional level (involving the stability of mRNA or production of proteins). In addition, there are a variety of regulatory mechanisms that involve the stability and localization of specific proteins as well as post-translational modifications that give each protein its final function. These topics are covered in Chapter 3; however, the mechanisms of gene regulation are extremely diverse and complicated. To cover all such topics goes far beyond the scope of this book. So, we will look at just a few specific examples here.

#### 5.4.1.1 Transcriptional Regulation

**Transcription** is the initial step at which genes are selected for expression and for modulation of the levels of expression. The expression of a gene at the RNA level is dependent on the transcriptional rate of the gene. The transcriptional rate is dependent on a number of factors, including the “*cis*” and the “*trans*” factors. The *cis* factors include the DNA sequence, whereas the *trans* factors include other proteins that bind to strategic points on the DNA sequence to either enhance or inhibit transcription. The *cis* factors can include **enhancer regions, silencer regions, promoters, TATA box, CAAT box, and GC box**. The *trans* factors include **transcription factors, negative inhibitors, and positive regulators**.

##### 5.4.1.1.1 Gene Regulation and Cis Factors

Gene regulation can occur at the promoter level, or expression can even be controlled by the **untranslated regions (UTRs)** in the gene. Gene regulation by the promoter regions is very important, especially in the case of metabolic engineering, as they govern the metabolism genes involved in the production of economically important metabolites. Hence, promoter sequences have been cloned and characterized so as to understand the regulatory mechanisms and to analyze the influence of environmental factors in gene expression. For example, the control of expression of the **leucoanthocyanidin dioxygenase (LDOX)** gene was studied in grapes. LDOX is an enzyme that converts leucoanthocyanidins to anthocyanidins in the anthocyanin pathway. The promoter of the *ldox* gene was cloned and expressed in all plant organs. This cloning made it possible to show that the gene was induced by calcium and sucrose in the presence of light, and that the ultraviolet (UV) receptor signal transduction pathway may be involved in the induction of the *ldox* gene (Gollop et al., 2001).

#### 5.4.1.1.2 Gene Regulation and Trans Factors

Here we discuss some of the best-known transcriptional factors that are instrumental in gene regulation, with special reference to the *myb* transcription factors and their role in metabolic engineering. Similar to the discussion in Section 5.3, **multigene families** encode transcription factors, with members either dispersed in the genome or clustered on the same chromosome. **Transcription factors** are products of regulatory genes within the genome. Transcription factors were isolated and characterized for many plant metabolic pathways. Some of these transcription factors include TFIIIA, WD-40, WRKY, MADS, MYB, and bHLH (MYC) families. (Chapter 3 includes a description of MADS-box transcription factors.) Here, we discuss transcription factors that are involved in secondary metabolism, using examples from the flavonoid and the terpenoid indole pathways.

In various plant species, it was shown that tissue-specific regulation of the structural genes involved in **anthocyanin biosynthesis** is directly controlled by a combination of two distinct transcription factor families with homology to the protein encoded by the vertebrate proto-oncogene *c-MYB*, and the vertebrate basic helix–loop–helix (bHLH) protein encoded by the proto-oncogene *c-MYC*, respectively. Most plant MYB proteins contain two related helix–turn–helix motifs, the R2 and R3 repeats responsible for binding to target DNA sequences. For example, the *Arabidopsis TT2* gene is a basic helix–loop–helix domain transcription factor with an R2R3 MYB domain protein with similarity to the rice *OsMYB3* protein and the maize *COLORLESS1* factor (Nesi et al., 2001).

Specific MYB family members are involved in the regulation of the flavonoid pathway in combination with specific bHLH protein partners. MYB and bHLH proteins were found to physically interact with each other. MYB/bHLH proteins were mainly studied in *Petunia*, snapdragon, and maize as regulators of anthocyanin biosynthesis, and more recently, in *Arabidopsis* as regulators of anthocyanin and seed coat tannin biosynthesis (Vom Endt et al., 2002).

In a recent example, the regulatory gene *OsCl-Myb* from rice (*Oryza sativa*) was shown to encode a MYB class of activators in the stress-induced expression of the structural genes, *OsDfr* and *OsAns*, which encode **dihydroflavonol reductase (DFR)** and **anthocyanidin synthase (ANS)** enzymes (Ithal and Reddy, 2004). The recombinant *OsCl-MYB* protein binds *in vitro* to the **MYB-responsive elements (MREs)** in the *OsDfr* and *OsAns* promoters, suggesting that it is a potential transcriptional activator of stress-induced structural genes in the flavonoid pathway. Another example of a basic helix–loop–helix (bHLH) regulatory gene is the maize *Leaf colour (Lc)* gene, which, when overexpressed in *Petunia*, enhances pigmentation through the upregulation of the flavonoid biosynthetic pathway genes (Bradley et al., 1998). This study suggests that there may be a divergence of the regulatory mechanisms in different dicots, and that a combination of introduced bHLH and MYB factors may be required to increase pigmentation in some plant species. However, some MYB transcription factors can have repressing transcriptional effects on genes involved in phenylpropanoid biosynthesis. *AmMYB308* and *AmMYB330* genes from snapdragon (*Antirrhinum majus*), when expressed in tobacco (*Nicotiana tabacum*), caused an inhibition of **hydroxycinnamic acid** and **monolignol** accumulation by reducing the expression of genes encoding the corresponding biosynthetic enzymes (Tamagnone et al., 1998).

Another transcription factor is KAP-2 protein that binds to the H-box in the bean *CHS15* chalcone synthase promoter and has sequence similarity to a large subunit of mammalian Ku autoantigen, a protein proposed to be involved in the control of DNA recombination and transcription (Lindsay et al., 2002). More details on other aspects of gene regulation are described in Chapter 3.

Recent genetic studies on the flavonoid biosynthetic pathway show that transcription factors are efficient molecular tools for plant metabolic engineering to increase the production of valuable compounds. The use of specific transcription factors can help to avoid the time-consuming step of acquiring knowledge about all the enzymatic steps of a poorly characterized biosynthetic pathway (Gantet and Memelink, 2002). However, because many transcription factors are able to bind other proteins, care must be taken to identify possible artifacts caused by nonspecific **protein–protein interactions** in tissues that do not normally express such factors. In any case, transcription factors that control either a whole biosynthetic pathway or a specialized branch of a pathway that synthesizes natural health-promoting molecules, such as flavonoids, can also be used to design functional foods or nutraceuticals. For example, the *Dofl* transcription factor was used to improve nitrogen assimilation in *Arabidopsis* (Yanagisawa et



al., 2004). Similar manipulations of secondary metabolic pathways can be useful in manipulating natural products. The applications of the different molecular biology techniques to understand the biosynthetic pathway and manipulate the production of natural products are described in Section 5.7.

#### 5.4.1.2 RNA-Based Post-Transcriptional Gene Regulation

Post-transcriptional regulation can occur at the level of RNA stability, via increases in efficiency, or via post-translational modifications. In this section, we give an overview of some of the factors controlling RNA-based posttranscriptional regulation. The study of such regulation is a relatively new field of research. It can be brought about by different RNA species, such as non-coding RNA (NcRNA), micro RNA (miRNA), small nucleolar RNA (snRNA), mRNA, and double-stranded RNA (dsRNA). While in some cases the mechanisms of these species of RNA are similar, there are some important differences that we briefly cover below.

1. **Non-coding RNAs** lack protein coding capacity. NcRNA is induced during **systemic acquired resistance (SAR)**. Hence, more involvement of ncRNAs in plant metabolism is likely to emerge in the coming years. About 15 putative *Arabidopsis* ncRNAs were reported in the literature or were annotated ([www.prl.msu.edu/PLANTncRNAs/nc.html](http://www.prl.msu.edu/PLANTncRNAs/nc.html)).
2. **Micro RNAs** are a subfamily of non-coding RNAs. These tiny RNAs act as small guides and direct **negative regulators**, such as those involved in the process of development, to target mRNAs through sequence complementarity. Once at the target mRNA, the negative regulator can perform its function. About 20 miRNAs were characterized from rice (*Oryza sativa*) (Wang et al., 2004). Under viral attack, the miRNA is thought to regulate both developmental genes as well as some metabolic genes. In addition, to test whether miRNAs play roles in the regulation of **wood development** in tree species, small RNAs were isolated from developing **xylem** of *Populus trichocarpa* stems, and 22 miRNAs were cloned (Lu et al., 2005). A majority of these miRNAs were predicted to target developmental- and stress/defense-related genes and possible functions associated with the biosynthesis of cell wall metabolites. Of the 21 *P. trichocarpa* miRNA families, 11 have sequence conservation in *Arabidopsis thaliana*, but exhibit species-specific developmental expression patterns. This suggests that even conserved miRNAs may have different regulatory roles in different species. Most unexpectedly, the remaining 10 miRNAs, for which 17 predicted targets were experimentally validated *in vivo*, are absent from the *Arabidopsis* genome, suggesting possible roles in tree-specific processes. Many of the miRNAs may still be undiscovered, and therefore, many functions of miRNA are still not understood.
3. **Small nucleolar RNAs** comprise another set of non-coding RNAs with their main function of rRNA modification. These RNAs provide ideal models for investigating the mechanism of evolution of genes (Brown et al., 2003). A large set of endogenous small RNAs of predominantly 21 to 24 nucleotides was identified in *Arabidopsis*. It is proposed that such small RNAs in *Arabidopsis* may participate in a wide range of post-transcriptional and epigenetic events (Llave et al., 2002).
4. Genetic control by **metabolite binding mRNA** is widespread in prokaryotes. This phenomenon is called **riboswitching**. These riboswitches are typically located in non-coding regions of mRNA, where they selectively bind their target compound, and subsequently, modulate gene expression. Similar riboswitches were found in *Arabidopsis* in the 3'-UTR of **thiamine** biosynthetic gene, where the RNA domain binds the corresponding coenzyme, as shown by *in vitro* experiments (Sudarsan et al., 2003). This result suggests that metabolite-binding mRNAs are possibly involved in eukaryotic gene regulation, and that some riboswitches might be representatives of an ancient form of genetic control.
5. The discovery that **double-stranded RNA (dsRNA)** is an extremely effective trigger of gene silencing has become one of the hot topics in the study of gene regulation. **Post-transcriptional gene silencing (PTGS)** is a natural gene-silencing mechanism that has become an effective method for studying gene expression and determining gene function through gene knockout studies. See Chapter 3 for background information. This technique is also referred to as **RNA interference** or **RNAi**. Gene silencing using RNAi and the PTGS is also described in Section 5.6.3.

## 5.5 Structure and Function of Enzymes Involved in Metabolism

Enzymes form an integral part of the biosynthetic pathway. Enzymes require specific conditions and substrates for their activity. Some of the enzymes and proteins were discussed in Chapters 2 and 3. This section highlights how structural elucidation has paved the way to understanding the activity of enzymes involved in metabolic reactions. We discuss here several examples of the structures of biosynthetic genes (examples from the phenylpropanoid pathway and the mevalonate pathway), methyltransferases, and terpene cyclases in relation to their function as well as enzyme complexes and protein interactions in phenylpropanoid metabolism.

### 5.5.1 Structures of Biosynthetic Enzymes

**Example 1: Phenylpropanoid Pathway** — Some of the structures of biosynthetic enzymes were already elucidated, which has provided knowledge on the substrate specificities and the conformational changes. Chalcone synthase (CHS) is one such enzyme with a structure that has been elucidated and studied (Ferrer et al., 1999). CHS is pivotal in the biosynthesis of flavonoid antimicrobial phytoalexins and anthocyanin pigments in plants. It produces chalcone by condensing one p-coumaryl- and three malonyl-coenzymeA thioesters into a polyketide reaction intermediate (see Chapter 2, Figure 2.21 for details). The crystal structure of CHS alone and the structure complexed with substrate and product analogs revealed the active site architecture and molecular understanding of the cyclization reaction leading to chalcone synthesis. The structure of CHS complexed with resveratrol also suggests how stilbene synthase, a related enzyme, uses the same substrates and an alternate cyclization pathway to form resveratrol (Jez et al., 2001). Later studies implicated side-chain position 256 to be the influencing position that determines the number of condensation reactions during polyketide chain extension and the conformation of the triketide and tetraketide intermediates during the cyclization reaction. Gly 256 residues on the surface of the CHS active site are in direct contact with the polyketide chain derived from malonyl-CoA. Another enzyme, chalcone isomerase (CHI), catalyzes the intramolecular cyclization of chalcone synthesized into (2S)-naringenin. The structure and mutational analysis of this enzyme suggest a mechanism in which shape complementarity of the binding cleft locks the substrate into a constrained conformation that allows the reaction to proceed with a second-order rate constant. The high-resolution crystal structure of CHI complexed with the products 7,4-dihydroxyflavanone, 7-hydroxyflavanone, and 4-hydroxyflavanone show that all 7-hydroxyflavanones share a common binding mode, whereas 4-hydroxyflavanone binds in an altered orientation at the active site (Jez and Noel, 2002).

**Example 2: Mevalonic Acid Pathway** — Study of **2-C-methyl-D-erythritol 2,4-cyclodiphosphate (MECDP) synthase** provided insight into the recognition of cations like  $Mn^{2+}$  for enzyme function. MECDP synthase catalyzes the conversion of 4-diphosphocytidyl-2-C-methyl-D-erythritol 2-phosphate (CDP-ME2P) to MECDP, which is a highly unusual cyclodiphosphate-containing intermediate on the mevalonate-independent pathway. The intermediate is then converted to isopentenyl diphosphate (IPP) and dimethylallyl diphosphate. Crystal structures of MECDP synthase in complex with  $Mn^{2+}$  cation, CMP, and MECDP revealed a homotrimeric quaternary structure built around a hydrophobic cavity and three externally facing active sites (Richard et al., 2002). The study identified the tetrahedrally arranged transition metal binding site, potentially occupied by  $Mn^{2+}$ , to be at the base of the active site cleft.

### 5.5.2 Methyl Transferases and Structure Elucidation

**Methyl transferases** form an important class of enzymes, as they are involved in diverse pathways in primary as well as secondary metabolism. These enzymes transfer methyl groups to various target substrates.

**Example 1: Chalcone *O*-methyltransferase (ChOMT) and isoflavone *O*-methyltransferase (IOMT)** are *S*-adenosyl-L-methionine (SAM)-dependent plant natural product methyltransferases involved in secondary metabolism and are the first plant methyltransferases to be structurally characterized. The crystal structures were deduced as complexes with their substrates and products: ChOMT in complex with the product *S*-adenosyl-L-homocysteine and substrate isoliquiritigenin and IOMT in complex with the products of *S*-adenosyl-L-homocysteine and isoformononetin (Zubieta et al., 2001). This study not only helps in understanding substrate specificities of these enzymes, but also, facilitates the engineering of novel activities in this class of natural product biosynthetic genes.

**Example 2:** One SAM-dependent methyltransferase from alfalfa is **caffeic acid/5-hydroxyferulic acid 3/5-*O*-methyltransferase (COMT)**, which is involved in **lignin biosynthesis**. COMT methylates caffeoyl- and 5-hydroxyferuloyl-containing acids, aldehydes, and alcohols. By analyzing the crystal structures of COMT in complex with *S*-adenosyl-L-homocysteine (SAH) and ferulic acid as well as in complex with SAH and 5-hydroxyconiferaldehyde, the residues lining the active site surface that contact the substrates could be identified (Zubieta et al., 2002). This study helped in structurally understanding the observed substrate preferences and gave a better understanding of the *in vivo* operation of the **monolignol biosynthetic pathway**.

### 5.5.3 Terpene Cyclases and Their Structures

**Terpene cyclases** are another class of enzymes that catalyze the synthesis of terpenes with 10-, 15-, and 20-carbon acyclic isoprenoid diphosphates as substrates. (See Chapters 1 and 2 for the structure and details of terpene biosynthesis.) These enzymes convert the acyclic isoprenoid diphosphates geranyl diphosphate (GPP, 10 carbon), farnesyl diphosphate (FPP, 15 carbon), and geranyl-geranyl diphosphate (GGPP, 20 carbon) into cyclic monoterpenes, sesquiterpenes, and diterpenes, respectively (see Chapter 3, Figure 3.10). TEAS (tobacco 5-epi-aristolochene synthase), a sesquiterpene cyclase from *Nicotiana tabacum* (tobacco), convert farnesyl diphosphate (FPP) to 5-epi-aristolochene. Crystal structures of 5-epiaristolochene synthase in separate complexes with two-farnesyl diphosphate were studied. This study revealed a mechanism for the enzymatic synthesis of the bicyclic product, 5-epi-aristolochene, and provided a basis for understanding the stereochemical selectivity displayed by other cyclases in the biosynthesis of pharmacologically important cyclic terpenes (Starks et al., 1997).

Such structural elucidations of the biosynthetic enzymes provide critical information that can be used to facilitate the engineering of novel activities in natural product biosynthetic enzymes in the future. These studies are also a starting point in the structure-based approach to metabolic engineering.

### 5.5.4 Enzyme Complexes and Protein Interactions in Phenylpropanoid Metabolism

It is seen that in living systems, the enzymes coded from genes often form macromolecular structures by **protein–protein interactions**. It is also seen that such interactions are often necessary for the proper functioning of these enzymes. The absence of any one of these enzymes may result in improper activity and drastically affect the pathway in which it acts. Similar protein–protein interactions were reported for metabolic pathways as well. One such example is of the **phenylpropanoid pathway** (see Chapter 2, Figure 2.19). The concept that the flavonoid, sinapate, and lignin pathways can be organized as enzyme complexes was first proposed by H.A. Stafford. Channeling, gel filtration, and cell fractionation studies were used earlier to indicate that **phenylalanine ammonia lyase (PAL)**, **cinnamate-4-hydroxylase (C4H)**, **chalcone synthase (CHS)**, and **UDP-glucose flavonoid glucosyltransferase** function as part of one or more membrane-associated enzyme complexes in *Amaryllis*, buckwheat (*Fagopyrum esculentum*), and red cabbage (*Brassica oleracea*). Further immunocytochemical studies indicated that CHS was located at the cytoplasmic face of the rough endoplasmic reticulum. This led to a model in which the phenylpropanoid and flavonoid pathways are organized as a linear array of enzymes loosely associated with the endoplasmic reticulum and anchored via the **cytochrome P450-dependent monooxygenases**, **cinnamate-4-hydroxylase**, and **F3H**. However, the apparent fragility of the enzyme interactions, and

the inability to isolate an intact complex from lysed plant cells, slowed efforts to further characterize this organization and to define its role in regulating phenylpropanoid and flavonoid biosynthesis.

It was hypothesized that the flavonoid enzymes assemble as a macromolecular complex with contacts between multiple proteins. To show protein–protein interactions, activation of the *His3* reporter by interactions between fusion proteins was assayed by screening for histidine prototrophy and 3-aminotriazole resistances. This assay revealed that CHS, CHI, and DFR interact with DFR, CHS, and CHI, respectively. Specific interactions among enzymes of flavonoid biosynthesis were demonstrated based on three criteria: (1) activation of multiple reporter genes in a yeast two-hybrid system; (2) extraction of flavonoid enzymes from crude plant protein extracts by CHS and CHI-affinity chromatography; and (3) co-immunoprecipitation of various flavonoid enzymes with an antibody specific for CHI. Affinity chromatography experiments suggested that flavonoid enzymes also interact with each other in plant cells (Burbulis and Winkel-Shirley, 1999).

Another type of protein–protein interaction was identified in *Arabidopsis*. It is suggested that at least three *TRANSPARENT TESTA* (*TT*) genes, TT8 (a helix–loop–helix domain protein), TTG1 (a WD-repeat [WDR] protein), and TT2 (an R2R3 MYB domain protein), may interact to regulate flavonoid metabolism in the seed coat (Nesi et al., 2000). Genetic analyses demonstrated that together with TTG1, TT2 and TT8 are necessary for the correct expression of *BANYULS* (*BAN*) (Baudry et al., 2004). This gene codes for the core enzyme of proanthocyanidin biosynthesis in *Arabidopsis thaliana* seed coat. The interplay of TT2, TT8, and their closest MYB/bHLH relatives, with TTG1 and the *BAN* promoter, was investigated using a combination of genetic and molecular approaches, both in yeast and in plants. The results obtained using glucocorticoid receptor fusion proteins in plants strongly suggest that TT2, TT8, and TTG1 can directly activate *BAN* expression. Experiments using yeast two- and three-hybrid experiments clearly demonstrated that TT2, TT8, and TTG1 form a stable ternary complex. Consistent with these results, the ectopic expression of TT2 was sufficient to trigger *BAN* activation in vegetative parts, but only where TTG1 was expressed. Taken together, these results indicate that TT2, TT8, and TTG1 can form a ternary complex directly regulating *BAN* expression in plants. Such ternary complexes are common in other forms for transcription factors. Some of the best examples come from the MADS-box class of transcription factors during their control of flower development (see Chapter 3).

---

## 5.6 Molecular Biology Tools Used in Natural Product Research

A variety of molecular biology tools are now available to study genomes. These include tools for gene identification, gene expression studies, and gene functional studies and gene silencing. Combinations of different techniques are often used to better understand genome function.

### 5.6.1 Techniques for Gene Identification

In molecular biological studies, the fundamental technique used to identify genes is **nucleic acid sequencing**. In this technique, the DNA of a specific gene is carefully isolated, cloned, and purified so that every nucleotide can be identified consecutively. (See Chapter 1 for details on the chemical structures of DNA, RNA, and the proteins derived from them.) This generates the sequence of nucleotides within the gene. This sequence can be used to search sequence databases, such as the NCBI integrated databases ([www.ncbi.nlm.nih.gov/gquery/gquery.fcgi](http://www.ncbi.nlm.nih.gov/gquery/gquery.fcgi)), to help identify the gene. With the creation of large databases of specific gene sequences from many plant species and the invention of equipment used for automated sequencing (see Chapter 8), many genes are currently being identified through large-scale genome-sequencing initiatives (see Chapter 6). The characterization of such genes is then performed through various gene expression and gene function studies (described in Sections 5.6.2 and 5.6.3).

Most researchers, however, are still interested in specific plant processes. The study of specific processes thus requires the identification of specific genes. The techniques used to isolate and clone specific DNA fragments are relatively straightforward and include various forms of the **polymerase chain reaction (PCR)** as well as **cDNA library** and **genomic library** screening (Cseke et al., 2004). The difficulty in identifying a specific gene is finding a way to narrow down the search within the huge amounts of

sequence obtained within the plant genome. This almost always requires the presence of a very clear and identifiable phenotype, which can be used as a marker to trace the trait to a specific region of DNA. Thus, the tools for gene identification include not only molecular techniques, but also physiological, biochemical, or analytical techniques. One method to identify new genes acting in the phenylpropanoid pathway in *Arabidopsis* is screening under UV for altered fluorescence phenotypes (Reugger et al., 1999). This type of screening was based on sinapoylmalate accumulation in cotyledons and leaves in *Arabidopsis*. Five new loci affecting the developmentally regulated accumulation of phenylpropanoid secondary metabolites and the cell specificity of their distribution were identified using this method of screening.

Analytical chemistry methods complement the molecular techniques in the study of biosynthetic genes. One of the strategies includes the study of mutant and transgenic plants by **metabolic profiling**. This includes the use of molecular methods to create a **mutant** (mutation in the targeted gene) and then using analytical methods to compare between the mutant and wild-type plants. This approach helps in discovering novel genes and ascribing functions to them. Silent plant phenotypes were studied using a combination of gas chromatography and time-of-flight mass spectroscopy techniques as well as various other forms of separation and analysis techniques (see Chapter 9). This is often followed by classical statistics and multivariate clustering (Weckwerth et al., 2004).

## 5.6.2 Tools to Study Gene Expression

There are many tools available to study gene expression. Gene expression can also be studied at several levels. The gene can be characterized within specific tissues (under specific conditions or at specific time points) in relation to the amount of RNA it produces, the amount of protein it produces, or the amount of final product it produces (Cseke et al., 2004). Traditionally, RNA-level studies are conducted using various **reverse-transcription polymerase chain reaction (RT-PCR)** techniques or **Northern blot analyses** (where RNA is blotted, and specific RNAs are detected using specific DNA probes); protein-level studies are conducted using **Western blot analysis** (where proteins are blotted, and specific proteins are detected with specific antibodies); and final product analysis is generally conducted using various forms of analytical chemistry approaches for the compound(s) of interest (see Chapters 8 and 9). It is also possible to study the expression of one gene at a time or to study many genes, and, in fact, even all the genes of the genome using techniques like microarray analysis. In this section, we highlight some of these techniques.

### 5.6.2.1 Qualitative Single-Gene Expression Analysis

Techniques such as **RT-PCR** allow biologists to rapidly study the expression of genes under varying conditions. In qualitative gene expression studies, only “yes” or “no” types of differences are identified. For example, gene activity can be determined in relation to whether a particular gene is expressed in a particular developmental stage or tissue in response to a particular physiological perturbation. The technique involves the isolation of total RNA, which includes the mRNA. The total RNA is then converted to single-stranded cDNA, using the enzyme **reverse transcriptase (RT)**. This single-stranded cDNA is then used as a template for the amplification of the target cDNA by use of the **polymerase chain reaction (PCR)** (Cseke et al., 2004). RT-PCR has been used to relatively quickly screen for the mRNA expression of **transgenes** (introduced genes) as well as to validate the expression of silenced or partially silenced genes (silenced using mutagenic methods). This technique is also useful in analyzing tissue-specific expression of biosynthetic genes. For detailed studies, however, this technique needs to be verified using quantitative techniques.

### 5.6.2.2 Quantitative Single-Gene Analysis

Polymerase chain reaction (PCR) techniques are useful, not only in qualitative analysis of mRNA, but also, in quantitative analysis, as mentioned earlier. Quantitative mRNA analysis techniques include **real-time PCR** and **competitive PCR**. In quantitative gene expression studies, data are obtained on relative or absolute levels of RNA under two or more conditions. Fold changes or number of molecules of RNA are quantified in this approach. Real-time PCR was used to study the expression profiles of endogenous

genes and multigene families. The real-time PCR technique is an extension of RT-PCR to quantitate the amount of mRNA produced. In this technique, instead of an end-product analysis of the PCR, the product is quantitated in “real time” and is plotted as a graph to show the products at the various intervals. The higher the abundance of target mRNA, the earlier the RT-PCR products are detected in the amplification cycles above the threshold values. Real-time PCR techniques were used to study the expression profiles of endogenous genes and multigene families. Competitive PCR techniques also involve real-time analysis. In this technique, a competitor internal standard is amplified along with the target DNA. The target is quantified from the melting curves of both the internal standard and target DNA.

As mentioned above, Northern blot analysis and Western blot analysis are traditionally used to characterize the expression patterns of genes of interest. These techniques are generally considered to be quantitative when performed with appropriate positive and negative controls. In **Northern blot analysis**, total RNA (or, in some cases, isolated mRNA) is blotted onto nylon or nitrocellulose membranes after separation by electrophoresis on agarose gels (see Chapter 8). Specific RNAs can then be detected on the membrane by hybridizing a specific DNA fragment (usually labeled with radioactivity) with a sequence that is complementary to that of the RNA of interest. When the membrane is then exposed to film, the relative amount of transcript can be determined in each sample by the intensity of the resulting bands. Likewise, in **Western blot analysis**, total proteins are immobilized onto a membrane after separation by electrophoresis on polyacrylamide gels (see Chapter 8). Specific protein(s) are detected with an antibody that was generated to be specific to the protein(s) of interest. The locations of these antibodies on the membrane are, in turn, detected using a secondary antibody (specific to the first) conjugated to an enzyme that generates either a colored product (visible on the membrane) or light (detected using film). These enzymes are usually alkaline phosphatase or horseradish peroxidase, and the relative amount of the protein to which they are bound can be determined by the intensity of the resulting band. Equipment such as the newer digital cameras and phosphoimagers come with software packages that accurately quantify light emissions or radioactivity.

These techniques are some of the most utilized for the characterization of differential gene expression in different plant tissues under differing conditions or at different time points. Likewise, gene expression through the characterization of final products may also be quantitative, utilizing a variety of analytical chemistry approaches for the separation and analysis of specific compounds (see Chapters 8 and 9). Such compounds may be the direct product of an enzymatic reaction (resulting in intermediates or end-products of biosynthetic pathways), or they may be the result of a regulatory effect on another gene.

### 5.6.2.3 Expressed Sequence Tags

One of the conventional methods used for gene identification and expression profiling is **expressed sequence tags (ESTs)**. Expressed sequence tags are small DNA sequences (usually 200 to 500 nucleotides long) that are generated by sequencing either one or both ends of an expressed gene. The idea is to sequence bits of DNA that represent genes expressed in certain cells, tissues, or organs from different organisms and use these “tags” to identify the respective genes from cDNA libraries or genome information. About 176,915 ESTs are available for the *Arabidopsis* genome (Zhu, Schlueter, and Brendel, 2003). Large-scale sequencing of ESTs is now under way for many plant species. Some of them include onion (*Allium cepa*), orange (*Citrus sinensis*), poplar (*Populus trichocarpa*), cotton (*Gossypium hirsutum*), coffee (*Coffea Arabica*), beet (*Beta vulgaris*), chickpea (*Cicer arietenum*), Chinese cabbage (*Brassica napus*), sunflower (*Helianthus annuum*), cassava (*Manihot esculenta*), barley (*Hordeum vulgare*), and potato (*Solanum tuberosum*).

An example of the utility of such ESTs in gene cloning is the use of an *Arabidopsis* EST, encoding CYP51 (**obtusifoliol-14-demethylase**, implicated in **plant sterol biosynthesis**), as a probe to isolate homologous sequences from *Nicotiana tabacum* (tobacco) cDNAs (Burger et al., 2003). Two types of cDNA clones were identified — Nt CYP51-1 and Nt CYP51-2. They shared 97% nucleotide sequence identity with each other and around 75% with other plant CYP51s. The function of the encoded enzyme was demonstrated in plants by manipulating the sterol biosynthetic pathway at the gene level. This example also shows the utility of ESTs in the genome era, where the complete genome sequence may be known for a model species such as *Arabidopsis* (see Chapter 6). In addition, physical clones such as ESTs are still useful and relevant in expanding to non-model plants such as tobacco.

#### 5.6.2.4 Gene Microarray

**Microarray** is a technique that helps to study gene expression at a whole genome level. This technique is different from the others in that it involves multiple gene expression analysis. This method is being increasingly used in recent years because it allows for the study of the expression of many genes in the same experiment. This technique involves the hybridization of total RNA to cDNA or oligonucleotide arrays that are spotted on a chip (a glass slide). The RNA is usually labeled using one of a variety of fluorescent dyes. Upon hybridization, the bound, labeled RNA is then detected with a scanning laser. The intensity of the spots relates to the expression of the target gene. The expression of the various genes under varying environmental conditions can be studied using such microarrays. It can also be used to identify differentially upregulated or downregulated genes when there is a chemical or genetic perturbation in a pathway. This technique is being used for gene expression studies in *Arabidopsis* in order to study primary and secondary metabolism responses to sugar accumulation (Lloyd and Zakhleniuk, 2004). The type of array that can be used also varies. The arrays can be **gene arrays**, **cDNA arrays**, or **oligonucleotide arrays**, which are currently more popular. This technique was also used for studying the phenylpropanoid pathway with special reference to the lignin pathway in *Medicago truncatula* (Barrel Medic) and *Medicago sativa* (alfalfa).

Similar “omics” approaches can be performed at the protein and metabolite production levels of gene expression. We take up these topics in Chapter 6. However, metabolic profiling and microarray data together provide a powerful tool for identifying gene function and regulatory networks, even in the absence of a combined proteomic approach. We recently reviewed the role of such integrated approaches in studying cellular processes (Bhalla et al., 2005).

### 5.6.3 Tools Used to Study Gene Function

Gene function can be studied by the use of **loss-of-function approaches** (loss of expression using mutational or gene-silencing approaches) or **gain-of-function approaches** (by expression of foreign genes). The loss-of-function approach to the study of gene function is widely adopted by the research community. Mutations in specific genes not only help in understanding the gene function, but also, are helpful in elucidating biochemical pathways.

#### 5.6.3.1 Loss-of-Function Approaches to Study Gene Function

**Gene knockout studies** are increasingly used in functional genomics. They are aimed at revealing the function of genes from sequenced genomes. Mutational approaches were one of the important ways to analyze the genes under consideration. Causing a gene to be non-functional provides information on the normal function(s) of this gene when it is active, because downregulation of the gene may give a different phenotype. Once the knockout is established, the mutant is compared with the wild-type plants for visible changes in the phenotypes. As described above, metabolic profiling of mutants and wild types helps to assign function(s) to the gene and to place them in appropriate pathways. The mutation that is induced may be either random or site-directed (Cseke et al., 2004). Various kits are commercially available for such studies. In earlier days, random mutations were most commonly used, wherein mutations are induced randomly in the genes, using UV radiation, chemicals, or transposons. The mutants are selected based on their phenotypes. But often, such mutations have deleterious developmental defects, and often, the mutants were unable to grow well due to mutations in other genes as well.

An alternative approach to create mutations at specific locations is now more frequently used. This is termed **site-directed mutagenesis** (Cseke et al., 2004). Using this technology, it is now possible to change a single amino acid in a protein sequence. Site-directed mutagenesis has been useful in the study of protein structure–function relationships, gene expression, and vector modification. PCR-based techniques are now also being used for the incorporation of the desired nucleotides in the DNA sequence encoding the protein. Recently, recombinant DNA technology paved the way to more advanced mutational strategies. Mutations in this case are first generated in cloned segments of DNA using chemical or enzymatic procedures. Consequently, the mutations are generated in very high frequencies and are

more systematic. However, it is currently not feasible to study such site-directed mutants in a whole plant context. At best, such site-directed mutants are expressed as transgenes in plants.

Mutations can be induced in the targeted gene by physical means, chemical means, or molecular means. The differences in the phenotypes of the plant are studied by means of bioassays or analytical approaches. In physical methods, the mutations are induced by the use of radiation, such as UV rays, gamma rays, and fast neutron bombardment. Researchers rarely use this method these days. The focus is currently on chemical and molecular methods. The chemical methods include the use of chemicals like ethyl methyl sulfonate (EMS) and diepoxybutane (DEB). Alternative means include molecular methods, like **insertional T-DNAs** or **transposon insertions** or **RNA interference (RNAi)**. These methods are discussed in detail in the following sections.

#### 5.6.3.1.1 Chemical Mutagenesis Methods

Chemical mutagenesis has had a tremendous impact on the application of molecular biology in higher plants. Chemical mutagens increase the frequency of some types of mutations. **Ethyl methyl sulfonate (EMS)** and **diepoxybutane (DEB)** are alkylating agents and are very commonly used mutagens. These two chemical mutagens produce DNA damage that induces **point mutations** (one base pair replaces another) or **insertion/deletion mutations** (one or more nucleotide pairs are inserted or deleted from DNA). These chemicals react directly with certain bases, especially G-rich regions, to form a variety of modified G residues, resulting most often in **depurination**. Some of these modified G residues have the property of inducing error-prone repair, although mispairing of the altered base might also be possible. This stimulation of error-prone repair allows all sorts of mutation types to occur as a result of these mutagens, although base substitutions are by far the most frequent. It also appears that alkylated bases can mispair during replication. In *Arabidopsis*, chemical mutagenesis has been useful in providing the mutant lines of *Arabidopsis* Columbia ecotype (Somerville and Browse, 1991), and in rice (*Oryza sativa*), glucosinolate-resistant varieties were produced by EMS mutagenesis (Sandhu et al., 2002).

DEB was recently used successfully to construct mutant rice populations at the **International Rice Research Institute (IRRI)** at Los Baños, Philippines. One such mutant is IR64, which is the most widely grown rice variety in Asia (Leung et al., 2003). This variety contains many useful agronomic characteristics, including wide adaptability, high yield potential, tolerance to multiple diseases and pests, and good eating quality. IRRI scientists produced a collection of 40,000 chemical (diepoxybutane and EMS) and irradiation (gamma ray and fast neutron) induced IR64 mutants. Such mutant libraries are of immense importance in searching for metabolic mutants. Another example is the *TRANSPARENT-TESTA (tt)*-series of *Arabidopsis* mutants, where EMS treatment was used for induction of mutations (Koornneef et al., 1982).

#### 5.6.3.1.2 Molecular Mutagenesis Methods

Molecular methods have recently gained importance over chemical mutagenesis methods. Molecular methods for mutagenesis of targeted genes include virus-mediated silencing, RNAi, T-DNA insertions, transposons, positional cloning, and sense- or antisense oligonucleotide gene silencing. Some of the above techniques are reviewed in the following sections.

**5.6.3.1.2.1 Transposon and T-DNA Insertions** — **Insertional mutagenesis** is a basic genetic tool that allows for rapid identification of the tagged genes responsible for a particular phenotype. Insertion of a large piece of DNA within the gene sequence is one of the methods that results in disabling the gene. These large insertions can be introduced using transposons. The appropriate usage of the word, **transposons**, for plants is **transposon elements**, as there are many forms of mobile DNA.

**Transposons** are sequences of DNA that can translocate to different positions within the genome of a single cell using a **cut-and-paste mechanism**. In the process, they cause mutations by virtue of insertions at the target locations. Transposons are especially useful tools in unraveling plant gene functions. The presence of the transposon provides a more straightforward means of identifying the locus that was mutated as compared to chemical mutagenesis methods. Sometimes the insertion of a transposon into a gene can disrupt that gene's function in a reversible manner. Transposase-mediated



excision of the transposon can then restore gene function. However, it can also create a frameshift of a small insertional deletion mutation during its excision from its previous location. This produces plants in which neighboring cells have different genotypes. This feature allows one to distinguish between gene products that must be present inside a cell in order to function (cell-autonomous) and genes that produce observable effects in cells other than those where the gene is expressed. This property can be used to isolate new mutant alleles or to perform local mutagenesis in a particular region of interest (Das and Martienssen, 1995). Transposon mutants were isolated from a number of plant species, including maize or corn (*Zea mays*), rice (*Oryza sativa*), and *Arabidopsis thaliana* (Yephremov and Saedler, 2000). The discoveries of **transposable elements** (“**jumping genes**”) by the late Nobel laureate geneticist, Barbara McClintock, were all made using their insertion in the genes involved in flavonoid, starch, and phlobaphene biosynthetic pathways in maize.

Knockout mutations by *Agrobacterium* T-DNA insertion mutagenesis are widely used to study the functions of plant genes. In this process, a high-efficiency T-DNA-mediated transformation process is set up. Individual insertional mutations are screened and further analyzed. To assess the efficiency of this genetic approach, a large collection of insertion mutants was created, and the PCR-amplified junctions of 1000 T-DNA insertions were sequenced. Their positions were then analyzed in the *Arabidopsis* genome (Szabados et al., 2002). Several public resources are available that provide pools or mutant libraries generated by T-DNA or transposons. Some of these are presented in Table 5.3.

Very often, there is a lot of variation among the different transformants obtained. It was proposed that transcript-level silencing accounts for such variation, and this form of RNA sensing is a genome surveillance mechanism (Schubert et al., 2004). One of the classical examples is shown by the work of Jorgensen et al. (1996), where the co-suppression phenotypes of chalcone synthase in *Petunia* were studied using single-copy and complex T-DNA sequences.

Apart from DNA insertions, introduction of RNA also acts as a powerful tool in creating knockouts. These methods are discussed in the next two sections.

**5.6.3.1.2.2 Sense and Antisense Expression Technologies** — The DNA strand, having the same sequence as the transcribed RNA, is known as the **sense** or **coding strand**. The DNA strand that serves as a template during transcription is known as the **antisense** or **non-coding strand**; its sequence is complementary to that of the transcribed RNA.

**Antisense technology** is a tool that is used for the inhibition of gene expression. The principle behind this form of gene inhibition is thought to be based on the antisense nucleic acid sequence base-pairing with its complementary sense RNA strand and preventing it from being translated into a protein. This is a relatively quick way to create an organism with a loss of expression of a target gene. The main considerations to produce transgenic plants carrying either sense or antisense constructs are the species to use, the transformation method, and the selectable marker.

Antisense RNA methods were used in addressing basic biology experiments and in industrial applications such as food biotechnology. One example in the latter category is that of the tomato (*Lycopersicon esculentum*), in which gene expression was reduced for **polygalacturonase (PG)**, an enzyme that breaks down **pectin**, which leads to the formation of softer fruits. In some landmark work, scientists at Calgene Inc. suppressed the expression of the gene encoding PG by introducing a gene encoding the antisense strand of the PG mRNA, thereby suppressing the translation of the enzyme. This was enough to save the tomatoes from rotting (Kimball, 2002). This mutation increased the shelf life of tomatoes, making them commercially important. The resultant product was called the **FLAVR SAVR™** tomato.

Sense mutations include the expression of sense sequences in cells. Sometimes it is seen that multiple copies of the same gene in up to 20% of the transgenic lines can lead to the suppression of its function. This is basically opposite to what is normally expected when over-expressing a gene. One of the early examples is that of the **chalcone synthase (CHS) gene**. CHS is one of the important genes in the biosynthetic pathway of anthocyanin production (see Chapters 2 and 3). The introduction of the sense CHS construct resulted in the suppression of coloring in the flowers of *Petunia*, giving a white flower phenotype. This process is called **co-suppression**, and the mechanism of gene silencing achieves a gene regulatory function in the phenylpropanoid pathway. The suppression was shown to be dependent on

TABLE 5.3

Resources of Mutant Libraries Generated by T-DNA, Transposons, or RNAi

Project	End Date	Project Goal	Current Status	Web Site
Amasino/ Wisc KO Sussman/	2004	Launchpad — 50,000 lines cre/lox, Ds (attack for tandem genes, cre/lox for deletions) TILLING chip T-DNA chip	50,000 lines created, not sequenced Future Begun	
Ecker GABI-Kat	2003 Initial 10/2003; extension (if granted) to 2007	130,000 T-DNA lines 120,000 T-DNA lines with flanking sequence 78,000 lines (70K T-DNA, 8K ZIGIA)	130,000 lines 102,000 done 78,000, not all FST-analyzed yet	www.biotech.wisc.edu/Arabidopsis/ http://signal.salk.edu/tabout.html www.mpiz-koeln.mpg.de/GABI-Kat/
FST (INRA-Versailles and URGV-Evry) AGRIKOLA-RNAi	June 2003 11/2002–11/2005	35,000 FSTs  (1) Make hairpin constructs for 20,000 to 25,000 genes in constitutive and inducible promoters (two collections); (2) 5000 of these used to make transgenic RNAi lines 27,000 Ds/Spm lines, expecting 5000 KOs 30,000 Ds gene-trap lines	30,000  None yet	http://flagdb-genoplante-info.infobiogen.fr/projects/fst/  www.agrikola.org/
UK-GARNet	July 2003		15,000 sequenced 24,000 made, 4000 sequenced	http://atfdb.cshl.org// http://atfdb.cshl.org//
UK-Transposon lines RIKEN	2004	5000 Activation trap lines 15,000 Transposon (Ac/Ds) lines 60,000 Activation trap lines	500 sequenced 10,000 collected, 10,000 sequenced 50,000 collected, 1000 sequenced	http://atfdb.cshl.org// http://pfgweb.gsc.riken.go.jp/ http://pfgweb.gsc.riken.go.jp/
CSHL TMRI	? Done	30,000 Ds gene/enhancer trap lines 100,000 T-DNA	~15,000 sequenced 100,000 collected, ~53,000 sequenced	http://atfdb.cshl.org// www.tmri.org

Source: Adapted from “The multinational coordinated *Arabidopsis thaliana* functional genomics project” ([http://arabidopsis.info/info/annualreports/masc\\_annual\\_june03.pdf](http://arabidopsis.info/info/annualreports/masc_annual_june03.pdf)).

the transgene promoter length (Jorgensen et al., 1996). However, the mechanism was later shown to share similarities with siRNA silencing mechanisms, described next.

**5.6.3.1.2.3 RNA Silencing Technology** — **Small interference RNA (siRNA)** is a recently developed and powerful genetic tool to study gene function. In the literature for animal studies, this is also called **RNAi (RNA interference)**, which refers to the introduction of homologous double-stranded RNA (dsRNA) to specifically target a gene's product, resulting in null or hypomorphic phenotypes. Transforming plants with virus or reporter gene constructs that produce dsRNAs efficiently triggers gene-specific silencing of expression. The dsRNA is cleaved into **siRNAs** (21 to 23 nucleotides) of both polarities. These act as guides, when combined with proteins in the silencing complex, to direct the RNA degradation machinery to the target RNAs. See Chapter 3 for more details. **Post-transcriptional gene silencing (PTGS)** in plants is the primary RNA-degradation mechanism that generates siRNAs. It is a naturally occurring phenomenon in plants and may be induced by transgenes or viral infection. It causes the degradation of RNAs with homology or complementarity to the transgene transcript or viral genome. PTGS can be induced efficiently in plants by the expression of **self-complementary hairpin (hp) RNA** (Miller et al., 2001).

An intriguing aspect of RNA silencing in plants is that it can be triggered locally and then spread, via a **mobile silencing signal**, throughout the plant. RNA silencing is thought to have evolved as a defense mechanism to suppress viral replication and transposon mobilization. However, additional functions involving the RNAi machinery were uncovered, including post-transcriptional regulation of endogenous genes and maintenance of structure and function of heterochromatin (Montgomery, 2004).

Usually, in gene knockout studies, a single gene is targeted. Recently, it was shown that multiple genes could be coordinately suppressed by **chimeric silencing**. Single chimeric constructs incorporating partial sense sequences for multiple genes to target suppression of two or three lignin biosynthetic genes were used (Abbott et al., 2002). This method has potential use in the study of biosynthetic genes, which are often coordinately expressed.

### **5.6.3.2 Gain-of-Function Approaches to Study Gene Function**

In addition to the transgenic loss-of-function techniques described above, **gain-of-function techniques** were also used to study gene function, and more importantly, to study relationships between pathways. Transgenic approaches include the introduction of a foreign gene (**transgene**) into another organism using molecular cloning and transformation techniques. This approach was used for increasing different kinds of commercially important natural products in plants by perturbing different pathways. Hence, it has become possible to obtain increased levels of secondary metabolites such as commercially important volatile oils and alkaloids. This technique is also being used for the production of human proteins and other protein-based therapeutic entities. Transgenic gain-of-function technology has great potential in the biopharmaceutical industry. Transgenic plants present a novel system for both production and oral delivery of vaccine antigens. Such techniques are cheaper and are now progressing toward human trials (Tacket, 2005). However, risks are involved if vaccine antigens are produced in plants used for human consumption. There could be serious allergic reactions in some individuals. Similarly, molecular farming techniques employed to produce **genetically modified (GM) plants** can have risks to humans, as detailed in Chapter 7.

## **5.6.4 Section Summary**

In this section, we described molecular biology tools and techniques that have been used in the study and identification of genes that are involved in biosynthetic pathways of secondary metabolites or that have potential application in natural product research. Additional approaches are described in Chapter 6, which explains different genomic techniques that help in the study of biosynthesis of natural products. Application of these techniques to genes involved in the biosynthetic pathways of secondary metabolites may prove useful in deciphering the functions of biosynthetic genes and may help in elucidating novel pathways for natural products.

## 5.7 Applications of Molecular Biology Approaches to Natural Products

Plants are one of the most economical and productive sources of biomass. They also present the advantages of lack of contamination with animal pathogens, relative ease of genetic manipulation, and the presence of eukaryotic protein modification machinery. Significant advances have been made concerning the biosynthesis, regulation, and genetic manipulation of plant natural products. A better understanding of the molecular biology of the enzymes involved in secondary metabolism — such as **glycosyltransferases**, **isomerases**, **synthases**, and other key enzymes, together with their regulation at transcriptional or post-transcriptional levels — is necessary in order to understand how to efficiently produce natural products.

### 5.7.1 Studying Interactions of Metabolic Pathways and Their Cross-Talk

One of the major applications of molecular biological studies is to address the nature of networks that control the metabolic and signaling pathways of natural products. **Molecular networks** guide the biochemistry of a living cell at multiple levels. Metabolic and signaling pathways are shaped by the network of interacting proteins. The production of these proteins, in turn, is controlled by the genetic regulatory network (Maslov and Sneppen, 2002). We briefly discuss here some examples covering a variety of pathways (see also Chapter 2 and Figure 2.1). Metabolic cross-talk between cytosolic and plastidial pathways of **isoprenoid biosynthesis** was studied (Bick and Lange, 2003). This study showed that membranes possess a unidirectional **proton symport system** for the export of specific isoprenoid intermediates involved in the metabolic cross-talk between cytosolic and plastidial pathways of isoprenoid biosynthesis. The role of ascorbate in metabolic cross-talk between redox-regulated pathways by contrasting the effects of high ascorbate and reduced thioredoxin was shown in *Arabidopsis* (Kiddle et al., 2003).

### 5.7.2 Feedback Mechanisms and Bottlenecks in Pathways

While we previously discussed the control of metabolic pathways via transcriptional and post-transcriptional mechanisms, many other levels of control occur widely at the biochemical level (see Chapter 3). Although biochemical methods have been classically used to study such effects, molecular biology tools currently provide an excellent additional approach to uncover and further study the feedback mechanisms and other biochemical-level controls in metabolic pathways of natural products. **Feedback inhibition** mechanisms in plants were studied in detail, especially in pathways associated with phenylpropanoid metabolism (see Chapter 3). Feedback mechanisms and metabolic control were described with the aid of metabolic mutants. Biosynthetic mutants are also useful for studying the effects of mutations on metabolite distribution as well gene regulation due to feedback regulation, for example, the albostrian mutant of barley (*Hordeum vulgare*) in the **tetrapyrrole biosynthetic pathway** (Yaronskaya et al., 2003). Such biosynthetic mutants are also useful in unraveling the main and branch pathways for synthesis of different **gibberellins** in plants and the fungus, *Gibberella fujikuroi*, that causes “foolish seedling disease” in rice (*Oryza sativa*) (Buchanan et al., 2000).

Another phenomenon distinct from feedback regulation is that of **co-suppression** and its effects on positive/negative feedback regulation. This effect is clearly shown for cosuppression of **limonene-3-hydroxylase** in peppermint. The phenomenon was shown to promote accumulation of limonene, the first committed intermediate of essential oil biosynthesis (Mahmoud et al., 2004). Limonene does not impose negative feedback on the synthase, and it does not, apparently, influence other enzymes of **monoterpene biosynthesis** in peppermint.

The **shikimic acid pathway** links metabolism of carbohydrates to biosynthesis of aromatic compounds (see Chapter 2). In microorganisms, the shikimate pathway is regulated by feedback inhibition and by repression of the first enzyme. In higher plants, no physiological feedback inhibitor was identified, suggesting that the pathway regulation may occur exclusively at the genetic level. This difference between

microorganisms and plants is reflected in the unusually large variation in the primary structures of the respective first enzymes (Herrmann and Weaver, 1999).

Feedback control in amino acid biosynthesis in the shikimate pathway was shown using transgenic tobacco (*Nicotiana tabacum*) (Guillet et al., 2000). This is shown by the substrate specificity of **tryptophan (Trp) decarboxylase (TDC)** for Trp and **tyrosine (Tyr) decarboxylase (TYDC)** for Tyr used to modify the *in vivo* pools of these amino acids. Expression of TDC and TYDC was shown to deplete the levels of Trp and Tyr, respectively, during seedling development. The creation of artificial metabolic sinks for Trp and Tyr also drastically affected the levels of **phenylalanine**, as well as those of the non-aromatic amino acids **methionine**, **valine**, and **leucine**. In addition, transgenic seedlings displayed a root-curling phenotype that directly correlated with the depletion of the Trp pool. Non-transformed control seedlings could be induced to display this phenotype after treatment with inhibitors of auxin translocation, such as **2,3,5-triiodobenzoic acid (TIBA)** or ***N*-1-naphthylphthalamic acid (NPA)**. The depletion of aromatic amino acids was also correlated with increases in the activities of the shikimate and phenylpropanoid pathways in older, light-treated transgenic seedlings expressing TDC, TYDC, or both. These results provide *in vivo* confirmation that aromatic amino acids exert regulatory feedback control over carbon flux through the shikimate pathway. They also affect pathways other than aromatic amino acid biosynthesis.

Plants have evolved highly efficient strategies to control **tetrapyrrole biosynthesis** (see Chapter 2) and to prevent the accumulation of free intermediates that are potentially extremely destructive under illumination. In higher plants, the metabolic flow of tetrapyrrole biosynthesis is regulated at the step of  **$\delta$ -aminolevulinic acid** synthesis. This regulation was previously attributed to the heme group's feedback control of **Glu tRNA reductase**, the first enzyme committed to tetrapyrrole biosynthesis. However, recent discovery of chlorophyll intermediates acting as signals that control both nuclear gene activities and tetrapyrrole biosynthesis, indicate that it is likely that heme is not the only regulator of this pathway. A genetic approach was used to identify additional factors involved in the control of tetrapyrrole biosynthesis (Meskauskiene et al., 2001). In *Arabidopsis thaliana*, a negative regulator of tetrapyrrole biosynthesis, FLU, operates independently of heme and seems to selectively affect only the Mg<sup>2+</sup> branch of tetrapyrrole biosynthesis.

Feedback mechanisms are also operative in lignifying cells, which prevent buildup of monolignols (Blee et al., 2003). This was observed using an antisense strategy for tobacco (*Nicotiana tabacum*), **peroxidase isoenzyme (TP60)**, which was downregulated in transgenic plants. Transformants showed lignin reduction of up to 40 to 50% of wild-type (control) plants.

The importance of primary metabolism in regulating secondary metabolism through feedback mechanisms was recently demonstrated by **microarray** studies on primary metabolic enzymes (sugar accumulation in *pho* mutants of *Arabidopsis*) and their effects on **anthocyanin biosynthesis** (Lloyd and Zakhleniuk, 2004). These findings reinforce the emerging picture of an important role for primary metabolism in regulating secondary metabolism.

Similarly, an *Arabidopsis* loss-of-function mutant in the **lysine pathway** points out complex regulatory mechanisms. A block in the **dihydrodipicolinate synthase (DHDPS)** gene (Figure 5.1) results in lower **lysine** synthesis and enhanced synthesis of **threonine** (Craciun et al., 2000). Possibly, the block resulted in diverting the metabolic precursors toward the synthesis of threonine. Analysis of various plant mutants possessing modified, feedback-insensitive enzymes showed that the DHDPS enzyme plays a major regulatory role in lysine synthesis, and that the **aspartate kinase (AK)** rate limits the synthesis of threonine (Figure 5.1).

The activity of **phenylalanine ammonia lyase (PAL)**, a key player in **phenylpropanoid metabolism**, is affected by feedback regulation by different downstream metabolites in the phenylpropanoid pathway. **Chlorogenic acid**, **lignins**, and **rutin** levels were identified as key regulators of different fluxes across pathways involved in the synthesis of phenylpropanoids. With this regulatory architecture of the pathway, the downstream steps are poised to control partitioning into different branch pathways (Bate et al., 1994).

Understanding points of action of feedback control in an enzyme sequence can be used to lift or remove such control using site-directed mutagenesis techniques, as described in Section 5.6.3. A good example is the case of **anthranilate synthase (AS)**. It is the key enzyme in the synthesis of **tryptophan (Trp)**, **indole-3-acetic acid (IAA)**, and **indole alkaloids**. Tryptophan accumulation was significantly

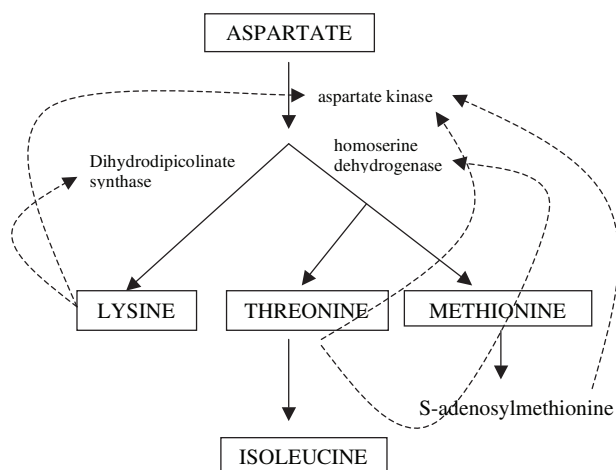

**FIGURE 5.1** Feedback mechanisms demonstrated by aspartate-derived amino acids and their pathways. Aspartate-derived biosynthetic pathways leading to the synthesis of lysine, methionine, and isoleucine. Dashed arrows indicate feedback mechanism by amino acids on respective enzymes. (Adapted from Yoshioka, Y., S. Kurei, and Y. Machida. (2001). *Genes and Genet Syst* 76: 189–198.)

increased up to 39-fold in mutant OASA2 (Y367A/L530D) compared to calli expressing OASA2 wild-type gene (Kanno et al., 2005).

### 5.7.3 Lignin Manipulation

A huge potential exists for improving plant raw materials and foodstuffs via gene manipulation. Biologically, **wood** is essentially a matrix of cell walls and the lumens of cells making up **secondary xylem** (wood) (Megraw, 1985). It can be considered the end-product of the collective action of many genes modulating the morphology and composition of secondary xylem cell walls in response to environmental and developmental signals. To date, progress in lignin manipulation is mostly limited to modulating the expression of single genes of well-studied pathways, such as the **lignin biosynthetic pathway**, in model species (see Table 5.4 for some examples). A new level of sophistication is achieved by over-expressing one lignin enzyme while simultaneously suppressing the expression of another lignin gene. This concept was recently shown in the case of lignin manipulation in the aspen tree (*Populus tremuloides*) (Li et al., 2003). Previously, the multigene manipulation strategy succeeded in improving several wood-quality traits (Halpin et al., 2001).

**TABLE 5.4**

Enzymatic Manipulation of Lignin Biosynthetic Pathway

	Trait Modified	Methods and Gene(s) Used	Observed Effect	Ref.
1	Lignin monomer methylation	Caffeic acid/5-hydroxyferulic acid 3/5- <i>O</i> -methyltransferase	Structural basis for the modulation of lignin monomer methylation	Zubieta et al., 2002
2	Monolignol biosynthesis	Transcriptional control	Monolignol ratios and carbon allocation in phenylpropanoid metabolism	Anterola and Lewis, 2002
3	Sinapate metabolism and lignin synthesis	Glucosyltransferase genes	Play key roles in the formation of these intermediates, potentially leading to the syringyl units found in lignins	Lim et al., 2001
4	Lignin content and composition	Downregulation of CCoAOMT	Total loss of S lignin without affecting cell wall polysaccharides	Guo et al., 2001

Among trees, **quantitative trait loci (QTL)** mapping has focused on wood properties and traits related to adaptation and growth (Sewell et al., 2000). Thirty-nine QTLs for *wsg* and seven for *mfa* were identified, each accounting for 5.4 to 15.7% of the phenotypic variance. The major trait that affects lignin quality includes the lignin biosynthetic genes **cinnamyl alcohol dehydrogenase (CAD)** and **caffeoyl CoA-O-methyltransferase (COMT)**. Downregulation of CAD and COMT activity by 32 and 44% (for COMT in the two lines tested) and 15 and 47% (for CAD as compared to wild-type activities) in transgenic plants in which these enzymes were downregulated yielded wood that was easier to pulp (Pilate et al., 2002). Overexpression of the **GA (gibberellin) 20-oxidase** in poplar, **glutamine synthetase** in pine (Gallardo et al., 1999), or constitutive suppression of **4-coumarate-CoA ligase** enhanced growth. Li et al. (2003) proposed a combinatorial modification of complete lignin traits. This would help in obtaining a more focused identification of potential traits for further manipulations in the future.

Complex monolignol-forming metabolic networks operate in various cell types, tissues, and organs, forming the cell-specific **guaiacyl (G)** and **guaiacyl-syringyl (G-S)**-enriched lignin biopolymers, respectively. Downregulation of **phenylalanine ammonia lyase (PAL)**, **cinnamate-4-hydroxylase (C4H)**, or steps in the G-S network predictably results in reduced lignin levels and impaired vascular integrity, as well as affects related (phenylpropanoid-dependent) metabolism (Anterola and Lewis, 2002). **Cinnamoyl CoA reductase (CCR)** and CAD downregulation/mutations also established that depletion in **monolignol** supply reduces both lignin components. In addition, analysis of the *bm1* mutation, a presumed CAD disrupted system, apparently revealed that both G and S lignin components were reduced. This seems to imply that there is no monolignol-specific dehydrogenase, such as the recently described **sinapyl alcohol dehydrogenase (SAD)** for sinapyl alcohol formation. For the G-lignin-forming network, however, the CAD isoform is apparently catalytically less efficient with all three monolignols than that associated with the corresponding G/S lignin-forming network(s) (Ralph et al., 1998). Thus, gene manipulation at a variety of steps in the networks of biosynthetic pathways can be an effective method in the discovery of how these networks fit together.

Likewise, **transcription factors** play a major role in lignin biosynthesis, as shown by the role of AmMYB308 and AmMYB330 from snapdragon (*Antirrhinum majus*). These transcription factors were shown to regulate phenylpropanoid and lignin biosynthesis in transgenic tobacco (*Nicotiana tabacum*; Tamagnone et al., 1998). It is important to remember that each gene within a biochemical pathway is under some form of regulation, and it is often the case that manipulation of the regulatory genes can have just as much of an impact on the biosynthesis of plant compounds as the manipulation of the genes that encode the actual enzymes.

#### 5.7.4 Flavonoid Manipulation

The **flavonoid** and **isoflavonoid pathways** are probably the best-characterized natural product pathways in plants and are, therefore, excellent targets for genetic manipulation (see Chapter 2 for details on these pathways). Flavonoid biosynthesis manipulation, using an overexpression approach, was attempted by Lukaszewicz et al. (2004) in order to exploit the antioxidant properties of flavonoids. Key genes targeted for this purpose included **chalcone synthase (CHS)**, **chalcone isomerase (CHI)**, and **dihydroflavonol reductase (DFR)**. Differential modification of flavonoid and isoflavonoid biosynthesis was attempted during the late 1990s, with an antisense CHS construct in transgenic *Lotus corniculatus* (Colliver et al., 1997). One of the early reports of flavonoid metabolism is associated with change in flower color (Holton, 1995). Also, genetic manipulation of **isoflavone 7-O-methyltransferase** enhances biosynthesis of **4-O-methylated isoflavonoid phytoalexins** as well as disease resistance in alfalfa (*Medicago sativa*) (He and Dixon, 2000).

Likewise, the role of transcriptional factors in altering flavonoid pathway end-products was well characterized, especially for Myb-type transcriptional factors. In addition, six different types of flavonoid regulatory elements (TFIIIA-like, WD-40-like, WRKY-like, MADS-box-like, myb-like, and bHLH [myc-like]) were cloned and identified using mutants from *Arabidopsis* (*tt1*, *ttg1*, *ttg2*, *tt2*, *tt16*, *tt2*, *tt8*) and two other species — *Hordeum vulgare* (*ant13*) and *Lotus* spp. (*tan1*) (Marles et al., 2003). Among the various approaches used, perhaps the most significant change is the 500-fold increase over wild-type

levels of flavonoids, determined by Mathews et al. (2003) using ANT1 in transgenic tomato (*Lycopersicon esculentum*). The enhanced purple coloration resulted from the overexpression of a gene that encodes a Myb-type transcription factor. The overexpression of ANT1 caused the upregulation of genes that encode proteins in both the early and later steps of **anthocyanidin biosynthesis** as well as genes involved in the **glycosylation** and transport of anthocyanins into the **vacuole**. Hence, manipulation in this pathway has proven to be successful and has a bearing on the nutraceuticals field. Some additional aspects of this important field are briefly discussed in Section 5.7.5.

### 5.7.5 Bioactive and Nutraceutical Compound Manipulation

**Nutraceutical** is a term that is a combination of “nutritional” and “pharmaceutical,” and it refers to the compounds within foods that act as medicines. Many of the secondary metabolites from plants play major roles as bioactive and nutraceutical compounds. **Nutraceuticals** include **polyphenols**, **phytoestrogens**, **phytosterols**, **phytates**, and **polyunsaturated fatty acids**. Other major nutraceutical compounds investigated by various workers include **carotenoids** as antioxidants (Sies and Stahl, 2004) and **polyketides** (Mendez and Salas, 2003).

Isoflavones have drawn much attention because of their benefits to human health (Kris-Etherton et al., 2004). The role of genistein in overcoming cystic fibrosis (CF) gene mutations is well characterized (Zeitlin, 2000). While isoflavones have their beneficial activities, they have other associated potential harmful ones. The estrogenic activity of several types of isoflavone compounds was well described. A detailed review on the effects of phytoestrogens and studies using microarray and systems approaches to study the effects of these bioactive compounds is described in a review by Barnes (2004). It was found that **genistein** alters the expression of genes six to eight times greater than a physiological estrogen, such as 17,-estradiol.

The discovery of useful novel compounds was enhanced by the adoption of a number of **reporter bioassays**, which allow the activity of a gene of interest to be monitored visually, making the screening process much easier. Several types of intracellular and extracellular reporter genes are currently used, and the most up-to-date and detailed description is provided by New et al. (2003). The most common intracellular reporter genes are **chloramphenicol acetyltransferase (CAT)**,  **$\beta$ -galactosidase**, **aequorin**, **green fluorescent protein (GFP)**, and **luciferase**. The most common extracellular reporter genes are **secreted placental alkaline phosphatase (SPAP)** and  **$\beta$ -lactamase**. A typical example for the use of such reporter systems in bioactive compound research is the use of the luciferase reporter gene assays that are used to screen natural products against enzymes and nuclear receptors (Miller-Martini et al., 2001). Additional bioassay techniques are described in Chapter 10, and many of these techniques are essential in the identification of gene manipulations that may result in useful medicinal properties.

### 5.7.6 Section Summary

We discussed several examples of the applications of molecular biology techniques in understanding natural product biosynthesis. Metabolic engineering and enhancement of secondary metabolite levels are also discussed in detail in Chapter 7. In order to understand (1) the different complex enzymatic reactions occurring in various pathways, (2) the numerous enzymes and genes involved in different organisms, and (3) the plethora of sequence information from these organisms, it is imperative to make use of **bioinformatics** tools. These tools help molecular biologists select genes based on sequence information; compare sequences in different organisms; find relationships between pathways, genes, and enzymes; and browse available literature to specifically find an enzyme or gene of interest. Many databases are now available for biosynthetic reactions, enzymes, proteins, protein–protein interactions, gene knockouts, and sequence information, providing invaluable information to natural product researchers. In the next section, we briefly discuss some currently available bioinformatics resources for the study of metabolic pathways. Functional genomics techniques are then discussed in detail in Chapter 6.



## 5.8 Bioinformatics Resources for Metabolic Pathways

Metabolic processes control body functions through small molecules involving highly complex networked pathways. A true understanding of metabolic processes requires an integrated approach. The limits of metabolic complexity are found in plants due to their extensive secondary metabolism networks. For instance, the model plant, *Arabidopsis thaliana*, has 184 metabolic pathways documented, including more than 700 different compounds and nearly 525 enzymes (Mueller et al., 2003; Rhee et al., 2003). However, the fact that there are approximately 900 known metabolites found experimentally in *Arabidopsis*, which are not assigned to any of the known metabolic pathways, indicates that information about the pathways is not complete. The vast quantities of diverse biological data generated by biotechnological advances led to the development and evolution of the field of **bioinformatics** that facilitates analysis of genomic and postgenomic data and the integration of information from the related fields of **transcriptomics**, **proteomics**, **metabolomics**, and **phenomics** (Edwards and Batley, 2004) (see Chapter 6 for a full description).

Identification of gene regulatory logic and biochemical networks is still a challenge. The conventional methods for creating a network model include performing several wet lab experiments and extensive literature surveys. Consequently, several attempts are under way to create large-scale databases on gene-regulatory and biochemical networks. These include the following:

**KEGG**, **Kyoto Encyclopedia of Genes and Genomes** database ([www.genome.ad.jp/kegg](http://www.genome.ad.jp/kegg))

**LIGAND**, a composite database consisting of the following four databases: **COMPOUND**, **GLYCAN**, **REACTION**, and **ENZYME** ([www.genome.ad.jp/dbget/ligand.html](http://www.genome.ad.jp/dbget/ligand.html))

**BRITE**, **Biomolecular Relations in Information Transmission and Expression** database ([www.genome.ad.jp/brite/brite.html](http://www.genome.ad.jp/brite/brite.html))

**STKE**, **Signal Transduction Knowledge Environment** database ([www.stke.org](http://www.stke.org))

**AFCS**, **Alliance for Cellular Signalling** database ([www.signalinggateway.org](http://www.signalinggateway.org))

**AraCyc**, *Arabidopsis thaliana* Biochemical Pathways ([www.arabidopsis.org/tools/aracyc](http://www.arabidopsis.org/tools/aracyc))

Other databases that could be used as references are **EMP** (Selkov et al., 1996), **PathDB** (Mendes et al., 2000), **UM-BBD** (Ellis et al., 2001), and **BRENDA** (Schomburg, Chang, and Schomburg, 2002). Additional Web resources are listed in the Appendix of this book.

All of these databases contain features that make them unique, but none singly fulfills all the requirements for a good reference for metabolic pathway studies (Mendes, 2002; Wittig and De Beuckelaer, 2001). Despite this, such databases serve as excellent knowledge resources. This is because such a reference list captures the complexity of relations between genes, proteins, and metabolites. It also identifies the evidence that was used to infer the existence of each particular molecule. Such relationships can now be studied more effectively using the tool known as the **Dragon Plant Biology Explorer (DPBE)**, which is described in Section 5.8.3. A group of researchers in Canada also organized a database named **Bio-molecular Interactions Database (BIND)**; ([www.blueprint.org/bind/bind.php](http://www.blueprint.org/bind/bind.php)), which contains similar features. In addition, one such database is being constructed for *Medicago truncatula* (Sumner et al., 2003).

Two widely used pathway resources, namely, the **AraCyc** and **KEGG** resources, for deciphering the genome are briefly described in following sections, and an example using the **DPBE** Web site is provided.

### 5.8.1 *Arabidopsis thaliana* Biochemical Pathways (AraCyc)

**AraCyc** is a database containing biochemical pathways of *Arabidopsis* developed at **The Arabidopsis Information Resource** ([www.arabidopsis.org](http://www.arabidopsis.org)) with the aim to represent *Arabidopsis* metabolism using a Web-based interface (Mueller et al., 2003). This database now contains 221 pathways that include information on compounds, metabolic intermediates, cofactors, reactions, genes, proteins, and protein

subcellular locations. This database allows users to visualize all pathways in the database down to the individual chemical structures. Built using a pathologic module with **MetaCyc** (a collection of pathways from >150 species), AraCyc was validated by comparing it with **EcoCyc** (an *Escherichia coli* database that uses the same software), and it is upgraded periodically. Some of the above resources, including AraCyc, also link the pathway information to the genome resources.

### 5.8.2 Kyoto Encyclopedia of Genes and Genomes (KEGG)

**KEGG** is a suite of databases and associated software that integrates current knowledge on molecular interaction networks in biological processes (PATHWAY database), information about the universe of genes and proteins (GENES/SSDB/KO databases), and information about the universe of chemical compounds and reactions (COMPOUND/GLYCAN/REACTION databases) accessible at [www.genome.ad.jp/kegg](http://www.genome.ad.jp/kegg). It currently hosts 15,037 pathways, of which 229 are reference pathways. It has genome coverage from 181 organisms and catalogs 646,192 genes with ortholog clusters known for 33,305 of the genes. It also has links to more than 10,000 chemical compounds and approximately 6000 chemical reactions. KEGG attempts to uncover and utilize cellular functions through reconstruction of protein interaction networks from the genome information. The KEGG lists enzymes in a specific organism for an existent sequence in **GenBank** that is annotated as coding for such an enzyme (Kanehisa et al., 2004).

### 5.8.3 Dragon Plant Biology Explorer (DPBE)

**DPBE** is a system based on gene ontologies and biochemical entity vocabularies that integrates information on *Arabidopsis* genes with their functions and presents the associations as interactive networks. DPBE is available at <http://research.i2r.a-star.edu.sg/DRAGON/ME2>. As such, this system can also be used for the analysis of different plants, although with less efficiency, as well as in the analysis of other species. The aim of the DPBE system is to identify potential associations between different searched components, particularly those that can suggest the function of the entity found. In this process of collecting information, DPBE uses supplied text documents collected from the **PubMed** repository. It analyzes submitted text and provides comprehensive summary information for the user. This tool can be used to rapidly build an information base on the previously reported relationships by using **microarray** results. This tool complements the existing biological resources for systems biology by identifying potentially novel associations using text analysis between cellular entities based on genome annotation terms. Therefore, DPBE complements the existing biological resources by presenting associations that can reveal some of the not-so-easily observable connections of metabolic entities. Another crucial aspect of the DPBE utility is that it condenses information from a large volume of documents for easy inspection and analysis, thus making it more accessible for individual users.

The text mining is performed based on the following well-controlled vocabularies, as adopted by TAIR ([www.tair.org](http://www.tair.org)) for *Arabidopsis thaliana*:

- List of pathways
- List of enzymes
- List of metabolites
- TAIR-developed anatomy ontology
- TAIR's ontology of developmental stages
- List of *Arabidopsis thaliana* genes and mutants

In addition, the system uses a local installation of PubMed with partly preprocessed documents. This makes the final analysis faster. The output is available in a number of formats, including tables or relationship networks, as shown in Figure 5.2 and Figure 5.3. This is part of a network obtained for literature on flavonoids and plants. Vocabulary lists chosen are metabolites, anatomy, development, biological process, and molecular function. As can be seen in these figures, the DPBE tool summarizes both pharmacological and pathway-related information efficiently.

Metabolites	Anatomy	Development	Biological Process	Molecular Function	Frequency
Flavonoid					1743
Isoflavone					544
Quercetin					508
Flavonol					375
Genistein					369
Flavone					335
			Growth		333
	Root				320
Kaempferol					279
			Development		275
Daidzein					267
	Seed				259
				Antioxidant activity	233
	Flower				228
			Metabolism		200
	Leaf				181
Methanol					174
				Binding	166
	Stem				160
Apigenin					155
Rutin					145
Flavanone					141
Luteofin					136
Ethanol					119
			Biosynthesis		118
Naringenin					110

FIGURE 5.2 DME Report for the query “flavonoids” AND “plants.”

## 5.9 Conclusions

In this chapter, we presented many examples of molecular studies that expand the understanding of how plant structural, enzymatic, and regulatory genes work together to produce specific compounds. The repertoire of approaches available for molecular biologists has increased greatly with the advent of genome biology. More sensitive and high-throughput technologies have come within the realm of the biologists' workbench at more affordable costs. At the same time, gene manipulation and the discovery of phenomena such as RNA silencing have tremendously increased the potential of plant molecular biologists to control the expression levels of the genes within specific biosynthetic pathways. With these technical advances, studies of gene expression and regulation can now be carried out more efficiently. In recent years, there was a sharp increase in the number of protein structures resolved. Hence, mechanistic views of those metabolic reactions can now be studied in more depth. Likewise, there is a much better understanding of how proteins can interact with each other to form regulatory complexes or multicomponent enzymes that govern biosynthetic pathways. In addition, the completed genomes of *Arabidopsis*, rice (*Oryza sativa*), and poplar trees (*Populus trichocarpa*) have contributed significantly to our understanding of the metabolic genes and potential pathways present in plant systems. These studies generated a huge amount of data on when and where specific genes are expressed within these species. The complexity of such information generated the need for completely new fields of research in bioinformatics as well as the creation of databases that deal with the information at all levels of gene expression. We introduced some of these databases in this chapter, giving an example of how they can be used to better understand how the information from many research approaches can come together to generate a clearer picture of the molecular biology of natural products. We expand upon these more integrated approaches in Chapter 6.

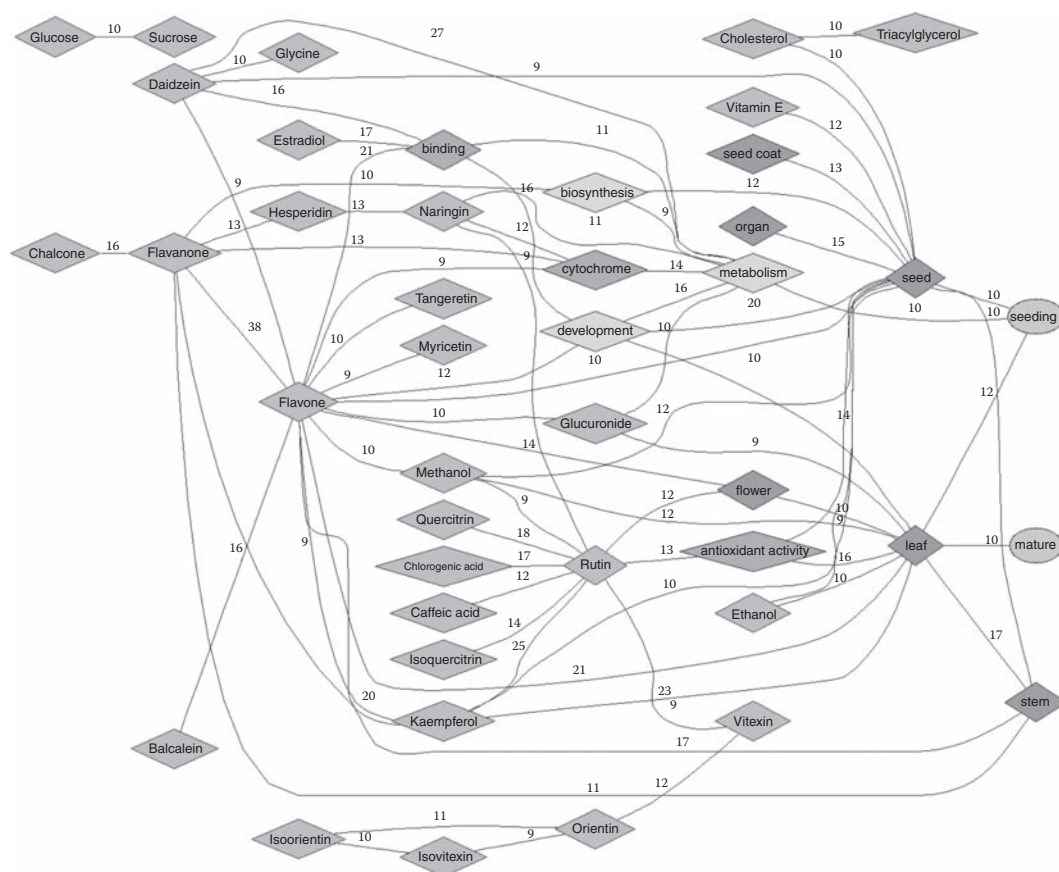

**FIGURE 5.3** (See color insert following page 256.) DME network showing potential relations with the query “flavonoid” AND “plants.”

## References

- Abbott, J.C., A. Barakate, G. Pincon, M. Legrand, C. Lapiere, I. Mila, W. Schuch, and C. Halpin. (2002). Simultaneous suppression of multiple genes by single transgenes. Downregulation of three unrelated lignin biosynthetic genes in tobacco. *Plant Physiol.* 128: 844–853.
- Anterola, A.M. and N.G. Lewis. (2002). Trends in lignin modification: a comprehensive analysis of the effects of genetic manipulations/mutations on lignification and vascular integrity. *Phytochemistry* 61: 221–294.
- Arabidopsis Genome Initiative. (2000). Analysis of the genome sequence of the flowering plant *Arabidopsis thaliana*. *Nature* 408: 796–815.
- Bak, S., C.E. Olsen, B.L. Petersen, B.L. Moller, and B.A. Halkier. (1999). Metabolic engineering of *p*-hydroxybenzylglucosinolate in *Arabidopsis* by expression of the cyanogenic CYP79A1 from *Sorghum bicolor*. *Plant J* 20: 663–671.
- Barlier, I., M. Kowalczyk, A. Marchant, K. Ljung, R. Bhalerao, M. Bennett, G. Sandberg, and C. Bellini. (2000). The SUR2 gene of *Arabidopsis thaliana* encodes the cytochrome P450 CYP83B1, a modulator of auxin homeostasis. *Proc Natl Acad Sci USA* 97: 14819–14824.
- Barnes, S. (2004). Soy isoflavones — phytoestrogens and what else? *J Nutr* 134: 1225–1228.
- Bate, N.J., J. Orr, W. Ni, A. Meromi, T. Nadler-Hassar, P.W. Doerner, R.A. Dixon, C.J. Lamb, and Y. Elkind. (1994). Quantitative relationship between phenylalanine ammonia-lyase levels and phenylpropanoid accumulation in transgenic tobacco identifies a rate-determining step in natural product synthesis. *Proc Natl Acad Sci USA* 91: 7608–7612.

- Baudry, A., M.A. Heim, B. Dubreucq, M. Caboche, B. Weisshaar, and L. Lepiniec. (2004). TT2, TT8, and TTG1 synergistically specify the expression of BANYULS and proanthocyanidin biosynthesis in *Arabidopsis thaliana*. *Plant J* 39: 366–380.
- Bhalla, R., K. Narasimhan, and S. Swarup. (2005). Metabolomics and its role in understanding cellular responses in plants. *Plant Cell Rep* 24: 562–571.
- Bick, J.A. and B.M. Lange. (2003). Metabolic cross talk between cytosolic and plastidial pathways of isoprenoid biosynthesis: unidirectional transport of intermediates across the chloroplast envelope membrane. *Arch Biochem and Biophys* 415: 146–154.
- Blee, K.A., J.W. Choi, A.P. O'Connell, W. Schuch, N.G. Lewis, and G.P. Bolwell. (2003). A lignin-specific peroxidase in tobacco whose antisense suppression leads to vascular tissue modification. *Phytochemistry* 64: 163–176.
- Bouvier, F., C. Suire, J. Mutterer, and B. Camara. (2003). Oxidative remodeling of chromoplast carotenoids: identification of the carotenoid dioxygenase CsCCD and CsZCD genes involved in Crocus secondary metabolite biogenesis. *The Plant Cell* 15: 47–62.
- Bradley, J.M., K.M. Davies, S.C. Deoles, S.J. Bloor, and D.H. Lewis. (1998). The maize Lc regulatory gene up-regulates the flavanoid biosynthetic pathway of petunia. *The Plant J* 13: 381–392.
- Brown, J.W.S., M. Echeverria, and L.H. Qu. (2003). Plant snoRNAs: functional evolution and new modes of gene expression. *Trends in Plant Sci* 8: 42–49.
- Buchanan, R.B., W. Gruissem, and R.L. Jones. (2000). *Biochemistry and Molecular Biology of Plants*. American Society of Plant Physiologists, Rockville, Maryland.
- Burbulis, I.E. and B. Winkel-Shirley. (1999). Interactions among enzymes of the *Arabidopsis* flavonoid biosynthetic pathway. *Proc Natl Acad Sci USA* 96: 12929–12934.
- Burger, C., S. Rondet, P. Benveniste, and H. Schaller. (2003). Virus-induced silencing of sterol biosynthetic genes: identification of a *Nicotiana tabacum* L. obtusifoliol-14  $\alpha$ -demethylase (CYP51) by genetic manipulation of the sterol biosynthetic pathway in *Nicotiana benthamiana* L. *J Exp Bot* 54: 1675–1683.
- Chen, F., D. Tholl, J.C. D'Auria, A. Farooq, E. Pichersky, and J. Gershenon. (2003). Biosynthesis and emission of terpenoid volatiles from *Arabidopsis* flower. *The Plant Cell* 15: 481–494.
- Colliver, S.P., P. Morris, and M.P. Robbins. (1997). Differential modification of flavonoid and isoflavonoid biosynthesis with an antisense chalcone synthase construct in transgenic *Lotus corniculatus*. *Plant Mol Biol* 35: 509–522.
- Craciun, A., M. Jacobs, and M. Vauterin. (2000). *Arabidopsis* loss-of-function mutant in the lysine pathway points out complex regulation mechanisms. *FEBS Lett* 487: 234–238.
- Cseke, L., N. Dudareva, and E. Pichersky. (1998). Structure and evolution of linalool synthase. *Mol Biol Evol* 15: 1491–1498.
- Cseke, L.J., P.B. Kaufman, G.K. Podila, and C.-J. Tsai. (2004). *Molecular and Cellular Methods in Biology and Medicine*, 2nd ed. CRC Press, Boca Raton, Florida.
- Cukovic, D., J. Ehrling, J.A. VanZiffle, and C.J. Douglas. (2001). Structure and evolution of 4-coumarate: coenzyme A ligase (4CL) gene families. *Biol Chem* 382: 645–654.
- Das, L. and R. Martienssen. (1995). Site-selected transposon mutagenesis at the hcf106 locus in maize. *The Plant Cell* 7: 287–294.
- De Luca, V. and B. St. Pierre. (1996). The cell and developmental biology of alkaloid biosynthesis. *Trends in Plant Sci* 5: 168–173.
- Edwards, D. and J. Batley. (2004). Plant bioinformatics: from genome to phenome. *Trends in Biotechnol* 22: 232–237.
- Ellis, L.B., C.D. Hershberger, E.M. Bryan, and L.P. Wackett. (2001). The University of Minnesota Biocatalysis/Biodegradation Database: emphasizing enzymes. *Nucleic Acids Res* 29: 340–343.
- Facchini, P.J. and S.U. Park. (2003). Developmental and inducible accumulation of gene transcripts involved in alkaloid biosynthesis in opium poppy. *Phytochemistry* 64: 177–186.
- Falk, K.L., C. Voge, S. Textor, S. Bartram, A. Hick, J. Pickett, and J. Gershenon. (2004). Glucosinolate biosynthesis demonstration and characterization of the condensing enzyme of the chain elongation cycle in *Eruca sativa*. *Phytochemistry* 65: 1073–1084.
- Farzad, M., R. Griesbach, J. Hammond, M.R. Weiss, and H.G. Elmendorf. (2003). Differential expression of key anthocyanin biosynthetic genes in a color-changing flower, *Viola cornuta* cv. Yesterday, Today and Tomorrow. *Plant Sci* 165: 1333–1342.

- Feldmann, K.A. (2001). Cytochrome P450s as genes for crop improvement. *Curr Opin in Plant Biol* 4: 162–167.
- Ferrer, J.L., J.M. Jez, M.E. Bowman, R.A. Dixon, and J.P. Noel. (1999). Structure of chalcone synthase and the molecular basis of plant polyketide biosynthesis. *Nat Struct Biol* 6: 775–784.
- Fujiwara, H., Y. Tanaka, Y. Fukui, M. Nakao, T. Ashikari, and T. Kusumi. (1997). Anthocyanin 5-aromatic acyltransferase from *Gentiana triflora*. Purification, characterization and its role in anthocyanin biosynthesis. *Eur J Biochem* 249: 45–51.
- Gallardo, F., J. Fu, F.R. Cantón, A.G. Gutiérrez, F.M. Cánovas, and E.G. Kirby. (1999). Expression of a conifer glutamine synthetase gene in transgenic poplar. *Planta* 210: 19–26.
- Gang, D.R., T. Beuerle, P. Ullmann, D. Werck-Reichhart, and E. Pichersky. (2002). Differential production of *meta* hydroxylated phenylpropanoids in sweet basil peltate glandular trichomes and leaves is controlled by the activities of specific acyltransferases and hydroxylases. *Plant Physiol* 130: 1536–1544.
- Gantet, P. and J. Memelink. (2002). Transcription factors: tools to engineer the production of pharmacologically active plant metabolites. *Trends in Pharmacol Sci* 23: 563–569.
- Gollop, R., S. Farhi, and A. Perl. (2001). Regulation of the leucoanthocyanidin dioxygenase gene expression in *Vitis vinifera*. *Plant Sci* 161: 579–588.
- Gomez-Vasquez, R., R. Day, H. Buschmann, S. Randles, J.R. Beeching, and R.M. Cooper. (2004). Phenylpropanoids, phenyl ammonia lyase and peroxidases in elicitor-challenged cassava (*Manihot esculenta*) suspension cells and leaves. *Ann Bot* 94: 87–97.
- Grimmig, B., M.N. Gonzalez-Perez, G. Welzl, J. Penuelas, R. Schubert, R. Hain, B. Heidenreich, C. Betz, C. Langebartels, D. Ernst, and H. Sandermann, Jr. (2002). Ethylene and ozone induces regulation of a grapevine resveratrol synthase gene: different responsive promoter regions. *Plant Physiol and Biochem* 40: 865–870.
- Guillet, G., J. Poupard, J. Basurco, and V. De Luca. (2000). Expression of tryptophan decarboxylase and tyrosine decarboxylase genes in tobacco results in altered biochemical and physiological phenotypes. *Plant Physiol* 122: 933–943.
- Guo, D., F. Chen, J. Wheeler, J. Winder, S. Selman, M. Peterson, and R.A. Dixon. (2001). Improvement of in-rumen digestibility of alfalfa forage by genetic manipulation of lignan O-methyltransferases. *Transgenic Res* 10: 457–464.
- Hall, R., M. Beale, O. Fiehn, N. Hardy, L. Sumner, and R. Bino. (2002). Plant metabolomics: the missing link in functional genomics strategies. *The Plant Cell* 14: 1437–1440.
- Halpin, C., A. Barakate, B.M. Askari, J.C. Abbott, and M.D. Ryan. (2001). Enabling technologies for manipulating multiple genes on complex pathways. *Plant Mol Biol* 47: 295–310.
- He, X.Z. and R.A. Dixon. (2000). Genetic manipulation of isoflavone 7-O-methyltransferase enhances biosynthesis of 4-O-methylated isoflavonoid phytoalexins and disease resistance in alfalfa. *The Plant Cell* 12: 1689–1702.
- Herrmann, K.M. and L.M. Weaver. (1999). The shikimate pathway. *Ann Rev Plant Physiol and Plant Mol Biol* 50: 473–503.
- Hoffmann, L., S. Besseau, P. Geoffroy, C. Ritzenthaler, D. Meyer, C. Lapierre, B. Pollet, and M. Legrand. (2004). Silencing of hydroxycinnamoyl-coenzyme A shikimate/quininate hydroxycinnamoyl transferase affects phenylpropanoid biosynthesis. *Plant Cell* 16: 1446–1465.
- Holton, T.A. (1995). Modification of flower colour via manipulation of P450 gene expression in transgenic plants. *Drug Metab and Drug Interactions* 12: 359–368.
- Honda, C., N. Kotoda, M. Wada, S. Kondo, S. Kobayashi, J. Soejima, Z. Zhang, T. Tsuda, and T. Moriguchi. (2002). Anthocyanin biosynthetic genes are coordinately expressed during red coloration in apple skin. *Plant Physiol and Biochem* 40: 955–962.
- Huang, F.C. and T.M. Kuchan. (2000). Distribution of morphinan and benzo phenanthridine alkaloid gene transcript accumulation in *Papaver somniferum*. *Phytochemistry* 53: 555–564.
- Ithal, N. and A.R. Reddy. (2004). Rice flavanoid pathway genes, OsDfr and OsAns, are induced by dehydration, high salt and ABA, and contain stress responsive promoter elements that interact with the transcription activator, OsC1-MYB. *Plant Sci* 166: 1505–1513.
- Itoh, A., A.L. Schillmiller, B.C. McCaig, and G.A. Howe. (2002). Identification of a jasmonate-regulated allene oxide synthase that metabolizes 9-hydroperoxides of linoleic and linolenic acids. *J Biol Chem* 277: 46051–46058.

- Jez, J.M. and J.P. Noel. (2002). Reaction mechanism of chalcone isomerase, pH dependence, diffusion control and product binding differences. *J Biol Chem* 277: 1361–1369.
- Jez, J.M., M.E. Bowman, and J.P. Noel. (2001). Structure-guided programming of polyketide chain length determination in chalcone synthase. *Biochem* 40: 14829–14838.
- Johnson, C.M., S.L. Roderick, and P.F. Cook. (2005). The serine acetyltransferase reaction: acetyl transfer from an acylpantothenyl donor to an alcohol. *Arch Biochem and Biophys* 433: 85–95.
- Jorgensen, R.A., P.D. Cluster, J. English, Q. Que, and C.A. Napoli. (1996). Chalcone synthase cosuppression phenotypes in petunia flowers: comparison of sense vs. antisense constructs and single-copy vs. complex T-DNA sequences. *Plant Mol Biol* 31: 957–973.
- Kanehisa, M., S. Goto, S. Kawashima, Y. Okuno, and M. Hattori. (2004). The KEGG resource for deciphering the genome. *Nucleic Acids Res* 32: D277–D280.
- Kanno, T., A. Komatsu, K. Kasai, J.G. Dubouzet, M. Sakurai, Y. Ikejiri-Kanno, K. Wakasa, and Y. Tozawa. (2005). Structure-based *in vitro* engineering of the anthranilate synthase, a metabolic key enzyme in the plant tryptophan pathway. *Plant Physiol* 138: 2260–2268.
- Karp, P.D., M. Riley, M. Saier, I.T. Paulsen, J. Collaado-Vides, S.M. Paley, A. Pellegrini-Toole, C. Bonavides, and S. Gamo-Castro. (2002). The EcoCyc database. *Nucleic Acids Res* 30: 56–58.
- Kato, M., Y. Ikoma, H. Matsumoto, M. Sugiura, H. Hyodo, and M. Yano. (2004). Accumulation of carotenoids and expression of carotenoid biosynthetic genes during maturation in citrus fruit. *Plant Physiol* 134: 824–837.
- Kiddle, G., G.M. Pastori, S. Bernard, C. Pignocchi, J. Antoniw, P.J. Verrier, and C.H. Foyer. (2003). Effects of leaf ascorbate content on defense and photosynthesis gene expression in *Arabidopsis thaliana*. *Antioxidants and Redox Signaling* 5: 23–32.
- Kim, S.H. and V. Walbot. (2003). Deletion derivatives of the MuDR regulatory transposon of maize encode antisense transcripts but are not dominant-negative regulators of mutator activities. *The Plant Cell* 15: 2430–2447.
- Kimball, J. (2002). Antisense RNA. <http://users.rcn.com/jkimball.ma.ultranet/BiologyPages/A/AntisenseRNA.html>.
- Kliebenstein, D.J., V.M. Lambrix, M. Reichelt, J. Geershenzon, and T. Mitchell-olds. (2001). Gene duplication in the diversification of secondary metabolism: tandem 2-oxoglutarate-dependent dioxygenases control glucosinolate biosynthesis in *Arabidopsis*. *The Plant Cell* 13: 681–693.
- Kolosova, N., D. Sherman, D. Karlson, and N. Dudareva. (2001). Cellular and subcellular localization of S-adenosyl-L-methionine: benzoic acid carboxyl methyl transferase, the enzyme responsible for biosynthesis of the volatile ester methyl benzoate in snapdragon flowers. *Plant Physiol* 126: 956–964.
- Koornneef, M., L.M.N. Dellaert, and J.H. van der Veen. (1982). EMS and radiation-induced mutation frequencies at individual loci in *Arabidopsis thaliana* (L) Heynh. *Mutat Res* 93: 109–123.
- Kris-Etherton, P.M., M. Lefevre, G.R. Beecher, M.D. Gross, C.L. Keen, and T.D. Etherton. (2004). Bioactive compounds in nutrition and health-research methodologies for establishing biological function: the antioxidant and anti-inflammatory effects of flavonoids on atherosclerosis. *Ann Rev Nutr* 24: 511–538.
- Leung, H., J. Wu, C. Lei, C. Wu, M. Baraoidan, A. Boredos, S. Madamba, R. Mauleon, I. Ona, C. Vera Cruz, R. Bruskiwich, L. Zeng, G. Wang, P. Manosalva, and J. Leach. (2003). Forward and reverse genetics using chemical- and irradiation-induced mutants of indica rice. <http://www.ncgr.ac.cn/chinese/p4-5-2.htm>.
- Li, L., Y. Zhou, X. Cheng, J. Sun, J.M. Marita, J. Ralph, and V.L. Chiang. (2003). Combinatorial modification of multiple lignin traits in trees through multigene cotransformation. *Proc Natl Acad Sci USA* 100: 4939–4944.
- Lim, E.K. and D.J. Bowles. (2004). A class of plant glycosyltransferases involved in cellular homeostasis. *EMBO J* 23: 2915–2922.
- Lim, E.K., Y. Li, A. Parr, R. Jackson, D.A. Ashford, and D.J. Bowles. (2001). Identification of glucosyltransferase genes involved in sinapate metabolism and lignin synthesis in *Arabidopsis*. *J Biol Chem* 276: 4344–4349.
- Lindsay, W.P., F.M. McAlister, Q. Zhu, X.Z. He, W. Droge-Laser, S. Hedrick, P. Doerner, C. Lamb, and R.A. Dixon. (2002). KAP-2, a protein that binds to the H box in a bean chalcone synthase promoter, is a novel plant transcription factor with sequence identity to the large subunit of human Ku antigen. *Plant Mol Biol* 49: 503–514.
- Llave, C., K.D. Kasschau, M.A. Rector, and J.C. Carrington. (2002). Endogenous and silencing-associated small RNA's in plants. *The Plant Cell* 14: 1605–1619.

- Lloyd, J.C. and O.V. Zakhleniuk. (2004). Responses of primary and secondary metabolism to sugar accumulation revealed by microarray expression analysis of the *Arabidopsis* mutant, *pho3*. *J Exp Bot* 55: 1221–1230.
- Lu, S., Y.-H. Sun, R. Shi, C. Clark, L. Li, and V.L. Chiang. (2005). Novel and mechanical stress-responsive microRNAs in *Populus trichocarpa* that are absent from *Arabidopsis*. *The Plant Cell* 17: 2186–2203.
- Lukaszewicz, M., I. Matysiak-Kata, J. Skala, I. Fecka, W. Cisowski, and J. Szopa. (2004). Antioxidant capacity manipulation in transgenic potato tuber by changes in phenolic compounds content. *J Agric and Food Chem* 52: 1526–1533.
- Mahmoud, S.S., M. Williams, and R. Croteau. (2004). Cosuppression of limonene-3-hydroxylase in peppermint promotes accumulation of limonene in the essential oil. *Phytochemistry* 65: 547–554.
- Marles, M.A., H. Ray, and M.Y. Gruber. (2003). New perspectives on proanthocyanidin biochemistry and molecular regulation. *Phytochemistry* 64: 367–383.
- Maslov, S. and K. Sneppen. (2002). Specificity and stability in topology of protein networks. *Science* 296: 910–913.
- Mathews, H., S.K. Clendennen, C.G. Caldwell, X.L. Liu, K. Connors, N. Matheis, D.K. Schuster, D.J. Menasco, W. Wagoner, J. Lightner, and D.R. Wagner. (2003). Activation tagging in tomato identifies a transcriptional regulator of anthocyanin biosynthesis, modification, and transport. *The Plant Cell* 15: 1689–1703.
- McInnes, R., A. Lidgett, D. Lynch, H. Huxley, E. Jones, N. Mahoney, and G. Spangenberg. (2002). Isolation and characterization of cinnamoyl-CoA reductase gene from perennial ryegrass (*Lolium perenne*). *J Plant Physiol* 159: 415–422.
- Megraw, R.A. (1985). Fibre length. In *Wood Quality Factors in Loblolly Pine*, R.A. Megraw (Ed.). TAPPI Press, Atlanta, chap. 2.
- Mendes, P. (2002). Emerging bioinformatics for the metabolome. *Briefings in Bioinformatics* 3: 134–145.
- Mendes, P., D.L. Bulmore, A.D. Farmer, P.A. Steadman, M.E. Waugh, and S.T. Wlodek. (2000). PathDB: a second generation metabolic database. In *Animating the Cellular Map*, J.-H.S. Hofmeyr, J.M. Rohwer, and J.L. Snoep (Eds.). Stellenbosch University Press, Stellenbosch, South Africa, pp. 207–212.
- Mendez, C. and L.A. Salas. (2003). On the generation of novel anticancer drugs by recombinant DNA technology: the use of combinatorial biosynthesis to produce novel drugs. *Combinatorial Chem and High Throughput Screening* 6: 513–526.
- Meskauskiene, R., M. Nater, D. Goslings, F. Kessler, R. op den Camp, and K. Apel. (2001). FLU: a negative regulator of chlorophyll biosynthesis in *Arabidopsis thaliana*. *Proc Natl Acad Sci USA* 98: 12826–12831.
- Meyer, K., J.C. Cusumano, C. Somerville, and C.C. Chapple. (1996). Ferulate-5-hydroxylase from *Arabidopsis thaliana* defines a new family of cytochrome P450-dependent monooxygenases. *Proc Natl Acad Sci USA* 93: 6869–6874.
- Meyermans, H., K. Morreel, C. Lapierre, B. Pollet, A. De Bruyn, R. Busson, P. Herdewijn, B. Devreese, J. Van Beeumen, J.M. Marita, J. Ralph, C. Chen, B. Burggraave, M. Van Montagu, E. Messens, and W. Boerjan. (2000). Modifications in lignin and accumulation of phenolic glucosides in poplar xylem upon down-regulation of caffeoyl-coenzyme A *O*-methyltransferase, an enzyme involved in lignin biosynthesis. *J Biol Chem* 275: 36899–36909.
- Mikkelsen, M.D. and B.A. Halkier. (2003). Metabolic engineering of valine and isoleucine-derived glucosinolates in *Arabidopsis* expressing CYP79D2 from cassava. *Plant Physiol* 131: 773–779.
- Mikkelsen, M.D., B.L. Petersen, E. Glawischnig, A.B. Jensen, E. Andreasson, and B.A. Halkier. (2003). Modulation of CYP79 genes and glucosinolate profiles in *Arabidopsis* by defense signaling pathways. *Plant Physiol* 131: 298–308.
- Miller, W.A., P.M. Waterhouse, J.W.S. Brown, and K.S. Browning. (2001). The RNA world in plants: post-transcriptional control III. *The Plant Cell* 13: 1710–1717.
- Miller-Martini, D.M., R.Y.K. Chan, N.Y. Ip, S.J. Sheu, and Y.H. Wong. (2001). A reporter gene assay for the detection of phytoestrogens in traditional Chinese medicine. *Phytotherapy Res* 15: 487–492.
- Montgomery, M.K. (2004). RNA interference: historical overview and significance. *Methods in Mol Biol* 265: 3–22.
- Morant, M., S. Bak, B.L. Moller, and D. Werck-Reichhart. (2003). Plant cytochromes P450: tools for pharmacology, plant protection and phytoremediation. *Curr Opin Biotechnol* 14: 151–162.
- Moyano, E., S. Encinas-Villarejo, J.A. López-Ráez, J. Redondo-Nevado, R. Blanco-Portales, M.L. Bellido, C. Sanz, J.L. Caballero, and J. Muñoz-Blanco. (2004). Comparative study between two strawberry pyruvate decarboxylase genes along fruit development and ripening, post harvest and stress conditions. *Plant Sci* 166: 835–845.



- Mueller, L.A., P. Zhang, and S.Y. Rhee. (2003). AraCyc: a Biochemical Pathway Database for *Arabidopsis*. *Plant Physiol* 132: 453–460.
- Nesi, N., I. Debeaujon, C. Jond, G. Pelletier, M. Caboche, and L. Lepiniec. (2000). The TT8 gene encodes a basic helix-loop-helix domain protein required for expression of DFR and BAN genes in *Arabidopsis* siliques. *The Plant Cell* 12: 1863–1878.
- Nesi, N., C. Jond, I. Debeaujon, M. Caboche, and L. Lepiniec. (2001). The *Arabidopsis* TT2 gene encodes an R2R3 MYB domain protein that acts as a key determinant for proanthocyanidin accumulation in developing seed. *The Plant Cell* 13: 2099–2114.
- New, D.C., D.M. Miller-Martini, and Y.H. Wong. (2003). Reporter gene assays and their applications to bioassays of natural products. *Phytotherapy Res* 17: 439–448.
- Nielsen, J.S. and B.L. Moller. (2000). Cloning and expression of cytochrome P450 enzymes catalyzing the conversion of tyrosine to *p*-hydroxyphenylacetaldoime in the biosynthesis of cyanogenic glucosides in *rioglchin maritima*. *Plant Physiol* 122: 1311–1321.
- Nomura, T., A. Ishihara, H. Imaishi, H. Ohkawa, T.R. Endo, and H. Iwamura. (2003). Rearrangement of the genes for the biosynthesis of benzoxazinones in the evolution of Triticeae species. *Planta* 217: 776–782.
- Okada, T., M.Y. Hirai, H. Suzuki, M. Yamazaki, and K. Saito. (2005). Molecular characterization of a novel quinolizidine alkaloid *O*-tigloyltransferase: cDNA cloning, catalytic activity of recombinant protein and expression analysis in *Lupinus* plants. *Plant and Cell Physiol* 46: 233–244.
- Petersen, B.L., E. Andreasson, S. Bak, N. Agerbirk, and B.A. Halkier. (2001). Characterization of transgenic *Arabidopsis thaliana* with metabolically engineered high levels of *p*-hydroxybenzylglucosinolate. *Planta* 212: 612–618.
- Pichersky, E. and D.R. Gang. (2000). Genetics and biochemistry of secondary metabolites: an evolutionary perspective. *Trends Plant Sci* 5: 439–445.
- Pilate, G., E. Guiney, K. Holt, M. Petit-Conil, C. Lapiere, L. Jean-Charles, B. Pollet, I. Mila, A.E.A. Webster, H.G. Marstorp, D.W. Hopkins, L. Jouanin, W. Boerjan, W. Schuch, D. Cornu, and C. Halpin. (2002). Field and pulping performances of transgenic trees with altered lignification. *Nat Biotechnol* 20: 607–612.
- Pincon, G., M. Chabannes, C. Lapiere, B. Pollet, K. Ruel, J.P. Joseleau, A.M. Boudet, and M. Legrand. (2001). Simultaneous down-regulation of caffeic/5-hydroxy ferulic acid-*O*-methyltransferase I and cinnamoyl-coenzyme A reductase in the progeny from a cross between tobacco lines homozygous for each transgene. Consequences for plant development and lignin synthesis. *Plant Physiol* 126: 145–155.
- Qi, X., S. Bakht, M. Leggett, C.L. Maxwell, R. Melton, and A. Osbourn. (2004). A gene cluster for secondary metabolism in oat: implications for the evolution of metabolic diversity in plants. *Proc Natl Acad Sci USA* 101: 8233–8238.
- Ralph, J., R.D. Hatfield, J. Piquemal, N. Yahiaoui, M. Pean, C. Lapiere, and A.M. Boudet. (1998). NMR characterization of altered lignins extracted from tobacco plants down-regulated for lignification enzymes cinnamylalcohol dehydrogenase and cinnamoyl-CoA reductase. *Proc Natl Acad Sci USA* 95: 12803–12808.
- Reutter, M., K. Meyer, J.C. Cusumano, and C. Chapple. (1999). Regulation of ferulate-5-hydroxylase expression in *Arabidopsis* in the context of sinapate ester biosynthesis. *Plant Physiol* 119: 101–110.
- Rhee, S.Y., W. Beavis, T.Z. Berardini, G.H. Chen, D. Dixon, A. Doyle, M. Garcia-Hernandez, E. Huala, G. Lander, M. Montoya, N. Miller, L.A. Mueller, S. Mundodi, L. Reiser, J. Tacklind, D.C. Weems, Y.H. Wu, I. Xu, D. Yoo, J. Yoon, and P.F. Zhang. (2003). The *Arabidopsis* Information Resource (TAIR): a model organism database providing a centralized, curated gateway to *Arabidopsis* biology, research materials and community. *Nucleic Acids Res* 31: 224–228.
- Richard, S.B., J.L. Ferrer, M.E. Bowman, A.M. Lillo, C.N. Tetzlaff, D.E. Cane, and J.P. Noel. (2002). Structure and mechanism of 2-*C*-methyl-D-erythritol 2,4-cyclodiphosphate synthase. An enzyme in the mevalonate-independent isoprenoid biosynthetic pathway. *J Biol Chem* 277: 8667–8672.
- Ro, D.K., N. Mah, B.E. Ellis, and C.J. Douglas. (2001). Functional characterization and subcellular localization of poplar (*Populus trichocarpa* × *Populus deltoides*) cinnamate 4-hydroxylase. *Plant Physiol* 126: 317–329.
- Sandhu, S.S., C.R. Bastos, L.E. Azini, A.T. Neto, and C. Colombo. (2002). RAPD analysis of herbicide-resistant Brazilian rice lines produced via mutagenesis. *Genet and Mol Res* 1: 359–370.
- Sattler, S.E., E.B. Cahoon, S.J. Coughlan, and D. Della Penna. (2003). Characterization of tocopherol cyclases from higher plants and cyanobacteria. Evolutionary implications for tocopherol synthesis and function. *Plant Physiol* 132: 2184–2195.

- Schepmann, H.G., J. Pang, and S.P. Matsuda. (2001). Cloning and characterization of *Ginkgo biloba* levopimaradiene synthase, which catalyzes the first committed step in ginkgolide biosynthesis. *Arch Biochem Biophys* 392: 263–269.
- Schnee, C., T.G. Kollner, J. Gershenzon, and J. Degenhardt. (2002). The maize gene terpene synthase 1 encodes a sesquiterpene synthase catalyzing the formation of (E)-farnesene, (E)-nerolidol and (E, E)-farnesol after herbivore damage. *Plant Physiol* 130: 2049–2060.
- Schomburg, I., A. Chang, and D. Schomburg. (2002). BRENDA, enzyme data metabolic information. *Nucleic Acids Res* 30: 47–49.
- Schubert, D., B. Lechtenberg, A. Forsbach, M. Gils, S. Bahadur, and R. Schmidt. (2004). Silencing in *Arabidopsis* T-DNA transformants — the predominant role of a gene-specific RNA sensing mechanism versus position effects. *The Plant Cell* 16: 2561–2572.
- Selkov, E., S. Basmanova, T. Gaasterland, I. Goryanin, Y. Gretchkin, N. Maltsev, V. Nenashev, R. Overbeek, E. Panyushkina, L. Pronevitch, E. Selkov Jr., and I. Yunus. (1996). The metabolic pathway collection from EMP: the enzymes and metabolic pathways database. *Nucleic Acids Res* 24: 26–28.
- Sewell, M.M., D.L. Bassoni, R.A. Megraw, N.C. Wheeler, and D.B. Neale. (2000). Identification of QTLs influencing wood property traits in loblolly pine (*Pinus taeda* L.). I. Physical wood properties. *Theor Appl Genet* 101: 1273–1281.
- Shimada, Y., H. Goda, A. Nakamura, S. Takatsuto, S. Fujioka, and S. Yoshida. (2003). Organ-specific expression of brassinosteroid biosynthetic genes and distribution of endogenous brassinosteroids in *Arabidopsis*. *Plant Physiol* 131: 287–297.
- Sies, H. and W. Stahl. (2004). Nutritional protection against skin damage from sunlight. *Ann Rev Nutr* 24: 173–200.
- Smolen, G. and J. Bender. (2002). *Arabidopsis* cytochrome P450 cyp83B1 mutations activate the tryptophan biosynthetic pathway. *Genetics* 160: 323–332.
- Somerville, C.R. and J. Browse. (1991). Plant lipids: mutants, metabolism, and membranes. *Science* 252: 80–87.
- Starks, C.M., K. Back, J. Chappell, and J.P. Noel. (1997). Structural basis for cyclic terpene biosynthesis by tobacco 5-epi-aristolochene synthase. *Science* 277: 1815–1820.
- Sudarsan, N., J.E. Barrick, and R.R. Breaker. (2003). Metabolite-binding RNA domains are present in the genes of eukaryotes. *RNA* 9: 644–647.
- Sumner, L.W., P. Mendes, and R.A. Dixon. (2003). Plant metabolomics: large-scale phytochemistry in the functional genomics era. *Phytochemistry* 62: 817–836.
- Szabados, L., E. Abraham, I. Kovacs, A. Oberschall, M. Alvarado, L. Zsigmond, I. Kerekes, G. Rigo, R. Nagy, I. Krasovskaja, and C. Koncz. (2002). T-DNA insertion mutagenesis: identification of tagged *Arabidopsis* genes by insert mapping and promoter trapping. *The Plant J* 32: 233–242.
- Tacket, C.O. (2005). Plant-derived vaccines against diarrheal diseases. *Vaccine* 23: 1866–1869.
- Tamagnone, L., A. Merida, A. Parr, S. Mackay, F.A. Culianez-Macia, K. Roberts, and C. Martin. (1998). The AmMYB308 and AmMYB330 transcription factors from *Antirrhinum* regulate phenylpropanoid and lignin biosynthesis in transgenic tobacco. *The Plant Cell* 10: 135–154.
- Tu, J., P. Zhu, K.D. Cheng, and J. Liu. (2004). Cloning and expression of *Taxus* acyltransferase cDNA. *Z Naturforsch [C]* 59: 755–761.
- Tuteja, J.H., S.J. Clough, W.C. Chan, and L.O. Vodkin. (2004). Tissue-specific gene silencing mediated by a naturally occurring chalcone synthase gene cluster in *Glycine max*. *The Plant Cell* 16: 819–835.
- Vogt, T. and P. Jones. (2000). Glycosyltransferases in plant natural product synthesis: characterization of a supergene family. *Trends in Plant Sci* 5: 380–386.
- Vom Endt, D., J.W. Kijne, and J. Memelink. (2002). Transcription factors controlling plant secondary plant metabolism: what regulates the regulators? *Phytochemistry* 61: 107–114.
- Walbot, V.A. (2000). A green chapter in the book of life. *Nature* 408: 794–795.
- Walker, K. and R. Croteau. (2001). Taxol biosynthetic genes. *Phytochemistry* 58: 1–7.
- Wang, J.F., H. Zhou, Y.Q. Chen, Q.J. Luo, and L.H. Qu. (2004). Identification of 20 microRNAs from *Oryza sativa*. *Nucleic Acid Res* 32: 1688–1695.
- Weckwerth, W., M.E. Loureiro, K. Wenzel, and O. Fiehn. (2004). Differential metabolic networks unravel the effects of silent plant phenotypes. *Proc Natl Acad Sci USA* 101: 7809–7814.
- Wittig, U. and A. De Beuckelaer. (2001). Analysis and comparison of metabolic pathway databases. *Briefings in Bioinformatics* 2: 126–142.

- Xiao, Y.L., M. Malik, C.A. Whitelaw, and C.D. Town. (2002). Cloning and sequencing of cDNAs for hypothetical genes from chromosome 2 of *Arabidopsis*. *Plant Physiol* 130: 2118–2128.
- Yamazaki, Y., H. Sudo, M. Yamazaki, N. Aimi, and K. Saito. (2002). Camptothecin biosynthetic genes in hairy roots of *Ophiorrhiza pumila*: cloning, characterization and differential expression in tissues and by stress compounds. *Plant and Cell Physiol* 44: 395–403.
- Yanagisawa, S., A. Akiyama, H. Kisaka, H. Uchimiya, and T. Miwa. (2004). Metabolic engineering with Dof1 transcription factor in plants: improved nitrogen assimilation and growth under low nitrogen conditions. *Proc Natl Acad Sci USA* 101: 7833–7838.
- Yaronskaya, E., V. Ziemann, G. Walter, N. Averina, T. Borner, and B. Grimm. (2003). Metabolic control of the tetrapyrrole biosynthetic pathway for porphyrin distribution in the barley mutant albostrians. *The Plant J* 35: 512–522.
- Yephremov, A. and H. Saedler. (2000). Display and isolation of transposon-flanking sequences starting from genomic DNA or RNA. *The Plant J* 21: 495–505.
- Yonekura-Sakakibara, K., Y. Tanaka, M. Fukuchi-Mizutani, H. Fujiwara, Y. Fukui, T. Ashikari, Y. Murakami, M. Yamaguchi, and T. Kusumi. (2000). Molecular and biochemical characterization of a novel hydroxycinnamoyl-CoA: anthocyanin 3-O-glucoside-6-O-acyltransferase from *Perilla frutescens*. *Plant Cell Physiol* 41: 495–502.
- Yoshioka, Y., S. Kurei, and Y. Machida. (2001). Identification of a monofunctional aspartate kinase gene of *Arabidopsis thaliana* with spatially and temporally regulated expression. *Genes and Genetic Syst* 76: 189–198.
- Zeitlin, P.L. (2000). Future pharmacological treatment of cystic fibrosis. *Respiration* 67: 351–357.
- Zhu, W., S.D. Schlueter, and V. Brendel. (2003). Refined annotation of the *Arabidopsis* genome by complete expressed sequence tag mapping. *Plant Physiol* 132: 469–484.
- Zubieta, C., X.Z. He, R.A. Dixon, and J.P. Noel. (2001). Structures of two natural product methyltransferases reveal the basis for substrate specificity in plant O-methyltransferases. *Nat Struct Biol* 8: 271–279.
- Zubieta, C., P. Kota, J.L. Ferrer, R.A. Dixon, and J.P. Noel. (2002). Structural basis for the modulation of lignin monomer methylation by caffeic acid/5-hydroxyferulic acid 3/5-O-methyltransferase. *The Plant Cell* 14: 1265–1277.

# 6

---

## *The Study of Plant Natural Product Biosynthesis in the Pregenomics and Genomics Eras*

---

Feng Chen, Leland J. Cseke, Hong Lin, Ara Kirakosyan, Joshua S. Yuan,  
and Peter B. Kaufman

### CONTENTS

6.1	Introduction .....	203
6.2	Pregenomic Strategies for Studying Plant Natural Product Biosynthesis .....	204
6.2.1	Biochemical Approach .....	204
6.2.2	Forward-Genetic Approach .....	205
6.2.3	Homology-Based Molecular Approach .....	206
6.3	Genomic Approaches for Investigating the Biosynthesis of Plant Natural Products .....	208
6.3.1	Expression Profiling and Transcriptomics .....	208
6.3.2	Proteomics .....	211
6.3.3	Metabolomics and Targeted Metabolic Profiling .....	212
6.3.4	Structural Biology and Structural Genomics .....	214
6.3.5	Integrated Functional Genomics .....	214
6.4	Systems Biology Approach to Understanding the Biology of Plant Natural Products .....	216
6.5	Conclusions .....	217
	References .....	217

---

### 6.1 Introduction

Collectively, plants produce a vast array of small molecular weight compounds. Most of these **natural products** are generally not essential for the basic metabolic processes of the plant, but are often critical to the proper functioning of the plant in relation to its environment. With at least 50,000 so far identified, the total number of such compounds in the plant kingdom is estimated to be much higher (De Luca and St. Pierre, 2000). Natural products are believed to play vital roles in the physiology and ecology of the plants that produce them, particularly as defense elements against pests and pathogens (Dixon, 2001) or as attractants for beneficial organisms such as insect pollinators (Knudsen et al., 1993) (see also Chapter 2). Because of their biological activities, some plant natural products have long been exploited by human beings as pharmaceuticals, stimulants, and poisons (Facchini, 2001). Like plants, microorganisms also make a bewildering array of natural products that are involved in the protection of the host from competing organisms, cell-to-cell communication, and gene regulation (Lamb and Wright, 2005).

During the latter half of the twentieth century, progress was made in the investigation of **natural product biosynthesis**, which particularly benefited from studies of the regiospecificity of incorporation of isotopically or radioactively labeled precursors by whole cells (Thomas, 2004). These pioneering studies established the foundation of contemporary schemes for the formation of major groups of terpenes, alkaloids, phenolics, and other secondary metabolites in plants and microorganisms. As dis-

cussed in Chapter 5, current investigations of plant natural product biochemistry aim at elucidating the molecular and biochemical mechanisms underlying natural product formation and regulation. The questions being asked include the following:

1. What are the enzymes catalyzing the formation of intermediates and final products?
2. What are the genes encoding the enzymes?
3. What are the regulatory factors that control the individual biosynthetic pathways and entire metabolic network?

Although relatively little is yet known about the molecular mechanisms responsible for the production of most plant natural products (mainly due to the complexity of plant metabolism), much progress has been made in the past few decades.

Interdisciplinary approaches, based on molecular biology and x-ray crystallography, led to rapid advances in the identification of biosynthetic genes and the elucidation of three-dimensional structures of encoded enzymes (Thomas, 2004). Besides its intrinsic scientific value, the knowledge of natural product biosynthesis is essential for providing novel tools for **plant metabolic engineering**, which is aimed at generating desirable crops for better performance against biotic and abiotic stresses, better nutrition, or the production of valuable phytopharmaceuticals (Sweetlove et al., 2003) (see also Chapter 7).

In the biological sciences, the original use of the suffix “**ome**” (from the Greek for “all,” “every,” or “complete”) was “**genome**,” which refers to the complete genetic makeup of an organism. Because of the success of large-scale quantitative biology projects, such as genome sequencing (**genomics**), the suffix “ome” has been extended to a host of other contexts. The next “ome” to become a buzzword is **proteome**, the totality of proteins (expressed genes that are translated) in an organism, and **proteomics** is now a well-established term for studying the proteome. More recently, we saw the term **metabolome** come into existence to describe the totality of metabolites in an organism; **metabolomics** is now a growing new field of research. In this chapter, we describe the various approaches employed in the study of plant natural product biosynthesis, covering both pregenomic approaches and genomic approaches.

---

## 6.2 Pregenomic Strategies for Studying Plant Natural Product Biosynthesis

Plant natural products are synthesized through a remarkably diverse suite of metabolic pathways. Extensive information on these biosynthetic pathways became available in the pregenomics age. Similar to the study of plant sciences in general, the investigation of plant natural product biosynthesis in the pregenomics era was conducted in a reductionist fashion, namely, as “one pathway, one enzyme, one gene” at a time. Biochemistry and genetics were the two major disciplines that contributed to these studies.

### 6.2.1 Biochemical Approach

The biochemical approach, as illustrated in Figure 6.1, was widely employed in the study of plant natural product biosynthesis in the pregenomics age. In this approach, the starting point is the formulation of a hypothetical scheme for the chemical transformation of candidate precursors based on a plausible reaction mechanism. The way to validate the hypothetical scheme is to detect enzymatic activity in plants, which is usually achieved through *in vitro* enzymatic assays. Once an enzyme activity is detected, the next goal is to identify the specific enzyme that catalyzes the reaction. The candidate enzymes are usually isolated through purification that involves one or multiple chromatography procedures. **Codeinone reductase** is used as an example to illustrate how the biochemical approach works.

Codeinone is an intermediate in the pathway for the formation of morphine, an important alkaloid with narcotic analgesic activity (see Chapter 1 for structures). Codeinone reductase was proposed to be a key enzyme for the transformation of codeinone to codeine (Unterlinner et al., 1999), the immediate precursor of morphine. Codeinone reductase activity was first detected from opium poppy (*Papaver somniferum*) cell suspension cultures. The enzyme was further purified to electrophoretic homogeneity.

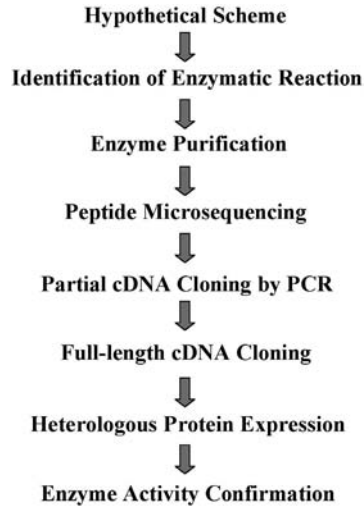
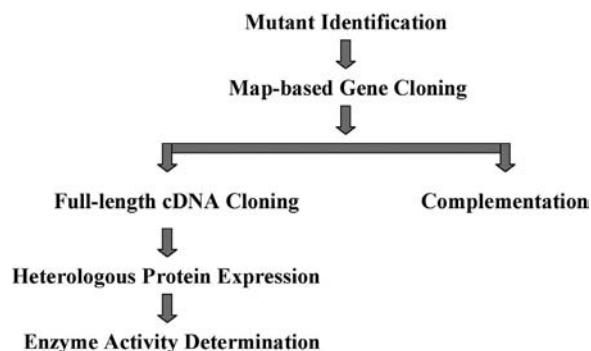

**FIGURE 6.1** A biochemical approach.

The purification procedure involved ammonium sulfate precipitation, affinity chromatography, gel filtration, and ion-exchange chromatography. The purified enzyme was subjected to **SDS-polyacrylamide gel electrophoresis (PAGE)**, and the target enzyme was digested *in situ* with **endoproteinase Lys-C**. The peptide mixture was separated by **reverse-phase high-performance liquid chromatography (RT-HPLC)**. See Chapter 8 for information on the above techniques. Seven of the peptides were microsequenced. Based on the peptide sequences, primers were designed to amplify partial cDNA of codeinone reductase gene using **reverse-transcription polymerase chain reaction (RT-PCR)** (see Chapter 5). **5'-RACE (rapid amplification of cDNA ends)** and **3'-RACE** were employed to obtain the full-length cDNA. Then the cDNA was expressed in *Escherichia coli* to produce an active enzyme that was confirmed to be codeinone reductase (Unterlinner et al., 1999). There are numerous other examples of successful gene cloning using this biochemistry-based approach. If the target protein is of low abundance or is membrane bound, however, there will be severe difficulties encountered in protein purification. As a result, the genetic approach may provide alternative opportunities for gene isolation.

### 6.2.2 Forward-Genetic Approach

In the **forward-genetic approach** (Figure 6.2), mutations are randomly introduced within the genes of an organism during development by radiation, chemical agents, or insertion sequences. This induces altered phenotypes, while the organism continues to grow or is bred to obtain the next generation. Once an altered phenotype of interest is identified, the mutation can then be used to clone the gene that causes



**FIGURE 6.2** A genetic approach.

the altered phenotype by screening for the defective gene. The *in vivo* function of the gene can then be validated by cloning the nonmutant, functional gene combined with **complementation** (putting a functional copy of the gene back into the organism with the mutation). For the plant natural products that determine phenotypic traits that are observable under certain conditions, forward-genetic approaches may prove effective in cloning the key genes involved in their biosynthesis.

The forward-genetic approach (typically considered the “classical” genetic approach) should be contrasted with the **reverse-genetic approach**. In reverse genetics, the method to discovering the function of a gene proceeds opposite to how such discoveries typically unfold in forward genetics. For reverse genetics, phenotype is the end point rather than the starting point. For example, researchers often isolate genes with functions that are completely unknown. Thus, to determine the function of such genes, researchers attempt to alter the expression of the gene within the organism (through the use of **directed mutations, transgenes, or gene silencing**) to see if it triggers an altered phenotype (see Chapters 3 and 5 for more information). Unfortunately, the reverse-genetic approach is rarely successful when searching for genes involved in the production of plant natural products, because the phenotypes are often quite subtle and difficult to identify. Thus, one of the main advantages of the forward-genetic approach is that the researcher is starting with an observable phenotype.

One example of the forward-genetic approach is the isolation of the *TT8* gene. **Flavonoids** are a group of natural products that are synthesized through the general **phenylpropanoid pathway** and determine the red, purple, and brown pigmentation of flowers, fruits, and seeds. In *Arabidopsis thaliana*, many mutants with altered seed coat color were obtained from genetic screens. Further investigation showed that many mutants are caused by mutations in the regulatory genes of the flavonoid pathway (Winkel-Shirley, 2002). The **TRANSPARENT TESTA 8 (TT8)** locus was determined to be one of the loci involved in the regulation of flavonoid biosynthesis in *A. thaliana* (Nesi et al., 2000). A novel allele, *tt8-3*, was isolated from a T-DNA-mutagenized *A. thaliana* collection. The *tt8-3* allele was tagged by an integrative molecule, which permitted the cloning and sequencing of the *TT8* gene. The *TT8* gene encodes a basic helix–loop–helix domain protein, which acts as a transcriptional factor required for expression of *DFR* and *BAN* genes in the flavonoid pathway (Nesi et al., 2000). See Chapter 2 for details on this pathway.

The genetic approach can also be used to isolate catalytic genes of plant natural products. Most of the genes coding for the enzymes of the phenylpropanoid pathway were cloned using standard biochemical approaches. However, the identification of **p-coumarate 3-hydroxylase (C3H)**, the enzyme essential for many branch pathways in phenylpropanoid metabolism in plants, was not straightforward. Over the past three decades, many investigators tried to assay, characterize, and purify C3H using biochemical approaches. As a result, many reports concerning the nature of this enzyme were published. However, there was considerable disagreement in these reports. The Chapple group took a genetic approach that led to the successful cloning of the gene encoding *A. thaliana* C3H (Franke et al., 2002). Leaves of *A. thaliana* placed under ultraviolet (UV) light fluoresce blue-green due to the presence of **sinapoylmalate**, which is derived from the phenylpropanoid pathway. When sinapoylmalate is deficient, the leaves appear red under UV light. By screening 100,000 M2 seedlings of **ethane methyl sulfonate (EMS)**-mutagenized lines, one mutant named *ref8*, which showed strong red fluorescence under UV light, was obtained. Map-based cloning was employed to clone the *REF8* gene. The cDNA of *REF8* was annotated as a putative P450. When *REF8* cDNA was expressed in *E. coli*, the enzyme produced showed C3H activity.

The forward-genetic approach relies on the availability of mutants that have an observable phenotype. However, as many natural products are not essential for plant growth and development, the disruption of their production often does not cause developmental abnormalities. Under these circumstances, the usefulness of the forward-genetic approach is limited.

### 6.2.3 Homology-Based Molecular Approach

With the accumulation of a large pool of genes that were identified as being involved in plant natural product biosynthesis, it has become evident that many enzymes in different plant species perform the same or similar biochemical functions, sharing sequence and structural similarities (Pichersky and Gang, 2000). This is not surprising, as many **homologous** (having similar sequence) and **orthologous** (having same function) genes in different plant species are believed to have originated from **common ancestor**

```

T. cuspidata DBAT 1 GATGACTACAGTCCCTTCACTTGAGCAACTACTTTTTTGTCTTCCGCTGATACAGATAATTGAGGACATCCATCCTCTGGT
T. baccata DBAT 1 GATGACTACAGTCCCTTCACTTGAGCAACTACTTTTTTGTCTTCCGCTGATACAGATAATTGAGGACATCCATCCTCTGGT
T. cuspidata TAT 1 GATGACATCAATCCATCATATTTGAGCAACTACTTTTTTGTCTTCCGCTGATACAGATAATTGAGGACATCCATCCTCTGGT
T. cuspidata TOAT 1 GATGACCTCAATCCATCATATGAACTTACTTTATGCTTCCGCTGATACAGATAATTGAGGACATCCATCCTCTGGT
T. cuspidata BAPT 1 GATAACTACAAATCCATCCGTTTCAAGCACTTATTTTTTCTCTACCAAGGATACAGATAATTGAGGACATCCATCCTCTGGT
T. media BAPT 1 GATAACTACAAATCCATCCGTTTCAAGCACTTATTTTTTCTCTACCAAGGATACAGATAATTGAGGACATCCATCCTCTGGT

T. cuspidata DBAT 81 GGTTCAGGTAACCTCGTTTTACATGTGGAGGTTTTGTTGTAGGGGTGAGTTCTCGCCATGGTATATGTGATGGACTAGGAG
T. baccata DBAT 81 GGTTCAGGTAACCTCGTTTTACATGTGGAGGTTTTGTTGTAGGGGTGAGTTCTCGCCATGGTATATGTGATGGACTAGGAG
T. cuspidata TAT 81 GTTTCAGGTAACCTCGTTTTACATGTGGAGGTTTTGTTGTAGGGGTGAGTTTCCACCATGGTATATGTGATGGACTAGGAG
T. cuspidata TOAT 81 GTTTCAGGTAACCTCGTTTTACATGTGGAGGTTTTGTTGTAGGGGTGAGTTTCCACCATAGTATATGTGATGGACCAAGG
T. cuspidata BAPT 81 GTTTCAGGTAACCTCGTTTTACATGTGGAGGTTTTGTTGTAGGGGTGAGTTTCCACCATAGTATAGTCCATGGATGCAAAAGGAT
T. media BAPT 81 GTTTCAGGTAACCTCGTTTTACATGTGGAGGTTTTGTTGTAGGGGTGAGTTTCCACCATAGTATAGTCCATGGATGCAAAAGGAT

```

**FIGURE 6.3** An example of homology-based sequence comparisons. DNA sequences of several *Taxus* species transferases were aligned using the Clustal W algorithm on the MultAlin Web site (<http://prodes.toulouse.inra.fr/multalin/multalin.html>) and the BoxShade service to color the nucleotides ([www.ch.embnet.org/software/BOX\\_form.html](http://www.ch.embnet.org/software/BOX_form.html)). Letters in black boxes indicate identical base pairs as compared to the first sequence. Letters in gray boxes indicate similar base pairs. The sequences include: *Taxus cuspidata* 10-deacetylbaccatin III-10-*O*-acetyl transferase (DBAT) mRNA; *Taxus baccata* 10-deacetylbaccatin III-10-*O*-acetyl transferase (DBAT) mRNA; *Taxus cuspidata* taxadienol acetyl transferase (TAT) mRNA; *Taxus cuspidata* taxoid-*O*-acetyltransferase (TOAT) mRNA; *Taxus cuspidata* phenylpropanoyltransferase (BAPT) mRNA; and *Taxus media* phenylpropanoyltransferase (BAPT) mRNA.

**genes** (Pichersky and Gang, 2000). It is often stated that a particular DNA or RNA sequence shares *X* percent identity with another DNA or RNA sequence. This number indicates the percentage of base pairs that are identical between the two sequences. The example shown in Figure 6.3 can be used to calculate percent identity. If the same or similar DNA sequences are present among different species, that sequence is said to have been conserved among the species.

Evolutionary conservation of a nucleotide sequence may imply that it confers a relative selective advantage to the organisms that possess it. Conservation also suggests that the sequence has functional significance. This knowledge is the foundation of homology-based cloning of genes of natural products. DNA of a known gene can be used as a probe to screen a target cDNA library, which contains representative transcripts of a given plant tissue, for gene cloning. Alternatively, if an antibody against the protein of a specific gene is available, it can be used to screen a protein expression library. PCR-based strategies have also been widely employed to clone homologous genes due to the relative ease of cloning and characterizing PCR products (see Chapter 5 for more details).

One such example is the isolation of **10-deacetylbaccatin III-10-*O*-acetyl transferase** gene, which is a key gene for the production of **Taxol**<sup>®</sup>. Taxol is one of the most effective anticancer agents and belongs to the taxoid family of natural products that are characterized by the tricyclic diterpene taxane ring system. There are at least 12 distinct enzymatic reactions involved in Taxol biosynthesis (Walker and Croteau, 2000), one of which is 10-deacetylbaccatin III-10-*O*-acetyl transferase. Based on a consensus sequence noted in a comparison of a few well-defined transferases of plant origin, **PCR primers** were designed for the 10-deacetylbaccatin III-10-*O*-acetyl transferase gene (see Figure 6.3 for an example of such a sequence comparison). A **PCR reaction** was performed using a cDNA library, which was constructed from mRNA derived from *Taxus* cell suspension cultures known to produce Taxol, as a template. The PCR fragment obtained was used as a probe to screen the same cDNA library, and a full-length **cDNA** was obtained. Further biochemical assays demonstrated that the cDNA encodes a 10-deacetylbaccatin III-10-*O*-acetyl transferase (Walker and Croteau, 2000).

A homology-based cloning method does not work well if the target gene does not share significant sequence similarity to known genes. Often, this is not a problem between even distantly related plant species if one is careful to use conserved gene regions to identify the homologous sequences. However, the problem of divergence in sequences over evolutionary time becomes more of a problem when working with sequences outside any conserved regions. It should also be noted that it is not always the case that genes with similar sequences have similar function (see Parenicova et al. [2003] for an example focusing on regulatory genes). Often, the function of a gene will diverge over time, and this can have a significant impact in shaping biochemical pathways. On the other hand, **convergent evolution**, where enzymes that perform a same biochemical function evolve independently in different plant species, also plays a significant role in shaping plant secondary metabolism (Pichersky and Gang, 2000). This is often reflected



in the protein amino acid sequence or DNA sequence levels, where there is no sequence similarity. In this case, other methods must be pursued toward gene cloning.

---

### 6.3 Genomic Approaches for Investigating the Biosynthesis of Plant Natural Products

Automated nucleotide sequencing fundamentally changed the study of biology. The development of many large-scale sequencing programs led to the generation of a wealth of information on DNA sequences from various organisms. This led to an entirely new field of research called genomics. **Genomics** is the study of all the nucleotide sequences, including structural genes, regulatory sequences, and noncoding DNA segments within all the chromosomes of an organism. Genomics appeared in the 1980s and took off in the 1990s with the initiation of genome projects for several species. The first genome to be sequenced in its entirety was that of **bacteriophage  $\phi$ -X174** (5,368 kb) in 1980. The first free-living organism to be sequenced was that of *Haemophilus influenzae* (1.8 Mb) in 1995, and since then, genomes are being sequenced at a rapid pace. In plants, the genome of the model plant species, *Arabidopsis thaliana*, was completed at the end of 2000, and the sequencing of the genome of poplar trees (*Populus trichocarpa*) was completed in 2005. While investigators previously examined the effects of treatments on individual genes or proteins, the new sequence collections along with newly engineered technologies, such as DNA microarrays currently allow for the analysis of thousands, if not all, of the genes or proteins within a cell or tissue.

The primary challenge in this field of work is how to deal with the huge amounts of sequence information that can now be obtained relatively easily. One way to derive knowledge from such biological data is to use **bioinformatics**, which is defined as the application of computer technology to the management of biological information. Bioinformatics is a fast-evolving branch of biology and is highly interdisciplinary, including biological, chemical, mathematical, and computer sciences. It has many practical applications in different areas of biology. In genomic studies, bioinformatics is important for gene function annotation. By performing sequence comparisons using bioinformatics tools, a large proportion of the genes obtained in the sequencing programs can be assigned with a putative function. However, the determination of the existence of genes, either with a putative function or unknown function, is just the first step in genomic studies. The more challenging task is to determine the biochemical and cellular functions of the genes, and various genomic approaches have been or are being developed and employed to meet this challenge. These include RNA expression profiling (**transcriptomics**), protein identification and expression profiling (**proteomics**), and metabolite identification and production profiling (**metabolomics**). Phytochemists also realized the great potential of genomic approaches and are employing these techniques to explore complex metabolic pathways in plants.

#### 6.3.1 Expression Profiling and Transcriptomics

One of the most important genomic approaches is global gene-expression profiling. If the goal of gene-expression profiling is to identify the relative levels of all transcripts in the cell, or **transcriptome**, it is called **transcriptomics**. The **expressed sequence tag (EST)**-based approach was the earliest approach used for large-scale expression profiling. Expressed genes can be sequenced from a range of cDNA libraries that are made from developmentally specific plant tissues. Biological functions of these ESTs can first be derived from a comparative analysis of their relative expression abundance in different samples as well as from bioinformatic studies based on their sequence similarity to genes of known function. There are many examples of using EST-database-based approaches for studying natural product biosynthesis. One such example is the identification of the **benzoyl-coenzyme A (CoA):benzyl alcohol benzoyl transferase (BEBT)** gene, which encodes an enzyme responsible for the production of **benzyl benzoate**, a floral scent component in *Clarkia breweri* (D'Auria et al., 2002). In this study, a cDNA library was first constructed using *C. breweri* flower tissue, where BEBT enzyme activity was detected. From the cDNA library, 750 ESTs were randomly generated, and one EST, showing a sequence similarity

to known **acyl transferases**, was identified. A full-length cDNA for the EST was then cloned and expressed in *E. coli*. The enzyme produced was verified to have the BEBT activity. (See Chapter 2 for more information on *C. breweri* studies.)

Another large-scale gene-expression profiling technique is **cDNA-AFLP** (Breyne et al., 2002). In this technique, RNAs extracted from different plant tissues are first synthesized into double-strand cDNAs, which are then subjected to digestion with different combinations of restriction enzymes (enzymes that cut DNA only at specific sequences). The digested products are screened through a series of selective PCR amplifications. Accurate gene profiles are determined by quantitative analysis of band intensities. In addition to cDNA-AFLP, several other PCR-based techniques, such as **differential display** (a PCR-based technique designed to identify differentially expressed genes), are also available for **global gene-expression profiling** (Goossens et al., 2003; Cseke et al., 2004). The EST approach using large-scale cDNA library sequencing can be expensive and time consuming. In comparison, PCR-based gene profiling approaches are selective; however, they are technically challenging and less quantitative.

In October 1995, two papers published in the same issue of *Science* profoundly transformed the field of functional genomics and transcriptome studies (Schena et al., 1995; Velculescu et al., 1995). Global gene-expression profiling techniques designated as **microarray** and **serial analysis of gene expression (SAGE)** were described. Microarray technology experienced unprecedented advancements in the past decade. It has become the predominant approach used for transcriptome studies. Currently, there are two major microarray platforms — **Affymetrix** and **printed microarray**. The Affymetrix microarray is composed of millions of oligonucleotide probes, each 15 to 25 bps and designed to hybridize to a specific part of a transcript. These probes are synthesized *in situ* on the array using a printing process called photolithography that results in every microarray having up to 500,000 individual probe cells, each of which contains millions of identical DNA molecules.

To analyze such an array (also called a **chip**), RNA is isolated from biological samples and labeled with a fluorescent tag. When presented to the microarray, the labeled RNA will hybridize to the complementary probe sequences on the microarray. Because there are millions of oligos for each probe sequence, the amount of labeled RNA that sticks in a given probe cell corresponds to the amount of RNA in solution. When the hybridized array is scanned by a laser, the fluorescent tagged fragments glow, producing spots with brightness proportional to the amount of RNA that has hybridized. The array image is recorded by a camera and processed by computer to produce numerical expression levels for the different genes. Differential gene expression from different biological samples can then be assessed by comparing the fluorescent signals from different slides with proper normalization. The advantage of Affymetrix is its power to discriminate single nucleotide differences between the sequences (Chee et al., 1996). This allows it to be used in whole genome single nucleotide polymorphism (SNP) analysis (Fan et al., 2000).

The printed microarray platform, as first developed in Pat Brown's lab at Stanford (Schena et al., 1995), involves printing either cDNAs or long-oligos ranging from 50 to 95 bps in length on glass slides, where they are covalently linked using UV light. Once created, the microarrays are processed in a manner similar to the methods above, where they are hybridized with target RNAs from two different samples labeled with different dyes. The ratio of the signals between the two samples (usually one control and one experimental sample) indicates the relative abundance of the transcripts between the samples (see Figure 6.4 for an example). From such analyses, a comprehensive view of transcriptome differences among samples can be generated. This allows for an in-depth characterization of plant biological processes at the transcript level (Stoughton, 2005). This method of microarray preparation and analysis gained a great deal of favor in the past few years.

**SAGE** is another approach to quantifying global gene expression changes. As a sequencing-based technique, SAGE is different from microarray in that the latter requires prior knowledge of the sequences to be analyzed. In SAGE, cDNAs, with sequences that are unknown, are digested with a number of enzymes to create fragments about 12 to 14 bps in length. These are then ligated and sequenced. The frequencies of these fragments in the chimeric sequences represent the frequencies of the mRNAs in the population. Many factors need to be taken into consideration when choosing an appropriate approach for global gene-expression profiling. If enough resources are available for large-scale sequencing, the SAGE approach can render more quantitative data than the microarray approach. Otherwise, microarray technology is relatively cost effective and technically less challenging.

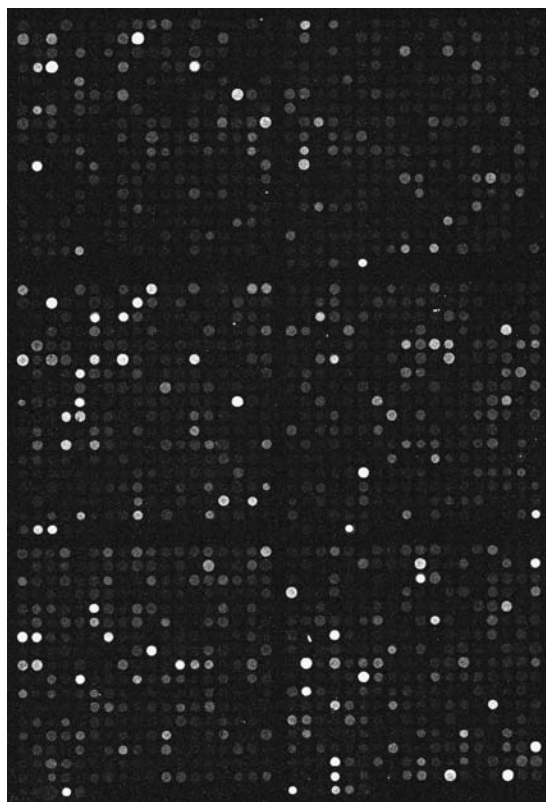

**FIGURE 6.4** An example of a scanned printed microarray. Each spot represents a single gene, and the brighter the spot, after hybridization to labeled probe, indicates a more abundant transcript. This is only a small region of the entire slide, and a single slide can contain as many as 60,000 individual genes.

An early example of using microarray to study plant natural product biosynthesis comes from the isolation of a flavor biosynthetic gene, **alcohol acyltransferase gene (SAAT)**, in strawberry (Aharoni et al., 2000). Strawberry flavor is determined by several hundred compounds that can be categorized into several classes: acids, **aldehydes, ketones, alcohols, and lactones**. To identify flavor biosynthetic genes, Aharoni and co-workers (2000) used a cDNA microarray technology. To create the array, 1701 **cDNA clones** from strawberry and 480 from petunia were spotted on a glass slide. By comparing expression of the cDNAs in the fruits at different stages of development, a cDNA that showed 16-fold higher expression in ripening fruits as compared with nonripened fruits was identified. Further biochemical analysis showed that the cDNA, which was named *SAAT*, encodes an active enzyme that has maximal activity with aliphatic medium-chain alcohols as substrates, with corresponding esters that are the major volatile components of the strawberry flavor.

Global gene-expression profiling techniques have also been used to understand the regulation of plant natural product biosynthesis. One such example comes from the work of Reymond and co-workers (2000), who developed a small microarray of 150 PCR-amplified ESTs in *A. thaliana* to profile the genes that are regulated by wounding and herbivory. One finding from this pioneering work is that the induction of several families of metabolic genes is coordinated upon physical **wounding (abiotic stress)** and **insect herbivory (biotic stress)**. The concerted induction of genes involved in natural product biosynthesis, including genes of the phenylpropanoid pathway (*CHS*, *CCR*, *4CL*, *COMT*, and *PAL*), tryptophan pathway (*ASAI*, *ASB*, *TAS*, and *TSB*), and jasmonate pathway (*FAD7*, *LOX2*, and *AOS*), suggest that natural products derived from these three pathways play important roles in plant responses against biotic and abiotic stresses (Reymond et al., 2000). While this is a relatively simple example, the completion of the *Arabidopsis* genome sequence is now allowing researchers to examine the behavior

of all the genes within this plant on commercially available microarrays containing up to 60,000 spots. Such technology is soon to follow in other plant species.

Global gene-expression profiling techniques provide revolutionary platforms for gene function studies. However, all of these approaches are highly dependent on proper statistical analysis, and the experimental design needs to be scrutinized before beginning any such studies (Churchill, 2002; Cui and Churchill, 2003; Cui et al., 2005). While studies at the transcriptional level generate a wealth of important information, changes observed in the transcriptome cannot be simply translated into the changes observed in the proteome due to the complicated processes of translation regulation, protein modification, and protein degradation. In other words, the changes at the transcript levels do not necessarily lead to corresponding changes at the protein levels. Therefore, proteomics is another important genomic approach that may contribute significantly to the investigation of complex biological systems (Rose et al., 2004), including biosynthesis and regulation of plant natural products.

### 6.3.2 Proteomics

**Proteomics** seeks to provide information regarding protein identity, expression levels, modifications, and interactions in the cell at a global level. As a vaguely defined new field, proteomics platforms include a variety of technologies. These include **two-dimensional polyacrylamide gel electrophoresis (2D-PAGE)** (see also Chapter 8), **mass spectrometry (MS)** (see also Chapter 9), **protein arrays** (using antibodies as probes), and **yeast two-hybrid array** systems to study **protein–protein interactions** (Kersten et al., 2002). Just as with transcriptomics, proteomics approaches must often account for large amounts of both biological and non-biological sources of error. Therefore, careful attention must be given to experimental design, implementation of the experiment, as well as interpretation of the data (Kim et al., 2004). In this chapter, we will concentrate on the application of 2D-PAGE and MS to proteomic studies.

2D-PAGE is not a novel approach. However, it has gained a renaissance in the genomics era. As invented more than 20 years ago, this technique separates proteins in the first dimension according to **protein isoelectric points** using **isoelectric focusing (IEF)**, and in the second dimension, according to molecular size using **sodium dodecyl sulfate polyacrylamide gel electrophoresis (SDS-PAGE)** (see Figure 8.24 in Chapter 8). 2D-PAGE is desirable due to its high efficiency in resolving different proteins and its capacity to perform protein quantification. Recent studies showed that up to 10,000 proteins in a species can be resolved in a single gel, making 2D-PAGE a powerful tool in proteomics experiments (de Hoog and Mann, 2004). After being resolved by 2D-PAGE, protein identities, modifications, and protein–protein interactions can be studied using various MS techniques. In addition to 2D-PAGE, other methods, such as **nanoflow high-pressure liquid chromatography (HPLC)**, **two-dimensional chromatography**, and a variety of **capillary electrophoresis** techniques are also available for protein separations (see Chapter 8).

A **mass spectrometer** is composed of an ionization source, a mass analyzer, and a detector. Based on the principles of MS, a mass spectrometer has four functions: ionization, separation of ions based on mass, measurement of mass, and measurement of abundance. There are many different ionization techniques (Newton et al., 2004) (see Chapter 9 for more details). The development of soft ionization techniques, particularly **matrix-assisted laser-desorption ionization (MALDI)** and **electrospray ionization (ESI)**, has made it possible for biologists to take advantage of mass spectrometers to analyze large molecules such as proteins. In MALDI, proteins or peptides are first crystallized with matrix molecules and spotted on a plate. A laser pulse then brings the protein with the matrix into an ionized gas phase, which will normally give singly charged ions. In contrast, ESI uses high voltage to generate ions that form an aerosol of charged liquid droplets. One advantage of ESI lies in its capability to analyze noncovalent complexes. After ionization, the proteins or peptide fragments are sent to the mass analyzer for separation to resolve the ions formed in the ionization source according to their mass-to-charge ratios. The popular mass analyzers include **quadrupole**, **time-of-flight (TOF)**, **Fourier transform ion traps**, and **quadrupole ion traps** (see Chapter 9 for details on these). The mass spectrometers used in proteomic studies normally have more than one mass analyzer coupled to the equipment. This allows for high-resolution peptide sequencing. The so-called tandem mass spectrometers can be composed of different

combinations of mass analyzers, including **quadrupole-quadrupole**, **quadrupole-TOF**, **TOF-TOF**, or **MALDI-TOF mass spectrometry** (see Kim et al., 2004).

In a typical proteomic analysis, a protein mixture is first resolved using 2D-PAGE. The proteins of interest are then excised from the gel. The gel containing the proteins of interest is dissolved, and the proteins are often digested by the action of proteolytic enzymes or mild hydrolysis to denature the peptides. The sample is then prepared for mass spectrometry (by spotting onto a MALDI target plate, for example) and subjected to MS for **peptide fingerprinting**. The peptide mass fingerprint and resulting sequence data will then be used to search against a protein database to identify the gene that produced the protein of interest. With recent improvements in mass accuracy, mass resolution, and the sensitivity of the equipment, very small amounts of proteins and peptides in the picomol to femtomol range can be rapidly identified if matching genomic sequence data are available (van Wijk, 2001).

Another development in proteomics technology has been in **fluorescent dyes** that are covalently linked to the proteins in two different samples (i.e., control versus experimental samples) (Unlu et al., 1997). This method is similar to the use of two dyes on microarrays, except the two sets of labeled proteins are run on a single two-dimensional gel instead of being spotted. Because the same protein in two different samples migrates with itself, differences in the two-dimensional location on the gel that may be due to variation between gels are eliminated. This allows the same protein to be compared directly in two different samples and can help to identify differences in post-translational modifications by searching for differences in the migration of the different fluorescent tags. In addition, some newly developed techniques make it possible to profile a protein mixture without employing a separation process. For example, a protein mixture can be applied directly to **Fourier-transform ion cyclotron mass spectrometry (FTMS)** for protein identification and quantification. Such techniques may revolutionize proteomic studies (Smith, 2000).

Despite its enormous potential, plant proteomics is still in its infant stage of development and is still facing many technical challenges. The proteome is much more complex than the transcriptome, involving not only the issue of expression levels but also the issues of many possible protein locations within each cell, post-translational modifications, and protein degradation. Another challenge involves **dynamic range** (van Wijk, 2001), which defines the concentration boundaries of an analytical determination over which the instrumental response is linear (Threthewey, 2002). As proteomes contain both high-abundant and low-abundant proteins, when large proteomes consisting of thousands of proteins are analyzed, the dynamic range could be limited. As a result, only the highly abundant proteins are detected. This can be improved through the use of fluorescently tagged proteins or by fractionating a proteome into smaller subfractions (van Wijk, 2001). Another significant problem for the dynamic range involves **hydrophobic membrane proteins**. These proteins tend to aggregate. When a low amount of such protein is analyzed, significant losses could occur. Novel extraction and separation procedures for hydrophobic membrane proteins still need to be developed. Despite these challenges, proteomics provides a new dimension to the study of complex biological systems. With regard to the study of plant natural products, proteomic studies can complement transcript profiling and provide novel information for identifying critical factors involved in plant natural product biosynthesis.

### 6.3.3 Metabolomics and Targeted Metabolic Profiling

**Metabolites** are organic compounds that are starting materials, intermediates, or end-products of metabolism. When it comes to natural products, they often represent the end-products of gene expression and enzymatic activity, and when taken as a whole for an organism, they make up the metabolome. Quantitative and qualitative measurements of all kinds of cellular metabolites, or **metabolomics**, can yield a global view of the biochemical phenotype of an organism. This can be used to differentiate phenotypes and genotypes at a metabolite level that may or may not produce visible phenotypes (Sumner et al., 2002). Due to the diversity of plant metabolites, it is generally accepted that there is no single analytical method that can provide sufficient visualization of the entire **metabolome**. Therefore, the methods of **metabolic profiling** must provide a compromise between the breadth of the metabolites that can be measured and the quality of the measurement (Sumner et al., 2002). Multiple technologies are, therefore, needed to measure the entire metabolome of a given biological sample.

**Large-scale metabolic profiling** in plants was first conducted with potato tuber (*Solanum tuberosum*), from which 150 compounds were simultaneously detected using **gas chromatography (GC)/MS** (Roessner et al., 2000). Using a similar approach, Oliver Fiehn (2002) detected 326 compounds in *A. thaliana* extracts and could assign a chemical identity to about half of them. While GC/MS is perhaps the most widely used platform for metabolic profiling, it is suitable only for volatile compounds or those compounds that can be volatilized by derivitization. **Liquid chromatography/MS (LC/MS)** is suitable for the analysis of chemicals of different properties. Recently, LC/MS was used to simultaneously detect sugars, amino acids, and some glycosides in phloem exudates of *Cucurbita maxima* (Tolstikov and Fiehn, 2002). More recently, von Roepenack-Lahaye and co-workers (2004) reported on the use of capillary LC coupled to ESI quadrupole TOF MS to profile *A. thaliana* metabolites. About 2000 different mass signals were detected in extracts of *A. thaliana* roots and leaves. Many of these originate from *A. thaliana* secondary metabolism. Finally, **nuclear magnetic resonance (NMR)** spectroscopy is becoming a powerful tool in the simultaneous analysis of many different compounds, and coupled **LC-NMR** has recently made some stunning advances in the analysis of natural products (Bringmann et al. 2002; Glaser et al., 2003; Xiao et al., 2004). For more information on separation techniques, see Chapter 8. For more information on the use of MS and NMR in the analysis of compounds, see Chapter 9.

**Fourier-transform ion cyclotron mass spectrometry (FTMS)** is also noteworthy in the analysis of metabolites. FTMS is different from the above-described profiling techniques in that it does not require chromatography, and it has also been used for metabolic profiling. The application of this technique to the study of plant metabolomics was first demonstrated by Aharoni and co-workers (2002). They used FTMS to profile metabolites in strawberry (*Fragaria chiloensis*) fruits and reported 5844 different masses and assigned putative chemical formulas to more than half of them. In the FTMS metabolic profiling, separation of the metabolites was achieved by ultra high mass resolution. Identities of the metabolites were determined by analyzing the elemental composition of the metabolite based on accurate mass determinants. Relative quantification was obtained by comparing the absolute intensities of each mass using internal calibration. The reported results showed variations in both primary metabolites and secondary metabolites in the various strawberry tissues (Aharoni et al., 2002).

Most metabolomic approaches seek to profile metabolites in a nontargeted way — to reliably separate and detect as many metabolites as possible in a single analysis (von Roepenack-Lahaye et al., 2004). This is technically challenging due to the diverse chemical properties of the metabolites. In contrast, selective profiling of a certain group of compounds, which is also called **targeted metabolic profiling**, is relatively easy to perform. For example, Schemelz and co-workers (2003) reported a profiling technique that can be used to simultaneously analyze multiple **phytohormones**. In their method, plant tissue is extracted with aqueous **1-propanol** and mixed with **dichloromethane**. Carboxylic acids present in the organic layer were methylated, and analytes were volatilized with application of heat, collected on a polymeric absorbent, and eluted with solvent into a sample vial. Analytes were separated by GC and quantified by using chemical-ionization MS. The levels of phytohormones, including **abscisic acid**, **indole-3-acetic acid**, **salicylic acid**, and **jasmonic acid**, were simultaneously identified and quantified. This method was used in phytohormone profiling with several plant species, including *A. thaliana*, corn (*Zea mays*), tomato (*Lycopersicon esculentum*), and tobacco (*Nicotiana tabacum*).

Another example of targeted metabolic profiling comes from the study of biosynthesis of volatiles in *A. thaliana* flowers (Chen et al., 2003). *A. thaliana* flowers have no smell to the human nose. However, when a highly sensitive closed-loop stripping system, designed to specifically collect headspace volatile compounds, was employed, a large number of **volatile terpenoids** were identified from *A. thaliana* flowers. In this particular study, a nontargeted metabolomic approach would not be as effective as the headspace approach that targets only volatiles, because the volatile compounds would be masked by more highly abundant compounds.

Similar to proteomics, a major challenge to metabolomics is the dynamic range. Serial extraction and parallel analysis are important for a comprehensive analysis of the metabolome, but highly abundant compounds can often mask the presence of compounds in low abundance, which usually require various separation techniques prior to chemical analysis. While metabolomics can generate a large amount of information about the types and amounts of compounds produced by a given plant, it is also important to facilitate the comparison of results between laboratories and experiments and to enhance the integration

of metabolic data with other functional genomic information (Bino et al., 2004). With respect to plant natural product biosynthesis, metabolic profiling is an essential component of such studies, as it provides a chemical basis for the identification and characterization of the biochemical pathways within different species and within specific tissues.

### 6.3.4 Structural Biology and Structural Genomics

**Structural biology** provides an important tool for the characterization of proteins at the atomic level. By elucidating the mechanisms of individual biosynthetic reactions, a more complete appreciation of complex biosynthetic networks can be achieved. In recent years, significant advances were made in structural studies on natural product biosynthetic enzymes, in which the **three-dimensional structures** of several types of enzymes pertaining to biosynthesis of natural products were solved. One such example is the elucidation of the three-dimensional structure of plant ***O*-methyl transferases**. **Methylation** is involved in the formation of almost all types of metabolites and is, therefore, an essential biochemical reaction for all living organisms. Depending on where the methylation occurs, methyl transferases can be divided into groups that include **oxygen (O)-, nitrogen (N)-, carbon (C)-, or sulfur (S)-methyl transferases**. The genes encoding these enzymes are very diverse. Even within the group of *O*-methyl transferases, many members do not share detectable sequence similarity, suggesting that convergent evolution played a significant role in shaping the *O*-methyl transferase superfamily (Ibrahim and Muzac, 2000). Structural biology, under these circumstances, presents a unique opportunity for understanding the catalytic mechanisms of the enzymes and their evolution. By solving the three-dimensional structures of several *O*-methyl transferases, the molecular basis for substrate diversification within and between *O*-methyl transferase families is now much better understood (Zubieta et al., 2001; Noel et al., 2003).

Another application of structural biology is functional annotation. Evolution has produced families of proteins with members that share the same three-dimensional architecture and frequently have detectably similar sequences. Using the known three-dimensional structure as a scaffold, the functional characteristic, such as substrate specificity, of novel but related enzymes can be assessed. For instance, the discovery of **indole-3-acetic acid methyl transferase (IAMT)** in *A. thaliana* was partly due to the structural information provided from *C. breweri* **salicylic acid methyl transferase**, which belongs to the same protein family as *A. thaliana* IAMT (Zubieta et al., 2003).

**Structural genomics** is a newly developed concept. It aims to provide an experimental or computational three-dimensional model structure for all of the tractable macromolecules that are encoded by complete genomes (Brenner, 2001). Currently, pilot centers worldwide are exploring the feasibility of large-scale structure determinations using **x-ray crystallography** and **nuclear magnetic resonance (NMR) spectroscopy** (see Chapter 9). The experimental structures and computational models established will provide important insights into the molecular functions and mechanisms of thousands of proteins, which in turn, will facilitate gene annotations and functional determination of new gene products discovered in the genomic sequencing efforts, including the genes coding for enzymes of plant natural product biosynthesis. In addition, structural biology studies will open up possibilities for structure-based rational design of enzymes involved in natural product formation. Transgenic plants could then be used to express such enzymes, allowing the production of novel plant natural products for various purposes.

### 6.3.5 Integrated Functional Genomics

Individual genomic approaches are powerful in order to gain specific types of biological information concerning a complex biological system. However, their full potential will not be realized until multiple approaches are integrated. For instance, transcriptomic and proteomic approaches were criticized for their lack of ability to assign gene function. Increases in the mRNA messages do not always correlate with an increase in protein levels, and once translated, a protein may or may not be active, depending on post-translational modifications. Integrated functional genomics aims to determine gene function on a large scale through the correlation of various genomic studies. The conceptual framework for an integrated functional genomic approach to plant natural product biosynthesis is illustrated in Figure 6.5.

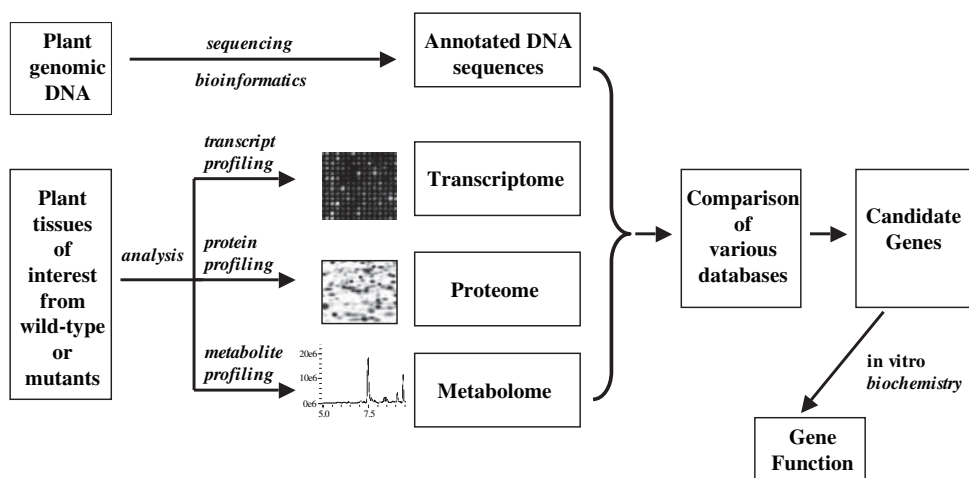

FIGURE 6.5 An integrated functional genomics approach.

In this approach, databases from individual genomic analyses, including genomics, expression profiling, proteomics, and metabolic profiling, are generated during the course of the study. In order to store and retrieve the large data sets in the regional databases, high-performance computers are required, and analysis of the data sets used to obtain biological information is just as important as performing wet genomic analyses.

A new term, **computational functional genomics**, was coined for such analyses (Mendes et al., 2002), for which many new tools remain to be developed. Individual databases are analyzed and clustered for cataloging the genes into particular cellular processes. Correlation analysis between different databases can yield a relatively small number of candidate genes for a particular function. One significant advantage of integrated functional genomic analyses is that confidence is gained at multiple levels. One recent review discussed in depth the use of integrated genomic approach for the identification of enzymes and their substrates and products (Friedman and Pichersky, 2005).

The starting point of **integrated functional genomics** is to choose certain biological materials that would be expected to reveal useful biological information. The biological materials could be developmentally or environmentally specific tissues of wild-type plants, or mutants. As a matter of fact, mutants are playing a more and more important role in genomic studies. Many methods were developed for generating mutations (see Chapter 5). One of them is insertion mutation using **T-DNA-** or **transposon-tagging**. This has been particularly successful in model species. For example, T-DNA-tagged mutant populations that nearly saturate the entire genome of *A. thaliana* were constructed (Alonso et al., 2003). This provides a unique opportunity for studying the function of almost every single gene in the *A. thaliana* genome.

In contrast to T-DNA insertion mutagenesis, which results in **loss-of-function mutants**, **gain-of-function mutants** can be generated by the use of a recently developed **activation-tagging** strategy (Weigel et al., 2000). Activation tagging utilizes a transformation vector that contains a multimeric series of plant virus transcriptional enhancers (Xia et al., 2002), such as **tobacco mosaic virus (TMV) 35S enhancer**. When the enhancers are inserted near a gene, they can induce the expression of the gene constitutively. As a consequence, a dominant mutation is generated. Because many plant natural products are not produced under normal growing conditions or produced at a low level, activation-tagging lines are particularly valuable in elucidating the function of genes coding for enzymes involved in the production of such plant natural products.

One consequence of correlating various genomic analyses is the identification of candidate genes that are potentially involved in the production of certain natural products. To determine the *bona fide* biochemical function of the candidate genes, *in vitro* biochemical assays need to be performed. The establishment of large-scale biochemical assays is, therefore, another important element of studying



plant natural product biosynthesis in the genomics age. One example of utilizing large-scale biochemistry for functional identification is a study of *A. thaliana* glycosyltransferase genes. **Glycosyltransferases** catalyze the transfer of sugar from nucleoside diphosphate donors to a wide range of acceptor molecules. Bioinformatic analysis reveals that the *A. thaliana* genome contains a large glycosyltransferase gene family (Li et al., 2001), which is in agreement with the fact that many phytochemicals, including many natural products, are present in glycosylated forms. One of these phytochemicals is salicylic acid, which is a signaling molecule in plants important for **systemic acquired resistance (SAR)**, a defense mechanism against pathogens (Lee and Raskin, 1998). **Glycosylation** is an important reaction for maintaining the **homeostasis** of salicylic acid. Thus, to identify the salicylic acid glycosyltransferase in *A. thaliana*, a high-throughput biochemical approach was employed. Ninety cDNAs of glycosyltransferase genes were cloned and expressed in *E. coli* to generate active enzymes. Salicylic acid and a few other related compounds were systemically tested as substrates with individual enzymes (Lim et al., 2002). Using this approach, salicylic acid glycosyltransferase from *A. thaliana* was successfully identified. A large-scale biochemical approach typically involves multiple members of a protein family, or even multiple protein families, and an assortment of chemical substrates.

Thus, in addition to providing more reliable information on plant natural product biosynthesis, the large data sets generated through integrated functional genomic studies can be used to establish models that can explain or even predict the nature of gene expression reprogramming in response to developmental or biotic and abiotic signals at the transcription, translation, and metabolite levels.

---

## 6.4 Systems Biology Approach to Understanding the Biology of Plant Natural Products

**Plant systems biology** is an exciting new area of plant sciences that provides a novel opportunity for understanding how natural products are involved in the biology and survival of a given plant. The concept of systems biology was developed in the 1960s and 1970s. Its basic proposition is that the biological systems should be analyzed as a whole, rather than studying isolated parts of a cell or organism (Ideker, Galitski, and Hood, 2001). Systems biology approaches the study of biological systems by systemically perturbing them (biologically, genetically, or environmentally). During the process, the approach continuously monitors the gene, protein, metabolite, and informational pathway responses, and then integrates the data (Ideker et al., 2001). The ultimate goal of systems biology is to formulate mathematical models that describe the structure of the system and its responses to individual perturbations (Ideker et al., 2001). Despite the power of its great promise, systems biology is still in its infancy regarding its application to studies of plant molecular, cellular, and developmental biology. The recent development of plant systems biology is driven by two advances: (1) the completion of whole genome sequencing for plant species, such as *A. thaliana* and rice (*Oryza sativa*), and (2) the ease of performing genetic manipulation of such species in a high-throughput mode.

Two recent publications in *Proceedings of the National Academy of Sciences USA* (PNAS) provide good examples of such a systems biology approach to the study of plant metabolic networks. The first report (Goossens et al., 2003) concerned secondary metabolism in tobacco cells, in which cDNA-AFLP transcript profiling in combination with targeted metabolic profiling was employed to investigate the biosynthesis of nicotine alkaloid following methyl jasmonate treatment. A transcriptome of nearly 600 genes regulated by **methyl jasmonate** was investigated for its role in metabolism reprogramming. Increases in the production of **nicotine alkaloids** were found to be correlated with five nicotine pathway enzymes that were upregulated by methyl jasmonate treatment. Besides alkaloids, the production of **phenylpropanoids** was also examined, which showed a similar correlation between the shift of metabolite biosynthesis and molecular reprogramming of metabolic enzymes. The second study analyzed plant global responses under sulfur nutritional stress by integrating **DNA microarray gene profiling** and **FTMS-based metabolite profiling** (Hirai et al., 2004). Large-scale data were handled by proper **data mining** tools and a **self-organizing map (SOM)**. The authors presented a comprehensive picture of regulation of plant metabolism related to sulfur nutrition and identified key pathways for metabolic

regulation. Both studies demonstrated the usefulness of a systems biology approach in studying the metabolic networks of a complex plant system.

Model plant species that can be easily manipulated via a genetic approach will be particularly useful for studying natural products using a systems biology approach. A large number of genes potentially involved in natural product biosynthesis in *A. thaliana* (*Arabidopsis* Genome Initiative, 2001) and rice (*Oryza sativa*) (Goff et al., 2002) were identified through genome sequence analysis. This information suggests that these two model species possess the capability of producing a large number of natural products previously unknown to phytochemists. Metabolomic studies will reveal what natural products are produced in these two plant species, and integrative functional genomics will elucidate the biochemical pathways responsible for their biosynthesis. Moreover, systems biology is expected to uncover the biological functions of those natural products in the two species, and similar approaches are being applied to additional plant species (such as *Populus trichocarpa*) as their genome information becomes available.

---

## 6.5 Conclusions

Plants elaborate a vast array of natural products, many of which have evolved to confer selective advantages to the host plant in ecological interactions. These natural products are synthesized through a diverse network of biochemical pathways, most of which belong to secondary metabolism. The elucidation of these biochemical pathways has been a challenging undertaking. It requires the use of advanced tools from the disciplines of analytical chemistry, biochemistry, molecular biology, and plant physiology. Before the advent of genomics, biochemical and genetic approaches were the two approaches employed in the study of plant natural product biosynthesis. In the genomics era, various genomic approaches, including transcriptomics, proteomics, and metabolomics, have become available. Like the study of general plant biology, the study of plant natural products in the genomics age is undergoing a paradigm shift from reductionist analysis to global analysis. The staggering amount of information that can be generated by these techniques has thus required the integration of computer and mathematical sciences to allow for the efficient manipulation of the data. The biosynthesis of plant natural products in several plant species, such as *A. thaliana*, rice, and *Medicago truncatula*, which is a close relative of alfalfa, is currently being investigated at the global level and in a high-throughput mode. In addition to facilitating the investigation of natural products biosynthesis, the employment of various genomic approaches to the study will lead to the generation of large data sets, which can serve as a basis for using systems biology to understand the biological function of plant natural products. The elucidation of plant natural product biosynthesis will provide novel information for understanding the biology, ecology, and evolution of plants. Such investigations may also provide tools for predictive metabolic engineering to improve plant traits that are determined by natural products.

---

## References

- Aharoni, A. et al. (2000). Identification of SAAT gene involved in strawberry flavor biogenesis by use of DNA microarrays. *Plant Cell* 12: 647–661.
- Aharoni, A., C.H. de Vos, H.A. Verhoeven, C.A. Maliapaard, G. Kruppa, R.J. Bino, and D.B. Goodenowe. (2002). Non-targeted metabolome analysis by use of Fourier Transform Ion Cyclotron Mass Spectrometry. *OMICS* 6: 217–234.
- Alonso, J.M. et al. (2003). Genome-wide insertional mutagenesis of *Arabidopsis thaliana*. *Science* 301: 653–657.
- Arabidopsis* Genome Initiative. (2001). Analysis of the genome sequence of the flowering plant *Arabidopsis thaliana*. *Nature* 408: 796–815.
- Bino, R.J. et al. (2004). Potential of metabolomics as a functional genomics tool. *Trends Plant Sci* 9: 418–425.
- Brenner, S.E. (2001). A tour of structural genomics. *Nat Rev Genet* 2: 801–809.

- Breyne, P., R. Dreesen, K. Vandepoele, L. De Veylder, F. Van Breusegem, L. Callewaert, S. Rombauts, J. Raes, B. Cannoot, G. Engler, D. Inzé, and M. Zabeau. (2002). Transcriptome analysis during cell division in plants. *Proc Natl Acad Sci USA* 99: 14825–14830.
- Bringmann, G., M. Wohlfarth, H. Rischer, J. Schlauer, and J. Brun. (2002). Extract screening by HPLC coupled to MS–MS, NMR, and CD: a dimeric and three monomeric naphthylisoquinoline alkaloids from *Ancistrocladus griffithii*. *Phytochemistry* 61: 195–204.
- Chee, M., R. Yang, E. Hubbell, A. Berno, X.C. Huang, D. Stern, J. Winkler, D.J. Lockhart, M.S. Morris, and S.P.A. Fodor. (1996). Accessing genetic information with high-density DNA arrays. *Science* 274: 610–614.
- Chen, F., D. Tholl, J.C. D’Auria, A. Farooq, E. Pichersky, and J. Gershenzon. (2003). Biosynthesis and emission of terpenoid volatiles from *Arabidopsis* flowers. *Plant Cell* 15: 481–494.
- Churchill, G.A. (2002). Fundamentals of experimental design for cDNA microarrays. *Nature (Genet Suppl)*, 32: 490–495.
- Cseke, L.J., P.B. Kaufman, G.K. Podila, and C.-J. Tsai. (2004). *Molecular and Cellular Methods in Biology and Medicine*, 2nd ed. CRC Press, Boca Raton, Florida.
- Cui, X., and G.A. Churchill. (2003). Statistical tests for differential expression in cDNA microarray experiments. *Genome Biol* 4: 210.
- Cui, X., J.T. Hwang, J. Qiu, N.J. Blades, and G.A. Churchill. (2005). Improved statistical tests for differential gene expression by shrinking variance components estimates. *Biostatistics* 6: 59–75.
- D’Auria, J.C., F. Chen, and E. Pichersky. (2002). Characterization of an acyltransferase capable of synthesizing benzylbenzoate and other volatile esters in flowers and damaged leaves of *Clarkia breweri*. *Plant Physiol* 130: 466–476.
- de Hoog, C.L. and M. Mann. (2004). Proteomics. *Ann Rev Genomics Hum Genet* 5: 267–293.
- De Luca, V. and B. St. Pierre. (2000). The cell and developmental biology of alkaloid biosynthesis. *Trends Plant Sci* 5: 168–173.
- Dixon, R.A. (2001). Natural products and plant disease resistance. *Nature* 411: 843–847.
- Facchini, P.J. (2001). Alkaloid biosynthesis in plants: biochemistry, cell biology, molecular regulation, and metabolic engineering applications. *Ann Rev Plant Physiol Plant Mol Biol* 52: 29–66.
- Fan, J.B. et al. (2000). Parallel genotyping of human SNPs using generic high-density oligonucleotide tag arrays. *Genome Res* 10: 853–860.
- Fiehn, O. (2002). Metabolomics — the link between genotypes and phenotypes. *Plant Mol Biol* 48: 155–171.
- Franke, R., J.M. Humphreys, J.H. Hemm, and M.O. Ruegger. (2002). The *Arabidopsis* REF8 gene encodes the 3-hydroxylase of phenylpropanoid metabolism. *Plant J* 30: 33–45.
- Friedman, E., and E. Pichersky. (2005). Metabolomics, genomics, proteomics, and the identification of enzymes and their substrates and products. *Curr Opin Plant Biol* 8: 242–248.
- Glaser, T., A. Lienau, D. Zeeb, M. Krucker, M. Dachtler, and K. Albert. (2003). Qualitative and quantitative determination of carotenoid stereoisomers in a variety of spinach samples by use of MSPD before HPLC-UV, HPLC-APCI-MS, and HPLC-NMR on-line coupling. *Chromatographia* 57: S-19.
- Goff, S.A. et al. (2002). A draft sequence of the rice genome (*Oryza sativa* L. ssp. *japonica*). *Science* 296: 92–100.
- Goossens, A., S.T. Häkkinen, I. Laakso, T. Seppänen-Laakso, S. Biondi, V. De Sutter, F. Lammertyn, A.M. Nuutila, H. Söderlund, M. Zabeau, D. Inzé, and K.M. Oksman-Caldentey. (2003). A functional genomics approach toward the understanding of secondary metabolism in plant cells. *Proc Natl Acad Sci USA* 100: 8595–8600.
- Hirai, M.Y., M. Yano, D.B. Goodenowe, S. Kanaya, T. Kimura, M. Awazuhara, M. Arita, T. Fujiwara, and K. Saito. (2004). Integration of transcriptomics and metabolomics for understanding of global responses to nutritional stresses in *Arabidopsis thaliana*. *Proc Natl Acad Sci USA* 101: 10205–10210.
- Ibrahim, R.K. and I. Muzac. (2000). The methyltransferase gene superfamily: a tree with multiple branches. In *Recent Advances in Phytochemistry*, Vol. 34. Ibrahim, R., Varin, L., De Luca, V., and Romeo, J.T., Eds., Elsevier Science, Oxford, pp. 349–384.
- Ideker, T., T. Galitski, and L. Hood. (2001). A new approach decoding life: systems biology. *Ann Rev Genomics Hum Genet* 2: 343–372.
- Kersten, B., L. Burkle, E.J. Kuhn, P. Giavalisco, Z. Konthur, A. Lueking, G. Walter, H. Eickhoff, and U. Schneider. (2002). Large-scale plant proteomics. *Plant Mol Biol* 48: 133–141.

- Kim, H., G.P. Page, and S. Barnes. (2004). Proteomics and mass spectrometry in nutrition research. *Nutrition* 20: 155–165.
- Knudsen, J.C., L. Tollsten, and G. Bergstöm. (1993). Floral scents — a checklist of volatile compounds isolated by head-space technique. *Phytochemistry* 33: 253–280.
- Lamb, S.S. and G.D. Wright. (2005). Accessorizing natural products: adding to nature's toolbox. *Proc Natl Acad Sci USA* 102: 519–520.
- Lee, H. and I. Raskin. (1998). Glucosylation of salicylic acid in *Nicotiana tabacum* cv. Xanthi-nc. *Phytopathology* 88: 692–697.
- Li, Y., S. Baldauf, E. Lim, and D.J. Bowles. (2001). Phylogenetic analysis of the UDP-glucosyltransferase multigene family of *Arabidopsis thaliana*. *J Biol Chem* 276: 4338–4343.
- Lim, E., C.J. Doucet, Y. Li, D. Worrall, et al. (2002). The activity of *Arabidopsis* glycosyltransferase toward salicylic acid, 4-hydroxybenzoic acid, and other benzoates. *J Biol Chem* 277: 586–592.
- Mendes, P., A. Fuente, and S. Hoops. (2002). Bioinformatics and computational biology of plant functional genomics. In *Recent Advances in Phytochemistry*, Vol. 36. Romeo, J.T. and Dixon, R.A., Eds., Elsevier, Oxford, pp. 1–14.
- Nesi, N., I. Debeaujon, C. Jond, G. Pelletier, M. Caboche, and L. Lepiniec. (2000). The TT8 gene encodes a basic helix-loop-helix domain protein required for expression of DFR and BAN in *Arabidopsis* siliques. *Plant Cell* 12: 1863–1878.
- Newton, R.P., A.G. Brenton, C.J. Smith, and E. Dudley. (2004). Plant proteome analysis by mass spectrometry: principles, problems, pitfalls and recent developments. *Phytochemistry* 65: 1449–1485.
- Noel, J.P., R.A. Dixon, E. Pichersky, C. Zubieta, and J. Ferrer. (2003). Structural, functional, and evolutionary basis for methylation of plant small molecules. In *Recent Advances in Phytochemistry*, Vol. 37. Romeo, J.T., Ed., Elsevier, Oxford, pp. 37–58.
- Parenicova, L., S. Folter, M. Kieffer, D.S. Horner, C. Favalli, J. Busscher, H.E. Cook, R.M. Ingram, M.M. Kater, B. Davies, G.C. Angenent, and L. Colombo. (2003). Molecular and phylogenetic analysis of the complete MADS-box transcription factor family in *Arabidopsis*: new openings to the MADS world. *Plant Cell* 15: 1538–1551.
- Pichersky, E. and D.R. Gang. (2000). Genetics and biochemistry of specialized metabolites in plants: an evolutionary perspective. *Trends Plant Sci* 5: 439–445.
- Reymond, P., H. Weber, M. Damond, and E.E. Farmer. (2000). Differential gene expression in response to mechanical wounding and insect feeding in *Arabidopsis*. *Plant Cell* 12: 707–720.
- Roessner, U., C. Wagner, J. Kopka, R.N. Trethewey, and L. Willmitzer. (2000). Simultaneous analysis of metabolites in potato tuber by gas chromatography-mass spectrometry. *Plant J* 23: 131–142.
- Rose, J.K.C., B. Sajid, J.J. Giovannoni, M.M. Molly, and R.S. Saravanan. (2004). Tackling the plant proteome: practical approaches, hurdles and experimental tools. *Plant J* 39: 715–733.
- Schena, M., D. Shalon, R.W. Davis, and P.O. Brown. (1995). Quantitative monitoring of gene expression patterns with a complementary DNA microarray. *Science* 270: 467–470.
- Schmelz, E.A., J. Engelberth, H.T. Alborn, P. O'Donnell, M. Sammons, H. Toshima, and J.H. Tumlinson. (2003). Simultaneous analysis of phytohormones, phytotoxins, and volatile organic compounds in plants. *Proc Natl Acad Sci USA* 100: 10552–10557.
- Smith, R.D. (2000). Probing proteomes — seeing the whole picture. *Nat Biotechnol* 18: 1041–1042.
- Stoughton, R.B. (2005). Applications of DNA microarrays in biology. *Ann Rev Biochem* 74: 53–82.
- Sumner, L.W., A.L. Duran, D.V. Huhman, and J.T. Smith. (2002). Metabolomics: a developing and integral component in functional genomic studies of *Medicago Truncatula*. In *Recent Advances in Phytochemistry*, Vol. 36. Romeo, J.T. and Dixon, R.A., Eds., Elsevier, Oxford, pp. 31–62.
- Sweetlove, L.J., R.L. Last, and A.R. Fernie. (2003). Predictive metabolic engineering: a goal for systems biology. *Plant Physiol* 132: 420–425.
- Thomas, R. (2004). Biogenetic speculation and biosynthetic advances. *Nat Prod Rep* 21: 224–248.
- Threthewey, R.N. (2002). Metabolite profiling: from metabolic engineering to functional genomics. In *Recent Advances in Phytochemistry*, Vol. 36. Romeo, J.T. and Dixon, R.A., Eds., Elsevier, Oxford, pp. 63–80.
- Tolstikov, V.V. and O. Fiehn. (2002). Analysis of highly polar compounds of plant origin: combination of hydrophilic interaction chromatography and electrospray ion trap mass spectrometry. *Anal Biochem* 301: 298–307.
- Unlu, M., M.E. Morgan, and J.S. Minden. (1997). Difference gel electrophoresis: a single gel method for detecting changes in protein extracts. *Electrophoresis* 18: 2071.

- Unterlinner, B., R. Lenz, and T.M. Kutchan. (1999). Molecular cloning and functional expression of codeinone reductase: the penultimate enzyme in morphine biosynthesis in the opium poppy *Papaver somniferum*. *Plant J* 18: 465–475.
- van Wijk, K.J. (2001). Challenges and prospects of plant proteomics. *Plant Physiol* 126: 501–508.
- Velculescu, V.E., L. Zhang, B. Vogelstein, and K.W. Kinzler. (1995). Serial analysis of gene expression. *Science* 270: 484–487.
- von Roepenack-Lahaye, E., T. Degenkolb, M. Zerjeski, M. Franz, et al. (2004). Profiling of *Arabidopsis* secondary metabolites by capillary liquid chromatography coupled to electrospray ionization quadrupole time-of-flight mass spectrometry. *Plant Physiol* 134: 548–559
- Walker, K. and R. Croteau. (2000). Molecular cloning of 10-deacetylbaccatin III-10-*O*-acetyl transferase cDNA from *Taxus* and functional expression in *Escherichia coli*. *Proc Natl Acad Sci USA* 97: 583–587.
- Weigel, D.J. et al. (2000). Breakthrough technologies activation tagging in *Arabidopsis*. *Plant Physiol* 122: 1003–1013.
- Winkel-Shirley, B. (2002). A mutational approach to dissection of flavonoid biosynthesis in *Arabidopsis*. In *Recent Advances in Phytochemistry*, Vol. 36. Romeo, J.T. and Dixon, R.A., Eds., Elsevier, Oxford, pp. 95–111.
- Xia, Y., J. Borevitz, J.W. Blount, R.A. Dixon, and C. Lamb. (2002). Biopanning by activation tagging. In *Recent Advances in Phytochemistry*, Vol. 36. Romeo, J.T. and Dixon, R.A., Eds., Elsevier, Oxford, pp. 111–124.
- Xiao, H.B., M. Krucker, K. Albert, and X.M. Liang. (2004). Determination and identification of isoflavonoids in *Radix astragali* by matrix solid-phase dispersion extraction and high-performance liquid chromatography with photodiode array and mass spectrometric detection. *J Chromatogr A* 1032: 117.
- Zubieta, C., X. He, R.A. Dixon, and J.P. Noel. (2001). Structures of two natural products methyltransferases reveal the basis for substrate specificity in plant *O*-methyltransferases. *Nat Struct Biol* 8: 271–279.
- Zubieta, C., P. Koscheski, J.R. Ross, Y. Yang, E. Pichersky, and J.P. Noel. (2003). Structural basis for substrate recognition in the salicylic acid carboxyl methyltransferase family. *Plant Cell* 15: 1704–1716.

# 7

## *Plant Biotechnology for the Production of Natural Products*

Ara Kirakosyan

### CONTENTS

7.1	Introduction .....	222
7.2	Plant Biotechnology: From Basic Science to Industrial Application .....	223
7.2.1	Basic Knowledge of Plant Cell Culture .....	223
7.2.1.1	Morphological Differentiation .....	224
7.2.1.2	Variations in Callus Cultures .....	224
7.2.1.3	Cell Types in Suspension Culture .....	224
7.2.2	<i>In Vitro</i> Cultures and Their Applications .....	225
7.2.3	Bioconversion of Metabolites .....	226
7.2.3.1	Case Study: Bioconversion of Sucrose to Its Isomer Form, Palatinose — Possible Impact on Carbohydrate Metabolism in Potato ( <i>Solanum tuberosum</i> ) Tubers .....	228
7.3	Natural Products and Plant Biodiversity .....	229
7.3.1	An Overview of the Status of Plant Biodiversity .....	229
7.3.1.1	Uses of Wild Plants .....	230
7.3.2	The Biodiversity of Several Medicinal Plants in the World — Their High-Value Secondary Metabolites and Uses .....	230
7.3.2.1	St. John's Wort ( <i>Hypericum perforatum</i> L.) .....	230
7.3.2.2	Hawthorn ( <i>Crataegus</i> spp.) .....	231
7.3.2.3	Legumes .....	232
7.3.2.4	Flax ( <i>Linum</i> spp.) .....	233
7.3.3	Different Aspects of the Exploration and Sustainable Exploitation of Plant Biodiversity .....	233
7.3.3.1	Methods for Phytochemical Screening and Testing of Biological Activity of Plant Extracts .....	234
7.3.3.2	Case Study: Evaluation of Extraction Efficiencies for <i>H. perforatum</i> Chemistries .....	234
7.3.4	Chemotaxonomy and Its Relationship to Secondary Metabolism .....	235
7.4	Plant Cell Biotechnology for the Production of Secondary Metabolites .....	236
7.4.1	Factors Determining the Accumulation of Secondary Metabolites by Plant Cells .....	237
7.4.2	Plant Cell Culture as a Method for Studying Biosynthesis and the Production of Secondary Metabolites .....	238
7.4.3	Strategies to Improve Metabolite Production .....	239
7.4.3.1	Selection of Elite Germplasm for an Efficient Production System .....	239
7.4.4	Micromanipulation of Higher Plant Cells for Production Systems .....	240
7.4.4.1	Elicitation .....	241
7.4.4.2	Screening and Selection of Cultured Plant Cells in Order to Increase Yields of Phytochemicals .....	242
7.4.5	Growth and Production Kinetics of Plant Cell Cultures in Bioreactors .....	244
7.4.5.1	Batch Systems .....	245

7.4.5.2	Long-Term Continuous Cultivation.....	246
7.4.5.3	Large-Scale Production of Plant Secondary Metabolites in Bioreactors .....	247
7.5	Metabolic Engineering of Plant Secondary Metabolism.....	247
7.5.1	Engineering of Plant Secondary Metabolite Pathways for the Production of Natural Products.....	248
7.5.1.1	Increasing Total Carbon Flux through Metabolic Pathways.....	248
7.5.1.2	Overcoming Rate-Limiting Steps .....	249
7.5.1.3	Blocking Catabolism or Competitive Pathways.....	250
7.5.2	Metabolic Engineering for Plant Improvement and Protection against Environmental Stresses .....	250
7.6	Molecular Farming.....	251
7.6.1	Molecular Farming Is a Relatively New Area of Science and Industry.....	251
7.6.2	Molecular Farming of Valuable Natural Products and Pharmaceutical Proteins .....	252
7.6.2.1	Fermentation Process, Extraction, and Purification .....	253
7.6.2.2	The Significance in Relation to the Plant Biotechnology.....	254
7.7	The Benefits and Risk Factors of Biotechnology and Future Prospects .....	254
7.8	Conclusions .....	255
References	.....	256

---

## 7.1 Introduction

Achievements today in plant biotechnology have already surpassed all previous expectations. Plant biotechnology has emerged as an exciting area of research by creating unprecedented opportunities for the manipulation of biological systems of plants. It is a forward-looking research area based on promising accomplishments in the past several decades. Plant biotechnology is changing plant science in three major areas: (1) growth and development control (vegetative, generative, and propagative), (2) protection of plants against the environmental threats of abiotic or biotic stresses, and (3) expansion of ways by which specialty foods, biochemicals, and pharmaceuticals are produced. To determine the current status of plant biotechnology, it must emphasize the difference between the traditional concept of biotechnology and its current status. Early directions of plant biotechnology, which mostly focused on *in vitro* cell and tissue culture and their production of important products, are now advancing into new directions. The current state of plant biotechnology research using a number of different approaches includes high-throughput methodologies for functional analysis at the levels of transcripts, proteins, and metabolites, and methods for genome modification by both homologous and site-specific recombination. Plant biotechnology allows for the transfer of a greater variety of genetic information in a more precise, controlled manner. The potential for improving plant productivity and their proper use in agriculture relies largely on newly developed **DNA biotechnology** and **molecular markers**. These techniques enable the selection of successful genotypes, better isolation and cloning of favorable traits, and the creation of transgenic organisms of importance to agriculture and industry.

Many scientists have now combined extensive research experience using plant tissue and cell culture with a deep knowledge of natural products in order to develop the current strategies cited above. This is enabling us to follow up in greater detail points of interest, both theoretical and practical. A number of methods were developed and validated in association with the use of genetically transferred cultures in order to understand the genetics of specific plant traits. Such relevant methods can be used to determine the markers that are retained in genetically manipulated natural products and to determine the elimination of marker genes and procedures for characterization of chromosomal aberrations in genetically manipulated plants.

A number of transgenic plants were developed with beneficial characteristics and significant long-term potential to contribute both to biotechnology and to fundamental studies. Therefore, the presentation of all the major achievements in plant biotechnology together will be beneficial for natural products research.

In this chapter, we discuss the most up-to-date information on basic and applied research in plant biotechnology. This will reveal strategies for development of this field, traditional and high-throughput approaches, and future trends.

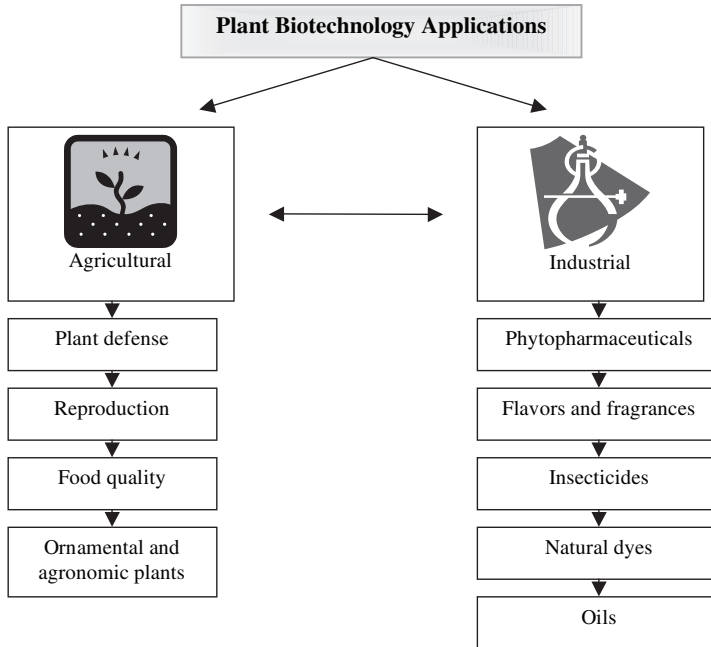

FIGURE 7.1 Plant biotechnology applications.

## 7.2 Plant Biotechnology: From Basic Science to Industrial Application

Because the different fields of plant science have become well developed in the past several decades, many opportunities are now available to make significant progress in plant biotechnology.

Plant biotechnology aims to impart an understanding of the basic principles of plant and molecular biology and to apply these principles to the production of healthy plants in a safe environment for food and nonfood applications (Figure 7.1).

Important aspects of this are the design of transgenic plants and related technology. Different strategies, using *in vitro* systems, were extensively studied with the objective of improving the production of natural products. Thus, specific processes were designed to meet the requirements of plant cell and organ cultures in **bioreactors**. Moreover, the recent emergence of recombinant DNA technology has opened a new field, whereby it is now possible to directly modify the expression of genes related to natural product biosynthesis. The focus here is on metabolic and genetic engineering biosynthetic pathways, so as to improve the production of high-value secondary metabolites in plant cells.

There are, however, some limitations concerning the use of **genetically modified (GM) plants**. While some scientists find this to be the most progressive direction to take in plant biotechnology, others are opposed to this exploration. In any case, the inclusion of foreign gene(s) in plant genomes gives us unique opportunities to upregulate metabolite biosynthesis, and thus, to reveal the nature, functional consequences, and physiological importance of secondary metabolites in plants. Genetic modification technology aims to add or enhance beneficial characteristics in current plant varieties so as to obtain high metabolite producer varieties that would otherwise be slow, costly, or impossible to achieve through conventional plant breeding (Sonnewald, 2003).

### 7.2.1 Basic Knowledge of Plant Cell Culture

Plant tissues excised from plants can be cultured *in vitro* and regenerated to whole plants if the culture medium contains suitable nutrients and plant growth hormones. This is due to plants having a unique property called **totipotency**, that is, the ability of plant cells to develop into whole plants or plant organs.



Regeneration of plants from callus tissue is usually achieved either by **organogenesis** or by **somatic embryogenesis**. In the case of organogenesis, plant organs and tissues, such as shoots, roots, and vascular tissue connecting shoots and roots, are formed independently of each other. On the other hand, plant organs regenerated via somatic embryogenesis are thought to originate from a single cell in a callus or from suspension-cultured cells. Due to this unique property of plant cells, *in vitro* cultures are now used to manipulate the biosynthetic potential of plants.

In recent years, more plant cell culture studies utilized plant protoplasts. Isolated protoplasts from plant cells can now be micromanipulated for **somatic cell hybridization**. However, the development of methods for protoplast isolation, culture, and subsequent plant regeneration are still critical for the successful somatic hybridization of higher plants.

Therefore, in plant cell biotechnology, most emphasis is given to plant cells that are cultured in suspension. **Cell suspension cultivation** offers a unique possibility for the production of natural products on a large scale. However, plant cell suspension cultures, in general, are less productive due to the fact that undifferentiated cells are not able to produce a wide variety of secondary metabolites. In addition, other problems arise in this kind of cultivation system that concern aseptic cultivation, specific design of bioreactors, stability of cell lines, and finally, differences in the cell cycle that are most efficient for optimizing cell suspension cultivation conditions.

Thus, plant cell suspension cultivation protocols still need to be very well designed using genetically stable cell lines with highest yields of desired secondary metabolites in order to elaborate conditions for long-term cultivation.

### 7.2.1.1 Morphological Differentiation

One of the main problems facing practical applications in the use of plant cell cultures for production of phytochemicals is that undifferentiated cell cultures do not often form such compounds. However, after the development of shoots or roots from callus tissue, or from cell suspension cultures, the regenerants are able to accumulate secondary metabolites in special types of cells, tissues, or organs. This is due to the fact that the major secondary metabolites in plants are accumulated in special morphological structures within intact plant tissues. This obstacle was the main stumbling block for large-scale cultivation of cell suspension cultures and their possible industrial applications. However, much current research is concentrated on deriving fully or partly morphologically differentiated cell aggregates or organ cultures. These kinds of cultures have turned out to be high producers of particular metabolites.

### 7.2.1.2 Variations in Callus Cultures

Callus cultures are derived from intact plant organs, sterile germinated seedlings, or individual cells cultivated in suspension. Callus culture tissue consists of two different groups of cells: parenchyma, which forms soft callus, and deep-green structures consisting of tightly packed meristematic cells located within the soft callus tissue. These tightly packed structures in callus cultures probably represent **somatic embryoids** at an early stage of development. It is known that for indirect embryogenesis to occur, the formation of clusters from embryogen-determined cells, which were redifferentiated, is universally necessary (Vasil et al., 1990). Usually, these cells proliferate to form bigger clusters. The tight callus is able to undergo morphogenesis; however, this occurs only when the right composition of phytohormones is selected.

The cells proliferate and form larger clusters that continue to increase in size until they reach a certain critical biomass. Depending on the culture conditions (light, composition of medium, pH, aeration), plant cell lines can differ in aggregate size and in uniformity of cell type.

### 7.2.1.3 Cell Types in Suspension Culture

Generally, cell suspension cultures are classified as homologous and heterologous cell cultures. The difference between these two cultures in terms of the morphology and uniformity of cell types has been well characterized. **Homologous cultures** consist of a fine cell suspension culture of mostly homogenous populations of cells. **Heterologous cultures**, on the other hand, consist of different types of cells made up of clusters as well as cell aggregates. These cell cultures may produce some desired secondary metabolites in various amounts; others, in contrast, do not produce them. An explanation for the different

biosynthetic abilities of these kinds of cell suspension cultures is that cells do not produce some compounds until full or partial differentiation has occurred, as described above. On the other hand, it is possible that the production of some compounds could be triggered in a critical situation when the biosynthetic ability of the cells must be turned on under the influence of biotic or abiotic factors. Critical to cell suspension culture biosynthetic potential is how and from what part of the intact plant the cell cultures are derived. If the cells are derived from a reproductive part of the plant that synthesizes a particular metabolite, this kind of cell culture could be considered to be a “**producer**” **cell suspension line**. If, however, the cell suspension culture is derived from callus culture that is, in fact, a nonproducer of a particular metabolite, this culture could be considered a “**nonproducer**” **cell suspension line**. However, this classification was not proven to be valid for all the cases discussed. In other words, it is not a general rule because the type of culture media formulation, or even elicitation, could trigger biosynthesis and production of some metabolites.

There is one interesting example of the cell suspension type of cultivation involving **globular structures** cultivated in liquid medium that may have more practical applications in biotechnology. This is a different type of cultivation of plant cells than was introduced previously, and it is now being extensively studied. The enhancement of secondary metabolite production in liquid-cultivated cell aggregates differs from that in shoots or callus (Vardapetyan et al., 2000). Recently, we reported that suspension cultures of *Hypericum perforatum* with compact globular structures had a higher total content of some important secondary metabolites than unorganized cell suspension cultures (Vardapetyan et al., 2000). This finding parallels the observations made for two other plant systems — *Catharanthus roseus* (Madagascar pink) and *Rhodiola sachalinensis* — in which compact globular structures constitute a very good system for secondary metabolite synthesis (Verpoorte, 1996; Xu et al., 1999). The globular structures reach the highest possible critical size during the cell culture process, which does not change after further subculturing. Long-term cultivation of these cultures showed that further accumulation of biomass is due to an increase in the number of globules (Vardapetyan et al., 2000). It is noteworthy that these globular structures are fully differentiated structures in which their shape appears to be like that of a raspberry (*Rubus* spp.) fruit.

### 7.2.2 *In Vitro* Cultures and Their Applications

The major topics of concern in this section include the following:

- The production of natural products from plant cell cultures
- Biochemical studies of secondary metabolite pathways to answer fundamental questions of how and why these compounds synthesized (see also Chapter 2)
- Immobilization of plant cells for biotransformation of low-value compounds into high-value end-products
- Micropropagation of plants that yield genetically stable fruits and vegetables, and those that produce valuable natural products
- Field testing of tissue-culture-derived transgenic plants
- Nutritional quality analysis, feed formulation, evaluation of toxigenesis, and environmental safety
- Processes for scaling-up and bioreactor design

The main application of cell cultures can be attributed to their biosynthetic abilities and large-scale cultivation. The question then arises, do cells cultivated *in vitro* produce desired natural products? The evidence that plant cell cultures are able to produce secondary metabolites was experimentally proven by Zenk and co-workers (1991). Their work disproved the controversial theory that only differentiated cells or specialized organs are able to produce secondary compounds. Currently, many kinds of secondary compounds are successfully isolated from suspension-cultured cells. Moreover, there are also *de novo* synthesized compounds isolated from and characterized in several kinds of plant cell cultures (Dias et al., 1998; Petersen and Alfermann, 2001).

TABLE 7.1

Comparison of Advantages and Disadvantages of Three Different Culture Regimes for Secondary Metabolite Production from Plants

Mode of Cultivation	Advantages	Disadvantages
Field cultivation in a nursery	Can help to improve conservation of plant biodiversity; can use low winter temperatures to break seed dormancy; low cost of production of 1-year-old plants	Short growing season; problems of disease, insect attack, and herbivory; no control of weather conditions
Greenhouse cultivation	Can use illumination and environmental parameters to control and regulate growth of plants and secondary metabolite production; growing of rare, endemic, or threatened plant species is possible	Higher energy and labor costs than field cultivation, including automated greenhouse installation and operation
Cell/tissue/organ culture	Can genetically modify culture to enhance metabolite biosynthesis; plant micropropagation is possible, resulting in genetic reproducibility; elicitation is more convenient; cultivation in bioreactors and enzyme-catalyzed modification of precursors into desired products are possible	The process is labor intensive and is expensive due to the high cost of culture media constituents and the requirement for sterile culture conditions; stability problems of cell lines; low yield of end products in bioreactors

The importance and potential of plant cell and tissue culture for the production of natural products are now proven for some plants and their metabolites, despite some limitations and drawbacks in this technique (Table 7.1). Many phytopharmaceutical compounds have traditionally been obtained from plants growing in the wild or from field-cultivated plants. But, in light of diminishing plant resources in natural and wilderness areas due to clear-cutting of temperate and tropical forests worldwide, and increasingly higher costs of obtaining secondary metabolites from plants growing in the wild, plant biotechnologists have opted to grow these plants in cell cultures. While this method is great for micropropagation of endangered plant species, it is very labor intensive and costly and gives notoriously low yields of secondary metabolites as compared with intact plants (Kaufman et al., 1999). It is well known that processes using large-scale plant cell cultures could be economically feasible, provided the cells have a high growth rate coupled with significant metabolite production rates. Therefore, the first question to be answered before developing plant cell biotechnology further for industrial applications is whether large-scale culture in bioreactors is economically feasible (Verpoorte, 1996; Verpoorte et al., 1994).

In addition, cell suspension cultures can be used for biotransformation of added substrates, to search for new compounds not present in the intact plant, and finally, to isolate enzymes that are responsible for the important metabolic pathways and then use them in the chemical synthesis of natural products (reviewed by Alfermann and Petersen, 1995).

### 7.2.3 Bioconversion of Metabolites

Plant cells constitute an effective system for the biotransformation of substrates that are supplied to the culture medium. In such cases, the enzymes involved in this process can be identified, purified, and immobilized. Then, the enzymatic potential of the plants or cultured plant cells can be employed for bioconversion purposes. Plant enzymes are able to catalyze regio- and stereospecific reactions, and therefore, can be used for the production of desired substances.

**Stereospecificity** concerns the high optical purity (100% of one stereoisomeric form) of biologically active molecules being catalyzed by plant enzymes. **Regiospecificity** allows for more precise conversion of one or more specific functional groups into others, or in the case of precursor molecules, selective introduction of functional groups on nonactivated positions.

In order to understand the bioconversion process better, we would like to highlight the general principles of plant enzyme-based processes. Generally, **bioconversion** means the enzyme-catalyzed modification of added precursors into more desired or valuable products, using plant cells or specific

enzymes isolated from plants. Particularly, this type of metabolite modification is accurate and not so labor intensive. In this context, two biocatalytic systems can be employed. First, the catalysis of specific foreign substances, either chemically prepared or isolated from nature, can be carried out by enzymatic conversion outside the organism. Second, bioconversion of a particular product uses either plant cell cultures or whole plants. Improved metabolite production may be achieved by adding precursors to the culture medium. The biochemical capability of cultivated plant cells to transform exogenously supplied compounds offers an interesting contribution with broad potential to the modification of natural and synthetic chemicals. Bioconversion appears to be a more useful tool for plant cell cultures, and in the chemical industry, it was shown to be more advantageous compared to chemical modification of secondary metabolites.

The **biocatalyst** may be free, in solution, immobilized on a solid support, or entrapped in a matrix. Systems applied for bioconversion can consist of freely suspended cells, where precursors are supplied directly to cultures, and immobilized plant cells, which are useful especially for secondary metabolite production but need further development and an increase in the half-life of the cells. Enzyme preparation and further usage must be considered by taking into account problems connected with enzyme stability and sufficiency. In bioconversions elicited by whole cells or extracts, a single enzyme or several enzymes may be required for an action to occur.

Recent studies showed that growing transgenic plants in the field could be an alternative approach to using labor-intensive bioreactor-based plant cell bioconversion. We will discuss this approach more specifically.

**Plant biomass**, the most abundant renewable resource on earth, is a potential source of fermentable sugars for the production of alternative transportation fuels and other chemicals. Bioconversion of plant biomass to fermentable glucose involves enzymatic hydrolysis of cellulose, a major polysaccharide constituent of the plant cell wall (see Chapters 1 and 2). Manufacturing heterologous cellulases in crop plant bioreactors could significantly reduce costs associated with enzyme production and could offer a potentially high-volume alternative to traditional methods.

For example, enzymes from thermophilic organisms are particularly suited for industrial applications, because they are typically thermostable, resistant to **protease attack** (which hydrolyzes proteins), and relatively tolerant toward other stresses, such as pH extremes. Genes for a variety of thermostable **cellulase enzymes** (cellulose-digesting enzymes) from fungi and bacteria were cloned and sequenced. Much effort was devoted to developing transgenic plants (*Arabidopsis thaliana* used as a model system) as bioreactors to produce heterologous proteins, including industrial enzymes such as cellulase (Park et al., 2003). Such transgenic plants are fertile and exhibit normal growth. Another example concerns secondary metabolite bioconversion by cell suspension cultures. *In vitro* cell suspension cultures of *Linum flavum* (flax) are able to convert high amounts of **2,7-cyclolignan deoxypodophyllotoxin** to **6-methoxypodophyllotoxin 7-O-glucoside**. This conversion was studied in detail by monitoring the intermediates and side products after feeding different concentrations of deoxypodophyllotoxin (Koulman et al., 2003). At a low concentration (0.1 to 0.5 mM), deoxypodophyllotoxin is rapidly converted into 6-methoxypodophyllotoxin 7-O-glucoside, 6-methoxypodophyllotoxin, and traces of  **$\beta$ -peltatin** and **podophyllotoxin** (Koulman et al., 2003).

Crude enzyme extracted from soybeans was used to convert **isoeugenol** into **vanillin**. The effects of several factors on the bioconversion were studied. Conversion was affected by the amount of substrate and was improved by the addition of absorbents, among which, powdered activated carbon was the best. The effect of H<sub>2</sub>O<sub>2</sub> concentration on the conversion was also studied. The optimum concentration of H<sub>2</sub>O<sub>2</sub> was 1% (v/v). With 10 g·ℓ<sup>-1</sup> of powdered activated carbon and 0.1% H<sub>2</sub>O<sub>2</sub> added, vanillin reached a maximum concentration of 2.46 g·ℓ<sup>-1</sup> after 36 h, corresponding to a molar yield of 13.3% (Li et al., 2005).

The results obtained from the biotransformation experiments using cell cultures and crude cell extracts suggest that enzymes were present only in the cells, and that the substrates and products had to be extracted from the entire culture. Balsevich (1985) examined the biotransformation of **10-hydroxy geraniol** by cultures of *Catharanthus roseus* (rosy periwinkle). The reduced products were all found to be present in the culture medium. The medium was devoid of any dehydrogenase activity. It was suggested that this was evidence for the existence of a membrane-bound enzyme.

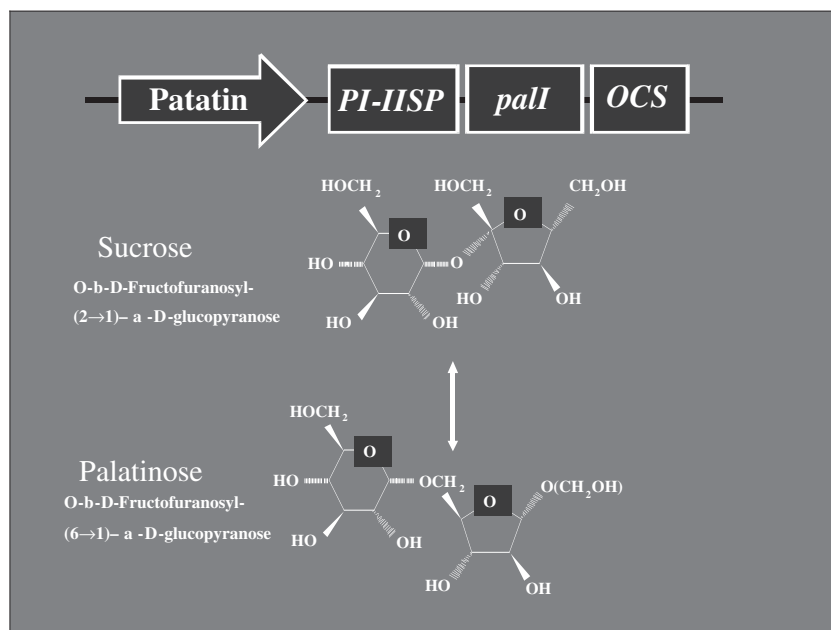

FIGURE 7.2 Tuber-specific expression of sucrose isomerase in transgenic potato plants leads to the accumulation of palatinose, a nonmetabolizable sucrose isomer.

### 7.2.3.1 Case Study: Bioconversion of Sucrose to Its Isomer Form, Palatinose – Possible Impact on Carbohydrate Metabolism in Potato (*Solanum tuberosum*) Tubers

**Palatinose (isomaltulose, 6-*O*-glucopyranosyl-fructose)** is a structural isomer of sucrose with similar physicochemical properties. Due to its noncariogenicity and low calorific value, it is an ideal sugar substitute for use in food production. Palatinose is produced on an industrial scale from sucrose by an enzymatic rearrangement using immobilized bacterial cells. Various palatinose-producing microorganisms were used industrially for the production of this sugar because of their ability to produce a particular **α-glucosyltransferase (sucrose isomerase; EC 5.4.99.11)** that catalyzes the conversion of sucrose into palatinose and a second isomer, **trehalulose (1-*O*-glucopyranosyl-fructose)**, in different ratios to each other. However, due to its extreme water solubility, trehalulose has not yet been crystallized, and thus, its use in food production is limited.

To explore the potential of transgenic plants as an alternative production system for palatinose, a chimeric sucrose isomerase gene (*pall*) from *Erwinia rhapontici* under control of a tuber-specific promoter was introduced by Bornke et al. (2002) into potato plants. This enzyme catalyzes the conversion of sucrose into palatinose (Figure 7.2).

Expression of the *pall* gene within the apoplast of transgenic tubers leads to a nearly quantitative conversion of sucrose into palatinose. Therefore, expression of a bacterial sucrose isomerase provides a valuable tool for high-level palatinose production in storage tissues of transgenic crop plants like potato. These results demonstrate that by using the appropriate promoter elements, palatinose production can be restricted to specific organs without interfering with plant growth. This is a prerequisite for the use of transgenic plants as bioreactors for palatinose production in agriculture. However, field trials need to be carried out in order to investigate whether sucrose conversion affects tuber yield.

In another experiment, in order to study the possible regulatory role of sucrose in potato tuber metabolism, two transgenic approaches were followed (Hajirezaei et al., 2003). The first approach used phloem-specific expression of cytosolic **invertase** so as to block the phloem transport of sucrose. As a consequence, tuber sprouting was strongly impaired. Surprisingly, reserve mobilization was found to be highly accelerated, even in the absence of any visible sprout growth. Based on this result, these inves-

tigators speculated that metabolic signals rather than real sink demand would trigger starch breakdown. Hexose metabolism or sucrose levels were selected as possible candidates for metabolic signals. To distinguish between both possibilities, transgenic plants engineered to express a bacterial sucrose isomerase were included in these studies as a second approach. Due to isomerase activity, sucrose is converted to palatinose, which leads to a depletion of sucrose. In contrast to sucrose hydrolysis (as catalyzed by invertase), sucrose isomerization does not lead to enhanced hexose metabolism. Use of these transgenic plants allowed for starch turnover in tubers containing low sucrose levels to be studied without significant changes occurring in hexose metabolism. In agreement with the theory that sucrose plays a prominent role in the regulation of reserve mobilization, accelerated starch breakdown in sucrose-isomerase-expressing tubers was observed (Hajirezaei et al., 2003). Based on this result, it was concluded that low sucrose levels trigger starch mobilization in stored potato tubers.

---

### 7.3 Natural Products and Plant Biodiversity

The biodiversity assessment for plants has three interlinked objectives: (1) to summarize the status of biodiversity and its conservation; (2) to analyze threats to plant biodiversity; and (3) to identify opportunities and make recommendations for the improved conservation of plant biodiversity. We will discuss each of these objectives in the sections that follow.

#### 7.3.1 An Overview of the Status of Plant Biodiversity

In the world, many regions were identified by the **World Wide Fund for Nature** as “**Global 200 Ecoregions**,” based on selection criteria such as species richness, levels of endemism, taxonomic uniqueness, unusual evolutionary phenomena, and global rarity of major habitat types. Moreover, **Conservation International** identified some regions as global “hotspots” — 25 of the most biologically rich and most endangered terrestrial ecosystems in the world. These hotspots were identified based on three criteria: (1) the number of species present, (2) the number of those species found exclusively in an ecosystem, and (3) the degree of threat they face. There is a high correlation between high species diversity and the variety of ecosystems and landscapes that occur in nature. Many rare, endemic, and threatened species grow in distinct zones.

The diversity of wild relatives of crop plants, also termed **agrobiodiversity**, has been used to develop new varieties through selection. The ancestors of wheat, barley, rye, oats, and other cereals, as well as many kinds of fruit trees or vegetables are involved in this process.

Because of natural and human impacts, almost half of existing plant species face some threat of extinction. The principal direct threat to biodiversity is habitat loss and degradation as a result of human activities, including intensive agricultural and livestock development on marginal lands, urban and industrial development, and associated pollution of soil and water. Forests are one of the most seriously threatened ecosystems.

The status of biodiversity conservation has been applied to protected areas. The network of protected areas was established to conserve the natural and cultural heritage, including important habitats and species, as well as landscapes, cultural and natural monuments, and important geological formations (see Chapter 14). In particular, several protected areas were created to preserve the habitats of unique, rare, and endemic plant and animal species. However, the effectiveness of the entire system of protected areas and many reserves has not been formally established, especially in developing countries.

Several **state reserves** were established in the world. **State conservation areas** are established to protect areas where unique natural habitats, ecosystems, and species occur. In contrast to state reserves, strictly regulated economic and sustainable use of natural resources is included among the management objectives of state reservations. The **national parks** have several management categories that include protection of their unique ecosystems and their littoral habitats; mitigation of the current negative impacts of industrial, agricultural, and tourism activities on the natural resource base; and preservation of the natural resources. Furthermore, natural monuments are established to protect nationally and internationally important natural and historical landscapes and special features of culture and natural history.

Another option concerning biodiversity is conservation outside protected areas, such as *ex situ* **conservation**. Live collections of plants are supported by plant scientists. Extensive plant collections were established in many countries. In general, the conditions of *ex situ* collections are very important. Museum research collections have been similarly affected.

There are some important recommendations for improved biodiversity conservation, which are generally applied to review and to develop revised protected area systems and to encourage pilot initiatives in community-based natural resource management (see Chapter 14).

### 7.3.1.1 Uses of Wild Plants

Many edible plants collected in the wild are used fresh, cooked, pickled, or dried. Commonly used plants include longleaf (*Falcaria*), lamb's quarters (*Chenopodium album*), asparagus (*Asparagus*), and chervil (*Chaerophyllum*). Many species of **wild berries and nuts** are collected, including walnut (*Juglans*), hazelnut (*Corylus*), pear (*Pyrus*), apple (*Malus*), dogwood (*Cornus*), blackberry and raspberry (*Rubus*), bilberry or lingonberry (*Vaccinium*), and currant (*Ribes*). Moreover, a great variety of plants are used for **animal fodder**, including clover (*Trifolium*), sainfoin (*Onobrychis*), and alfalfa (*Medicago sativa*). Many species of plants are known to produce **essential oils**, mainly species of thyme (*Thymus*), helichrysum (*Helichrysum*), and wormwood (*Artemisia*). Other plants used in **producing dyes** include indigo (*Isatis tinctoria*), spurge (*Euphorbia*), buckthorn (*Rhamnus*), elderberry (*Sambucus*), and madder (*Rubia*).

Around 30 to 40% of plants have some **medicinal use**, and species of hawthorn (*Crataegus* spp.), neem tree (*Azadirachta indica*), juniper (*Juniperus*), barberry (*Berberis*), kudzu (*Pueraria montana*), St. John's wort (*Hypericum perforatum*), and many others are collected for traditional remedies.

## 7.3.2 The Biodiversity of Several Medicinal Plants in the World — Their High-Value Secondary Metabolites and Uses

### 7.3.2.1 St. John's Wort (*Hypericum perforatum* L.)

St. John's wort, *Hypericum perforatum* L., is a rich source of high-value secondary metabolites that include medicinal compounds, flavorings, fragrances, insecticides, and natural dyes. This traditional medicinal plant is considered to be an important source of phytopharmaceuticals, which occur in the aerial parts of the plant, and it has become one of the leading plant-based dietary supplements worldwide. St. John's wort is a woody perennial species belonging to the family, Hypericaceae, which is comprised of 10 genera and 400 species worldwide. The genus *Hypericum* has more than 350 species and includes evergreen and deciduous shrubs, subshrubs, and herbaceous perennials (Hickman, 1993). The species in the genus *Hypericum* have simple, opposite, or whorled leaves and usually have golden yellow flowers with many stamens.

*H. perforatum* is a low-growing perennial with yellow flowers that originated in Western Europe, Asia, and North Africa, but has since become naturalized throughout the temperate regions of the world. *H. perforatum* grows in open woods, dry meadows and fields, waste places, on grassy banks, in thickets, and along roadsides throughout Europe (except Iceland), Asia Minor, Russia, India, China, North Africa, and many other countries (Halusková and Cellárová, 1997). In North America, *H. perforatum* grows throughout Canada (except in the far north) and in all of the United States except in the most southern states (Campbell and Delfosse, 1984). *H. perforatum* grows to an average of 30 cm to 1 m high; it is common to see multiple stems branch from the main stalk of the plant, causing the plant to look very "top heavy." The leaves are opposite, oblong to lanceolate, and 1.5 to 4 cm long; they contain pellucid glands throughout the leaves and dark glands along the leaf margins (Kurth and Spreemann, 1998).

Flowers are produced from May to August (Halusková and Cellárová, 1997), with peak blooming time occurring around mid-July through mid-August. Flowers consist of bright yellow clusters of about ten flowers each at the tops of the many branches of the plant. Older, more mature plants can have as many as 100 flowers per plant. The flowers are perfect, radiate, and have five petals that are usually 8 to 12 mm long with black dots appearing along the margins. Five linear-lanceolate, acute, or acuminate sepals, measuring 4 to 6 mm long, occur at the base of the petals. They also contain glands that appear as black dots that adorn the margins (Kurth and Spreemann, 1998). Stamens number 15 to 100 in clusters of three or five. The ovary is superior, containing three carpels and three styles. The fruits are septicidal

capsules of 7 to 8 mm in length. They contain numerous brown- to black-pitted seeds (Kurth and Spreemann, 1998).

*H. perforatum* is a prolific seed producer, primarily apomictically but sexually as well. Seed germination is greatly delayed by inhibitors present in the seed coat. *H. perforatum* colonizes via vigorous vegetative growth from stolons located in the crown of the plant. Conditions of stress, including **herbivory**, may promote an increase in crown production from the lateral roots. Approximately ten or more **ramets** (crowns) in a stand may originate from the same root system (Lopez-Bazzocchi et al., 1991).

The cytology and reproduction of this plant was documented by Cellárová et al. (1995). *H. perforatum* is a tetraploid ( $n = 16$ ) species arising from allopolyploidy (Halusková and Cellárová, 1997). *H. perforatum* may have arisen from an ancient hybridization between two diploids (possibly *H. maculatum* Crantz and *H. attenuatum* L.) with subsequent chromosome doubling (Campbell and Delfosse, 1984). It is interesting to note that almost all of the world's most invasive species are polyploids (Radosevich, 1997). The high level of heterozygosity may benefit the weed by conferring greater tolerance to heterogeneous environments (Barrett, 1982).

The genetic potential for *Hypericum* has yet to be tapped to identify superior germplasm, whether for traditional cultivation or for development of superior plant cell culture lines. Breeding of improved *H. perforatum* varieties is mainly hindered by limited knowledge of its mode of reproduction. St. John's wort has traditionally been supplied from both cultivated and wild-harvested materials. However, the marketed product has raised concerns about variability in quality and about adulteration and contamination (Constantine and Karchesy, 1998) as well as the possibility of losses in biodiversity when collected from the wild. There are now several reports noting the variation in phytochemical contents in wild populations of *H. perforatum* (Kirakosyan et al., 2004a, and references cited therein), but it is still not clear whether these differences are indicative of environmental or genetic influences.

St. John's wort was traditionally used in folk medicine. In recent years, its pharmaceutical potential greatly increased when antiviral, anticancer, and antidepressant activities were demonstrated (Kirakosyan et al., 2004a, and references cited therein). These activities are thought to be due to a family of **dianthrones** and **phloroglucinol** derivatives that are present in plant tissues. Perhaps the most important secondary metabolites in St. John's wort are the dianthrone pigments **hypericin** and **pseudohypericin**. Pseudohypericin differs from hypericin at one carbon, where a hydroxyl group is substituted for hydrogen, making the compound slightly more polar. Plant extracts typically contain small amounts of the immediate precursors, **protohypericin** and **protopseudohypericin**, that are converted to hypericin and pseudohypericin within 2 h in the presence of light (Sirvent and Gibson, 2000). **Cyclopseudohypericin** and **isohypericin** can also be recovered from plant extracts of *H. perforatum* in trace amounts (Sirvent and Gibson, 2000).

**Hypericins** are the active, antiviral components of the extracts (Lopez-Bazzocchi et al., 1991; Upton et al., 1997). (See Section 2.5.4 in Chapter 2 for details on their structure and synthesis.) Hypericin, pseudohypericin, and crude extracts of *H. perforatum* were shown to be effective against the hepatitis C virus *in vitro* (Prince et al., 2000) and for possible human immunodeficiency virus (HIV) treatment (Lavie et al., 1995). Hypericin also exhibited serotonin uptake inhibitory activity and, thus, may contribute to antidepressive activity (Muller et al., 2000). The biological activities of the dianthrones in *H. perforatum* are thought to be a result of their photodynamic properties (Diwu, 1995; see also Chapter 11 in this text). **Hyperforin** and related phloroglucinol derivatives were identified as the probable antidepressive components of therapeutically used alcoholic *Hypericum* extracts (Singer et al., 1999). Hyperforin is one of the major components (2 to 4%) of the dried herb. Hyperforin was reported to be a main antibiotic constituent of crude *H. perforatum* extracts (Schempp et al., 1999). Recently, a novel activity of hyperforin, namely, its ability to inhibit the growth of tumor cells by induction of apoptosis, was reported as well (Schempp et al., 2002). Crude extracts of *H. perforatum* contain a number of other constituents with documented biological activity, including chlorogenic acid, a broad range of flavonoids, essential oil components, and xanthones.

### 7.3.2.2 Hawthorn (*Crataegus* spp.)

A genus in the rose family, *Crataegus* is now recognized to have about 280 species. This plant group embodies the concept of endless variation with numerous hybrids and other variants in existence. Even



though 60 or more species are known from Europe and Asia, North America is the center of distribution and diversity for the genus (Sticher and Meier, 1998).

Hawthorns are large shrubs or small trees, usually with dark brown bark, flaking in scales. A prominent feature of the branches is stout or slender, solitary or branched spines. The white, and sometimes red, usually foul-smelling flowers are born toward the ends of the leaf branches in round-top clusters. The fruits, perhaps more showy than the flowers, are rounded, oblong, or pear-shaped, relatively small (the size of a large cultivated blueberry fruit [*Vaccinium* spp.]), and range from orange-yellow, scarlet, red, yellow, blue, to black in color. The flesh is mealy and dry, like that of rose hips (*Rosa* spp.).

One of the most extensively planted hawthorn species is the English hawthorn, *Crataegus laevigata* (syn., *C. oxyacantha*). It is distinguished by its three- to five-lobed leaves and blossoms with a purplish tint. Several species of hawthorns are recognized as sources of medicinal compounds. In Europe, one-seeded hawthorn, *Crataegus monogyna*, is used along with *C. laevigata*. The leaves, flowers, and fruits of these two species are used in European herbal traditions. Both of these species occur throughout Europe. Occasionally, other hawthorn species are used, such as *Crataegus pentagyna*, which is native to the Balkan Peninsula. A common species of the eastern Mediterranean region, *Crataegus azarolus* is sometimes used in herbal medicine. Black hawthorn, *Crataegus nigra*, has been the species of choice in eastern European countries, where it is grown on a commercial scale.

Hawthorn leaves, flowers, and both green (unripe) and red (ripe) berries are used to make herbal preparations to treat patients with severe heart disease. Some secondary metabolites synthesized in *Crataegus* (hawthorn) species recently received attention, especially due to their vasoactive properties (Weihmayr and Emst, 1996). Flavonoids and proanthocyanidin oligomers are thought to be the active principles in *Crataegus* spp. A mixture of flavonoids and proanthocyanidins extracted from *Crataegus monogyna* and *C. laevigata* relax vascular tone or increase production of cyclic guanosine monophosphate (cGMP) in the rat aorta, but flavonoid components of *Crataegus* extracts, namely, hyperoside, rutin, and vitexin, do not affect vascular tone (Kim et al., 2000). Hawthorn extracts were also shown to increase myocardial contractility, reduce reperfusion arrhythmias, dilate peripheral arteries, and mildly decrease blood pressure (Von Eiff et al., 1994; Zhang et al., 2001; Weihmayr and Emst, 1996). A standardized extract of the leaves and flowers is approved by the German Commission E for treatment of heart failure (Sticher and Meier, 1998). It is widely used in Europe, especially in Germany, as a cardiotonic in the treatment of chronic heart failure and high blood pressure (Schussler et al., 1995; Weihmayr and Emst, 1996).

Many phenolic compounds in these plants possess antioxidant activity and may help protect cells against the oxidative damage caused by free radicals (Rakotoarison et al., 1997; Zhang et al. 2001; Kirakosyan et al., 2003a). The phytoactive secondary compounds present in hawthorn are flavonol derivatives and flavonoids (Rohr and Meier, 1997; Chang et al., 2001). The flavonols are chains of **catechin** or (–)-**epicatechin** linked by 4 → 8 or 4 → 6 bonds (see Chapter 1 for examples). The primary flavonoids present in hawthorn include **vitexin-2-O-rhamnoside**, **acetyl vitexin-2-O-rhamnoside**, **vitexin**, **isovitexin**, **quercetin**, **hyperoside**, and **rutin** (Sticher and Meier, 1998).

Currently, commercial preparations, primarily manufactured in Europe, are calibrated to contain flavonoids, **oligomeric proanthocyanidins**, and chlorogenic acid, among other constituents. Timing of harvest as well as plant part used are important factors to consider when developing hawthorn drugs. For example, as much as three times the amount of proanthocyanidins are found in the autumn leaves, compared with those harvested in spring.

### 7.3.2.3 Legumes

Many edible legumes in the bean family (*Fabaceae*) are important sources of **isoflavone** secondary metabolites (Kaufman et al., 1997) and of soluble dietary protein.

Over 80 taxa of mostly agriculturally important legumes were surveyed as sources of the isoflavone metabolites **genistein** and **daidzein** by Kaufman et al. (1997). All legumes, with the exception of fermented soybean miso, had genistein levels <0.4 mg·g<sup>-1</sup> dry weight. Different concentrations of genistein and daidzein and their respective glucoside conjugates, **genistin** and **daidzin**, were found in the stems of the fava bean (*Vicia faba*) and roots of kudzu vine (*Pueraria montana*). The results indicate that the legumes, lupine (*Lupinus* spp.), kudzu (*Pueraria montana*), fava bean (*Vicia faba*), and soybeans (*Glycine max*)

are excellent food sources for both genistein and daidzein. Miso, a fermented soybean product, is also a rich source of both isoflavones. In addition, estimation of isoflavones from other legumes — such as adzuki beans, fenugreek, tepary beans, fava beans, soybeans, alfalfa, red clover, cowpeas, black gram, lentils, garbanzo beans (or chickpeas), and licorice — was successfully carried out by the same authors.

Kudzu (*Pueraria montana*) is one of the earliest leguminous medicinal plants used in traditional Chinese medicine. It has many profound pharmacological actions, including antidiabetic (antialcohol abuse) activity. The active constituents in this leguminous plant are the same isoflavones mentioned above and **puerarin**. In our studies (Lal et al., 2003; Kirakosyan et al., 2003b), kudzu (*Pueraria montana*) turned out to have unusually high levels of genistein and daidzein isoflavones as compared with almost all other edible legumes examined. Because of this observation, the fact that kudzu is widely used in Oriental medicine, that legume seeds and seedlings are good sources of soluble proteins, and that kudzu is a very serious weedy vine pest in southeastern forests of the United States (Kaufman et al., 2002), this plant should be explored in more detail as a potentially good source of medicinally important isoflavonoids and soluble protein.

#### 7.3.2.4 Flax (*Linum spp.*)

Flax in the genus *Linum* (the family Linaceae) is one of the earliest-grown medicinal herbs. Its seed, known as linseed, is being widely employed in medicine. There are more than 200 *Linum* species found throughout the world. It has been cultivated in all temperate and tropical regions for so many centuries that its geographical origin cannot be identified, for it readily escapes from cultivation and is found in a semi-wild condition in all the countries where it is grown.

Flax is a graceful little plant with turquoise blue blossoms. The stems are usually solitary, quite smooth, with alternate, linear, sessile leaves.

It is best treated as a farm crop. Being quickly grown and quickly harvested, it can be grown after a winter root crop and harvested in time to secure a “**catch crop**” for the following season. The fruit is a globular capsule, about the size of a small pea, containing in separate compartments ten seeds, which are brown (white within), oval to oblong, and flattened, pointed at one end, and shiny and polished on the surface.

Lignans constitute a large group of secondary metabolites synthesized by many plants. Several hundred species of lignans were identified. These compounds are usually formed from two phenylpropanoid units (Middel et al., 1995; Ward, 1995) and manifest high biological activities. The lignan, podophyllotoxin, is used for the semisynthesis of the anticancer drugs, **etoposide**, **teniposide**, and **Etopophos**<sup>®</sup> (Petersen and Alfermann, 2001). The chemical synthesis of pharmacologically important lignans is complicated and not cost effective. Therefore, numerous attempts were made to obtain lignans from wild-grown plants and from cell and suspension cultures (Ward, 1995; Petersen and Alfermann, 2001). **Podophyllotoxin (Ptox)** is usually isolated from *Podophyllum hexandrum* and *P. peltatum*, which contain 0.2 to 4% Ptox on a dry weight basis. However, the stock of *Podophyllum* is restricted, and its roots, which usually store Ptox, must grow for 5 to 7 years. Plants from the genus *Linum* (the family Linaceae), with their ability to synthesize and accumulate lignans both in intact plants and in callus cultures, provide an additional source of Ptox. Hence, several *Linum* species may become a source of podophyllotoxins (Petersen and Alfermann, 2001). Therefore, researchers are attempting to delineate the biosynthetic pathway of podophyllotoxin in *Linum* cell suspension cultures with the aim of manipulating this species genetically to enhance podophyllotoxin accumulation. Moreover, cell cultures of *Linum* species accumulate podophyllotoxin and **6-methoxypodophyllotoxin** as glycosides (Smolny et al., 1998).

### 7.3.3 Different Aspects of the Exploration and Sustainable Exploitation of Plant Biodiversity

Plants contain more than 100,000 known natural organic constituents, many of which are valuable phytopharmaceuticals (Robinson, 1991; Kaufman et al., 1999). Natural products chemistry, as defined today, involves many studies on biosynthesis, isolation, structure determination, and investigation of biological properties of secondary metabolites (Torssell, 1997; Dewick, 1998). The levels of these compounds vary greatly, depending on what plant parts are collected at what time of year; environmental

conditions prevailing during the growing season; incidence of pathogen, insect, and herbivore attack; how plants or plant parts are collected and preserved; and what species, or even cultivars, are chosen for collection. Many plants have been overcollected in the wild, making them rare or endangered (e.g., ginseng [*Panax ginseng*] and goldenseal [*Hydrastis Canadensis*]). Some are invasive species, like kudzu (*Pueraria montana*). Some have poisonous constituents that can only be used safely as medicines after proper treatment during extraction or formulation (e.g., tree of joy, *Camptotheca accuminata*). But, can we grow these plants in a safe, sustainable way in order to obtain the value-added phytopharmaceutical constituents in abundance in an efficient and consistent manner? The answer is yes. But to do so requires controlled environmental growing conditions, suitable biomass, clear-cut knowledge of the chemical nature of the constituents of interest and how they are extracted and analyzed, and ways by which the levels of the constituents of interest can be upregulated to maximize their yield.

The availability of sources of biodiversity, however, is presently a major limiting factor. The largest numbers of plant species occur in third-world countries that do not have the resources for conducting an extensive screening of their national biodiversity. On the other hand, negotiations over revenues with pharmaceutical companies interested in screening the biodiversity are not easy due to the huge value of making biodiversity available for screening and considering the property rights of indigenous peoples (see Chapter 14).

Plant cell culture extracts are an interesting option for screening, as they are easy to scale up when an interesting activity is found (McAlpine et al., 1999). Moreover, plant cell cultures can be made from rare and endangered plant species to ensure the production of compounds from those plants that show interesting activities.

Besides the more or less random screening of organisms for biological activity, one can also look at ecological leads for biological activity (Verpoorte, 1998, 1999). For example, young leaves and seedlings are expected to be more strongly protected against predators by, among other factors, secondary metabolites, than older parts of a plant. For example, we found very high levels of isoflavones (daidzein and genistein and their respective glucosyl conjugates, genistin and daidzin) in seedlings of kudzu vine as compared to the levels found in much older parts (e.g., roots, leaves) of kudzu plants (Kirakosyan et al., 2003b).

### 7.3.3.1 *Methods for Phytochemical Screening and Testing of Biological Activity of Plant Extracts*

Exploration of nature's chemodiversity has changed dramatically in recent years because of the introduction of **high-throughput screening (HTS)** methods (for review, see Verpoorte, 1998, 2000). However, the structural diversity arising from synthetic chemistry will never match that which occurs in nature. A novel active compound like **paclitaxel**, with 11 asymmetric carbons, will never be designed in a synthetic laboratory. Thus, HTS offers new possibilities for developing drugs from natural products. It allows for the rapid screening of large numbers of extracts, and it is suitable for bioassay-guided fractionation (see Chapter 10), which in the past was the major bottleneck in studies of active compounds in plant extracts. In Chapters 8 and 9, the most important current analytical methods for natural product extraction and characterization are presented in detail. A special case in point is provided below for extraction efficiency of polyketides in St. John's wort, *H. perforatum*.

### 7.3.3.2 *Case Study: Evaluation of Extraction Efficiencies for H. perforatum Chemistries*

Many solvents were used to extract hypericin from plant material, including methanol (both 80 and 100%) (Brolis et al., 1998; Mauri and Pietta, 2000), acetone (Bladt and Wagner, 1994), an ethanol–acetone mixture (Liu et al., 2000a), a mixture of methanol–acetonitrile (Gray et al., 2000), and a methanol–acetone mixture (Piperopoulos et al., 1997). Hexane (Verotta et al., 2000), heptane (Erdelmeier et al., 1999), acetone (Maisenbacher and Kovar, 1992), ethanol (Trifunovic et al., 1998), methanol, and a methanol–acetonitrile mixture (Gray et al., 2000) are all solvents that have been used for hyperforin extraction. Two reports compared the effectiveness of multiple solvent extraction procedures (Kurth and Spreemann, 1998; Liu et al., 2000b). Kurth and Spreemann compared water, 30% ethanol, 60% ethanol, 100% ethanol,

80% methanol, and 100% acetone to determine the efficiency of hypericin extraction. They reported that 60% ethanol is a better extraction solvent for optimum recovery of hypericins. Extraction with 80% methanol gave only 68% recovery, as compared with 60% ethanol, while acetone gave only 36% recovery (Kurth and Spreemann, 1998). They did not, however, report statistical differences. With respect to the experimental protocol, there may not be significant differences between solvents.

A recent report by Liu et al. (2000b) stated that the best extraction solvent for optimum recovery of hypericin alone was either acetone or 50:50 acetone:ethanol. In addition, these researchers reported that extraction with 50% ethanol was only 14% as efficient as compared with either acetone alone or the 50:50 acetone:ethanol mixture, while 100% ethanol was only 57% as good. Kurth and Spreemann (1998) also reported on the extraction efficiency of hyperforins; 95% ethanol extracts produced the highest recoverable amounts of hyperforin. When comparing the extraction efficiencies of various solvent systems for the optimum extraction of hyperforin, Orth et al. (1999) reported that petroleum ether is the ideal solvent for hyperforin recovery. Hexane and heptane were 94 and 97% as efficient as compared with petroleum ether, respectively. They also tested polar solvents, including 100% methanol, which was 92.5% as efficient as compared with petroleum ether.

Kirakosyan et al. (2003c) found that extractions using either 80% acetone or acetone:methanol (50:50) resulted in slightly higher levels of hypericins, although all extractions using 100% methanol, 80% methanol, or 100% acetone were statistically similar. Hyperforin extraction efficiencies were highest when extraction was conducted with 100% acetone or 100% methanol. With respect to time, recovery of both hypericins and hyperforin increased with extraction time. However, prolonged exposure to solvent resulted in the complete degradation of both hypericins and hyperforins.

### 7.3.4 Chemotaxonomy and Its Relationship to Secondary Metabolism

Natural products research is, by nature, multidisciplinary. Systematic botany and organic chemistry, for example, aim to elucidate the systematic position and the evolutionary differentiation of many medicinal plant families. Therefore, noteworthy aspects of natural products research may include organic chemistry related to the chemical synthesis of natural compounds, biosynthetic studies concerning metabolic pathways, chemotaxonomy, ethnobotany, bioengineering, molecular biology, and drug development.

Accurate and simple determination of **chemotaxonomy** can be attributed to the science of describing plants by their chemical nature. This interdisciplinary scientific field combines molecular phylogenetic analysis with metabolic profiling. Furthermore, it helps to investigate the molecular phylogeny and taxonomy of plants and to investigate the structural diversity of unique secondary metabolites only found in endemic species. In addition to the evaluation of some compounds as chemotaxonomic markers, one can focus on the structural elucidation of these unique secondary metabolites, applying modern techniques of analysis (see Chapters 8 and 9). This is based on the use of a range of analytical techniques (various kinds of chromatography, high-performance liquid chromatography [HPLC], mass spectrometry [MS], nuclear magnetic resonance [NMR], circular dichroism [CD]) to clarify the systematics of some critical groups and to map the distribution of the plants according to different edaphic-environmental conditions. Sequencing of nuclear DNA (**ITS** and **5S NTS**) and chloroplast gene (**trnK intron** and **trnL-trnF IGS**) markers turns out to be a reliable tool to establish the phylogenetic relationships within a genus, based on cladistic methods (**parsimony** and **maximum likelihood**) (DeBry and Abele, 1995). The work carried out so far allows one to highlight a number of regional species that are high in biologically active substances and to clarify the systematic aspects of various groups on a chemical basis.

Two main directions in chemotaxonomic research are currently in progress: (1) the characterization of biologically active secondary metabolites as taxonomic markers and (2) the identification of substructures.

The identification of substructures and parts of structures has several applications in organic chemistry. Two research fields that apply the concept of structures are computer-assisted structure elucidation and chemotaxonomy. In both fields, the implementation of computer programs involves chemists, mathematicians, and computer engineers. The consequent interdisciplinarity of the problems results in a great challenge. Substructures, allied to other biochemical inferences, are the main tools for chemotaxonomy methodology, and they may be useful to discriminate genera and, to a lesser extent, species. Previous studies demonstrate the validity of the **polyprenol spectrum** as a chemotaxonomic criterion (Swiezewska

et al., 1994). While studying plants grown in various habitats, researchers have encountered variations of polyprenol content in leaves of plants of a given species. Several possible ecological factors might have been responsible for this phenomenon.

To accomplish the recognition of substructures for classification purposes in chemotaxonomy and evolution, new and different programs were developed. They permit realization of a search, at a determined botanical rank (family or genus), by chemical category, such as chemical class, carbon skeleton type, and functional groups (Jenett-Siems et al., 2005). These programs are stored in a database especially designed for chemical data. The wide application of such programs to natural products chemistry is due to the great diversity of compounds already recorded in this field of science, as well as the great number of plants chemically studied in laboratories. **Skeletons** are different carbon arrangements exhibited by a determined chemical class. Twenty **chemical classes** are large groupings of natural products possessing a common biosynthetic origin — the same chemical precursor. For chemists who deal with natural products chemistry, the concept of skeletal types is frequently used for taxonomic and structural determination purposes.

The structure types to be defined include (1) **chemical classes**: triterpene, diterpene, monoterpene; (2) **carbon skeletons**: lupane, clerodane, menthane, for example; and (3) **substructures** (parts of structures): functional groups, such as hydroxyl or carbonyl, and sets of interlinked atoms, such as an acetate, an aromatic, or a furanic ring, among others. One or various chemical classes can occur among plant families or genera. These include the occurrence of a specific skeleton or various skeletons belonging to a chemical class and the occurrence of one or various substructures in one chemical class or on a specific skeleton belonging to a given chemical class. This kind of approach enables one to verify, for example, whether an accumulation of a preferential skeleton exists in some genera of a given family.

With such new program developments, the methodologies allow one to search for requirements, such as chemical classes, carbon skeletons, and substructures at a determined level, in botanical classification. This kind of program permits one to correlate botanical information with chemical constraints. Thus, the results obtained can help forthcoming chemosystematic and evolutionary studies. Because chemosystematics and evolution papers usually comprise studies on the occurrence of compounds at several hierarchical levels, this approach makes powerful computer programs essential in performing basic chemotaxonomic tasks.

---

## 7.4 Plant Cell Biotechnology for the Production of Secondary Metabolites

The presence of valuable chemicals in plants stimulates interest on the part of industries in the fields of pharmaceuticals (as drug sources), agrochemicals (for the supply of natural fungicides and insecticides), nutrition (for the acquisition of natural substances used for flavoring and coloring foods), and cosmetics (natural fragrances).

The world market for biotechnological products increased greatly in recent decades. For example, in 2000, biopharmaceuticals represented a global market valued at over \$12 billion (U.S. currency). Since then, the industry has expanded considerably, despite being severely limited by the manufacturing capacity and cost of the production systems currently in place. Therefore, an alternative source for desired secondary metabolites is of great interest. Cell and tissue cultured plant materials can be an attractive alternative as a production system and as a model system with which to study the regulation of natural product biosynthesis in plants to ultimately increase yields. Thus, plant biotechnology can supply information to optimize phytochemical production in plant cell and tissue culture through sustainable, economically viable cultivation. However, trials with different plant cell cultures initially failed to produce high levels of the desired products.

Several medicinal plants are employed in our studies concerning plant cell biotechnology. These include Hawthorn (*Crataegus*), which produces **proanthocyanidins** and several kinds of **flavonoids** used for the treatment of heart disease; St. John's wort (*Hypericum perforatum*), which produces antidepressant and anticancer compounds like **hyperforin** and **hypericins**; flax (*Linum* spp.), for the production of cytotoxic **lignans** such as **podophylotoxin** and **5-methoxy-podophylotoxin** (see chemical structures in Chapter

12); kudzu (*Pueraria montana*) as a source of **isoflavones**, **daidzein**, **genistein**, and their respective glucoside conjugates, **daidzin (daidzein-7-O-glucoside)** and **genistin (glucosyl-7-genistein)** plus **puerarin (daidzein-8-C-glucoside)**. Each of these plants made important contributions to the pharmaceutical industry. In all plant cell studies, the upregulation of biosynthesis processes of several compounds using genetic and epigenetic approaches are now being considered as viable approaches.

#### 7.4.1 Factors Determining the Accumulation of Secondary Metabolites by Plant Cells

The failure to produce high levels of the desired products by cell cultures is mainly due to our insufficient knowledge of how plants regulate natural product biosynthesis. It is important to elucidate the factors that control the accumulation of secondary metabolites in particular plant species.

Biotic factors are among the environmental factors that affect to a greater extent the production of phytochemicals. Therefore, it is highly probable that there is a relationship with defensive responses that is manifested either in **phytoalexin** production or in compounds produced along the signal transduction pathway (see Chapter 3). An approach to characterize the biotic parameters that may elicit the plant's defensive mechanisms may be revealed by an analysis of the expression of certain genes involved in the process and by correlation of gene induction with particular metabolite levels.

Applied environmental stress factors along with biotic factors can affect the upregulation of biosynthesis of secondary metabolites both in intact plants and in cell cultures. For example, in our investigations, two species of *Crataegus* (hawthorn) were chosen for applied environmental stress treatment experiments to enhance the levels of polyphenolics in the leaves of hawthorn intact plants. One-year-old plants of hawthorn (*Crataegus laevigata* and *C. monogyna*) were subjected to water deficit (continuous water deprivation), cold (4°C), flooding (immersion of roots of plants in water), or herbivory (leaf removal) stress treatments (each of 10 days duration) in order to assess their effects on levels of polyphenolics, namely, (–)-**epicatechin**, **catechin**, **chlorogenic acid**, **vitexin**, **vitexin-2-O-rhamnoside**, **acetylvitexin-2-O-rhamnoside**, **hyperoside**, **quercetin**, and **rutin** in the leaves. Cold stress causes increases in levels of vitexin-2-O-rhamnoside, acetylvitexin-2-O-rhamnoside, hyperoside, and quercetin in both *Crataegus* species. Water deficit stress increases the production of chlorogenic acid, catechin, and (–)-epicatechin in both hawthorn species. Flooding and herbivory cause no net increases and, in some cases, decreases in levels of polyphenolics. These studies indicate that either water deficit stress or cold stress treatments, or a combination of the two, can be used to enhance the levels of desired polyphenolics in the leaves of these two hawthorn species (Kirakosyan et al., 2004b). Moreover, these kinds of stress treatments can enhance the levels of important secondary metabolites and their total **antioxidant activities** in leaves of *Crataegus* (Kirakosyan et al., 2003a). Such environmental stress factors could also positively influence secondary metabolite biosynthesis in *in vitro* cultures derived from young leaves of hawthorn.

A second example concerning environmental and genetic factors that we would like to highlight concerns St. John's wort and its biosynthesis of polyketides. The biosynthesis of secondary metabolites, such as **hypericin**, **pseudohypericin**, and **hyperforin**, may be influenced by genetic, metabolic, and environmental parameters (see discussion in Section 2.5.4 in Chapter 2). Several studies reported variation in hypericin levels in *H. perforatum* in Australia, Nova Scotia, Switzerland, and the United States (reviewed by Kirakosyan et al., 2004a). There has only been one investigation attempting to dissect the chemical composition of field-grown clonal accessions of *H. perforatum* as influenced by the environment or as a result of genetic variation (Buter et al., 1998). In addition, other important factors thought to affect or modulate the production or yield of hypericins include climate, stage of plant development, method of processing and storage, epigenetic factors, methods by which the plant material is harvested and processed, and differences in extraction and analysis techniques (reviewed by Kirakosyan et al., 2004a).

The effects of both environmental and genetic factors were also found to influence the levels of these metabolites in field-cultivated *H. perforatum* (Buter et al., 1998). Kirakosyan et al. (2003c) examined populations based on phytochemical analysis and identified parameters that may enhance production. For example, having more leaf surface in comparison to stem tissue in the sample shifts the proportion of hypericin recovered. This is because of the fact that the glands containing hypericin are generally

located along the leaf margins. Branching and gland number per leaf are not affected, which was corroborated in another study (Cellárová et al., 1992).

Hypericin and other related compounds vary to a greater extent in **somaclones** originating from the same genotype than between different genotypes (Cellárová et al., 1994). The biosynthesis of **dianthrones** and **phloroglucinols** was also studied with *in vitro*-grown *H. perforatum* seedlings at early stages of development (Kosuth et al., 2003). Here, it was estimated that peculiarities in reproductive development pathways do not primarily affect the formation of secondary metabolites but could significantly contribute to genetic variation (Kosuth et al., 2003). Several other factors can influence the production of hypericins and hyperforin. These include light intensity, light quality, and temperature (reviewed by Kirakosyan et al., 2004a). The effect of light intensity on the levels of leaf hypericins was examined for *H. perforatum* grown in a sand culture system with artificial lighting (Briskin, and Gawienowski, 2001). This study clearly demonstrated that increasing the light intensity results in a continuous increase in the levels of leaf hypericins. In shoot cultures, hypericin and pseudohypericin levels were not significantly different from each other when plants were grown either in direct light ( $185 \mu\text{E}\cdot\text{m}^{-2}\cdot\text{s}^{-1}$ ) or under partial light ( $88 \mu\text{E}\cdot\text{m}^{-2}\cdot\text{s}^{-1}$ ), although a general trend indicates that lower light levels may cause an increase in hypericin and pseudohypericin biosynthesis, especially in the case of pseudohypericin in plantlets grown at  $25^\circ\text{C}$  (Sirvent, 2001). The effect of light is closely connected with the effect of temperature, but the differences in these reports may also be due to the use of different cell lines or different types of cultures or to differences in extraction and harvest methodologies.

The role of the cell cycle in plant secondary metabolism also received little attention. A number of factors contribute to the efficiency of recombinant protein expression in plants. Parameters such as transient versus stable expression, codon optimization, organelle targeting, tissue-diverse versus tissue-specific expression, and activatable/inducible versus constitutive expression, should all be taken into consideration when designing a plant-based expression system.

#### 7.4.2 Plant Cell Culture as a Method for Studying Biosynthesis and the Production of Secondary Metabolites

Plant cell culture provides an opportunity for extensive manipulation to enhance production of natural products over levels found in intact plants and to identify parameters for enhancing productivity. It is possible to gain knowledge of the mechanisms that regulate the metabolic flux by carefully manipulating plant cell culture conditions and by genetically engineering the plant cells. These approaches offer the possibility to elucidate biosynthetic pathways and to quantify the flux of biosynthetic intermediates through a pathway. They also allow one to become acquainted with the techniques and equipment used to monitor metabolic flux in plant cell cultures.

Consequently, the development of an information base on a cellular and molecular level can be a good strategy. Using established cell cultures, it is possible to define the rate-limiting step in biosynthesis by determining the accumulation of presumed (labeled) intermediates, characterizing the limiting enzyme activity, and relating it to the corresponding gene for eventual manipulation (see Chapter 3). Generally, this approach works for known pathways. Therefore, step-by-step identification of all enzymatic activities that are specifically involved in the pathway is more appropriate and was carried out successfully. It is also common that blockage of one pathway leads to diversion of the substrate to alternative pathways. This would make it very difficult to identify the rate-limiting step in synthesis of a particular metabolite. It may also be that the pathway is subject to developmentally controlled flux at entry, as, for example, through the activity of **transcription factors** (see Chapters 3 and 5). This kind of research must, therefore, focus on metabolic regulation by first establishing the pathways at the level of intermediates and enzymes that catalyze their formation. The subsequent step is the selection of targets for further studies at the level of the genes. The studies on regulation of metabolite biosynthesis might eventually lead to transgenic plants or plant cell cultures with an improved productivity of the desired compounds. This knowledge is also of interest in connection with studies on the role of secondary metabolism for plants, and may contribute to a better understanding of resistance of plants to diseases and various herbivores.

### 7.4.3 Strategies to Improve Metabolite Production

Zenk and co-workers (1977) suggested a strategy to improve the production of secondary metabolites in cell cultures that is being used by many researchers today. This strategy for the improvement of secondary metabolite production in plant cell cultures generally includes the following:

- Screening and selection of high-producing metabolite cell lines
- Analysis of culture conditions that enhance production levels of the metabolites of interest

What has changed in recent years? More important tools, such as new approaches based on genetic and metabolic engineering, were introduced. Noteworthy, Zenk's strategy involves whole aspects of research connected to plant cell culture. These include the following general steps: (1) plant screening for natural products accumulation; (2) use of high-producer plants for initiation of callus cultures; (3) analysis of derived cultures; (4) establishment of cell suspension cultures; (5) analysis of metabolite levels in cell suspension cultures; (6) selection of cell lines based on single cells; (7) analysis of culture stability; and (8) further improvement of product yields. However, follow-up research employing this strategy was marginally successful. This is based on the fact that not all desired natural products can be produced by plant cell biotechnology. For instance, only a few compounds, such as **shikonin**, **berberin**, **vinblastine**, **vincristine**, and **Taxol®** have had successful industrial applications to date. The limited production of other constituents by plant cell and tissue cultures was reviewed by Alfermann and Petersen (1995) and Verpoorte et al. (1994). We still do not know why the production of some compounds, like those just cited, can be feasibly employed in large-scale processes, whereas the production of other compounds, using this same approach, is either impossible or not economically feasible for industrial trials.

This strategy also focuses on developing cultures from elite germplasm and optimizing production strategies for important plant constituents through genetic and culture manipulations. Therefore, the aim of comparative studies of different medicinal plants is to obtain a detailed biochemical analysis on genetically distinct populations to identify superior plant germplasm sources. In this connection, investigators are able to take advantage of the wide range of biosynthetic capacities within cultures, either by selection or by screening germplasm for highly productive cell lines, as for example, in the production of Taxol from *Taxus* cell cultures (Kim et al., 2005).

Our recommendation to improve secondary metabolite production in *in vitro* plant cultures is based on optimization of production strategies being introduced for particular plant constituents. For example, for hypericin production, as an alternative way for growing cultures, we developed a new way to grow shoot cultures as morphologically differentiated structures containing high-value metabolites continuously. This study is directed toward delineating the optimal conditions for production of economically viable amounts of given phytochemicals. Such optimization of culture conditions includes a variety of media formulations and environmental conditions. These variables to be tested include light intensity and quality; temperature; length of culture period, including kinetics of production; concentration and source of major limiting nutrients, such as phosphate, carbon, and nitrogen; concentration and source of micronutrients, vitamins, and plant growth regulators; and presence or absence of fungal or bacterial elicitors.

Once *in vitro* plant cultures are established for the production of economically viable amounts of the phytochemicals, the development of a transformation system will expedite genetic enhancement of such cultures to further increase yields for greater profitability.

#### 7.4.3.1 Selection of Elite Germplasm for an Efficient Production System

The vast majority of medicinal plants are collected in the wild in a process known as **wildcrafting**. Likewise, the genetic potential for many medicinal plants has yet to be tapped to identify **superior germplasms**, whether for traditional cultivation or for derivation of superior plant cell culture lines. However, as the market expands, and as new clinical trials expand market size, there is a vast opportunity to introduce more economically viable and environmentally sustainable production strategies using genetically superior material for production of phytochemicals.



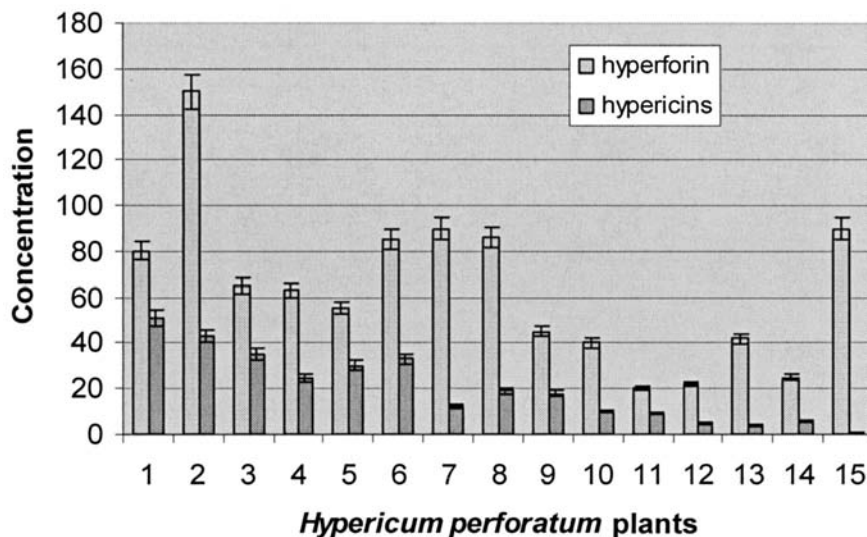

**FIGURE 7.3** Variations in hyperforin ( $\text{mg}\cdot\text{g}^{-1}$  dry weight) and hypericin ( $\text{mg}\cdot\text{g}^{-1}$  dry weight  $\times 10$ ) levels present in *H. perforatum* cultivars.

Development of elite germplasm that can be manipulated for more efficient production of phytochemicals would aid in the development of plant cell culture as an alternative technology to wildcrafting and low economic return practices.

There are two examples connected to elite germplasm research that we carried out — St. John's wort (*H. perforatum*) and fava bean (*Vicia faba*). For St. John's wort, more than 15 genetically distinct populations and 10 cultivars of *H. perforatum* from Armenia and North America were surveyed to identify superior plant germplasm as sources of the secondary metabolites, **hypericin**, **pseudohypericin**, and **hyperforin** (Kirakosyan et al., 2003c). Remarkably high concentrations (over 15% of dry weight) of the antidepressive metabolite, hyperforin, was found in one *H. perforatum* population collected in Armenia, while North American samples and cultivars showed high levels of hypericins, up to 0.23% of dry weight (Figure 7.3). Results from *in vitro* studies indicated that shoot cultures derived from such elite germplasms are excellent sources for both hypericins and hyperforin. Concentration levels in shoot cultures were increased for hypericins up to six-fold (1.4% of dry weight), while the levels of hyperforin were lower than those from wild-collected or greenhouse-grown plants. In another plant study (fava bean), we made a comparison of levels of **L-dopa (3,4-dihydroxy-L-phenylalanine)** and isoflavones (**genistein**, **genistin**, **daidzein**, and **daidzin**) in seedlings of 24 different cultivars of *Vicia faba* (Kirakosyan et al., 2004c). The concentrations of L-dopa, genistein, daidzein, and their glucosyl conjugates in each cultivar of *V. faba* plants were analyzed. The data indicate that there is wide variation between cultivars in the amounts of L-dopa analyzed. In connection with the use of *V. faba* as a source of L-dopa (one of the major compounds in *V. faba*) to treat patients with Parkinson's disease, the current investigation indicates great variation in the levels of this compound in different cultivars (Figure 7.4).

However, a word of caution is necessary here — because of the large variation that we observed in L-dopa and isoflavone levels in seedlings of more than 24 different cultivars of *V. faba* derived from different geographic locations worldwide, one must know the *V. faba* cultivar being used, have an assay of its L-dopa or isoflavone levels from a reliable source, and make dosage recommendations based on the assay provided.

#### 7.4.4 Micromanipulation of Higher Plant Cells for Production Systems

Plant cell culture may be a reasonable candidate for commercial realization if the natural resources are limited, *de novo* synthesis is complex, and the product has a high commercial value. Over the past 20

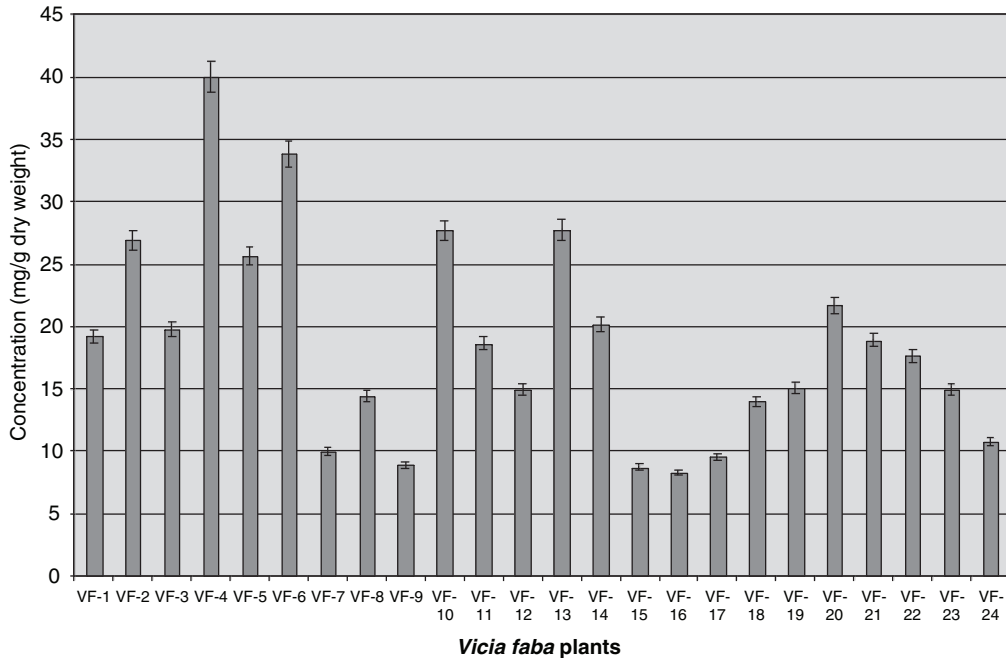

FIGURE 7.4 Comparison of L-dopa levels in 24 different cultivars of *Vicia faba* L.

years, advances were made toward enhancing productivity in plant cell culture. Initial attempts included applying selection pressure for faster-growing and better-producing cell lines, optimizing media, and utilizing multistage production, where cells are initially cultured to optimize growth and then are switched to media optimized for productivity.

#### 7.4.4.1 Elicitation

More recently, emphasis was placed on the use of elicitors (see also Chapter 3) that can trigger the defense response to induce overproduction of valuable secondary metabolites in plants or plant cell cultures.

Elicitation was originally accomplished by adding crude fungal cell-wall extracts to cell cultures (Radman et al., 2003). Induction can be mediated within plant tissues by **salicylic acid (SA)**, **jasmonic acid (JA)**, and possibly **nitric oxide** (reviewed by Kirakosyan et al., 2004a). The methyl ester of JA, **methyl jasmonate (MeJA)**, is known to enhance the production of phytoalexins and genes involved in their synthesis, including various alkaloids, flavonoids, terpenoids, and anthraquinones (Blechert et al., 1995). SA was reported to induce various defense responses, including **PR (pathogenesis-related)** protein induction (Ryals et al., 1996), induction of **HR (hypersensitive response)** (Goodman and Novakcy, 1994), and induction of **nitrous oxide (NO)** (Klessig et al., 2000). The impact of different elicitors on the quantity and distribution of secondary metabolites can provide valuable information regarding biosynthetic pathways, in addition to elevating the production of a desired compound (Moreno et al., 1996).

Plant defense responses can involve both constitutive defense mechanisms, such as preformed antimicrobial compounds, as well as the activation of a variety of defense responses at the cellular level, including **induced resistance (IR)**, **systemic acquired resistance (SAR)** (Ryals et al., 1996), phytoalexin production (Hammerschmidt, 1999), and active oxygen (**reactive oxygen species [ROS]**) induction (Baker and Orlandi, 1995), needed to ward off pathogen and herbivore attacks (Agrawal, 1998). This upregulation of secondary metabolite biosynthesis by elicitors is undoubtedly a defense mechanism against predators. In this connection, the same kind of defense mechanism in plants is turned on upon the plants being challenged by nonpathogen agents, namely, **plant growth-promoting rhizobacteria (PGPR)**. Systemic induction of metabolic pathways by PGPR was described mostly in connection with

defense responses (induced systemic resistance [ISR]) in *Arabidopsis thaliana* and in other plant species (van Loon et al., 1998), but it was also related to increases in secondary metabolites with pharmacological effects in *Digitalis lanata* in a vegetative stage of development (Gutierrez Manero et al., 2003). In connection with PGPR, several bacterial strains are inoculated with plant cells or seedlings from the high-producer and low-producer lines following a randomized block design, at different time points in the plant's natural cycle. Complementary to this approach, **lipopolysaccharides (LPS)** and **exopolysaccharides (EPS)** derived from PGPR cell walls can be directly added to the cultivation medium based on evidence that they act as elicitors of systemic resistance (Ramamoorthy et al., 2001).

For example, the production of hypericins in *H. perforatum* shoot cultures can be modified by chemical elicitors. A first report indicated that **mannan** (a **glycoprotein** derived from cell walls) stimulated pseudohypericin production up to four-fold ( $0.82 \text{ mg}\cdot\text{g}^{-1}$  dry wt.) and hypericin production up to two-fold ( $0.04 \text{ mg}\cdot\text{g}^{-1}$  dry wt.). In a similar study, cork pieces (derived from cork oak, *Quercus suber*) slightly stimulated shoot growth but enhanced pseudohypericin biosynthesis about threefold (to  $0.4 \text{ mg}\cdot\text{g}^{-1}$  dry wt). It is possible that the stimulating effect of cork tissue on hypericin biosynthesis is determined by the matrix components, which are insoluble in water and organic solvents (Kirakosyan et al., 2001).

Walker et al. (2002) recently reported on the use of elicitation in cell suspension cultures for hypericin production, where the addition of JA ( $250 \mu\text{M}$ ) caused a two-fold increase of hypericin levels in cell suspension cultures only when grown in the dark, and had no effect in the light. In addition, they report that salicylic acid (SA) and fungal cell-wall oligosaccharides do not elicit hypericin accumulation in suspension cultures regardless of growth condition regimes. Sirvent and Gibson (2002) used shootlet meristem cultures to assess the effects of exposure to exogenous application of these same chemical elicitors. Levels of hypericins increased in response to both elicitor treatments, with an increase of 3.3 times control levels when treated with  $200 \mu\text{M}$  MeJA for 14 days. When plantlets were treated with  $1 \text{ mM}$  SA or  $50 \mu\text{M}$  MeJA, increased hyperforin concentrations were detected. On the basis of these results, it is likely that the elevation of hypericins and hyperforin in response to chemical and biotic elicitors is consistent with a role of these components in the inducible plant defense responses of *H. perforatum*. In addition to the abiotic elicitation caused by SA, inoculation of a fungal pathogen, *Colletotrichum gloeosporioides*, resulted in increases in hypericin, pseudohypericin, and hyperforin accumulation within the plant of up to eight times the amount found in control plants (Sirvent and Gibson, 2002).

In their recent research review, Zhao et al. (2005) summarize all progress to date made on several aspects of elicitor-mediated signal transduction mechanisms leading to production of plant secondary metabolites.

#### 7.4.4.2 Screening and Selection of Cultured Plant Cells in Order to Increase Yields of Phytochemicals

Optimization of culture conditions has been carried out in a variety of media formulations and environmental conditions. The **Plackett & Burman** technique is particularly useful in that it allows for testing of multiple variables within a single experiment (Plackett and Burman, 1946). This method relies on the following characteristics: each variable is present at a high level in half of the test cultures or at low or none in the other half; any two variables will be present in 25% of the test cultures; both will be absent in 25%; and only one variable is present in the remaining 50% of the test cultures. Because the production of secondary metabolites can be followed by HPLC, a medium can be selected that supports growth and production of secondary metabolites. Those variables to be tested can include light; temperature; length of culture period, including kinetics of production; concentration and source of major limiting nutrients, such as phosphate, carbon, and nitrogen; and concentration and source of micronutrients, vitamins, and plant growth regulators.

Screening for high productivity can be done on several levels. In some cases, high-producing plants, calli, or cell clones can be obtained from single cells, and subsequently, used for the screening of high-producing strains (Figure 7.5).

The selection of high-producing cell lines by culturing cells/tissues on media containing certain additives, such as biosynthetic precursors or toxic analogues, provides interesting possibilities (Verpoorte, 1996). However, in this case, the successes are rather limited because of the instability of many precursors

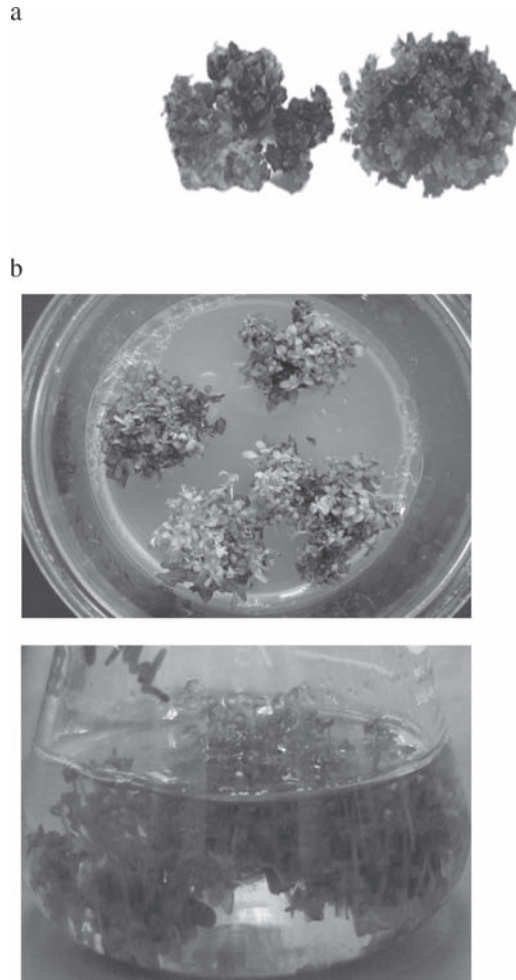

**FIGURE 7.5** (See color insert following page 256.) High metabolite producing callus (a) and shoot cultures (b) of *Hypericum perforatum*. Shoot cultures shown in (b) were cultivated on agar (top) and in liquid (bottom).

or toxic effects of some constituents to the cells. For rapid selection of high-producing cells, **flow cytometry** could be used. This technique is based on the fact that cells contain fluorescent products (e.g., **thiophenes**), and therefore, it is possible to separate these cells from others. In this case, however, some instability can accrue with persistence of the cell line, as well as with difficulties connected to cell differentiation or morphogenesis. Therefore, the stability problems of cell lines may have made researchers reluctant to develop extensive screening programs, leaving this as the last step prior to industrial application (Verpoorte, 1996).

In recent years, Kirakosyan and colleagues established different systems of cell cultures: callus, cell suspension, and organ cultures of *Hypericum perforatum* (St. John's wort), *Pueraria Montana* (kudzu), *Crataegus laevigata* and *C. monogyna* (hawthorn), and *Glycyrrhiza glabra* (licorice). Moreover, the contents of many secondary metabolites at different stages of morphogenesis and regeneration were determined (Kirakosyan et al., 2000, 2003c). These cell cultures are able to produce the desired compounds, but in extremely varied amounts. Our investigations associated with multiple shoot regeneration showed that in the newly formed leaves of *H. perforatum*, the content of hypericins is higher than in intact plants (Kirakosyan et al., 2003c). The yield of secondary metabolites from plant cultures has generally been much lower than the concentrations found in the intact plant. Poor performance of cultures can be attributed, in part, to a lack of knowledge of the regulation of secondary metabolism and the lack

of production triggers to manipulate metabolism. Since the discovery that factors that suppress growth often promote secondary metabolism, work in this field identified culture conditions and additives that can shift cultures into higher growth and secondary metabolite productivity states. Investigators were able to take advantage of the wide range of biosynthetic capacities within cultures, either by selection or by screening germplasm for highly productive cell lines. These techniques were applied in our laboratory to the production of hypericins and hyperforin in *H. perforatum* (Kirakosyan et al., 2003c). As a first step in teasing apart the contributions of genetic or environmental influences, tissue cultures were used. Whether the specific levels of the phytochemicals in the studied populations are the result of environmental influences or genetic influences or both will need to be studied further.

With plant cell cultures and intact plants, the key to success in discovering naturally occurring therapeutic agents rests on bioassay-guided fractionation and purification procedures. The screening of both synthetic organic compounds and extracts of natural products has had an impressive history of identifying active agents. High-throughput screens and sensitive instrumentation for structure elucidation greatly reduced the amount of time and the amount of sample required for the first stage of investigation (see Chapters 8, 9, and 10).

The development of medicinal plants into therapeutic drugs takes several years, and millions of dollars are needed, making the process very capital intensive. The risks are also high, and the success rate has not been very good. Despite all this, natural products drug-discovery programs are in existence all over the world, mainly because of several reasons: (1) the high chemical diversity from natural products as compared to synthetics; (2) the human-use potential of these natural products is largely unknown; (3) the large number of terrestrial and marine species yet uninvestigated; (4) the back-to-nature syndrome (see Chapter 15); and (5) modern technology and advancements made in this field in the past few years made such programs more attractive than before.

#### 7.4.5 Growth and Production Kinetics of Plant Cell Cultures in Bioreactors

A number of factors should define the choice of **bioreactor** (controlled apparatus, such as a large fermentation chamber or closed container, for growing various organisms, including plant cell cultures, that are used in the biotechnological production of value-added substances) to be used for particular plant cell culture lines. These include cell type, nature of desired products, and scale of operation. Generally, plant cell culture bioreactors are categorized into two types:

1. Those used for cultivation of primary cultures that originate from **callus tissue**
2. Those used for the cultivation of cell suspensions (e.g., cell lines already established and maintained in an Erlenmeyer flask)

In some cases, the bioreactor may be modified to grow both primary cultures and suspended cells. The main points for bioreactors and their application are to maintain sterile cultures and to set up the conditions that could affect cell growth and productivity.

Until now, some major obstacles persisted for large-scale cultivation of plant cells in bioreactors. For example, Alfermann and co-workers (personal communication) showed that it is possible to grow *Linum* (flax) cell suspension cultures in a 20 ℓ **airlift bioreactor**, where a maximal product yield of **podophyllotoxin** of up to 0.2% of the dry weight could be achieved. However, the costs of plant cell cultures in bioreactors are high, and due to the low yields, the use of these cultures is far from being economical (Smolny et al., 1998; Petersen and Alfermann, 2001).

As mentioned above, microbial contamination can stop the whole culture process in a bioreactor due to entry of microbes through exit and entry ports, air or filter valves, seals, or connections to different programmable parts.

A number of physical, chemical, and biochemical interactions exist in a bioreactor. This affects the design and setup of bioreactors for particular plant cell types and desired product production. For example, mixing rates and aeration (O<sub>2</sub> supply) have to be considered very carefully for given cell types. Cells even have different oxygen demands. There are waste and toxic product accumulations that must be considered. However, it is most important to determine the cell growth rates and product formation kinetics that depend on nutritional requirements of the plant cells.

Plant cells are sensitive to hydrodynamic stresses that depend on the type and diameter of the bioreactor, possible occurrence of shear stresses where cells are stirred by propellers, as well as the origin and physiological status of the cultivated cells. These stress conditions may inhibit cell growth and product formation. Bioreactor-based plant bioprocesses are not only an excellent model for quantitative interpretation of growth kinetics and product biosynthesis, but they can also be a vehicle for scaled-up production of valuable bioactive natural compounds, mass propagule production, and applications using genetically engineered cells and tissues.

Researchers now focus on current, compelling challenges for bioreactor-based processing of plant cell and organ cultures. Plant cell cultivation in bioreactors is far less routine than microbial cultures, despite the fact that many complex, high-value plant metabolites cannot be synthesized by simpler microbial cell culture systems. Most suspension-cultured plant cells fail to detach from one another completely after division. Instead, they form multicellular aggregates, with rigid cell walls and surface-to-volume ratios that make them more brittle than bacterial cells. The high-speed agitation required for oxygenation and mixing generates a shear stress detrimental to most plant cells. Furthermore, high rates of aeration tend to strip gaseous metabolites like CO<sub>2</sub> and ethylene (C<sub>2</sub>H<sub>4</sub>) out of the culture media, which can reduce the capacity for plant cells to produce metabolites (Schlatmann et al., 1995). Innovative problem-solving strategies and specific needs for sensors and instrumentation to streamline the bioprocess are now being explored. For example, Kim et al. (2002) describe how the biological responses of *Artemisia annua* (Sweet Annie) hairy root cultures (overall growth and incidence of **hypoxic stress**) are influenced by gas limitations in bioreactor cultures (**liquid-phase** or **gas-phase**). The roots in these studies were grown in liquid-phase bubble column and gas-phase nutrient mist reactors. The efficient exchange of gases between roots and their environment is one of the biggest challenges in bioreactor design for transformed root cultures. Gas-phase reactors can alleviate this problem as well as provide a new tool for studying the biological response of roots and other differentiated tissues to changes in the gas-phase composition. In comparison to liquid- and gas-phase reactors, roots grown in liquid (shake flasks or bubble column reactors) were under hypoxic stress. At low packing densities, the average growth rate in the bubble column reactors was higher than in the mist reactors, decreasing to comparable rates at high packing densities. In contrast, roots grown in a gas-phase reactor (nutrient mist), while not hypoxic, produce 50% less biomass (Kim et al., 2002). Further analysis showed that the average specific growth rate in the mist reactors was essentially constant and independent of the biomass concentration at the beginning of the mist mode. These results suggest that the response of the tissues to gas-phase composition are complex and need to be further studied. Meyer et al. (2002) developed image analysis strategies that are able to monitor biomass accumulation, aggregation, and changes in cell culture pigmentation over the course of a batch culture cycle. The availability of these quantitative measurement parameters permits accurate assessment of a culture's status and places the analysis of plant cell cultures on par with the detailed monitoring now routinely performed for commercial microbial fermentations. The information collected enables the identification and clear understanding of the biological and physical constraints within the process and enables the optimization of somatic embryo production planning, costing, and scheduling activities. All of these factors have to be considered in relation to scale, geometry, and configuration of the bioreactor. There are many slightly modified or novel designs of bioreactors for plant cells. A few successful bioreactor designs are described below.

#### 7.4.5.1 Batch Systems

In **batch cultivation**, an inoculum of known density is “seeded” into a specified volume of preconditioned medium in the bioreactor. Ideally, nothing is added or removed from the bioreactor during the course of cultivation. However, in practice, additions of air and acids or bases for pH control are made. Batch cultivation of suspension cells can be carried out in two types of bioreactors: **stirred tank** and **airlift reactors** (Vogel and Tadaró, 1997).

##### 7.4.5.1.1 Airlift Bioreactors

In **airlift bioreactors**, gas is introduced at the bottom of the vessel within the draught tube. A reduction in the density of the aerated contents in the draught tube results in the circulation of the culture through

the draught tube and down in the outer zone of the vessel. Advantages are that there are no moving parts or mechanical seals; there is adequate oxygen transfer; there are low hydrodynamic shear forces; and there is low power input per unit volume.

In batch operation, the temperature is controlled via a cooling jacket. pH is controlled by the automatic addition of CO<sub>2</sub> into the sparged gas or by adding NaOH. Dissolved oxygen partial pressure is controlled by varying the concentration of oxygen in the air. Foaming may be controlled by the addition of antifoam agents.

For scale-up, 10 to 2000 ℓ airlift bioreactors are used for the cultivation of cell suspension cultures. Improved oxygen transfer rates were achieved under large-scale conditions. The increase in hydrostatic pressure resulting from increased bioreactor height does not have a deleterious effect on the cells.

#### 7.4.5.1.2 Stirred Tank Characteristics

The size of the stirred tank for a given suspension cell culture process depends upon previous planning estimates and calculations. These determine the quantity of raw material necessary to meet the demands of product formation. These estimates take into consideration the following: (1) product titer; (2) yields through the purification process; and (3) losses that may occur during formulation, final fill operations, or sampling required for quality control and in process monitoring.

This information provides the total number of liters of cell culture medium required. Based on the mode operation (batch, semicontinuous, or perfusion), the batch size and batches per year can be established. The largest cell suspension cultures in operation today range from 1000 to 10,000 ℓ. Reactors of similar design on a laboratory scale and pilot-plant scale are necessary to ensure the scalability of critical parameters, provide inoculum for the larger reactors, and supply preclinical and clinical trial material prior to the commercial production phase conducted on a larger scale. Stirred bioreactors for plant cell culture can be designed in virtually any size required to meet the particular need. Stirred cell culture tanks are almost always cylindrical vessels with a ratio of height to diameter between 3:1 (Vogel and Tadaró, 1997).

In addition, a number of substrates are available for cell attachment, spread, and growth. The simplest batch systems are stationary flasks or rotating bottles made of plastic. The plastic has to be wettable and the surface treated to carry negative charges. Batch cultivation in packed bed reactors can also be carried out using surface area packing materials such as sponges, steel springs, porous ceramic particles, and calcium alginate gels. Alternatively, cells may be grown on microcarriers, which are kept in suspension in stirred tank reactors (Vogel and Tadaró, 1997).

#### 7.4.5.2 Long-Term Continuous Cultivation

An alternative approach to batch cultivation is to continuously add fresh medium to the cells and to remove either medium mixed with cells or cell-free medium from the bioreactor. As in the batch cultivation, the pH, temperature, and dissolved oxygen need to be monitored and controlled. In addition, automated pumps are required to control the addition of fresh nutrients and to remove waste and end-products (Vogel and Tadaró, 1997).

In the **continuous flow, stirred tank reactor (CSTR or chemostat)**, fresh medium is fed into the bioreactor at a constant rate, and medium mixed with cells leaves the bioreactor at the same rate. A fixed bioreactor volume is maintained, and ideally, the effluent stream should have the same composition as the bioreactor contents. The culture is fed with fresh medium containing one and sometimes two growth-limiting nutrients, such as sucrose. The concentration of the cells in the bioreactor is controlled by the concentration of the growth-limiting nutrient. A steady-state cell concentration is reached where the cell density and substrate concentration are constant. The cell growth rate ( $\mu$ ) is controlled by the dilution rate ( $D$ ) of the growth-limiting nutrient. At steady state,  $\mu = D$ , where  $D = F/V$  ( $F$  = medium flow rate,  $V$  = culture volume). The chemostat offers a useful method of manipulating the culture environment for improved cell or product yields (Vogel and Tadaró, 1997).

*In vitro* plant cell culture is currently carried out for a diverse range of bioreactor designs, ranging from batch, airlift, and stirred tank to perfusion and continuous flow systems. For a small-scale operation, both the conventional and novel bioreactor designs are relatively easy to operate. For a larger scale of

operation, problems of maintaining bioreactor sterility and providing adequate oxygen supply to the cells have yet to be resolved (Vogel and Tadaro, 1997).

#### 7.4.5.3 Large-Scale Production of Plant Secondary Metabolites in Bioreactors

The commercial-scale use of plant cell cultures is progressing rapidly. Verpoorte et al. (1994) showed that the application of plant cell cultures on a large scale in bioreactors is feasible. The drawback here concerns the price of the final product. This is mainly attributed to the slow growth of plant cell cultures, making the depreciation costs of the bioreactor the major cost-determining factor (Verpoorte et al., 1994). Some promising advances were made for several kinds of *in vitro* plant cell cultures used for secondary metabolite production. The review by Roberts and Shuler (1997) is germane to this topic. It discusses the progress achieved for paclitaxel (Taxol), where yields have improved more than 100-fold.

Another topic of interest concerns new information on **photobioreactor** design. It allows for testing and comparing the efficiency of the **two-stage photobioreactor concept** versus plant cell suspension culture and field cultivation. Here, it is also important to determine optimization parameters for enhancement of both biomass accumulation and yield of secondary metabolites in this kind of photobioreactor. However, proof is still needed that the photobioreactor concept is the most efficient way to obtain high-value secondary metabolites from plants. If this is the case, then it will be possible to develop a new way to produce high-value secondary metabolites from plants year-round under controlled environmental conditions that may give predictable yields of metabolites at low input costs. Additionally, this type of system would work admirably where farmland is becoming scarce. It could be used in urban environments on the tops of buildings. It could be powered by solar-based energy systems, such as **photovoltaic (PV)** coupled to a **hydrogen fuel cell** (where hydrogen is generated by the electrolysis of water, and there are no pollutants given off). The light-emitting diodes (LEDs), all electronic control systems, and a commercially available CO<sub>2</sub> generator can be powered by the PV/hydrogen fuel cell energy generation system. The efficiency of each production system (cell cultures versus greenhouse cultivation versus field cultivation) must be measured by the use of **input/output analysis**, as employed by chemical engineers.

---

## 7.5 Metabolic Engineering of Plant Secondary Metabolism

A new direction of research in plant cell biotechnology, namely, **plant metabolic engineering**, is currently progressing rapidly. Rational engineering of secondary metabolic pathways requires a thorough understanding of the whole biosynthetic pathway (see Chapter 2) and an unraveling of the regulatory mechanisms (see Chapters 3 and 5). Recent achievements were made in the altering of various pathways by use of specific genes encoding biosynthetic enzymes or genes that encode regulatory proteins (Maliga and Graham, 2004; Verpoorte and Memelink, 2002). In addition, new antisense genes are used to block competitive pathways. This could increase the total flux toward the desired secondary metabolites (Verpoorte et al., 2000). Shifting attention from recombinant proteins to metabolic engineering introduces new challenges. A better understanding of the basic metabolic process could be key information needed to produce high-value natural products. There is another important factor concerning the accumulation and storage of desired secondary metabolites in plants. Secondary metabolites in cell and tissue cultures are usually stored intracellularly, as for example, in vacuoles or multicellular cavities, and transporters probably play an important role in the sequestration of secondary metabolites (Kunze et al., 2002). Moreover, many biosynthetic pathways in plants are long and complicated, requiring multiple enzymatic steps to produce the desired end-product. The major aims for engineering secondary metabolism in plant cells are to increase the content of desired secondary compounds, to lower the levels of undesirable compounds, or to introduce novel compound production into specific plants.

Plant metabolism, however, concerns thousands of interacting pathways and processes. Therefore, engineering even known metabolic pathways will not provide the expected results. Extensive metabolic profiling must be more systematic and involve considerable analysis in this case. **Productive metabolic engineering**, therefore, is based on a **systems biology approach** involving integrated **metabolomics**, **proteomics**, and **transcriptomics** approaches (Carrari et al., 2003; Dixon, 2005) (see also Chapter 6).



Despite major advances in metabolic engineering, only a few secondary metabolic pathways were enzymatically characterized and the corresponding genes cloned. In this context, the biosynthetic pathways for **alkaloids**, **flavonoids**, and **terpenoids** are presently the best characterized at the enzyme and gene levels. Metabolic engineering is a potentially powerful tool for the regulation of secondary metabolism in transgenic plants, and it will certainly have many applications in the future (Verpoorte and Alfermann, 2000).

## 7.5.1 Engineering of Plant Secondary Metabolite Pathways for the Production of Natural Products

### 7.5.1.1 Increasing Total Carbon Flux through Metabolic Pathways

Metabolic engineering represents a promising approach and opens up different ways to enhance the yield of valuable natural products from plants (Figure 7.6).

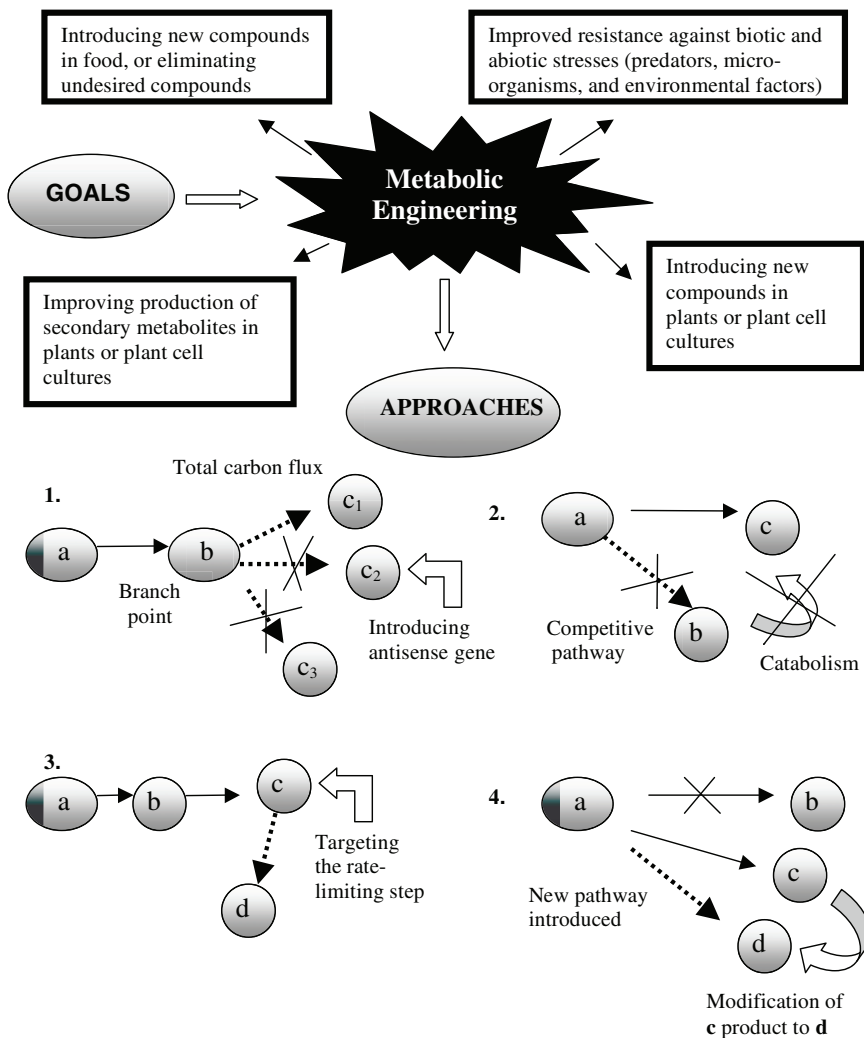

**FIGURE 7.6** Goals and approaches in metabolic engineering: (1) increase in the total carbon flux at the branch point, or decrease in the flux through competitive pathways, or introduction of an antisense gene of the competing enzyme; (2) regulation of desired metabolite yield either by competitive pathway or by catabolism blocking; (3) determination and targeting of rate-limiting steps; and (4) introduction of a new pathway or gene of the specific enzyme.

The first approach involves increases in the total carbon flux toward the desired secondary metabolite. However, this rule is not universal because decreasing the flux through competitive pathways is another option that must be considered. This can be achieved by introducing an **antisense gene** of the competing enzyme at the branch point (Verpoorte et al., 2000). This can also be done by overcoming **rate-limiting steps** or by blocking **competitive pathways**.

A flux of carbon into a given metabolite pathway, diversion of flux at intermediate branches, and lack of final conversion at the end of a specific branch appear to affect secondary metabolite production in plants. It is important to identify points of possible flux limitation. By identifying points of flux limitation, pathway steps can then be pursued for genetic modification. A method with which to quantify flux through metabolite measurements is necessary for the analysis of original and modified pathways. In this context, analyzing a wide range of secondary metabolites has significant advantages as compared to final product accumulation. An interesting model was proposed by Morgan and Shanks (2002) that organizes the flux analysis by grouping metabolites of similar biosynthetic origin. For example, they quantified temporal profiles of metabolites from several branches of the **indole alkaloid pathway** in *Catharanthus roseus* (Madagascar pink) hairy root cultures and were able to examine the distribution of flux around key branch points. Thus, this analysis provides crucial information, such as an estimate of total flux to all the secondary metabolites produced in a multibranch pathway.

The regulation of **metabolic flux** to **cellulose**, a major sink for carbon in plants, was introduced by Delmer and Haigler (2002). As for many pathways, it is still unclear where carbon flux is limited in the complex cellulose biosynthetic pathway. Cellulose is an important component of the cell walls of higher plants. As a major sink for carbon on earth, possible means by which the quality or quantity of cellulose deposited in various plant parts might be manipulated by metabolic engineering techniques (Delmer and Haigler, 2002). Thus, putative mechanisms for regulation-altered flux through this pathway, as well as multiple genes for cellulose biosynthesis and regulation, provide targets for metabolic manipulations. However, the environmental sensitivity of the process and possible variation in flux control under environmental influences must also be considered.

Another example worthy of mention is the genetic engineering of a **zeaxanthin-rich potato** by **antisense inactivation** and **cosuppression of carotenoid epoxidation**, as recently reported by Romer et al. (2002). **Zeaxanthin** is an important dietary carotenoid, but its abundance in our food is low. In order to provide a better supply of zeaxanthin in a staple crop, two different potato (*Solanum tuberosum* L.) cultivars were genetically modified. By transformation with sense and antisense constructs encoding **zeaxanthin epoxidase**, zeaxanthin conversion to **violaxanthin** was inhibited. Both approaches (**antisense** and **cosuppression**) yielded potato tubers with higher levels of zeaxanthin up to 40  $\mu\text{g}\cdot\text{g}^{-1}$  dry weight. As a consequence of this genetic manipulation, the amount of violaxanthin was diminished dramatically, and in some cases, the monoepoxy intermediate **antheraxanthin** accumulated (Romer et al., 2002). Between one and eight copies of the sense or antisense epoxidase gene fragments were integrated into the genome. In addition, most of the transformants with higher zeaxanthin levels showed simultaneous increases in total carotenoid content (up to 5.7-fold). The increase in total carotenoids suggests that the genetic modification affects the regulation of the whole carotenoid biosynthetic pathway in potato tubers, involving substantially higher **phytoene synthase** and slightly increased  **$\beta$ -carotene hydroxylase** transcript levels in tubers.

### 7.5.1.2 Overcoming Rate-Limiting Steps

The most important aspects in metabolic engineering are to identify enzymes that may be involved in intermediate biosynthesis and, subsequently, to determine if any of these may occur at regulatory steps, or as now named, **rate-limiting steps**. Such determinations may play a key role in future manipulation of secondary metabolite biosynthesis, because rate-limiting steps can be considered excellent targets. The single-gene approach is an excellent way to find out where a rate-limiting step occurs in a pathway. However, it should be mentioned that pathway architecture could be quite different, raising the bar from the linear to a complex network. Therefore, pathway architecture is one of the important factors that will allow one to determine the most suitable approach for engineering plant cells. On the other hand, several other factors can play significant roles. Such factors are common in plant secondary metabolism,

such as regulatory mechanisms or compartmentation. Thus, regulatory mechanisms such as **feedback regulation** may affect secondary metabolite yields in plants (see Chapters 3 and 5). This is especially relevant with the single gene approach. In contrast, with **heterologous gene overexpression**, a heterologous enzyme is shown to be operative, and because of this, it may have no feedback inhibition by downstream products. Such an enzyme may be introduced from another source (Chartrain et al., 2000). Compartmentation also plays a major role in the regulation of secondary metabolite pathways, because some important pathways occur in compartments (Verpoorte et al., 1999). For example, the biosynthesis of terpenoid **indole alkaloids** requires at least three compartments — the **plastids** for the terpenoid moiety and tryptophan, the **cytosol** for decarboxylation of tryptophan, and the **vacuole** for the coupling of tryptamine with secologanin (Verpoorte et al., 1999).

### 7.5.1.3 Blocking Catabolism or Competitive Pathways

Because little is known about catabolism in secondary metabolite pathways, there is an important question as to whether catabolism is an important factor in secondary metabolite pathways for limiting accumulation. Interesting questions are also raised concerning the possible toxicity of some compounds to the plant cells, and the role of catabolism in detoxification mechanisms. In this context, naturally occurring storage compartments (e.g., vacuoles and plastids in plant cells) may play a key role in saving secondary metabolites from catabolism. Catabolism may be an important factor in metabolic engineering. A remarkable observation was made in plant cell cultures of *Catharanthus roseus* (rosy periwinkle) by Dos Santos et al. (1994) concerning the equality of the rate of catabolism with the rate of *de novo* compound biosynthesis. The phenomenon of catabolism in secondary metabolites was not studied extensively, and few enzymes were characterized in the catabolism of most secondary metabolites (Verpoorte et al., 2000). However, such studies are needed and will allow us to explore the blocking of catabolism to increase the accumulation of desired compounds. Catabolism or competitive pathways can be blocked by antisense genes or even by using some antibodies.

## 7.5.2 Metabolic Engineering for Plant Improvement and Protection against Environmental Stresses

Abiotic stresses (e.g., high salt levels, low water availability leading to drought, excess water leading to flooding, or high and low temperature regimes) can adversely affect plant growth and natural products production. The genetic responses of plants to these stresses are complex because they involve simultaneous expression of a number of genes. Continuing efforts of plant biologists resulted in the engineering of plants resistant to low temperature, high temperature, and excess salinity. Satisfactory progress was also achieved in generating plants resistant to water deficit stress and flooding. While such achievements are impressive, it is a challenging task to pyramid (like designing the food pyramid) useful genes for high-level resistance to such stresses. In such studies, metabolic engineering can play an important role. The limiting factor in this aspect is the lack of information on what constitutes a **useful gene** (i.e., genes that would lead to better stress tolerance).

Metabolic engineering of rice leading to biosynthesis of **glycinebetaine** and tolerance to salt and cold is one of the best examples in this field. Genetically engineered rice (*Oryza sativa* L.) with the ability to synthesize glycinebetaine was established by introducing the *codA* gene for **choline oxidase** from the soil bacterium *Arthrobacter globiformis* (Sakamoto and Murata, 1998). These results indicated that the subcellular compartmentalization of the biosynthesis of glycinebetaine was a critical element in the efficient enhancement of tolerance to salt and cold stresses in the engineered plants.

Metabolic engineering of osmoprotectant accumulation in plants represents another way to increase the drought and salinity tolerance of plants. Drought and salinity are among the worst scourges of agriculture. An effective mechanism to reduce damage from these stresses is brought about by the accumulation of high intracellular levels of **osmoprotectant compounds**, such as **proline**, **ectoine**, **betaines**, **polyols**, and **trehalose**. Engineering osmoprotectant biosynthesis pathways, as a potential way to improve stress tolerance, was reported by Rontein et al. (2002). Several single genes were successfully introduced for such osmoprotectant pathways into several plants (such as tobacco [*Nicotiana tabacum*],

*Arabidopsis*, canola [*Brassica napus*], rice [*Oryza sativa*], and potato [*Solanum tuberosum*]) and improved stress tolerance.

One possible mechanism by which plants could survive salt stress is to compartmentalize sodium ions away from the cytosol. Overexpression of a **vacuolar Na super(+)/H super(+) antiport** from *Arabidopsis thaliana* in *Arabidopsis* plants promotes sustained growth and development in the soil water environment. This salinity tolerance was correlated with higher-than-normal levels of **AtNHX1 transcripts**, protein, and vacuolar Na super(+)/H super(+) (sodium/proton) antiport activity, as reported by Apse et al. (1999). These results demonstrate the feasibility of metabolic engineering for **salt tolerance** in plants. Improving plant drought, salt, and freezing tolerance by gene transfer of a single **stress-inducible transcription factor** was reported to be successful (Kasuga et al., 1999). Overexpression of the cDNA encoding this transcriptional factor in transgenic plants activated the expression of many of these stress tolerance genes under normal growing conditions and resulted in improved tolerance to drought, salt loading, and freezing.

Improving resistance against pests or diseases also leads to improved yields. For resistance against pathogenic microorganisms, metabolic engineering can aim for the expression of high levels of defense compounds, such as **phytoalexins**, or for pest resistance, improve the production of **endogenous defense compounds** (e.g., **pathogenesis-related proteins**), or introduce into plants the genes that produce new toxic compounds against predators (e.g., the **B.T. gene** from *Bacillus thuringiensis* that produces a toxic crystalline protein that interrupts digestion in many types of feeding insect pests).

---

## 7.6 Molecular Farming

One of the important goals of plant cell biotechnology research is to develop a new molecular farming industry. The use of plants as bioreactors offers the global health care industry the most promising system for mass producing many of the phytopharmaceuticals and is increasingly being used as a safe and inexpensive alternative for the production of valuable proteins. This unique system can offer strict control over the timing and pattern of gene expression, which can be restricted to particular plant organs such as seeds, leaves, and roots.

With the advent of gene transfer technology, the plant-based manufacturing of recombinant proteins has become an attractive alternative. **Molecular farming** is a relatively new area of science and a new industry. It can be defined as the production of novel products in plants; in the majority of instances, these products are of nonplant origin. This field provides a fundamental understanding of how plants can be exploited for the production of foreign proteins. Plants are induced to produce these products through the insertion and expression of new genes that are responsible for final product formation. Thus, molecular farming involves the genetic modification of the “host” plant with subsequent stable product formation. The categories of products that are currently being produced either commercially or experimentally in plants include human and animal therapeutics (including vaccines), diagnostics, industrial proteins, and other industrial products (such as bioplastics). It is important to mention here that such foreign gene products now being produced in transgenic plants should be limited to nonfood plants.

### 7.6.1 Molecular Farming Is a Relatively New Area of Science and Industry

Molecular farming activity arose after the first successful transformation of higher plants. The first report of a plant-produced protein, **avidin**, for the specific purpose of extraction, purification, and sale, was reported by Hood et al. (1997). Reports on the first **antibodies** produced by plants occurred in 1988 by Daring and co-workers (1990). Other reports on molecular-farmed pharmaceutical proteins in plant systems and their application are presented in reviews by Horn et al. (2004); Fischer and Emans (2000); Twyman et al. (2003); and Maliga and Graham (2004).

In this connection, plant cell suspension cultures can be used for recombinant protein production under controlled conditions. Today, the expression of recombinant antibodies and antibody fragments in plants

is a well-established technique (Fischer and Emans, 2000; Twyman et al., 2003). The comparison of such a system to bacterial or mammalian cells showed some advantages in terms of cultivation and growth of plant cells. However, some technical, ethical, and safety issues must be addressed in this technology.

Plants used as bioreactors offer protein production free of human pathogens and bacteria-associated endotoxins. Furthermore, **post-translational modification pathways** in plants are similar to those of higher eukaryotes. Other advantages of using plants in molecular farming include lower production costs compared with other transgenic systems; the synthesis of proteins by higher plants with correct folding, glycosylation, and activity; and the secretion of more stable proteins by plants to the environment.

The commercial success of molecular farming in plants depends on technology, economic considerations, and public acceptance. Particularly, seeds have the useful advantage of protein accumulation in a relatively small volume, and such proteins are more stable under environmental stress conditions. For example, it was estimated that the cost of producing recombinant proteins in plants could be 10- to 50-fold lower than producing the same proteins in *Escherichia coli* or in mammalian cells. Several proteins, enzymes, and antibodies produced in plants are now being used in clinical trials, with a potential for commercial exploitation (Ma et al., 2003).

Thus, the economic drivers for developing molecular farming as an industry have been the capacity of crops to produce large volumes of the desired product; the safety, particularly microbiological safety, of plant-based production; and most importantly, the cost benefits of plant-based production. Several efficient plant-based expression systems were explored, and more than 100 recombinant proteins were produced in a range of different plant species (for review, see Twyman et al., 2003).

### 7.6.2 Molecular Farming of Valuable Natural Products and Pharmaceutical Proteins

Plants are used to produce a variety of commercially important proteins, including vaccines, industrial proteins, biopharmaceuticals (e.g., autoantigens, growth hormones and factors), and antibodies. Since the first report in 1989 by Hiatt and co-workers, a number of antibodies targeting a wide range of antigens (e.g., tumor epitopes, herbicides, and bacteria) have been expressed in plants. There is an ever-growing interest in plant molecular farming as a system for producing valuable recombinant pharmaceutical molecules, such as single-chain variable fragments, on an industrial/agricultural scale. It appears that it is going to become a reality. **Single-chain antibodies (scFvs)** represent a particularly promising class of therapeutics, which allows one to overcome problems of the whole molecule. In particular, the immune response against the Fc fragment was overcome. ScFvs exhibit faster systemic clearance, an improved tumor penetration, and a specificity of tumor targeting during the terminal phases of elimination. Many scFvs were expressed in *E. coli* for various biomedical applications (Ward et al., 1989; Worn and Pluckthun, 2001), but only a few scFvs were produced in the plant system (e.g., a scFv against Hodgkin's disease produced in tobacco [*Nicotiana tabacum*] (McCormick et al., 1999) and a scFv-T84.66 against carcinoembryonic antigens produced in various plants (Vaquero et al., 1999; Stoger et al., 2000). The production of a functional scFv in *E. coli* and in plant systems, specific for the **HER2 oncogene** related to breast and ovary human cancers (Galeffi et al., 2005), was reported. Stable and transient plant expression systems were used to test the scFv's stability and functionality, with the objective of mass production. The functionality was assayed using both *in vitro* and *ex vivo* analyses. The scFv-ÉøHER2 appears to be intrinsically stable, as demonstrated by cytosol accumulation without loss of functionality. The results obtained are promising with regard to conjugating this molecule with an immunotoxin to develop a new anticancer drug.

Another important pharmaceutically active protein, **human epidermal growth factor receptor-2 (HER2)** — an oncogene involved in abnormal cell growth in breast cancer — is considered for the development of new cancer therapies. The cloning and expression of a **scFv-HER2** produced in *Escherichia coli* and in plants, using both stable and transient systems in tobacco (*Nicotiana tabacum*) and *Nicotiana benthamiana* was reported (reviewed by Fischer and Emans, 2000). Single-chain antibodies (ScFvs) extracted and purified from *E. coli* and plant tissues were tested for functionality and specificity by **flow cytometry analysis** on several cell lines, and they showed positive results when used on breast cancer slides from human frozen tissues. As a result, scFv-HER2 represents a good opportunity for application and use in diagnosis and therapy (Galeffi et al., 2005).

In most cases, **single-chain variable fragment (scFv) antibodies** (synthetic antibody derivatives containing the heavy- and light-chain variable domains of an immunoglobulin joined by a flexible peptide linker) are preferred, as the scFv retains full binding capabilities and does not need to pass through the endomembrane system to be assembled.

A number of factors contribute to the efficiency of **recombinant protein expression** in plants. Parameters such as transient versus stable expression, codon optimization, organelle targeting, tissue-diverse versus tissue-specific expression, and activatable/inducible versus constitutive expression should be taken into consideration when designing a plant-based expression system.

Viral vectors were reported to be more attractive transformation systems in molecular farming because of the high yield of protein and the stability of transformation (Scholthof et al., 1996). Such a system, for example, involves the use of a **tobacco mosaic virus (TMV)-based vector** for the production of hepatitis B surface antigen, scFvs, and other recombinant proteins, as reported by McCormick et al. (1999) and Kumagai et al. (2000).

Some good examples and a novel strategy for activatable, high-level expression of proteins are based on the **rolling-circle mechanism** by which circular ssDNA viruses replicate. Termed **InPact (in plant activation)**, the basis of the system relies on an integrated gene cassette arranged in such a way that there is no expression in the absence of a **viral-encoded replication protein (Rep)**. Upon delivery of Rep, the protein mediates a cascade of events that include (1) the release of the “split gene” cassette, (2) the reconstitution of a transcribable and translatable episomal expression cassette, and (3) protein accumulation and amplification of the episomal circular DNA forms. Hence, by tightly regulating the delivery of Rep, one can govern when and where recombinant protein accumulation occurs. Using the InPact system to express a commercially important scFv, targeting the antigen D-dimer, a blood clot factor associated with **deep vein thrombosis (DVT)** becomes more relevant. Hence, purification of scFv involves **immobilized metal-ion affinity chromatography (IMAC)** over **Ni-NTA** (the Ni-NTA purification system is designed for purification of polyhistidine-containing recombinant proteins) and refinement by separation through size-exclusion columns (see Chapter 8). Activity can be monitored by ligand blots with D-dimer. Additional protocols are developed to improve yields of the active protein. In this matter, preliminary studies indicate that the affinity approach produces reasonably clean preparations that are active in the ligand blot assays.

The most important thing for molecular farming in plants is the use of host systems with proven expression technology. Toward further development of molecular farming in the future, the use of plant cell suspension cultures in bioreactors is very promising. Suspension cell lines can be used for recombinant protein production. This is also relevant for plant transformation and protein targeting. The transfer of foreign genes into plant cells is very well-documented, and cell cultures represent the best system for this purpose. Cell cultures grow faster and thus constitute a clear advantage for valuable protein production over the use of intact plants. Recombinant proteins expressed in plant cells can be found in the culture medium, or they accumulate within the cells. These aspects are very well documented and reviewed by Fischer et al. (1999). The localization of a recombinant protein depends on the targeting leader peptide or permeability of the plant cell walls. Some scientists used targeting signals for the secretion of proteins (Fischer et al., 1999). In addition, these targeting signals are used to retain recombinant proteins within compartments to protect them from proteolytic degradation. This technique is now applicable in some plant cell systems, such as the use of plant roots for exudation of recombinant proteins. Subcellular targeting can also be used as a general method to increase the yield of recombinant proteins, because the accumulation sites could strongly influence protein folding, assembly, and post-translational modification (Twyman et al., 2003).

### 7.6.2.1 Fermentation Process, Extraction, and Purification

There are specific technical considerations for high-level pharmaceutical protein expression that include transcriptional modification in subcellular destinations as it relates to protein targeting in general. **Subcellular targeting** can be used as a general method to increase the yield of **recombinant protein (antibodies)**. As a rule, subcellular compartments are responsible for or influence protein folding, assembly, and post-translational modification. For example, significant increases in recombinant protein yield were observed when proteins are targeted to the secretory pathway rather than to the cytosol (Conrad

and Fiedler, 1998). Another experiment with full-size immunoglobulins and single-chain Fv fragments revealed that the secretory pathway is a more suitable compartment for folding and assembly (for review, see Twyman et al., 2003, and references cited therein). The **endoplasmic reticulum (ER)** retention of such targeted proteins can give much higher yields (Conrad and Fiedler, 1998), because the ER provides an oxidizing environment and an abundance of **molecular chaperones**, while, at the same time, there are few **proteases**. These are likely to be the most important factors affecting protein folding and assembly (Twyman et al., 2003). A high level of protein expression could also be introduced into chloroplasts rather than into the nucleus. Several examples of **chloroplast-based molecular farming** are discussed and highlighted in the recent advances in chloroplast gene transfer. Chloroplasts also offer biosafety advantages. However, chloroplast gene technology is narrow in its scope of application because of the inability of this system to sustain many post-translational modifications (for review, see Twyman et al., 2003). Horn et al. (2004) describe four classes of proteins within molecular farming technology that are categorized into the following broad areas: (1) parental therapeutics and pharmaceutical intermediates, (2) industrial proteins such as enzymes, (3) monoclonal antibodies, and (4) antigens for vaccines.

### 7.6.2.2 *The Significance in Relation to the Plant Biotechnology*

Molecular farming offers strict control over the timing and pattern of gene expression that can be restricted to particular plant structures, such as seeds, leaves, and roots, or to subcellular compartments as mentioned above. The use of plants as bioreactors offers the global health-care industry the most promising system for mass production of many of the proteins required for diagnostic, pharmaceutical, and therapeutic development. Several efficient plant-based expression systems emerged, and more than 100 recombinant proteins are now being produced in a range of different plant species. However, the huge potential of molecular farming is still in progress. This concerns some important factors that include quality, homogeneity of the final products, economic feasibility of the process, and serious risks associated with the production of vaccines in food plants eaten by humans.

---

## 7.7 The Benefits and Risk Factors of Biotechnology and Future Prospects

The use of plant biotechnology raises a number of positive and negative issues. The positive issues concern the major benefits that plant biotechnology may contribute to industry, agriculture, and the environment. Such positive impacts on the environment may involve clearance of contaminated soil by means of **phytoremediation**. For example, roots of some plant species in the mustard family (*Brassicaceae*) and redroot pigweed (*Amaranthus retroflexus*) are especially well adapted for the accumulation of significant amounts of heavy metals, such as **zinc, nickel, lead, strontium, cesium, uranium, and mercury**, from natural or human-contaminated soil environments (see Kaufman et al., 2002). Moreover, plants were found that can break down or degrade organic contaminants (similar to microbes), while others are able to extract and stabilize toxic metal contaminants by acting as traps or filters. The ramifications of these phenomena for environmental cleanup were quickly realized. In theory, by simply growing a crop of the appropriate plant at a given polluted site, the contaminant concentration could be lowered to environmentally acceptable levels. This may involve several rotations of the plants, and it may even be possible to use a combination of plants (and microbes, too) to treat sites polluted with both heavy metals and organics.

In general, two basic factors will determine the particular method of phytoremediation that will be used at a site: the type of contaminant (toxic metal vs. organic), and the medium that is contaminated (soil vs. water). Unlike organic compounds, toxic metals cannot be broken down (i.e., they are immutable). Consequently, plants deal with these contaminants differently than they do with organics. Plants either stabilize toxic metals, or they remove them via extraction or filtration from the contaminated soil or groundwater. Plants carry out these processes by utilizing three basic mechanisms: (1) **phytoextraction** (which is the use of metal-accumulating plants that can transport and concentrate metals from the soil to the roots and aboveground shoots), (2) **rhizofiltration** (which is similar to phytoextraction, but the plants are used primarily to address contaminated groundwater rather than soil), and (3) **phytostabili-**

**zation** (which is the use of plants to immobilize contaminants in the soil and groundwater through absorption and accumulation by roots, adsorption onto roots, or precipitation within the root zone of plants [**rhizosphere**]).

The criteria for **risk assessment** are based on the original unmodified plant; the novel trait or gene transferred; the novel modified plant as a whole; effects on the health of humans and other animals; and its potential environmental interaction. Characterization of the novel trait plays a central role in the assessment process and overlaps the assessment of the modified plant. The main criteria considered include information about the genetic construct (genes inserted, regulatory elements, marker genes, donors, and known risks associated with the known organisms), the gene products, complementary and breakdown products, metabolic pathways affected, and potential toxic and allergic effects of the gene product. Thus, the negative issues relative to plant biotechnology include potential harm to nontarget organisms or potential introduction of regulatory molecules (such as transcriptional factor or hormones) into the same organism with subsequent effects on other genes (a process known as a **pleiotropic effect**). On the other hand, the foreign genes could escape into nature, and this process could not be controlled. This can lead to loss of biodiversity or can have a negative impact in deriving new plant organisms with unpredicted properties. The most serious concern is that pollen from genetically engineered plants could contaminate natural populations due to pollination. However, new technologies help to transfer foreign genes to the special organelles, such as chloroplasts, for gene function and possible application; therefore, the risk of transformation of foreign genes through pollen shedding is kept to a minimum.

Better ways to prevent all these negative impacts described above will come about through better regulation of plant biotechnology and the risk factors involved in its use. Therefore, scientists engaged in plant biotechnology should follow all regulatory mandates as well as socially and ethically acceptable targets (Boulter, 1995).

With the inevitable entry of **genetically modified (GM)** crops into the human and animal food chain, consumers on all continents are demanding both information and choice about GM crops. To satisfy this demand, many countries are introducing legislation to control the circulation of GM crops and to trace the use of approved GM crops. Companies throughout the agricultural supply chain are implementing strict tracking/audit systems to ensure that the consumer is given both information and choice. An integral part of these tracking systems is testing the genetic identity of raw and refined crop materials. Prior to variety registration/commercialization of GM plants, they must go through a rigorous step-wise screening involving confined and unconfined field trails. In general, plants with novel traits are regulated on the basis of the characteristics of the product, not the specific process by which the product is made. More specifically, when the next novel plant is assessed, emphasis is placed on the insertion of the novel genes into the plant genome, the number of sites of integration (loci), the copy numbers, the presence of rearrangement, the stability, the expression, the alterations of metabolic pathways, the activity of an inserted gene product in the plant, and the activity of the gene product in the environment. Potential altered interactions of the novel plants involve identifying changes to the relative phenotype with respect to stress adaptation, composition, toxins, and agronomic characteristics. Also, the novel plant is assessed for possible changes in agriculture practices and its potential environmental effects from introgression of traits into related wild plant species.

In plant biotechnology, all substances have the potential to have an adverse impact on our health, hygiene, safety, and environment. The risks must be evaluated in regard to workplace safety, environmental contamination, and public exposures. In conducting risk assessments, it is important to consider all normal and foreseeable abnormal operations, maintenance, cleaning, and security. Following completion of a risk assessment and risk characterization, development of effective risk-management programs, such as implementation through training and selection of risk-management tools, is needed.

---

## 7.8 Conclusions

While plant natural products are useful for the treatment of many human ailments, they are often made in only trace amounts within the specific species that produce them. Therefore, plant biotechnology is expected to play a major role in the production of natural products through bioengineering. Although



we still have limited knowledge about plant secondary metabolism, its regulation, functional consequences, and physiological importance, recent achievements in plant genomics, proteomics, metabolomics, and systems biology are now filling these voids (see Chapter 6). New technologies are emerging that enhance our understanding of the factors that control the accumulation of secondary metabolites, the molecular mechanisms concerning gene expression, signal transduction regulation, and rate-limiting enzymes found within a diverse network of biosynthetic pathways in plants. Molecular biology strategies are being used to produce beneficial products, such as phytopharmaceuticals, vaccines in nonfood plants, natural pesticides, or food additives. Therefore, our challenge will be to integrate different disciplines in plant science in order to unravel metabolic networks and to elucidate the biosynthesis and molecular regulation of several important secondary metabolites in plants. This will lead to successful applications in metabolic engineering and molecular farming. It will further reduce our dependence on accruing large amounts of plant biomass, and hence, reduce the loss of important biological resources.

Biotechnology is now playing an ever-increasing role in the search for biologically active natural products from plants and other sources. Because plant natural products have great chemical diversity, their sustainable supply from original biological sources is increasingly becoming a problem. **Bio-prospecting** will remain an attractive proposition as long as we have the flora diversity; but when these natural resources are gone, can biotechnology meet the challenge to fill the void left by diminishing resources? There are far-reaching socioeconomic and ethical consequences now confronting us with many of the current biotechnology applications in industry and corporate farming.

---

## References

- Agrawal, A.A. (1998). Induced responses to herbivory and increased plant performance. *Science* 279: 1201–1202.
- Alfermann, A.W. and M. Petersen. (1995). Natural product formation by plant cell biotechnology. *Plant Cell Tissue Organ Cult* 43: 199–205.
- Apse, M.P., G.S. Aharon, W.A. Snedden, and E. Blumwald. (1999). Salt tolerance conferred by overexpression of a vacuolar Na super(+)/H super(+) antiport in *Arabidopsis*. *Science* 285: 1256–1258.
- Baker, C.J. and E.W. Orlandi. (1995). Active oxygen in plant pathogenesis. *Ann Rev Phytopathol* 33: 229–321.
- Balsevich, J. (1985). Biotransformation of 10-hydroxygeraniol and related compounds by a cell suspension culture of *Catharanthus roseus*; the formation of reduced products. *Planta Med* 2: 128–132.
- Barrett, S.C.H. (1982). Genetic variation in weeds. In *Biological Control of Weeds with Pathogens*, R. Charudattan and H.L. Walker (Eds.). John Wiley & Sons, New York, pp. 73–98.
- Bladt, S. and H. Wagner. (1994). Inhibition of MAO by fractions and constituents of *Hypericum* extract. *J Geriatr Psychiatry Neurol* 7 (Sp. 1): 57–59.
- Blechert, S., W. Brodschelm, S. Holder, L. Kammerer, T.M. Kuchan, M.J. Mueller, Z.H. Xia, and M.H. Zenk. (1995). The octadecanoic pathway: signal molecules for the regulation of secondary pathways. *PNAS* 92: 4099–4105.
- Bornke, F., M. Hajirezaei, and U. Sonnewald. (2002). Potato tubers as bioreactors for palatinose production. *J Biotechnol* 96: 119–124.
- Boulter, D. (1995). Plant biotechnology: facts and public perception. *Phytochemistry* 40: 1–9.
- Braz-Filho, R. (1999). Brazilian phytochemical diversity: bioorganic compounds produced by secondary metabolism as a source of new scientific development, varied industrial applications and to enhance human health and the quality of life. *Pure Appl Chem* 71: 1663–1672.
- Briskin, D. and M. Gawienowski. (2001). Differential effects of light and nitrogen on production of hypericins and leaf glands in *Hypericum perforatum*. *Plant Phys and Biochem* 39: 1075–1081.
- Brolis, M., B. Gabetta, N. Fuzzati, R. Pace, F. Panzeri, and F. Peterlongo. (1998). Identification by high-performance liquid chromatography–diode array detection–mass spectrometry and quantification by high-performance liquid chromatography–UV absorbance detection of active constituents of *Hypericum perforatum*. *J Chromatogr A* 825: 9–16.
- Buter, B., C. Orlacchio, A. Soldati, and K. Berger. (1998). Significance of genetic and environmental aspects in the field cultivation of *Hypericum perforatum*. *Planta Med* 64: 431–437.

- Campbell, M.H. and E.S. Delfosse. (1984). The biology of the Australian weeds 13. *Hypericum perforatum* L. *J Aust Inst Agric Sci* 50: 63–73.
- Carrari, F., E. Urbanczyk-Wochniak, L. Willmitzer, A.R. Fernie. (2003). Engineering central metabolism in crop species: learning the system. *Metab Eng* 5: 191–200.
- Cellárová, E., K. Kimakova, and R. Brutovska. (1992). Multiple shoot formation and phenotypic changes of R<sub>0</sub> regenerants in *Hypericum perforatum* L. *Acta Biotechnol* 12: 445–452.
- Cellárová, E., Z. Daxnerova, K. Kimakova, and J. Haluskova. (1994). The variability of the hypericin content in the regenerants of *Hypericum perforatum*. *Acta Biotechnol* 14: 267–274.
- Cellárová, E., K. Kimakova, Z. Daxnerova, and P. Martonfi. (1995). *Hypericum perforatum* (St. John's wort): *in vitro* culture and production of hypericin and other secondary metabolites. In *Biotechnology in Agriculture and Forestry*, Vol. 33, *Medicinal and Aromatic Plants VIII*, Y.P. Bajaj (Ed.). Springer-Verlag, Heidelberg, pp. 261–275.
- Chang, Q., M. Zhu, Z. Zuo, M. Chow, and W.K. Ho. (2001). High-performance liquid chromatographic method for simultaneous determination of hawthorn active components of rat plasma. *J Chromatogr B Biomed Sci Appl* 760: 227–235.
- Chartrain, M., P.M. Salmon, D.K. Robinson, and B.C. Buckland. (2000). Metabolic engineering and directed evolution for the production of pharmaceuticals. *Curr Opin Biotechnol* 11: 209–214.
- Conrad, U. and U. Fiedler. (1998). Compartment-specific accumulation of recombinant immunoglobulins in plant cells: an essential tool for antibody production and immunomodulation of physiological functions and pathogen activity. *Plant Mol Biol* 38: 101–109.
- Constantine, G.H. and J. Karchesy. (1998). Variations in hypericin concentrations in *Hypericum perforatum* L. and commercial products. *Pharm Biol* 36: 365–367.
- DeBry, R.W. and L.G. Abele. (1995). The relationship between parsimony and maximum-likelihood analyses: tree scores and confidence estimates for three real data sets. *Mol Biol Evol* 12: 291–297.
- Delmer, D.P. and C.H. Haigler. (2002). The regulation of metabolic flux to cellulose, a major sink for carbon in plants. *Metab Eng* 4: 22–28.
- Dewick, P.M. (1998). *Medicinal Natural Products: A Biosynthetic Approach*. John Wiley, New York.
- Dias, A.C.P., F.A. Tomas-Barberan, M. Fernandes-Ferreira, and F. Ferreres. (1998). Unusual flavonoid produces by callus of *Hypericum perforatum*. *Phytochemistry* 48: 1165–1168.
- Diwu, Z. (1995). Novel therapeutic and diagnostic applications of hypocrellins and hypericins. *Photochem Photobiol* 61: 529–539.
- Dixon, R.A. (2005). Engineering of plant natural product pathways. *Curr Opin Plant Biol* 8: 329–336.
- Dos Santos, R., J. Schripsema, and R. Verpoorte. (1994). Ajmalicine metabolism in *Cataranthus roseus* cell cultures. *Phytochemistry* 35: 677–681.
- During, K., S. Hippe, F. Kreuzaler, and J. Schell. (1990). Synthesis and self-assembly of a functional monoclonal antibody in transgenic *Nicotiana tabacum*. *Plant Mol Biol* 15: 281–293.
- Erdelmeier, C.A.J., K. Klessing, S. Renzi, and H. Hauer. (1999). New hyperforin analogues from *Hypericum perforatum* and a stable dicyclohexylammonium salt of hyperforin. In *Book of Abstracts. 2000 Years of Natural Products Research — Past, Present and Future* (Joint Meeting of the ASP, AFERP, GA, and PSE, July 26–30, Vrije Univeriteit, Amsterdam, The Netherlands), T.J.C. Luijendijk and R. Verpoorte (Eds.), p. 432.
- Fischer, R. and N. Emans. (2000). Molecular farming of pharmaceutical proteins. *Transgenic Res* 9: 279–299.
- Fischer, R., N. Emans, F. Schuster, S. Hellwig, and J. Drossard. (1999). Towards molecular farming in the future: using plant-cell-suspension cultures as bioreactors. *Biotechnol Appl Biochem* 30: 109–112.
- Galeffi, P., A. Lombardi, M.D. Donato, A. Latini, M. Sperandei, C. Cantale, and P. Giacomini. (2005). Expression of single-chain antibodies in transgenic plants. *Vaccine* 23: 1823–1827.
- Goodman, R.N. and A.J. Novakcy. (1994). *The Hypersensitive Reaction in Plants to Pathogens*. American Phytopathological Society Press, St. Paul, Minnesota.
- Gray, D., G. Rottinghaus, H.E.G. Garrett, and S.G. Pallardy. (2000). Simultaneous determination of the predominant hyperforins and hypericins in St. John's wort by liquid chromatography. *J AOAC Int* 83: 944–949.
- Gutierrez Manero, F.J., B. Ramos, J.A. Lucas Garcia, A. Probanza, and M.L. Barrientos Casero. (2003). Systemic induction of the biosynthesis of terpenic compounds in *Digitalis lanata*. *J Plant Physiol* 160: 105–113.

- Hajirezaei, M.R., F. Bornke, M. Peisker, Y. Takahata, J. Lerchl, A. Kirakosyan, and U. Sonnewald. (2003). Decreased sucrose content triggers starch breakdown and respiration in stored potato tubers (*Solanum tuberosum*). *J Exp Bot* 54: 477–488.
- Halusková, J. and E. Cellárová. (1997). RFLP analysis of *Hypericum perforatum* L. somaclones and their progenies. *Euphytica* 95: 229–235.
- Hammerschmidt, R. (1999). Phytoalexins: what have we learned after 60 years? *Ann Rev Phytopathol* 37: 285–306.
- Hiatt, A., R. Cafferkey, and K. Bowdish. (1989). Production of antibodies in transgenic plants. *Nature* 342: 76–78.
- Hickman, J.C. (1993). *The Jepson Manual: Higher Plants of California*. University of California Press, Berkeley.
- Hood, E.E., D. Witcher, S. Maddock, T. Meyer, M. Bailey, A.R. Kusnadi, R.L. Evangelista, Z.L. Nikolov, C.P. Li, and J. Howard. (1997). Commercial production of avidin from transgenic maize: characterization of transformants, production, processing, extraction and purification. *Mol Breeding* 3: 291–306.
- Horn, M.E., S.L. Woodard, and J.A. Howard. (2004). Plant molecular farming: systems and products. *Plant Cell Rep* 22: 711–720.
- Jenett-Siems, K., R. Weigl, A. Bohm, P. Mann, B. Tofern-Reblin, S.C. Ott, A. Ghomian, M. Kaloga, K. Siems, L. Witte, M. Hilker, F. Muller, and E. Eich. (2005). Chemotaxonomy of the pantropical genus *Merremia* (*Convolvulaceae*) based on the distribution of tropane alkaloids. *Phytochemistry* 66: 1448–1464.
- Kasuga, M., Q. Liu, S. Miura, K. Yamaguchi-Shinozaki, and K. Shinozak. (1999). Improving plant drought, salt, and freezing tolerance by gene transfer of a single stress-inducible transcription factor. *Nat Biotechnol* 17: 287–291.
- Kaufman, P.B., J.A. Duke, H. Brielmann, J. Boik, and J.E. Hoyt. (1997). A comparative survey of leguminous plants as sources of the isoflavones, genistein and daidzein: implications for human nutrition and health. *J Altern Complement Med* 3: 7–12.
- Kaufman, P.B., L.J. Cseke, S. Warber, J.A. Duke, and H.L. Brielmann. (1999). *Natural Products from Plants*. CRC Press, Boca Raton, Florida.
- Kaufman, P.B., C.W. Coon, J.N. Govil, J.E. Hoyt, C.R. Lu, B.J. Madsen, and S.L. Warber. (2002). *Creating a Sustainable Future, Living in Harmony with the Earth*. Researchco Book Centre, New Delhi, India.
- Kim, B., D.M. Gibson, and M.L. Shuler. (2005). Relationship of viability and apoptosis to taxol production in *taxus* sp. suspension cultures elicited with methyl jasmonate. *Biotechnol Prog* 21: 700–707.
- Kim, S.H., K.W. Kang, K.W. Kim, and N.D. Kim. (2000). Procyanidins in crataegus extract evoke endothelium-dependent vasorelaxation in rat aorta. *Life Sci* 67: 121–131.
- Kim, Y.J., P.J. Weathers, and B.E. Wyslouzil. (2002). Growth of *Artemisia annua* hairy roots in liquid- and gas-phase reactors. *Biotechnol Bioeng* 80: 454–464.
- Kirakosyan, A., E. Seymour, P.B. Kaufman, S. Warber, S. Bolling, and S.C. Chang. (2003a). Antioxidant capacity of polyphenolic extracts from leaves of *Crataegus laevigata* and *Crataegus monogyna* (Hawthorn) subjected to drought and cold stress. *J Agric Food Chem* 51: 3973–3976.
- Kirakosyan, A., P.B. Kaufman, S. Warber, S. Bolling, and J.A. Duke. (2003b). Quantification of major isoflavonoids and L-canavanine in several organs of kudzu vine (*Pueraria montana*) and in starch samples derived from kudzu roots. *Plant Sci* 164: 883–888.
- Kirakosyan, A., D.M. Gibson, and T. Sirvent (2003c). A comparative study of *Hypericum perforatum* plants as sources of hypericins and hyperforins. *J Herbs Spices Med Plants* 10: 73–88.
- Kirakosyan, A., T.M. Sirvent, D.M. Gibson, and P.B. Kaufman. (2004a). The production of hypericins and hyperforin by *in vitro* cultures of St. John's wort (*Hypericum perforatum*). *Biotechnol Appl Biochem* 39: 71–81.
- Kirakosyan, A., P.B. Kaufman, S. Warber, S. Zick, K. Aaronson, and S. Bolling. (2004b). Applied environmental stress to enhance the levels of polyphenolics in leaves of hawthorn plants. *Physiol Plant* 121: 182–186.
- Kirakosyan, A., P.B. Kaufman, J.A. Duke, S. Warber, and S. Bolling. (2004c). The production of L-Dopa and isoflavones in seeds and seedlings of different cultivars of *Vicia faba* L. (fava bean). *Evidence-Based Integrative Med* 1: 131–135.
- Kirakosyan, A.B., H.R. Vardapetyan, and A.G. Charchoglyan. (2000). The contents of hypericin and pseudo-hypericin in cell cultures of *Hypericum perforatum* L. *Rus J Plant Physiol* 47: 302–306.

- Kirakosyan, A.B., R.R. Vardapetyan, A.G. Charchoglyan, H. Yamamoto, H. Hayashi, and K. Inoue. (2001). The effect of cork pieces on pseudohypericin production in cells of *Hypericum perforatum* shoots. *Rus J Plant Physiol* 48: 815–818.
- Klessig, D.F., J. Durner, J.M. Zhou, D. Kumar, R. Navarre, S. Zhang, J. Shah, D. Wendehenne, H. Du, Y. Trifa, R. Noad, P. Kachroo, D. Pontier, E. Lam, and H. Silva. (2000). Nitric oxide and salicylic acid signaling in plant defense. *PNAS* 97: 8849–8855.
- Kosuth, J., J. Koperdakova, A. Tolonen, A. Hohtola, and E. Cellarova. (2003). The content of hypericins and phloroglucinols in *Hypericum perforatum* L. seedlings at early stage of development. *Plant Sci* 165: 515–521.
- Koulman, A., A.C. Beekman, N. Pras, and W.J. Quax. (2003). The bioconversion process of deoxypodophyllotoxin with *Linum flavum* cell cultures. *Planta Med* 69: 739–744.
- Kumagai, M.H., J. Donson, G. della-Cioppa, and L.K. Grill. (2000). Rapid, high-level expression of glycosylated rice  $\alpha$ -amylase in transfected plants by an RNA viral vector. *Gene* 245: 169–174.
- Kunze, R., W.B. Frommer, and U.I. Flügge. (2002). Metabolic engineering of plants: the role of membrane transport. *Metab Eng* 4: 57–66.
- Kurth, H. and R. Spreemann. (1998). Phytochemical characterization of various St. John's wort extracts. *Adv Ther* 15: 117–128.
- Lal, A., S. Warber, A. Kirakosyan, P.B. Kaufman, and J.A. Duke. (2003). Upregulation of isoflavonoids and soluble proteins in edible legumes by light and fungal elicitor treatments. *J Altern Complement Med* 9: 371–378.
- Lavie, G., Y. Mazur, D. Lavie, and D. Meruelo. (1995). The chemical and biological properties of hypericin: a compound with a broad spectrum of biological activities. *Med Res Rev* 15: 111–119.
- Li, Y.H., Z.H. Sun, L.Q. Zhao, and Y. Xu. (2005). Bioconversion of isoeugenol into vanillin by crude enzyme extracted from soybean. *Appl Biochem Biotechnol* 125: 1–10.
- Liu, F.F., C.Y.W. Ang, T.M. Heinze, J.D. Rankin, R.D. Beger, J.P. Freeman, and J.O. Lay Jr. (2000a). Evaluation of major active components in St. John's Wort dietary supplements by high-performance liquid chromatography with photodiode array detection and electrospray mass spectrometric confirmation. *J Chromatogr A* 888: 85–92.
- Liu, F.F., C.Y.W. Ang and D. Sringer (2000b). Optimization of extraction conditions for active components in *Hypericum perforatum* using response surface methodology. *J Agric Food Chem* 48: 3364–3371.
- Lopez-Bazzocchi, I., J.B. Hudson, and G.H.N. Towers. (1991). Antiviral activity of the photoactive plant pigment hypericin. *Photochem Photobiol* 54: 95–98.
- Ma, J.K., P.M.W. Drake, and P. Christou. (2003). The production of recombinant pharmaceutical proteins in plants. *Nat Rev Genet* 4: 794–805.
- Maisenbacher, P. and K.A. Kovar. (1992). Analysis and stability of hyperici oleum. *Planta Med* 58: 351–354.
- Maliga, P. and I. Graham. (2004). Molecular farming and metabolic engineering promise a new generation of high-tech crops. *Curr Opin Plant Biol* 7: 149–151.
- Mauri, P. and P. Pietta. (2000). High performance liquid chromatography/electrospray mass spectrometry of *Hypericum perforatum* extracts. *Rapid Commun Mass Spectrom* 14: 95–99.
- McAlpine, J.B., C. Pazoles, and A. Stafford. (1999). Phytera's strategy for the discovery of novel anti-infective agents from plant cell cultures. In *Bioassay Methods in Natural Product Research and Drug Development. Proceedings of the Phytochemical Society of Europe*, Vol. 43, L. Bohlin and J.G. Bruhn (Eds.). Kluwer Academic, Dordrecht, pp. 159–166.
- McCormick, A.A., M.H. Kumagai, K. Hanley, T.H. Turpen, I. Hakim, L.K. Grill, D. Tuse, S. Levy, and R. Levy. (1999). Rapid production of specific vaccines for lymphoma by expression of the tumor-derived single-chain Fv epitopes in tobacco plants. *Proc Natl Acad Sci USA* 96: 703–708.
- Meyer, J.E., M.F. Pepin, and M.A. Smith. (2002). Anthocyanin production from *Vaccinium pahalae*: limitations of the physical microenvironment. *J Biotechnol* 93: 45–57.
- Middel, O., H.J. Woerdenbag, W. van Uden, A. van Oeveren, J.F. Jansen, B.L. Feringa, A.W. Konings, N. Pras, and R.M. Kellogg. (1995). Synthesis and cytotoxicity of novel lignans. *J Med Chem* 38: 2112–2118.
- Moreno, P.R.H., C. Poulsen, R. van der Heijden, and R. Verpoorte. (1996). Effects of elicitation on different metabolic pathways in *Catharanthus roseus* (L.) G. Donn cell suspension cultures. *Enz Microb Technol* 18: 99–107.

- Morgan, J.A. and J.V. Shanks. (2002). Quantification of metabolic flux in plant secondary metabolism by a biogenetic organizational approach. *Metab Eng* 4: 257–262.
- Muller, W.E., A. Singer, and M. Wonnemann. (2000). Mechanism of action of St. John's wort extract. *Schweiz Rundsch Med Prax* 89: 2111–2121.
- Orth, H.C.J., C. Rentel, and P.C. Schmidt. (1999). Isolation, purity analysis and stability of hyperforin as a standard material from *Hypericum perforatum* L. *J Pharm Pharmacol* 51: 193–200.
- Park, Y.W., T. Tominaga, J. Sugiyama, Y. Furuta, E. Tanimoto, M. Samejima, F. Sakai, and T. Hayashi. (2003). Enhancement of growth by expression of poplar cellulase in *Arabidopsis thaliana*. *Plant J* 33: 1099–1106.
- Petersen, M. and A.W. Alfermann. (2001). The production of cytotoxic lignans by plant cell cultures. *Appl Microbiol Biotechnol* 55: 135–142.
- Piperopoulos, G., R. Lotz, A. Wixforth, T. Schmierer, and K.P. Zeller. (1997). Determination of naphthodianthrone in plant extracts from *Hypericum perforatum* L. by liquid chromatography-electrospray mass spectrometry. *J Chromatogr B* 695: 309–316.
- Plackett, R.L. and J.P. Burman. (1946). The design of optimum multifactorial experiments. *Biometrika* 33: 305–325.
- Prince, A.M., D. Pascual, D. Meruelo, L. Liebes, Y. Mazur, E. Dubovi, M. Mandel, and G. Lavie. (2000). Strategies for evaluation of enveloped virus inactivation in red cell concentrates using hypericin. *Photochem Photobiol* 71: 188–195.
- Radman, R., T. Saez, C. Bucke, and T. Keshavarz. (2003). Elicitation of plants and microbial cell systems. *Biotech Appl Biochem* 37: 91–102.
- Radosevich, S. (1997). *Weed Ecology: Implications for Management*. John Wiley & Sons, New York.
- Rakotoarison, D.A., B. Greissier, F. Trotin, C. Brunet, T. Dine, M. Luyckx, J. Vasseur, M. Cazin, J.C. Cazin, and M. Pinkas. (1997). Antioxidant activities of polyphenolic extracts from flowers, *in vitro* callus and cell suspension cultures of *Crataegus monogyna*. *Pharmazie* 52: 60–64.
- Ramamoorthy, V., R. Viswanathan, T. Raguchander, V. Prakasam, and R. Samiyappan. (2001). Induction of systemic resistance by plant growth promoting rhizobacteria in crop plants against pests and diseases. *Crop Prot* 20: 1–11.
- Roberts, S.C. and M.L. Shuler. (1997). Large-scale plant cell culture. *Curr Opin Biotechnol* 8: 154–159.
- Robinson, T. (1991). *The Organic Constituents of Higher Plants*. Cordus Press, Amherst, Massachusetts.
- Rohr, G. and B. Meier. (1997). *Crataegus*-Pharmazeutische qualitat und wirksamkeit. *Deutsche Apothek Zeitung* 137: 104–116.
- Romer, S., J. Lubeck, F. Kauder, S. Steiger, C. Adomat, and G. Sandmann. (2002). Genetic engineering of a zeaxanthin-rich potato by antisense inactivation and co-suppression of carotenoid epoxidation. *Metab Eng* 4: 263–272.
- Rontein, D., G. Basset, and A.D. Hanson. (2002). Metabolic engineering of osmoprotectant accumulation in plants. *Metab Eng* 4: 49–56.
- Ryals, J., U. Neuenschwander, M. Willits, A. Molina, H.Y. Steiner, and M. Hunt. (1996). Systemic acquired resistance. *Plant Cell* 8: 1809–1819.
- Sakamoto, A. and N. Murata. (1998). Metabolic engineering of rice leading to biosynthesis of glycinebetaine and tolerance to salt and cold is one of the best examples in this field. *Plant Mol Biol* 38: 1011–1019.
- Scheller, J. and U. Conrad. (2005). Plant-based material, protein and biodegradable plastic. *Curr Opin Plant Biol* 8: 188–196.
- Schempp, C.M., K. Pelz, A. Wittmer, E. Schopf, and J.C. Simon. (1999). Antibacterial activity of hyperforin from St. John's wort, against multiresistant *Staphylococcus aureus* and gram-positive bacteria. *Lancet* 353: 2129.
- Schempp, C.M., V. Kirkin, B. Simon-Haarhaus, A. Kersten, J. Kiss, C.C. Termeer, B. Gilb, T. Kaufmann, C. Borner, J.P. Sleeman, and J.C. Simon. (2002). Inhibition of tumour cell growth by hyperforin, a novel anticancer drug from St. John's wort that acts by induction of apoptosis. *Oncogene* 21: 1242–1250.
- Schlatmann, E., J.L. Vinke, H.J.G. ten Hoopen, and J.J. Heijnen. (1995). Relation between dissolved oxygen concentration and ajmalicine production rate in high-density cultures of *Catharanthus roseus*. *Biotechnol Bioeng* 45: 435–439.
- Scholthof, H.B., K.G. Scholthof, and A.O. Jackson. (1996). Plant virus gene vectors for transient expression of foreign proteins in plants. *Annu Rev Phytopathol* 34: 299–323.

- Schussler, M., J. Holzl, and U. Fricke. (1995). Myocardial effects of flavonoids from *Crataegus* species. *Arzneim-Forsch* 45: 842–845.
- Singer, A., M. Wonnemann, and W.E. Muller. (1999). Hyperforin, a major antidepressant constituent of St. John's Wort, inhibits serotonin uptake by elevating free intracellular Na<sup>+</sup>. *J Pharmacol Exp Ther* 290: 1363–1368.
- Sirvent, T. (2001). Hypericins: a family of light-activated anthraquinones in St. John's wort (*Hypericum perforatum* L.) and their importance in plant/pathogen/herbivore interactions. Cornell University, Ithaca, New York.
- Sirvent, T. and D. Gibson. (2000). Rapid isocratic analysis of hypericins. *J Liq Chrom* 23: 251–259.
- Sirvent, T. and D. Gibson. (2002). Induction of hypericins and hyperforin in *Hypericum perforatum* L. in response to elicitation. *Physiol Mol Plant Pathol* 60: 311–320.
- Smolny, T., H. Wichers, S. Kalenberg, A. Shahsavari, M. Petersen, and A.W. Alfermann. (1998). Accumulation of podophyllotoxin and related lignans in cell suspension cultures of *Linum album*. *Phytochem* 48: 975–979.
- Sonneward, U. (2003). Plant biotechnology: from basic science to industrial application. *J Plant Physiol* 160: 723–725.
- Sticher, O. and B. Meier. (1998). Hawthorn (*Crataegus*): biological activity and new strategies for quality control. In *Phytomedicines of Europe. Chemistry and Biological Activity* (ACS Symposium Series 691), L.D. Lawson and R. Bauer (Eds.). American Chemical Society, Washington, D.C., pp. 241–262.
- Stoger, E., C. Vaquero, E. Torres, M. Sack, L. Nicholson, J. Drossard, S. Williams, D. Keen, Y. Perrin, P. Christou, and R. Fischer. (2000). Cereal crops as viable production and storage systems for pharmaceutical scFv antibodies. *Plant Mol Biol* 42: 583–590.
- Swiezewska, E., W. Sasak, T. Mankowski, W. Jankowski, T. Vogtman, I. Krajewska, J. Hertel, E. Skoczylas, and T. Chojnacki. (1994). The search for plant polyprenols. *Acta Biochim Polon* 41: 221–260.
- Torsell, K.B.G. (1997). *Natural Product Chemistry: A Mechanistic, Biosynthetic and Ecological Approach*, 2nd ed. Swedish Pharmaceutical Press, Stockholm.
- Trifunovic, S., V. Vajs, S. Macura, N. Juranic, Z. Djarmati, R. Jankov, and S. Milosavljevic. (1998). Oxidation products of hyperforin from *Hypericum perforatum*. *Phytochem* 49: 1305–1310.
- Twyman, R.M., E. Stoger, S. Schillberg, P. Christou, and R. Fischer. (2003). Molecular farming in plants: host systems and expression technology. *Trends Biotechnol* 21: 570–578.
- Upton, R., A. Graff, E. Williamson, D. Bunting, D.M. Gatherum, E.B. Walker, V. Butterweck, U. Liefländer, A. Nahrstedt, H. Winterhoff and J. Cott. (1997). St. John's wort, *Hypericum perforatum*: quality control, analytical and therapeutic monograph. *American Herbal Pharmacopoeia*, Santa Cruz, CA, p. 38.
- Van Loon, L.C., P.A.H.M. Bakker, and C.M.J. Pieterse. (1998). Systemic resistance induced by rhizosphere bacteria. *Annu Rev Phytopathologia* 36: 453–483.
- Vaquero, C., M. Sack, J. Chandler, J. Drossard, F. Shuster, M. Monecke, S. Schillberg, and R. Fischer. (1999). Transient expression of a tumor-specific single-chain fragment and a chimeric antibody in tobacco leaves. *Proc Natl Acad Sci USA* 96: 11128–11133.
- Vardapetyan, H.R., A.B. Kirakosyan, and A.G. Charchoglyan. (2000). The kinetics regularities of the globular structures growth in cell cultures of *Hypericum perforatum* L. *Biotechnology* 4: 53–58.
- Vasil, V., F. Redway, and I.K. Vasil. (1990). Regeneration of plants from embryogenic suspension culture protoplasts of wheat (*Triticum aestivum* L.). *Bio/Technology* 8: 429–434.
- Verotta, L., G. Appendino, J. Jakupovic, and E. Bambardelli. (2000). Hyperforin analogues from St. John's Wort (*Hypericum perforatum*). *J Nat Prod* 63: 412–415.
- Verpoorte, R. (1996). Plant cell biotechnological research in the Netherlands. In *Plant Cell Culture Secondary Metabolism*, F. DiCosmo and M. Misawa (Eds.). CRC Press, Boca Raton, Florida, p. 660.
- Verpoorte, R. (1998). Exploration of nature's chemodiversity: the role of secondary metabolites as lead for drug development. *Drug Disc Today* 3: 232–238.
- Verpoorte, R. (1999). Chemodiversity and the biological role of secondary metabolites, some thoughts for selecting plant material for drug development. In *Bioassay Methods in Natural Product Research and Drug Development. Proceedings of the Phytochemical Society of Europe*, Vol. 43, L. Bohlin and J.G. Bruhn (Eds.). Kluwer, Dordrecht, pp. 11–25.
- Verpoorte, R. (2000). Pharmacognosy in the new millennium: leadfinding and biotechnology. *J Pharm Pharmacol* 52: 253–262.
- Verpoorte, R. and A.W. Alfermann. (2000). *Metabolic Engineering of Plant Secondary Metabolism*. Kluwer, Dordrecht.

- Verpoorte, R. and J. Memelink. (2002). Engineering secondary metabolite production in plants. *Curr Opin Biotechnol* 13: 181–187.
- Verpoorte, R., R. van der Heijden, and J. Memelink. (2000). Engineering the plant cell factory for secondary metabolite production. *Transgenic Res* 9: 323–343.
- Verpoorte, R., R. van der Heijden, J.H.C. Hoge, and H.J.G. ten Hoopen. (1994). Plant cell biotechnology for the production of secondary metabolites. *Pure & Appl Chem* 66: 2307–2310.
- Verpoorte, R., R. van der Heijden, H.J.G. ten Hoopen, and J. Memelink. (1999). Metabolic engineering of plant secondary metabolite pathways for the production of fine chemicals. *Biotechnol Lett* 21: 467–479.
- Vogel, H.C. and C.L. Tadaro. (1997). *Fermentation and Biochemical Engineering Handbook — Principles, Process Design, and Equipment*, 2nd ed. William Andrew Publishing/Noyes, Park Ridge, New Jersey.
- Von Eiff, M., H. Brunner, A. Haegeli, U. Kreuter, B. Martina, B. Meier, and W. Schaffner. (1994). Hawthorn/Passionflower extract and improvement in physical capacity of patients with dyspnoea Class II of the NYHM functional classification. *Acta Therap* 20: 47–66.
- Walker, T.S., H.P. Bais, and J.M. Vivanco. (2002). Jasmonic acid-induced hypericin production in cell suspension cultures of *Hypericum perforatum* L. (St. John's wort). *Phytochem* 60: 289–293.
- Ward, E.S., D. Gusson, A.D. Griffiths, P.T. Jones, and G. Winter. (1989). Binding activities of a repertoire of single immunoglobulin variable domains secreted from *Escherichia coli*. *Nature* 341: 544–546.
- Ward, R.S. (1995). Lignans, neolignans, and related compounds. *Nat Prod Rep* 12: 183–205.
- Weihmayr, T. and E. Emst. (1996). Therapeutic effectiveness of *Crataegus*. *Fortschritte der Medizin* 114: 27–29.
- Worn, A. and A. Pluckthun. (2001). Stability engineering of antibody single-chain Fv fragments. *J Mol Biol* 305: 989–1010.
- Xu, J.F., P.Q. Ying, A.M. Han, and Z.G. Su. (1999). Enhanced salidroside production in liquid-cultivated compact callus aggregates of *Rhodiola sachalinensis*: manipulation of plant growth regulators and sucrose. *Plant Cell Tiss Org Cult* 55: 53–58.
- Zenk, M.H. (1991). Chasing the enzymes of secondary metabolism: plant cultures as a pot of gold. *Phytochem* 30: 3861–3863.
- Zenk, M.H., H. El-Shagi, H. Arens, J. Stockigt, E.W. Weiler, and B. Deus. (1977). Formation of indole alkaloids serpentine and ajmalicine in cell suspension cultures of *Catharanthus roseus*. In *Plant Tissue Culture and Its Biotechnological Application*, W. Barz, E. Reinhard, and M.H. Zenk (Eds.). Springer-Verlag, Heidelberg, pp. 27–43.
- Zhang, Z., Q. Chang, M. Zhu, Y. Huang, W.K.K. Ho, and Z.-Y. Chen. (2001). Characterization of antioxidants present in hawthorn fruits. *J Nutr Biochem* 12: 144–152.
- Zhao, J., L.C. Davis, and R. Verpoorte. (2005). Elicitor signal transduction leading to production of plant secondary metabolites. *Biotechnol Adv* 23: 283–333.

# 8

## *Traditional, Analytical, and Preparative Separations of Natural Products*

Leland J. Cseke, William N. Setzer, Bernhard Vogler, Ara Kirakosyan,  
and Peter B. Kaufman

### CONTENTS

8.1	Introduction .....	264
8.1.1	Traditional Methods .....	264
8.1.2	Contemporary Methods.....	265
8.2	Collection, Storage, and Vouchering of Plants.....	265
8.2.1	Collection of Plants in the Field: Do's and Don'ts.....	265
8.2.2	Storage of Plants at Low Temperatures.....	266
8.2.3	Vouchering of Plants Collected in the Field .....	266
8.2.3.1	Keep a Good Logbook.....	267
8.2.3.2	Photographic Records of Plants Collected.....	267
8.2.3.3	Preparation of Dry Specimens.....	268
8.2.3.4	Living Plant Specimens .....	268
8.3	Grinding and Extraction Protocols .....	268
8.3.1	General Extraction Protocols for Biologically Important Compounds.....	268
8.3.1.1	Rupturing Bacterial Cells .....	269
8.3.1.2	Rupturing Plant Cell Suspension Cultures.....	270
8.3.1.3	Rupturing Whole Plant Tissues .....	270
8.3.1.4	The Extraction Process .....	271
8.3.2	Aqueous and Organic-Solvent Extraction Methods.....	271
8.3.2.1	Aqueous Extraction of Compounds.....	271
8.3.2.2	Laboratory Methods of Organic-Solvent Extraction of Compounds.....	274
8.3.3	Use of Detergents, Alcohols, and Dimethylsulfoxide (DMSO) to Extract Compounds of Interest without Killing the Tissue .....	275
8.3.4	Ultrasonic Extractions.....	276
8.3.5	Microwave-Assisted Extractions.....	276
8.3.6	Supercritical Fluid Extractions .....	276
8.3.7	Case Studies: Purification of Crude Extracts from Plant Tissues.....	277
8.3.7.1	Purification of Crude Extracts Containing Taxol® .....	277
8.3.7.2	Extraction of Cuticular Wax from Needles of Yew ( <i>Taxus</i> ) Plants .....	281
8.3.7.3	Extraction of Proanthocyanidins and Flavonoids in Leaves of Hawthorn .....	282
8.3.7.4	Extraction of Proteins from Fresh Plant Tissues.....	283
8.4	Analytical and Preparative Chromatography Protocols .....	284
8.4.1	An Overview .....	284
8.4.2	Adsorption Chromatography.....	286
8.4.2.1	Thin-Layer Chromatography (TLC).....	286
8.4.2.2	Preparative Column Chromatography .....	290
8.4.2.3	Affinity Chromatography .....	291
8.4.2.4	High-Performance Liquid Chromatography (HPLC).....	291
8.4.3	Partition Chromatography .....	293
8.4.3.1	Paper Chromatography .....	293
8.4.3.2	Countercurrent Chromatography .....	293



8.4.4	Gas Chromatography .....	294
8.4.5	Size-Exclusion Chromatography .....	294
8.4.6	Case Studies: Examples of Chromatography Protocols.....	297
8.4.6.1	Purification of Proteins Using Ion-Exchange Chromatography .....	297
8.4.6.2	Extraction and Bioactivity-Directed Separation of the Bark of an Undescribed <i>Salacia</i> Species from Monteverde, Costa Rica.....	298
8.5	Electrophoresis .....	301
8.5.1	The Basics .....	301
8.5.2	Agarose Gel Electrophoresis.....	301
8.5.3	Polyacrylamide Gel Electrophoresis (PAGE).....	302
8.5.3.1	SDS-PAGE .....	302
8.5.3.2	Nondenaturing PAGE.....	303
8.5.3.3	Two-Dimensional Gel Electrophoresis.....	303
8.5.3.4	Staining Techniques .....	304
8.5.4	Capillary Electrophoresis.....	305
8.5.4.1	Basic Modes of Capillary Electrophoresis.....	307
8.5.4.2	Selecting the Mode of Capillary Electrophoresis .....	311
8.6	Conclusions .....	313
	References .....	313

---

## 8.1 Introduction

It was estimated that about 80% of all the world's medicines are originally derived from plant sources, especially those found in tropical regions. However, many of the plants within these often remote regions of the world have yet to be identified as species, and only about 15% of the known angiosperm species in these regions were examined for their medicinal potential. Therefore, there are most definitely a large number of plant-derived medicines and other useful compounds that have yet to be discovered and characterized around the world. While we discuss the social problems of environmental and plant conservation in other chapters (see Chapters 14 and 15), the aim of this chapter is to give the reader an understanding of how one begins to determine what plants have useful compounds by looking at the process of plant collection, methods of extracting compounds, and general methods of separating plant compounds within crude extracts. In Chapters 9 and 10, we go on to explore how isolated compounds are characterized, with a focus on nuclear magnetic resonance (NMR) techniques and bioassays for the characterization of potential medical benefits.

### 8.1.1 Traditional Methods

Much of the knowledge about plants that have useful properties comes from native populations of people living in each given area. Natural medicines have been used for centuries in many parts of Asia, such as China and India. In particular, Native Americans had a profound influence on the natural medicines of today (Ody, 1993). For centuries, such native peoples passed on this knowledge from generation to generation, making use of techniques that they had available to them to perform plant extractions. Such traditional methods used for the separation of metabolites from plant materials include the use of hot water extracts to make teas or natural plant dyes (e.g., the monoterpenes from mints to make mint tea). Salves and decoctions are often made from a single plant source (e.g., the oleoresin terpenes from pitch of balsam fir used directly to treat burns). However, more complicated mixtures of plants are also used (e.g., many commercial herbal teas that utilize chamomile, mint, bee balm, lavender, and other plants or upregulators of the immune system, such as Echinacea and goldseal). The important idea here is that such extracts or preparations rely on the **synergistic action** of several plant metabolites that are more effective than any one alone (see Chapter 13). An excellent discussion of these traditional methods is found in Penelope Ody's book, *The Complete Medicinal Herbal* (1993), but the point remains that plant extractions in even a traditional sense can be diverse due to the complexity of the mixtures of compounds resulting from crude extraction processes. Consequently, during the technological advances of the last

century, contemporary methods were developed to better separate the specific compounds within crude plant extracts, allowing for better characterization of the usefulness of each compound.

### 8.1.2 Contemporary Methods

Modern methods of isolation of natural products, in contrast to traditional methods, utilize principles of extraction that are based on the **polarity** (relative solubility in organic solvents), solubility in water, and various alterational solubilities based on salts and pH (relative acidity or alkalinity) (see Chapter 1). These contemporary methods are meant to complement the traditional methods. Yet, they provide a greater degree of resolution of the types of metabolites present in plant samples (see Chapter 2). They also allow one to quantitate their levels and to study how genetic and environmental factors regulate their synthesis (see Chapter 3). The basic methods for extraction and quantitation of the metabolites present are described in detail in this chapter and in Chapter 23 of Cseke et al. (2004).

---

## 8.2 Collection, Storage, and Vouchering of Plants

The first steps in isolating natural products are to be able to identify the plants of interest and to preserve the compounds within them. During discovery projects, it is not normally known which of the plants actually have useful compounds. Therefore, it is essential to be able to keep complete records of all collected specimens. The following sections offer suggestions to follow, based on our experience.

### 8.2.1 Collection of Plants in the Field: Do's and Don'ts

When collecting plants in the field for natural product extractions, it is important to be properly prepared. We recommend the following:

- Wear field clothes, and cover yourself head to toe if collecting is to be in the cold of winter or when mosquitoes or flies are in abundance.
- Take along a notepad (Rite in the Rain® waterproof paper is excellent) and pencil to record information about the collecting site location, soil conditions, ecological habitat, date of collection, plant identity, and who collected the plant(s).
- If possible, take along a portable global positioning system (GPS) unit/altimeter for recording geographical positions and elevations.
- Take soil samples from each site so as to get information later on soil nutrients, soil pH, and soil type where each plant grows.
- Take along a pocket-size field guide (with photos, drawings, and good, usable identification keys) to the local flora and a hand lens to help you identify each plant.
- Take a good-quality digital camera to keep a photographic record of each plant.

Unfortunately, during field collections, the availability of optimal storage equipment is often not an option due to the remote collection locations. Depending on weather, the trip will be short or long. With available storage equipment nearby, we recommend the following:

- If you are collecting live plants on a short trip (1 or 2 h) and have access to liquid nitrogen, take along a large thermos full of liquid nitrogen and some aluminum foil. The thermos should have a good handle on it to avoid spilling liquid nitrogen on your skin. The samples can be collected, wrapped in aluminum foil pockets, labeled with a Sharpie® pen, and dropped into the liquid nitrogen. This is by far the best method for preserving compounds within the plant that may be easily degraded or chemically altered. Remember not to close the cap on the thermos too tightly, or the container will explode.

- If you are collecting live plants on a longer trip, or you do not have access to liquid nitrogen, take some Ziploc® plastic bags of various sizes in which to put the samples after collecting plants on site. Such bags keep the plant materials alive until they can be frozen. Slips of recycled waterproof paper or flagging tape are good to have so you can place notes on plant identity with your collected specimens that match up with your field notes about the respective collections.
- In all cases, when you collect plants for extracts, it is important to get representative samples of all parts available: roots, vegetative shoots, bark from stems (if woody plant), flowers, fruits, and seeds (if mature).
- When collecting plants in the field, *do not* take every last plant in the population, especially if the plant is rare, threatened, or endangered.
- In the process of collecting herbaceous perennial plants (plants that come from the same mother plant year after year), leave some of the original plant intact where it is growing so that it can reproduce during the current and following years. Many of these plants take years to produce even a small amount of new biomass every year.
- If you are collecting mushrooms or puffballs in the field, wrap the fruiting bodies in wax paper and place them in a collecting basket or other suitable container where they will not become squashed. This will help for later identification and for making spore prints from the fruiting bodies. This is impossible with giant puffballs (*Calvatia gigantea*); these can be collected intact and placed in large paper shopping bags. Some of these mushrooms attain a diameter of 0.5 m.
- As the Native Americans do, *thank the plant* for providing you with substrate for your extracts. While this may not seem important to some, we all do this in various ways when we collect plants in the home garden for food or for aesthetic purposes, or when we collect wild edible plants in the field.

### 8.2.2 Storage of Plants at Low Temperatures

As noted above, one of the most important aspects of plant collection for the purpose of extracting many natural plant products is the preservation of the compounds within the collected tissue. By far the best way to do this is by quickly freezing the tissue in liquid nitrogen. Such samples can then be stored long term in a  $-80^{\circ}\text{C}$  commercial freezer. This technique prevents almost all degradation of the plant material or any enzymatic changes that alter or degrade naturally occurring metabolites. Such techniques are especially important for molecular biological studies, because once a plant is damaged by being picked, it undergoes a drastic defense response that can greatly alter the composition of plant compounds, such as RNA and proteins. Also, many additional stress compounds are produced once the plant perceives itself as having been “attacked” during the collection process. So, one must work quickly to keep the natural components of the plant intact. Even if liquid nitrogen is not available, it is a good idea to freeze the specimens that will be used for extraction immediately in a freezer at  $-20^{\circ}\text{C}$  or in a commercial freezer held at  $-80^{\circ}\text{C}$ . However, some of the collected plant material should be kept unfrozen for the vouchersing process (see below).

On the other hand, natural drying of the plant material can also be done if yield of metabolites is not critical. This is usually the case for plant material used for dyeing fibers. This also works well when using seeds for extraction. Seeds are usually dried to a low moisture content to prolong seed viability. If the drying process is slow and the temperature is at ambient level, very little degradation of stored metabolites in the seeds occurs. However, for extraction of medicinal compounds from plants, the use of dried plant material is not desirable due to degradation of naturally occurring metabolites during the drying process. Rather, it is best to rely on the use of frozen plant material.

### 8.2.3 Vouchersing of Plants Collected in the Field

The vouchersing process involves keeping detailed records of the collected plant tissue. It may not be known for some time if a particular collected tissue will contain compounds of interest. This is especially

true when searching for new medicinal compounds. So, accurate and lasting records are absolutely essential. We recommend using the following combination of approaches.

### 8.2.3.1 Keep a Good Logbook

One should always keep a logbook of the plants and the tissues that were collected and frozen. This includes information about the collecting site location, soil conditions, ecological habitat, environmental conditions, as well as the date of collection, plant identity, and who collected the plant. Many times, the environmental conditions help control the biosynthesis of various compounds; so, a record of the collection conditions may help to avoid confusion when comparing multiple collections of the same type of plant. For similar reasons, we recommend taking soil samples and later recording information on soil nutrients, soil pH, and soil type where each plant grows. It is also important that proper labels be kept on samples stored in the freezer. Slips of paper work well inside Ziploc plastic bags at  $-20^{\circ}\text{C}$ , but these bags do not work well at  $-80^{\circ}\text{C}$ . In these conditions, it is better to store the tissue inside aluminum foil packets labeled with a Sharpie pen. In addition, a backup inventory on the computer is a good idea. Why is this important? Sometimes, labels with collected plant material become lost. Sometimes, one needs to examine lists of collected plants quickly, without having to go through all of the frozen material. And sometimes, one needs to send such lists to others involved in the project.

### 8.2.3.2 Photographic Records of Plants Collected

It is often desirable to keep photographic records of plants that were collected, either for plant identification or for re-collection of a particular plant. We recommend taking digital photographs of the live plant in the field in addition to performing high-resolution scans (using a flatbed computer scanner) back in the laboratory. The newer digital cameras provide high-resolution photos with special built-in features, such as macro-lenses that provide surprising detail and good-quality flashes for low-light conditions. Most of the computer scanners available can scan images in excess of 1200 dpi, and such detailed photographic records augment any herbarium voucher specimens (see below and example shown in Figure 8.1).



**FIGURE 8.1** Digital photograph and scan of *Calyptanthes pallens* (Myrtaceae), spicewood, collected from Abaco Island, the Bahamas.

### 8.2.3.3 Preparation of Dry Specimens

Dried plant specimens are prepared in order to have them available at any time as voucher specimens representing typical plants that were collected in the field and used for plant extracts. They are also called **herbarium specimens**. Dried plant specimens are prepared in the traditional way by placing the collected plant between single newspaper sheets and then placing this in a sandwich consisting of a dry blotter above and below the newspaper sheets. A piece of corrugated cardboard (with air spaces present) is then placed above and below each blotter. Successive sandwiches are placed atop one another and then compressed between two wood-slatted frames and tied together tightly with straps. The entire assembly is then placed upright on its side over a heat source, such as a radiator or a plant drier, with the heat on a moderate temperature (e.g., 35 to 40°C). The specimens are allowed to dry this way for 48 h or longer. If plant specimens are very high in water content, it is a good idea to replace the blotters with dry ones in the middle of the drying process.

Rapid drying ensures that plant pigments are well preserved; if the drying process is slow, chlorophylls will degrade, and the leaves will appear yellow; flower pigments also fade badly with slow drying. For this reason, newer methods making use of a microwave oven have also been developed. This works especially well for the preservation of flower color. The tissue is placed between two sheets of absorbent paper and compressed between two blotters, similar to the above technique. The final sandwich (pressed in a microwave-safe frame) is then heated in a microwave oven for 1 to 5 min, depending on the type of tissue. In a similar technique, plant tissues can be submerged in silica gel crystals and heated in a microwave. However, such samples are not flat, making them more difficult to store.

Once plant specimens are dry, they can be mounted flat (with glue or cement) on heavy paper of sufficient size to accommodate the specimen and a label with information about the plant, location of the collecting site, collector, date of collection, genus and species of the plant, and the family to which the plant belongs. The label may be placed in the lower right-hand corner of the sheet of heavy paper. To avoid damage to the dry, mounted specimen, the entire sheet can be covered with Saran™ Wrap or even laminated if the equipment is available. Dried sheets with plants mounted on them are usually stored in an airtight cabinet in which paradichlorobenzene or naphthalene flakes are kept to deter insects that can damage the specimens. If use of such chemicals is not desirable due to their harmful effects to humans if inhaled continuously, natural insect repellents, such as dried lavender (*Lavandula officinalis*) or neem (*Azadirachta indica*), or other less toxic commercial repellents can be used.

### 8.2.3.4 Living Plant Specimens

In our experience, we found it to be a good idea to collect seeds and living specimens of the plants that are to be used for the extraction of natural products. We do this in order to have the living plants on hand (e.g., medicinal plants, dye plants, or culinary herb garden or in a greenhouse) to be used for later extractions or experimental treatments to enhance metabolite biosynthesis; this is especially important when access to the original collecting site is not possible or convenient. A good example of this is with the tree of joy (*Camptotheca accuminata*), which is the source of the drug camptothecin, used to treat patients with prostate cancer. Our original seed came from China, and it would not be convenient to travel to China each time that we need tissue for further experiments. Thus, the seed used in our greenhouse experiments came from progeny from the original Chinese seeds that were grown in Louisiana. These seeds were kindly provided by Mr. Tracy Moore, President of Xylomed Research, Inc., in Monroe, LA (Figure 8.2). Using records that came from the naturally growing tree of joy, we were able to simulate the growing conditions in our greenhouse, thereby being able to reproduce natural levels of camptothecin. The results from these studies are provided in the research essay in Chapter 3, written by Atul Rustgi and Ashish Goyal.

---

## 8.3 Grinding and Extraction Protocols

### 8.3.1 General Extraction Protocols for Biologically Important Compounds

The primary ways to extract organic molecules of interest to biologists and medical investigators involve breaking open the cells of the organism under investigation. Cell rupturing is accomplished in a variety



**FIGURE 8.2** (Left to right) Dr. Stanley Carpenter, Louisiana State University (LSU); Dr. Zhijun Liu, postdoctoral research fellow at LSU; Tracy Moore, president of XyloMed Research, Inc.; and Dr. John D. Tarven, LSU, while visiting Beijing, People's Republic of China, in November 1996 to collect seed from different native populations of tree of joy (*Camptotheca accuminata*), the source of the drug, camptothecin, used to treat cancer patients. (Photo courtesy of Tracy Moore.)

of ways. The method used depends on the type of organism being considered and the type of tissue used. In this section, we aim to give the reader a general understanding of such protocols. In the following sections, we examine in more detail traditional and contemporary extraction methods that have proven particularly useful for subsequent natural product separations.

It is important to note here that many compounds are rapidly degraded once the extraction process has begun. For example, there are many **proteases** located inside of each cell. Normally, these proteases are sequestered into specific regions of the cell, where they do little damage to important proteins. However, once the cells are ruptured, the proteases are released, and they begin to destroy potentially important proteins. To maximally inhibit those proteases, it is important to keep the temperature low (from 0 to 4°C), and **protease inhibitors** are commonly added to lysis solutions or **buffers** used for protein/enzyme isolation. There is also a wide variety of different solutions used for compound extraction. It is strongly recommended that specific buffer conditions be maintained during the extraction and purification of water-soluble compounds because the structures or activities of many compounds are sensitive to pH changes. Using the example of proteins, it is essential to use proper buffering, because some proteins or enzymes may be degraded or lose their enzymatic activities. Such buffer conditions need to be optimized for specific cells, tissues, and protein types. In addition, extraction and purification of membrane proteins usually requires detergents to help release them from the membranes (see Section 8.3.7.4), and many proteins require specific reducing agents, salts, and metal ions to remain active. Therefore, the choice of rupturing procedure and extraction solution is often critical for the extraction of specific plant products. A good discussion of these methods is found in Cseke et al. (2004).

### 8.3.1.1 Rupturing Bacterial Cells

Bacterial cells, like plant cells, have very strong cell walls that often make them difficult to extract. Modern protocols for the extraction of water-soluble compounds make use of specific enzymes that are able to cleave the protein components of the bacterial cell wall. In such protocols, cell cultures are pelletized by spinning them in a centrifuge. The pellet is then resuspended in lysis buffer, to which an enzyme, such as **lysozyme**, is added. After an incubation period, the suspension becomes very viscous due to large amounts of released DNA from inside the cells. This can be reduced through the addition of other enzymes, such as **DNase I**, to chop up the DNA and reduce the viscosity of the final extract (see Cseke et al., 2004). Traditional bacterial extractions make use of a **French press** so as to break open the cell walls. This involves using a heavy cylinder with high pressure applied to a piston that compresses the cells in an extraction solution into a successively smaller volume within the free cylinder. As the cells leave the cylinder, the rapid drop in pressure causes the cells to lyse and release their components.

### 8.3.1.2 Rupturing Plant Cell Suspension Cultures

Like the bacterial procedures discussed above, similar procedures are used for plant cells grown in suspension culture or for plant callus tissue. Specific enzymes, such as **cellulase** or **pectinase**, can be added to lyse the walls of cells in aqueous solutions, or the cells can be passed through a French press. Many plant cells grown in culture can simply be ruptured with a **glass tissue homogenizer**. However, another good method for disrupting cells in suspension involves the use of special equipment called a **sonicator**. In this case, the sonicator releases repeated high-frequency pulses of ultrasonic vibrations that rupture the cell membranes. For heat-sensitive compounds, such as proteins or RNA, it is especially important to keep the sample on ice, because the sonicator vibrations generate a great deal of heat. This is why repeated pulses are used instead of a continuous discharge; this procedure allows the sample to cool between pulses. Many of these methods, however, assume that water-soluble compounds are being extracted, and they may not be applicable to many compounds. In these cases, the culture can be spun down in a centrifuge to yield a pellet that can be used as described below.

### 8.3.1.3 Rupturing Whole Plant Tissues

Probably the best way to extract highly lignified or silicified plant tissues within organs such as leaves, stems, roots, seeds, or fruits is to freeze the tissue and pulverize it using liquid nitrogen in a mortar and pestle (Figure 8.3). This frozen powder can then be added to an appropriate extraction solution and



A



B

**FIGURE 8.3** (A) A typical container used for the storage of liquid nitrogen. (B) Gregg Roslun, undergraduate student at the University of Michigan, grinding a frozen plant sample with liquid nitrogen and a ceramic mortar and pestle, in preparation for analysis of products of medicinal value in this sample. (Photo by David Bay.)

processed for final extraction (see Section 8.3.2). On the other hand, fresh tissue can simply be finely chopped using a food processor or finely milled using a **Wiley mill**, and softer plant tissues can be ground in a small volume of buffer in a mortar, using whitewashed sand and a pestle to rupture the cells. The bottom line here is that the more finely ground the material is, the better the final extraction of compounds will be.

#### 8.3.1.4 The Extraction Process

Once the cells are ruptured, the actual extraction is performed using techniques that depend on the chemical properties of the compounds of interest. Water-soluble compounds and proteins are extracted in water or buffers. Water-insoluble compounds are extracted with organic solvents. For example, because taxanes are miscible in methanol, this solvent is often used as the extraction reagent. This is by no means the only solvent that will work (see Section 8.3.2). Some compounds, such as cell-wall constituents, have no need to be solubilized for extraction, because they can be obtained in pellet form by filtration or centrifugation followed by washing with buffer solutions. It is worth noting that integral membrane proteins often require the use of strong detergents, such as **Triton X 100**, to be extracted from the membranes (see Section 8.3.7.4).

Two steps are usually critical for good extraction. First, ruptured cells should be ground or homogenized in the extraction solvent, depending on the cell-rupturing technique chosen. For example, **taxanes** (terpenoid compounds derived from plants) are extracted by grinding the plant tissue in organic solvent (methanol) in the same mortar and pestle that is used for the liquid nitrogen to rupture the cells. **Waxes**, on the other hand, can be removed from the aqueous phase coming from a French press by homogenizing and partitioning with chloroform and methanol. Second, once ground or homogenized, the extraction mixture should be allowed to stand undisturbed for 0.5 to 24 h at a temperature that will not allow degradation of the compound(s) or protein(s) of interest to occur (e.g., 4°C). This is done simply to allow time for the extraction solvent to penetrate all parts of the ruptured cells.

After these two critical steps, the resulting slurry is filtered to obtain a filtrate free of particulates, or it is centrifuged in order to obtain a **cell-wall or membrane pellet fraction** and a cell cytosol-containing **supernatant fraction**. Such crude fractions can be used directly for enzyme reaction assays, or they can be subjected to further purification and cleanup procedures in order to separate and identify the compounds of interest. For example, C18 Sep-Pak™ columns can be used to remove **chlorophylls**, which interfere with subsequent analysis of taxane extractions (compare Figure 8.7A and B).

For the extraction of natural products of potential medicinal or other value in plant samples, the protocols in the following sections can be employed. These are the conventional counterparts based on the more traditional methods described above.

### 8.3.2 Aqueous and Organic-Solvent Extraction Methods

Extraction methods to be chosen should be based on knowledge of several physicochemical properties of the compound of interest. These include partition coefficients in water or organic solvents, relative polarity of the molecule, stability of the molecule in light or dark, as well as the temperature employed during the extraction process. So, if the compound of interest is highly soluble in water, we employ hot or cold water to obtain an **aqueous extract**. If, on the other hand, the compound is highly soluble in a particular organic solvent, we employ that solvent to obtain an **organic-solvent extract**.

#### 8.3.2.1 Aqueous Extraction of Compounds

##### 8.3.2.1.1 Traditional Methods of Aqueous Extraction

The preparation of **herbal remedies** based on traditional methods of water extraction utilizes two different approaches: if extracting **herbaceous tissues** of leaves, roots, and flowers, or soft-textured fruits with a relatively high water content (in the range of 60 to 95% water) with hot water or cold water, relatively mild physical conditions are used to obtain what is called an **infusion**. However, for woody,



highly lignified tissues with relatively low water content (in the range of 5 to 50% water), such as roots, barks, twigs, and some dry fruits, we need to employ more vigorous physical extraction procedures, using longer extraction times and boiling water, to obtain what is called a **decoction**. There is an almost endless list of methods for preparing infusions and decoctions, but all are based on the same principles. An example of each type of traditional extraction is described in the following sections.

The preparation of **hot water infusions** can be done as follows:

1. Begin with a standard quantity of tissue to be extracted, such as 30 g dried herb (either freeze-dried or dried on newspaper over several days in the dark, as with rose hip tea [from fruits of *Rosa* spp.], lemon balm tea [from leaves of *Melissa officinalis*], bee balm tea [from leaves of *Monarda didyma*], chamomile tea [from flowers of *Matricaria* spp.], mint tea [from leaves of *Mentha* spp.], green tea [from shoot tips of *Camelia sinensis*], or rhubarb tea [from leaf petioles of *Rheum palmatum*]). Fermented dried herb can also be used in similar amounts (as with black tea, derived from fermented shoot tips of *Camelia sinensis*). Generally, more tissue weight is used for fresh herbs due to the water content in the tissue. Fresh herbs are best collected from young leaves and shoot tips.
2. Place the herb in a teapot or water-boiling kettle that includes a tight-fitting lid.
3. Pour hot water (preferably from a reliable bottled water source or water rendered potable [drinkable] by boiling and filtering) over the herb and allow to infuse for 10 min.
4. Pour the ambient hot water extract through a nylon sieve or strainer.
5. Use the infusion immediately, as you would for a cup of hot tea. Such infusions can also be stored in a brown bottle away from the light in a cool place, like a refrigerator, and must be used after no more than one year because of degradation of the active constituents. If bacterial or fungal contamination occurs, the infusion should be thrown out immediately.

The preparation of **cold water infusions** can be done as follows:

1. Place several bags of black tea (obtained from *Camelia sinensis*) in a clear glass jar or bottle filled with cold water.
2. Cover the jar to exclude particulate matter, such as dust or insects.
3. Allow to stand in the sun outdoors for a single day.
4. Chill by storing in a refrigerator at 4°C.
5. Drink when cold. The product here is often called **sun-made tea**.

The preparation of a **decoction** can be done as follows:

1. Place the quantity of herb (described above) in a saucepan, and add cold water. Again, the tissues requiring the preparation of a decoction are often woody or highly lignified tissues.
2. Bring the water to a boil (100°C).
3. Allow to simmer for up to 60 min or until the volume has been reduced by one-third.
4. Strain the mixture through a nylon sieve into a bottle or jar.
5. Store in a cool place, such as a refrigerator, at 4°C. If bacterial or fungal contamination occurs, the decoction should be thrown out immediately.

The above and other methods of preparation of plant extracts for medicinal purposes (like tinctures, syrups, hot and cold oil infusions, creams, ointments, powders and capsules, compresses, and poultices) are described and beautifully illustrated by Penelope Ody in *The Complete Medicinal Herbal* (1993, pp. 116–125).

### 8.3.2.1.2 Laboratory Methods of Aqueous Extraction

In contrast with the traditional methods of aqueous extraction described above, laboratory methods for aqueous extraction rely on the use of more stringent quantitative procedures and more sophisticated equipment. This is evident in the following methods typically used to prepare lab-type **hot water extracts** that allow for compounds of a more **polar** nature to be obtained (see Chapter 1):

1. Weigh out a 0.5 g sample of a given plant that was previously placed in a deep freeze at  $-80^{\circ}\text{C}$ .
2. Grind frozen plant tissues to a fine powder using small amounts of liquid nitrogen in a ceramic **mortar** and grinding with a ceramic **pestle**.
3. Place 0.5 g of the powder into a 20 ml Corex<sup>®</sup> or Pyrex<sup>®</sup> centrifuge tube containing 10 ml of hot ( $80^{\circ}\text{C}$ ) water, and place the tube into a hot-water bath for 10 min.
4. Centrifuge the extract at  $3000\text{-g}$  for 10 min. By centrifuging it, all of the particulate plant materials from the grinding get pelleted at the bottom of the tube, leaving a relatively clear liquid (the **supernatant**) containing the water-soluble compounds of interest.
5. Filter the supernatant using a  $40\ \mu\text{m}$  filter disk in the filtration apparatus to make sure that no plant particulates remain in the filtrate.
6. Freeze-dry/lyophilize the filtrate. It may require 2 to 12 h to lyophilize the filtered extract so as to remove all moisture.

This yields a powdered residue that can then be used to separate and identify the kinds and amounts of compounds present by means of high-performance liquid chromatography/mass spectrometry (HPLC/MS) or other appropriate procedures. Some of these characterization procedures are described later in this chapter as well as in Chapter 9.

#### Hot Water Extraction Protocol for Natural Product Screens

Weigh 0.5 g samples of plant tissue from tissue stored at  $-80^{\circ}\text{C}$  in a deep freeze

↓  
Grind the sample in liquid  $\text{N}_2$  to a fine powder

↓  
Place tissue in 10 ml of hot ( $80^{\circ}\text{C}$ ) water for 10 min

↓  
Centrifuge at  $3000 \times g$  and take supernatant

↓  
Filter supernatant through a glass filter

↓  
Lyophilize the sample to dryness

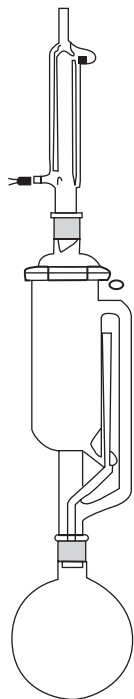

FIGURE 8.4 Soxhlet extractor. (From AM Glassware Ltd. catalog.)

### 8.3.2.2 Laboratory Methods of Organic-Solvent Extraction of Compounds

If the compounds of interest are not soluble in water because of their **non-polar** nature (see Chapter 1), select an organic solvent (e.g., acetone, methanol, ethanol, chloroform, diethyl ether, methylene chloride, or a combination of more than one organic solvent) to carry out the extraction. The temperature of this extraction depends on the boiling point of the solvent chosen and must be carefully watched due to the special equipment that is used. One can use a **Soxhlet extractor**, which is basically a specialized glass refluxing unit that is used for such organic-solvent extractions (Figure 8.4). In the following example (using a 1:1 mixture of methylene chloride/methanol), the temperature must be maintained at 40°C for 8 h in order to obtain complete extraction of each sample. If the temperature falls below this, extraction will be slow. If the temperature goes above this, the risk of degrading the compounds of interest becomes great. With the presence of higher temperatures, there is always the risk of degrading some of the active compounds; thus, low-boiling-point solvents, such as dichloromethane or diethyl ether, are usually the best choice. The basic procedure is outlined below. Preliminary cleanup procedures are usually necessary before samples are analyzed by HPLC or by any of the other chromatographic techniques (see Section 8.3.7.1 and Figure 8.7).

The example we use here employs methylene chloride. It is highly toxic, and therefore, needs to be used in a fume hood to avoid breathing the toxic fumes. It should also be handled carefully, using latex gloves so that none of this solvent comes in contact with the skin. The extraction methods are as follows:

1. Weigh out a 0.5 g sample of plant tissue that was previously stored in deep freeze at  $-80^{\circ}\text{C}$ .
2. Grind frozen plant tissues to a fine powder using small amounts of liquid nitrogen in a ceramic **mortar** and grinding with a ceramic **pestle**.
3. Weigh out a 0.5 g sample powdered tissue in a **cellulose thimble** in a Soxhlet extractor (see Figure 8.4) containing 100 ml of a 1:1 mixture of methylene chloride/methanol.
4. Reflux the sample for 8 h at 40°C using a condenser (with running cold water) attached to the top of the Soxhlet. This condenser drops the temperature quickly, allowing the solvent to condense on the sides of the glass and drop back into the cellulose thimble.
5. Allow the solvent to cool to room temperature, and filter with a 40  $\mu\text{m}$  filter to remove any particulate matter.

6. Blow the collected liquid to dryness with a stream of N<sub>2</sub> gas, and store the sample in the refrigerator at 4°C until it is used to separate and identify the kinds and amounts of compounds present by means of HPLC/MS or other appropriate procedures. (These procedures are described later in this chapter as well as in Chapter 9.)

#### Organic-Solvent Extraction Protocol for Natural Product Screens

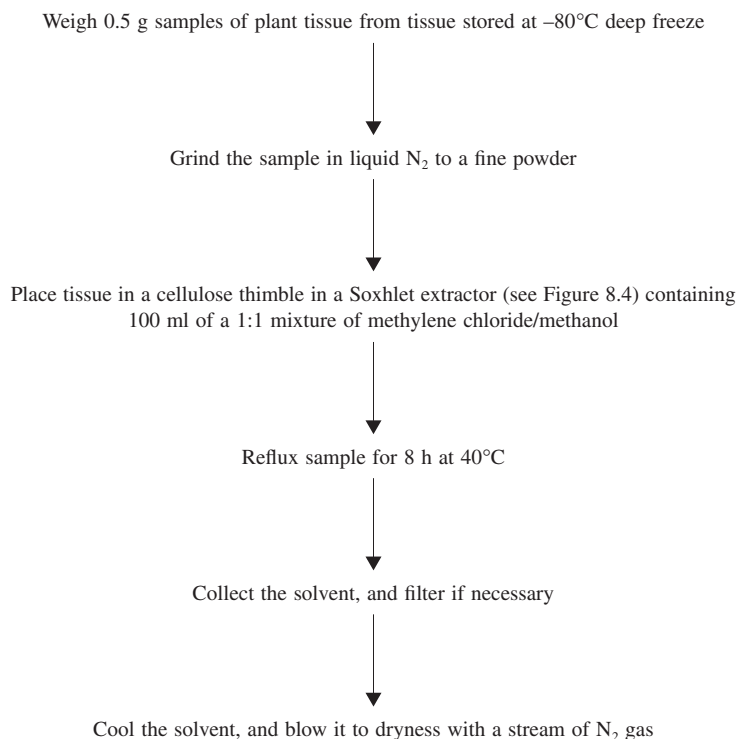

### 8.3.3 Use of Detergents, Alcohols, and Dimethylsulfoxide (DMSO) to Extract Compounds of Interest without Killing the Tissue

This is a relatively new concept being used experimentally in our laboratory to achieve maximal extraction of the metabolites of interest without actually killing the plant. It is done with seeds or green, living plants. No grinding of tissues is involved. The method relies on the partition coefficients of the chemicals used, the polarity of molecules to be extracted, and the ease with which the solvents can penetrate the tissues without killing them. **Dimethylsulfoxide (DMSO)**, alcohols (e.g., **methanol**, **ethanol**, or **long-chain alcohols**), and detergents (e.g., **XAD-4**, **styrene-divinylbenzene**) were used for this purpose. In testing such compounds in various combinations, **viability tests** must be run with the plants being extracted to obtain the compounds of interest (Komolpis et al., 1998; Wang et al., 2001).

In the study by Wang et al. (2001) on **permeabilization** of metabolites from seeds of biologically viable soybeans (*Glycine max*), the effect of 0 to 30% (v/v) of aqueous **methanol** solutions was used to permeabilize soybean seeds for the release of two isoflavonoids, **daidzein** and **genistein**. The release of these metabolites increases with increasing methanol concentrations. The amounts of daidzein and genistein released can increase up to 40- and 86-fold, respectively, when incubated in a 30% (v/v) methanol solution for 24 h compared with those incubated with water only. The effect of methanol on the release rates is primarily due to an increase in the solubility of the stored daidzein and genistein (14- to 18-fold) inside the seeds, thus maximizing the concentration gradients for metabolite release. However, the viability of the seeds drops with an increase in methanol concentrations and incubation time. The **viability** of soybeans (indicated by the ability of the seeds to germinate) after permeabilization treatment with 0 to

20% (v/v) methanol solutions was maintained above 80% throughout the 24 h period, whereas no seeds were found to be viable when 30% (v/v) methanol solution was used. The **permeability coefficients** ( $P$ ) of daidzein and genistein were found to increase as the methanol concentration used was increased. These  **$P$  values** were estimated to range from  $1.1 \cdot 10^{-9}$  to  $1.9 \cdot 10^{-8}$  m/s and  $1 \cdot 10^{-9}$  to  $1.7 \cdot 10^{-8}$  m/s, respectively. The increase in  $P$  can be attributed primarily to an increase in the **partition coefficient** of the metabolites in the soybean seed coats. Knowledge obtained from this study will help provide us with useful selection criteria for chemical permeabilization of plant tissues, such as seeds, with minimal loss in their viability.

### 8.3.4 Ultrasonic Extractions

**Ultrasonic extraction** (often called **sonication**) uses high-frequency sound to liberate phytochemicals from the plant materials. This extraction process is fast compared with traditional laboratory methods, such as maceration or Soxhlet extraction, because of particle disruption of the plant material. This type of extraction was recently used for the isolation of essential oils (Salisova et al., 1997), polysaccharides (Hromadkova et al., 1999, 2002), and bioactive phytochemicals (Vinatoru et al., 1997), including menthol (Shotipruk et al., 2001), cardiac glycosides (Ikeda et al., 1995), pyrethrins (Romdhane and Gourdon, 2002), and camptothecin (Fulzele and Satdive, 2005). However, the procedure presents problems when attempting to isolate very large molecules, such as DNA or large proteins, due to the shearing forces that occur during sonication. The process of sonication can also generate a lot of heat, so various heat-labile compounds, such as proteins, require steps to keep them cold during sonication (see below).

Typical procedures involve sonication of the finely powdered plant material with solvent for 0.5 to 2 h. For example, tartaric and malic acids were extracted this way from grape (*Vitis* spp.) seeds by sonication at 24 kHz for 30 min at 70°C using water or aqueous methanol as the solvent (Palma and Barroso, 2002). Likewise, marigold was extracted by sonication for 2 h at 25°C using petroleum ether as the solvent (Vinatoru et al., 1997). If the compound is heat-labile, however, sonication should be performed by placing the extraction container on ice. A series of short pulses of sonication (e.g., 20 rounds of approximately 30 sec pulses) are then used to allow the solvent to cool between pulses (30 sec of cooling), thus keeping more of the compounds intact (Cseke et al., 2004).

### 8.3.5 Microwave-Assisted Extractions

Microwave-assisted extractions of phytochemicals constitute another alternative to traditional laboratory methods of extraction. Numerous bioactive materials were extracted using this technique. They include essential oils (Chen and Spiro, 1994, 1995; Baker et al., 2000), taxanes from *Taxus* spp. (Mattina et al., 1997), azadirachtin-related limonoids from neem (*Azadirachta indica*) (Dai et al., 1999, 2001), glycyrrhizic acid from licorice (*Glycyrrhizia glabra*) (Pan et al., 2000), tanshinones from *Salvia miltorrhiza bunge* (Pan et al., 2002), cocaine from coca (*Erythroxylon coca*) (Brachet et al., 2002), artemisinin from *Artemisia annua* (Hao et al., 2002), ginsenosides from ginseng (*Panax ginseng*) (Shu et al., 2003), as well as camptothecin from *Nothapodytes foetida* (Fulzele and Satdive, 2005). Microwave-assisted extractions give yields comparable to Soxhlet extraction methods, but in much less time.

In general, **microwave-assisted extractions** are carried out on 1 to 10 g samples, using an appropriate solvent, and irradiation powers around 100 to 150 W. Irradiation is usually applied for short intervals with intervals of cooling time so that the samples do not super boil. For example, azadirachtin-related limonoids were extracted from neem seed kernel (Dai et al., 1999): neem seeds (2 g), defatted with petroleum ether, were extracted with 15 ml dichloromethane at 150 W, 30 s on, 30 s off, 30 s on, 30 s off, 30 s on. Similarly, ginsenosides were extracted from ginseng root: 2 g ginseng root was extracted with 15 ml 3:7 H<sub>2</sub>O/ethanol at 150 W for a total of 5 min irradiation time and gave yields comparable to 10 h of conventional refluxing solvent extraction (Shu et al., 2003).

### 8.3.6 Supercritical Fluid Extractions

A substance is in its **supercritical fluid state** when both the temperature and pressure equal or exceed the critical point (31°C and 73 atm for carbon dioxide, see Figure 8.5). In its supercritical state, CO<sub>2</sub> is

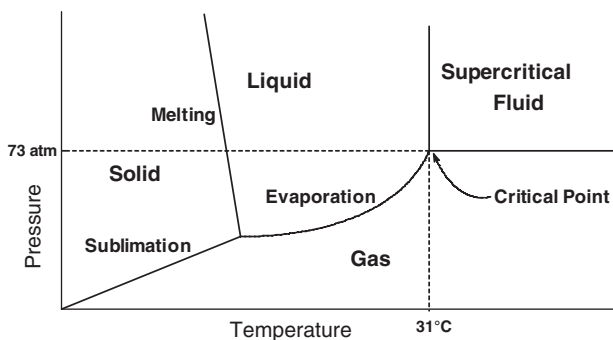

FIGURE 8.5 Phase diagram for carbon dioxide.

neither a gas nor a liquid and is best described as intermediate to the two extremes. This dual characteristic of supercritical fluids provides the ideal conditions for extracting compounds with a high degree of recovery in a short period of time (Mukhopadhyay, 2000).

Supercritical fluid extractions (SFEs) are currently being carried out with carbon dioxide on a large scale for the decaffeination of green coffee beans (*Coffea arabica*) and the extraction of hops (*Humulus lupulus*) for beer production. Carbon dioxide is the most adopted supercritical fluid due to its low cost, environmentally benign nature, lack of flammability, and reactivity. There are several advantages of SFEs compared to traditional solvent extractions (Lang and Wai, 2001; Zougagh et al., 2004). Supercritical fluids have lower viscosities and higher diffusivities than conventional solvent systems; therefore, extraction rates are enhanced, and less degradation of solutes occurs. SFE with carbon dioxide is carried out at a relatively low temperature, ca.  $-40^{\circ}\text{C}$ , avoiding the decomposition of thermally labile components. In addition, extractions can be selective to some extent, by controlling the temperature or pressure of the medium. Because of the high pressures required to perform  $\text{CO}_2$  extractions, the equipment is expensive and must be handled with care. However, commercial SFE instruments are available (e.g., Thar Technologies, Pittsburgh, PA; Applied Separations, Allentown, PA; SITEC-Sieber Engineering, Zurich, Switzerland).

SFEs with  $\text{CO}_2$  were used as alternatives to **hydrodistillation** for isolating essential oils (see, for example, Reverchon et al., 1995; da Cruz et al., 2001; Diaz-Maroto et al., 2002; Marongiu et al., 2004). Because of the non-polar nature of carbon dioxide, supercritical fluid extraction is an attractive technique for the isolation of relatively non-polar natural products, such as artemisinin from *Artemisia annua* (Kohler et al., 1997), azadirachtin from neem (*Azadirachta indica*) (Ambrosino et al., 1999), phloroglucinols from St. John's wort (*Hypericum perforatum*) (Seger et al., 2004), or triterpenoids and steroids from cork (*Quercus suber*) (Castola et al., 2005). In order to efficiently extract more polar substituents, the addition of a small amount of a liquid modifier can significantly enhance the extraction of these materials. Typical modifiers include methanol, ethanol, dichloromethane, and acetonitrile (Lang and Wai, 2001). For example, vindoline was efficiently extracted from rosy periwinkle (*Catharanthus roseus*) using SFE with 3% methanol as a co-solvent (Song et al., 1992); flavanones and xanthenes were extracted more efficiently from Osage orange (*Maclura pomifera*) using 20% methanol rather than  $\text{CO}_2$  alone (da Costa et al., 1999); and the polyphenolics catechin and epicatechin were isolated from grape seeds using 40% methanol (Ashraf-Khorassani and Taylor, 2004).

### 8.3.7 Case Studies: Purification of Crude Extracts from Plant Tissues

#### 8.3.7.1 Purification of Crude Extracts Containing Taxol®

One application that we employed is for the analysis of **Taxol**. Taxol is a unique taxane diterpene amide that possesses antitumor and antileukemic properties. Kilograms of this cancer chemotherapeutic agent are needed for the clinical treatment of patients who have breast cancer; however, Taxol exists in only minute quantities — 0.01% of the inner bark and needles of yew (*Taxus*) species. Until recently, Taxol could not be synthesized, and the most economical source of Taxol was from the Pacific yew (*Taxus*

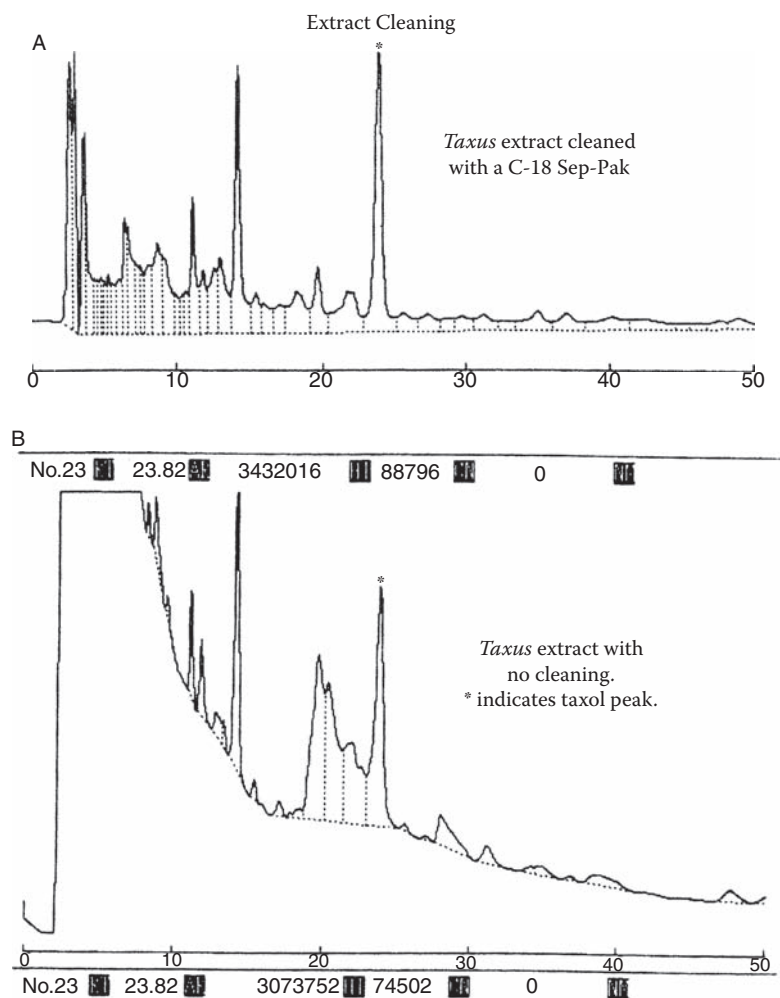

**FIGURE 8.6** Leland Cseke is shown with the C18 Sep-Pak™ column (lower center) used in our laboratory to partially purify yew (*Taxus* spp.) plant extracts in preparation for high-performance liquid chromatography analysis of taxane-type diterpenes found in these plants.

*brevifolia*). For this reason, large areas of Pacific yew forests in the Pacific Northwest of the United States were destroyed in order to obtain this anticancer drug. The Taxol extraction methods used by researchers commonly involve complicated partitioning methods in which the plant is first extracted with methanol and H<sub>2</sub>O and then partitioned using methylene chloride to remove chlorophyll and other unwanted compounds. In the process, Taxol molecules move from the aqueous methanol to the more hydrophobic methylene chloride. Unfortunately, methylene chloride is a suspected carcinogen, and it seems counterproductive, in our opinion, to extract a cancer chemotherapeutic with a substance that could cause cancer. At least it needs to be monitored carefully and with caution and should, therefore, be used only in very well-vented rooms, best in a fume hood. Hence, it was our motive in studying Taxol to find a cheap, efficient, and easy way to separate Taxol from the thousands of other organic compounds in yew tissues. One of the primary difficulties, in this case, is the removal of chlorophylls from methanolic extracts. Chlorophylls absorb at the same wavelength as Taxol and often occur in such large quantities that their resulting peaks interfere with taxane peaks. For this purpose, we use a C18 reverse-phase Sep-Pak™ column (Waters Corporation, Milford, MA). The protocol for doing this follows. Figure 8.6 shows the small size of the C18 Sep-Pak setup as used in our laboratory. However, Sep-Pak columns are also available in 96-well formats. HPLC results using C18 Sep-Pak cleaning versus no cleaning are shown in Figure 8.7A and Figure 8.7B, respectively.

A new, simple, and rapid method that successfully works for extraction and HPLC separation of Taxol from **crude extracts** of *Taxus cuspidata* (Japanese yew) needles and stems was developed in our laboratory and tested by ten groups independently with repeated success. It requires 2 h to perform steps 1 through 21 and 70 min per sample to run them in an automated Shimadzu HPLC apparatus. This long run time is used to separate the multitude of peaks that result at 228 nm spectrophotometric monitoring when not using the C18 Sep-Pak cleanup method. The advantage of not using cleanup procedures is that the researcher saves time in preparing extracts.

In some analytical situations, or for cases where publication is desired, it may be necessary to clean the crude extract with a C18 Sep-Pak column. The cleanup procedure is given following the crude extraction protocol described below (*Note*: This is by no means the only cleanup procedure for extracts. Any form of chromatography can be used to clean up the extracts [see discussion of chromatographic methods].) The basic trick is to find the fraction eluted from the cleanup column that contains the compound of interest. In the case of Taxol, this was accomplished experimentally by using purified Taxol standards dissolved in 10% methanol in ddH<sub>2</sub>O (distilled and deionized water). At this concentration of methanol, it was found that Taxol binds to the C18 packing material in the column. Then, the concentration of methanol was arbitrarily increased in several steps up to 100% methanol. A fraction of eluted mobile phase (2 to 3 ml) was collected at each concentration increase, and HPLC was performed



**FIGURE 8.7** High-performance liquid chromatography taxane analysis results showing chart recordings resulting from C18 Sep-Pak™ cleaning (A) versus no cleaning (B) of extracts from yew (*Taxus* spp.) needles and stems.

on each fraction to determine where Taxol had eluted off the column in comparison to the retention time of Taxol standard samples. After repeated experiments, it was found that while the Taxol is able to bind to the C18 column in 10% methanol in ddH<sub>2</sub>O, it loses affinity for the column at 65% methanol in ddH<sub>2</sub>O. This allowed for the creation of the cleanup method described below.

In some cases, chromatography is not necessary for cleanup of the sample. The addition of adsorptive particles, such as activated charcoal, to the crude extracts followed by filtration may be all that is necessary to remove unwanted compounds.

#### *Taxol Extraction from Fresh Taxus (Yew) spp. Tissue Resulting in Crude Extract Samples That Can Be Used for HPLC*

1. Obtain *Taxus* spp. plant specimens.
2. For each sample, weigh out 0.5 g of needles + 0.5 g of stems.
3. Grind to a fine powder using liquid N<sub>2</sub> in a mortar and pestle.
4. Let powder warm to room temperature.
5. Add 1 ml of 100% MeOH, and grind vigorously.



6. Transfer this slurry to a 15 ml Corex centrifuge tube.
7. Add 2 ml of 100% MeOH, and grind the remaining plant material in the mortar.
8. Add this to the tube, and label.
9. Add another 1 ml of 100% MeOH to the mortar, and rinse again.
10. Add this to the tube, and label.
11. Stopper the tube, and vortex or shake for 10 min.
12. Cool at  $-80^{\circ}\text{C}$  for 10 min.
13. Balance the tubes by adding 100% MeOH to the lighter tube.
14. Centrifuge at 12,000 rpm for 15 min.
15. Take off the supernatant, and place in a clean, acid-washed tube using a Pasteur pipette; then label.
16. Put this tube into a water bath at  $55^{\circ}\text{C}$ .
17. Blow  $\text{N}_2$  gas gently into the tubes until the samples are completely dry.
18. Add 0.5 ml of ice-cold HPLC grade 100% MeOH, and vortex for several minutes with periodic placement in an ice bath. This allows one to later quantify the amount of taxol extracted, because a known volume of sample has been created.
19. When the MeOH is very cold, place the 0.5 ml into a syringe, and filter through a  $0.2\ \mu\text{m}$  filter into an HPLC bottle.
20. Add an aluminum septum to the top of the bottle, and cap.
21. Seal the tube to prevent evaporation, and then label.
22. Inject the sample into HPLC and run through the Curosil G column (from Phenomenex, Torrance, CA), collecting data at 228 nm. Run each sample for 70 min at  $1\ \text{ml}\cdot\text{min}^{-1}$  in 36.5% acetonitrile + 63.5% 10 mM ammonium acetate at pH 4. Figure 8.7B shows a typical chromatogram using this procedure.
23. Use purified Taxol to make several known concentrations of Taxol. Run these standards on HPLC as in step 22 to make a standard curve.
24. Compare your data to the standard curve for Taxol, and calculate the percent of Taxol per unit (gram) of fresh weight of tissue.

*Taxol Extraction from Fresh Taxus (Yew) spp. Tissue Resulting in Cleaned Extracts That Can Be Used for HPLC — Use of the C18 Sep-Pak Column*

1. Obtain *Taxus* spp. plant specimens.
2. Weigh out 0.5 g of needles + 0.5 g of stems.
3. Grind to a fine powder using liquid  $\text{N}_2$  in a mortar and pestle.
4. Let powder warm to room temperature.
5. Add 1 ml of 100% MeOH, and grind vigorously.
6. Transfer this slurry to a 15 ml Corex centrifuge tube.
7. Add 2 ml of 100% MeOH, and grind the remaining plant material in the mortar.
8. Add this to the tube, and label.
9. Add another 1 ml of 100% MeOH to the mortar, and rinse again.
10. Add this to the tube, and label.
11. Stopper the tube, and vortex or shake for 10 min.
12. Cool at  $-80^{\circ}\text{C}$  for 10 min.
13. Balance the tubes by adding more 100% MeOH to the lighter tube.
14. Centrifuge at 12,000 rpm for 15 min.
15. Take off the supernatant, and place in a clean, acid-washed tube using a Pasteur pipette; then label.
16. Dilute the volume of MeOH supernatant tenfold with  $\text{ddH}_2\text{O}$  to produce a 10% MeOH sample.

17. Run this entire diluted sample through a C18 Sep-Pak column (activated as per instruction from supplier). Taxol-type molecules will bind to the column at this concentration of MeOH.
18. In the case of Taxol, wash the column first with 3 ml of 35% MeOH, then with 3 ml of 55% MeOH. This washes compounds that have less affinity for the C18 adsorbent than Taxol out of the column, while the Taxol remains bound.
19. Now wash the C18 column with 2 ml of 65% MeOH, and collect the sample. All taxane species of compounds (including Taxol, 7-epi-Taxol, 7-epi-10 deacetyl Taxol, and cephalomanine) are released from the column during this elevation in MeOH concentration, leaving almost all of the problematic chlorophyll still bound to the column adsorbent phase.
20. The 2 ml of Taxol-containing sample is completely dried under a stream of N<sub>2</sub> gas in a 55°C water bath, while the C18 column is cleaned with 100% MeOH and reused. (*Note*: No detectable amount of Taxol is lost during this procedure.)
21. Add 0.5 ml of ice-cold HPLC grade 100% MeOH, and vortex for several minutes with periodic placement in an ice bath.
22. When the MeOH is very cool, place the 0.5 ml into a syringe, and filter through a 0.2 µm filter into an HPLC bottle.
23. Add an aluminum septum to the top of the bottle, and cap.
24. Seal the tube to prevent evaporation; then label.
25. Inject the sample into HPLC and run through a Curosil G column (from Phenomenex). Collect data at 228 nm. Run each sample for 30 min at 1 ml·min<sup>-1</sup> in 40% acetonitrile + 60% 10 mM ammonium acetate at pH 4. Figure 8.7A shows a typical chromatogram using this procedure. Note the dramatic deduction of the chlorophyll peak as compared to Figure 8.7B.
26. Use purified Taxol to make several known concentrations of Taxol. Run these standards on HPLC as in step 22 to make a standard curve.
27. Compare your data to the standard curve for Taxol, and calculate the percent of Taxol per unit (gram) of fresh weight of tissue.

*Note*: The run time can be reduced to as little as 10 min by increasing the percentage of acetonitrile. The Taxol peak is still clearly resolved in this case.

### 8.3.7.2 Extraction of Cuticular Wax from Needles of Yew (*Taxus*) Plants

Waxes are lipids synthesized by plants and animals, and they function to keep out infectious organisms (e.g., ear wax in animals), to prevent desiccation, and to serve as a barrier against fungal and bacterial pathogens in plants. In yew plants (*Taxus* spp.), waxes are synthesized in increased amounts in response to stresses, such as hypergravity. The protocol we successfully used to quantitatively analyze cuticular waxes from *Taxus* needles is listed. This procedure should be adaptable for any species of plant or animal.

1. Weigh out 1.0 g of *Taxus* needles.
2. Dice needles with a razor blade, and place in a mortar and pestle.
3. Add 2:1 mixture of methanol/chloroform to the mortar, and grind thoroughly.
4. Transfer the resulting slurry to a centrifuge tube, and centrifuge at 12,000 rpm for 15 min.
5. Remove the supernatant, and place it in a separate collection flask. This supernatant contains the lipids from the *Taxus* needles.
6. Place the pellet back into a mortar and pestle.
7. Add a 2:1:0.8 mixture of methanol/chloroform/water, and grind thoroughly.
8. Centrifuge this slurry at 12,000 rpm for 15 min.
9. Transfer the supernatant to the above collection flask.
10. Regrind the pellet from the centrifuge tube using the original 2:1 mixture of methanol/chloroform mixture, and repeat steps 8 and 9.

11. While collecting the rinse liquid, vacuum filter the pellet, rinsing with 100% chloroform.
12. Transfer this rinse liquid to the collection flask.
13. Transfer all of the collected liquid to a separatory funnel, and add a 1:1 mixture of chloroform/water. This will produce two phases. The lower phase will contain the dissolved lipid.
14. Empty the bottom layer of chloroform from the separatory funnel, and dry it over solid sodium acetate. This absorbs water from the sample.
15. Weigh a clean rotary evaporator flask (round-bottom flask), and record the weight.
16. Pipette the chloroform solution into the rotary evaporator flask.
17. Vacuum filter the sodium acetate solid, rinsing with chloroform. Add the collected rinse liquid to the rotary evaporator flask.
18. Evaporate the chloroform using a rotary evaporator until the sample is completely dry.
19. Weigh the rotary evaporator flask with the sample, and subtract the recorded initial weight for the empty flask. This will give the amount of cuticular wax from the original sample of *Taxus* needles.

### 8.3.7.3 Extraction of Proanthocyanidins and Flavonoids in Leaves of Hawthorn

As an example of an extraction method suitable for HPLC analysis of small molecules, we focus on hawthorn (*Crataegus* spp.). The leaves, flowers, and berries of *C. laevigata* and *C. monogyna* were used to make herbal preparations to treat patients with severe heart disease in order to improve coronary circulation, to strengthen heart muscle, and to help stabilize blood pressure as cardiac function improves. The active metabolites in such hawthorn preparations are proanthocyanidins and flavonoids. At the University of Michigan Integrative Medicine Center (MIM), we developed new methods for extraction and HPLC analysis of proanthocyanidins and flavonoids in hawthorn (*C. laevigata* and *C. monogyna*) leaf samples. The extraction protocol is as follows:

1. Freeze-dry leaves (ca. 15 g fresh weight) using a lyophilizer/freezer for 48 h.
2. Prepare a powder of dried hawthorn leaves (ca. 1 g dry wt.) using a clean mortar and pestle.
3. Prepare extract of 0.5 g of the powder in 15 ml Pyrex tubes with screw caps, using 10 ml dichloromethane (using plastic gloves to avoid contact with this solvent). Place on shaker set at 150 rpm in an incubator set at 50°C overnight. This step is performed in order to remove lipids and chlorophylls.
4. Pour off the dichloromethane, and now extract the residue in the tubes with 10 ml of 70% methanol, again doing this at 50°C on a shaker set at 150 rpm overnight.
5. Remove the methanol by air drying overnight in a fume hood. For this purpose, we use a glass manifold with Pasteur pipettes attached to blow off the methanol with gentle air pressure applied to each tube.
6. Separate the remaining water layer from the precipitate by centrifugation at  $10,000 \times g$  for 10 min.
7. Continue extraction of the precipitates two times with 5 ml aliquots of diethyl ether per tube in the fume hood. Diethyl ether is a more polar solvent than the above ones, so extraction of the more polar compounds of interest should be enhanced.
8. Separate the pooled diethyl ether extracts into precipitates by centrifugation at  $10,000 \times g$  for 10 min and dry under reduced pressure to obtain the residues. Use a vacuum centrifuge for this purpose.
9. Continue extractions of precipitates with 10 ml ethyl acetate per tube on a shaker at room temperature.
10. Remove the ethyl acetate extracts separate from the precipitates under reduced pressure to obtain residues.
11. Dissolve the remaining water layer from step 6 in 6 ml distilled water, adjust the pH to 5.4 with 0-phosphoric acid, and incubate with 0.1 ml distilled water containing  $\beta$ -glucosidase

(Sigma-Aldrich, St. Louis, MO) at 0.1 mg of the enzyme per 0.1 ml water. The mixture is incubated for 1 h in a water bath set at 35°C in order to release flavonoids from sugar conjugates. The mixture is then combined with 10 ml of 100% methanol so as to dissolve the flavonoids more effectively.

12. Repeatedly mix and then place on a shaker at 150 rpm for 60 to 90 min in an incubator set at 60°C. The mixture is then centrifuged in a swinging bucket rotor at  $2000 \times g$  for 2 min.
13. The supernatant is now evaporated using a Büchi or other flash evaporator.
14. The residues from steps 8, 10, and 11 are now combined and dissolved in 10 ml of 80% methanol.
15. After filtration through a 0.22  $\mu\text{m}$  filter, the extracts are ready to analyze by HPLC.
16. For HPLC analysis, we use the following conditions: a Phenomenex Luna column (5  $\mu\text{m}$  pore size, C18, 150 mm  $\times$  4.60 mm), flow rate of 1 ml/min, solvent A = water + 0.1% TFA, solvent B = acetonitrile + 0.1% TFA, HPLC running conditions = a gradient of 5% B to 100% B during a 30 min period, oven temperature = 40°C, and detector set at a wavelength of 280 nm.

#### 8.3.7.4 Extraction of Proteins from Fresh Plant Tissues

As described previously, proteins play an enormous variety of roles within all tissues of plants (see Chapters 1 and 2). Some carry out the transport and storage of small molecules, while others make up a large part of the structural framework of cells and tissues. **Enzymes** are the protein catalysts that promote the enormous variety of reactions that channel metabolism into essential pathways. Therefore, like the smaller molecules described above, extraction methods for proteins are important as well. Individual types of cells may contain several thousand kinds of proteins; therefore, most protein extracts will initially result in a **crude extract** containing not only the protein of interest but also a collection of many “unwanted” compounds. Such crude extracts require additional chromatographic separations to clean up the protein of interest. The following example is a common method for preparing protein-containing crude extracts. Section 8.4.6.1 goes on to give an example of the purification of such crude extracts using a common type of ion-exchange chromatography.

1. Prepare appropriate extraction buffer solutions, and place in ice water for at least 1 h prior to use. The type of buffer varies with the particular protein of interest. The commonly used homogenizing buffers are sodium phosphate, Tris, *tris*-sucrose, and phosphate-buffered saline (PBS). As an example, a buffer containing 50 mM Tris, 5 mM sodium bisulfite, 10% glycerol, 1% insoluble PVPP, and 10 mM DTT can extract active terpenoid synthase enzymes (Dudareva et al., 1996).
2. Rinse the tissue (10 to 50 g per extraction) three times with an appropriate homogenizing buffer to wash away traces of soil or extracellular materials.
3. Chop the washed tissue into small pieces (~5 mm) with a clean razor blade or equivalent knife.
4. Transfer the chopped tissues into a homogenization jar or a standard blender, and add four to five volumes of ice-cold homogenizing buffer.
5. Homogenize the tissue to a fine homogenate, being careful to keep the contents cold to prevent degradation of the proteins. If using a power-driven Glass-Teflon homogenizer, set the speed between 500 and 1500 rpm, and pass the homogenizer through the sample four to six times at 5 to 10 sec per stroke. If using a blender or a polytron, homogenize the tissue at top speed for 1.5 to 2 min, pausing for 4 sec between each pulse of 20 sec. If using a hand homogenizer, pass the sample through 10 to 20 times until a fine homogenate is obtained.
6. Quickly filter the homogenate through four layers of cheesecloth into a beaker on ice.
7. Save the filtrate, and directly use it for total soluble protein characterization. Residues filtered from plant tissue can also be used for cell-wall-bound or membrane-bound (insoluble) protein extraction.
8. The extraction and purification of cell-wall-bound or membrane proteins usually requires detergents. **Detergents** are amphipathic molecules consisting of a **hydrophobic** (“water-

hating”) portion of a linear or branched hydrocarbon “tail” and a **hydrophilic** (“water-loving”) “head.” They can form **micelles** with the hydrophilic head portions facing outward. Such insoluble proteins are extracted by solubilizing them in the same extraction buffer used above with the addition of 1 to 2% detergent. The common detergents used for protein extraction and purification are as follows:

- a. **Ionic detergents:** These detergents contain charged head groups (+/) and serve to denature proteins in molecular-size separations. For example, **sodium dodecyl sulfate (SDS)** can denature proteins into their monomeric moieties and make proteins negatively charged. These properties can then be separated, based on their molecular weights (MWs), by sodium dodecyl sulfate polyacrylamide gel electrophoresis (SDS-PAGE; see Section 8.5.3.1).
- b. **Nonionic detergents:** These compounds have uncharged hydrophilic head groups and are less likely to disrupt protein–protein interactions. They are less denaturing in action than ionic detergents and may cause proteins to aggregate. Common nonionic detergents include **Triton X-100, Triton X-114, Nonidet P-40, octylglucoside**, and Tween-20. These are used to block nonspecific protein interactions in solid-phase immunochemistry and other molecular biology procedures (see Chapter 5).

---

## 8.4 Analytical and Preparative Chromatography Protocols

### 8.4.1 An Overview

**Chromatography** is one of the most useful means of separating mixtures of compounds, as a technique to both purify the components and identify them. In chromatography, the mixture is separated by differential distribution of the components between a stationary phase and a mobile phase. Primary methods of chromatography in isolation and analysis of natural products include the following: **thin-layer chromatography (TLC)**, **liquid column chromatography (LC)**, **gas chromatography (GC)** (Figures 8.8A–C), **high-performance liquid chromatography (HPLC)**, **fast protein liquid chromatography (FPLC)**, immobilized metal-ion affinity chromatography, and antibody affinity chromatography (Bruno, 1991; Heftmann 1992a, 1992b; Poole and Poole, 1991; Porath, 1988).

There are probably five major separation **mechanisms of chromatography**. They include adsorption chromatography, gas chromatography, liquid–liquid partition chromatography, ion-exchange chromatography, and size-exclusion chromatography.

**Gas chromatography** is a chromatographic technique that can be used to separate volatile organic compounds. A **gas chromatograph** consists of a gaseous mobile phase, an injection port, a separation column containing the stationary phase, and a detector. The organic compounds are separated due to differences in their partitioning behavior between the mobile gas phase and the stationary liquid phase in the column. The volatilities of the compounds, which strongly correlate to their boiling points, is mostly responsible for the partitioning between the liquid phase and the gas phase.

**Liquid–liquid partition chromatography** is based on the different solubilities of compounds in two liquid phases. Here, the stationary phase and the mobile phases are liquids. The oldest known method of liquid–liquid partition chromatography is paper chromatography. More recent implementations are droplet **countercurrent chromatography (DCCC)**, **centrifugal droplet countercurrent chromatography (CPC)**, **high-speed countercurrent chromatography (HSCCC)**, and **elution extrusion countercurrent chromatography (EECCC)**. While paper chromatography is widely used in analytical separations, the other methods are often used for preparative purposes.

In **ion-exchange chromatography**, separation is based on ionic interactions of the individual components of a mixture with a stationary phase that is an ionically charged surface of opposite charge to the sample ions. The mobile phase is an aqueous buffer, where both pH and ionic strength are used to control elution time. The stronger the charge on the sample, the stronger it will be attracted to the ionic surface, and thus, the longer it will take to elute it from the column. Typical applications in natural products chemistry are in the separation of fruit acids.

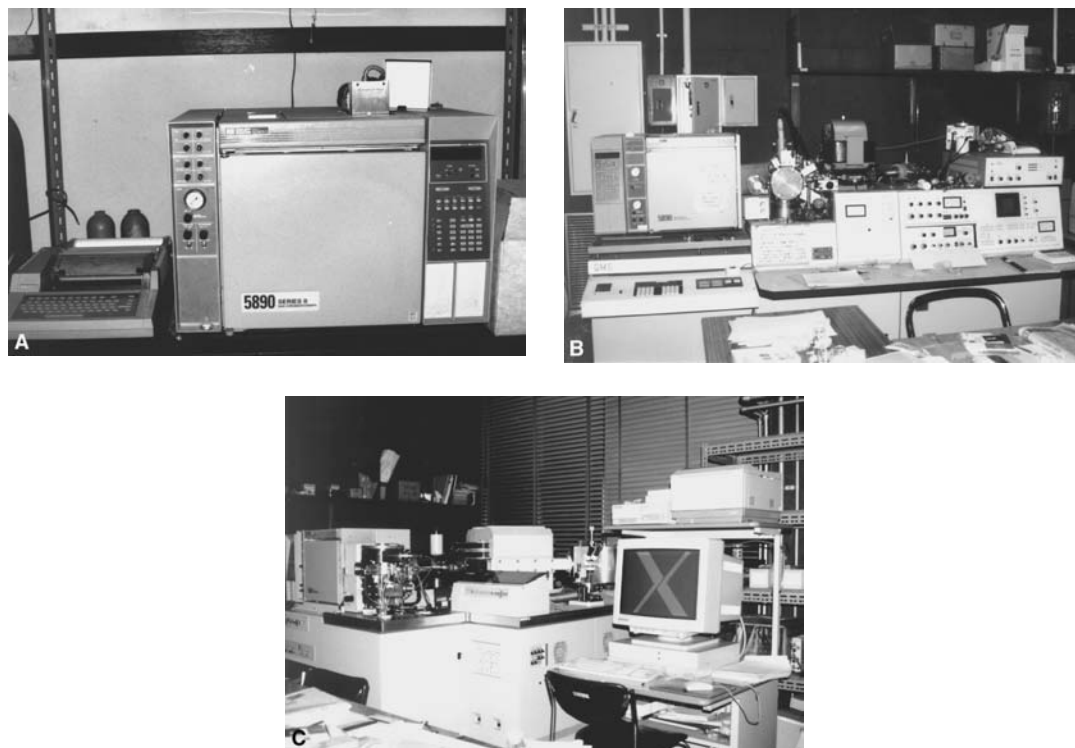

**FIGURE 8.8** (A) Small table-model gas chromatograph (GC) in Dr. Akira Okubo's laboratory at the University of Tokyo. (B) Hitachi gas chromatograph (GC)/mass spectrometer (MS) in Dr. Akira Okubo's laboratory at the University of Tokyo. (C) JEOL gas chromatograph (GC)/mass spectrometer (MS) in Dr. Akira Okubo's laboratory at the University of Tokyo.

In **size-exclusion chromatography**, the separation of mixtures is based strictly upon size. The column is filled with material that has precisely controlled pore sizes, and the sample is simply screened or filtered according to its solvated molecular size. Because larger molecules cannot get into the small pores of the packing material, they are rapidly washed through the column. Smaller molecules, however, penetrate inside the porous packing particles, which leads to a longer path through the column, and as a result, makes them elute later. Typical applications for size-exclusion chromatography are separations of biomacromolecules, such as proteins.

The first type of chromatography, **adsorption chromatography**, can be further subdivided into **normal-phase chromatography** and **reversed-phase chromatography**. In normal-phase chromatography, the stationary phase is of a polar nature (hydrophilic), typically silica, and the solvent is of an unpolar nature (hydrophobic). In order to achieve separation, the polarity of the solvent is adjusted to the polarity of the mixture. It ranges from unpolar hexanes to very polar methanol or even water. Polar samples are retained on the polar surface of the column packing longer than less-polar materials. On the other hand, reversed-phase chromatography consists of modified silica surfaces, such that the nature of the stationary phase becomes unpolar. The mobile phase is a polar solvent, such as water–methanol mixtures or water–acetonitrile mixtures.

The separation process in adsorption chromatography is typically accomplished by probing the various functional groups in the molecules to be separated. An exemplary case could be a very polar and hydrophilic carboxylic acid function attached to a long alkane chain that is hydrophobic. Attempts to separate molecules of various chain lengths and complexity should then focus on the hydrophobic part. For the separation process, these different types of behavior compete. To resolve variations in different molecules, a delicate balance between those different effects, hydrophobic versus hydrophilic interaction, is needed. Because we can vary only the mobile phase during a separation, after choosing a stationary phase, we have to accomplish minute variations by choosing proper solvent systems. As a result, we

often end up with fairly complex mobile phases that address different parts of our molecules. In many cases, however, we have no prior knowledge of these different groups, either because we do not know exact structures or because we do not know exact composition of the mixture, and we are left with simple trial-and-error attempts based on our experience with a specific group of plants or plant constituents.

## 8.4.2 Adsorption Chromatography

In **adsorption chromatography**, finely divided inert adsorbent materials (e.g., silica gel or alumina) serve as the stationary phase, and organic solvents serve as the mobile phase. Separation of the mixture, then, is achieved by differences in polarity of the individual components. Depending on the pore size of the material, different techniques can be used to achieve separations.

### 8.4.2.1 Thin-Layer Chromatography (TLC)

In **thin-layer chromatography (TLC)**, the adsorbent is coated on one side of a plate of glass or a strip of plastic or aluminum. Common adsorbents are **silica gel** and **alumina**. A few microliters of a solution of the sample to be analyzed are spotted onto the plate as a single small dot near one end of the plate using a microcapillary tube. The plate is developed by placing it in a jar or developing chamber that contains a small amount of solvent (see Figure 8.9). The solvent rises up to the plate by capillary action, carrying the components of the sample with it. The different compounds are separated based upon their interaction with the adsorbent coating.

Commercially available TLC plates, 60 Å silica gel, 250 µm layer thickness, on either polyester or aluminum backing, either with or without a fluorescent indicator (e.g., Whatman® flexible-backed TLC plates), are suitable for the rapid analysis of crude plant extracts and for following the progress of preparative separations. These commercial plates can be cut with scissors or a paper cutter to the desired size. Samples are commonly applied with fine capillaries prepared from melting-point capillary tubes. Development of analytical TLC plates can be carried out either in wide-mouth round jars or rectangular TLC developing chambers. The detection of spots is generally achieved using an ultraviolet (UV) lamp (if the TLC plates have the fluorescent indicator) or iodine vapor. The detection of components of TLC plates may also be accomplished by spraying the plates with a suitable reagent (e.g., chromic acid solution or 2,4-dinitrophenylhydrazine reagent).

Preparative TLC plates, also commercially available (e.g., Sorbent Technologies, 20 cm × 20 cm, glass-backed, 60 Å silica gel, 1000 µm layer thickness, with fluorescent indicator), were used for preparative separations. The sample is applied as a line rather than a spot onto the bottom of the plate with a capillary, and the plates are developed in a solvent chamber (Figure 8.10A). Visualization of the



FIGURE 8.9 Common thin-layer chromatography developing chambers.

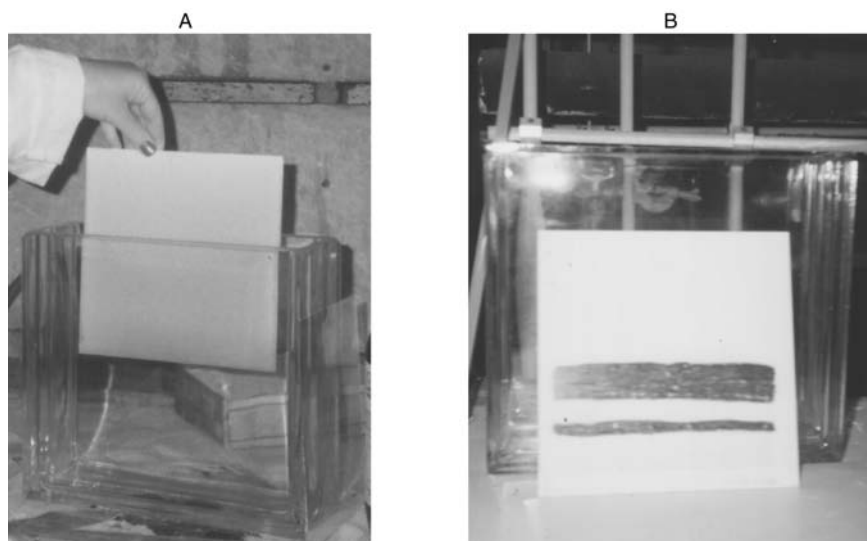

**FIGURE 8.10** Preparative thin-layer chromatography. (A) Development of thin-layer chromatography plate. (B) Desired bands are scraped off.

components is carried out using a UV lamp. The desired components are scraped off of the glass with a razor blade (Figure 8.10B). The compound is separated from the adsorbent by dissolving with an appropriate solvent and filtering from the silica gel.

Analytical as well as preparative TLC is performed by first spotting the mixture under study onto a dry TLC plate. This task is best performed by adding small amounts of sample at a time, such that only a small area of the TLC plate is covered with the mixture. In the case of comparative studies of several mixtures, or mixtures with reference compounds, care has to be taken that all mixture spots are lined up parallel to the edge of the plate.

The mobile phase should be placed into the developing chamber prior to the separation. The chamber should have a lid that closes tightly enough to keep a constant gas pressure in the chamber. Essential for good and reproducible separations is that the solvent system be allowed to equilibrate with its vapor phase. Chamber walls are often covered with filter-type paper to ensure the evaporation of the solvent and a fast equilibrium. The depth of the solvent should be less than the distance of the sample spots from the bottom of the plates.

Finally, the plate is placed in the chamber and allowed to develop. Capillary forces will move the mobile phase into the TLC plate. On their way through the TLC plate, they move the different molecules at different distances through the plate. Development should be stopped before the solvent front reaches the other end of the plate. The exact end-point of the solvent front should be marked.

More sophisticated TLC-based separation methods are the Chromatotron<sup>®</sup> (Harrison Research, Inc., Palo Alto, CA), or CycloGraph<sup>®</sup> system (Analtech, Newark, DE) (see Figure 8.11). These systems are

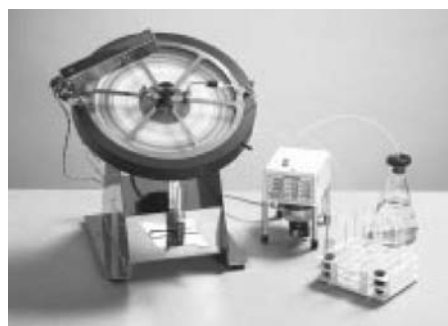

**FIGURE 8.11** Analtech's CycloGraph<sup>®</sup> system.



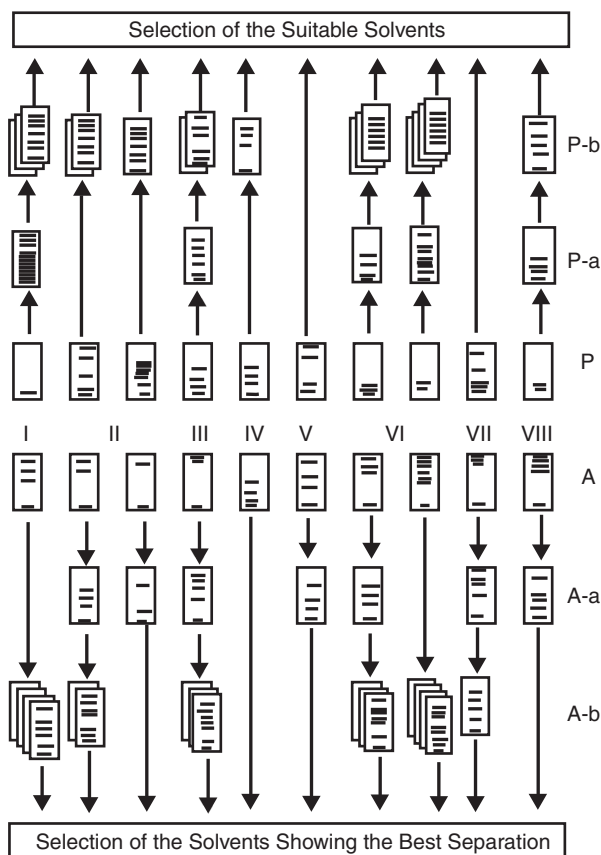

FIGURE 8.12 Thin-layer chromatography evaluation of the best-suited solvents.

centrifugally accelerated devices for performing preparative chromatographic separations. They combine the advantages of preparative TLC and column chromatography and deliver fast, efficient separations.

In order to perform analytical TLC, different solvent systems are used depending on which types of compounds are analyzed (Table 8.1).

These solvent systems are just first entries to achieve separation. Another approach to finding optimal conditions includes techniques such as *PRISMA* to evaluate the best combinations of solvents (Nyiredy et al., 1985a, 1985b) in a systematic fashion. In the *PRISMA* model, originally developed for normal-phase applications, all available solvents are grouped into eight main groups depending on their selectivity. Solvents from all eight groups are then systematically evaluated, and if necessary, the polarity is adjusted with *n*-hexane so that the  $R_f$  values of the separated compounds fall into a range of 0.2 to 0.8 (see Figure 8.12). The combination of a maximum of three of the best-suited solvents into the *PRISMA* model (see Figure 8.13) then typically gives an optimum result. This systematic way of evaluation overcomes the problem that in many cases nothing is known about the nature of the compounds to be separated (Table 8.2).

**TABLE 8.1**Solvent Systems for Thin-Layer Chromatography

---

*Steroids*

Benzene or benzene-ethyl acetate (9:1 or 8:2)  
Chloroform-ethanol (96:4), alumina  
Ethyl acetate-cyclohexane (x:y)  
Benzene-isopropanol  
Methanol-water (95:5)  
Cyclohexane-heptane (1:1)  
Cyclohexane-ethyl acetate (9:1)  
Benzene-chloroform (9:1)  
Benzene-methanol

*Terpenoids*

Hexane or hexane-ethyl acetate (85:15)  
Benzene or benzene-petroleum ether or benzene-ethanol  
Isopropyl ether or isopropyl ether-acetone (5:2 or 19:1)

*Essential Oils*

Benzene-chloroform  
Petroleum ether

*Cardenoloids*

Chloroform-pyridine (6:1)

*Fatty Acids*

Petroleum ether-isopropyl ether-acetic acid (70:30:1)  
Chloroform-petroleum ether

*Vitamins*

Methanol-carbon tetrachloride-xylene, chloroform (alumina)  
Chloroform-petroleum ether  
Methanol, propanol, or chloroform  
Acetone-hexane (9:1)

*Alkaloids*

Chloroform or ethanol or hexane-chloroform (3:7) + 0.05% diethylamine (alumina)  
Benzene-ethanol (9:1)  
Chloroform-acetone-diethylamine (5:4:1)

*Flavonoids and Coumarins*

Petroleum ether-ethyl acetate (2:1)  
Methanol-water (8:2 or 6:4) (polycaprolactam)  
Toluene-ethyl formate-formic acid (5:4:1)

---

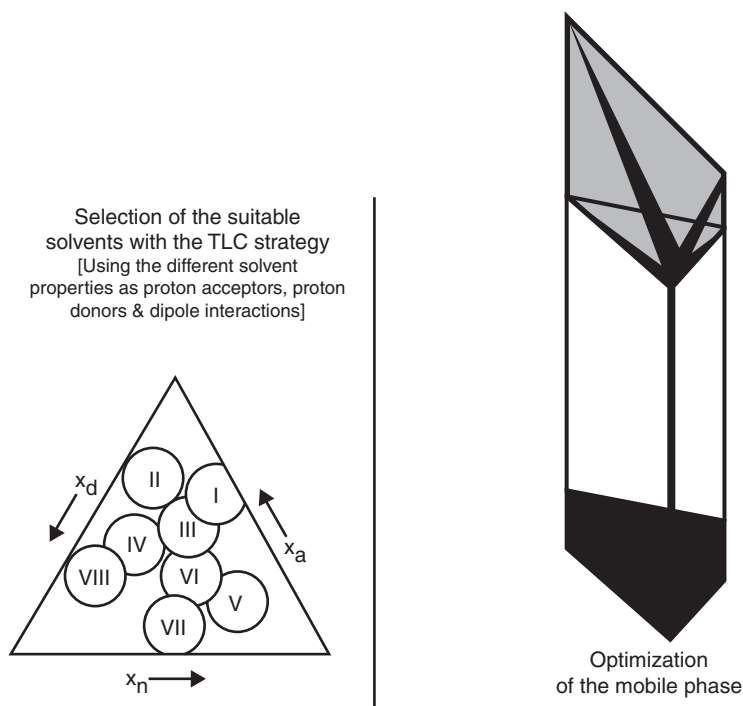

**FIGURE 8.13** A PRISMA model is constructed based on the different solvent properties (proton acceptors,  $x_a$ ; proton donors,  $x_d$ ; and dipole interactions,  $x_n$ ). Modifiers such as water and hexane are used to construct the final PRISMA.

**TABLE 8.2**

Solvent Groups for the PRISMA Model

I	<i>n</i> -Butyl ether, diisopropyl ether, methyl <i>t</i> -butyl ether, diethyl ether
II	<i>n</i> -Butanol, isopropanol, <i>n</i> -propanol, ethanol, methanol
III	Tetrahydrofuran, pyridine, methoxyethanol, dimethylformamide
IV	Acetic acid, formamide
V	Dichloromethane, 1,2-dichloroethane
VI	Ethyl acetate, methyl ethyl ketone, dioxane, acetone, acetonitrile
VII	Toluene, benzene, nitrobenzene
VIII	Chloroform, dodecafluoroheptanol, water

#### 8.4.2.2 Preparative Column Chromatography

**Column chromatography** is most often used for the preparative scale separation of components from a crude plant extract. In practice, a vertical column, usually glass, is packed with a suspension of adsorbent in a nonpolar solvent (e.g., hexane). The crude extract to be separated is added to the top of the column, and a suitable solvent or solvent mixture, which should be as nonpolar as practical, is allowed to flow down through the column, eluting the various components from the bottom of the column. Common adsorbents for column chromatography include aluminum oxide, Florisil® (a magnesium silicate), and silica gel. More recently, Sephadex™ LH-20 (a hydroxypropylated, cross-linked dextran) and bonded-phase silica gel derivatives such as C8 or C18 (for reversed-phase separations) have become popular.

In general, the ratio of mass of adsorbent/mass of extract should be around 40:1, and the ratio of column height/column diameter of the packed column of adsorbent should be around 15:1. For gross preparative separations of multigram quantities of crude plant extracts, we found that columns of silica gel (240 to 400 mesh), 85 cm length × 5 cm diameter, either gravity elution or with slight nitrogen pressure (flash chromatography), eluting with a solvent gradient (e.g., hexane/ethyl acetate or chloroform/methanol) generally produce good results (see case study in Section 8.4.6.2).

### 8.4.2.3 Affinity Chromatography

This is a powerful means of purifying proteins. (See Chapter 1 for details on protein structure and binding characteristics.) The principle of this technique is based on the fact that some proteins have a very high affinity for specific chemical groups (**ligands**) covalently attached to a chromatographic bed material (the **matrix**). After loading and running the protein mixture sample through the column, only those proteins with a high affinity to the ligand can bind to the column matrix. Other proteins, in contrast, run through the column, because they are unable to bind to the ligand. The bound proteins can then be eluted from the column by a solution containing a high concentration of the soluble form of the ligand or, in some cases, by changes in the buffer conditions that cause the bound proteins to change conformation. A number of affinity columns are commercially available, depending on the particular protein purification desired (Bruno, 1991; Heftmann, 1992a). One example is **ConA-Sepharose affinity chromatography** that is specific for glycoprotein purification (Cseke et al., 2004). Another example uses columns with immobilized metal ion covalently linked to the column matrix (Porath, 1988). In this type of method, the proteins with affinity to the metal ion (including the proteins that have a HIS-Tag or a series of six to ten histidine residues) will bind to the column, while other proteins will be washed away.

### 8.4.2.4 High-Performance Liquid Chromatography (HPLC)

**HPLC** typically uses small particle sizes for the stationary phase, which results in a fairly large backpressure when the mobile phase is passed through this bed. As a consequence, the only way to achieve flow of the mobile phase is to use pump systems. The pressure of HPLC typically reaches 150 to 200 bars. In certain cases, larger pressures are unavoidable. Modern instrumentation is able to handle up to 400 bars.

Typically, an HPLC system consists of the following components: solvent reservoir, injection system, column, HPLC pump, detector, sample collector (optional), and a computer serving as a data station for the detector information as well as a way to control and automate the HPLC pump (see Figure 8.14).

More sophisticated instruments consist of two or three pumps as well as a number of detectors to characterize the sample (see Chapter 9). The advantage of having more than one pump is that solvent gradients can be programmed, meaning that the solvent composition can be changed continuously throughout the chromatography. This allows for the separation of a much larger range of compounds because the mobile phase can be adjusted to the changing polarity of the mixture. As an additional benefit, chromatographic peaks get sharper — they elute in a smaller volume from the column — and the separation can be done in a much shorter time period.

Almost every HPLC system is equipped with a UV detector in order to detect compounds of interest. Traditionally, these UV detectors were single-wavelength detectors; however, with cheaper hardware, **photodiode-array (PDA or DAD) detectors** that permit the scanning of the full UV-visible range (210

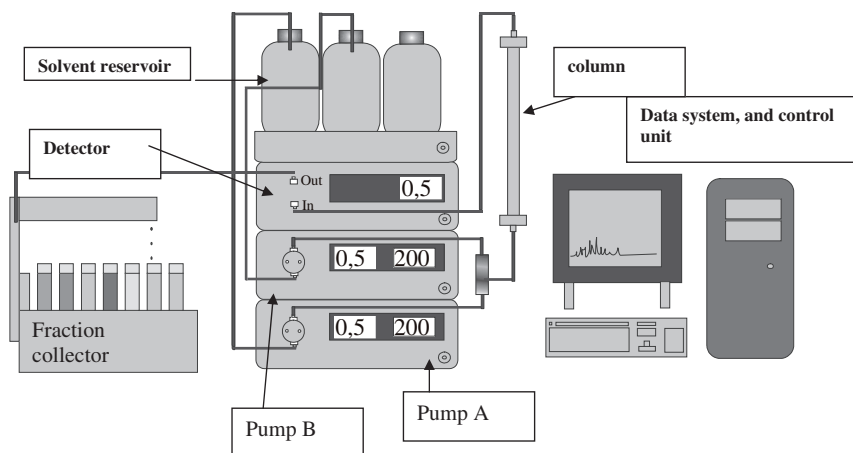

**FIGURE 8.14** High-performance liquid chromatography system consisting of two pumps to allow for gradients, column, detector, and fraction collector.

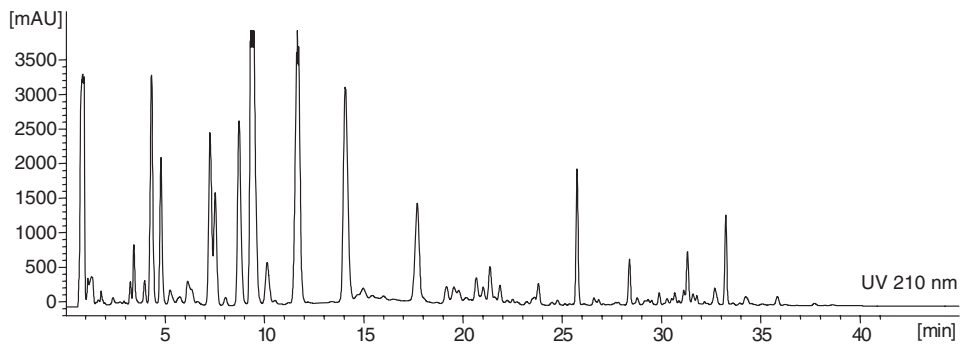

**FIGURE 8.15** *n*-Hexane extract of *Piper longum* detection at 210 nm, acetonitrile/H<sub>2</sub>O, 40 to 50% acetonitrile linear over 15 min, followed by 50 to 95% acetonitrile over 35 min. Column: Merck LiChrospher® 100 RP-18, 5  $\mu$ m. Flow: 0.8 ml·min<sup>-1</sup>.

to 650 nm) are becoming more popular. For the separation of natural products, this is of great advantage because depending on the compounds involved, there can be very large differences in their UV maxima (see Chapter 9 for further discussion).

Natural products, such as sugars, that absorb in the range of the solvent systems are detected using **refractive-index (RI)** detectors or **evaporative light-scattering detectors (ELSDs)**. In addition, MS and NMR (see Chapter 9) can be used to detect compounds. The latter techniques are always used in combination with UV detection.

In most cases, HPLC is implemented as an analytical technique. With either reversed-phase or normal-phase materials, column sizes are typically 25 cm in length and 4.6 mm in diameter. The typical load for an analytical column is well below 1 mg for the overall mixture. However, up to 5 mg of sample are possible in favorable cases. Common flow rates for analytical separations are 1 ml·min<sup>-1</sup>. Semipreparative separations can be achieved using larger columns; here the diameter of the column is increased to 10 mm or more. For a 10 mm column, a maximum load of about 50 mg is possible. Preparative columns go up to 50 mm in diameter, which allows for the separation of a few grams of material. In the case of preparative separations, the larger column diameters require increased flow rates (up to 150 ml·min<sup>-1</sup>), and thus, HPLC pumps with larger pumping capabilities are required.

For normal-phase HPLC, there are a variety of different surface chemistries commercially available. Those most commonly used are silica columns; however, the use of alumina packing or modified silica columns, such as diol, cyano, or amino phases, is possible. The advantage of the modified silica phases is their ability to equilibrate quickly, contrary to silica or alumina phases. With respect to the retention power, the normal-phase materials can be grouped as follows: alumina > silica  $\cong$  amino > diol > cyano.

Examples of successful HPLC separations are shown in Figure 8.15 through Figure 8.17. Additional examples are presented in Chapter 9.

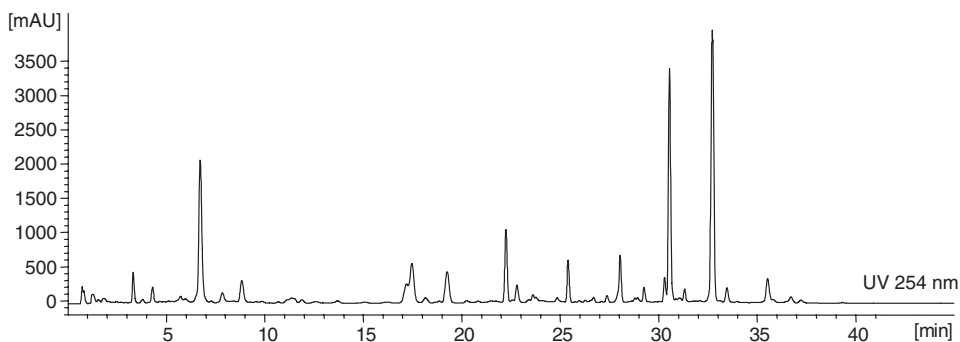

**FIGURE 8.16** *n*-Hexane extract of *Piper hainanense* detection at 254 nm, acetonitrile/H<sub>2</sub>O, 40 to 50% acetonitrile linear over 15 min, followed by 50 to 95% acetonitrile over 35 min. Column: Merck LiChrospher® 100 RP-18, 5  $\mu$ m. Flow: 0.8 ml·min<sup>-1</sup>.

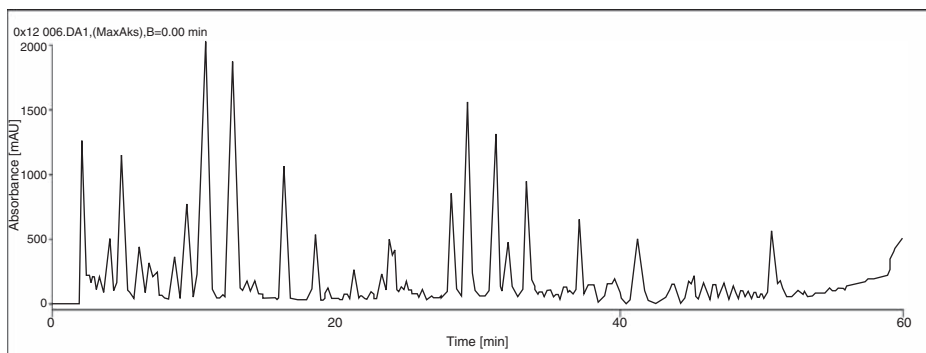

**FIGURE 8.17** Ethanol extract of *Fraxinus pallisiae*, methanol/H<sub>2</sub>O, 15% methanol for 5 min, then 15 to 35% methanol over 35 min, then 35 to 100% methanol over 10 min, detection at 254 nm. Column: YMC 250 mm × 3 mm J-sphere M 80/80 (3 to 4 μm). Flow: 1 ml·min<sup>-1</sup>.

### 8.4.3 Partition Chromatography

**Partition chromatography**, often called **liquid–liquid partition chromatography**, involves two liquid phases. The stationary phase is an adsorbed solvent held on the surface or within the grains or fibers of an inert solid supporting matrix. Examples of inert supports include sheets of paper (cellulose) as used in paper chromatography. The separation of mixtures is based on the partitioning of the individual components between two immiscible liquid phases — the solubility differences of each component in the mobile phase and the stationary phase. In paper chromatography, a thin film of water on the paper constitutes the stationary phase. Early liquid chromatography (LC) stationary phases were coated onto the inert support and packed into a column. The mobile phase was then passed through the column.

#### 8.4.3.1 Paper Chromatography

**Paper chromatography** is usually carried out in a large glass tank or cabinet and involves either ascending or descending flow of the mobile-phase solvents. Descending paper chromatography is faster due to gravity facilitating the flow of solvents. Large sheets of Whatman #1 or #2 filter paper (the latter is thicker) are cut into long strips (e.g., 22 × 56 cm long) for use in descending paper chromatography, or a wide strip of paper (e.g., 25 cm wide) of variable height is used for ascending paper chromatography.

For descending liquid–paper chromatography, substances to be separated are applied as spots (e.g., 25 mm apart) along a horizontal pencil line placed down from the V-trough folded top of the paper. The V-trough folded paper is placed in a glass trough, held down by a glass rod, and when the tank has been equilibrated (vapor-saturated) with “running solvents” (mobile phase), the same solvent is added to the trough via a hole in the lid covering the chromatography tank. The lid is sealed onto the chamber with stopcock grease in order to make the chamber airtight. After the mobile-phase trails to the base of and off the paper sheet, the paper is hung to dry in a fume hood, where it can then be sprayed with reagents (e.g., ninhydrin reagent for amino acids) that give color to the separated compounds of interest in white or UV light. Some compounds of interest have their own distinctive colors (e.g., chlorophylls), and hence, can be purified using this technique. In other cases, the dyes used to stain the location of the compound or protein cause irreversible covalent changes to the compound. In these cases, purification is not possible.

In ascending paper chromatography, the same basic setup and principles apply, with the exception that the mobile phase is placed at the bottom of the tank. Separation is achieved when the mobile phase travels up the paper via capillary action.

#### 8.4.3.2 Countercurrent Chromatography

**Droplet countercurrent chromatography (DCCC)**, **centrifugal droplet countercurrent chromatography (CPC)**, **high-speed countercurrent chromatography (HSCCC)**, and **elution extrusion coun-**

**tercurrent chromatography (EECCC)** are all based on the partitioning of a component in two nonmiscible liquids. These methods are basically an improvement of Craig partitioning and are widely used in natural products research. HSCCC is a liquid–liquid partitioning chromatography method in which the stationary phase is immobilized by a centrifugal force. When the mobile phase is pumped through, sample components are partitioned between the mobile and stationary phases and are separated on the basis of differences in their partition coefficients. Advantages of the technique are that there is no interaction with a solid phase, which typically leads to considerably less degradation of compounds.

A search for these techniques in the *Journal of Chromatography* revealed more than 250 publications that discussed them. A few recent examples from the literature show the application of these techniques (Ito, 2005) to carotenoids (Aman et al., 2005), coumarins (Liu et al., 2005), and sesquiterpenes (Yan et al., 2005), just to name a few.

#### 8.4.4 Gas Chromatography

Gas chromatography was the first commercially available separation technique available. A gas chromatograph consists of an injector system, a column that is placed in a programmable oven, and a detection system.

Currently, the columns most widely used are fused silica columns approximately 30 m in length. They provide excellent stability over a wide temperature range, so that compounds up to molecular weights of approximately 450 amu can be analyzed by GC. The most common detector for GC is the **flame ionization detector**, which provides excellent sensitivity for a wide range of compounds. A more sophisticated detector is a mass selective detector (see Chapter 9).

In natural products, GC instruments are typically used for the evaluation of highly volatile essential oils. Because, in many cases, **retention time** is the only parameter to distinguish individual compounds, and retention time highly depends on the column used as well as the specific temperature program incorporated, methods were developed to compare different analyses. In order to obtain a scaled retention time, a standard sample of a known mixture of hydrocarbons is used to evaluate the combination of temperature program and column characteristics under the exact conditions as the actual plant extract. Using this standard mixture, **retention indices (RIs)** can be calculated, and a comparison of the actual sample with the work done by others is possible based on these RIs.

The influence of changing the temperature program on the essential oil of *Piper umbellatum* is shown in Figure 8.18. On the left panels, we see the hydrocarbon mix; on the right panels, we see the extract of *Piper umbellatum*. The upper panels show use of a fast gradient (50 to 250°C over 25 min); the lower panels show use of a slow gradient (50 to 250°C over 70 min). From Figure 8.18, it is clear that the individual components are better separated with the slower temperature gradient. Furthermore, when inspecting the hydrocarbon mixture, it is apparent that the spacing between the individual components changes, indicating that it is very important to correlate separations under different conditions with standard mixtures.

#### 8.4.5 Size-Exclusion Chromatography

**Size-exclusion chromatography** is also referred to as **gel filtration** or **permeation chromatography** (Bruno, 1991; Heftmann, 1992a). It involves the use of porous gel molecules of agarose, cross-linked dextran, or polymers of acrylamide that allow the separation of compounds based on their molecular sizes. The pore size of the beads determines the molecular size range that can be separated with a particular column. The general rationale for separation is as follows:

1. A gel with an appropriate pore size is chosen in relation to the size of the molecule of interest.
2. Samples are added to the top of the gel column and are washed through using a mobile phase that completely dissolves the molecules of interest.
3. Molecules that are too big to fit in the pores of the solid support will travel straight through the gel, and hence, elute from the column first.
4. Molecules that fit in the pores will penetrate the pores, which results in a longer path and elution at later time points. As a consequence, molecules normally elute in order of decreasing size.

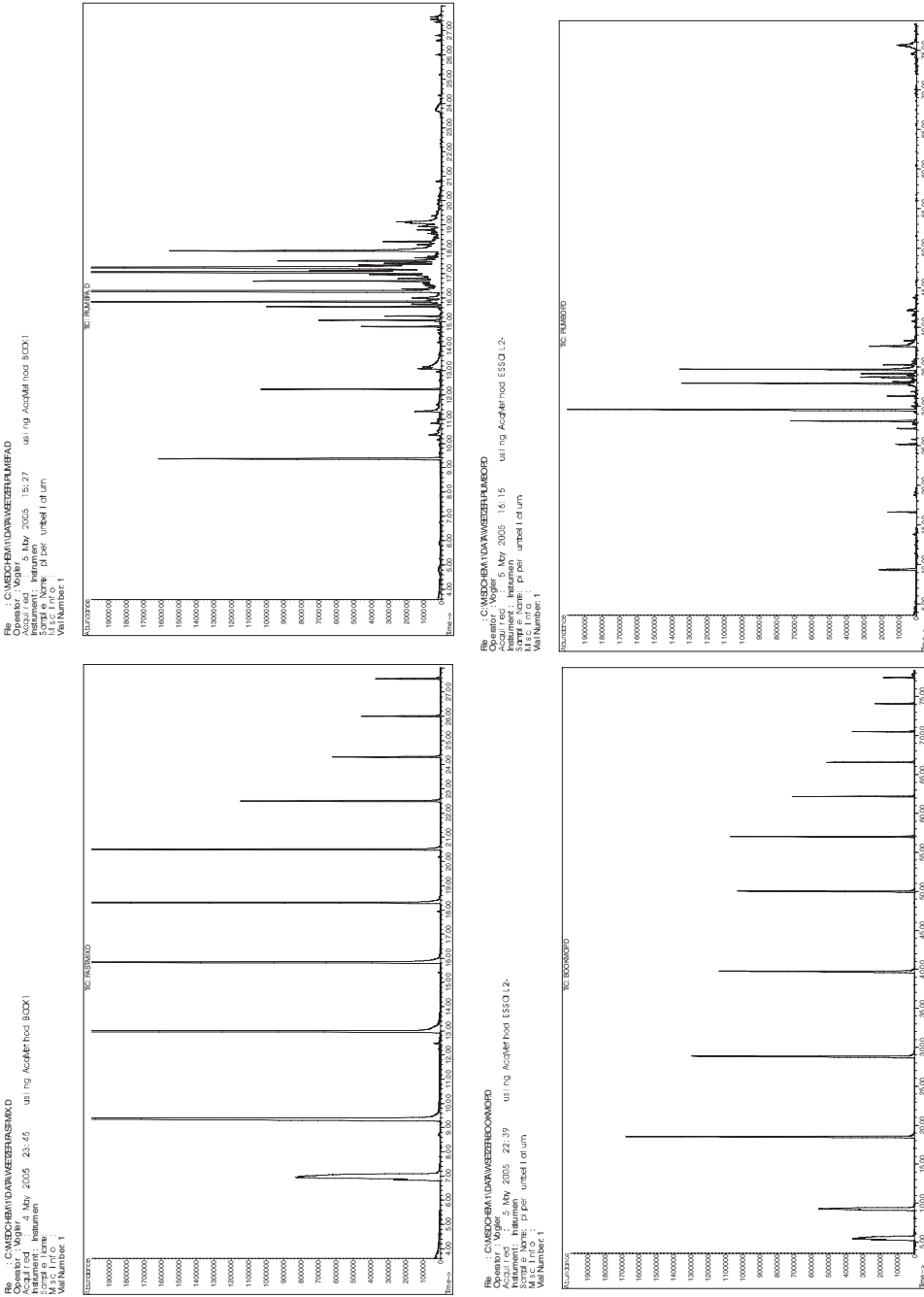

**FIGURE 8.18** Influence of change of temperature program on the separation. On the left panels are chromatograms of a mixture of a homologous series of hydrocarbons; on the right panels are chromatograms of the essential oil of *Piper umbellatum*. The upper panels show use of a fast gradient (50 to 250°C over 25 min); the lower panels show use of a slow gradient (50 to 250°C over 70 min).



Unlike other modes of liquid chromatography, the interaction between sample molecules and the stationary phase is minimized to keep the sample from spreading out within the column, resulting in higher recoveries. However, size-exclusion chromatography is not considered a method to use to achieve a high level of purity. It is usually used only as a “cleanup” step during liquid chromatography purification protocols to reduce the amount of larger or smaller molecules that may contaminate a compound of interest. Such techniques are widely used for the separation and characterization of biological macromolecules, especially proteins.

All size-exclusion separations are run under isocratic conditions, with a constant mobile phase (Cseke et al., 2004). Three major factors affecting such separations are the ionic strength, detergent concentration, and organic modifiers that may be added to the mobile phase. These conditions will also control which type of gel resin can be used. Consequently, a number of commercial gel matrices are available, such as Sephadex™, Sepharose™, Sephacryl™, Sepharose CL™, and Bio-Gel™, each with different chemical properties and size-exclusion ranges. By choosing an appropriate gel resin as a column matrix, molecules can be separated as they move through the column. For example, Sephadex (General Electric/Amersham Biosciences, United Kingdom) is widely used in the purification of proteins and is also widely used in determining their molecular weights (Cseke et al., 2004). This type of column packing must be hydrated before it is functional as a separation medium. The hydration process causes the pores in the Sephadex to swell to the appropriate size. For example, Sephadex G-10 gains approximately 1 ml of water per gram of dry gel during hydration, while Sephadex G-200 gains approximately 20 ml of water per gram of dry gel. Bio-Gels™ from Bio-Rad Laboratories (Hercules, CA) consist of long polymers of acrylamide that are cross-linked to *N,N*-ethylene-*bis*-acrylamide. These gels have a larger range of pore sizes than the Sephadex G series. Still another porous gel, with an even larger pore size, is agarose, made from the neutral polysaccharide fraction from agar. Agarose and polyacrylamide can be used to separate nucleic acids and proteins as well as other biological samples as large as ribosomes and viruses.

Remember that many of the compounds separated by this technique (such as proteins) degrade relatively easily. Therefore, size-exclusion chromatography is usually done in a cold room held at 4°C. Once an appropriate column matrix is chosen and hydrated (if necessary), the matrix suspension is transferred to a vertical plastic or glass column (often 2 × 60 cm in size). The column fluid is then allowed to drain in order to “pack” the column. The void volume of the column can then be determined by adding a dye of large molecular size (such as Blue Dextran) to the top of the column and allowing it to flow through the column (around the gel resin beads) by adding mobile phase to the column. The amount of mobile phase required for the dye to leave the column is the void volume, and it is used to help figure out when to begin collecting sample fractions. At this point, the sample can be carefully added to the top of the column, and an automatic fraction collector can be used to collect different samples, as the column is run for several hours. In addition, various compounds can be detected as they leave the column, if an appropriate detector is attached to the bottom of the column. For example, proteins can be detected if a UV detector is linked to the column.

Once the samples are collected, various analytical techniques can be used to determine which fractions contain the compound of interest. For example, when isolating enzymes, enzymatic assays can be used, and for other proteins, immunoassays or SDS-PAGE (see Section 8.5.3.1) can be used. Other biological products may require mass spectrometry or NMR spectroscopy (see Chapter 9). For protein work, the fraction of interest can also be dialyzed to reduce the ionic strength prior to the next purification procedure, and dialyzed fractions can be concentrated using Amicon® centrifuge tubes (Millipore, Billerica, MA) or equivalent tubes that allow the volume to be reduced by spinning them in a centrifuge (Cseke et al., 2004).

In addition, gel permeation can effectively be used as an analytical tool under high pressure for the separation of proteins and other molecules based on size. In these cases, the columns are usually packed with synthetic polymer beads that can withstand high pressure. Due to its ability to separate proteins or other large biological molecules by size, size-exclusion chromatography is widely used in the biotechnology industry to monitor the level of aggregates in a protein-based therapeutic (Cseke et al., 2004).

## 8.4.6 Case Studies: Examples of Chromatography Protocols

### 8.4.6.1 Purification of Proteins Using Ion-Exchange Chromatography

As mentioned in Section 8.4.5, gel filtration methods separate proteins according to different molecular sizes, but these methods are usually used only as cleanup steps prior to other forms of chromatography during purification procedures. For proteins, one of the most common methods of purification is **ion-exchange chromatography**, which separates proteins based on their charge. The basic principle is that at a given pH, most proteins have an overall negative or positive charge depending on their pI value. This makes it possible for them to interact with an oppositely charged chromatographic matrix. Different proteins have different amounts of charge, causing differential retardation in chromatography, during which proteins are separated. There are two types of columns commonly used. One is **diethylaminoethyl (DEAE) cellulose** for binding to net negatively charged proteins. The other is **carboxymethyl (CM) Sephadex** for binding to net positively charged proteins in addition to separating the proteins based on molecular size, as in gel filtration (Cseke et al., 2004). As an example, we focus on a procedure using DEAE cellulose.

#### *DEAE Cellulose Chromatography*

1. Prepare 2 ℓ of 10 to 20 mM phosphate buffer (pH 6.0) containing 1 mM EDTA, 1 mM benzamidine, and 0.1 mM PMSF. Store at 4°C.
2. Suspend an appropriate amount of DEAE cellulose in 20 volumes of phosphate buffer, and allow it to equilibrate for 1 to 2 h at 4°C.
3. Transfer the matrix suspension into a plastic or glass column (1.5 × 20 cm to 2 × 40 cm), setting it vertically with the bottom valve closed. The column should be filled with the gel suspension up to a level about 5 cm from the top. Add more buffer to the top, and let it stand for 30 min to allow the matrix to settle.
4. Drain the fluid by opening the bottom valve to “pack” the column, and close the valve once the buffer reaches the top of the column matrix.
5. Add 0.5 to 1.0 ml of an appropriate dye solution, such as Blue Dextran, to the top of the column, open the bottom valve, and collect the eluate in a beaker. Continue to add the phosphate buffer to the top of the column until the dye runs out of the column. The volume of collected eluate is the estimated void volume of the column.
6. In a cold room, assemble an automatic fraction collector with about 100 collection tubes, and place the collector under the column. Set the collection volume per tube at 3 ml. If an automatic protein-peak UV detector is available, connect the detector to the bottom of the column and then to the collector according to the instructions.
7. Pretest the flow of the assembled components by running the buffer through the column at a flow rate of 2.0 ml·min<sup>-1</sup>.
8. Stop the addition of buffer to the column, and allow the liquid to come to the top of the column matrix. Carefully add the extracted protein sample (such as the active-fraction pool purified by gel filtration) to the top of the column. When the protein sample solution subsides into the bed-matrix, wash the column with two to three bed volumes of phosphate buffer (pH 6.0), and start to collect the eluate.
9. The elution buffer is a linear gradient of 0 to 0.6 M NaCl in phosphate buffer or appropriate buffer for the protein of interest. This can be made by using a commercial gradient maker consisting of two chambers. First, close the channel between the two chambers. Add a volume (e.g., 250 ml) of phosphate buffer lacking NaCl to the inner chamber. Add an equal volume (e.g., 250 ml) of phosphate buffer containing 0.6 M NaCl to the outer chamber. Drop a stir bar in the inner chamber, and place the entire gradient maker on a stir plate that is set above the DEAE cellulose column and connected to the top of the column.

10. Elute the bound proteins with the 0 to 0.6 M NaCl gradient by opening the valve of the gradient maker to the column and then opening the channel between the two chambers with the magnetic stir bar rotating.
11. Adjust the flow rate at the top of the column so that it is the same as the flow rate at the base of the column. Allow the column to run for 3 to 10 h at 4°C.
12. Stop running the column, and transfer the tubes in appropriate order to an ice-water bath until analysis can be performed.
13. Carry out the appropriate enzyme assay for each of the tubes, and pool the active fractions for further purification. For nonenzymatic proteins, appropriate analysis methods should be used to identify the positive fraction containing the protein of interest. These methods include immunoassay, immunoblotting, and MW determination by SDS-PAGE or by elution profile of standard protein markers chromatographed on the same column under the same conditions. Pool the fraction containing the expected proteins for further purification.
14. If necessary, dialyze the pooled samples against diluted elution buffer (1:5 dilution) to reduce the ionic strength prior to the next purification procedure.
15. Concentrate the pooled or dialyzed sample using Amicon centrifuge tubes or equivalent tubes. Add 5 to 7 ml to each tube, assemble the tubes according to the instructions, and centrifuge at 2000 to 3000 g for 20 min at 4°C. Stop the centrifugation, and decant the concentrated fluid from the collection tube. Transfer the concentrated protein sample from the inner tube into a fresh tube, and proceed to the next step of purification.

#### 8.4.6.2 *Extraction and Bioactivity-Directed Separation of the Bark of an Undescribed Salacia Species from Monteverde, Costa Rica (Setzer et al., 1998; Bates et al., 1999)*

The bark of an undescribed species of *Salacia* (Hippocrateaceae) was collected from Monteverde, Costa Rica, extracted with chloroform, and the crude extract was screened for biological activity. A total of 2.50 kg fresh bark was extracted, using a Soxhlet extractor, for 4 h, to give 42.7 g crude bark extract. The extract showed antibacterial activity against *Bacillus cereus* and *Streptococcus pneumoniae* and cytotoxic activity against Hep G2, MDA-MB-231, MCF7, PC-3, SK-MEL-28, and 5637, human tumor cell lines. See Chapter 10 for descriptions of these bioassays. The procedure was as follows:

**Adsorb the crude extract onto silica gel.** The crude CHCl<sub>3</sub> *Salacia* extract (25.00 g) was dissolved in CH<sub>2</sub>Cl<sub>2</sub>. The solution was added to 100 g of 230–400 mesh silica gel, and the CH<sub>2</sub>Cl<sub>2</sub> was allowed to evaporate to adsorb the extract onto the silica gel. The mixture was stirred from time to time to obtain a homogeneous mixture.

**Pack the chromatography column.** Using the wet-pack technique, approximately 750 g of 230–400 mesh silica gel was thoroughly mixed with hexane, and the slurry was packed into a large chromatography column (87 cm in length × 5 cm in diameter). The silica gel was allowed to settle with gentle tapping on the column. After the column was packed with silica gel, a slurry of the *Salacia* extract/silica gel and hexane was prepared, and the slurry was very carefully (so as to avoid disturbing the surface of the silica gel) added to the column.

**Use flash chromatography to separate *Salacia* extract.** The column was then fitted with a 2-ℓ solvent reservoir (attached to the column with a Keck® clip). The reservoir was filled with hexane, and a nitrogen inlet was fitted on top of the solvent reservoir (attached with a Keck clip, see Figure 8.19). The bottom stopcock was opened, slight nitrogen pressure (ca. 5 psi) was applied, and chromatography commenced. After a forerun of 750 ml, 250 ml fractions were collected in Erlenmeyer flasks. The following solvent step gradient was used for the separation: hexane (F1 to F16), 9:1 hexane/ethyl acetate (F17 to F47), 4:1 hexane/ethyl acetate (F48 to F111), 1:1 hexane/ethyl acetate (F112 to F139), ethyl acetate (F140 to F144), and ethanol (F145 to F188).

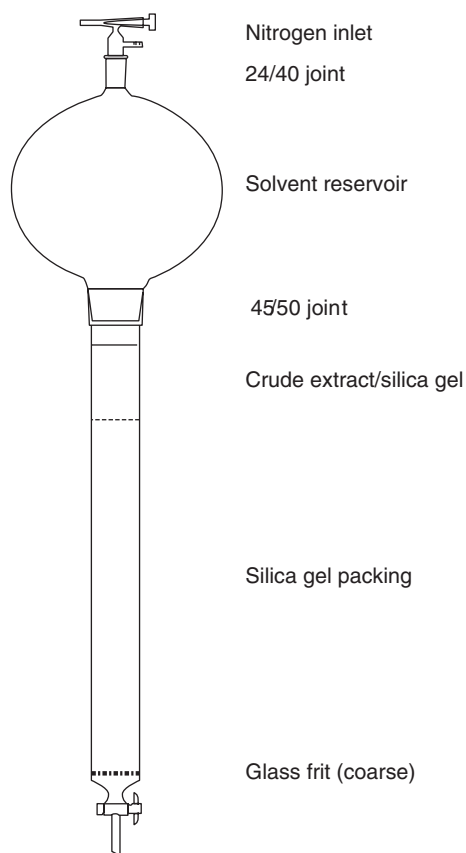

FIGURE 8.19 Preparative flash chromatography column.

**Combine fractions based on TLC.** Analytical thin-layer chromatographic analysis was carried out on each fraction, and fractions with comparable TLC profiles were combined to give “superfractions,” as presented in Table 8.3.

**Screen for bioactivity.** Small samples of each of the combined “superfractions” were dissolved in dimethylsulfoxide to make 1% (w/v) solutions. Each of these samples was tested for bioactivity against Hep G2 liver tumor cells (see Chapter 10). Fractions F87–F89, F90–F93, F94–F101, F102–F105, and F106–F114 showed excellent cytotoxic activity.

**Purify compounds by recrystallization.** F32 was recrystallized from hexane to give 41.2 mg friedelin. F40–F42 was recrystallized from hexane to give 50.8 mg 1-hydroxy-3,6-dimethoxy-9H-xanthene-9-one. F46–F49 was recrystallized from hexane to give 40.9 mg friedelan-3-on-29-al. F58–F60 was recrystallized from ethyl acetate to give 149.2 mg canophyllol. F61 and F62–F63 were recrystallized from ethyl acetate to give 28.9 and 65 mg, respectively, of 30-hydroxyfriedelan-3-on-28-al as a mixture of *R*- and *S*-hemiacetals. F64–F65 was recrystallized from ethyl acetate/pentane using the solvent diffusion technique to give 9.1 mg 29-hydroxyfriedelan-3-one. The sample was dissolved in a minimal amount of warm ethyl acetate, the open vial was placed in a jar with pentane, and the crystals were allowed to form over several days. F87–F89, F90–F93, F94–F101, and F102–F105 were recrystallized from ethyl acetate to give 238.7 mg, 404.2 mg, 2.773 g, and 128.5 mg, respectively, of tingenone, which proved to be the cytotoxic agent responsible for the activity (see Figure 8.20).

TABLE 8.3

Superfractions Obtained from *Salacia* Extract

Fractions	Yield (mg)	Fractions	Yield (mg)	Fractions	Yield (mg)
F1-F4	181.0	F55-F57	115.5	F115	394.3
F5-F6	31.0	F58-F60	303.4	F116-F117	859.4
F7-F8	7.6	F61	138.1	F118-F122	1340.8
F9-F10	6.7	F62-F63	254.2	F123	135.8
F11-F16	10.4	F64-F65	140.3	F124-F127	501.9
F17-F19	3.1	F66-F67	182.8	F128-F130	269.6
F20-F29	4.7	F68-F70	145.4	F131-F136	293.9
F30-F31	0.2	F71-F72	62.2	F137-F144	151.2
F32	251.9	F73-F76	184.1	F145	121.0
F33-F34	215.6	F77-F79	117.5	F146-F147	375.4
F35	13.8	F80-F83	142.9	F148-F154	644.0
F36-F38	65.8	F84-F86	115.3	F155-F158	154.2
F39	28.8	F87-F89	350.4	F159-F168	355.6
F40-F42	220.8	F90-F93	1141.9	F169-F172	101.9
F43-F45	123.2	F94-F101	2940.1	F173-F181	104.4
F46-F49	86.5	F102-F105	354.4	F182	1912.5
F50-F54	64.2	F106-F114	309.0	F183-F188	1052.2

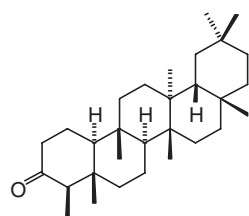

friedelin

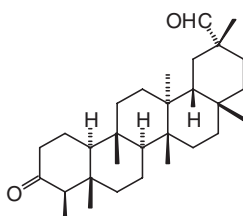

friedelan-3-on-29-al

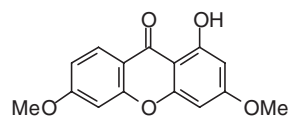

1-hydroxy-3,6-dimethoxy-9H-xanthene-9-one

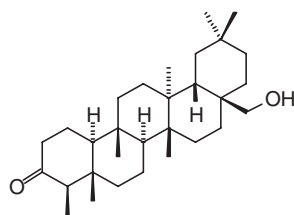

canophyllol

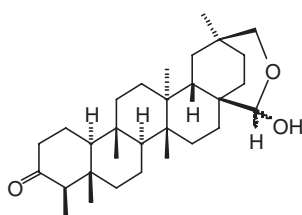

30-hydroxyfriedelan-3-on-28-al hemiacetals

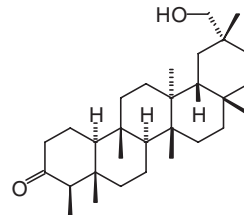

29-hydroxyfriedelan-3-one

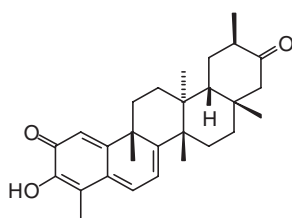

tingenone

FIGURE 8.20 Compounds isolated from *Salacia* sp. nov. "liana."

## 8.5 Electrophoresis

### 8.5.1 The Basics

The process of **electrophoresis** is defined as the differential migration of ions by attraction or repulsion in an electric field (Bruno, 1991). In practical terms, a positive (anode) electrode and a negative (cathode) electrode are placed in a solution containing ions. When a voltage is applied across the electrodes, solute ions of different charge (i.e., anions [negative ions] and cations [positive ions]), will move through the solution toward the electrode of opposite charge. One can take advantage of this phenomenon to separate plant products if the electric current is applied across a solid matrix material. If the plant products have a net positive or negative charge, they will migrate through the matrix toward the electrode of opposite charge on the basis of both the amount of charge and the size of the molecule. There are a variety of forms of electrophoresis that have found widespread use based on this principle, such as agarose gel electrophoresis, polyacrylamide gel electrophoresis (PAGE), two-dimensional gel electrophoresis, and the relatively new techniques of capillary electrophoresis, as we will describe below. We refer the reader back to Chapter 1 for information on the structures and chemical properties of the compounds discussed below.

### 8.5.2 Agarose Gel Electrophoresis

**Agarose gel electrophoresis** is a standard method of electrophoresis used to separate and characterize nucleic acids. **Agarose** (Figure 8.21), extracted from seaweed, is a linear polymer consisting of D-galactose and 3,6-anhydro-L-galactose units. It is soluble in hot water or aqueous buffer and cools to form a matrix that serves as a molecular sieve to separate DNA fragments or extracted RNA on the basis of size. Under the influence of an electric field, the nucleic acid fragments migrate toward the positive electrode due to the negative charges contained on the phosphate groups of the DNA or RNA backbone (see Chapter 5). The larger the fragments, the more slowly they migrate through the matrix due to the resistance encountered in the matrix. The concentration of agarose used depends on the range of DNA or RNA sizes to be resolved. In general, concentrations of 0.8 to 1% agarose are adequate for fractionation of most nucleic acid fragments. The electrophoresis buffer also influences migration of these fragments within the agarose gel depending on its composition. The most commonly used buffers are TAE (Tris-acetate-EDTA) and TBE (Tris-borate-EDTA). Unfortunately, this method has relatively few uses for the analysis of most plant products, because the agarose gel is only able to resolve large charged molecules such as DNA or RNA in excess of 50 base pairs. Exciting new developments in electrophoresis, however, are starting to allow electrophoresis techniques to be used for more types of compounds (see Section 8.5.4).

Because the DNA or RNA within the gel is invisible to the naked eye, a small amount of ethidium bromide (EtBr), 2  $\mu\text{l}$  of 10  $\text{mg}\cdot\text{ml}^{-1}$  per 100 ml, is added to the gel and buffer either during electrophoresis or afterward to stain the fragments (Figure 8.22). EtBr stains nucleic acid molecules by intercalation between the stacked bases. It fluoresces orange when illuminated with UV light, allowing the nucleic acid to be visualized within the gel. The merit of adding EtBr to the gel is that DNA or RNA bands can be stained and monitored with a UV lamp while the electrophoresis is underway. However, EtBr is also a powerful mutagen and a potential carcinogen. Therefore, gloves should be worn when working with

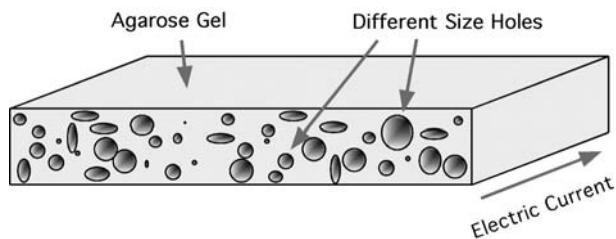

**FIGURE 8.21** A slab of agarose with sieve-like holes exposed on the edge. Note that there are many different sizes of tunnels scattered randomly throughout the gel.

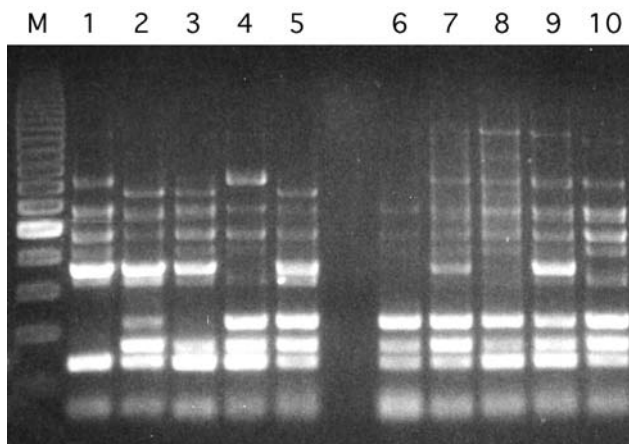

**FIGURE 8.22** Top view of an agarose gel containing EtBr after the current was on for a while (positive pole at the bottom) and then turned off. The gel has several lanes where different samples of DNA were applied to the gel. Lane M, molecular weight standards of known sizes; Lanes 1 through 10, a mixture of different sizes of DNA resulting from PCR. The molecular weight standards are used to measure the relative sizes of the unknown fragments from each sample.

this compound. All EtBr waste (gel, electrophoresis buffer, etc.) needs to be disposed of properly according to local safety practices.

### 8.5.3 Polyacrylamide Gel Electrophoresis (PAGE)

Another form of electrophoresis uses a gel matrix with different chemical characteristics ideal for the separation of different proteins from plant extracts. Unlike nucleic acids, which have a natural net negative charge, a mixture of proteins (such as that obtained from other chromatographic separations) has individual proteins that each has a different amount of overall positive or negative charge based on their individual pI values. Each protein will thus move toward the electrode with the opposite charge under the influence of their overall charge. If such a mixture of proteins is placed in an environment that will allow different-sized proteins to move at different rates, then they can be separated according to both charge and size. The environment of choice is polyacrylamide, which is a polymer of acrylamide monomers usually cross-linked to *N,N*-ethylene-*bis*-acrylamide. When this polymer is formed, it turns into a gel-like molecular sieve similar to the agarose gel described above. The process of electrophoresis using such a gel is called **polyacrylamide gel electrophoresis (PAGE)**. Its main advantage is that it can resolve molecules that cannot be resolved on a gel matrix such as agarose.

#### 8.5.3.1 SDS-PAGE

One of the most widely used forms of PAGE makes use of detergents to reduce folded proteins to their primary structures, allowing them to be separated based predominantly on their size. **SDS** (sodium dodecyl sulfate) is an anionic detergent that, like other detergents, can dissolve hydrophobic molecules, but it also has a negatively charged head group (a sulfate group) attached to it. Therefore, if a cell is incubated with SDS, the membranes will be dissolved, all the proteins will be solubilized by the detergent, and all the proteins will be coated with negative charges. This binding results in equal charge densities per unit length of protein, thereby eliminating the ionic charges of individual amino acids. Therefore, a protein that may start out like the example shown in the top part of Figure 8.23 will be converted into one shown in the bottom part of the figure. The end result has two important features: all proteins retain only their primary structure and all proteins have a net negative charge, which means they will all migrate toward the positive pole when placed in an electric field. As in the case of the separation of negatively charged nucleic acids using agarose gel electrophoresis, SDS-PAGE is able to separate SDS-treated proteins predominantly by size, making other physical features insignificant. The primary disadvantage of SDS-PAGE is that it destroys the activity of proteins, such as enzymes.

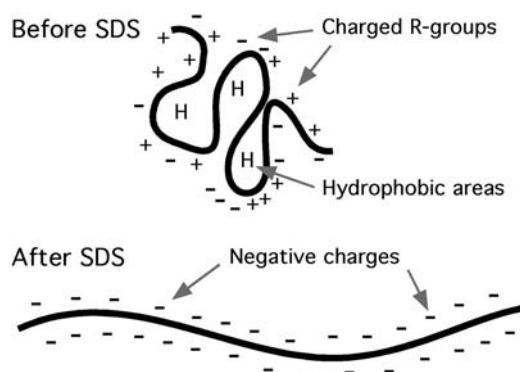

**FIGURE 8.23** A depiction of what happens to a protein (dark line) when it is incubated with the denaturing detergent SDS. The top portion of the figure shows a protein with negative and positive charges due to the charged R-groups in the protein. The large Hs represent hydrophobic domains where nonpolar R-groups collected in an attempt to get away from the polar water that surrounds the protein. The lower diagram shows that SDS can disrupt hydrophobic areas and coat proteins with many negative charges, which overwhelms any positive charges the protein had due to positively charged R-groups. The resulting protein was denatured by SDS (reduced to its primary structure).

SDS-PAGE can be used to separate and determine the molecular weights (MWs) of proteins when the migration of unknown proteins is compared to the migration of standardized protein-size markers. There is a linear relationship between the log of the MW of a polypeptide and its  $R_f$ , which is the ratio of the distance from the top of the gel to the polypeptide divided by the distance from the top of the gel to the dye front. A standard curve can be generated by plotting the  $R_f$  of each standardized protein marker as the abscissa and the  $\log_{10}$  of its MW as the ordinate. The MW of an unknown protein can then be determined by finding its  $R_f$ , which vertically crosses on the standard curve, and reading the  $\log_{10}$  MW that horizontally crosses to the ordinate. The antilog of the  $\log_{10}$  MW is the actual MW of the protein.

### 8.5.3.2 Nondenaturing PAGE

**Nondenaturing polyacrylamide gel electrophoresis (PAGE)**, or **native gel electrophoresis**, is a procedure that separates proteins according to their native or folded sizes as well as their natural charge properties. The acrylamide pore size serves as a molecular sieve to separate different sizes of proteins. Further, proteins that are more highly charged at the pH of the separating gel migrate faster than those with less-charged molecules. The major merit of nondenaturing PAGE is that it minimizes the denaturation of proteins in contrast to sodium dodecyl sulfate (SDS)-PAGE, which denatures proteins. Thus, many enzymes still have biological activities after running PAGE. The enzyme activity can be assayed either directly within the gel or following protein elution from the gel. Procedures for carrying out native gel electrophoresis can be almost identical to those used for SDS-PAGE, except that there is no SDS component (Cseke et al., 2004).

### 8.5.3.3 Two-Dimensional Gel Electrophoresis

So far, we discussed the use of one-dimensional gels, which can be routinely used to separate a mixture of proteins on the basis of molecular size or native charge. However, under some circumstances, more information may be required about the individual proteins within a mixture. In these cases, two-dimensional (2D) gel electrophoresis may be used to better separate proteins based on additional criteria. Two-dimensional gel electrophoresis consists of a first-dimensional gel, which is an **isoelectric focusing (IEF)** gel, as well as a second-dimensional gel, which is normally SDS-PAGE. The IEF gel separates the proteins based on each protein's individual pI value, while SDS-PAGE denatures and separates the proteins based on their molecular sizes, as previously described. When done correctly, the results of 2D gel electrophoresis can give much higher resolution of individual proteins or similar amphoteric substances, and such procedures are widely used in the study of proteomics (Figure 8.24) (see also Chapters 5 and 6).



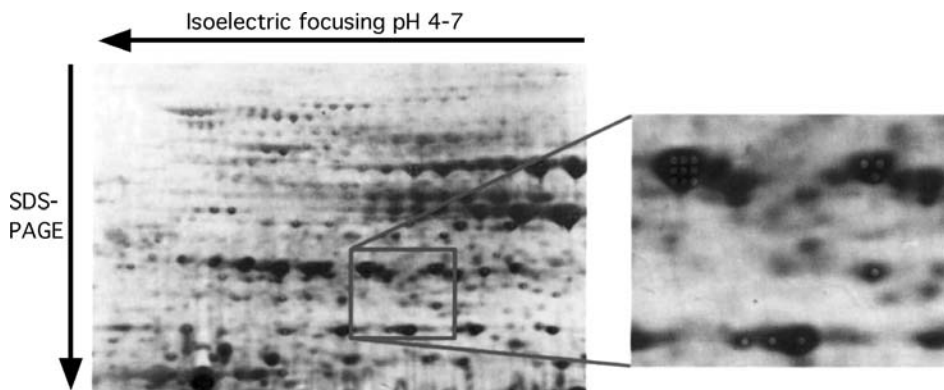

**FIGURE 8.24** An example of a gel resulting from two-dimensional gel electrophoresis, showing proteins stained with Coomassie Blue. This gel was used for proteomic studies where small sections of the gel were taken out (the small circles within each spot) and used for mass spectrometry analysis to identify the proteins within the individual spots.

Classical methodology for the 2D gel electrophoresis was well established by O'Farrell (1975). The fundamental premise of IEF is that a molecule will migrate as long as it is charged. Should it become neutral, it will stop migrating in the electric field. IEF is run in a pH gradient where the pH is low at the anode and high at the cathode. The preparation of the focusing gel is similar to the preparation of the gel for SDS-PAGE, except no stacking gel is required. The pH gradient is generated with a series of chemicals known as **carrier ampholytes**. When a voltage is applied, the ampholyte mixture separates within the gel. Positively charged ampholytes will migrate toward the cathode, while negatively charged ampholytes migrate toward the anode. This movement results in alignment of the different ampholytes between the cathode and the anode according to their isoelectric points (pIs). Finally, the ampholyte migration will cease when each ampholyte reaches its own pI and is no longer charged. Any amphoteric sample added to the gel will migrate according to the same principles. For example, an amphoteric sample added to the gel with a net negative charge will migrate toward the anode, where it encounters buffer of decreasing pH. Finally, the sample encounters a pH at which its net charge becomes zero, the isoelectric point (pI), and migration halts. The same sample is usually run in several lanes that are subsequently separated into individual strips for the analysis of the pH gradient by applying the strips to the top of an SDS-PAGE gel run in the second direction.

Ampholytes are not isoelectric at times, and loss of basic ampholytes can occur during electrophoresis, affecting the stability of the pH gradient. Such problems are overcome by using **immobilines**, which are co-polymerized with the acrylamide and *bis*-acrylamide, resulting in stable pH gradients during electrophoresis. Thus, IEF using immobilized pH gradients can provide sufficient focusing for even problematic proteins.

#### 8.5.3.4 Staining Techniques

As in the case of agarose gel electrophoresis, where ethidium bromide (EtBr) is used to visualize nucleic acids, the proteins within a PAGE gel are also naked to the human eye unless stained for visualization. The most common method used to stain proteins within a gel is to soak the gel after running it in a solution of **Coomassie Blue** for approximately 1 h (Cseke et al., 2004). During this time, the Coomassie Blue stain penetrates the gel and binds to the proteins. When the staining solution is removed, the gel is then placed in a destaining solution. The Coomassie Blue stain leaves the gel but remains associated with the protein within the gel, causing the proteins to appear as blue bands (one-dimensional PAGE) or spots (2D PAGE). This method, however, is only able to resolve proteins within a gel if they are in relatively high abundance.

**Silver staining** is a very sensitive staining technique as compared to Coomassie Blue staining (Cseke et al., 2004). It relies on the differential reduction of silver ions that bind to the side chains of the amino acids within the proteins, allowing for detection of as little as 0.1 to 1.0 ng of protein with a PAGE gel. Thus, very weak bands that are not visible using Coomassie Blue staining become very sharp after silver staining. The disadvantage of this technique is that the silver staining procedure is much more complicated.

### 8.5.4 Capillary Electrophoresis

**Capillary electrophoresis (CE)** is a relatively new class of electrophoresis that is proving to be an extremely powerful technique for separating a variety of different compounds (Molnár-Perl and Füzai, 2005). It utilizes small-bore open capillary tubes in a system akin to an apparatus found in traditional electrophoresis. The two limiting factors of traditional electrophoresis are (1) that the detection of molecules within the gel is possible only upon completion of electrophoretic separation and (2) that only low voltages can be used to prevent heat damage of the samples. Any high voltages used in traditional electrophoresis tend to cause heat convection within the gel. This results in distortions and blurring of the separated bands. CE solves both of these problems: (1) Detection of the migrating molecules is accomplished most commonly by shining a light source (such as a laser of specific wavelength) through a portion of the tubing and detecting the light emitted from the other side. However, there are a variety of detectors that can be used. (2) Because the capillary tube has a high surface-to-volume ratio (20 to 200  $\mu\text{m}$  internal diameter), it allows for rapid dissipation of the heat produced by the electric current. Consequently, much higher voltages (10 to 30 kV) can be used in CE than can be used in traditional electrophoresis, and CE allows for much better resolution of related species of compounds as well as much faster running times. Its high sensitivity, speed of analysis, high resolution, flexibility of pH, and ability to utilize a variety of separation matrices make it an attractive separation method for a variety of applications.

The instrumentation required for CE is simple in design, as Figure 8.25 illustrates. The ends of a capillary are placed in separate buffer reservoirs, each containing an electrode connected to a high-

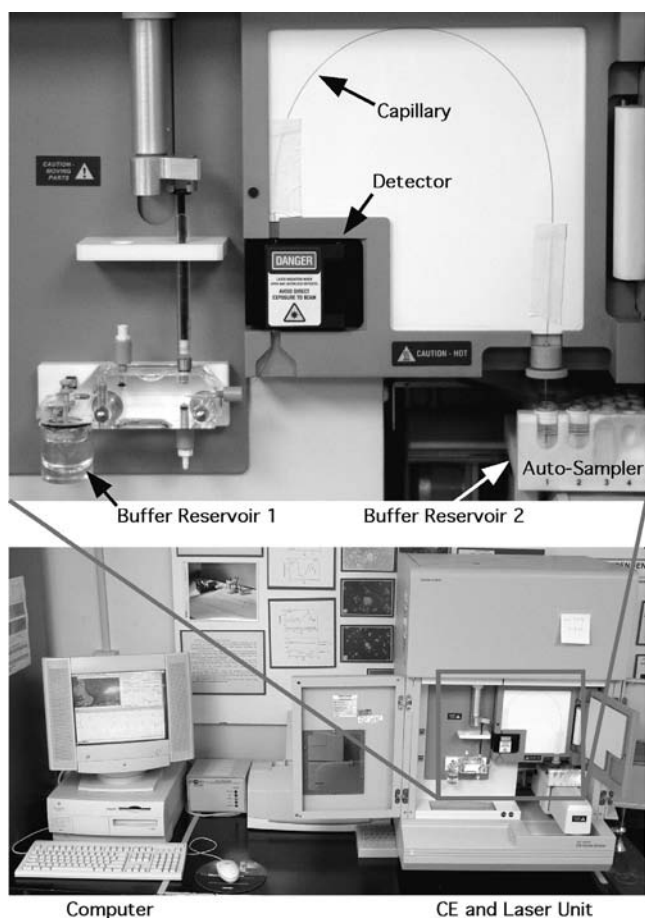

**FIGURE 8.25** An automated capillary electrophoresis system used for DNA sequencing. Samples enter the capillary tube from the right and travel to the left to the detection system (detector) that records the chromatogram output on a computer.

voltage power supply capable of delivering up to 30 kV. The sample is injected onto the capillary by temporarily replacing one of the buffer reservoirs (normally at the anode) with a sample reservoir, and then either pressure is applied to the sample and 10 to 100 nl is injected or an electrical current is applied through the sample and only the charged molecules enter the capillary. After replacing the buffer reservoir, an electric potential is applied across the capillary, and the separation is performed based on the same mechanisms as traditional electrophoresis. A vitally important feature of CE, however, is the flow of liquid and ions through the capillary. This is called the **electroosmotic flow (EOF)** and is caused by the fact that an uncoated fused-silica capillary tube is typically used for CE. The surface of the inside of the tube has ionizable silanol groups that are in contact with the buffer. These silanol groups readily dissociate, giving the capillary wall a negative charge. Therefore, when the capillary is filled with buffer, the negatively charged capillary wall attracts positively charged ions from the buffer. As the buffer travels through the capillary tube via the electrical current, there is an EOF produced that carries these positively charged species of molecules in the same direction as the negatively charged species. Hence, both negatively and positively charged species can be separated and analyzed at the same time. Various modifications can be made during CE to help control EOF (Rasmussen and McNair, 1990), and the primary alterations are summarized in Table 8.4.

Detection of separated molecules can be achieved directly through the capillary wall near the opposite end (normally near the cathode). Instead of the cumbersome stains used in traditional electrophoresis, CE utilizes several types of detectors, including spectrophotometers, mass spectrometers, electrochemical detectors, and radiometric detectors (see Table 8.5 for a listing) (Albin et al., 1991; Yeung and Kuhr, 1991). The data output from CE is presented in the form of an electropherogram, which is analogous to a chromatogram, where the electropherogram is a plot of migration time versus detector response. Once the electrophoretic separation is completed, the contents of the capillary are flushed out, and fresh matrix fills the tube. Replacing the matrix within the capillary minimizes the possibility of contaminating samples between runs.

CE is very suited to automation, and the arrangement of commercial CE instruments will seem familiar to those with knowledge of modern HPLC (McLaughlin et al., 1991). Basic features of an automated CE instrument include an autosampler, a detection module, a high-voltage power supply, the capillary, and a computer to control everything. So, if we consider that the power supply is equivalent to an HPLC pump, and the capillary is equivalent to a column, the instrumentation is completely analogous. This is especially so, as the software packages used to control most commercial CE instruments are based heavily on existing HPLC software.

**TABLE 8.4**

Summary of Methods Used to Control EOF during Capillary Electrophoresis

Variable	Result	Considerations
Change electric field	EOF will change proportionally	Resolution of compounds may decrease when lowered; heating may result when increased
Change buffer pH	EOF decreased at low pH; EOF increases at high pH	Easiest method of changing EOF; may cause the solute to change charge
Change ionic strength or concentration of buffer	Decreases the EOF as the ionic strength increases	Heating may result from high ionic strength; adsorption of compounds may result from low ionic strength
Add surfactant to buffer	Adsorbs to capillary wall via hydrophobic or ionic interactions	Anionic surfactants can increase EOF; cationic can reverse or decrease EOF
Add organic modifier to buffer	Changes the viscosity of the solution, usually decreasing EOF	Many changes can occur depending on the modifier used
Use a neutral hydrophilic polymer to pack the column	Adsorbs to capillary wall via hydrophobic interactions	Decreases EOF by shielding the surface charge of the column
Covalently coat the column	Chemical bonding to the capillary wall	Many modifications are possible depending on the compound used
Change temperature	Alters viscosity of the solution or the column packing	Usually controlled by the instrument

TABLE 8.5

Methods of Detection Used in Capillary Electrophoresis

Method	Sensitivity	Pros/Cons
UV-Vis	Moderate; most sensitive when used at low wavelengths	Most common method; most simple method; cannot be used with all compounds
Fluorescence	High	Molecules usually require chemical labeling with a fluorophore
Laser-induced fluorescence	Extremely high	Molecules usually require chemical labeling with a fluorophore
Amperometry	Very high	Useful only for electroactive molecules; requires specialized electronics
Indirect UV, fluorescence, or amperometry	Low compared to direct methods	Commonly used for inorganic ions that do not absorb UV radiation
Conductivity	Moderate	Requires specialized electronics
Radioactivity	Very high	Molecules require radioactive chemical labeling; dangers are associated with the use of radioactivity
Mass spectrometry	High to very high depending on the equipment	Primary advantage is that it generates structural information for better identification; the equipment is very expensive

### 8.5.4.1 Basic Modes of Capillary Electrophoresis

CE comprises a family of developed techniques that have dramatically different separation characteristics. The basic modes of CE include capillary zone electrophoresis, capillary gel electrophoresis, capillary isoelectric focusing, isotachopheresis, capillary electrochromatography, micellar electrokinetic chromatography, and microemulsion electrokinetic capillary chromatography. The basic modes of CE are summarized in the next sections in the attempt to give the reader an understanding of the power of such techniques in the analysis of many varieties of compounds. We then go on to offer some guidelines as to how to choose the best CE technique for the analysis of different compounds from plants.

#### 8.5.4.1.1 Capillary Zone Electrophoresis (CZE)

**Capillary zone electrophoresis (CZE)**, also known as **free solution capillary electrophoresis (FSCE)**, is the simplest form of CE; yet it remains quite versatile. It separates molecules based on differences between their charge-to-size ratios, typically in an aqueous mobile phase or buffer. Knowledge of the structure, or more specifically the  $pK_a$ , of the compound will allow for the selection of an appropriate electrolyte. The  $pK_a$  of a compound is the pH at which it is 50% ionized. If the compound is basic, then it will be protonated (positively charged) at low pH. Conversely, an acidic compound will be deprotonated (negatively charged) at high pH (Huang et al., 1990). Zwitterionic compounds, which have both positive and negative charged groups, may be analyzed at either end of the pH range.

CZE is very useful for the separation of nucleic acids, proteins, and peptides, where complete resolution can often be obtained for nucleic acids differing by only one base or proteins differing by only one amino acid residue (Huang et al., 1990; Gu et al., 2004; Nielsen and Rickard, 1990; Rasmussen and McNair, 1990). This is particularly important in tryptic mapping, where mutations and post-translational modifications must be detected (see Chapter 6). Such separations are run at low pH with 1.5 M urea as an additive. The urea modifier induces peptide unfolding, thereby exposing the internal structural elements. Methods using chemical modifiers in the mobile phase are still being developed for the separation and analysis of compounds such as anthraquinones (Qi et al., 2004). Other applications where CZE may be useful include inorganic and organic anions and cations, such as those typically separated by ion chromatography. Small molecules, such as pharmaceuticals and wine pigments, can also be separated, provided they are charged (Sáenz-López et al., 2004). While CZE cannot normally separate neutral molecules, some methods were developed to separate neutral compounds, such as carbohydrates, by first modifying the compound so that it has a charge (Honda, 1996; Paulus and Klockow, 1996). In most cases, however, the technique of **micellar electrokinetic chromatography (MEKC)** gives superior results for charged as well as neutral small molecules. This mode of CE is covered below.

#### 8.5.4.1.2 Capillary Gel Electrophoresis (CGE)

**Capillary gel electrophoresis (CGE)** is based on traditional gel electrophoresis, where charged samples are separated in a medium, such as polyacrylamide, and exposed to an electric field (Yin et al., 1990). The composition of the media can also serve as a molecular sieve to separate compounds based on molecular size. Furthermore, the gel within surface-modified capillaries suppresses the electroosmotic flow (EOF). Because of the long history of this technique in traditional electrophoresis, the adaptation to CE is relatively simple. This is particularly valuable for DNA separations because no other technique to date has provided such dramatic separations. Here, polyacrylamide gel-filled capillaries are usually employed, because agarose gels are unable to withstand the heating produced by the high voltages. New polymer formulations with greater stability to the applied electric field are also available for applications such as DNA sequencing. In CZE and other forms of “open-tubular” CE, the capillary is filled with buffer by pressurization. For gel-filled capillaries, however, this technique would result in extrusion of the gel. Thus, an electrical current is applied through the sample to load the column with sample containing charged compounds.

Separations of oligonucleotides and DNA sequence products are now regularly accomplished in capillaries filled with polyacrylamide gels or their derivatives. Determining the purity of synthetic oligos is also an important application of CGE, due to the short run times that it allows. For restriction fragments, double-stranded DNA, and larger oligos, gels with little or no cross-linker seem to be most effective due to the larger pore size of the gel. Under these conditions, the fragment migration time is directly related to the number of bases present due to the negative charge contained on each phosphate group of each nucleotide. In addition, proteins denatured with 2-mercaptoethanol are usually run with a capillary SDS-PAGE system. Under these conditions, all proteins have the same charge-to-mass ratio because the native charge is supplied by SDS binding (see Section 8.5.3.1).

#### 8.5.4.1.3 Capillary Isoelectric Focusing (cIEF)

As described in Section 8.5.3.3, the fundamental premise of isoelectric focusing (IEF) is that a molecule will migrate as long as it is charged. Should it become neutral, it will stop migrating in the electric field. **Capillary IEF** is run under identical principles as traditional IEF electrophoresis, using a pH gradient generated with a series of chemicals known as **carrier ampholytes**. When a voltage is applied, the ampholyte mixture separates in the capillary. Ampholytes that are positively charged will migrate toward the cathode, while those negatively charged migrate toward the anode. Charged samples added to the capillary will migrate along with the ampholytes and will cease migration when each reaches its isoelectric point and is no longer charged. However, unlike traditional electrophoresis, it is important that the EOF and other convective forces be suppressed if cIEF is to be effective. The capillary walls can thus be coated with methylcellulose or polyacrylamide to suppress EOF.

Thus, in contrast to CZE, the buffer medium is discontinuous, with a pH gradient formed along the capillary, and commercial ampholytes are available from several suppliers covering many pH ranges. The three basic steps of cIEF are loading, focusing, and mobilizing. During loading, the sample is mixed with the appropriate ampholytes, and the mixture is loaded into the capillary either by pressure or vacuum aspiration. Focusing is then achieved under the same principles as traditional IEF electrophoresis. In traditional slab-gel techniques, the mobilization technique is unnecessary. Once focusing is completed, the gel is stained using standard methods. In cIEF, however, the bands must migrate past the detector; therefore, mobilization is required. For cathodic mobilization, the cathode reservoir is filled with sodium hydroxide/sodium chloride solution. In anodic mobilization, the sodium chloride is added to the anode reservoir. The addition of salt alters the pH in the capillary when the voltage is applied because the anions/cations compete with hydroxyl/hydronium ion migration. As the pH is changed, ampholytes and proteins are mobilized in the direction of the reservoir with added salt. Some systems also use pressure to simply force the contents of the column past the detector (Herrero et al., 2005). Again, a number of detectors can be linked to the capillary column for analysis of the compounds (see Table 8.5).

Capillary IEF is generally used for high-resolution separations of proteins and polypeptides, but it could be used for any amphoteric substance, provided a series of ampholytes that cover the entire pI range is used. In addition, cIEF is useful for determining the pI of a specific protein. cIEF is particularly

useful for separating immunoglobulins, hemoglobin variants, and post-translational modifications of recombinant proteins.

#### 8.5.4.1.4 Capillary Isotachopheresis (cITP)

Like cIEF, **capillary isotachopheresis (cITP)** relies on zero electroosmotic flow (EOF), and the buffer system is heterogeneous (Thormann, 1990). The capillary is filled with a **leading electrolyte** that has a high mobility compared with any of the sample components to be analyzed. The sample is injected, and a **terminating electrolyte** is supplied to the opposite reservoir. The ionic mobility of the terminating electrolyte is lower than any of the sample components, and thus, separation will occur in the gap between the leading and terminating electrolytes based on the individual mobilities of the molecules. The disadvantage of cITP is that unless spacer compounds are added to the sample, adjacent bands will be in contact with each other, obscuring the individual bands. A spacer compound is a nonabsorbing solute with a mobility value that falls in between the mobilities of two peaks that need to be resolved. In addition, cITP can separate either cations or anions but not both. Thus, ITP is typically used only as a preconcentration step for specific small molecules, peptides, and proteins prior to CZE or other capillary techniques.

#### 8.5.4.1.5 Capillary Electrochromatography (CEC)

**Capillary electrochromatography (CEC)** is a hybrid separation method that couples the high separation efficiency of CZE with HPLC (Molnár-Perl and Füzfa, 2005). CEC uses an electric field rather than hydraulic pressure to propel the mobile phase through a packed bed. So it is possible to use small-diameter packings and thereby achieve very high efficiencies. An additional benefit of CEC compared with HPLC is the fact that the flow profile in a pressure-dependent system is parabolic, whereas in an electrically dependent system, it is plug-like due to the EOF and is, therefore, much more efficient. The capillaries used in CEC are filled with standard HPLC packing materials. These are generally made of silica and have a large negative surface charge. This allows for the production of a significant EOF that drives the separation of both cationic and anionic compounds. However, if the solute has no ionizable group, or if the compounds are highly water insoluble, then a chromatographically based CE technique such as **micellar electrokinetic chromatography (MEKC)** or **microemulsion electrokinetic chromatography (MEEKC)** is more applicable.

#### 8.5.4.1.6 Micellar Electrokinetic Chromatography (MEKC)

**Micellar electrokinetic chromatography (MEKC)** is one of the most useful modes of CE for the separation of small molecules (Terabe et al., 1992). Unlike IEF or ITP, MEKC relies on a controllable EOF, making use of micelles to control the separation of both charged and uncharged molecules. Micelles are amphiphilic aggregates of molecules known as **surfactants** (specific types of detergents), long-chain molecules (10 to 50 carbon units) possessing a long hydrophobic tail and a hydrophilic head group. Normally, micelles are formed in aqueous solution with the hydrophobic tails pointing inward and the hydrophilic heads pointing outward into the aqueous solution. This results from the fact that the hydrophobic tail of the surfactant cannot be in contact with the aqueous solution. There are four major classes of surfactants: anionic, cationic, zwitterionic, and nonionic. The first two are most useful in MEKC and commonly include SDS (sodium dodecyl sulfate; anionic) and CTAB (cetyltrimethylammonium bromide; cationic). Micelles have the ability to organize molecules at the molecular level based on hydrophobic and electrostatic characteristics. Even neutral molecules can bind to micelles because the hydrophobic core has a strong solubilizing power. Therefore, in MEKC, the surfactant solutions act as chromatographic mobile-phase modifiers. Micellar chromatography can thus mimic reverse-phase liquid chromatography in that increasing the surfactant concentration increases the eluting power of the mobile phase.

Small molecules within a sample can partition between three locations: (1) the micelle phase and the mobile phase, (2) the micelle phase and the stationary phase, or (3) the mobile phase and the stationary phase. This three-phase equilibrium can be likened to ion-pair chromatography in many instances. For example, at neutral to alkaline pH, a strong EOF moves in the direction of the cathode. If SDS is employed as the surfactant, however, the electrophoretic migration of the anionic micelle goes in the

direction of the anode. As a result, the overall micellar migration is slowed compared with the bulk flow of solvent. Because different molecules can partition into and out of the micelles, the requirements for a separation mechanism are available. When a compound is associated with a micelle, its overall migration is slowed. When an uncharged compound resides in the mobile phase, its migration speed is that of the EOF. Therefore, molecules that have greater affinity for the micelle have slower migration compared with molecules that spend most of their time in the mobile phase. With such SDS micelles, the general migration order will be anionic compounds followed by neutral compounds followed by cationic compounds. Anions spend more of their time in the mobile phase due to electrostatic repulsions from the micelle. Neutral molecules are separated exclusively based on hydrophobicity, and cations elute last due to strong electrostatic attraction or ionic pairing with the anionic micelle (Honda, 1996).

As for applications, MEKC has a broad base of small molecules, oligonucleotides, and peptides that can be efficiently separated and analyzed. Some examples include the analysis of modified nucleic acids, penicillins, OPA-amino acids, urinary porphyrins, aspirin, caffeine, water-soluble vitamins, antibiotics, phenols, chiral drugs, catecholamines, small oligonucleotides, and sulfonamides (Bonoli et al., 2004; Debusschère et al., 1997; Nishi et al., 1990).

#### 8.5.4.1.7 *Microemulsion Electrokinetic Chromatography (MEEKC)*

**Microemulsion electrokinetic chromatography (MEEKC)** is similar to MEKC in that it offers the possibility of obtaining highly efficient separations of both charged and neutral solutes covering a wide range of water solubilities (Marsh et al., 2004; Terabe et al., 1992). The main difference is that MEEKC uses microemulsion buffers instead of surfactants to separate solutes based on their hydrophobicity and electrophoretic characteristics. **Microemulsions** are solutions containing a dispersion of nanometer droplets of an immiscible liquid. The microemulsions used in MEEKC are oil droplets dispersed in an aqueous buffer. The oil and water components are totally immiscible and do not mix together, as there is a high surface tension between them. Therefore, the oil droplets are coated with a surfactant to reduce the surface tension between the two liquid layers and allow the emulsion to form. The surface tension is further lowered by the addition of a short-chain alcohol, such as butanol, which further stabilizes the microemulsion system. Such alcohols bridge the oil-and-water interface and further reduce the surface tension of the system to nearly zero (Marsh et al., 2004). If the microemulsion system was unstable, then it would revert to individual layers of oil and water after a short period of time. The diameter of the oil droplets thus formed is below 10 nm, so they do not scatter light, and the microemulsion is basically optically transparent.

As with MEKC, sodium dodecyl sulfate (SDS) is the most widely used emulsifier surfactant in MEEKC. The oil droplet is coated with SDS surfactant molecules making the droplet negatively charged. The C12 alkyl chain of the surfactant penetrates into the oil droplet, while the negatively charged hydrophilic sulfate groups reside in the surrounding aqueous phase. The basis for separation is similar to that in MEKC, where the surfactant monomers group together to form micelles, except that the use of microemulsions containing ionic surfactants allows chromatographic separation as solutes partition between the oil droplets and the aqueous buffer phase (Terabe et al., 1992). Water-insoluble compounds will favor inclusion in the oil droplet rather than in the buffer phase. This situation allows for the partitioning of the solute between the oil and water phases in a chromatographic fashion, where hydrophobic solutes will reside more frequently in the oil droplet than will water-soluble solutes. High-pH buffers such as borate or phosphate are generally used in MEEKC. These buffers generate a high EOF when a voltage is applied across a capillary filled with the buffer. This flow is relatively rapid and is toward the cathode situated near the detector. The surfactant-coated oil droplets are negatively charged and attempt to migrate toward the anode when the voltage is applied. However, if the EOF is sufficiently strong, the oil droplets will eventually move through the detector toward the cathode, carrying the hydrophobic compounds with them. Likewise, highly water-soluble or neutral solutes will reside predominantly in the aqueous phase and will move rapidly toward the detector through the influence of the EOF.

MEEKC has been used for a wide variety of separations and analyses and is broadly applicable to most plant-derived compounds. Thus, it is an important technique in natural product analysis. It has been used to assess the solubility or hydrophobicity of various compounds, including neutral, anionic,

and cationic solutes. Consequently, it can be used to characterize vitamins and other drugs. Vitamins are classified into either water- or fat-soluble compounds. The water-soluble acidic vitamins, such as nicotinic acid and vitamin C, possess an acidic function, allowing them to be analyzed using CZE. However, the fat-soluble vitamins, such as vitamins A and E, are neutral and have poor water solubility, thus requiring the use of chromatographic methods. MEEKC, however, was shown to be useful for the simultaneous determination of both water- and fat-soluble vitamins (Altria, 1999). Likewise, basic drugs can interact with the surface silanols on the stationary phases used in HPLC and CZE, which can lead to tailing and loss of separation efficiency. Highly efficient MEEKC separations of a range of water-soluble and insoluble basic drugs, such as terbutaline, bupivacaine, salmeterol, and amitryline, were performed with no evidence of peak tailing (Altria, 1999). A range of water-soluble and insoluble acidic drugs was also resolved using MEEKC, including cephalosporins, acetylsalicylic acid, and insoluble drugs such as ibuprofen, indomethacin, and troglitazone.

Using an SDS–octane–butanol microemulsion system, MEEKC was applied to the separation of highly insoluble compounds, such as diphenyl hydrazine derivatives and phenylurea herbicides (Song et al., 1995). Likewise, polyaromatic hydrocarbons are generally difficult to analyze by CE due to their neutral charge and low water solubilities. However, MEEKC has efficiently separated simple aromatic solutes, such as naphthol and toluene, using an SDS–heptane–butanol microemulsion system (Terabe et al., 1992). Such systems also work to separate a wide range of pharmaceuticals (analgesics and cold medicine ingredients); ketones such as acetylacetone, benzoylacetone, acetophenone, and benzyoyltrifluoroacetone; as well as proteins (Zhou et al., 1999). Proteins are generally too large to partition into a micelle but can partition into the microemulsion droplet, which has a larger volume. The MEEKC method could resolve both basic and acidic proteins and was applied to the analysis of a range of injection formulations containing various protein mixtures.

Hop bitter acids are present in the hops used to manufacture beer. The levels and composition of these acids affect hop quality and are tested before the hops are used in beer manufacture. It was shown that MEEKC produces accurate and precise data for this type of analysis (Vanhoenacker et al., 2000). Resolution of the six major hop acids was achieved with high efficiency within only 10 min. Even problematic cardiac glycosides were separated using MEEKC (Debusschère et al., 1997). This class of natural product compounds includes highly insoluble, neutral digoxin that is extracted from foxglove (*Digitalis purpurea*) plants.

#### 8.5.4.2 Selecting the Mode of Capillary Electrophoresis

The following table can be used as a rough guide to help select the most advantageous mode of CE as a starting point in methods development. The techniques are listed in order of the best likely technique for a given type of compound. Emphasis is loosely placed on the most simplistic method. However, the more complicated methods may give overall better results once the time has been taken to optimize the method for a specific separation.

**TABLE 8.6**

Selecting the Mode of Capillary Electrophoresis

Small Ions	Small Molecules	Oligonucleotides	RNA/DNA	Peptides	Proteins
CZE	CEC	CGE	CGE	CZE	CZE
CEC	MEKC	MEKC		MEKC	CGE
cITP	MEEKC			MEEKC	MEEKC
cIEF	CZE			cIEF	cIEF
	cITP			CGE	cITP
	cIEF			CEC	
				cITP	

*Note:* Capillary zone electrophoresis (CZE); capillary gel electrophoresis (CGE); capillary isoelectric focusing (cIEF); capillary isotachopheresis (cITP); capillary electrochromatography (CEC); micellar electrokinetic chromatography (MEKC); microemulsion electrokinetic chromatography (MEEKC).



---

### An Example to Approaches in Methods Development for Capillary Electrophoresis (CE)

Using a guide such as Table 8.6 may help us narrow our choices of which mode of CE may be useful for a compound of interest. However, from the descriptions in the above sections, it should be clear that separations using capillary electrophoresis have a wide range of considerations. Before you attempt a new separation, it is important to ask some fundamental questions about the compound of interest:

1. Is the compound soluble in water at concentrations up to 1 mg·ml<sup>-1</sup>?
2. If aqueous solubility is a problem, will small amounts of methanol or acetonitrile solubilize it?
3. Will small molecules solubilize if SDS is added to the buffer?
4. Is the compound soluble at specific pHs?
5. Is the compound unstable at certain pHs?
6. Is the compound thermally labile?
7. For proteins, will urea or another additive, such as ethylene glycol, help during the separation?
8. What type of detector will be required for the concentration of the compound to be used?
9. If using UV detection, what is the wavelength of maximum UV absorption of the compound?
10. How many components are expected in the mixture?
11. What is the concentration expected of each component?

Assessing these and additional questions will go a long way in determining what mode of CE will work best. However, additional criteria will be encountered depending on the mode of CE chosen. As examples, we give some general criteria on which to base a separation method for CZE as well as MEKC for comparison.

### Developing a Method by CZE

A great number of options and tools for methods development are available for CZE (Nielsen and Rickard, 1990). In this example, several processes for separating a new protein by CZE will be considered. For starting conditions, use a 75 cm capillary run at 25°C at 20 kV with the detector set at 214 nm. Make a 1 s injection of a 1 mg·ml<sup>-1</sup> solution of the protein, and use a 100 mM buffer at the appropriate pH. Other considerations are as follows:

1. Acid-stable protein — use a buffer pH below the protein's pI; acid-labile protein — select a pH at least 1 unit above the protein's pI.
2. Solubility problem — add a modifier such as urea or ethylene glycol to the buffer.
3. Adsorption problem — use an additive such as a sulfonic acid, a salt, or switch to a treated capillary.
4. Good efficiency, poor separation — adjust the pH of the buffer.
5. Poor efficiency — increase the ionic strength of the buffer or add a salt in which the protein is stable.

In many cases, you will be able to get a good separation in a relatively short time frame. Some samples may be quite difficult, and you may have to spend considerable time carefully selecting buffers and buffer additives.

### Developing a Method by MEKC

MEKC is a good separation mechanism for small molecules. However, proteins are not well separated by this technique. Good starting conditions are 100 mM SDS in pH 7 (50 mM phosphate-borate buffer) after which adjustments in SDS concentration, pH, and organic modifier may be necessary. Some considerations are as follows:

1. Long separation times, good resolution — increase the pH of the buffer or decrease the SDS concentration.
2. Long separation times, poor resolution — use an organic modifier in the buffer.
3. Short separation times, poor resolution — increase the SDS concentration.
4. Short separation times, moderate resolution — decrease the pH of the buffer or increase the SDS concentration.

The use of the organic modifier is especially powerful in MEKC. Acetonitrile is the solvent of first choice, because it has little impact on the EOF. Alcohols may also be useful, but the separation times can become lengthy. Under the proper conditions, the resolving power and peak capacity of MEKC far exceed HPLC. It takes no more than a few days to develop most separations.

---

## 8.6 Conclusions

Bioseparation of natural products from plants can be relatively simple and inexpensive when applied to the preparation of natural and whole foods, herbal medicines, teas, and plant dyes. Most of these protocols involve hot or cold water extractions; preparation of salves, ointments, and decoctions; and the making of alcohol/water tinctures. No sophisticated laboratory equipment is needed. Such extractions are the cornerstone of folk medicine, preparation of home remedies, and natural plant dyeing of wool and other fibers.

In contrast, when there is a need to identify particular constituents and their amounts in cell fractions, cells, tissues, organs (e.g., roots, stems, leaves, flowers, and fruits), and whole plants (e.g., seeds, seedlings, adult plants, or mycelial and cell cultures), one must employ many different chemical and physical separation methods. These may include grinding tissues in liquid nitrogen, centrifugations, Soxhlet extractions, freeze-drying, column and silica gel thin-layer chromatography, high-performance liquid chromatography, gas chromatography, and a variety of modes of electrophoresis. The extremely sensitive analytical equipment of MS and NMR spectroscopy will be considered in Chapter 9.

As alluded to in the sections on capillary electrophoresis, miniaturization of the separation equipment combined with highly sensitive analytical equipment has some distinct advantages in that very small quantities of sample can be characterized quite effectively. The relatively new field of nanotechnology is predicted to impact analytical chemistry/natural products separation technology to a large extent in the future. Already, separations are being performed with “lab-on-a-chip” technology to examine, for example, nucleotides in DNA and RNA preps, amino acids and small molecular weight peptides in proteins, sugars in complex carbohydrates, and a host of secondary metabolites that include terpenes, lectins, plant hormones, alkaloids, and plant pigments. Applications of such technology will soon be seen with wines, dyes, natural product-based medicines, natural insecticides and fungicides, foods, organic fertilizers, diseased tissue samples, soils, microbe samples, blood samples, and human-based fluid and tissue samples.

---

## References

- Albin, M., R. Weinberger, E. Sapp, and S. Moring. (1991). Fluorescence detection in capillary electrophoresis: evaluation of derivatizing reagents and techniques. *Anal Chem* 63: 417–422.

- Altria, K.D. (1999). Application of microemulsion electrokinetic chromatography to the analysis of a wide range of pharmaceuticals and excipients. *J Chromatogr* 844: 371–386.
- Aman, R., R. Carle, J. Conrad, U. Beifuss, and A. Schieber. (2005). Isolation of carotenoids from plant materials and dietary supplements by high-speed counter-current chromatography *J Chromatogr A* 1074: 99–105.
- Ambrosino, P., R. Fresa, V. Fogliano, S.M. Monti, and A. Ritieni. (1999). Extraction of azadirachtin A from neem seed kernels by supercritical fluid and its evaluation by HPLC and LC/MS. *J Agric Food Chem* 47: 5252–5256.
- Ashraf-Khorassani, M. and L.T. Taylor. (2004). Sequential fractionation of grape seeds into oils, polyphenols, and procyanidins via a single system employing CO<sub>2</sub>-based fluids. *J Agric Food Chem* 52: 2440–2444.
- Baker, G.R., R.F. Lowe, and I.A. Southwell. (2000). Comparison of oil recovered from tea tree leaf by ethanol extraction and steam distillation. *J Agric Food Chem* 48: 4041–4043.
- Bates, R.B., W.A. Haber, W.N. Setzer, and C.C. Stessman. (1999). Cyclic hemiacetals with seven-membered rings from an undescribed *Salacia* species from Monteverde, Costa Rica. *J Nat Prod* 62: 340–341.
- Bonoli, M., E. Marconi, and M. Fiorenza Cabon. (2004). Free and bound phenolic compounds in barley (*Hordeum vulgare* L.) flours: evaluation of the extraction capability of different solvent mixtures and pressurized liquid methods by micellar electrokinetic chromatography and spectrophotometry. *J Chromatogr A* 1057: 1–12.
- Brachet, A., P. Christen, and J.L. Veuthey. (2002). Focused microwave-assisted extraction of cocaine and benzoylecgonine from coca leaves. *Phytochem Anal* 13: 162–169.
- Bruno, T.J. (1991). *Chromatography and Electrophoretic Methods*. Prentice-Hall, Englewood Cliffs, New Jersey.
- Castola, V., B. Marongiu, A. Bighelli, C. Floris, A. Lai, and J. Casanova. (2005). Extractives of cork (*Quercus suber* L.): chemical composition of dichloromethane and supercritical CO<sub>2</sub> extracts. *Ind Crops Prod* 21: 65–69.
- Chen, S.S. and M. Spiro. (1994). Study of microwave extraction of essential oil constituents from plant materials. *J Microwave Power Electromagn Energy* 29: 231–241.
- Chen, S.S. and M. Spiro. (1995). Kinetics of microwave extraction of rosemary leaves in hexane, ethanol and a hexane + ethanol mixture. *Flavour Fragrance J* 10: 101–112.
- Cseke, L., P. Kaufman, G.K. Podila, and C.-J. Tsai. (2004). *Handbook of Molecular and Cellular Methods in Biology and Medicine*, 2nd ed, CRC Press, Boca Raton, Florida.
- da Costa, C.T., S.A. Margolis, B.A. Benner, and D. Horton. (1999). Comparison of methods for extraction of flavanones and xanthenes from the root bark of the osage orange tree using liquid chromatography. *J Chromatogr A* 831: 167–178.
- da Cruz, F.J., E.P. Jarvenpaa, R. Huopalahti, and B. Sivik. (2001). Comparison of *Eucalyptus camaldulensis* Dehn. oils from Mozambique as obtained by hydrodistillation and supercritical carbon dioxide extraction. *J Agric Food Chem* 49: 2339–2342.
- Dai, J., V.A. Yaylayan, G.S.V. Raghavan, and J.R. Pare. (1999). Extraction and colorimetric determination of azadirachtin-related limonoids in neem seed kernel. *J Agric Food Chem* 47: 3738–3742.
- Dai, J., V.A. Yaylayan, G.S.V. Raghavan, J.R. Pare, Z. Liu, and J.M.R. Belanger. (2001). Influence of operating parameters on the use of the microwave-assisted process (MAP) for the extraction of azadirachtin-related limonoids from neem (*Azadirachta indica*) under atmospheric pressure conditions. *J Agric Food Chem* 49: 4584–4588.
- Debusschère, L., C. Demesmay, J.L. Rocca, G. Lachatre, and H. Lofti. (1997). Separation of cardiac glycosides by micellar electrokinetic chromatography and microemulsion electrokinetic chromatography. *J Chromatogr A* 779: 227–233.
- Diaz-Maroto, M.C., M.S. Perez-Coello, and M.D. Cabezudo. (2002). Supercritical carbon dioxide extraction of volatiles from spices: comparison with simultaneous distillation-extraction. *J Chromatogr A* 947: 23–29.
- Dudareva, N., L. Cseke, M.B. Blanc, and E. Pichersky. (1996). Evolution of floral scent in *Clarkia*: novel patterns of *S*-linalool synthase gene expression in the *C. breweri* flower. *The Plant Cell* 8: 1137–1148.
- Fulzele, D.P. and R.K. Satdive. (2005). Comparison of techniques for the extraction of the anti-cancer drug camptothecin from *Nothapodytes foetida*. *J Chromatogr A* 1063: 9–13.

- Gu, M., S. Zhang, Z. Su, Y. Chen, and F. Ouyang. (2004). Fingerprinting of *Salvia miltiorrhiza* Bunge by non-aqueous capillary electrophoresis compared with high-speed counter-current chromatography. *J Chromatogr A* 1057: 133–140.
- Hao, J.Y., W. Han, S.D. Huang, B.Y. Xue, and X. Deng. (2002). Microwave-assisted extraction of artemisinin from *Artemisia annua* L. *Sep Purif Technol* 28: 191–196.
- Heftmann, E. (1992a). *Fundamentals and Techniques in Chromatography*, 5th ed., Part A, *Journal of Chromatography Library*, 51A. Elsevier, New York.
- Heftmann, E. (1992b). *Applications in Chromatography*, 5th ed., Part B, *Journal of Chromatography Library*, 51B. Elsevier, New York.
- Herrero, M., D. Arráez-Román, A. Segura, E. Kenndler, B. Gius, M.A. Raggi, E. Ibáñez, and A. Cifuentes. (2005). Pressurized liquid extraction–capillary electrophoresis–mass spectrometry for the analysis of polar antioxidants in rosemary extracts. *J Chromatogr A* 1084: 54–62.
- Honda, S. (1996). Separation of neutral carbohydrates by capillary electrophoresis. *J Chromatogr A* 720: 337–351.
- Hromadkova, Z., A. Ebringerova, and P. Valachovic. (1999). Comparison of classical and ultrasound-assisted extraction of polysaccharides from *Salvia officinalis* L. *Ultrasonics Sonochem* 5: 163–168.
- Hromadkova, Z., A. Ebringerova, and P. Valachovic. (2002). Ultrasound-assisted extraction of water-soluble polysaccharides from the roots of valerian (*Valeriana officinalis* L). *Ultrasonics Sonochem* 9: 37–44.
- Huang, X., Shear, J.B., and Zare, R.N. (1990). Quantitation of ribonucleotides from base-hydrolyzed RNA using capillary zone electrophoresis. *Anal Chem* 62: 2049–2051.
- Ikeda, Y., Y. Fujii, I. Nakaya, and M. Yamazaki. (1995). Quantitative HPLC analysis of cardiac glycosides in *Digitalis purpurea* leaves. *J Nat Prod* 58: 897–901.
- Ito, Y. (2005). Golden rules and pitfalls in selecting optimum conditions for high-speed counter-current chromatography. *J Chromatogr A*, 1065: 145–168.
- Kohler, M., W. Haerdi, P. Christen, and J.L. Veuthey. (1997). Extraction of artemisinin and artemisinin acid from *Artemisia annua* L. using supercritical carbon dioxide. *J Chromatogr A* 785: 353–360.
- Komolpis, K., P. Kaufman, and H.Y. Wang. (1998). Chemical permeabilization and *in situ* removal of daidzein from biologically viable soybean (*Glycine max*) seeds. *Biotechnol Tech* 12: 697–700.
- Lang, Q. and C.M. Wai. (2001). Supercritical fluid extraction in herbal and natural product studies — a practical review. *Talanta* 53: 771–782.
- Liu, R., Q. Sun, A. Sun, and J. Cui. (2005). Isolation and purification of coumarin compounds from *Cortex fraxinus* by high-speed counter-current chromatography. *J Chromatogr A* 1072: 195–199.
- Marongiu, B., A. Piras, and S. Porcedda. (2004). Comparative analysis of the oil and supercritical CO<sub>2</sub> extract of *Elettaria cardamomum* (L.) Maton. *J Agric Food Chem* 52: 6278–6282.
- Marsh, A., B. Clark, M. Broderick, J. Power, S. Donegan, and K. Altria. (2004). Recent advances in microemulsion electrokinetic chromatography. *Electrophoresis* 25: 3970–3980.
- Mattina, M.J.I., W.A.I. Berger, and C.L. Denson. (1997). Microwave-assisted extraction of taxanes from *Taxus* biomass. *J Agric Food Chem* 45: 4691–4696.
- McLaughlin, G., R. Palmieri, and K. Anderson. (1991). Benefits of automation in the separation of biomolecules by high performance capillary electrophoresis. In *Techniques in Protein Chemistry II*, J.J. Villafraña (Ed.). Academic Press, New York, pp. 3–19.
- Molnár-Perl, I. and Z. Füzfa. (2005). Chromatographic, capillary electrophoretic and capillary electrochromatographic techniques in the analysis of flavonoids. *J Chromatogr A* 1073: 201–227.
- Mukhopadhyay, M. (2000). *Natural Extracts Using Supercritical Carbon Dioxide*. CRC Press, Boca Raton, Florida.
- Nielsen, R.G. and E.C. Rickard. (1990). Method optimization in capillary zone electrophoretic analysis of hGH tryptic digest fragments. *J Chromatogr* 516: 99–114.
- Nishi, H., T. Fukuyama, M. Matsuo, and S. Terabe. (1990). Separation and determination of the ingredients of a cold medicine by micellar electrokinetic chromatography with bile salts. *J Chromatogr* 498: 313–323.
- Nyiredy, Sz., C.A.J. Erdelmeier, B. Meier, and O. Sticher. (1985a). “PRISMA” — Optimierung der mobilen phase in der präparativen CLC. *Chromatographie Suppl* 4: 24–30.
- Nyiredy, Sz., C.A.J. Erdelmeier, B. Meier, and O. Sticher. (1985b). “PRISMA”: Ein Modell zur Optimierung der mobilen phase für die Dünnschichtchromatographie, vorgestellt anhand verschiedener Naturstofftrennungen. *Planta Med* 51: 241–246.

- Ody, P. (1993). *The Complete Medicinal Herbal*. Dorling Kindersley, London.
- Ody, P. (1993). Herbal remedies. In *The Complete Medicinal Herbal*, P. Ody (Ed.). Dorling Kindersley, London, pp. 116–127.
- O'Farrell, P.H. (1975). High resolution two-dimensional electrophoresis of proteins. *J Biol Chem* 250(10): 4007–4021.
- Palma, M. and C.G. Barroso. (2002). Ultrasound-assisted extraction and determination of tartaric and malic acids from grapes and winemaking by-products. *Analyt Chim Acta* 458: 119–130.
- Pan, X., G. Niu, and H. Liu. (2002). Comparison of microwave-assisted extraction and conventional extraction techniques for the extraction of tanshinones from *Salvia miltiorrhiza* bunge. *Biochem Eng J* 12: 71–77.
- Pan, X., H. Liu, G. Jia, and Y.Y. Shu. (2000). Microwave-assisted extraction of glycyrrhizic acid from licorice root. *Biochem Eng J* 5: 173–177.
- Paulus, A. and A. Klockow. (1996). Detection of carbohydrates in capillary electrophoresis. *J Chromatogr A* 720: 353–376.
- Poole, C.F. and S.K. Poole. (1991). *Chromatography Today*. Elsevier, New York.
- Porath, J. (1988). High performance immobilized-metal-ion affinity chromatography of peptides and proteins. *J Chromatogr* 443: 3–11.
- Qi, S., S. Cui, X. Chen, and Z. Hu. (2004). Rapid and sensitive determination of anthraquinones in Chinese herb using 1-butyl-3-methylimidazolium-based ionic liquid with  $\gamma$ -cyclodextrin as modifier in capillary zone electrophoresis. *J Chromatogr A* 1059: 191–198.
- Rasmussen, H.T. and H.M. McNair. (1990). Influence of buffer concentration, capillary internal diameter and forced convection on resolution in capillary zone electrophoresis. *J Chromatogr* 516: 223–231.
- Reverchon, E., G. Della Porta, and F. Senatore. (1995). Supercritical CO<sub>2</sub> extraction and fractionation of lavender essential oil and waxes. *J Agric Food Chem* 43: 1654–1658.
- Romdhane, M. and C. Gourdon. (2002). Investigation in solid–liquid extraction: influence of ultrasound. *Chem Eng J* 87: 11–19.
- Sáenz-López, R., P. Fernández-Zurbano, and M.T. Tena. (2004). Analysis of aged red wine pigments by capillary zone electrophoresis. *J Chromatogr A* 1052: 191–197.
- Salisova, M., S. Toma, and T.J. Mason. (1997). Comparison of conventional and ultrasonically assisted extractions of pharmaceutically active compounds from *Salvia officinalis*. *Ultrasonics Sonochem* 4: 131–134.
- Seger, C., H. Römpf, S. Sturm, E. Haslinger, P.C. Schmidt, and F. Hadacek. (2004). Characterization of supercritical fluid extracts of St. John's Wort (*Hypericum perforatum* L.) by HPLC-MS and GC-MS. *Eur J Pharm Sci* 21: 453–463.
- Setzer, W.N., M.C. Setzer, A.L. Hopper, D.M. Moriarity, G.K. Lehrman, K.L. Niekamp, S.M. Morcomb, R.B. Bates, K.J. McClure, C.C. Stessman, and W.A. Haber. (1998). The cytotoxic activity of a *Salacia* liana species from Monteverde, Costa Rica, is due to a high concentration of tingenone. *Planta Med* 64: 583.
- Shotipruk, A., P.B. Kaufman, and H.Y. Wang. (2001). Feasibility study of repeated non-lethal ultrasonic extraction of menthol from *Mentha X piperata*. *Biotechnol Prog* 17: 924–928.
- Shu, Y.Y., M.Y. Ko, and Y.S. Chang. (2003). Microwave-assisted extraction of ginsenosides from ginseng root. *Microchem J* 74: 131–139.
- Song, K.M., S.W. Park, W.H. Hong, H. Lee, S.S. Kwak, and J.R. Liu. (1992). Isolation of vindoline from *Catharanthus roseus* by supercritical fluid extraction. *Biotechnol Prog* 8: 583–586.
- Song, L., Q. Ou, W. Yu, and G. Li. (1995). Separation of six phenylureas and chlorsulfuron standards by micellar, mixed micellar and microemulsion electrokinetic chromatography. *J Chromatogr A* 699: 371–382.
- Terabe, S., N. Matsubara, Y. Ishihama, and Y. Okada. (1992). Microemulsion electrokinetic chromatography: comparison with micellar electrokinetic chromatography. *J Chromatogr* 608: 23–29.
- Thormann, W.J. (1990). Isotachopheresis in open-tubular fused-silica capillaries: impact of electroosmosis on zone formation and displacement. *Chromatography* 516: 211–217.
- Vanhoenacker, G., H. Rong, D. De Keukeleire, W. Baeyens, G. Van Der Weken, and P. Sandra. (2000). Simultaneous analysis of hop acids and prenylated flavanones by microemulsion electrokinetic chromatography with diode array detection. *Biomed Chromatogr* 14: 34–36.
- Vinatoru, M., M. Toma, O. Radu, P.I. Filip, D. Lazurca, and T.J. Mason. (1997). The use of ultrasound for the extraction of bioactive principles from plant materials. *Ultrasonics Sonochem* 4: 135–139.

- Wang, H.Y., K. Komolpis, P.B. Kaufman, P. Malakul, and A. Shotipruk. (2001). Permeabilization of metabolites from biologically viable soybeans (*Glycine max*). *Biotechnol Prog* 17: 424–430.
- Yan, J., G. Chen, S. Tong, Y. Feng, L. Sheng, and J. Lou. (2005). Preparative isolation and purification of germacrone and curdione from the essential oil of the rhizomes of *Curcuma wenyujin* by high-speed counter-current. *J Chromatogr A* 1070: 207–210.
- Yeung, E.S. and W.G. Kuhr. (1991). Indirect detection methods for capillary separations. *Anal Chem* 63: 275A–282A.
- Yin, H.F., A. Juergen, and G.J. Schomburg. (1990). Production of polyacrylamide gel filled capillaries for capillary gel electrophoresis (CGE): influence of capillary surface pretreatment on performance and stability. *High Resolution Chromatogr* 13: 624–627.
- Zhou, G.H., G.A. Luo, and X.D. Zhang. (1999). Microemulsion electrokinetic chromatography of proteins. *J Chromatogr* 853: 277–284.
- Zougagh, M., M. Valcarcel, and A. Rios. (2004). Supercritical fluid extraction: a critical review of its analytical usefulness. *Trends Anal Chem* 23: 399–405.



# 9

## *Characterization of Natural Products*

Bernhard Vogler and William N. Setzer

### CONTENTS

9.1	Introduction .....	320
9.2	Nuclear Magnetic Resonance (NMR) Spectroscopy .....	320
9.2.1	One-Dimensional Methods .....	320
9.2.1.1	NMR Parameters .....	320
9.2.1.2	Chemical Shift .....	321
9.2.1.3	Coupling .....	322
9.2.1.4	<sup>13</sup> C NMR .....	325
9.2.1.5	Other Nuclei .....	325
9.2.2	Two-Dimensional Methods .....	325
9.2.2.1	COSY .....	326
9.2.2.2	TOCSY .....	326
9.2.2.3	NOESY/ROESY .....	328
9.2.2.4	HSQC/HMQC .....	328
9.2.2.5	HMBC .....	329
9.2.2.6	HSQCTOCSY/HMQCTOCSY .....	330
9.2.3	Selective Excitation Methods .....	330
9.2.4	Illustrative Examples .....	330
9.2.4.1	Hydroquinine, C <sub>20</sub> H <sub>26</sub> N <sub>2</sub> O <sub>2</sub> .....	330
9.2.4.2	Camptothecin .....	338
9.2.4.3	Tingenone .....	344
9.2.4.4	Paclitaxel .....	347
9.3	Mass Spectrometry .....	355
9.3.1	Gas-Phase Ionization .....	355
9.3.1.1	Electron Ionization (EI) .....	355
9.3.1.2	Chemical Ionization (CI) .....	355
9.3.1.3	Field Desorption and Ionization .....	356
9.3.2	Particle Bombardment .....	356
9.3.2.1	Fast Atom Bombardment (FAB) .....	356
9.3.2.2	Secondary Ion Mass Spectrometry (SIMS) .....	357
9.3.3	Atmospheric Pressure Ionization .....	357
9.3.3.1	Electrospray Ionization (ESI) .....	357
9.3.3.2	Atmospheric Pressure Chemical Ionization (APCI) .....	357
9.3.4	Laser Desorption .....	357
9.3.4.1	Matrix-Assisted Laser-Desorption Ionization (MALDI) .....	357
9.3.5	Mass Analyzers .....	358
9.3.5.1	Scanning Mass Analyzers .....	358
9.3.5.2	Time-of-Flight (TOF) Mass Analyzer Spectrometer .....	358
9.3.5.3	Trapped-Ion Mass Analyzers .....	358
9.3.6	MS-MS Experiments .....	359
9.3.7	Illustrative Examples of EI Mass Spectra .....	359
9.3.7.1	Benzylalcohol .....	359
9.3.7.2	Germacrene D .....	361
9.3.7.3	α-Pinene .....	362



	9.3.7.4 Linalool .....	363
9.4	UV-Vis, IR Spectroscopy .....	364
	9.4.1 UV-Vis .....	364
	9.4.2 IR Spectroscopy .....	364
9.5	Hyphenated Techniques .....	365
	9.5.1 GC-MS .....	365
	9.5.1.1 <i>Solidago canadensis</i> (Goldenrod) Leaf Essential Oil .....	366
	9.5.1.2 <i>Randia matudae</i> Floral Essential Oil .....	368
	9.5.2 LC-MS .....	368
	9.5.2.1 <i>Ligusticum chuangxiang</i> .....	368
	9.5.2.2 <i>Vernonia fastigiata</i> .....	371
	9.5.3 LC-NMR .....	373
	9.5.3.1 Solvent Signals .....	373
	9.5.3.2 Stop-Flow Analysis .....	375
	9.5.3.3 <i>Stauranthus perforatus</i> .....	377
	9.5.3.4 <i>Fraxinus</i> spp. ....	377
	9.5.3.5 <i>Piper longum</i> .....	382
	9.5.4 LC-NMR-MS .....	385
9.6	Conclusions .....	385
	References .....	386

---

## 9.1 Introduction

The bottleneck in natural products chemistry generally is separation/purification of compounds of interest from complex mixtures and structure elucidation of those compounds. Separation was addressed in Chapter 8, and in this chapter, we address the problems of structure elucidation. The most important tools for structure elucidation of natural products are **nuclear magnetic resonance (NMR)** (Günther, 1995) and **mass spectroscopic (MS)** (de Hoffmann and Stroobant, 2002) techniques. In addition, **infrared (IR)** and **ultraviolet-visible spectrophotometric (UV-Vis)** methods are of importance. In this chapter, we present NMR and MS in some detail, as well as provide overviews of IR and UV-Vis. We also include hyphenated techniques such as gas chromatography (GC)-MS, liquid chromatography (LC)-MS, and LC-NMR. These techniques provide separation methods coupled with structural (spectroscopic) information. Although a very powerful analytical method, x-ray crystallography is not covered (Stout and Jensen, 1989).

---

## 9.2 Nuclear Magnetic Resonance (NMR) Spectroscopy

NMR spectroscopy has grown after its invention in the late 1940s into the most important tool for structure determination. The power of NMR spectroscopy lies in its ability not only to produce unique fingerprints for a particular compound, but also, to offer possibilities to explore these “fingerprints” with various NMR experiments in order to study the chemical environment of a particular atom within the molecule. This enables chemists to obtain a very detailed picture of a molecule. Even dynamic processes, such as the conformational space of molecules, can be studied in great detail.

### 9.2.1 One-Dimensional Methods

#### 9.2.1.1 NMR Parameters

**NMR spectroscopy** probes the magnetic properties of nuclei induced by their spin states. In order to see differences of these spin states, powerful magnets that are able to align spin states in their magnetic fields have to be used (Figure 9.1). Almost all elements of the periodic table have an isotope that is magnetically active. For the study of organic compounds, we can use this technique on compounds containing  $^1\text{H}$ ,  $^{13}\text{C}$ ,  $^{15}\text{N}$ , and  $^{31}\text{P}$ . All of these nuclei have nuclear spins of one-half, which means that they act as tiny magnets, and their magnetic vectors align in an external field either parallel or antiparallel

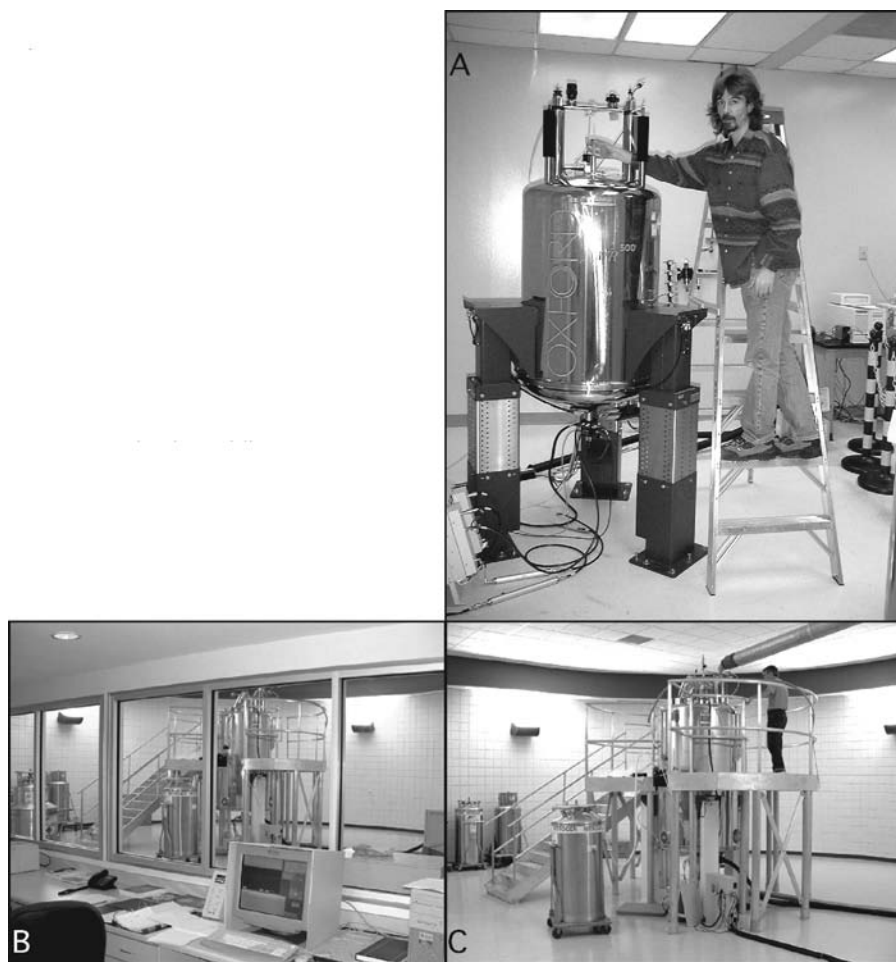

**FIGURE 9.1** Nuclear magnetic resonance (NMR) facility at the University of Alabama in Huntsville. (A) Dr. Bernhard Vogler shows the 500 MHz spectrometer. (B and C) The 800 MHz spectrometer facility with control room and lab ([www.bionmr.uah.edu/nmr/nmrlab.html](http://www.bionmr.uah.edu/nmr/nmrlab.html)). More sophisticated facilities such as these require a specialized building in which to house the equipment due to the intense magnetic fields.

to the field. Because there is a small energy difference associated with the parallel and antiparallel orientations, we can visualize the difference in energy by irradiation with the proper radiofrequencies. Note that the amount of splitting of the energy levels is different for each nucleus and is linearly dependent on the magnetic field. As a consequence, different nuclei can be observed at different radiofrequencies. For example, with a magnet with 11.7 Tesla field strength, the transitions of  $^1\text{H}$  are probed at 500 MHz, whereas  $^{13}\text{C}$  are studied at 125 MHz. This is a major advantage of NMR spectroscopy and allows us to separate proton information from carbon information. Due to the differences in frequencies, we can observe  $^1\text{H}$  or  $^{13}\text{C}$  by choosing the proper frequency. The drawback of NMR spectroscopy is its inherent low sensitivity compared to other spectroscopic methods. Furthermore, for a number of important nuclei, the most abundant isotope is not NMR active. Thus, for example,  $^{12}\text{C}$  is the most abundant isotope of carbon, but it is not NMR active. We lose, therefore, even more sensitivity due to the fact that we can observe only 1.1% of the sample, where the carbon is a  $^{13}\text{C}$ -isotopomer.

### 9.2.1.2 Chemical Shift

Important for the wide application of NMR spectroscopy is the fact that the frequencies of the aforementioned transitions not only depend on the strength of the magnet, but also, on the chemical environ-

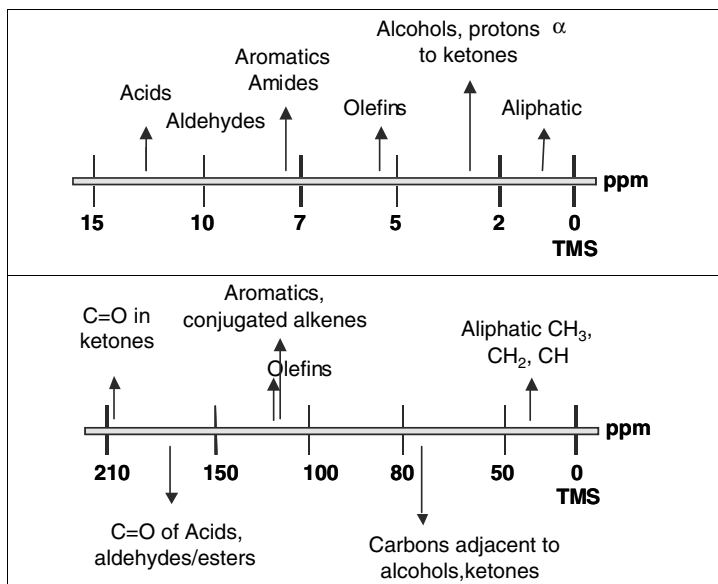

FIGURE 9.2 Typical shift ranges for various functional groups.

ment of the nucleus under study. Atoms in molecules are held together by chemical bonds formed by electrons. These electrons, dependent on the nature of their bonds, then produce different magnetic fields that are small compared to the external magnetic field. Different nuclei within a molecule then “feel” different overall magnetic fields (effective field = external magnetic field + local magnetic field), and hence, they resonate at different frequencies. We call this effect **chemical shift** because the differences in frequencies can be directly correlated to differences in chemical environments. In order to account for the different magnetic fields, we introduce a frequency-independent scale. We choose a reference compound, **tetramethylsilane (TMS)**, as our artificial starting point, and calculate the chemical shift according to the following formula:

$$\text{Chemical shift } \delta \text{ (ppm)} = \frac{\text{Frequency of nucleus under study} - \text{Frequency of TMS}}{\text{Frequency of TMS}}$$

In  $^1\text{H}$  NMR, this results in differences of about 10 ppm.  $^{13}\text{C}$  chemical shift differences fall into a range of 220 ppm (see Figure 9.2).

### 9.2.1.3 Coupling

So far, we introduced only the influence of the electrons of the chemical bonds. If we now also take into consideration that within a molecular framework, a nucleus is not only influenced by the local magnetic fields produced by electrons, but also, by local fields produced by other nuclei (remember that each nucleus is a little magnet), we obtain an additional factor that influences our NMR spectra. It turns out that the influence of neighboring nuclei is even smaller than the influence stemming from electrons. So, we obtain signals with a fine splitting.

#### 9.2.1.3.1 Scalar Couplings

**Scalar couplings** are a result of neighborhood information transmitted through the bonding framework. Consider the  $^1\text{H}$ -NMR spectrum of ethanol,  $\text{CH}_3\text{CH}_2\text{OH}$  (Figure 9.3).

In that spectrum, we can distinguish two types of protons — the  $\text{CH}_3$  and the  $\text{CH}_2$  groups, which are further split into three lines, and four lines, respectively. The difference in chemical shift ( $\text{CH}_3 = 1.19$  ppm and  $\text{CH}_2 = 3.65$  ppm) can be explained through the difference of the chemical environment — the

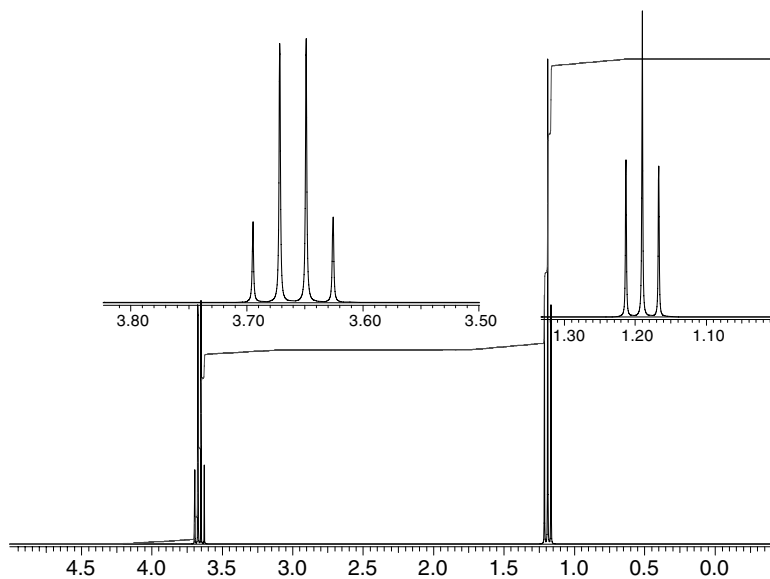

FIGURE 9.3 <sup>1</sup>H-NMR spectrum of ethanol taken at 300 MHz.

CH<sub>2</sub> group has one strongly electronegative bonding partner, the oxygen of the OH, whereas the CH<sub>3</sub> group has only an alkane-type environment. The splitting of the signals into a number of lines can be explained as follows. Assuming that the protons of the CH<sub>2</sub> group and the CH<sub>3</sub> group line up with the external field, and because we observe more than one molecule at a time, we have the situation where the magnetic field vectors of the CH<sub>3</sub> group line up in a well-defined combination with respect to the orientation of the magnetic field vector of the CH<sub>2</sub> group (Figure 9.4). Because there are three proton spins in the CH<sub>3</sub> group, there are eight possible alignment combinations ( $2^3 = 8$ ). With respect to the

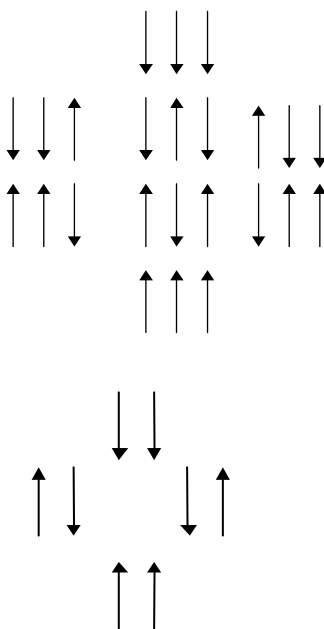

FIGURE 9.4 Influence of neighbor spins.

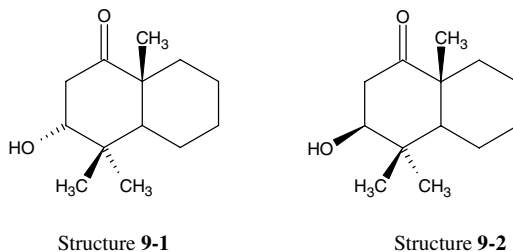

FIGURE 9.5 Diastereomeric alcohols.

overall magnetic field, there are four energetically different situations, because some of the combinations are degenerate. So, a quartet is produced. We can also see that the number of possible combinations with the same energy is the same as the relative intensity of the four lines as displayed in the spectrum (i.e., 1:3:3:1). Likewise, when we observe the protons of the  $\text{CH}_3$  group, only certain combinations are allowed for the magnetic field vector of the neighboring  $\text{CH}_2$  group. Here we get four possible combinations, which results in three energetically different magnetic fields because two are degenerate (i.e., a 1:2:1 triplet). Note that we treated the protons of either the methyl group or the methylene group as chemically equivalent, so the splitting pattern tells us the number of chemically equivalent neighboring protons; in other words, the neighborhood of a proton is reflected in the shape of its signal, which is a very powerful tool to use to “walk” through our molecule. Couplings typically can be observed for geminal and vicinal protons, which means that they are two bonds or three bonds away from each other, respectively. In cases where we have double bonds or special geometrical features, we sometimes observe coupling through four or more bonds. The more bonds there are between protons, the less likely we are to observe a coupling. In addition, the magnitude of the coupling in our fine splitting is dependent on the dihedral angle between the two protons coupling with each other. In the case of open chain compounds, as in ethanol, we see an averaged spectrum for all possible conformations. In cases where other factors limit the conformation of molecules, such as in ring compounds, we have a very sensitive tool with which to determine relative stereochemistry. For example, if we inspect the situation in the diastereomeric model compounds shown in Figure 9.5, we see differences for the proton attached at the alcoholic carbon.

In a three-dimensional view, this proton has different dihedral angles with its neighboring methylene protons. For compound **9-1**, the proton has about the same dihedral angle ( $60^\circ$ ) to both methylene protons, whereas in compound **9-2**, there is one proton at an angle of about  $180^\circ$ , and a second proton at about  $60^\circ$ . This results in different coupling constants, twice a coupling of 4 Hz in the first case (to give a triplet), and coupling constants of 12 Hz and 4 Hz in the second case (to give a doublet of doublets; see Figure 9.6). In  $^{13}\text{C}$  NMR, scalar coupling is not observed because the probability of two carbons that are  $^{13}\text{C}$ -isotopomers being next to each other is very low ( $1.1 \times 10^{-2} \times 1.1 \times 10^{-2} = 1.21 \times 10^{-4}$ ). The low abundance of  $^{13}\text{C}$  is also the reason why we see  $^1\text{H}$ - $^{13}\text{C}$  couplings only to a limited extent in proton spectra, but we will see later that we use them heavily in heteronuclear-correlated two-dimensional (2D)-NMR spectroscopy.

### 9.2.1.3.2 Residual Dipolar Couplings

These couplings result from close proximity in space and are dependent on the distance between the two nuclei. Residual dipolar couplings do not result in additional line splitting. However, when we saturate the transition of one proton, then the intensities of protons in close proximity are changed. This effect is called **nuclear Overhauser effect (NOE)**. This phenomenon has been used very effectively to measure distances of nuclei within a molecule (complementing x-ray crystallography), so that we can get a distance map for a particular molecule. This, of course, is most interesting for molecules that have nuclei very close in space but that are separated through many bonds. Furthermore, nuclear Overhauser spectroscopy is often used to probe stereochemical features in ring systems. Here we use the simple fact

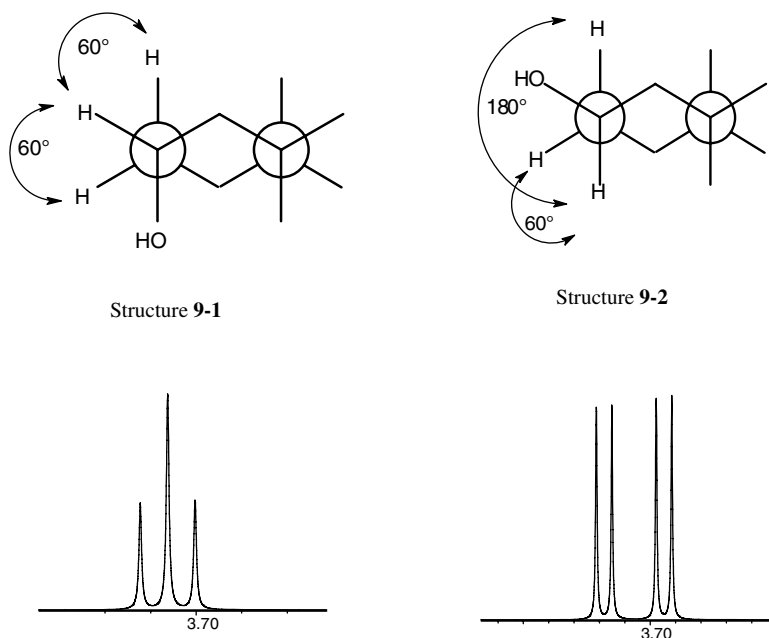

FIGURE 9.6 Dihedral angles and splitting patterns for compounds 9-1 and 9-2.

that protons on one side of the ring should be closer to each other, and therefore, show nuclear Overhauser enhancement if one of those protons gets irradiated. See examples below.

#### 9.2.1.4 $^{13}\text{C}$ NMR

The nuclear Overhauser effect is also of great importance for  $^{13}\text{C}$  NMR. Typically, we run  $^{13}\text{C}$  NMR as  $^1\text{H}$ -decoupled spectra. This means that we saturate the proton frequencies. As a consequence, we do not observe couplings between  $^{13}\text{C}$  and  $^1\text{H}$ , so the carbon spectra are just single lines. Furthermore, due to the NOE, the intensity of the carbon signals is further increased. Due to the decoupling, we obtain only chemical shift information, and  $^{13}\text{C}$ -NMR spectra are much easier to analyze. In order to get proton information (i.e., how many protons are attached to a carbon), we need to turn off the decoupling that would result in very little signal intensity, limit the decoupling through off-resonance decoupling, or use different mechanisms to determine the number of protons attached to a carbon. Techniques currently in widespread use are **DEPT (distortionless enhancement through polarization transfer)** or **APT (attached proton test)** spectra. In those spectra, data are collected in such a way that the resulting signal is either positive or negative, depending on the number of protons attached.

#### 9.2.1.5 Other Nuclei

Other nuclei that are important in natural products chemistry are  $^{31}\text{P}$  and  $^{15}\text{N}$ .  $^{15}\text{N}$  is especially useful when protein studies are performed. Because  $^{15}\text{N}$  also has a very low natural abundance, proteins are typically subjected to isotopic labeling before collecting NMR spectra.

### 9.2.2 Two-Dimensional Methods

Driven by the relatively small chemical shift differences in  $^1\text{H}$ -NMR spectroscopy, which lead to severe signal overlap, and hence, difficulties with spectral analyses with larger, more complex molecules, 2D-NMR techniques were developed. These techniques make great use of the coupling information inherent in all types of NMR spectra.

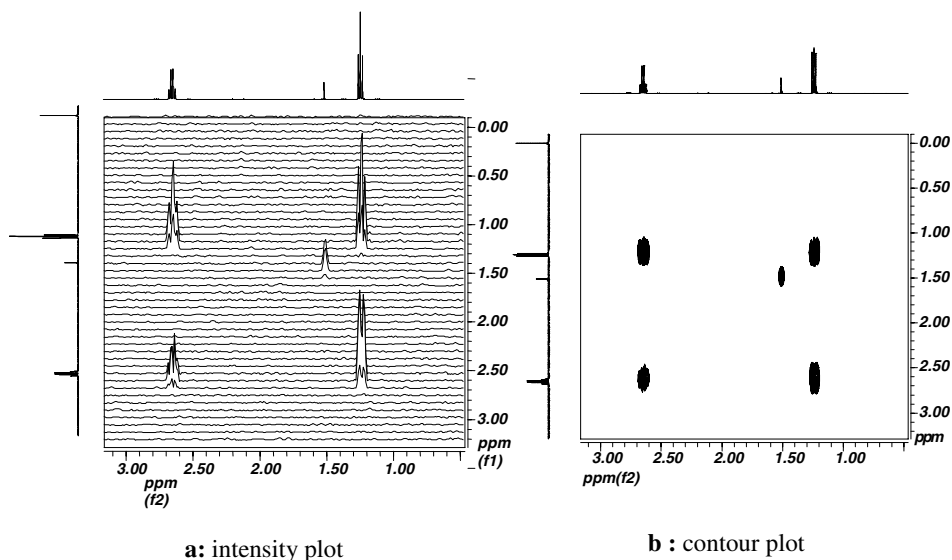

FIGURE 9.7 COSY spectrum of ethanol.

### 9.2.2.1 COSY

**Correlation spectroscopy (COSY)** is one of the oldest 2D methods. In COSY, which nowadays covers solely homonuclear  $^1\text{H}$ - $^1\text{H}$ -COSY, we correlate the different protons in our spectrum that are coupled to each other. In the COSY spectrum of ethanol, for example (see Figure 9.7), we see the correlation of the methyl with the methylene. The spectrum is now a two-dimensional intensity plot, where the normal spectrum is on the diagonal, and additional signals, the “cross-peaks,” appear whenever two protons with different shifts have a coupling in common (Figure 9.7a). For easier display, we generally plot this 2D spectrum as a contour plot, where the width of a certain signal is represented as an ellipsoid (Figure 9.7b).

### 9.2.2.2 TOCSY

**Total correlation spectroscopy (TOCSY)** goes one step further. Instead of correlating only one group of protons with another, we “walk” through a complete spin system of coupled protons. So, for example, with the help of TOCSY, we can “disentangle” the crowded region around  $\delta$  3.8 ppm in the  $^1\text{H}$  spectrum of sucrose (Figure 9.8). In the COSY spectrum (Figure 9.9), we can follow the coupling path 12345 easily. However, at this point, due to heavy overlap, we cannot make a decision as to how to proceed further.

In the TOCSY spectrum (Figure 9.10), the complete spin system  $1 \rightarrow 2 \rightarrow 3 \rightarrow 4 \rightarrow 5 \rightarrow 6$  and  $3' \rightarrow 4' \rightarrow 5' \rightarrow 6'$  are displayed as heavily coupling units (see squares). For H-1, which is separated from the other protons, we clearly see correlation peaks all the way to H-6 (trace). We now easily recognize the two spin systems, which overlap at 3.75 to 3.85 ppm. So, the power of TOCSY really lies in its ability to deal with situations where we have spectral overlap. Because sugars are very common in saponins, and their NMR spectra are in a relatively small range, TOCSY is an excellent method with which to assign the protons of each individual sugar component.

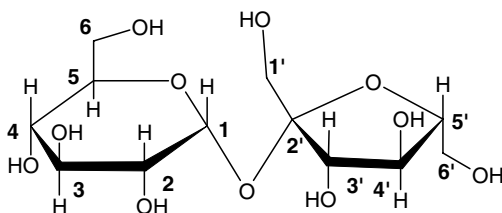

FIGURE 9.8 Structure of sucrose.

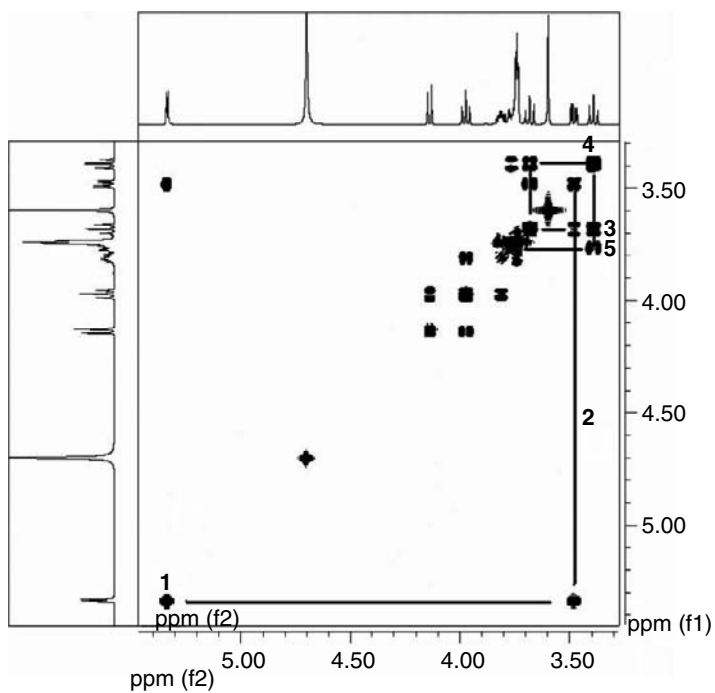

FIGURE 9.9 COSY spectrum of sucrose in D<sub>2</sub>O.

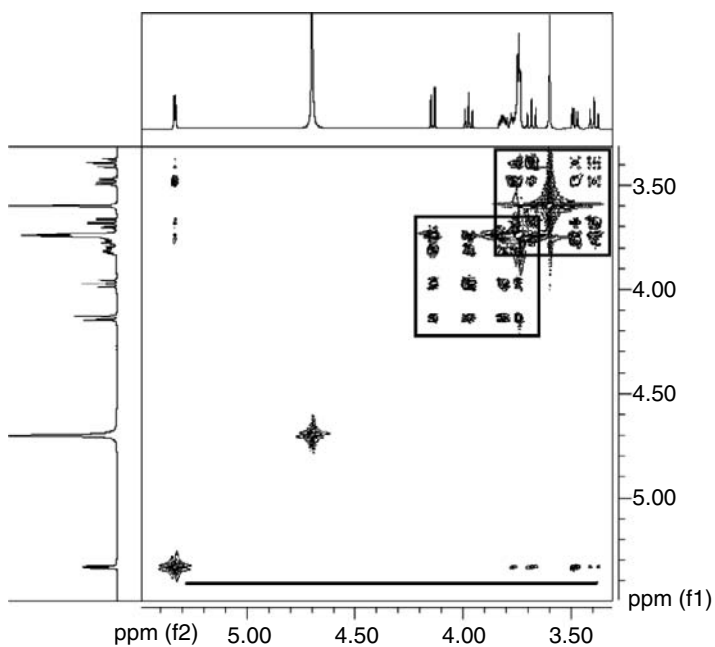

FIGURE 9.10 TOCSY spectrum of sucrose in D<sub>2</sub>O.



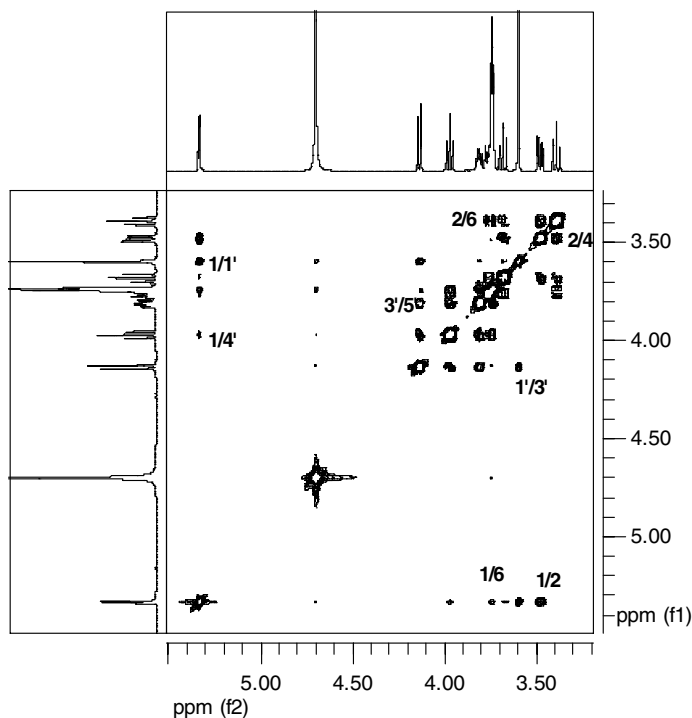

FIGURE 9.11 NOESY of sucrose.

### 9.2.2.3 NOESY/ROESY

Nuclear Overhauser effects are mostly measured as **nuclear Overhauser enhancement spectroscopy (NOESY)**; see Figure 9.11) or **rotating frame nuclear Overhauser enhancement spectroscopy (ROESY)**. The reason for two implementations is due to the dependence of the NOE on the molecular-weight-to-magnetic-field ratio. NOE strongly depends on the mobility of the molecule. For small molecules with a large mobility, we observe positive NOEs, which then with increasing molecular weight, decreasing mobility, pass through zero, finally ending up with negative NOEs. Unfortunately, the region where the NOE gets close to zero for 400 to 500 MHz spectrometers is in the molecular weight range where we see a number of interesting natural products, like triterpenoidal saponins and tannins (MW 600 to 900), for example. So-called spin-lock conditions, as used in ROESY, however, provide a solution to this problem. With the spin-lock, we observe NOE effects that are not dependent on molecular mobility. Spectra presented to users look similar to COSY or TOCSY spectra; however, the effect giving rise to cross-peaks is now due to residual dipolar couplings.

### 9.2.2.4 HSQC/HMQC

$^1\text{H}$ - $^{13}\text{C}$  correlations can be implemented in various ways. With older hardware, **heteronuclear-correlated (HETCOR)** spectra are measured, meaning that we measure carbon spectra that correlate to protons. Due to the lack of sensitivity of carbon, however, mostly HSQC or HMQC spectra are recorded where we measure proton spectra and use either **heteronuclear single-quantum coherence (HSQC)** or **heteronuclear multiquantum coherence (HMQC)** to see correlations (i.e., couplings) between protons and carbons. In all cases, we end up with a 2D spectrum with one axis displaying proton and one axis displaying carbon chemical shifts. HSQC and HMQC spectra offer, however, a huge sensitivity advantage over HETCOR. In many cases, it is possible to run HSQC/HMQC spectra on samples so minute that one-dimensional (1D)  $^{13}\text{C}$  spectra require considerably longer acquisition times. With respect to the information content, HSQC/HMQC spectra offer the advantage that due to the large chemical shift range of carbon, the proton spectroscopic information is spread out, and overlap is much less likely. One

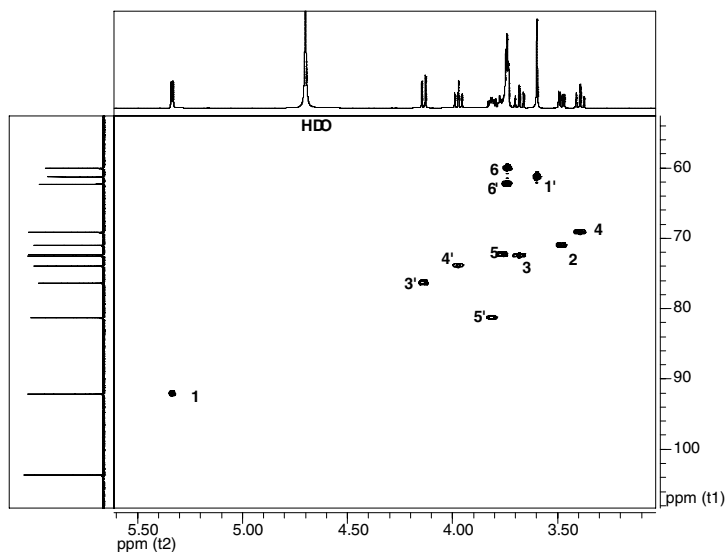

FIGURE 9.12 HSQC spectrum of sucrose.

example that demonstrates that nicely is the HSQC spectrum of sucrose (Figure 9.12). The region in the  $^1\text{H}$  spectrum between 3.7 ppm and 3.9 ppm shows many overlapping resonances. In the HSQC spectrum, the correlation peaks are spread out over 20 ppm in the carbon range. This also offers interesting structural information because a part of our structure is now characterized by two data points ( $^1\text{H}$ -shift and  $^{13}\text{C}$ -shift), which very often enables us to resolve ambiguous assignments.

#### 9.2.2.5 HMBC

In order to obtain information about quaternary carbons, we have to modify the HMQC measurement to see long-range couplings. C–H couplings over more than one bond ( $^2\text{J}$ ,  $^3\text{J}$ ) typically fall into the range of 0 to 25 Hz, whereas direct couplings ( $^1\text{J}$ ) have values between 100 and 200 Hz. Direct couplings are an order of magnitude larger, and this offers a way to filter them out. The following **heteronuclear multibond correlation (HMBC)** spectrum of sucrose (Figure 9.13) shows a cross-peak that establishes

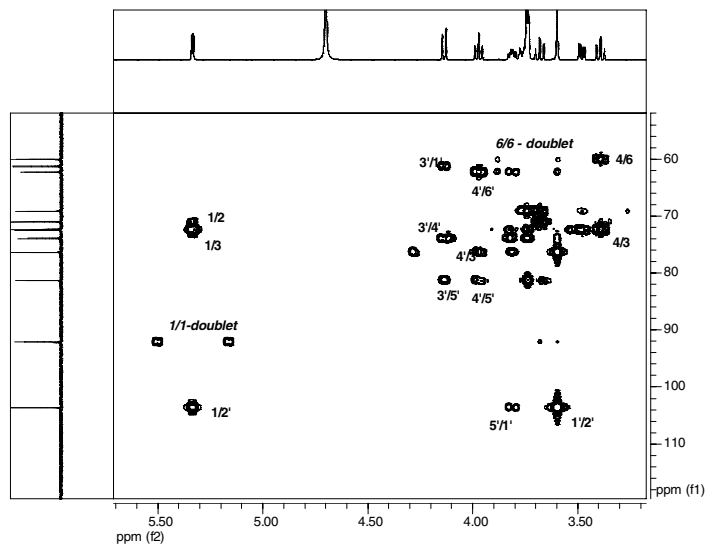

FIGURE 9.13 HMBC spectrum of sucrose. The labels indicate the proton/carbon coupling.

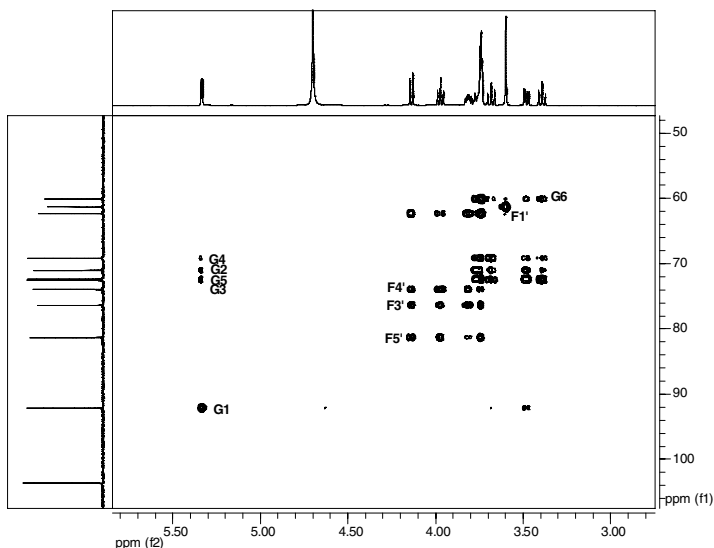

FIGURE 9.14 HSQCTOCSY of sucrose.

the connection of the anomeric proton of glucose to the quaternary ketal carbon of fructose. Note that for the same anomeric proton, we see two additional correlations. The one that is responsible for the direct coupling ( $^1J$ ) is exhibited as a doublet because we run HMBC without carbon decoupling. Apparently, the filtering method did not work properly here, most likely due to an unusual coupling constant. HMBC is used heavily to connect fragments already identified by COSY and HSQC spectra. Correlations observable in COSY typically end at quaternary carbons; so HMBC serves as an important tool to connect these “independent” spin systems with each other. Note that in the example of sucrose, we now also observe a correlation from the anomeric proton (H-1) of the glucose part to the ketal carbon (C-1) of the fructose part, thus giving spectroscopic proof that the two sugar units are connected.

### 9.2.2.6 HSQCTOCSY/HMQCTOCSY

Variations of the TOCSY experiment are the HSQCTOCSY and the HMQCTOCSY experiments. In these cases, we again take advantage of the larger chemical shift dispersions that the carbon spectra offer, and combine them with the power of TOCSY to probe complete spin systems. The two clusters of spins are labeled as  $G_{1-6}$  for the glucose part and  $F1'-F6'$  for the fructose part in the HSQCTOCSY of sucrose (Figure 9.14).

## 9.2.3 Selective Excitation Methods

There is also an opportunity to run the above-mentioned spectra as 1D versions. Good examples are 1D-TOCSY, 1D-NOESY, and 1D-ROESY. The advantage of the 1D version over the 2D version is the higher resolution that the 1D version offers. In cases where there are overlapping regions, that can be a way to “separate” overlapping peaks by selective irradiation and subsequent NOESY or TOCSY propagation. Since here we work with high-resolution 1D methods, in many cases, detailed  $^1H$  information is obtained even for heavily crowded areas. Using TOCSY, we can produce many different “subspectra” (see examples below).

## 9.2.4 Illustrative Examples

### 9.2.4.1 Hydroquinine, $C_{20}H_{26}N_2O_2$

The proton spectrum of hydroquinine (Figure 9.15 and Figure 9.16) shows 17 groups of signals.

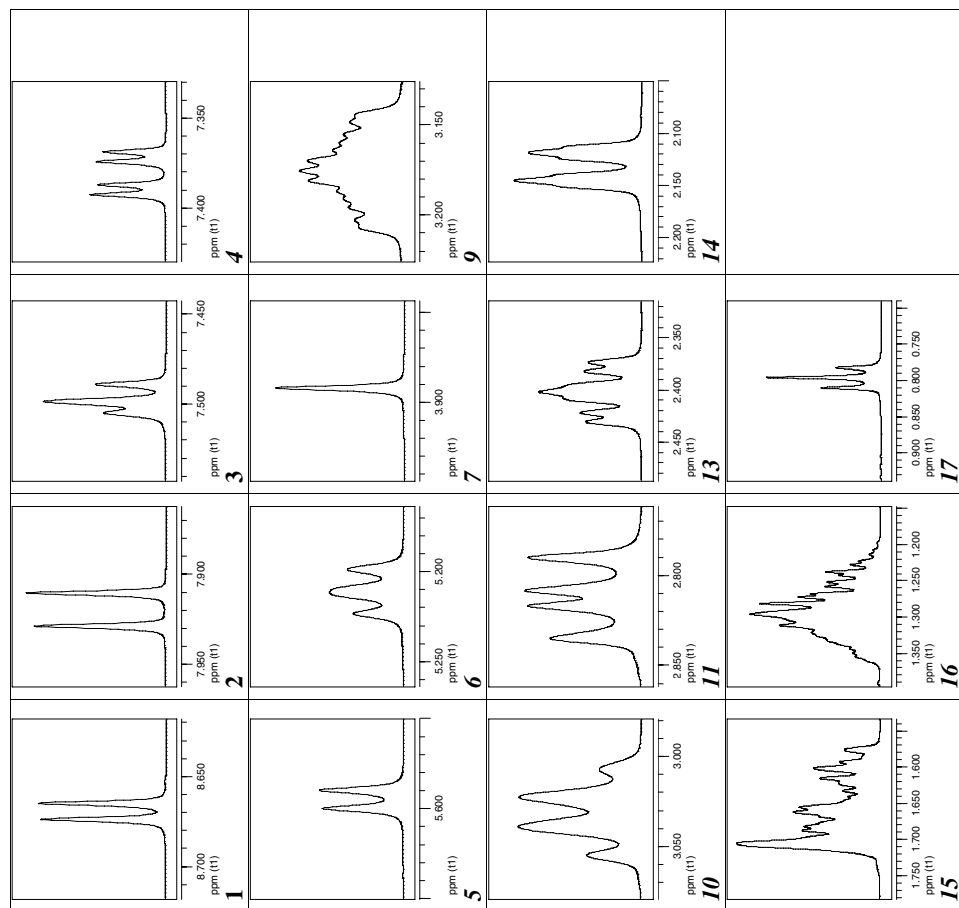

**FIGURE 9.16** Expansions of the 15 signals belonging to hydroquinine. The missing numbers are solvent signals.

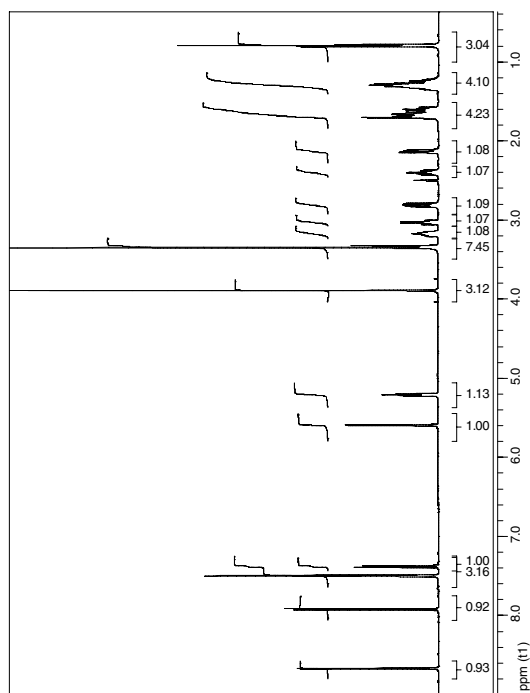

**FIGURE 9.15**  $^1\text{H-NMR}$  spectrum of hydroquinine in  $d_6$ -dimethylsulfoxide (DMSO).

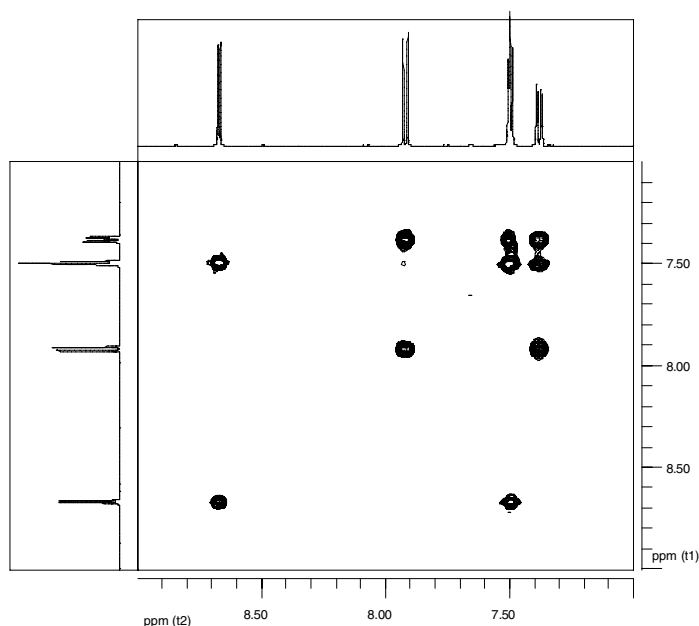

FIGURE 9.17 COSY spectrum of the aromatic portion of hydroquinine.

The situation is somewhat complicated because we have overlap of a number of protons (signals 15 and 16), as indicated through fairly complicated patterns and the respective integrations. Based on the integration, there are 26 protons, of which 10 are apparently isolated single protons, and 3 are due to a methyl group.

The remaining signals are one two-proton signal, and three four-proton signals. Based on chemical shift information, we can speculate that there are five aromatic protons (7.3 to 8.7 ppm). Inspection of the COSY spectrum (Figure 9.17), and also taking into account the splitting patterns of the signal at 7.5 ppm, suggests that we have two isolated spin systems. The signal at 7.5 looks more like overlapping signals rather than a multiplet. With this assumption, we would have two aromatic systems — one consisting of two protons and the other consisting of three protons. This is supported by the HSQC spectrum (Figure 9.18), which clearly shows two carbons coupling with the protons at 7.5 ppm. The coupling patterns are consistent with a trisubstituted aromatic ring and a tetrasubstituted aromatic ring system. The  $^{13}\text{C}$ -NMR spectrum ( $\delta$  [ppm]: 156.648, 149.376, 147.393, 143.815, 131.027, 127.016, 120.796, 119.009, 102.425, 70.958, 60.500, 57.543, 55.383, 41.793, 37.137, 28.168, 27.151, 25.089, 23.821, 11.999), however, shows only nine aromatic carbons.

If we assume that one aromatic position is occupied by nitrogen, the information we need to get by other methods, such as mass spectrometry, then there are four possibilities for a fused-aromatic ring moiety (Figure 9.19).

Based on the chemical shift ( $\delta$  3.9 ppm) and a weak long-range coupling to proton signal 3 (d,  $\delta$  = 7.5 ppm; see Figure 9.20), the methyl group could be a methoxy group attached to an aromatic moiety. This leaves us with the structures below, where  $\text{R}_1$  is equal to  $\text{O-CH}_3$ . All other protons show mostly more than one coupling adding up to a complicated coupling path (Figure 9.21).

It appears as though all of the remaining aliphatic protons belong to one large interconnected spin system (see Figure 9.21). In order to sort out these couplings, we will inspect the edited HSQC spectrum, which tells us whether these protons are  $\text{CH}$ ,  $\text{CH}_2$ , or  $\text{CH}_3$  groups, as well as provides us with carbon chemical shifts. With this information, we might be able to connect the corresponding carbons forming the aliphatic framework. Overall, the spectrum shows correlations of 20 protons to 11 carbons. Two of those carbons ( $\delta$  55.7 ppm, 12.5 ppm) are methyl groups, as indicated through their phase (filled circles) in the edited HSQC and their proton integration. From the remaining nine carbons, four carbons have a positive phase ( $\text{CH}$ ) (filled circle) and show only a correlation to one proton ( $\text{CH}$ ). The other six carbons each exhibit a negative phase ( $\text{CH}_2$ ) (open circle) and have correlations to a pair of protons.

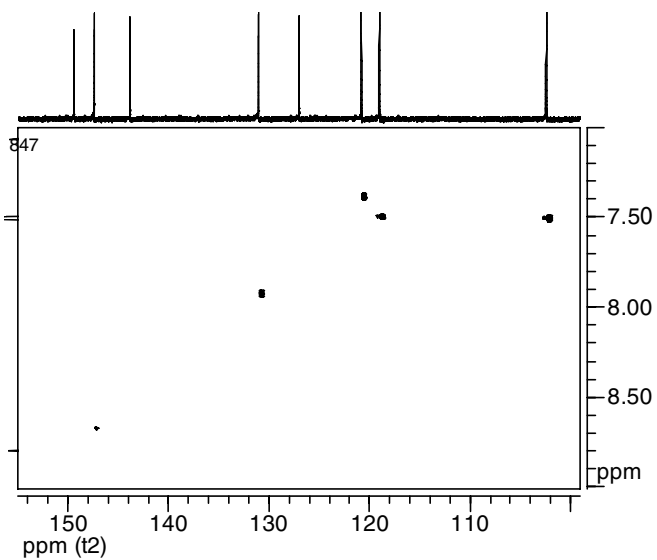

FIGURE 9.18 HSQC spectrum of the aromatic region of hydroquinine.

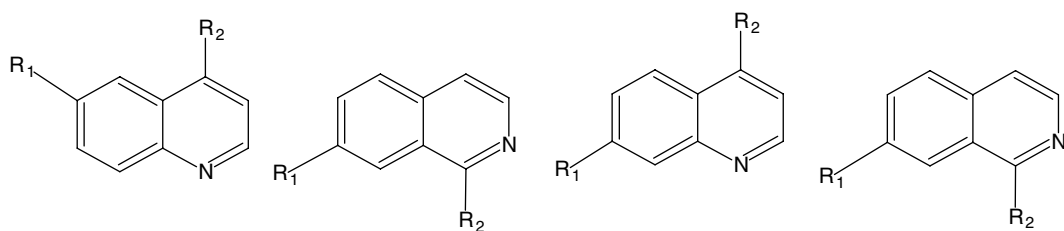

FIGURE 9.19 Possible aromatic ring systems.

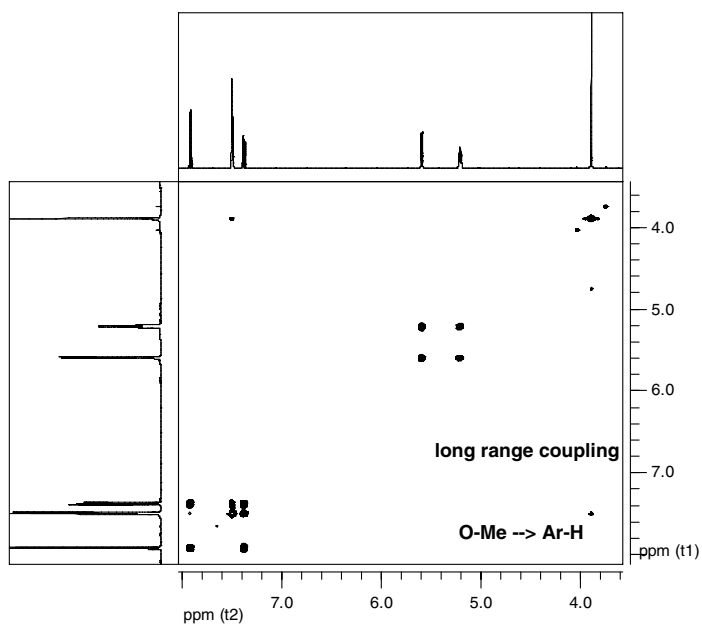

FIGURE 9.20 COSY spectrum in  $d_6$ -DMSO of hydroquinine showing long-range couplings.

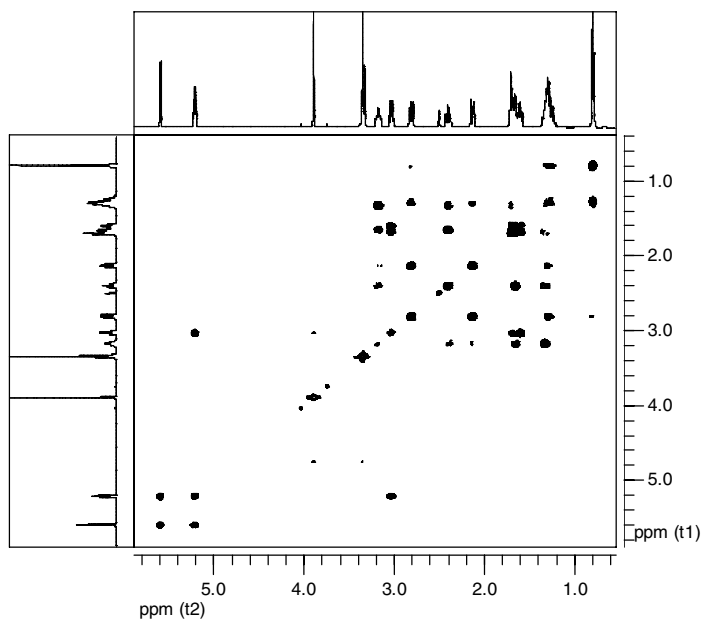
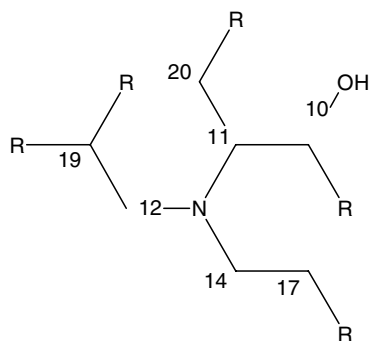

FIGURE 9.21 COSY spectrum, aliphatic region, of hydroquinine.

Note also that the proton signal 5 does not show a correlation to a carbon, which indicates an OH group. Overall, we obtain the following coupling information from the HSQC spectrum: H-1→C-2, H-2→C-4, H-3→C-7, H-3→C-8, H-4→C-6, H-6→C-10, H-7→C-13, H-9 and H-13→C-14, H-10→C-11, H-11 and H-14→C-12, H-15→C-18, C-19, H-15 and H-16→C-16, H-16→C-15, C-17, and finally H-17→C-20. Following the coupling path in the COSY, with the carbon information at hand, we can identify the following units:

H-5→H-6→H-10→H-15a, H-15b  
 H-9/H-13→H-15c/H-16a  
 H-17→H-16b, H-16c  
 H-11/H-14→H-16d

HO-CH(10)-CH(11)-CH<sub>2</sub>(20)  
 CH<sub>2</sub>(14)-CH<sub>2</sub>(17)  
 CH<sub>3</sub>(21)-CH<sub>2</sub>(18)  
 CH<sub>2</sub>(12)-CH(19)



Numbers are carbon numbers

FIGURE 9.22 Fragment IV.

The first three of the above fragments are easy to deduce. The fourth entry, Figure 9.22, however, needs a more detailed analysis. Inspection of the multiplet of protons 11/14 suggests that this CH<sub>2</sub> is connected to a CH group. This leaves one CH (16) where the proton is part of signal 15. In addition, the chemical shifts of four of those ten carbons fall in the range where we should expect alcohol and amine carbons ( $\delta$  70.96, 60.50, 57.54, 41.79). This gives us the opportunity to put in our second nitrogen. To sort out the connectivities, we need to analyze the HMBC correlations (Figure 9.23).

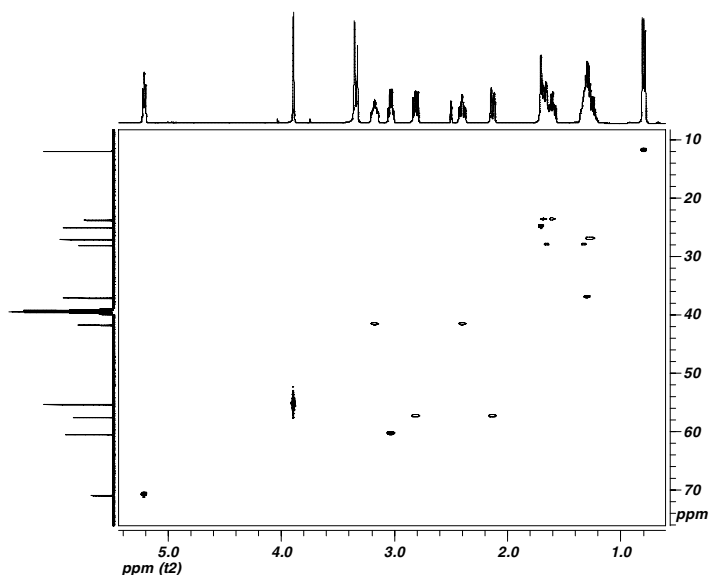

**FIGURE 9.23** HSQC spectrum of hydroquinine. Open circles represent  $\text{CH}_2^-$ , and closed circles represent CH and  $\text{CH}_3$  functions.

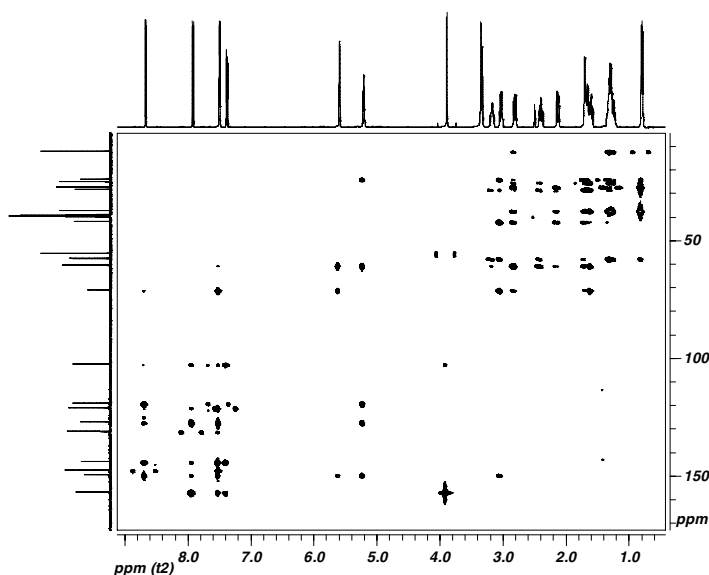

**FIGURE 9.24** HMBC spectrum of hydroquinine.

Probably the first analysis to undertake is the connection of the aliphatic part to the aromatic ring system. Protons 5 and 6 both correlate to carbon 2, which is a quaternary carbon. Furthermore, the HMBC (Figure 9.24) shows correlations between proton 5 and carbons 6 and 8. Carbon 8 is a CH group, and carbon 6 is another quaternary carbon, which then limits the number of possible aromatic skeletons to only two (Figure 9.25a and Figure 9.25b), and also tells us where the aliphatic part is connected. The other couplings of proton 6 confirm the connectivities that we deduced from the COSY/HSQC data (i.e., correlations to C-11 and C-20). Proton 10 correlates to carbons 10, 12, 14, and 20, again supporting our previous assembly of subunits around the nitrogen atom. We have not yet accounted for the ethyl group (H-17/C-21, H-16ab/C-18) in the structure.



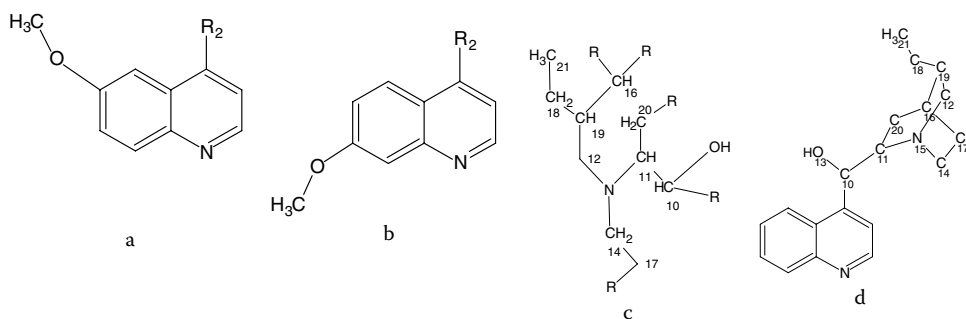

FIGURE 9.25 Partial structures for hydroquinine.

In the HMBC spectrum, proton 17 shows correlations to carbons C-12, C-16, C-18, and C-20, which is consistent with a substructure, as shown in Figure 9.25c. At this point, all carbon atoms are accounted for. We simply need to connect the C-17 and C-20 to carbon C-16, which results in the overall structure shown in Figure 9.25d.

The position of the methoxy group on the aromatic system is still unclear, as is the stereochemistry at carbons 11 and 19. Focusing on the aromatic part, there is a dipolar coupling (NOE) between the methoxy group and two aromatic protons (H-3 and H-4). H-3 also exhibits NOE correlations with protons H-6 and H-10 (see Figure 9.26 through Figure 9.28). The only way to accommodate these NOE interactions is to place the methoxy group as shown in the next structure (Figure 9.27).

With respect to the stereochemistry at carbons 11 and 19, the dipolar couplings of proton H-10 are important. The NOESY spectrum (Figure 9.28) shows correlations to proton H-14, H-15a, and H-6. H-15a also has a correlation to H-16a. This is a clear indication of the three-dimensional (3D) representation in Figure 9.27. Other NOESY correlations are summarized in Figure 9.27 and Figure 9.28. With these NOE correlations, then, we are able to complete the structure of hydroquinine. The complete  $^1\text{H}$  and  $^{13}\text{C}$ -NMR data are given in Table 9.1.

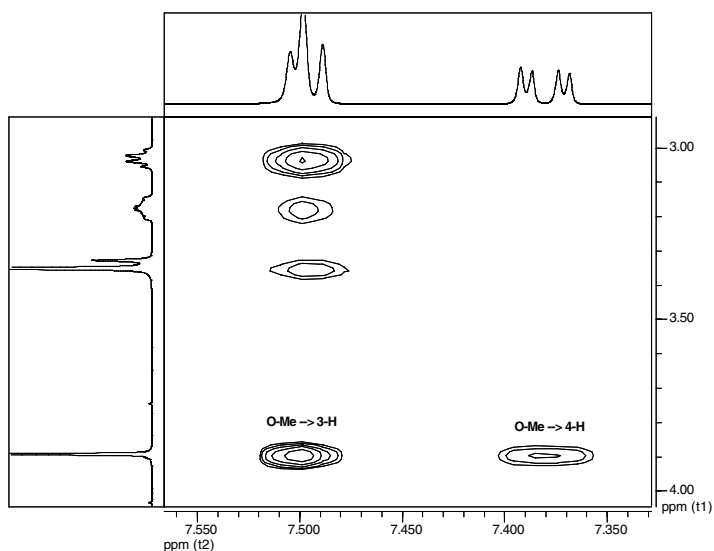

FIGURE 9.26 NOESY spectrum showing the nuclear Overhauser effect (NOE) between O-Me and H-3, as well as H-4.

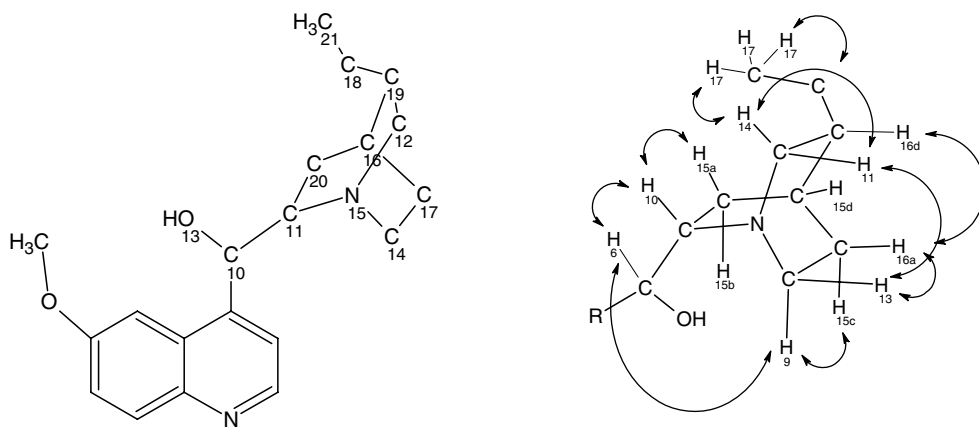

FIGURE 9.27 NOESY correlations in hydroquinine.

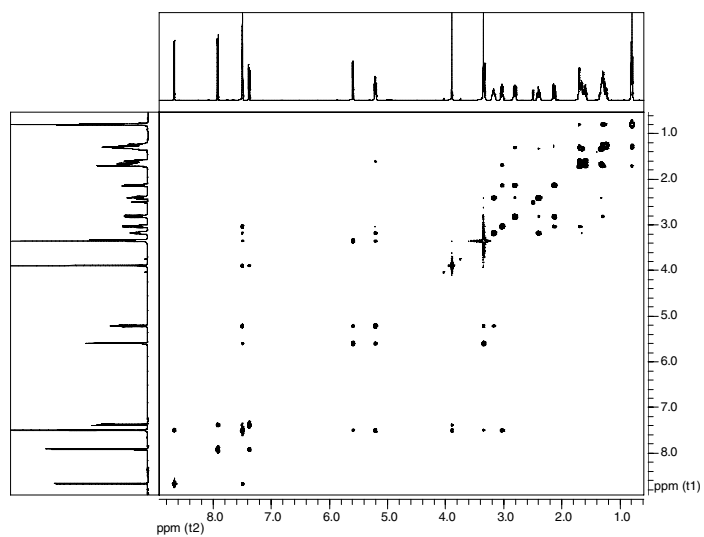
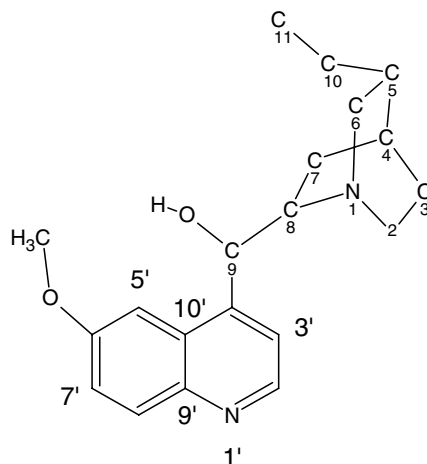

FIGURE 9.28 NOESY spectrum of hydroquinine.

TABLE 9.1

Assignments of Hydroquinine Using IUPAC Numbering



Hydroquinine

Pos	<sup>1</sup> H[ppm]	<sup>13</sup> C[ppm]	Pos	<sup>1</sup> H[ppm]	<sup>13</sup> C[ppm]	Pos	<sup>1</sup> H[ppm]	<sup>13</sup> C[ppm]
2	3.17/2.39	41.79	9	5.2	70.96	5'	7.5	102.4
3	1.66/1.33	28.17	10	1.25	27.15	6'	—	156.65
4	1.70	25.09	11	0.79	11.99	7'	7.4	120.8
5	1.29	37.14	10-OH	5.6	—	8'	7.9	131.0
6	2.8/2.1	57.54	2'	8.66	147.4	9'	—	143.82
7	1.68/1.58	23.82	3'	7.5	119.01	10'	—	127.02
8	3.03	60.50	4'	—	149.38	6'-OMe	3.89	55.38

#### 9.2.4.2 Camptothecin

Based on the <sup>1</sup>H-NMR spectrum of **camptothecin** (Figure 9.29 and Figure 9.30), we can distinguish 13 groups of signals in the <sup>1</sup>H-NMR image. The signal at 3.4 ppm is due to water impurity, and the peak at 2.5 ppm is due to that part of the solvent (*d*<sub>6</sub>-dimethylsulfoxide [DMSO]) that is not completely deuterated. The remaining signals to take into account are as follows:

Signal	δ, ppm	Integral	J, Hz	Signal	δ, ppm	Integral	J, Hz
1	8.720	1	—	7	6.559	1	—
2	8.203	1	8.5	8	5.462	2	—
3	8.157	1	8.2	9	5.317	2	—
4	7.899	1	7.5	10	1.908	2	7.25, 14.3
5	7.744	1	7.5	11	0.920	3	7.25
6	7.384	1	—				

Obviously, signals 2 through 5, 10, and 11 show a splitting due to coupling, namely, doublets (2 and 3), triplets (4, 5, and 11), and a fairly complicated multiplet (ten lines for signal 10). This indicates that all those protons have neighboring protons that give rise to the splitting. Closer inspection of these signals, utilizing the COSY spectrum (Figure 9.31), gives an idea of which of those protons is coupled to which. We easily see that the doublet-type signals show cross-peaks to only one other proton; the triplet-type signals show cross-peaks to other neighboring protons, as expected. The signals 10 and 11 are apparently part of an ethyl group (based on integration), which is unusual and indicates that, apparently, the two protons of the CH<sub>2</sub> group are diastereotopic (i.e., they have different chemical shifts). The overall signal for the CH<sub>2</sub> group is an overlap of two doublets of quartets, which due to their small ratio of *JΔδ*, show strong secondary-order effects, leading to the observed “roof effect.” This strongly

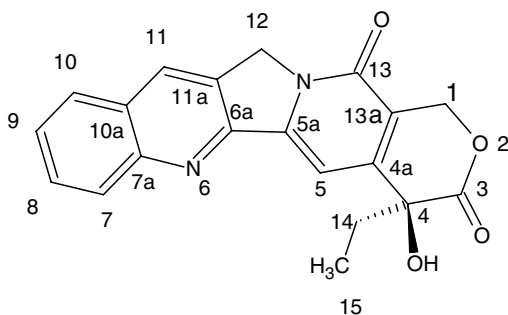

FIGURE 9.29 The structure of camptothecin.

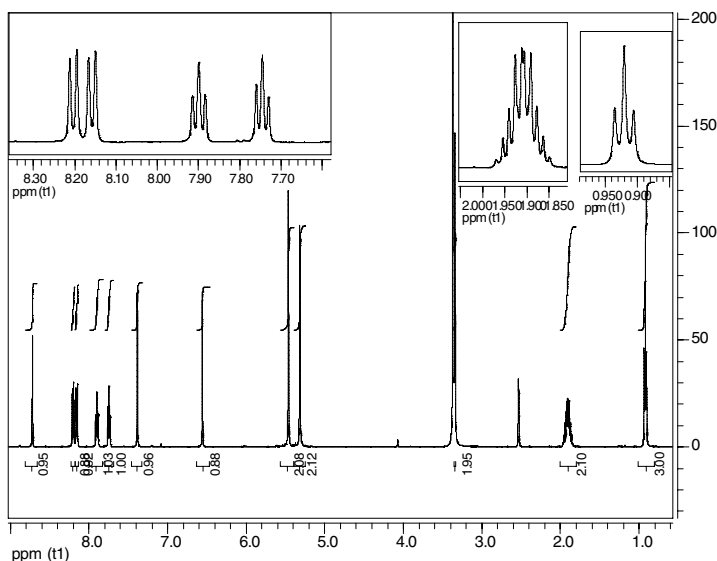

FIGURE 9.30  $^1\text{H-NMR}$  spectrum of camptothecin.

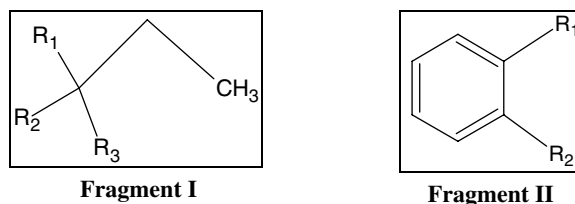

FIGURE 9.31 Fragments so far identified.

suggests that the ethyl group is next to a chiral center. Close inspection of the COSY (Figure 9.32) confirms the ethyl group, Fragment I (1.9 and 0.9 ppm). Furthermore, we recognize the correlation path for the other protons showing a line splitting (signals 2 through 5). Their chemical shifts suggest that we are dealing with an aromatic moiety. As a consequence, we conclude that the group is a disubstituted aromatic ring, Fragment II. Note that there are weaker correlations (lower intensity) in the COSY spectrum due to long-range couplings that can be used to assign almost all of the proton peaks (see Figure 9.33). We see a correlation of signal 1 to one aromatic doublet, and at the same time to signal 9, which, according to integration, is another  $\text{CH}_2$  group.

The chemical shift of 1 strongly suggests an aromatic proton, while signal 9 must be connected to a heteroatom. Following these arguments, we could simply expand our aromatic ring to consist of two

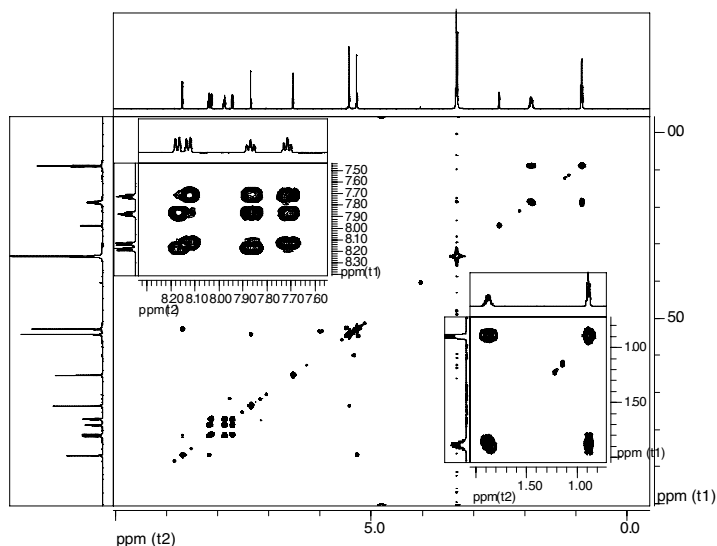

FIGURE 9.32 COSY spectrum of camptothecin.

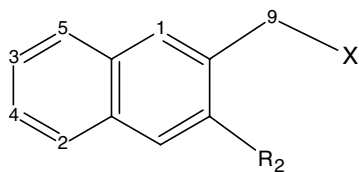

FIGURE 9.33 Fragment III (numbers are proton signal index).

rings. Since 1 is a singlet, the *ortho* and *meta* positions must be substituted, otherwise we would observe a splitting. This expands our aromatic system to Fragment III (Figure 9.33).

In addition, there is a correlation between signals 6 and 8. The chemical shift as well as integration suggests that signal 6 is either an aromatic or olefinic proton, and that it is connected via several bonds to a  $\text{CH}_2$  group (signal 8), which again should be close to a heteroatom (Figure 9.34).

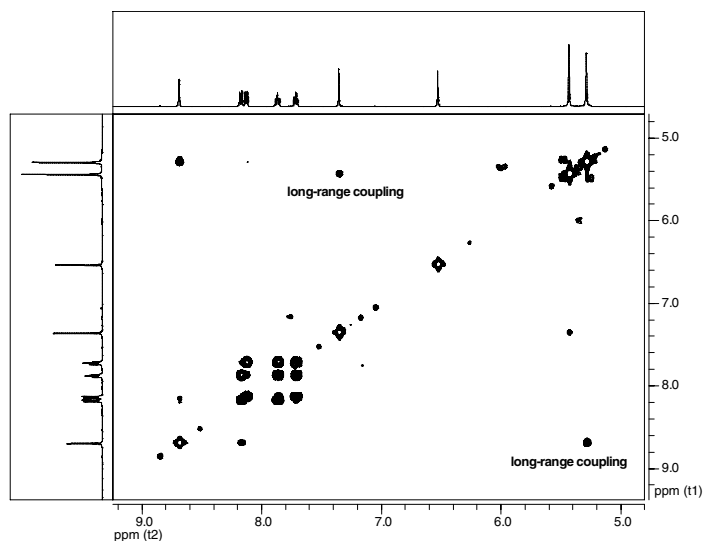

FIGURE 9.34 COSY spectrum of camptothecin showing long-range couplings.

TABLE 9.2

 $^{13}\text{C}$ -NMR Spectrum of Camptothecin

Peak Number	$\delta$ , ppm	Peak Number	$\delta$ , ppm	Peak Number	$\delta$ , ppm	Peak Number	$\delta$ , ppm
1	172.366	10	128.938	19	39.931	28	39.263
2	156.727	11	128.409	20	39.763	29	39.096
3	152.459	12	127.857	21	39.690	30	38.928
4	149.895	13	127.556	22	39.597	31	30.210
5	147.834	14	118.969	23	39.523	32	7.686
6	145.390	15	96.608	24	39.494		
7	131.456	16	72.288	25	39.430		
8	130.291	17	65.167	26	39.352		
9	129.732	18	50.143	27	39.341		

The only signal that we have not considered is signal 7, which shows up as a singlet in a chemical shift range where it could be either aromatic, olefinic, a CH connected to a heteroatom, or an OH proton. It could, for example, be used to explain the remaining position in our aromatic ring (Fragment III). To summarize, we identified 16 protons that are possibly connected to 11 carbons. For further analysis of camptothecin,  $^{13}\text{C}$  spectra as well as carbon-proton correlations have to be taken into account. The  $^{13}\text{C}$ -NMR spectrum is summarized in Table 9.2.

Twelve of these lines are due to  $d_6$ -DMSO (19 to 30), so there are 20 carbons overall. APT or DEPT spectra or edited HSQC spectra should reveal the number of protons bonded to each carbon (C, CH,  $\text{CH}_2$ , or  $\text{CH}_3$ ). Most advantageous is an edited HSQC spectrum because with this, we already can assign carbon resonances to all carbons directly bonded to hydrogens, and we get the number of protons attached to each carbon through its sign (positive for CH and  $\text{CH}_3$ , negative for  $\text{CH}_2$ ). Expansions of the HSQC spectrum are shown in Figure 9.35. All proton signals but one show a correlation to a carbon. In addition,

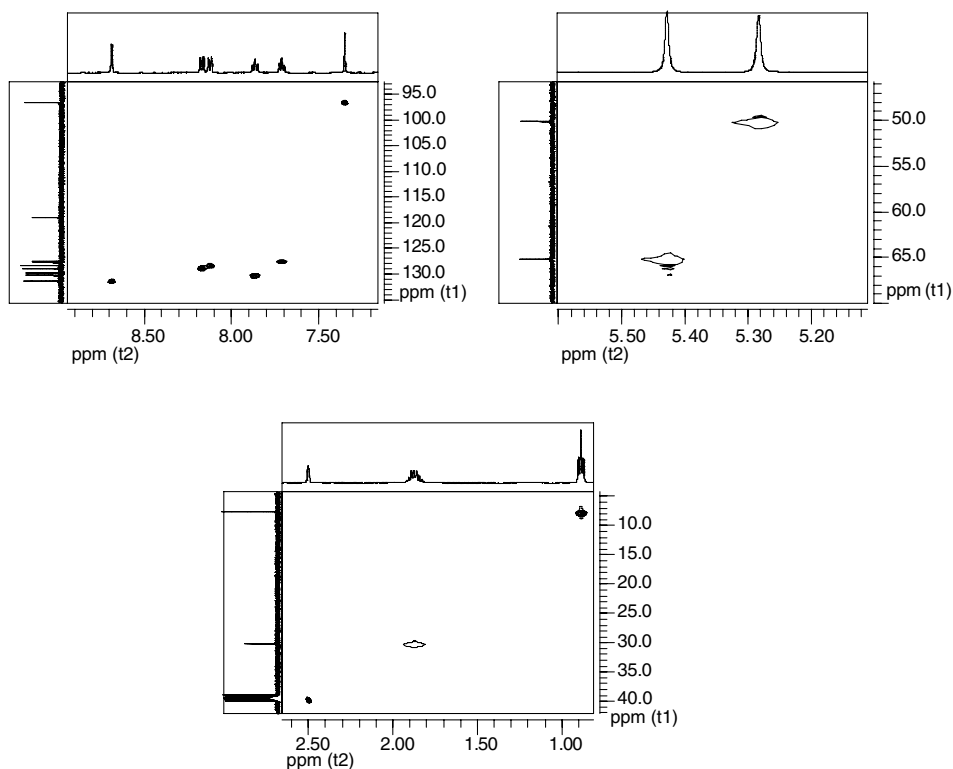
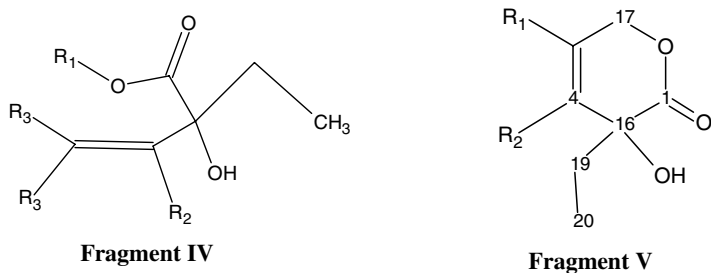

FIGURE 9.35 HSQC spectrum of camptothecin (open circles,  $\text{CH}_2$  groups; filled circles, CH,  $\text{CH}_3$ ).

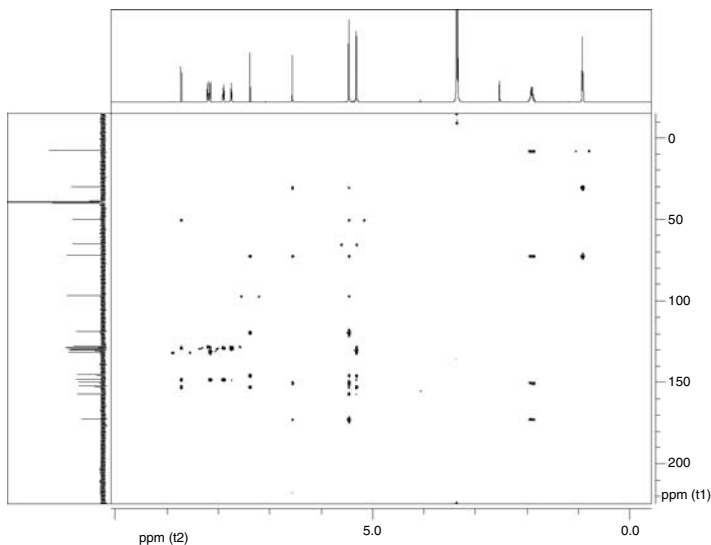

**FIGURE 9.36** Fragments IV and V.

there are six CH groups, three CH<sub>2</sub> groups, and one CH<sub>3</sub> group, which leaves ten quaternary carbons in our structure. Obviously, proton signal 7 must arise from an OH or amide-NH group. From the HSQC, we obtain the following correlations: H-1→C-7, H-2→C-10, H-3→C-11; H-4→C-8; H-5→C-13; H-6→C-15; H-8→C-17; H-9→C-18; H-10→C-19; H-11→C-20.

In order to complete the NMR analysis, we need to verify the quaternary centers of the remaining ten carbons: C-1 to C-6, C-9, C-12, C-14, and C-16. First, we inspect the chemical shifts of the remaining carbons. All but three of them fall clearly in the range of double-bonded carbons (C-3 to C-6, C-9, C-12, and C-14). Two of the others (C-1 and C-2) could be carbonyl carbons from esters and amides, and C-16 is clearly an oxygen-bearing carbon. Recall that the ethyl group is most likely attached to a chiral center. This can be only C-16, as it is the only aliphatic quaternary carbon. Thus, starting the analysis of the HMBC spectrum (Figure 9.37) with the ethyl group, we identify correlations from the methyl protons (H-11) to two carbons (C-19 at 30.2 and C-16 at 72.3 ppm), and from the methylene group (H-10) to four carbons (C-20 at 7.7, C-16 at 72.3, C-4 at 149.9, and C-1 at 172.4 ppm). In addition, there is a correlation from our OH or NH signal (H-7) to the following carbons: C-1, C-4, C-16, and C-19. Because C-4 is a double-bonded carbon, there should be at least one other double-bonded carbon attached to it. This gives us the fragments shown in Figure 9.36.

In addition, 8-H shows correlations to C-1, C-4, C-16, and C-19. We must conclude, then, that H-8 should be R<sub>1</sub> in Fragment IV because that explains both the proton and carbon (C-17) chemical shifts as well as the correlation to C-1. Correlations to C-4 and C-16 can be explained if we construct a six-



**FIGURE 9.37** HMBC spectrum of camptothecin.

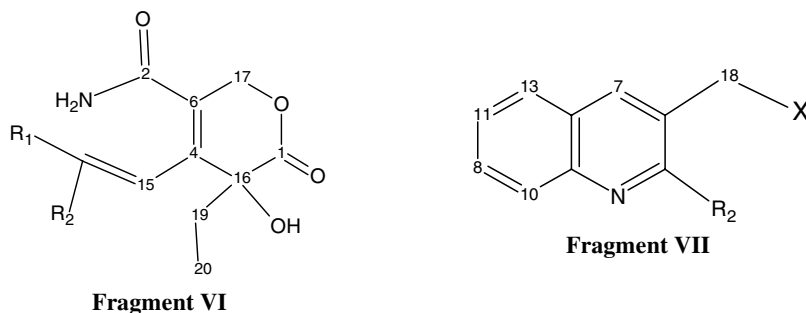

FIGURE 9.38 Fragments VI and VII.

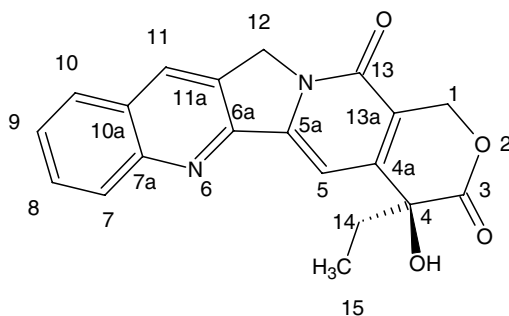

FIGURE 9.39 Camptothecin.

member ring (Fragment V). The long correlation to C-16 would then be mediated by the double bond, which is not readily explained otherwise. In addition, H-8 shows correlations to C-2, C-6, C-14, and C-15. C-15 was identified as a CH carbon, and all the others are quaternary carbons. Note that in the COSY spectrum, we see a correlation between H-8 and H-6. Both effects are best explained if we position C-15 as R<sub>2</sub> in Fragment V, which then implies that there is another double-bonded carbon attached to C-15, and also carbon C-2 attached to C-6 (Fragment VI). So far, we have one carbon of the previous structure not yet assigned. Because H-8 is a singlet, C-15 has to be connected to yet another quaternary carbon. Overall, Fragment VI would account for 10 out of the total 20 carbons, and we used up 5 of the 10 quaternary carbons. 6-H, which is now our key proton with which to grow our structure, shows correlations to C-3, C-6, C-14, and C-16. The only new carbon here would be C-3, which could possibly be the unassigned carbon in Fragment VI. Recall that Fragment III is composed of 11 carbons, and if we consider the number of CH carbons, there is one CH too many in Fragment III. The molecular formula for camptothecin, which could be obtained from a mass spectrum, is C<sub>20</sub>H<sub>16</sub>N<sub>2</sub>O<sub>4</sub> (Figure 9.37, Figure 9.38, and Figure 9.39).

Because we have to place one additional nitrogen in the structure, and there is one too many CH positions in Fragment III, we need to replace one of the CH groups with a nitrogen. The most obvious place to put this nitrogen is in the CH position that was not yet assigned. When, at the same time, we replace the proton labels with the carbon labels, our Fragment III then becomes Fragment VII. The only remaining task is to connect Fragment VI and Fragment VII properly. We have no evidence for amide protons, so the amide nitrogen must be connected to two carbons. In Fragment VII, we already have one good candidate, C-18, which has a chemical shift consistent with a carbon attached to a nitrogen. This then leads to the following overall structure. Checking the remaining signals in the HMBC spectrum confirms the structure. The final assignment of peaks using numbering according to IUPAC is presented in Table 9.3.



TABLE 9.3

Complete NMR Assignment for Camptothecin

Position	$^{13}\text{C}\delta$ (ppm)	$^1\text{H}\delta$ (ppm)	Position	$^{13}\text{C}\delta$ (ppm)	$^1\text{H}\delta$ (ppm)
1	65.2	5.46	9	127.6	7.74
3	172.4	—	10	128.4	8.16
4	72.3	—	10a	127.8	—
4a	149.9	—	11	131.5	8.72
5	96.6	7.38	11a	129.7	—
5a	145.4	—	12	50.1	5.32
6a	152.5	—	13	156.7	—
7a	147.8	—	13a	118.9	—
7	128.9	8.2	14	30.2	1.91
8	130.3	7.9	15	7.7	0.92

### 9.2.4.3 Tingenone

With the next example, we will inspect a situation that is typical for triterpenes. Attempts to analyze the  $^1\text{H}$ -NMR spectrum of **tingenone** (Figure 9.40 and Figure 9.41) quickly become complicated in the region between  $\delta = 1.8$  ppm and  $\delta = 1.2$  ppm (Figure 9.42). We see a crowded region of fairly complicated proton

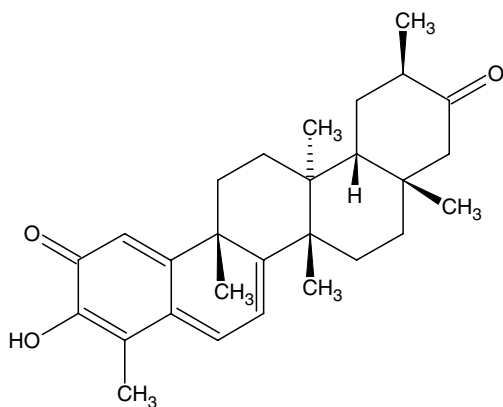
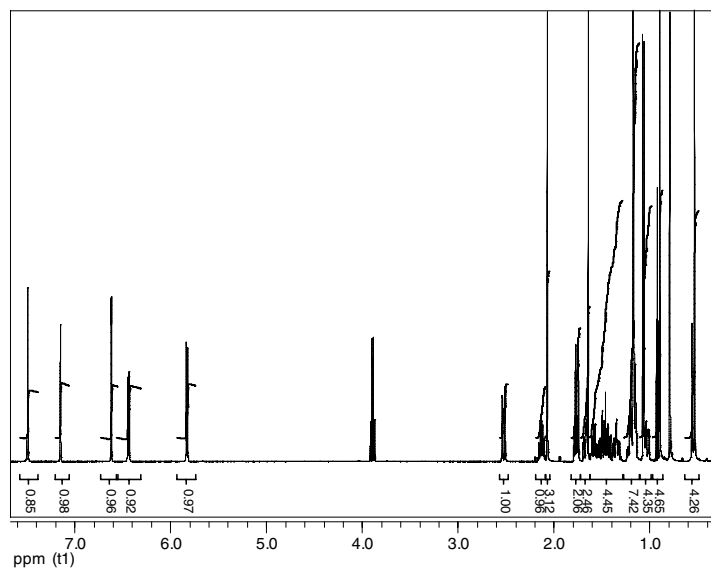

FIGURE 9.40 Tingenone.

FIGURE 9.41  $^1\text{H}$ -NMR of tingenone, solvent  $d_6$ -benzene.

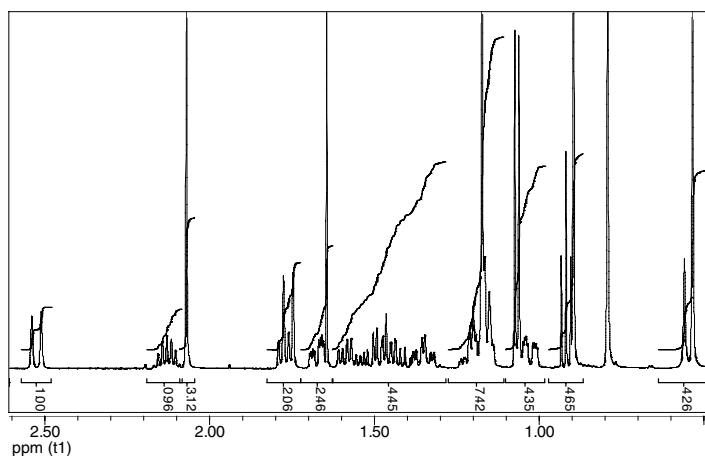

FIGURE 9.42  $^1\text{H}$ -NMR spectrum of tingenone in  $d_6$ -benzene, aliphatic part.

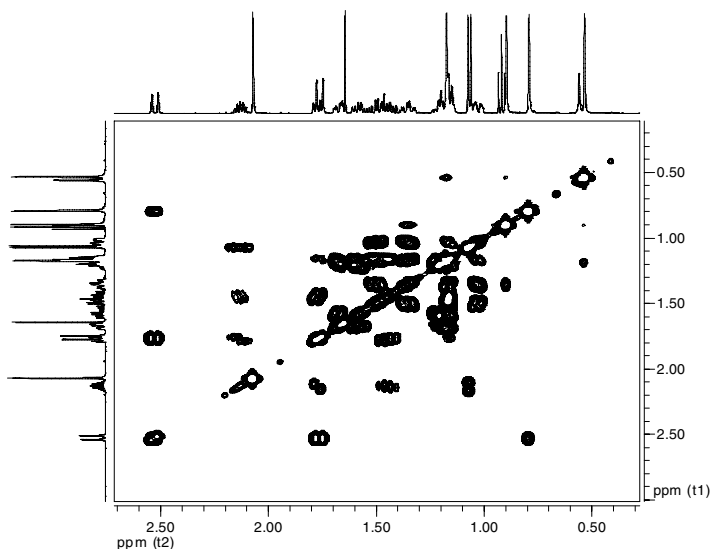
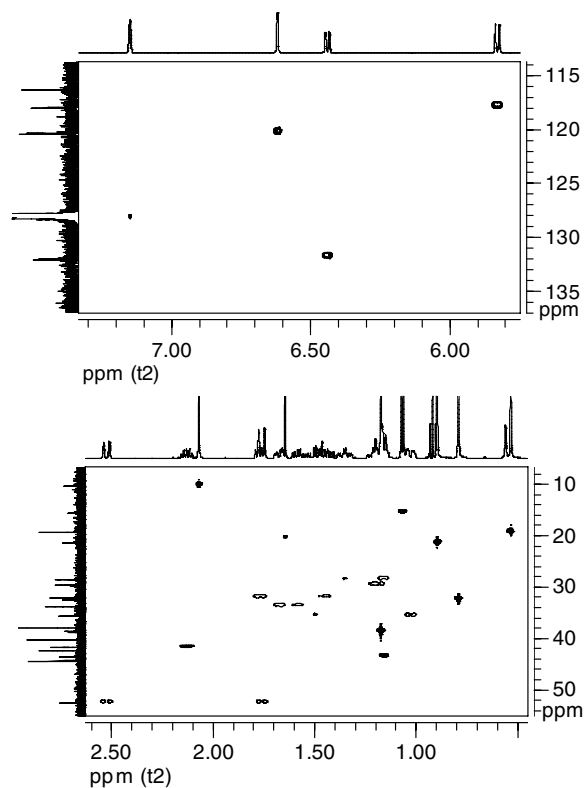

FIGURE 9.43 COSY spectrum of tingenone aliphatic part in  $d_6$ -benzene.

responses. According to the integration, up to 35 protons could give rise to signals. The COSY spectrum (Figure 9.43) offers no immediate solution to the problem because a large number of correlations seem to start at the same chemical shift at  $\sim 1.2$  ppm. The best solution in this case is probably running  $^{13}\text{C}$  spectra, which immediately show resonances for 28 carbons. The situation can be further improved when the HSQC spectrum is inspected.

Clearly, six methyl groups at  $\delta = 9.9, 15.1, 19.1, 21.2, 32.1,$  and  $38.6$  ppm; six methylene groups at  $\delta = 28.24, 29.32, 31.73, 33.39, 35.30,$  and  $52.39$  ppm; and five methine carbons at  $\delta = 41.52, 43.26, 117.71, 120.12,$  and  $131.66$  ppm can be identified. Using the HSQC spectrum (Figure 9.44) in connection with the HSQTOCSY spectrum (Figure 9.45), we are able to sort out the COSY spectrum. The combination of the COSY and HSQC leads to the following subunits:  $\text{CH}_3\text{-CH-CH}_2\text{-CH}$  (a),  $\text{CH}_2\text{-CH}_2$  (b),  $\text{CH}_2\text{-CH}_2$  (c),  $\text{CH}_2$  (d), and  $\text{CH=CH}$  (e).

Most important to solve the structure, however, is the HMBC spectrum (Figure 9.46). There we can see correlations to the 11 quaternary carbons and assemble the structure using the framework of  $^2\text{J}$  and  $^3\text{J}$  couplings. Noteworthy is also the coupling of the 3-OH to C-2, C-3, and C-4.



**FIGURE 9.44** HSQC spectrum of tingenone with the olefinic part shown at the top and the aliphatic part shown at the bottom.

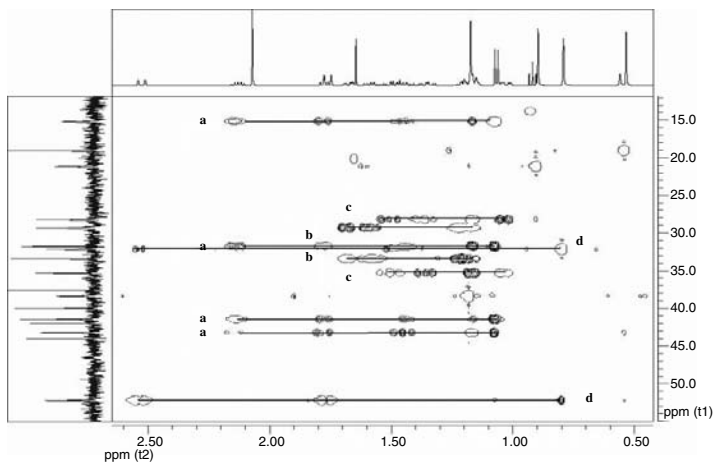

**FIGURE 9.45** HSQCTOCSY spectrum of the aliphatic part of tingenone. Spin systems are labeled a, b, c, d.

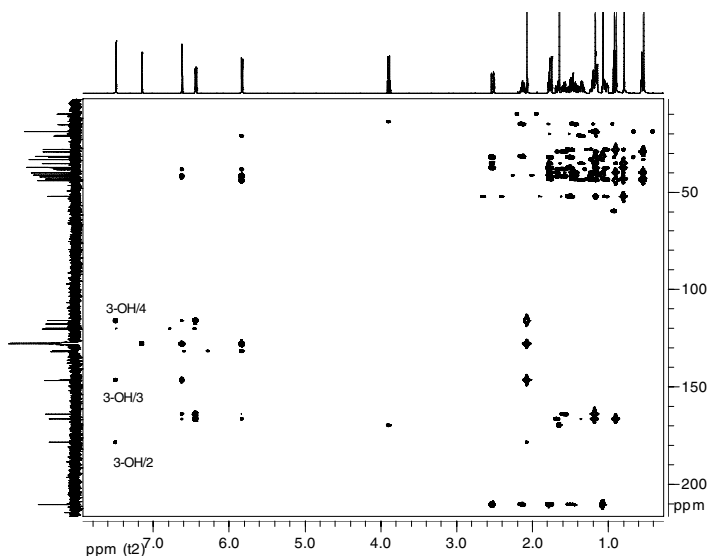

FIGURE 9.46 HMBC spectrum of tingenone.

TABLE 9.4

NMR Assignment of Tingenone (*d*<sub>6</sub>-Benzene)

Pos	<sup>1</sup> H	<sup>13</sup> C	Pos	<sup>1</sup> H	<sup>13</sup> C	Pos	<sup>1</sup> H	<sup>13</sup> C
1	6.62 d (1.5)	120.15	11	1.77 1.54	33.41	21	—	210.40
2	—	178.33	12	1.21 m	29.3	22	2.53 d (14.3) 1.76 d (14.3)	52.26
3	—	146.52	13	—	39.85	23	2.07 S	10.18
4	—	116.01	14	—	44.07	25	1.19	38.15
5	—	127.85	15	1.36 td 1.17	28.13	26	0.90	21.22
6	6.44 dd (1.5,7.1)	119.99	16	1.51 td 1.03 ddd	35.05	27	0.54	19.06
7	5.83 d (7.1)	117.58	17	—	37.39	28	0.79 s	31.9
8	—	166.42	18	1.18, d (7.2)	43.21	30	1.07 d(6.65)	15.16
9	—	41.96	19	1.79 dd (15, 6.5) 1.44 ddd (15.1, 13.1, 7.2)	31.76			
10	—	163.90	20	2.13 ddq (13.1, 6.5, 6.5)	41.38			

#### 9.2.4.4 Paclitaxel

In paclitaxel (Figure 9.47), the <sup>1</sup>H-NMR displays a large number of protons integrating to a total of 51 protons. In the aromatic region, 7.00 to 8.5 ppm (Figure 9.48), we find eight signals accounting for 16 protons.

Next are the olefinic region and the region of oxygenated functional groups, including OHs,  $\delta = 3.5$  ppm to 6.5 ppm. Here, we find 12 signals, which account for ten protons and three signals that integrate for only half a proton. All of those groups are nicely separated from each other (Figure 9.49).

Finally, the aliphatic region (Figure 9.50) displays 11 signals, one of which at  $\delta = 2.05$  ppm is the solvent signal. According to their integrals, the remaining signals can be divided into six methyl group resonances and four resonances from individual protons — a total of 22 protons. Inspection of the COSY spectrum (Figure 9.51) quickly identifies three different benzene rings, each having five aromatic protons, thus accounting for 15 of the 16 protons. The remaining proton at  $\delta = 8.128$  ppm, doublet, however, couples to a nonaromatic proton at  $\delta = 5.826$  ppm, which identifies this proton as an NH-amide proton.

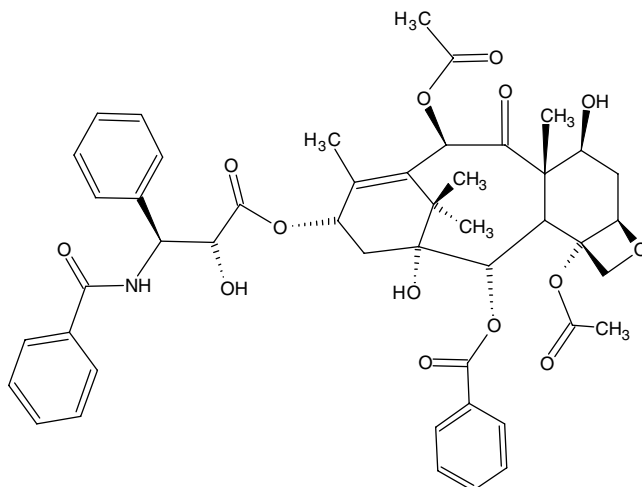

FIGURE 9.47 Structure of paclitaxel.

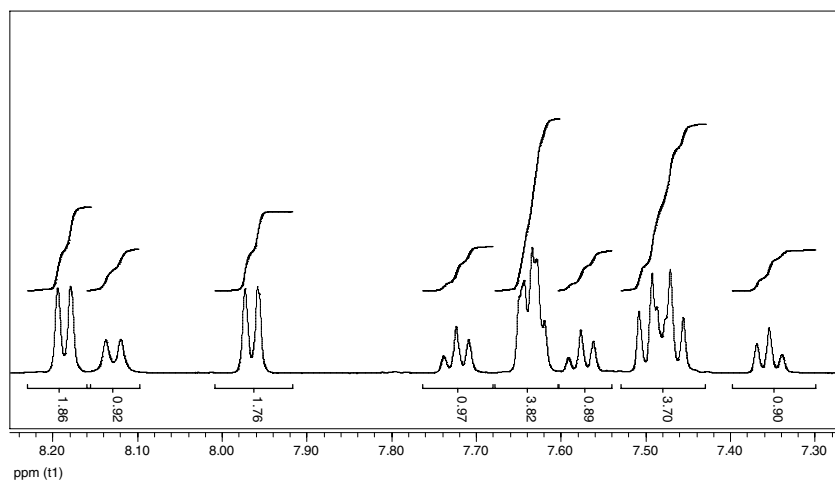

FIGURE 9.48 Aromatic region of the <sup>1</sup>H-NMR of paclitaxel.

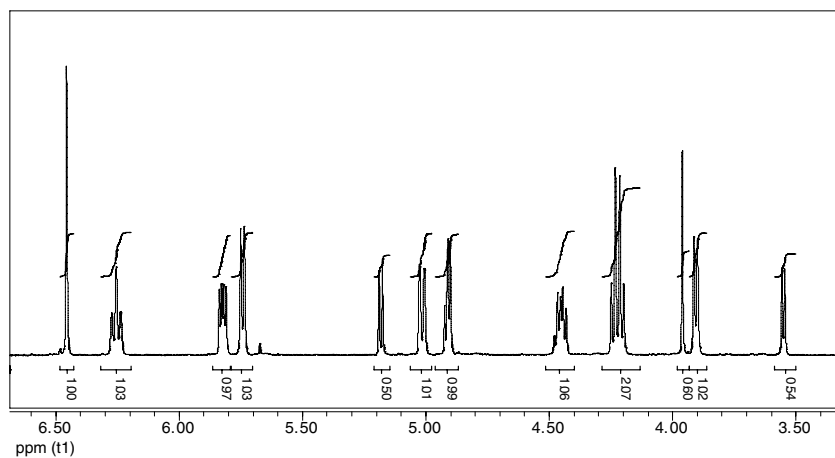

FIGURE 9.49 δ 3.6 to 6.5 ppm region of the <sup>1</sup>H-NMR of paclitaxel.

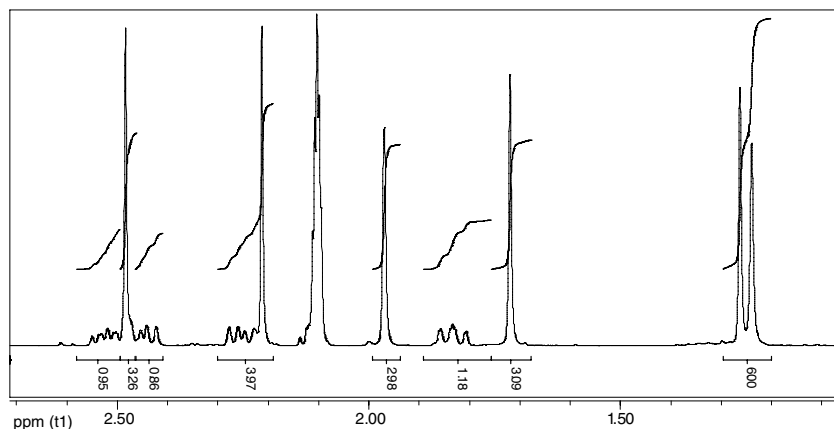

FIGURE 9.50 Aliphatic region of the  $^1\text{H}$ -NMR of paclitaxel.

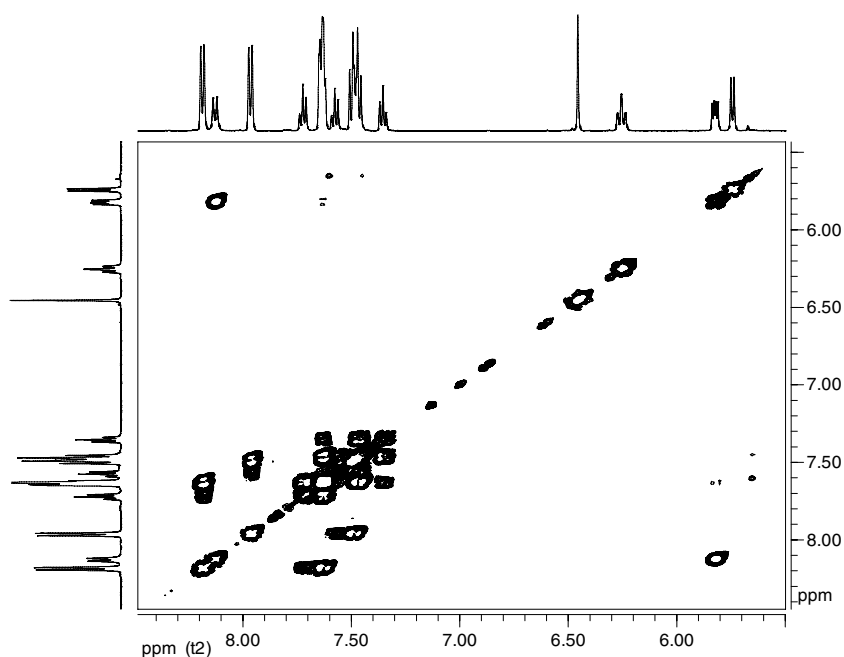

FIGURE 9.51 Low-field part of the COSY spectrum of paclitaxel.

Interestingly, there is also a weak coupling from that same proton at  $\delta = 5.826$  ppm to an aromatic proton, suggesting a long-range coupling. This supports the idea that the NH and one aromatic ring are substituents on the same carbon. The electronic effects of these two substituents would easily explain the chemical shift of this proton at  $\delta = 5.826$  ppm. Being displayed as a dd in the 1D image, the remaining coupling partner can be identified in the COSY at  $\delta = 4.9$  ppm. This coupling path continues to a signal at  $\delta = 5.18$  ppm, which is one of those protons integrating for only one-half a proton. This suggests an OH group.

The remaining coupling patterns, which can be followed in the COSY spectrum (Figure 9.52), are, starting at  $\delta = 6.2$  ppm, which couples to two of the individual aliphatic protons,  $\delta = 2.45$  and  $2.24$  ppm, as well as one of the methyl groups at  $\delta = 1.97$  ppm. This methyl group has one other weak coupling to the signal at  $\delta = 6.44$  ppm. The next coupling path starts at  $\delta = 5.74$  ppm (1H), connects via  $\delta = 3.89$  ppm (1H),  $\delta = 4.21$  ppm (2H) to  $\delta = 5.02$  ppm (1H). The signal at  $\delta = 5.02$  ppm is again connected to

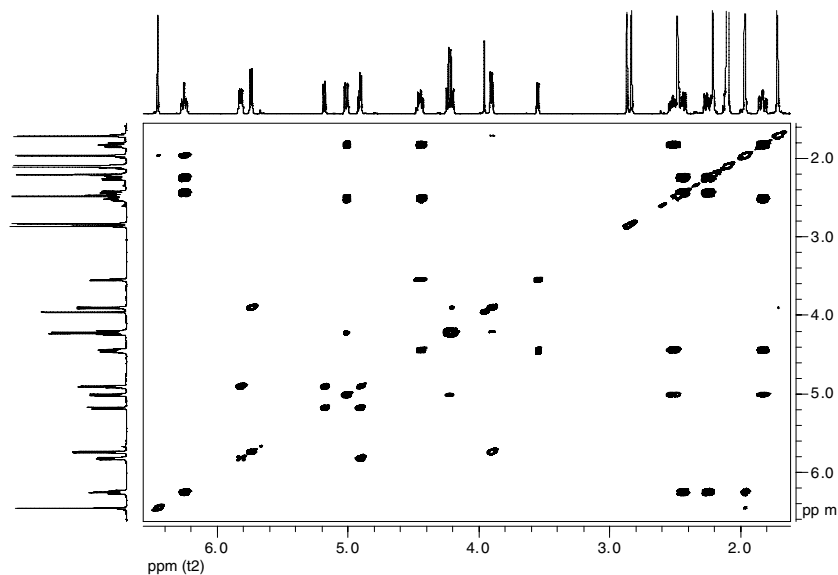

FIGURE 9.52 High-field part of the COSY spectrum of paclitaxel.

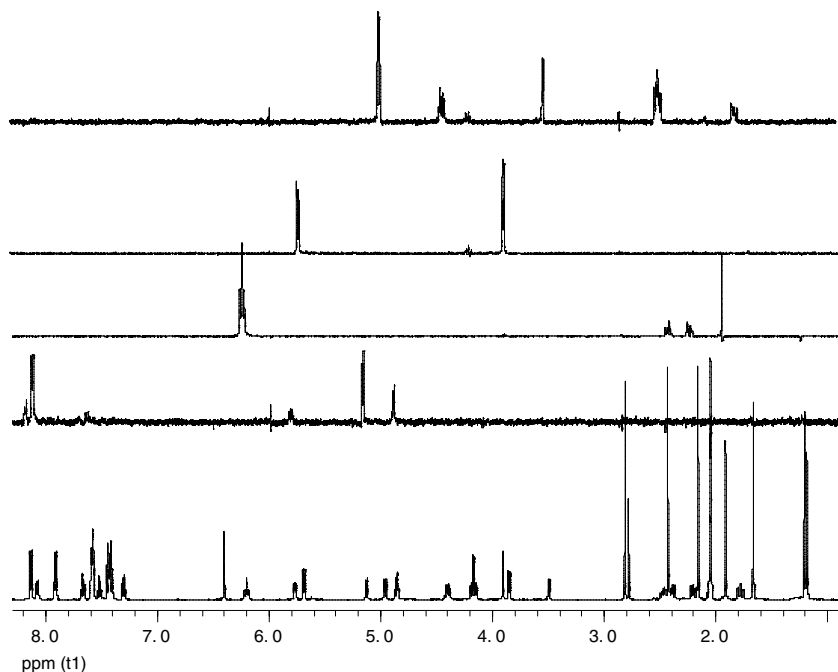

FIGURE 9.53 1D-TOCSY spectrum of aliphatic parts of paclitaxel.

$\delta = 2.52$  ppm (1H), and  $\delta = 1.83$  ppm, which, in turn, correlate with a signal at  $\delta = 4.44$  ppm. This last proton at  $\delta = 4.44$  ppm displays an additional coupling to the second proton integrating only for one half at  $\delta = 3.55$  ppm. This again can be taken as an indication for an OH proton.

The aforementioned coupling paths can be easily displayed with 1D-TOCSY measurements. While the aliphatic part for this molecule is straightforward (see Figure 9.53), because we do not get any overlap, the aromatic part can be nicely divided into three different aromatic rings, as shown in the 1D-TOCSY spectra (Figure 9.54).

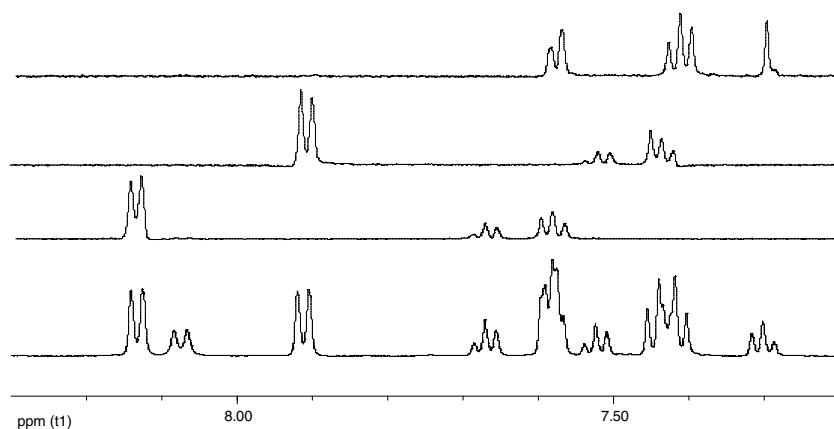

FIGURE 9.54 1D-TOCSY spectrum of paclitaxel showing the aromatic spin systems.

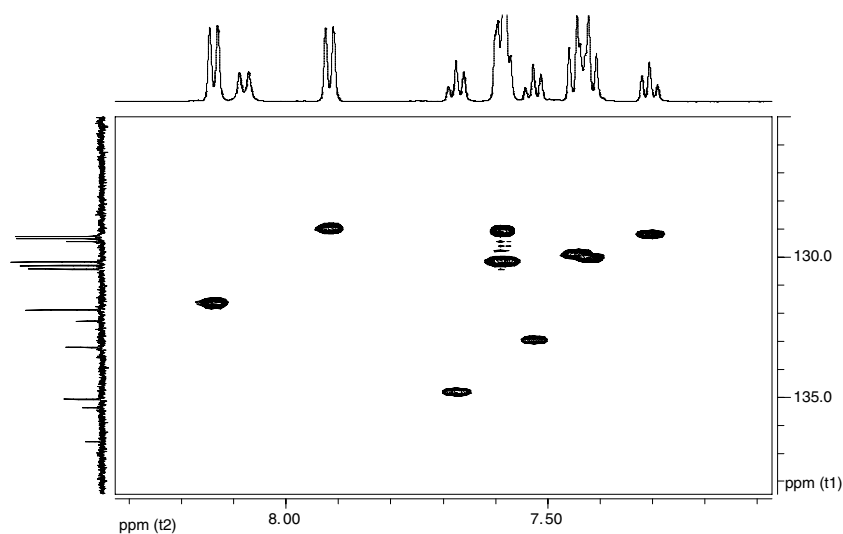

FIGURE 9.55 Aromatic region of the HSQC spectrum of paclitaxel.

Many of these assumptions are supported by the HSQC (Figure 9.55, Figure 9.56, and Figure 9.57) and HMBC (Figure 9.58) spectra, which, for instance, give clear indications for the NH, and suggested OH protons because there is no correlation of those signals to any carbon in the HSQC spectrum, as well as the aromatic protons, because all of them correlate with carbons between  $\delta = 128$  ppm and  $\delta = 136$  ppm.

The HSQC spectrum also clearly identifies three CH<sub>2</sub> groups, seven oxygenated CH functions, and the methyl groups, which were mentioned before. The missing information of the quaternary carbons and how the carbon framework is connected can then be retrieved from the HMBC spectrum (Figure 9.51).

The combination of all this information leads to the assignments shown in Table 9.5.



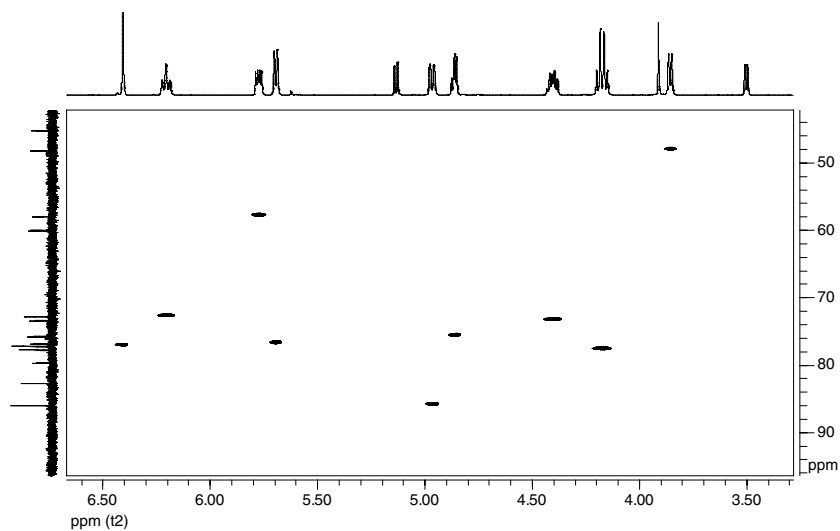

FIGURE 9.56 Part of the HSQC spectrum of paclitaxel showing oxygen bearing group range.

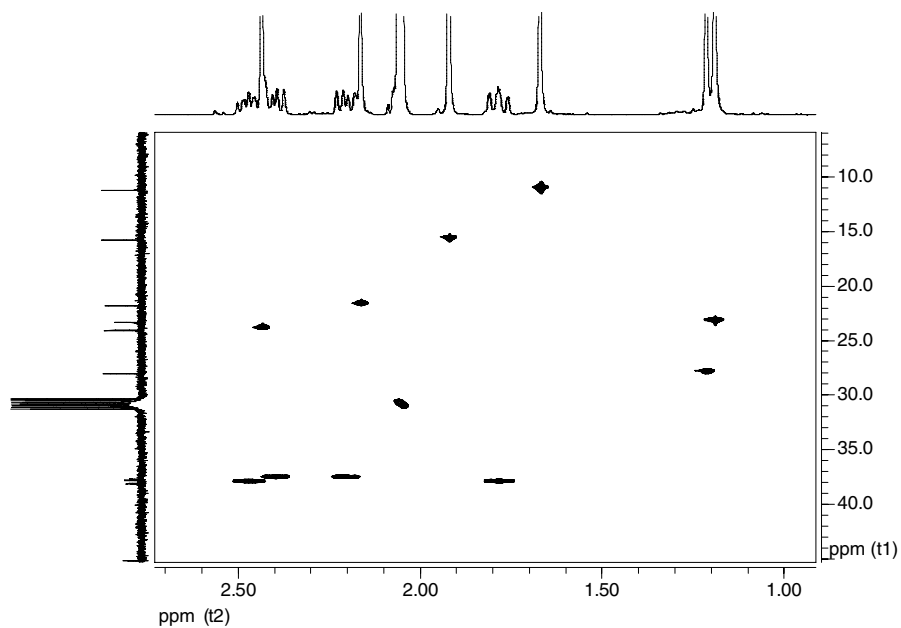

FIGURE 9.57 Aliphatic region of the HSQC spectrum of paclitaxel.

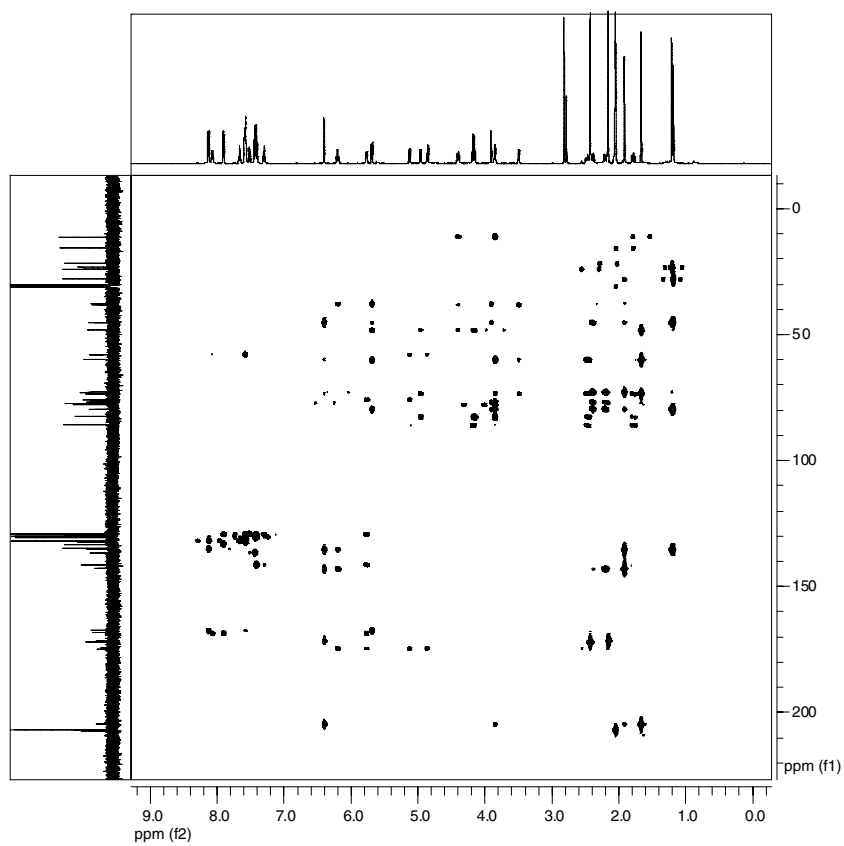

FIGURE 9.58 HMBC spectrum of paclitaxel.

**TABLE 9.5**  
NMR Assignment of Paclitaxel

Position	H (ppm)	C (ppm)	HMBC Correlation
1	—	79.92	
2	5.7	76.54	14,8,1,1 <sup>''''</sup>
3	3.85	47.9	19,8,7,2,1,4
4	—	84.62	
5	4.96	85.75	4,7
6	2.47/1.77	37.90	8,7/4,5,7
7	4.4	73.14	8,19
8	—	48.76	
9	—	204.11	7,8,10,19
10	6.41	76.95	8,9,18
11	—	135.09	
12	—	142.71	
13	6.18	72.55	11,12
14	2.39/2.18	37.5	1,13/1,13
15	—	45.22	
16	1.18	23.17	11,17,15,1
17	1.2	27.7	16,15,1,11,12
18	1.67	10.89	13,10,9,17,15
19	1.77	14.19	3,8,7,9
20	4.17	77.4	3,4,5
1'	—	174.74	
2'	4.86	75.38	3',1''
3'	5.75	57.6	2'',6''
NH	8.05	—	
1''	—	131.4	
2'',6''	7.57	129.07	
3'',5''	7.39	129.9	
4''	7.3	128.9	
1'''	—	167.6	
2'''	—	136.4	
3''', 7'''	8.1	131.56	
4''', 6'''	7.55	129.98	
5'''	7.65	134.7	
1''''	—	168.5	
2''''	—	142.4	
3'''', 7''''	7.9	128.9	
4'''', 6''''	7.46	129.8	
5''''	7.53	132.8	
10-OAc-CO	—	170.98	
10-OAc-Me	2.11	21.9	
4-OAc-CO	—	171.5	
4-OAc-Me	2.342	24.09	
2'-OH	5.13	—	1'

---

## 9.3 Mass Spectrometry

Next to NMR, **mass spectrometry** is certainly the most important tool in the structural determination of organic compounds and of natural products. In comparison to NMR spectroscopy, it offers outstanding sensitivity, which is orders of magnitude better than that of NMR. However, the interpretation of MS spectra is more complex than NMR spectra, and connectivity information, which is so important for the structure elucidation process, can be obtained only indirectly through careful examination of fragmentation spectra.

A mass spectrometer produces charged particles (ions) from the chemical substances that are to be analyzed. Subsequently, these charged particles are falling apart (“fragmentation”) due to their high energy, and then electric and magnetic fields are used to measure the mass (“weight”) of the newly generated charged particles. Because this fragmentation is not an arbitrary process, but a process controlled by the different stabilities of cations and anions produced, conclusions can be drawn as to the underlying structures. While this can be partially used to deduce structure, at the same time, it introduces the problem that in many cases molecular ions are hard to produce, and thus, molecular formulas of unknown compounds are hard to determine.

There are many different techniques in mass spectrometry that can be divided according to their ion formation and according to the process of how we sort out the originally generated ions and the ions resulting from fragmentation reactions.

### 9.3.1 Gas-Phase Ionization

Gas-phase ionization methods rely upon ionizing samples that are in the gas phase. Gas-phase ionization is limited to volatile samples, which are usually introduced into the mass spectrometer through a heated batch inlet, heated direct insertion probe, or, most commonly, a gas chromatograph.

#### 9.3.1.1 Electron Ionization (EI)

**Electron ionization** or **electron impact ionization (EI)** is the oldest and best characterized of all the ionization methods. A beam of electrons passes through the gas-phase sample and collides with the neutral analyte molecule. This collision can knock off an electron from the analyte molecule, resulting in a **positively charged radical ion**. The ionization process can produce, in favorable cases, molecular ions that will have the same molecular weight and elemental composition as the starting analyte, or it can produce fragment ions that correspond to smaller pieces of the analyte molecules.

Most mass spectrometers use electrons with an energy of 70 electron volts (eV) for EI. Decreasing the electron energy can reduce fragmentation, but it also reduces the number of ions formed. EI mass spectra are well understood, can be applied to virtually all volatile compounds, lead to reproducible mass spectra, which through their fragmentation provide structural information, and their reproducibility can be used in libraries of mass spectra that can be searched for **EI mass spectral “fingerprints.”** In some cases, especially in higher-molecular-weight compounds, no molecular ion is observed. For EI, the sample must be volatile; therefore, the mass range is limited to typically less than 1000 Da, which, however, for most natural products is not that much of a problem.

#### 9.3.1.2 Chemical Ionization (CI)

Alternatively, **chemical ionization (CI)** can be used. This is a two-step process, where in a first step a reagent gas, typically methane, isobutene, or ammonia is ionized through electron impact. In a second step, these reagent gas ions are then reacted with the analytes, which, in turn, produce the analyte ions to be analyzed by the spectrometer.

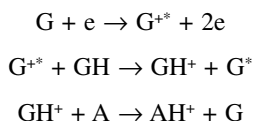

where

$G$  = reagent gas

$A$  = analyte molecule

$e$  = electron

$\bullet$  = radical species

$H$  = hydrogen

The advantage of chemical ionization is the occurrence of much less fragmentation, which typically means that molecular ions are easier to produce, and the spectra obtained are less complex. It can also be interfaced with liquid chromatography (LC-MS).

### 9.3.1.3 Field Desorption and Ionization

**Field desorption** and **ionization** are soft ionization methods that tend to produce mass spectra with little or no fragment-ion content. These methods are based on electron tunneling from an emitter that is biased at a high electrical potential.

#### 9.3.1.3.1 Field Desorption (FD)

The sample is deposited onto the emitter, the emitter is biased to a high potential (several kilovolts), and a current is passed through the emitter to heat up the filament. Mass spectra are acquired as the emitter current is gradually increased, and the sample is evaporated from the emitter into the gas phase. Characteristic positive ions produced are radical molecular ions and cation-attached species such as  $[M+Na]^+$ . The latter are probably produced during desorption by the attachment of trace alkali metal ions present in the analyte. FD leads to simple mass spectra, typically one molecular or molecular-like ionic species per compound. It works well for small organic molecules. The mass range in which this technique can be applied is less than about 2000 to 3000 Da; however, it is very sample dependent.

#### 9.3.1.3.2 Field Ionization (FI)

The sample is evaporated from a direct insertion probe, gas chromatograph, or gas inlet. As the gas molecules pass near the emitter, they are ionized by electron tunneling. This again leads to very simple mass spectra, typically one molecular or molecular-like ionic species per compound. The sample must be thermally volatile and is introduced in the same way as for electron ionization. This limits the mass range to typically less than 1000 Da.

## 9.3.2 Particle Bombardment

In these methods, the sample is deposited on a target that is bombarded with neutral or ionic atoms. The most common approach for organic mass spectrometry is to dissolve the analyte in a liquid matrix with low volatility and to use a relatively high current of bombarding particles (fast atom bombardment [FAB] or dynamic secondary ion mass spectrometry [SIMS]).

### 9.3.2.1 Fast Atom Bombardment (FAB)

The analyte is dissolved in a liquid matrix such as glycerol, thioglycerol, or *m*-nitrobenzyl alcohol, and a small amount is placed on a target. The target is bombarded with a fast (neutral) atom beam (for example, 6 keV xenon atoms) that desorbs molecular-like ions and fragments from the analyte. Cluster ions from the liquid matrix are also desorbed, and they produce a chemical background that varies with the matrix used. It provides a rapid and simple technique that can be applied to a large number of compounds and is often used for high-resolution measurements. The typical mass range for this technique

is 300 Da to about 6000 Da. FAB has been used for many years to obtain high-resolution mass data of especially higher masses from easy-to-fragment molecules.

### 9.3.2.2 Secondary Ion Mass Spectrometry (SIMS)

**Dynamic SIMS** is nearly identical to FAB except that the primary particle beam is an ion beam (usually cesium ions) rather than a neutral beam. The ions can be focused and accelerated to higher kinetic energies than are possible for neutral beams, and sensitivity is improved for higher masses. This technique, in use for a long time for moderate-sized (3000 to 13,000 Da) proteins and peptides, has now been largely replaced by **electrospray ionization** techniques.

### 9.3.3 Atmospheric Pressure Ionization

In these methods, a solution containing the analyte is sprayed at atmospheric pressure into an interface to the vacuum of the mass spectrometer ion source. The sample is desolvated to ions as they enter the ion source. These methods are widely used in flow-injection and LC-MS techniques.

#### 9.3.3.1 Electrospray Ionization (ESI)

In ESI, the sample solution is sprayed across a high potential difference (a few kilovolts) from a needle into an orifice in the interface. Heat and gas flows (typically nitrogen) are used to desolvate the ions existing in the sample solution. **Electrospray ionization** can produce multiply charged ions, with the number of charges tending to increase as the molecular weight increases. It is popular for flow injection of, especially, proteins and as an LC-MS interface and is compatible with MS-MS methods and complementary to atmospheric pressure chemical ionization (APCI). The method is not good for uncharged, nonbasic, low-polarity compounds (e.g., steroids). The range of masses covers molecules up to 200,000 Da.

#### 9.3.3.2 Atmospheric Pressure Chemical Ionization (APCI)

This method uses a similar interface to that used for ESI. In APCI, however, a corona discharge is used to ionize the analyte in the atmospheric pressure region. The gas-phase ionization in APCI is more effective than ESI for analyzing less-polar species. ESI and APCI are complementary methods. This is a good method for less-polar compounds, is an excellent LC-MS interface, and is compatible with MS-MS methods.

### 9.3.4 Laser Desorption

**Laser desorption** methods use a pulsed laser to desorb species from a target surface. Therefore, one must use a mass analyzer, such as time-of-flight (TOF) or Fourier transform ion cyclotron resonance (FTICR), which is compatible with pulsed ionization methods. Direct laser desorption relies on the very rapid heating of the sample or sample substrate to vaporize molecules so quickly that they do not have time to decompose. This is good for low- to medium-molecular-weight compounds. The more recent development of matrix-assisted laser-desorption ionization (MALDI) relies on the absorption of laser energy by a matrix compound. MALDI has become extremely popular as a method for the rapid determination of high-molecular-weight compounds (proteins).

#### 9.3.4.1 Matrix-Assisted Laser-Desorption Ionization (MALDI)

In MALDI, the analyte is dissolved in a solution containing an excess of a matrix, such as sinapinic acid or dihydroxybenzoic acid, that has a chromophore that absorbs at the laser wavelength. A small amount of this solution is placed on the laser target. The matrix absorbs the energy from the laser pulse and produces a plasma that results in vaporization and ionization of the analyte. MS-MS experiments tend to be difficult when using this technique; however, it offers the largest mass range up to 500,000 Da.

### 9.3.5 Mass Analyzers

The next component in the mass spectrometer is the **mass analyzer**, which sorts different ions. All commonly used mass analyzers use electric and magnetic fields to apply a force on charged particles (ions), which then is used to distinguish the different mass/charge ( $m/z$ ) ratios that are generated in the ionization chambers.

#### 9.3.5.1 Scanning Mass Analyzers

In **scanning mass spectrometry**, one starts with a mixture of ions that have different mass-to-charge ratios and different relative abundances. Electromagnetic fields separate the ions according to their mass-to-charge ratios, and a slit serves as a selector of which mass-to-charge ratio reaches the detector. Because we are able to control the electromagnetic fields, we can adjust which mass-to-charge ratios reach the detector slit — we scan different mass-to-charge ratios — and the ion current is recorded as a function of time (mass).

Commonly used designs for scanning mass spectrometers are **magnetic field sector** instruments and **quadrupole** instruments.

##### 9.3.5.1.1 Magnetic Sector Mass Spectrometers

In a **magnetic deflection mass spectrometer**, ions leaving the ion source are accelerated to a high velocity by means of an electric field. The ions then pass through a magnetic sector in which the magnetic field is applied in a direction perpendicular to the direction of ion motion. Changing the magnetic field characteristics allows for the scanning of different mass-to-charge ratios. In combination with an electric field sector (double focusing), this technique allows for accurate mass measurements, quantitation, and isotope ratio measurements. Magnetic sector instruments are very often used to obtain high-resolution data.

##### 9.3.5.1.2 Quadrupole Mass Analyzer Spectrometers

The **quadrupole mass analyzer** is a “mass filter.” Combined DC and RF potentials on the quadrupole rods can be set to pass only a selected mass-to-charge ratio. In a **quadrupole**, which consists of a pair of rods with a positive potential and a pair of rods with a negative potential, one pair is used to select for molecular weight higher than a threshold, whereas the other selects for a mass lower than a certain threshold. Overall, this serves as a narrow mass filter, and only limited mass-to-charge ratios find their way through the quadrupole. All other ions do not have a stable trajectory through the quadrupole mass analyzer and will collide with the quadrupole rods, never reaching the detector. Quadrupole analyzers are found in the majority of benchtop GC-MS and LC-MS systems; however, they have a fairly limited mass resolution.

#### 9.3.5.2 Time-of-Flight (TOF) Mass Analyzer Spectrometer

A **time-of-flight mass analyzer** measures the mass-dependent time it takes ions of different masses to move from the ion source to the detector. This requires that the starting time (the time at which the ions leave the ion source) be well defined. Therefore, ions are formed by a pulsed ionization method (usually **MALDI**), or various kinds of rapid electric field-switching techniques are used as a “gate” from which to release the ions from the ion source in a very short time. Time-of-flight allows for the fastest analysis of mass spectra.

#### 9.3.5.3 Trapped-Ion Mass Analyzers

There are two principal **trapped-ion mass analyzers**: three-dimensional **quadrupole ion traps** (“dynamic” traps) and **ion cyclotron resonance mass spectrometers** (“static” traps). Both operate by storing ions in the trap and manipulating the ions by using DC and RF electric fields in a series of carefully timed events. This provides some unique capabilities, such as extended MS-MS experiments, very high resolution, and high sensitivity. The trade-off is that trapping the ions for long periods of time

(milliseconds to days) provides plenty of time for the ions to fall apart spontaneously (unimolecular decomposition) and to experience undesirable interactions with other ions (space charge effects), neutral molecules (ion–molecule reactions), or perturbations in the ion motion due to imperfect electric fields.

#### 9.3.5.3.1 Ion Cyclotron Resonance

Ions move in a circular path in a magnetic field. The cyclotron frequency of the ion's circular motion is mass dependent. By measuring the cyclotron frequency, one can determine an ion's mass. A group of ions with the same mass-to-charge ratio will have the same cyclotron frequency, but they will be moving independently and out of phase at roughly thermal energies. If an excitation pulse is applied at the cyclotron frequency, the “resonant” ions will absorb energy and be brought into phase with the excitation pulse. As ions absorb energy, the size of their orbits increase. The packet of ions passes close to the receiver plates in the ICR cell and induces image currents that can be amplified and digitized. The signal induced in the receiver plates depends on the number of ions and their distance from the receiver plates. If several different masses are present, then one must apply an excitation pulse that contains components at all of the cyclotron frequencies. This is done by using a rapid frequency sweep (“chirp”), an “impulse” excitation, or a tailored waveform. The image currents induced in the receiver plates will contain frequency components from all of the mass-to-charge ratios. The various frequencies and their relative abundances can be extracted mathematically by using a **Fourier transform**, which converts a time-domain signal (the image currents) to a frequency-domain spectrum (the mass spectrum).

Most FTICR mass spectrometers use superconducting magnets, which provide a relatively stable calibration over a long period of time. FTICR offers the highest recorded mass resolution of all mass spectrometers, powerful capabilities for ion chemistry and tandem-MS capabilities.

### 9.3.6 MS-MS Experiments

With the introduction of milder ionization techniques, chemists sought to regain the structural information provided by fragmentation processes, which are so often used in EI spectra. As a result, **MS-MS** was developed, which uses a combination of mass spectrometers (tandem-MS) to achieve this job. In a first mass spectrometer, ions are generated, and mass-to-charge ratios under investigation are selected in a mass analyzer. These ions are then passed into a collision chamber, where collisions with a gas are initiated that lead to fragmentation. These newly generated “daughter ions” are then analyzed in a second mass analyzer.

### 9.3.7 Illustrative Examples of EI Mass Spectra

#### 9.3.7.1 Benzylalcohol

For benzylalcohol (Figure 9.59 and Figure 9.60), we assume  $m/z = 108$  to be the molecular ion, which suggests, according to the nitrogen rule, that there is no nitrogen atom (or an even number of nitrogen atoms). Inspection of the largest two peaks in the spectrum 108 and 109 and their respective intensities 100% and 7.7% allows us to estimate how many carbon atoms are involved. Taking into account that the natural abundance of  $^{13}\text{C}$  is 1.1%, the value of 7.7% for the  $[M+1]$  ion supports seven carbons. Using

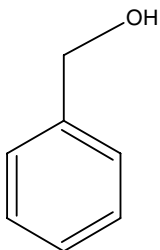

FIGURE 9.59 Structure of benzylalcohol.



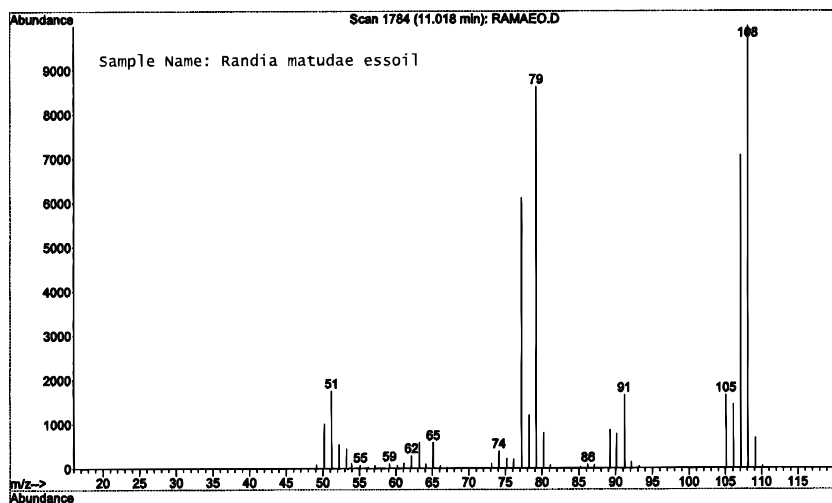

FIGURE 9.60 Electron ionization mass spectrometry (EI-MS) of benzylalcohol.

this as a starting point, we could account for  $7 \times 12 = 84$  amu in our molecular ion of  $m/z = 108$ . This leaves us with 24 amu. We also recognize a fragment at  $m/z = 91$ , which accounts for a difference of 17 amu typical for the loss of OH. Taking this into account allows us to place one oxygen in the structure and leaves us with eight hydrogens. Because the general formula of a hydrocarbon containing one oxygen is  $C_nH_{2n+2}O$ , we should expect for a hydrocarbon in our case ( $n = 7$ ), 16 hydrogens. The difference to our proposed eight hydrocarbons can be accounted for when we assume that we have three sites of unsaturation (double bond) and a ring system. Each would account for two hydrocarbons less, thus leaving us with the proposed eight hydrocarbons. This supports the idea of benzylalcohol. A benzylic compound is further supported by the typical fragmentation patterns consisting of 91/77/51. The major fragmentations occurring in the mass spectrum of benzylalcohol are shown in Figure 9.61.

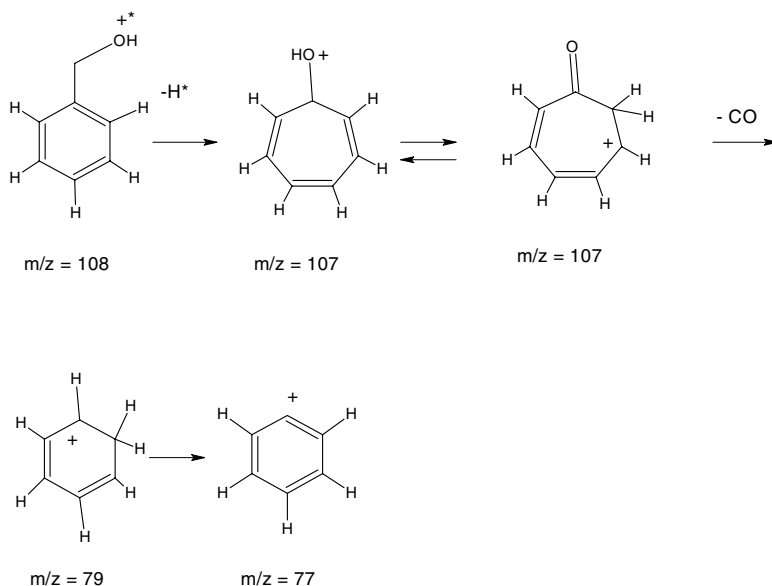

FIGURE 9.61 Fragmentation of benzylalcohol.

### 9.3.7.2 Germacrene D

For germacrene D (Figure 9.62), we assume  $m/z = 204$  to be the molecular ion, which suggests, according to the nitrogen rule, that there is no nitrogen atom (or an even number of nitrogen atoms). Inspection of the largest three peaks in the spectrum (see Figure 9.63), 204, 205, and 206, and their respective intensities, 17.84, 2.91, and 0.24%, allows us to estimate how many carbon atoms are involved. Normalizing the 17.84 to 100% gives 16.31% for  $m/z = 205$ , and 1.35% for 206. Taking into account that the natural abundance of  $^{13}\text{C}$  is 1.1%, the value of 16.31% for the  $[\text{M}+1]$  ion supports 15 carbons. The chance to find an isomer with two  $^{13}\text{C}$ -isotopes is  $(1.1 \times 10^{-2}) \times (1.1 \times 10^{-2}) = 1.21 \times 10^{-4}$  with 15 carbons that would account to 0.18%. Using this as a starting point, we could account for  $15 \times 12 = 180$  amu in our molecular ion of  $m/z = 204$ . This leaves us with 24 amu.

Because the general formula of a hydrocarbon is  $\text{C}_n\text{H}_{2n+2}$ , we should expect in our case ( $n = 15$ ) 32 hydrocarbons. As a result, we have to account for four double bonds or rings in our analyte. In the case of germacrene D, we have three double bonds and one ring system. Starting from the  $[\text{M}]^+$  peak at  $m/z = 204$ , there is a large gap to the most abundant peak in the spectrum  $m/z = 161$ . This difference (43 amu) accounts for a loss of a propyl group. Notably, in the spectrum, we see a large number of losses of 14 ( $161 \rightarrow 147 \rightarrow 133 \rightarrow 119 \rightarrow 105 \rightarrow 91$ ), accounting for the loss of methylene groups, which is typical for hydrocarbons. The stability of the ion at  $m/z = 161$  can be easily explained through conjugation, where the cation resulting from a loss of the isopropyl radical leads to a resonance-stabilized carbocation (Figure 9.64). The positive identification of germacrene D, however, would not be possible without comparing it to reference spectra, as there is a large number of possible isomers. Important to note here is that, generally, it is not only the mass spectrum but also the retention time, or better to say **retention index (RI)**, that positively identify a given compound.

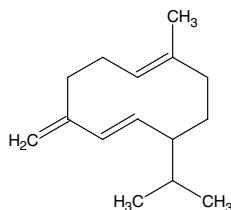

FIGURE 9.62 Structure of germacrene D.

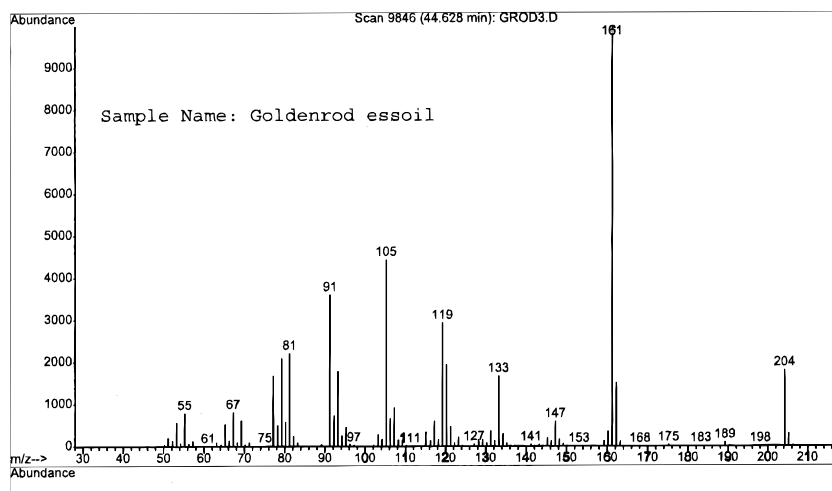

FIGURE 9.63 Electron ionization mass spectrometry (EI-MS) of germacrene D.

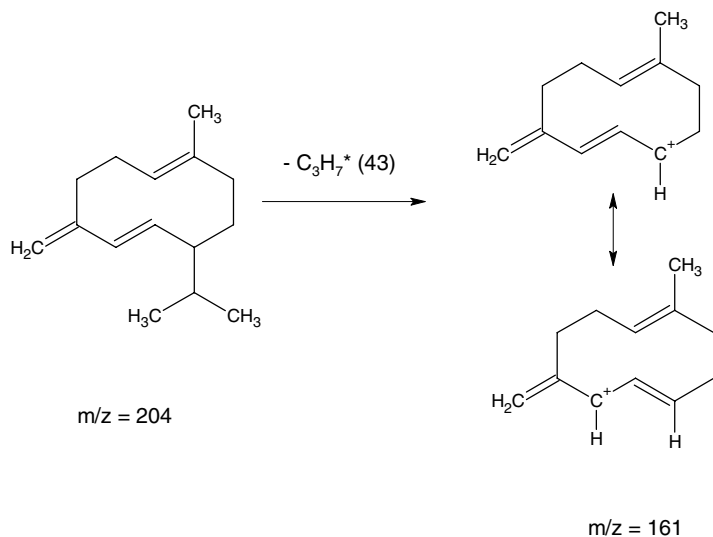
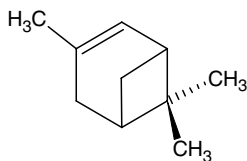
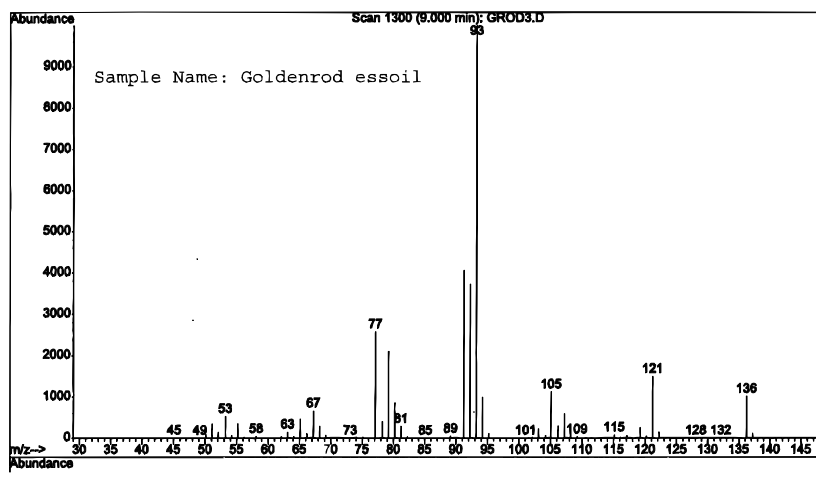

FIGURE 9.64 Fragmentation of germacrene D.

### 9.3.7.3 $\alpha$ -Pinene

For  $\alpha$ -pinene (Figure 9.65), we assume  $m/z = 136$  to be the molecular ion (see Figure 9.66), which suggests, according to the nitrogen rule, that there is no nitrogen atom (or an even number of nitrogen atoms). Inspection of the largest three peaks in the spectrum (136, 137) and their respective intensities (10.14, 1.17, and 0.065%) allows us to estimate how many carbon atoms are involved. Normalizing the

FIGURE 9.65 Structure of  $\alpha$ -pinene.FIGURE 9.66 EI-MS of  $\alpha$ -pinene.

10.14 to 100% gives 11.54% for  $m/z = 137$ , which therefore supports ten carbons. This then leads to 16 amu remaining. Based on the general formula of  $C_nH_{2n+2}$ , we should expect for a hydrocarbon in our case ( $n = 10$ ), 22 hydrocarbons. As a result, we have to account for three double bonds or rings in our analyte. Comparing with reference spectra leads to the identification of  $\alpha$ -pinene.

### 9.3.7.4 Linalool

For linalool (Figure 9.67), we assume  $m/z = 154$  to be the molecular ion, which suggests, according to the nitrogen rule, that there is no nitrogen atom (or an even number of nitrogen atoms). Inspection of the largest two peaks in the spectrum (154, 155) and their respective intensities (0.498 and 0.059%) allows us to estimate how many carbon atoms are involved. Normalizing the 0.498 to 100% gives 11.85% for  $m/z = 155$ . Taking again into account that the natural abundance of  $^{13}C$  is 1.1%, the value of 11.85% for the  $[M+1]$  ion supports ten carbons. Thus, we could account for  $10 \times 12 = 120$  amu in our molecular ion of  $m/z = 154$ . This leaves us with 34 amu. We also recognize a fragment at  $m/z = 136$ , which accounts for a difference of 18 amu to the molecular ion at  $m/z = 154$ , typical for the loss of water and, therefore, suggesting an alcohol. With 34 amu, only one oxygen would be supported, thus bringing the number of hydrogens to 18. Two oxygen atoms would be unlikely because our molecule would then have only two hydrogens. Because the general formula of a hydrocarbon containing one oxygen is  $C_nH_{2n+2}O$ , we should expect for a hydrocarbon in our case ( $n = 10$ ), 22 hydrocarbons. As a result, we have to account for three double bonds or rings. Starting from the  $[M]^+$  peak at  $m/z = 154$ , we find the following fragments  $136 \rightarrow 121 \rightarrow 107 \rightarrow 93 \rightarrow 79 \rightarrow 65 \rightarrow 51$ , which in each case is a difference of 14 amu, thus strongly suggesting a hydrocarbon chain.

A definite answer in this case again can be made only by comparison with a reference spectrum.

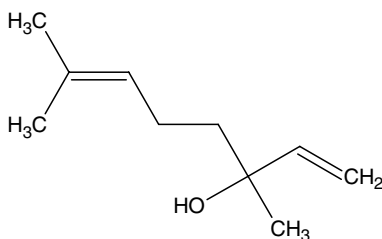

FIGURE 9.67 Structure of linalool.

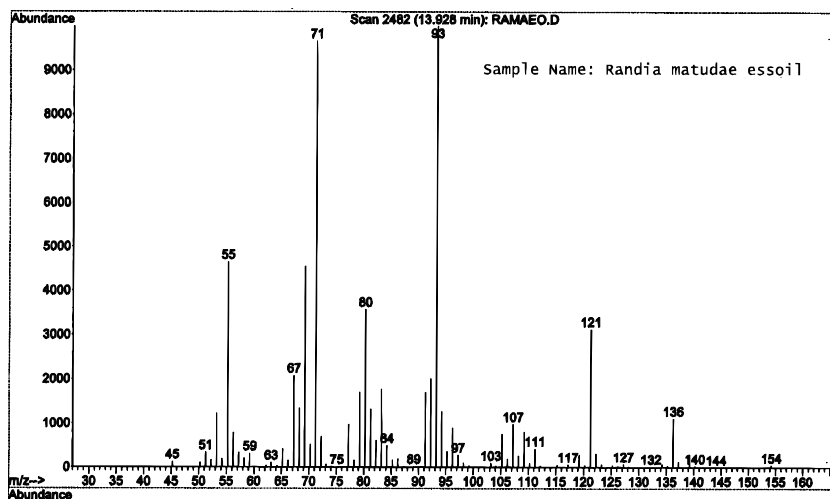

FIGURE 9.68 EI-MS of linalool.

## 9.4 UV-Vis, IR Spectroscopy

### 9.4.1 UV-Vis

The use of **UV-Vis (ultraviolet visible)** spectroscopy in the structure elucidation process is limited. Nevertheless, UV-Vis spectroscopy plays an important role as probably the most often used tool for detection in separations. It also finds wide applications in quantitative analysis, not only in the context of separations, but also, for a large number of assay techniques, where chromophores are used to assess biochemical reactions. Quantitative applications are based on **Beer–Lambert’s law**:

$$A = \log(I_0/I) = \epsilon lC$$

where  $A$  = absorbance, an optical parameter measured with a spectrophotometer,  $I$  = intensity of light leaving sample cell,  $I_0$  = intensity of light incident upon sample cell,  $l$  = length of the sample cell,  $C$  = molar concentration, and  $\epsilon$  = molar absorptivity.

The typical wavelength range of a spectrometer covers 190 to 800 nm. UV spectra are typically recorded as a plot of absorbance versus wavelength; however, only very few are reproduced in chemical literature. Typically, wavelengths of band maxima are reported along with their respective absorptivities.

All organic compounds absorb UV radiation; thus, solvents also have UV absorption. When measuring UV spectra or intensities, solvent cutoffs must be taken into consideration. Some cutoffs are provided in Table 9.6.

For most of the natural products we deal with, there are only a few types of chromophores that we use to probe our samples in assays or HPLC separations. Especially useful in this context are chromophores that have one or more double bonds. If these double bonds are conjugated, we can easily reach absorption maxima in the range of 280 to 350 nm or even larger. Mostly, however, the maxima of chromophores fall in the range up to 220 nm (see Table 9.7).

In the case of conjugated double-bond systems, such as dienes, enones, and some benzene derivatives, **Woodward–Fieser rules** are commonly used to estimate the UV maxima of compounds.

### 9.4.2 IR Spectroscopy

Analytical **infrared (IR) spectroscopy** covers several methods that are based on the absorption of electromagnetic radiation with wavelengths in the range of 1 to 1000  $\mu\text{m}$ . This spectral range is typically divided into near-IR (1 to 2.5  $\mu\text{m}$ ), mid-IR (2.5 to 25  $\mu\text{m}$ ), and far-IR (larger than 25  $\mu\text{m}$ ). Mid-IR is the range that is richest in structural information and is the easiest to access. This spectral range is not only used to determine functional groups of a molecule, but it also provides characteristic fingerprint

**TABLE 9.6**

Solvent Cutoffs

Solvent	Cutoff [nm]	Solvent	Cutoff [nm]	Solvent	Cutoff [nm]
Acetonitrile	190	Methanol	205	Water	205
95% Ethanol	205	Isooctane	195	<i>n</i> -Hexane	201
Cyclohexane	195	Chloroform	240	1,4-Dioxane	215

**TABLE 9.7**

Simple Isolated Chromophores

Chromophore	$\lambda(\text{nm})$	Chromophore	$\lambda(\text{nm})$	Chromophore	$\lambda(\text{nm})$
R-OH	180	R-O-R	180	R-NH <sub>2</sub>	190
R-CN	160	R-CHO	190/290	R <sub>2</sub> CO	180/280
R-COOH	205	R-COOR	205		

TABLE 9.8

Important Group Frequencies for IR Spectroscopy

	4000	3500	3000	2500	2000	1900	1800	1700	1600	1500	1400	1300	1200	1100	1000	900	800	700
Alkanes			-C-H							-CH <sub>2</sub> and CH <sub>3</sub>								CH <sub>2</sub> / <sub>3/4</sub>
Alkenes			C=C-H					C=C										
Alkynes			C≡C-H		C≡C													
Aromatics			C=C-H							C=C								
Alcohols\		O-H											O-H					
Phenols																		
Ethers																		
Aldehydes			O=C-H					C=O										
Ketones								sat.		unsat.								
								C=O										
Esters								sat.		unsat.								
Acids			O-H(Dimer)					C=O										
Amines		N-H																
		Prim.																
Amides		Sec.																

regions that can be used to uniquely identify compounds. For IR measurements, it is common to report wavelengths in terms of wave numbers  $\nu$  ( $\text{cm}^{-1}$  or *kaysers*). All observable IR bands are due to the interaction of the electrical vector of the electromagnetic radiation with the electric dipole of nonsymmetrical bonds. It turns out that IR spectroscopy can easily be used as a semiempirical method for structural analysis because it was observed that there is a good correlation between the position of band maxima and organic functional groups or structural characteristics.

Typical group frequencies often found in natural products are listed in Table 9.8.

## 9.5 Hyphenated Techniques

### 9.5.1 GC-MS

The combination of **gas chromatography (GC)** and **mass spectrometry (MS)** for the detection and identification of constituents of essential oils has become a powerful analytical tool in phytochemical analysis. The sample to be analyzed is injected into the GC, where it is swept through a capillary column by an inert gas stream. The components of the sample are separated based on their differential adsorptive interactions with the liquid phase of the GC column. The separated components, then, individually pass through the mass spectrometer, where ionization, fragmentation, and mass detection take place. The GC-MS combination allows for the separation of essential oil components and the acquisition of mass spectra of the separated components. Utilization of GC retention data along with MS fragmentation and comparison with spectral libraries allows for compound identification.

In the following two examples, goldenrod (*Solidago canadensis*) leaf essential oil and *Randia matudae* floral essential oil were analyzed by GC-MS. In these studies, the essential oils were analyzed using an Agilent 6890 GC with Agilent 5973 (Agilent Technologies, Palo Alto, CA) mass selective detector, a fused silica capillary column (HP-5ms, 30 m  $\times$  0.25 mm), helium as the carrier gas, 1 ml/min flow rate,

and splitless injection. The injector temperature was 200°C, and the oven temperature was programmed as follows: 40°C initial temperature, hold for 10 min; increased at 3°/min to 200°C; increased 2°/min to 220°C. The MS detector temperature was 280°C.

**Retention indices (RIs)** of the essential oil components were determined by reference to a homologous series of normal alkanes. Thus, a mixture of alkanes (*n*-octane through *n*-triacontane) is injected into the GC-MS system and analyzed using the temperature program above. The retention indices of the alkanes are defined as *n*-octane = 800, *n*-nonane = 900, *n*-decane = 1000, and so on. A plot of RI versus retention time for the homologous alkanes is used as a standard curve to determine the RIs of the components of the essential oils. RIs for essential oil components can then be compared with published RIs. An excellent compilation of GC RIs along with MS fragmentation patterns can be found in the literature (Adams, 1995). Mass spectral fragmentations of the individual essential oil components are compared with the NIST library of mass spectra (through the ChemStation data system of the instrument) as well as mass spectra compiled in Adams (1995).

### 9.5.1.1 *Solidago canadensis* (Goldenrod) Leaf Essential Oil

Goldenrod (*Solidago canadensis*, Asteraceae) leaf oil was obtained from Young Living Essential Oils™. The essential oil has been used as an antihypertensive, antiseptic, and anti-inflammatory treatment (Sheppard-Hanger, 1994). The leaf oil components, as revealed by GC-MS, are listed in Table 9.9 (see Figure 9.69 for GC/TIC of *S. canadensis* leaf oil). This sample of goldenrod leaf oil was made up largely of **monoterpene** hydrocarbons (42.1%) and **sesquiterpene** hydrocarbons (51.2%), with smaller amounts of oxygenated monoterpenoids (5.3%) and oxygenated sesquiterpenoids (1.4%). The most abundant essential oil components were **germacrene D** (34.4%), **α-pinene** (13.3%), **limonene** (11.0%), **sabinene** (8.0%), and **myrcene** (6.3%). Previous examinations of goldenrod leaf oil showed germacrene D to be the most abundant component in agreement with this work. However, Schmidt and co-workers (1999) found **cyclocolorenone** to be a major component (38%) in goldenrod from northern Germany, and Kasali and co-workers (2002) found **6-epi-β-cubebene** to be a major component (21%) in goldenrod oil from Poland. Interestingly, neither of these compounds was detected in our sample of goldenrod leaf oil.

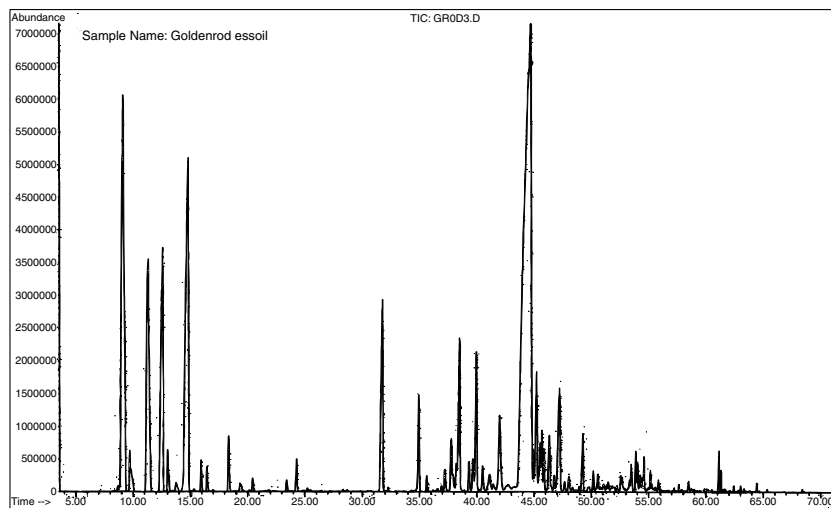

FIGURE 9.69 Total ion current (TIC) chromatogram of *Solidago canadensis* leaf essential oil.

TABLE 9.9

Chemical Composition of *Solidago canadensis* Leaf Essential Oil

RT (min)	RI (this work)	RI (Adams, 1995)	Compound	TIC	Area (%)	QI (%)
6.29	926	931	$\alpha$ -Thujene	14267895	0.1	93
6.69	937	939	$\alpha$ -Pinene	2410743795	13.3	97
7.09	951	953	Camphene	188128784	1.0	97
8.19	977	976	Sabinene	1458932480	8.0	97
9.14	992	991	Myrcene	1136301605	6.3	94
9.42	1005	1005	$\alpha$ -Phellandrene	122999988	0.7	95
10.03	1018	1018	$\alpha$ -Terpinene	26806547	0.1	98
10.84	1031	1031	Limonene	1999018401	11.0	97
11.00	1038	1040	<i>cis</i> - $\beta$ -Ocimene	Trace	Trace	97
11.42	1046	1050	<i>trans</i> - $\beta$ -Ocimene	74862331	0.4	98
11.83	1055	1062	$\gamma$ -Terpinene	59481695	0.3	96
13.18	1085	1088	$\alpha$ -Terpinolene	151740515	0.8	98
13.76	1099	1098	Linalool	21398967	0.1	97
13.95	1103	1102	<i>cis</i> -Thujone	21411433	0.1	96
16.71	1167	1165	<i>endo</i> -Borneol	32969900	0.2	91
17.33	1181	1177	4-Terpineol	86930061	0.5	97
17.94	1186	1189	$\alpha$ -Terpineol	Trace	Trace	91
22.55	1290	1285	Bornyl acetate	783472731	4.3	98
22.65	1292	1289	Lavandulyl acetate	Trace	Trace	91
24.66	1339	1339	$\delta$ -Elemene	265223743	1.5	97
25.11	1350	1351	$\alpha$ -Cubebene	39463740	0.2	98
25.78	1366	1368	Cyclosativene	Trace	Trace	—
25.99	1371	1372	$\alpha$ -Ylangene	14918082	0.1	98
26.21	1376	1376	$\alpha$ -Copaene	70914454	0.4	98
26.61	1386	1384	$\beta$ -Bourbonene	202636829	1.1	98
26.85	1391	1390	$\beta$ -Cubebene	53405846	0.3	97
27.14	1398	1391	$\beta$ -Elemene	602259710	3.3	99
27.70	1411	1409	$\alpha$ -Gurjunene	70873350	0.4	99
28.19	1423	1418	$\beta$ -Caryophyllene	440399535	2.4	99
28.47	1431	1432	$\beta$ -Gurjunene	54073684	0.3	—
28.79	1438	1436	<i>trans</i> - $\alpha$ -Bergamotene	63635862	0.4	95
29.49	1455	1454	$\alpha$ -Humulene	320387818	1.8	98
30.23	1474	1473	$\gamma$ -Gurjunene	25335774	0.1	—
30.56	1482	1480	Germacrene-D	6248063891	34.4	98
31.67	1513	1513	$\gamma$ -Acoradiene	342269365	1.9	—
32.01	1521	1524	$\delta$ -Cadinene	247216321	1.4	97
32.82	1537	1532	Cadina-1,4-diene	26142658	0.1	97
32.98	1543	1538	$\alpha$ -Cadinene	37099932	0.2	98
33.43	1554	1549	Elemol	12296703	0.1	91
33.74	1561	1556	Germacrene-B	163401105	0.9	99
34.04	1568	1564	Nerolidol	55312814	0.3	94
34.47	1578	1576	Spathulenol	60891526	0.3	99
34.95	1589	1590	Viridiflorol	28119678	0.2	99
37.04	1638	1640	$\tau$ -Cadinol	31597439	0.2	—
37.34	1644	1641	$\tau$ -Muurolol	75030447	0.4	90
38.01	1673	1674	Cadalene	Trace	Trace	86

Note: RT = Retention time; RI = retention index; TIC = total ion count; Area = % based on TIC; and QI = quality index based on agreement with NIST reference spectrum.



### 9.5.1.2 *Randia matudae* Floral Essential Oil

*Randia matudae* (Rubiaceae) is a subcanopy tree, 10 to 20 m tall, found in Mexico and Costa Rica (Haber et al., 2000). The flowers of this tree produce a strong fragrance at night that serves to attract hawk moths (Sphingidae) that feed on nectar as well as pollinate this species. The GC of *R. matudae* floral essential oil is shown in Figure 9.70, and the floral essential oil composition is compiled in Table 9.10.

## 9.5.2 LC-MS

Mixture analysis using chromatographic techniques such as GC-MS has a long history in natural products chemistry, but many of the earlier investigations were hampered by the low volatility of a large number of compounds, such as polyphenols. With the introduction of APCI and ESI interfaces, the chromatographic process could be extended to liquid chromatography applications that allow for the analyses of compounds regardless of their volatility. Whereas GC-MS investigations provide some structural information (EI MS fragmentation), ESI and APCI tend to give only molecular weight information. To enhance structural information, **tandem mass spectrometry (MS-MS)** experiments can be performed. Wide use of these techniques led to affordable benchtop instruments, and LC-MS has grown into one of the most important and most widely used analytical techniques in natural products analysis.

### 9.5.2.1 *Ligusticum chuangxiong*

The *n*-hexane extract of *Ligusticum chuangxiong* could be clearly separated by **reversed-phase HPLC** analysis (Zschocke et al., 2005). Figure 9.71 shows the HPLC chromatogram that is the basis by which to analyze four of the apparent six peaks.

The peaks labeled 1 through 4 in the chromatogram give the APCI mass spectra shown in Figure 9.72. These spectra, which commonly show a  $[M+H]^+$  ion and a  $[M+CH_3CN+H]^+$  ion, are consistent with the structures shown in Figure 9.73.

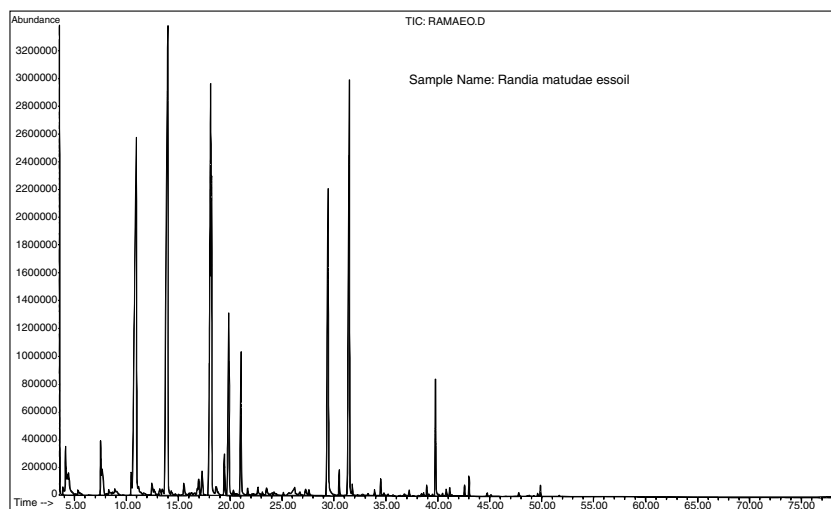

FIGURE 9.70 Total ion current chromatogram of *Randia matudae* floral essential oil.

TABLE 9.10

Chemical Composition of *Randia matudae* Floral Essential Oil

RT (min)	RI (this work)	RI (Adams, 1995)	Compound	TIC	Area (%)	QI (%)
3.88	850	—	3-Methyl-1-pentanol	3213209	0.2	83
4.14	857	851	<i>trans</i> -3-Hexenol	30147117	1.7	76
4.43	865	857	<i>cis</i> -3-Hexenol	14999060	0.8	83
5.34	890	—	2-Heptanol	Trace	Trace	83
7.53	967	961	Benzaldehyde	38369298	2.2	95
8.31	983	978	1-Octen-3-ol	Trace	Trace	80
8.89	995	—	6-Methyl-5-hepten-2-ol	Trace	Trace	95
10.48	1027	1033	1,8-Cineole	7314075	0.4	98
11.00	1036	1032	Benzyl alcohol	325325107	18.4	96
12.46	1075	1074	<i>cis</i> -Linalool oxide	5081315	0.3	87
12.67	1079	1076	Benzyl formate	Trace	Trace	98
13.22	1088	1088	<i>trans</i> -Linalool oxide	Trace	Trace	83
13.47	1093	1091	Methyl benzoate	Trace	Trace	91
14.01	1101	1098	Linalool	371838984	21.0	97
14.31	1111	1111	<i>cis</i> -Rose oxide	Trace	Trace	90
14.38	1112	1110	Phenethyl alcohol	Trace	Trace	76
15.53	1136	—	Methyl nicotinate	7364915	0.4	90
16.02	1146	1147	Veratrole	Trace	Trace	91
16.72	1165	1165	Borneol	Trace	Trace	90
16.97	1170	—	Linalool 3,7-oxide	10388645	0.6	87
17.29	1177	1177	4-Terpineol	13122235	0.7	95
18.15	1190	1189	$\alpha$ -Terpineol	235348277	13.3	91
18.23	1192	1190	Methyl salicylate	86455240	4.9	95
18.63	1200	—	C <sub>10</sub> H <sub>18</sub> O (monoterpene alcohol)	7032059	0.4	—
19.46	1218	—	<i>exo</i> -2-Hydroxycineole	16123992	0.9	90
19.89	1227	1228	Citronellol	82436046	4.7	96
21.06	1256	1255	Geraniol	55671645	3.1	87
21.68	1270	1270	Geranial	2586495	0.1	91
22.66	1293	1292?	<i>trans</i> -Verbenyl acetate	3540830	0.2	—
23.50	1310	—	C <sub>10</sub> H <sub>16</sub> O (monoterpene alcohol)	4003285	0.2	—
29.46	1449	1447	<i>trans</i> -Isoeugenol	156299544	8.8	96
30.52	1481	1480	Germacrene D	8607074	0.5	97
31.50	1500	1495	<i>trans</i> -Methyl isoeugenol	223328699	12.6	98
31.76	1507	1508	( <i>E,E</i> )- $\alpha$ -Farnesene	3296468	0.2	93
33.89	1566	1564	<i>trans</i> -Nerolidol	Trace	Trace	83
34.49	1581	1574	Dendrolasin	4997148	0.3	—
38.92	1697	—	2-Pentadecanone	3357401	0.2	89
39.11	1702	—	2-Hexadecanol	Trace	Trace	91
39.78	1720	1714	<i>trans</i> -Nerolidol acetate	35982150	2.0	91
41.15	1759	1762	Benzyl benzoate	2615652	0.1	96
42.57	1800	—	<i>cis</i> -11-Hexadecenal	3259107	0.2	94
43.01	1813	—	Hexadecanal	5706737	0.3	94
44.72	1863	—	<i>cis</i> -11-Hexadecen-1-ol	Trace	Trace	91
45.12	1875	1879	1-Hexadecanol	Trace	Trace	91
49.59	2011	2009	Hexadecyl acetate	Trace	Trace	91
49.86	2019	—	Phytopenaene	3067985	0.2	93

Note: Phytopenaene = (*E,E,E*)-3,7,11,15-tetramethylhexadeca-1,3,6,10,14-pentaene.

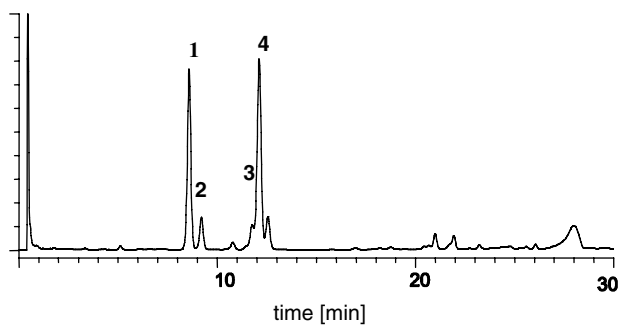

FIGURE 9.71 High-performance liquid chromatography (HPLC) chromatogram of *Ligusticum chuangxiang* extract with ultraviolet (UV) detection at 235 nm.

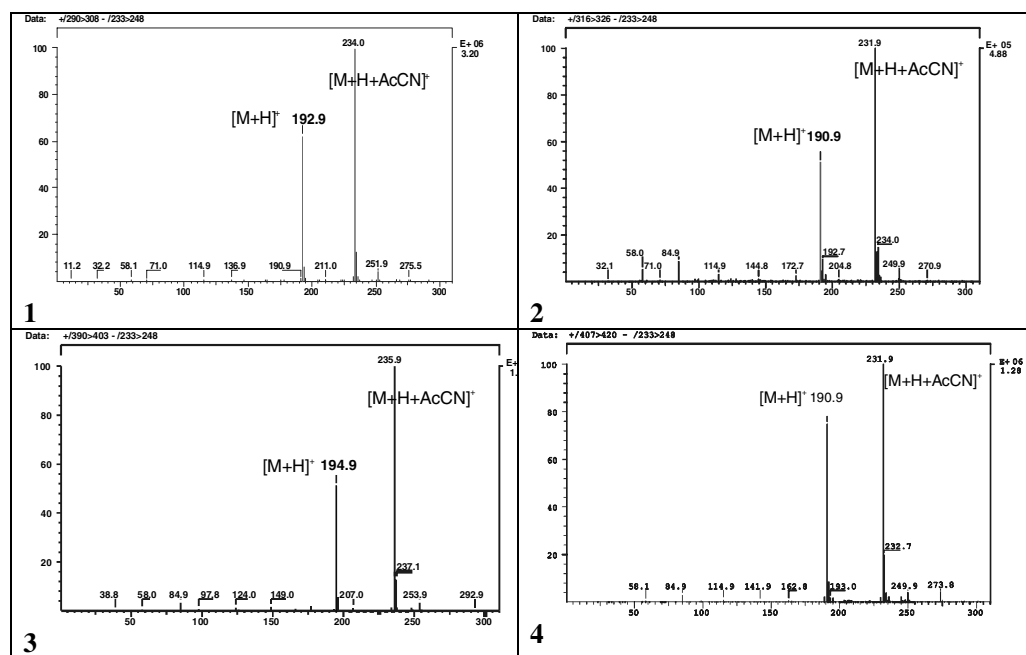

FIGURE 9.72 Atmospheric pressure chemical ionization mass spectrometry (APCI-MS) of peaks 1 to 4 of *Ligusticum chuangxiang* extract.

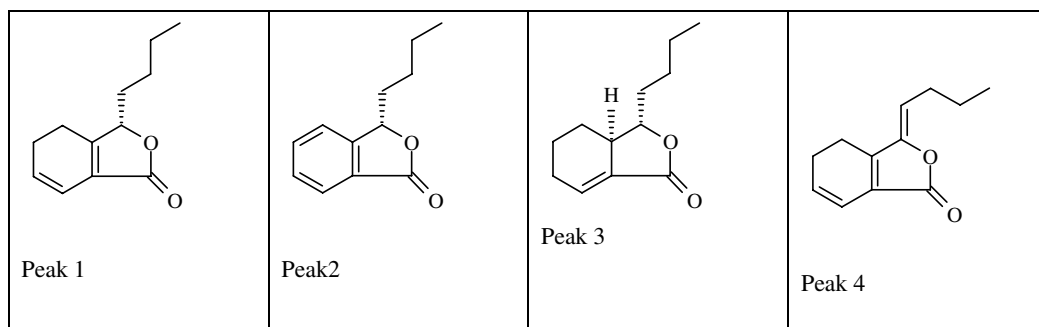

FIGURE 9.73 Structures identified in *Ligusticum chuangxiang* by liquid chromatography/mass spectrometry (LC-MS).

### 9.5.2.2 Vernonia fastigiata

An example from an investigation of *Vernonia fastigiata* (Vogler et al., 1997) is presented, which illustrates the use of MS-MS spectra, as well as the use of single-ion monitoring. In this example, we deal with pairs of isomeric compounds ( $m/z = 421$  or  $423$ ), which nicely show up when using single-ion monitoring (see Figure 9.74). Furthermore, it was demonstrated that by monitoring the two ions at  $m/z = 275$  and  $m/z = 257$ , all but one compound belong to the same skeleton (see Figure 9.75, Figure 9.76, Figure 9.77, and Table 9.11).

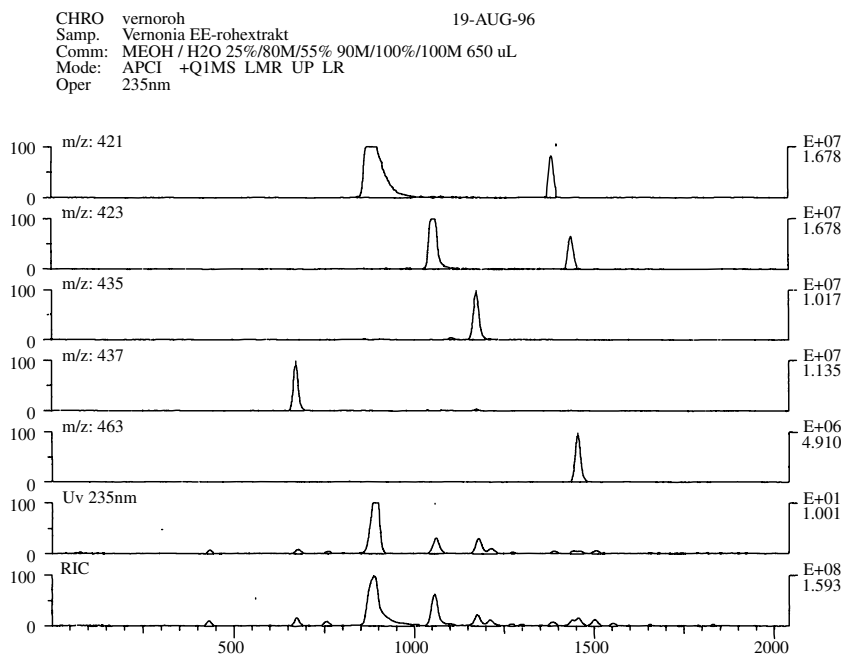

FIGURE 9.74 Single-ion monitoring of *Vernonia fastigiata* extract.

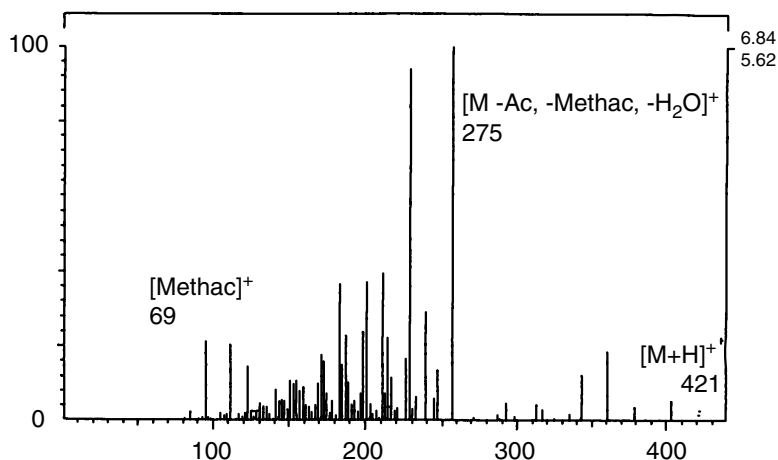

FIGURE 9.75  $m/z = 421$ , structure C, Table 9.11.

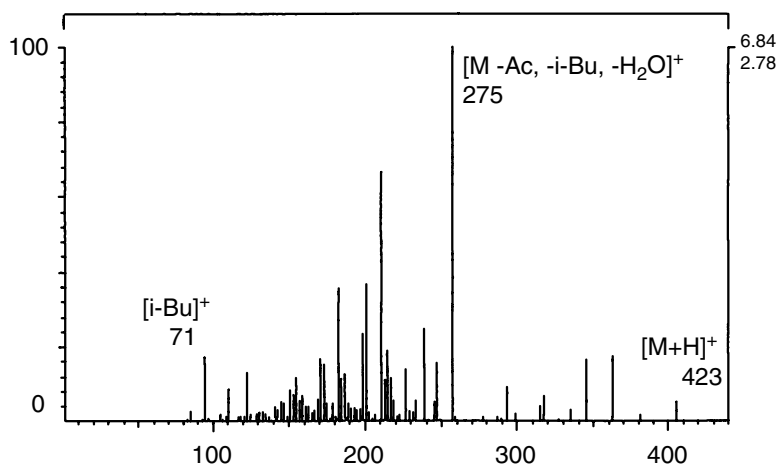

FIGURE 9.76  $m/z = 423$ , structure D, Table 9.11.

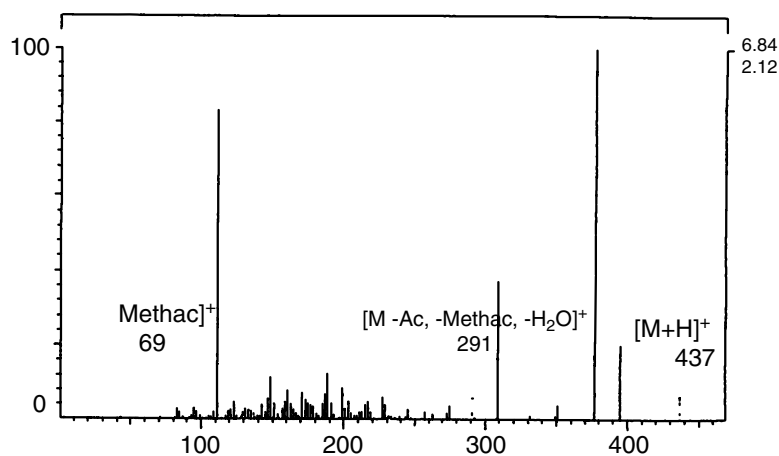

FIGURE 9.77  $m/z = 437$ , structure I, Table 9.11. All spectra taken under CID conditions using 2.5 mTorr argon, 18 V, vaporizer set at 200°C, nebulizer capillary at 70°C.

TABLE 9.11

Summary of MS Results for *Vernonia fastigiata*

	Results from APCI-LC-MS- Messungen								
	A	B	C	D	E	F	G	H	I
$m/z$ [M+H] <sup>+</sup>	379	381	421	423	435	463	421	423	437
$m/z$ [M+H-R <sub>2</sub> -R <sub>3</sub> ] <sup>+</sup>	275	275	275	275	275	275	275	275	291
$m/z$ [M+H-R <sub>1</sub> -R <sub>2</sub> -R <sub>3</sub> ] <sup>+</sup>	257	257	257	257	257	257	257	257	273
R <sub>1</sub>	H	H	H	H	H	Ac	H	H	H
R <sub>2</sub>	Methac	<i>i</i> -Bu	Methac	<i>i</i> -Bu	Ang	Methac	Methac	<i>i</i> -Bu	Methac
R <sub>3</sub>	H	H	Ac	Ac	Ac	Ac	Ac	Ac	Ac

Note: Methac = methylacryloyl, *i*-Bu = isobutyryl, Ang = angeloyl, Ac = acyl.

### 9.5.3 LC-NMR

Since LC-NMR became commercially available around 1997, a large number of applications of LC-NMR, especially in natural products research, were published. It appears that the foremost European groups — like those of Prof. Albert (University of Tübingen) (Krucker et al., 2004; Xiao et al., 2004; Glaser et al., 2003), Prof. Hostettmann (University of Lausanne) (Waridel et al., 2004; Queiroz et al., 2002; Ramm et al., 2004; Wolfender et al., 2003), Prof. Bringmann (University of Würzburg) (Bringmann et al., 1998, 1999, 2002), just to name probably the most active groups — put the application of LC-NMR, often in combination with LC-MS, into a new light. These authors, as well as others, demonstrated the application of LC-NMR to a wide range of natural products using only very little material.

Since its first appearance in the literature, the coupling of NMR with HPLC necessitated a wealth of technical improvements when compared to the situation some 10 years ago. HPLC, which was primarily used as an analytical method (due to the high costs for column material and solvents), could barely handle the necessary amounts of sample needed for former routine NMR instruments. In analytical HPLC of complex mixtures, single peaks often represent only several hundred nanograms or a few micrograms of a compound. Now, however, high field NMR instruments ( $\geq 500$  MHz) are accessible and provide much higher sensitivity for very small samples. Sensitivity was also improved by the employment of detection cells with smaller volumes (50 to 150  $\mu\text{l}$ ). This allows for measurements in the center of HPLC peaks, where concentration of the sample is highest. Improvements on the radiofrequency (RF) side — transmitter and receiver — of the spectrometers added further benefits that finally allow for the routine use of LC-NMR. In order to avoid the use of expensive deuterated organic solvents ( $\text{CD}_3\text{CN}$ ,  $\text{CD}_3\text{OD}$ ), efficient solvent suppression techniques were introduced. In addition, the introduction of inverse detection experiments enabled spectroscopists to extend their investigations to the less sensitive elementary nuclei. This was further improved by pulsed field gradient probes. Improvements in NMR experiments, in general, such as selective excitation techniques, opened up new possibilities in obtaining complete structural information. Despite all of these improvements, the amount of sample presents a challenge for NMR spectroscopy, which under these circumstances normally reaches the detection limit of the instrument.

Using gradient probe technology and detection cell volumes of 60 to 120  $\mu\text{l}$ , compounds with a molecular weight of 450 can be detected in on-flow runs in amounts as little as 10  $\mu\text{g}$ . For stop-flow, realistic limits are probably at 1  $\mu\text{g}$  and, in special cases, certainly lower. When we consider a typical HPLC peak width, which is most likely something around 500  $\mu\text{l}$ , we can estimate sample amounts to be in that range, the amount typically required for bioassays (see Chapter 10). When implementing the latest available techniques, like LC-SPE-NMR (Godejohann et al., 2004) with cold-probe technology, the amount of sample per HPLC peak being detectable will be dramatically reduced, so that the analytical part is well in the range of typical bioassay procedures. Using this technique, detection limits will reach the several nanogram range.

#### 9.5.3.1 Solvent Signals

Attempts to reduce solvent costs in LC-NMR have introduced serious difficulties. Due to the replacement of the deuterated solvents by their much cheaper protonated counterparts, a huge solvent peak (proton signal of the organic solvent) is added to the spectrum of the sample under study. To circumvent this problem, instruments are needed that are capable of dealing with the huge solvent signals and, at the same time, with the very small signals produced by the sample. Because receivers with sufficient dynamic range are not available to accomplish this, presaturation experiments were developed to eliminate or reduce unwanted solvent signals (Albert, 1995). For example, the signal of acetonitrile and the water signal originating from H/D exchange during chromatography can be irradiated through a second and third RF channel, respectively. However, this technique still has some drawbacks due to the short measurement time in LC-NMR. If a sample is pumped through the NMR probe with a flow rate of 1  $\text{ml}\cdot\text{min}^{-1}$ , the time required to replace all spins in a 60  $\mu\text{l}$  flow cell is about 4 sec. Because transmitter presaturation requires approximately 1 sec, it can only partially saturate solvent signals. This accounts for just one transient by itself. By adding the necessary acquisition time, one transient with transmitter presaturation takes 2 sec. Hence, a more efficient technique was introduced. With gradient probes and

more sophisticated NMR hardware (waveform generators) available, enhanced solvent suppression techniques such as **WET (water suppression enhanced through T<sub>1</sub>)** were introduced (Smallcombe et al., 1995). This technique combines shaped RF pulses, pulsed field gradients, shifted laminar pulses on the observation channel, and <sup>13</sup>C decoupling, and it reduces the time required for suppression to approximately 40 to 80 msec. An additional problem, the change of the relative position of the water signal versus the organic solvent during chromatographic gradients, must also be addressed. Only a proper determination of the solvent frequencies makes good solvent suppression possible. The change in the relative position of the solvent signals to each other is followed, for instance, by using scout scans that monitor these changes. The newly determined frequencies from the scout scan are then used for the automatic creation of shaped RF pulses. HPLC analysis is normally carried out under continuous flow of about 1 ml min<sup>-1</sup> until the end of the separation. This results in a short dwell time of the sample in the probe; thus, only short acquisition times are possible. Due to the detection limit, which can easily be reached under LC-NMR conditions, all analyses are limited to the more sensitive nuclei, like <sup>1</sup>H or <sup>19</sup>F (for pharmaceutical/metabolic research). This can be understood by the fact that the size of the NMR cell is in the range of 65 to 120 μl, which seems to be the optimum with respect to average chromatographic peaks (usually in the range of approximately 300 to 500 μl). This enables the spectroscopist to detect about 10 μg of a sample with a mass up to 500 mu, which is equivalent to a concentration of 0.2 mM. In ideal cases, all components are separated by the chromatographic conditions and are lined up in the corresponding LC-NMR run as separate <sup>1</sup>H spectra (Figure 9.78). A good LC-NMR run, however, is not determined only by well-separated peaks. At the same time, the narrowest possible HPLC peaks have to be achieved in order to increase the concentration of the analyzed peaks in the NMR flow cell. As mentioned earlier, solvent suppression must be used, although parts of the NMR spectrum get lost. Spectroscopic information about the compounds under study close to the solvent signal is not directly accessible. This drawback can be overcome by the subsequent use of two different solvent systems, preferably solvents with single NMR peaks like acetonitrile or methanol. In acetonitrile, the methyl group necessary to be suppressed resonates at 2 ppm, whereas in methanol, the methyl group resonates at 3.3 ppm. Furthermore, with respect to the aforementioned two signals of the methyl groups, the position of the exchanged water peak changes, so that by the combination of both LC-NMR runs, all necessary information is generally accessible (Figure 9.79). It is a well-known fact that different NMR parameters, chemical shifts, as well as coupling constants, are obtained for the same compound when determined in different solvents. The combined analysis of the spectra of both HPLC runs (methanol/D<sub>2</sub>O and acetonitrile/D<sub>2</sub>O) is possible, because, apparently, the solvent effect under LC conditions is mostly determined by the protic D<sub>2</sub>O conditions. Still, the solvent effect exists; thus, in comparison to the

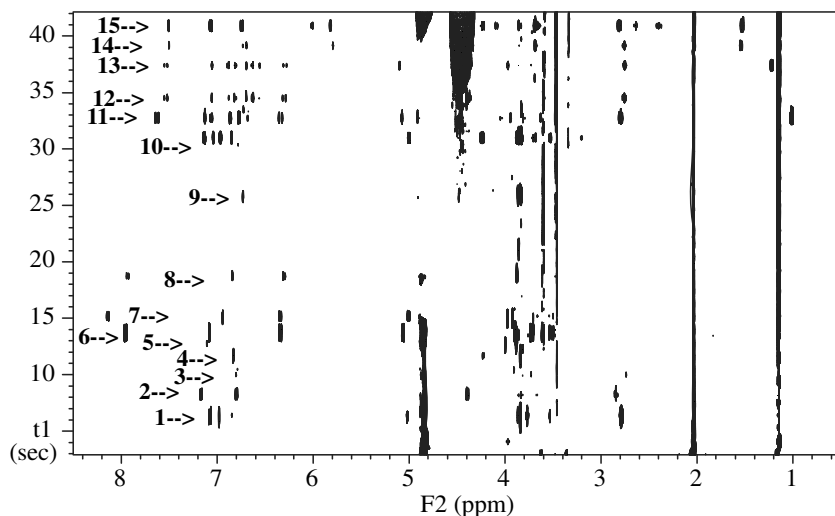

**FIGURE 9.78** On-flow high-performance liquid chromatography nuclear magnetic resonance (on-flow-HPLC-NMR) of *Fraxinus* spp. using methanol/D<sub>2</sub>O.

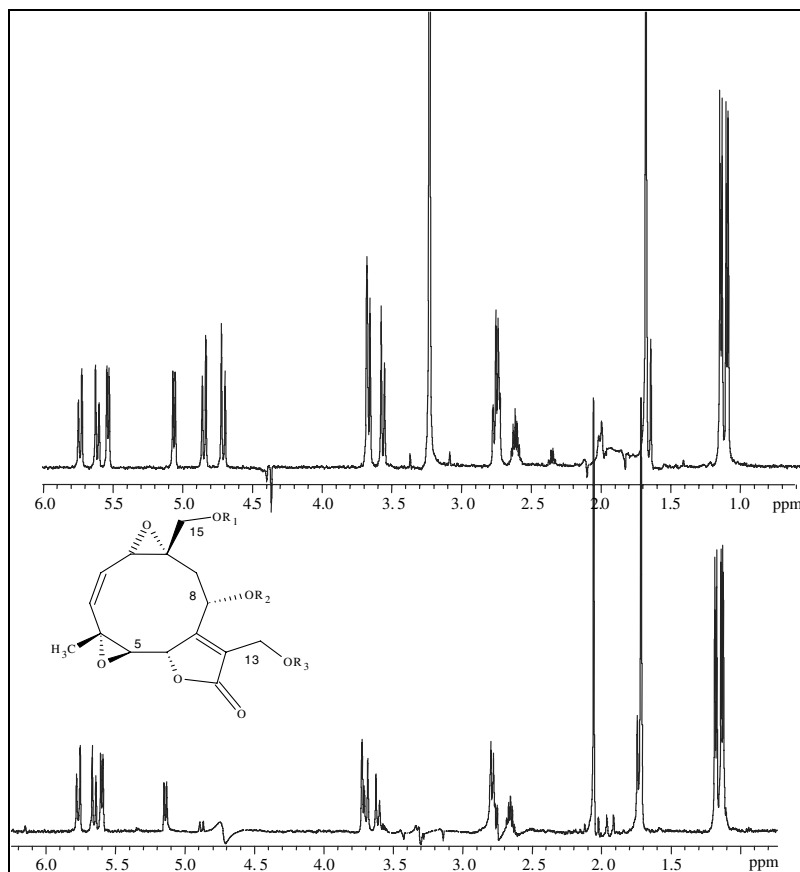

**FIGURE 9.79** Comparison of prevencistifolide-8-*O*-iso-butyrate ( $R_1 = H$ ,  $R_2 = i\text{-but}$ ,  $R_3 = \text{Ac}$ ) under  $\text{CH}_3\text{CN}/\text{D}_2\text{O}$  (upper trace) and  $\text{MeOH}/\text{D}_2\text{O}$  (lower trace) conditions.

normally used NMR solvents like  $\text{CDCl}_3$ , dramatic shift differences can be observed in some cases. Therefore, even in the case of the analysis of known compounds, a full spectroscopic characterization might be necessary in order to account for the differences in the measured chemical shifts and coupling constants when compared with published data (measured in  $\text{CDCl}_3$ ) (Table 9.12) (Figure 9.80).

As a consequence, the full repertoire of modern NMR experiments should be applicable under LC-NMR conditions. This means that we are dealing with a huge protonated solvent signal (i.e.,  $\text{CH}_3\text{OH}$  or  $\text{CH}_3\text{CN}$ ) that has to be suppressed sufficiently so that the dynamic range of the NMR receivers can be used for the analysis of the compound of interest. However, because under on-flow conditions a sample is normally in the NMR cell for a few seconds only, time-consuming analyses like long-term acquisition for low concentrated samples or 2D measurements have to be done differently.

### 9.5.3.2 Stop-Flow Analysis

With respect to the chromatographic part, stop-flow analysis in LC-NMR can be performed in two ways. In one method, a sample is chromatographed normally, and peaks of interest, when leaving the column, are stored in special loops of a collector connected to the column. Fractions can then be analyzed one by one when the chromatographic separation has been finished. Alternatively, the chromatographic separation is stopped by turning off the flow when the peak of interest reaches the NMR cell. After the NMR analysis is finished, the HPLC pump is restarted, and chromatography can be continued. According to our experience, such interruptions of the HPLC separation for a time span of several minutes or even a few hours have little influence on the efficiency of chromatographic separations.

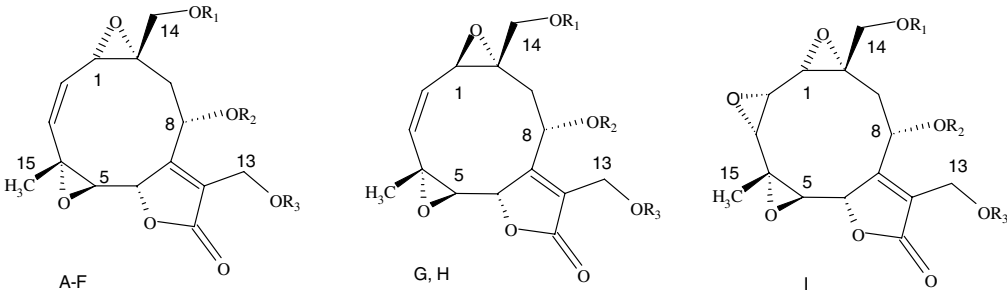

TABLE 9.12

Comparison of NMR Data for Prevernocistifolide-8-*O*-methacrylate

Proton	Offline (CDCl <sub>3</sub> )	Online (Acetonitrile)	Online (Methanol)
1-H	3.72; d; 1.4	3.75; bs	3.80; bs
2-H	5.81; dd; 12.4, 1.4	5.80; d; 12.5	5.86; d
3-H	5.71; dd; 12.4, 1.4	5.71; d; 12.5	5.75; d
5-H	2.59; d; 8.8	2.78; d; 8.8	2.90; d
6-H	4.92; d; 8.8	5.16; d; 8.8	5.22; d
8-H	5.63; d; 8.2	5.62; d; 8.2	5.84; d
9 <sub>a</sub> -H	2.82; ddd; 1.4, 8.2, 15.6	2.80; dd; 8.2, 15.6	2.91; dd
9 <sub>b</sub> -H	1.83; d; 15.6	1.84; d; 15.6	1.94; d
13 <sub>a</sub> -H	4.83; d; 12.4	4.78; d; 12.7	—
13 <sub>b</sub> -H	4.78; d; 12.4	4.64; d; 12.7	—
14 <sub>a</sub> -H	3.77; d; 12.3	3.59; d; 12.3	3.65; d
14 <sub>b</sub> -H	3.74; d; 12.3	3.70; d; 12.3	3.81; d
15-CH <sub>3</sub>	1.78; s	1.72; s	1.82; s
OAc	2.05; s	—	2.10; s
-CH <sub>3</sub>	1.98; dd; 0.9, 1.4	—	—

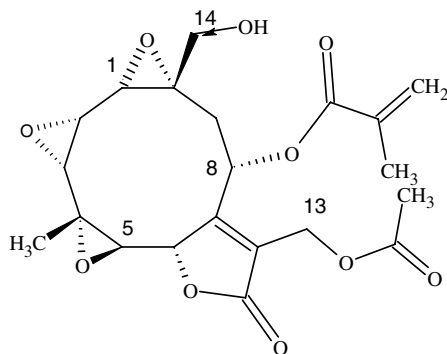
FIGURE 9.80 Prevernocistifolide-8-*O*-methacrylate.

With respect to the NMR part, sufficient pulse sequences were developed so that nowadays, all normally used NMR experiments can be used in combination with solvent suppression (Smallcombe et al., 1995). Again, WET solvent suppression seems to have advantages in comparison to presaturation due to the short pulse period necessary for an efficient solvent suppression. Hence, almost no magnetization is lost due to long saturation periods, and all of the sensitivity is retained for the NMR experiment in use. Thus, NMR techniques like COSY, GCOSY, DQFCOSY, NOESY, TOCSY, and even HSQC or HMQC could be implemented with a WET element for solvent suppression. In addition, 1D versions of the aforementioned 2D experiments can be performed with the use of selective pulses. By the implementation of the DPGF-selective pulses, it is even possible to run the NMR experiments without solvent suppression.

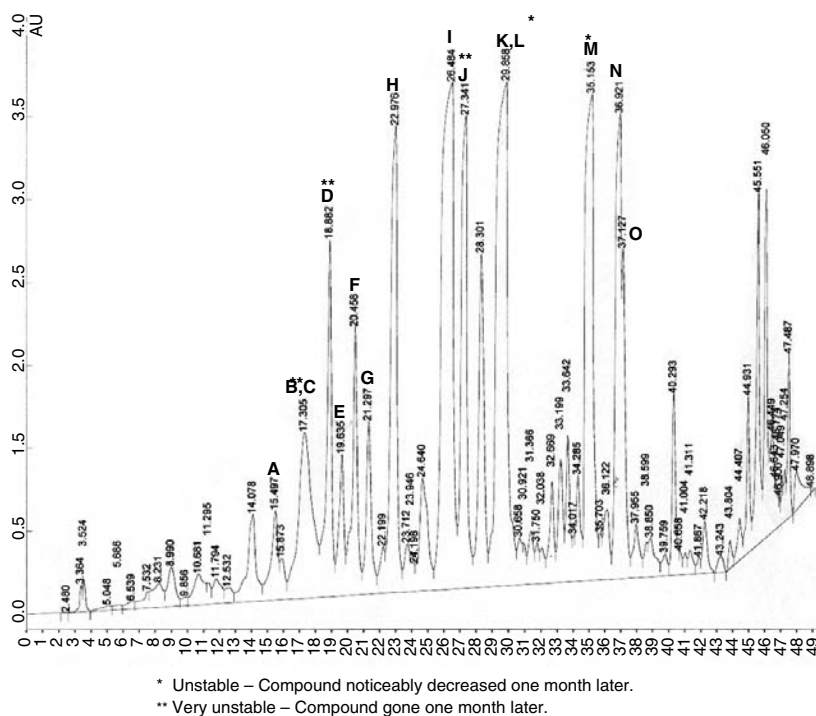

FIGURE 9.81 High-performance liquid chromatography (HPLC) of *Stauranthus perforatus*, Fraction 51-52.

### 9.5.3.3 *Stauranthus perforatus*

*Stauranthus perforatus* (Rutaceae) bark extract showed *in vitro* cytotoxic activity against a number of human tumor cell lines (Setzer et al., 2000). Bioactivity-directed preparative flash chromatography led to cytotoxic fractions that TLC analysis indicated were composed of many components. The cytotoxic fractions were subjected to LC-NMR and LC-MS analyses (Setzer et al., 2003) and were shown to be complex mixtures of **quinoline alkaloids** and **psoralens** (Figure 9.81 and Figure 9.82).

Six furanocoumarins (byakangelicol [L], heraclenin [J], heraclenol [A], imperatorin [O; see Figure 9.83], isopimpinellin [I; see Figure 9.84], and xanthotoxin [H]) and nine quinoline alkaloids (veprisine [M], 5-hydroxy-1-methyl-2-phenyl-4-quinolone [K], stauranthine [N], 3,4-dihydroxy-3,4-dihydroveprisine [D], 3,4-dihydroxy-3,4-dihydrostauranthine [E], 3,6-dihydroxy-3,6-dihydroveprisine [B], 3,6-dihydroxy-3,6-dihydrostauranthine [C], 6-hydroxy-3-ketoveprisine [F], and 6-hydroxy-3-ketostauranthine [G]) were identified in the fractions. Thus, LC-NMR in combination with LC-MS techniques allowed for the analysis of the components of this mixture, including seven new quinoline alkaloids, in spite of the instability of a number of components.

### 9.5.3.4 *Fraxinus spp.*

The analysis of the on-flow NMR spectra (Iossifova et al., 1998) revealed the presence of 15 compounds. Subsequent analysis using stop-flow analysis confirmed the findings from independent LC-MS investigations and led to the identification of **3-glucopyranosyloxy-2-methoxy-phenylethanol** (1), **salidroside** (2), **4-glucopyranosyloxy-syringinic acid** (3), **tyrosol** (4), **fraxin** (5), **fraxinoside** (6), **fraxinol** (7), **isofraxetin** (8), **hydroxypinoresinol-glucoside** (9), **verbascoside** (10), **isoacteoside** (11), **pinoresinol-glucoside** (12), **calcelarioside** (13), **ligstroside** (14), and **oleuropein** (15). Using NMR methods like **DPGNOESY** (double-pulsed field gradient nuclear Overhauser enhancement spectroscopy) (see Figure 9.85) allowed for the investigation of a number of structural problems, which by means of MS are difficult. One example is shown with fraxin (5). Here, the position of the methoxy group could be clearly proven by 1D-DPGNOESY spectra.

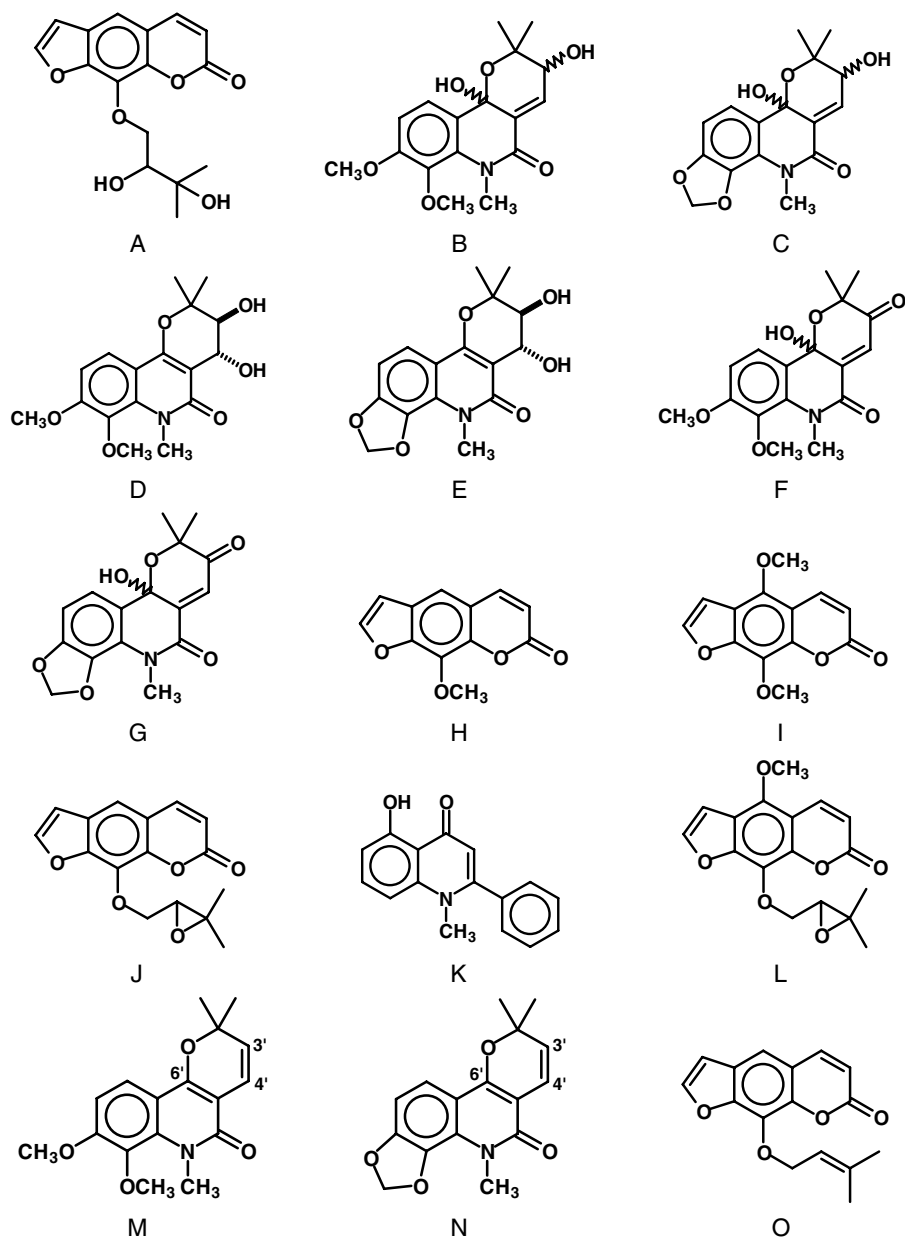

**FIGURE 9.82** Compounds identified in *Stauranthus perforatus*, Fraction 51-52, in order of increasing high-performance liquid chromatography (HPLC) retention time.

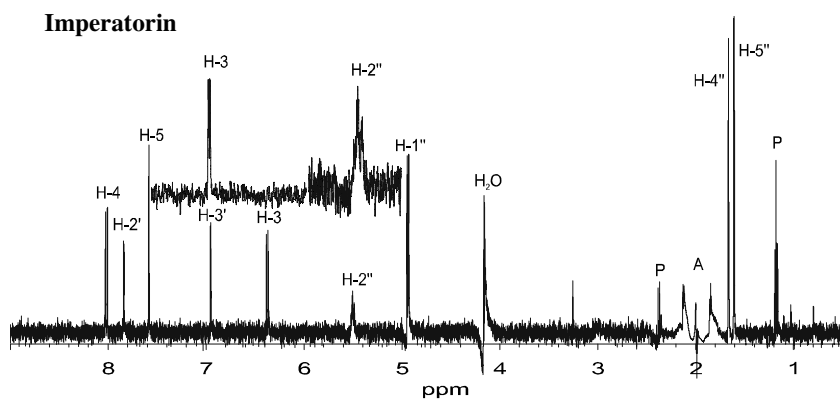

FIGURE 9.83 LC-NMR spectrum of imperatorin under  $\text{CH}_3\text{CN}/\text{D}_2\text{O}$  conditions.

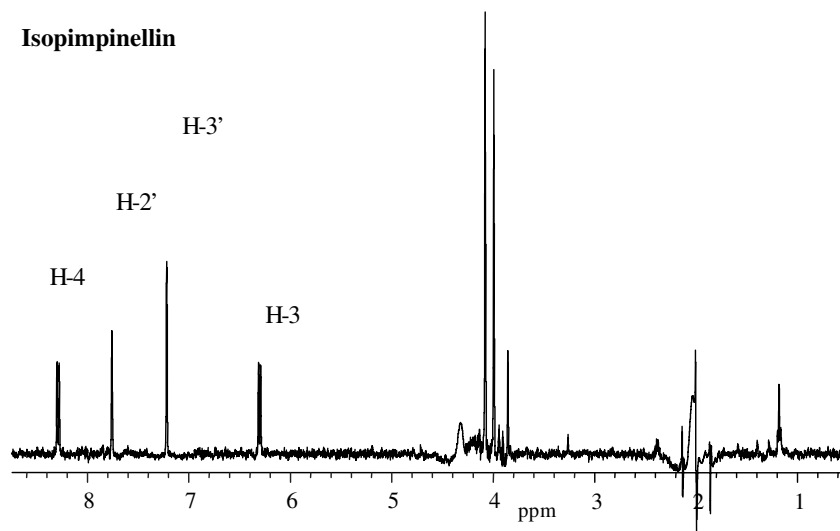
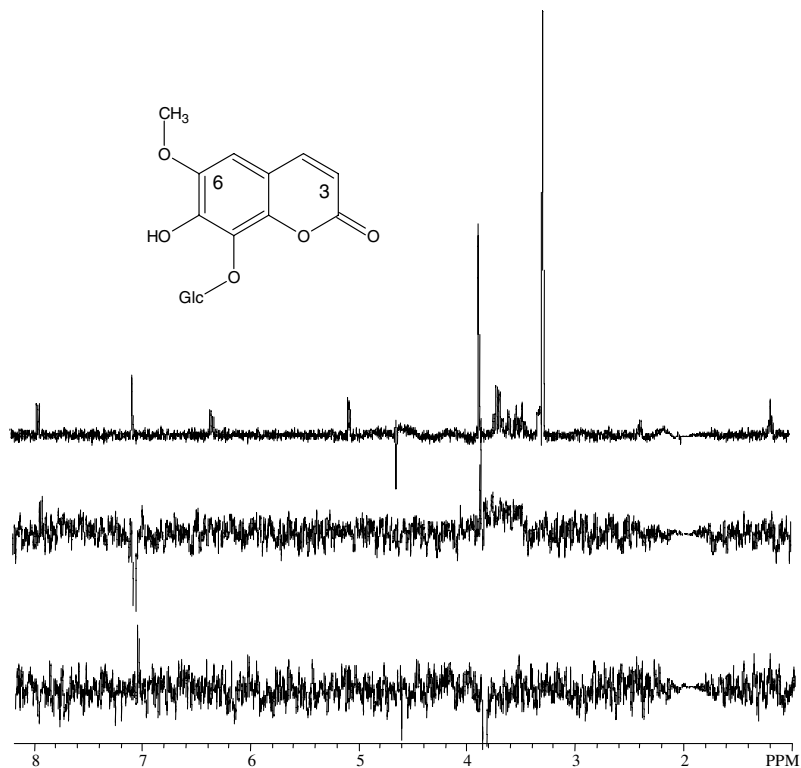

FIGURE 9.84 LC-NMR spectrum of isopimpinellin under  $\text{CH}_3\text{CN}/\text{D}_2\text{O}$  conditions.

Similarly for fraxinoside (6), see Figure 9.86, the position of the methoxy groups can be proven by 2D-NOESY spectra, which clearly show different NOEs for the two methoxy groups.

The application of 1D-TOCSY measurements can be shown in the example of verbascoside (Figure 9.87 and Figure 9.88).



**FIGURE 9.85** DPGNOESY of fraxin (5); top trace is the  $^1\text{H}$  spectrum; middle trace is the selective excitation of H-5; and lower trace is the selective excitation of the methoxy group.

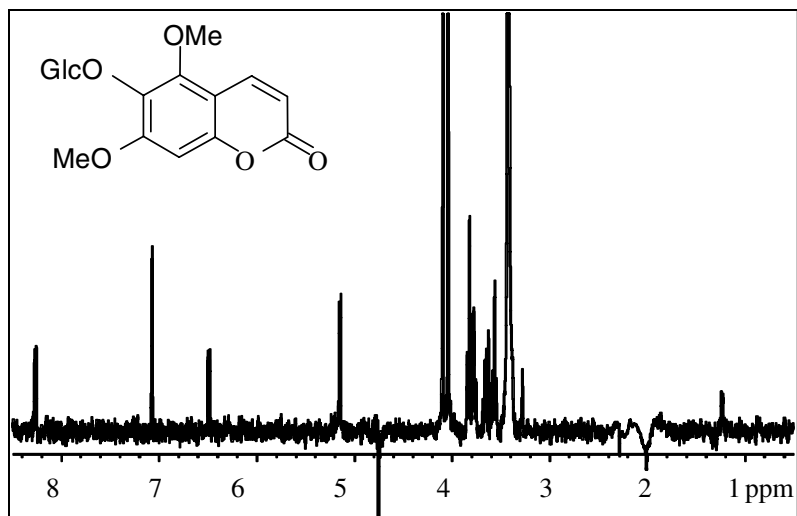

**FIGURE 9.86**  $^1\text{H}$ -NMR of fraxinoside (6).

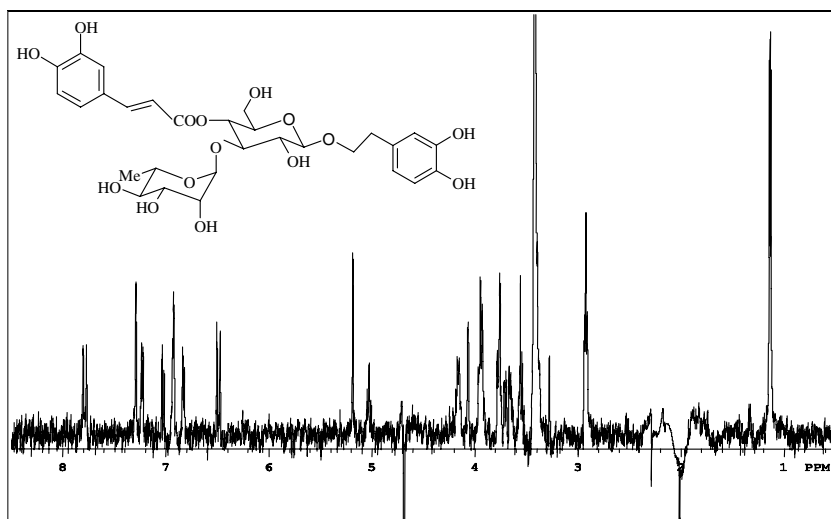

FIGURE 9.87 LC-NMR spectrum of verbascoside (10) in  $\text{CH}_3\text{CN}/\text{D}_2\text{O}$ .

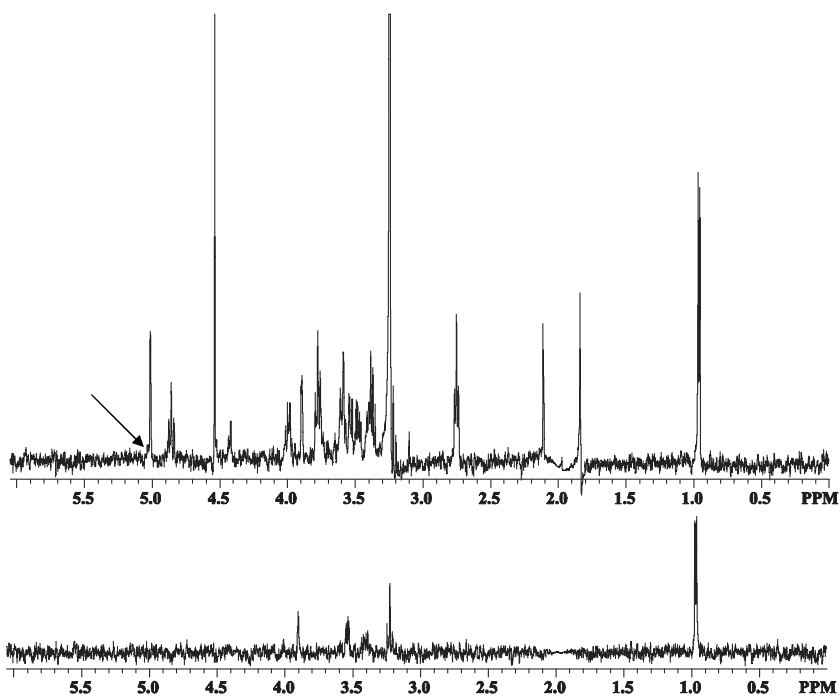

FIGURE 9.88 1D-TOCSY spectrum of the rhamnose part of verbascoside (10). The anomeric proton ( $\rightarrow$ ) does not show up, because the coupling constant is too small; thus, the TOCSY transfer is inefficient.

### 9.5.3.5 Piper longum

In the case of *Piper longum*, eight different components could be confirmed (Vogler et al., 1999) (Figure 9.89). Inspection of the NMR spectra again shows the strength of hyphenated techniques for closely related compounds. The structural difference between the compounds observed was mostly the number of double bonds or type of amine residue for the amide part (see Figure 9.90), so that the analysis of the NMR spectra (Figure 9.91 through Figure 9.94) was straightforward. All connectivities could be confirmed by WETCOSY spectra (see Figure 9.95).

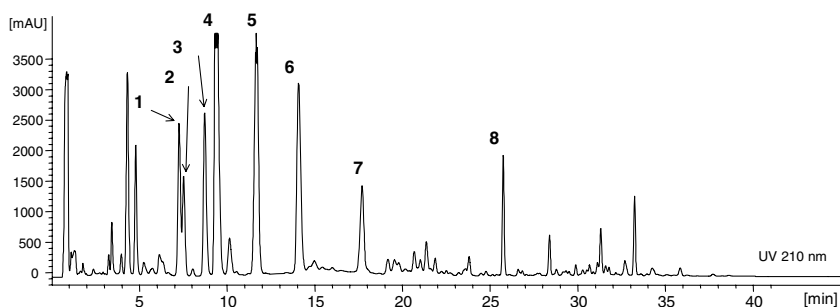

FIGURE 9.89 Chromatogram of *Piper longum* extract. UV detection was set at 210 nm.

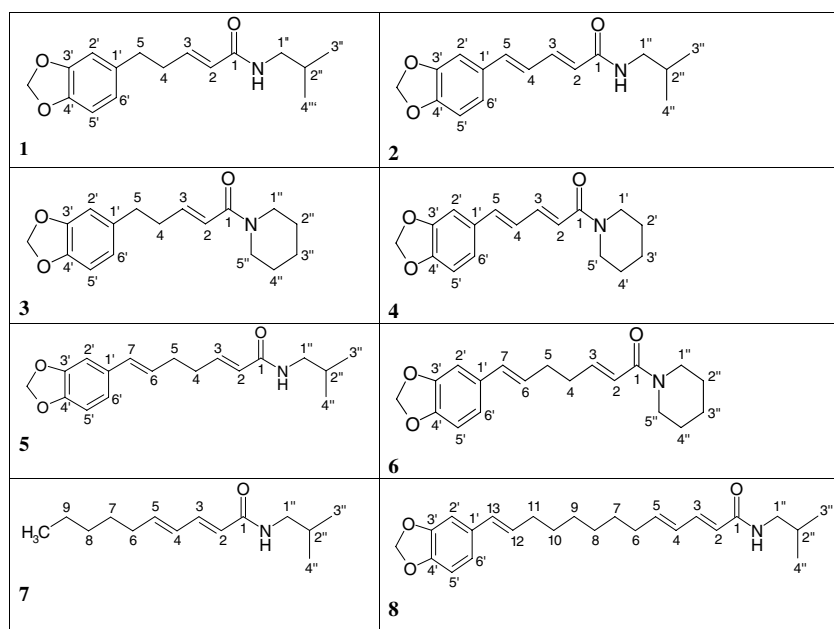

FIGURE 9.90 Structures of *Piper longum* compounds confirmed by LC-NMR.

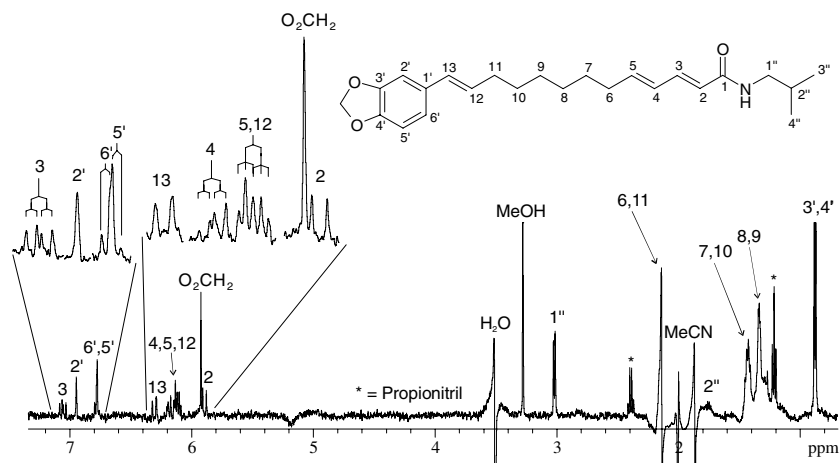

FIGURE 9.91 Guineensine.

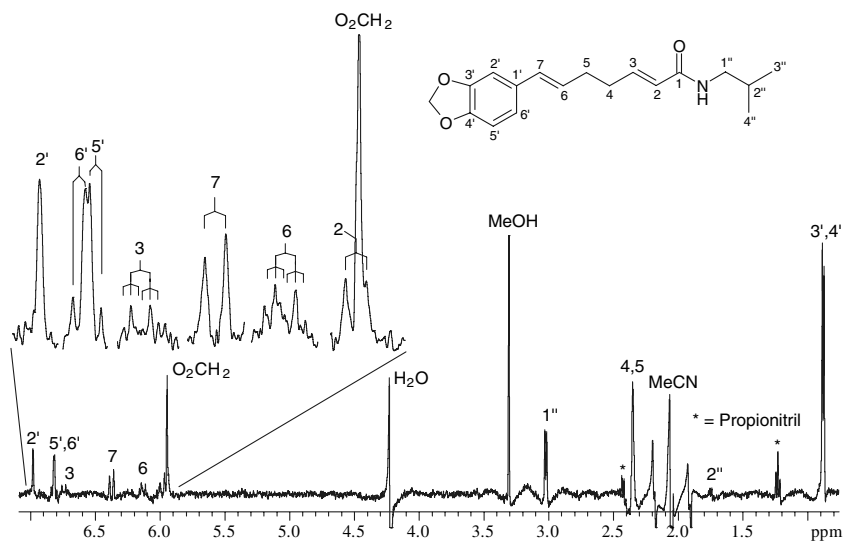

FIGURE 9.92 Futoamide.



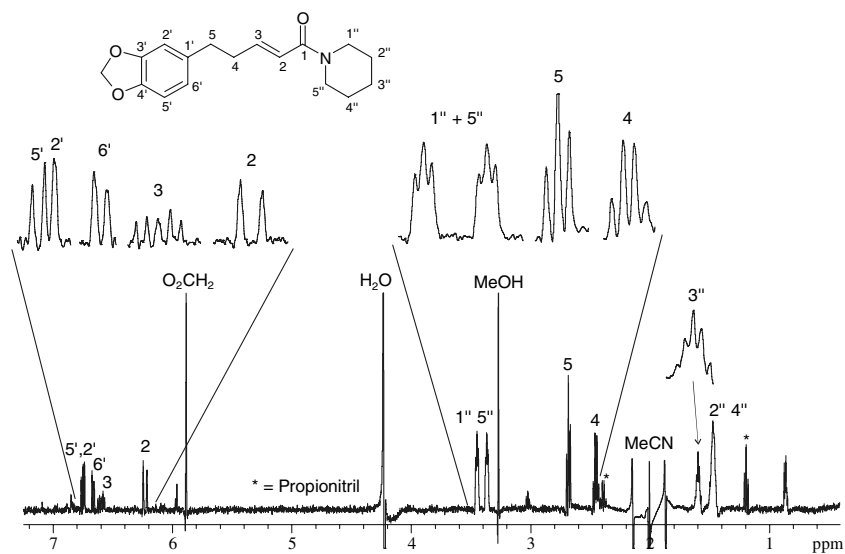

FIGURE 9.93 Dihydropiperlonguminine.

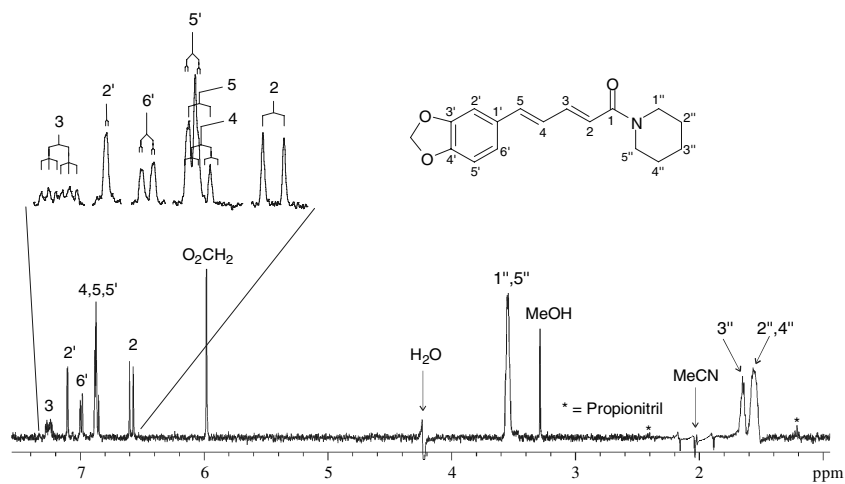

FIGURE 9.94 Piperlonguminine.

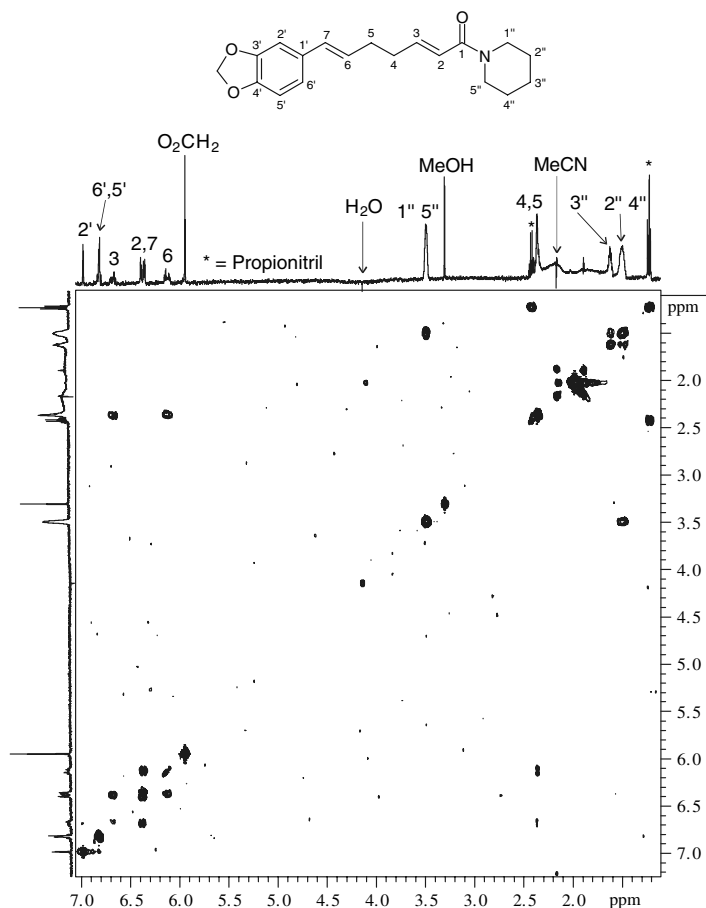

FIGURE 9.95 *N*-[7-(3,4-methylenedioxyphenyl)-2*E*,6*E*-heptadienoyl]piperidine.

#### 9.5.4 LC-NMR-MS

Recently, **LC-NMR-MS** instruments became commercially available. This powerful setup combines the rich structural information of NMR with the high sensitivity and structural information of MS, so that all the necessary information typically required for the structure elucidation of natural products is available during a single chromatographic run. The successful application of this combined technique was demonstrated in applications for the characterization of carbohydrates in beer (Duarte et al., 2003) and saponins in *Asteria rubens* (Sandvoss et al., 2001).

## 9.6 Conclusions

Tremendous improvements in structure elucidation were made over the past decades. While NMR spectrometry has considerably improved through the use of 2D techniques, especially proton-detected heteronuclear correlations, the application of mass spectrometry has widened dramatically through the introduction of ESI and APCI interfaces that led to a broad application of LC-MS methods. The amount of sample necessary for characterization purposes could be considerably decreased, especially due to the developments in NMR spectroscopy.

---

## References

- Adams, R.P. (1995). *Identification of Essential Oil Components by Gas Chromatography/Mass Spectroscopy*. Allured Publishing, Carol Stream, Illinois.
- Albert, K. (1995). On-line use of NMR detection in separation chemistry. *J Chromatogr A* 703: 123.
- Bringmann, G., C. Guenther, J. Schlauer, and M. Rueckert. (1998). HPLC-NMR on-line coupling including the ROESY technique: direct characterization of naphthylisoquinoline alkaloids in crude plant extracts. *Anal Chem* 70: 2805.
- Bringmann, G., K. Messer, M. Wohlarth, J. Kraus, K. Dumbuya, and M. Rueckert. (1999). HPLC-CD on-line coupling in combination with HPLC-NMR and HPLC-MS/MS for the determination of the full absolute stereostructure of new metabolites in plant extracts. *Anal Chem* 71: 2678.
- Bringmann, G., M. Wohlfarth, H. Rischer, J. Schlauer, and J. Brun. (2002). Extract screening by HPLC coupled to MS-MS, NMR, and CD: a dimeric and three monomeric naphthylisoquinoline alkaloids from *Ancistrocladus griffithii*. *Phytochemistry* 61: 195–204.
- De Hoffmann, E. and V. Stroobant. (2002). *Mass Spectrometry: Principles and Applications*, 2nd ed. Wiley, West Sussex, United Kingdom.
- Duarte, I.F., M. Godejohann, U. Braumann, M. Spraul, and A.M. Gil. (2003). Application of NMR spectroscopy and LC-NMR/MS to the identification of carbohydrates in beer. *J Agric Food Chem* 51: 4847–4852.
- Glaser, T., A. Lienau, D. Zeeb, M. Krucker, M. Dachtler, and K. Albert. (2003). Qualitative and quantitative determination of carotenoid stereoisomers in a variety of spinach samples by use of MSPD before HPLC-UV, HPLC-APCI-MS, and HPLC-NMR on-line coupling. *Chromatographia* 57: S-19.
- Godejohann, M., L.H. Tseng, U. Braumann, J. Fuchser, and M. Spraul. (2004). Characterization of a paracetamol metabolite using on-line LC-SPE-NMR-MS and a cryogenic NMR probe. *J Chromatogr A* 1058: 191.
- Günther, H. (1995). *NMR Spectroscopy*, 2nd ed. John Wiley & Sons, New York.
- Haber, W.A., W. Zuchowski, and E. Bello. (2000). *An Introduction to Cloud Forest Trees, Monteverde, Costa Rica*. Mountain Gem Publications, Monteverde, Costa Rica.
- Iossifova, T., I. Klaiiber, B. Vogler, L. Evstatieva, I. Kostova, and W. Kraus. (1998). LC-coupled spectroscopic investigation of *Fraxinus pallisiae* bark. In *Quality of Medicinal Plants and Herbal Medicinal Products*. Hrsg.: Gesellschaft für Arzneimittelforschung. 46th Annual Congress of the Society of Medicinal Plant, Wien, 31.08.–04.09. E24 (Abstracts of Plenary Lectures, Short Lectures and Posters).
- Kasali, A.A., O. Ekundayo, C. Paul, and W.A. Konig. (2002). Epi-Cubebanes from *Solidago canadensis*. *Phytochemistry* 59: 805–810.
- Krucker, M., A. Lienau, K. Putzbach, M.D. Grynbaum, P. Schuler, and K. Albert. (2004). Hyphenation of capillary HPLC to microcoil <sup>1</sup>H NMR spectroscopy for the determination of tocopherol homologues. *Anal Chem* 76: 2623–2628.
- Queiroz, E.F., J.L. Wolfender, K.K. Atindehou, D. Traore, and K. Hostettmann. (2002). On-line identification of the antifungal constituents of *Erythrina vogelii* by liquid chromatography with tandem mass spectrometry, ultraviolet absorbance detection and nuclear magnetic resonance spectrometry combined with liquid chromatographic micro-fractionation. *J Chromatogr A* 974: 123.
- Ramm, M., J.L. Wolfender, E.F. Queiroz, K. Hostettmann, and M. Hamburger. (2004). Rapid analysis of nucleotide-activated sugars by high-performance liquid chromatography coupled with diode-array detection, electrospray ionization mass spectrometry and nuclear magnetic resonance. *J Chromatogr A* 1034: 139.
- Sandvoss, M., A. Weltring, A. Preiss, K. Levsen, and G. Wuensch. (2001). Combination of matrix solid-phase dispersion extraction and direct on-line liquid chromatography-nuclear magnetic resonance spectroscopy-tandem mass spectrometry as a new efficient approach for the rapid screening of natural products: application to the total asterosaponin fraction of the starfish *Asterias rubens*. *J Chromatogr A* 917: 75–86.
- Schmidt, C.O., H.J. Bouwmeester, N. Bulow, and W.A. Konig. (1999). Isolation, characterization, and mechanistic studies of (-)-alpha-gurjunene synthase from *Solidago canadensis*. *Arch Biochem Biophys* 364: 167–177.
- Setzer, W.N., M.C. Setzer, J.M. Schmidt, D.M. Moriarity, B. Vogler, S. Reeb, A.M. Holmes, and W.A. Haber. (2000). Cytotoxic components from the bark of *Stauranthus perforatus* from Monteverde, Costa Rica. *Planta Med* 66: 493–494.

- Setzer, W.N., B. Vogler, R.B. Bates, J.M. Schmidt, C.W. Dicus, P. Nakkiew, and W.A. Haber. (2003). HPLC-NMR/HPLC-MS analysis of the bark extract of *Stauranthus perforatus*. *Phytochem Anal* 14: 54–59.
- Sheppard-Hanger, S. (1994). *The Aromatherapy Practitioner Reference Manual*. Atlantic Institute of Aromatherapy, Tampa, Florida.
- Smallcombe, S.H., S.L. Patt, and P.A. Keiffer. (1995). WET solvent suppression and its applications to LC NMR and high-resolution NMR spectroscopy. *J Magnetic Res Ser A* 117: 295.
- Stout, G.H. and L.H. Jensen. (1989). *X-Ray Structure Determination: A Practical Guide*, 2nd ed. John Wiley & Sons, New York.
- Vogler, B., I. Klaiber, G. Roos, C.U. Walter, W. Hiller, P. Sandor, and W. Kraus. (1997). Combination of LC-MS and LC-NMR as a tool for the structure determination of natural products. *J Nat Prod* 61: 175–178.
- Vogler, B., J.R. Stoehr, I. Klaiber, and R. Bauer. (1999). Online structure elucidation of amides and polyoxygenated cyclohexane derivatives by LC-NMR and LC-MS from crude extracts of Piper species. In *2000 Years of Natural Products Research — Past, Present and Future* (Joint Meeting of the ASP, AFERP, GA and PSE, July 26–30Z), T.J.C. Luijendijk and R. Verpoorte (Eds.). Vrije Universteit, Amsterdam, p. 315.
- Waridel, P., J.L. Wolfender, J.B. Lachavanne, and K. Hostettmann. (2004). Ent-Labdane glycosides from the aquatic plant *Potamogeton lucens* and analytical evaluation of the lipophilic extract constituents of various Potamogeton species. *Phytochemistry* 65: 945.
- Wolfender, J.L., L. Verotta, L. Belvisi, N. Fuzzatti, and K. Hostettmann. (2003). Structural investigations of isomeric oxidised forms of hyperforin by HPLC-NMR and HPLC-MS<sup>n</sup>. *Phytochem Anal* 14: 290.
- Xiao, H.B., M. Krucker, K. Albert, and X.M. Liang. (2004). Determination and identification of isoflavonoids in *Radix astragali* by matrix solid-phase dispersion extraction and high-performance liquid chromatography with photodiode array and mass spectrometric detection. *J Chromatogr A* 1032: 117.
- Zschocke, S., I. Klaiber, R. Bauer, and B. Vogler. (2005). HPLC-coupled spectroscopic techniques (UV, MS, NMR) for the structure elucidation of phthalides in *Ligusticum chuanxiong*. *Mol Diversity* 9: 33–39.



# 10

## Bioassays for Activity

William N. Setzer and Bernhard Vogler

### CONTENTS

10.1	Introduction .....	390
10.2	Antimicrobial Assays .....	390
10.2.1	Disk Diffusion Assay .....	390
10.2.2	Microbroth Dilution Assay (MIC Evaluation) .....	390
10.2.3	Growth Curves .....	391
10.3	<i>In Vitro</i> Cell-Based Assays.....	391
10.3.1	Immortal Cell Lines .....	392
10.3.1.1	Hep G2 (Human Hepatocellular Carcinoma).....	392
10.3.1.2	MDA-MB-231 (Human Mammary Adenocarcinoma).....	393
10.3.1.3	PC-3 (Human Prostatic Carcinoma).....	393
10.3.1.4	5637 (Primary Bladder Carcinoma) .....	393
10.3.2	Primary Tissue Culture .....	393
10.3.2.1	Primary Rat Hepatocytes .....	393
10.3.3	Antiviral Assays .....	394
10.3.3.1	Anti-HSV .....	394
10.4	Invertebrate-Based Assays.....	395
10.4.1	<i>Artemia salina</i> (Brine Shrimp).....	395
10.4.2	<i>Drosophila melanogaster</i> (Fruit Fly).....	395
10.4.3	<i>Solenopsis invicta</i> (Red Imported Fire Ant).....	396
10.4.4	<i>Meloidogyne incognita</i> (Root-Knot Nematode) Nematocidal Assay.....	396
	The Test Procedure.....	397
10.4.5	<i>Caenorhabditis elegans</i> Anthelmintic Assay .....	397
	The Test Procedure.....	398
10.4.6	<i>Epilachna varivestis</i> (Mexican Bean Beetle) Antifeedant Assay.....	398
10.4.6.1	Dual-Choice Antifeedant Assay.....	398
10.4.6.2	Contact Toxicity .....	399
10.4.6.3	No-Choice Feeding Test for Insect Growth Regulator .....	399
10.4.7	<i>Biomphalaria glabrata</i> (Freshwater Snail) Molluscicidal Assay.....	399
	The Test Procedure.....	401
10.5	Biochemical Screens .....	401
10.5.1	Based on Spectrophotometric Detection .....	401
10.5.1.1	Papain Inhibition Assay .....	402
10.5.1.2	Trypanothione Reductase Inhibition.....	402
10.5.2	Based on Gel Electrophoresis.....	402
10.5.2.1	Topoisomerase II Inhibition.....	403
10.6	Evaluation of Structural Interactions via NMR and MS Methods .....	403
10.6.1	NMR-Based Methods.....	404
10.6.1.1	Ligand-Based Screening Methods .....	404
10.6.1.2	Diffusion Spectroscopy-Based Methods .....	404
10.6.1.3	SHAPES .....	406
10.6.1.4	Receptor-Based Screening Methods.....	406
10.6.1.5	SAR by NMR .....	407
10.6.2	MS Methods.....	408

10.7 Conclusions .....	408
References .....	409

---

## 10.1 Introduction

The driving force behind much phytochemical research is the discovery of new biologically active compounds for medicinal or agricultural uses. Biological assays, then, must be carried out in order to identify promising plant extracts, to guide the separation and isolation, and to evaluate lead compounds. In this chapter, we present some bioassays that are routinely used in our laboratories. These include *in vitro* assays for antimicrobial or cytotoxic activities, assays with invertebrates such as brine shrimp and insects, and some biochemical assays. We do not include biological assays using vertebrate animals or human clinical trials.

---

## 10.2 Antimicrobial Assays

In recent years, established antimicrobial drugs have become less effective against many infectious agents. A 1994 report from the Centers for Disease Control points out the concern not only about the possibility of a “postantibiotic era,” but also, our tenuous ability to detect, contain, and prevent emerging diseases. In addition to antibiotic resistance, the incidence of opportunistic infections continues to increase rapidly because of the increased number of immunocompromised patients, and this has created a need for more effective therapy for these otherwise benign pathogens. The emergence of pathogenic microbes with increased resistance to established antibiotics provides a major incentive for the discovery of new antimicrobial agents. Antimicrobial screening of plant extracts and phytochemicals, then, represents a starting point for antimicrobial drug discovery.

### 10.2.1 Disk Diffusion Assay

We utilized the disk diffusion technique in order to screen crude extracts for antifungal activity against a panel of filamentous fungi, including *Aspergillus niger*, *Aspergillus nidulans*, *Aspergillus flavus*, *Alternaria alternata*, *Chaetomium globosum*, *Cladosporium herbarum*, *Neurospora crassa*, *Penicillium notatum*, *Rhizopus oligosporus*, *Trichoderma viride*, and *Trichothecium roseum*, using a “zone of inhibition” assay (unpublished). In this assay, plant extracts or phytochemicals are diluted at various concentrations (e.g., 5  $\mu\text{g}\cdot\text{mL}^{-1}$ , 50  $\mu\text{g}\cdot\text{mL}^{-1}$ , 500  $\mu\text{g}\cdot\text{mL}^{-1}$ ) in an appropriate volatile solvent. Filter paper disks are prepared by immersing the disks in the diluted extracts. The disks are then air-dried and placed in petri dishes containing lawns of the fungus on **potato dextrose agar (PDA)**. The petri dishes are incubated at room temperature, examined after 24 and 48 h, and zones of inhibition are then ascertained for each sample (see Figure 10.1).

### 10.2.2 Microbroth Dilution Assay (MIC Evaluation)

Crude extracts are screened for antibacterial activity against a panel of both Gram-positive and Gram-negative bacteria using the microbroth dilution technique (Sahm and Washington, 1991). The microbial agents that we use are commercially available from the **American Type Culture Collection (ATCC)**, Manassas, VA. We generally screen against *Bacillus cereus* (ATCC No. 14579), *Staphylococcus aureus* (ATCC No. 29213), *Streptococcus pneumoniae* (ATCC No. 6303), *Pseudomonas aeruginosa* (ATCC No. 27853), and *Escherichia coli* (ATCC No. 25922) (Setzer et al., 2001, 2003). Dilutions of the crude extracts are prepared in **cation-adjusted Mueller Hinton broth (CAMHB)** beginning with 50  $\mu\text{l}$  of 1% w/w solutions of crude extracts in **dimethylsulfoxide (DMSO)** plus 50  $\mu\text{l}$  CAMHB. The extract solutions are serially diluted (1:1) down a lane in CAMHB in 96-well plates. This gives dilutions of each crude extract of 2500, 1250, 625, 313, 156, 78, 39, and 19.5  $\mu\text{g}\cdot\text{mL}^{-1}$  in each lane. Bacteria at a

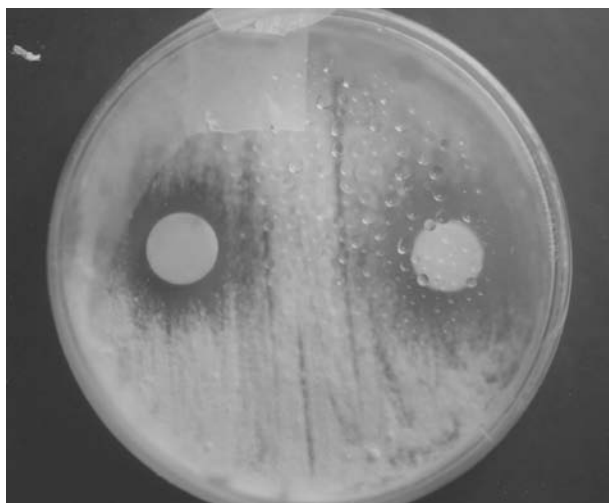

**FIGURE 10.1** Disk diffusion assay with *Trichothecium roseum* showing “zone of inhibition.”

concentration of approximately  $1.5 \times 10^8$  **colony-forming units (CFUs)** $\cdot\text{ml}^{-1}$  are added to each well. Plates are then incubated at  $37^\circ\text{C}$  for 24 h, and the final **minimum inhibitory concentration (MIC)** is determined as the lowest concentration without turbidity. Gentamicin is used as a positive antibiotic control, and DMSO is used as a negative control. For extracts or compounds that exhibit MICs  $<19.5 \mu\text{g}\cdot\text{ml}^{-1}$ , the procedure is repeated diluting down two lanes for each sample. We generally regard a sample as exhibiting antibacterial activity if the MIC is  $\leq 19.5 \mu\text{g}\cdot\text{ml}^{-1}$ .

Antifungal activity against *Saccharomyces cerevisiae* (ATCC No. 204501) or *Candida albicans* (ATCC No. 10231) can be determined as described above using yeast-nitrogen base growth medium with approximately  $7.5 \times 10^7$  CFU $\cdot\text{ml}^{-1}$ . Amphotericin B is used as the positive control, and DMSO is used as a negative control. Antifungal activity against *Aspergillus niger* (ATCC No. 16401) is determined similarly using potato dextrose broth inoculated with *A. niger* hyphal culture diluted to a McFarland turbidity of 1. Amphotericin B is the positive control, and DMSO is the negative control.

### 10.2.3 Growth Curves

In order to further probe the antimicrobial effects of bioactive extracts and phytochemicals, growth rates at sublethal concentrations for the microorganisms of interest can be determined (Setzer et al., 2004). In our laboratories, growth rate determinations are carried out in triplicate using the 96-well microplate-dilution method as described above. Dilutions of test materials are prepared in CAMHB beginning with 50  $\mu\text{l}$  of 1% w/w solutions of compounds in DMSO plus 50  $\mu\text{l}$  CAMHB. The extract solutions are serially diluted (1:1) in CAMHB in 96-well plates. Microorganisms at concentrations of approximately  $1.5 \times 10^8$  CFU $\cdot\text{ml}^{-1}$  are added to each well. Plates are incubated at  $37^\circ\text{C}$ , and turbidity (by measuring optical density at 600 nm) is recorded every 20 min over an 8 h period. The final MIC is determined as the lowest concentration without turbidity. Growth data (log OD versus time) are plotted, the slopes of the exponential growth phase are determined, and average slopes and standard deviations are calculated based on the three replicates. Statistical analyses of the data are carried out using the **SYSTAT** program (Richmond, CA).

---

## 10.3 *In Vitro* Cell-Based Assays

**Chemotherapy** is one of the major approaches used to destroy cancerous tissues. Unfortunately, cancer cells can develop resistance to chemotherapeutic agents. So there is a need to find new chemical agents



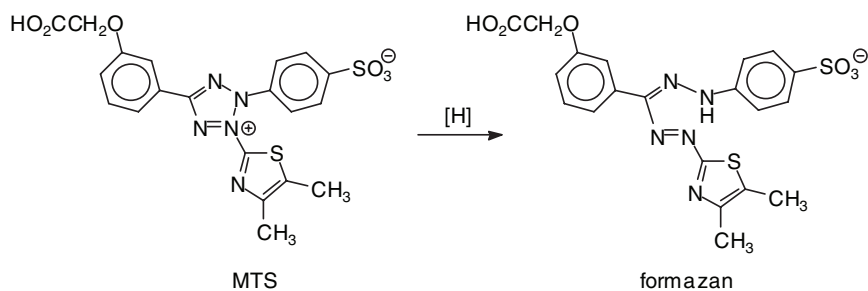

**FIGURE 10.2** MTS is reduced by living cells to a colored formazan product.

that can use differences between normal cells and cancer cells in order to selectively kill the cancer cells. *In vitro* cytotoxicity assays have been used as rapid screening methods to identify potential antineoplastic agents. Various techniques are used to determine the degree of cytotoxic activity of plant extracts and purified compounds, including direct counting of trypan-blue-stained dead cells (Walum, Strenberg, and Jenssen, 1990; Setzer et al., 1992) and colorimetric methods utilizing **tetrazolium dyes** such as MTT (Denizot and Lang, 1986), XTT (Scudiero et al., 1988), INT (Bernabei et al., 1989), or MTS (Cory et al., 1991). We utilize the MTS method for determination of cytotoxicity. The method is rapid, reproducible, and reliable. In this technique, **MTS** [3-(4,5-dimethylthiazol-2-yl)-5-(3-carboxymethoxyphenyl)-2-(4-sulfophenyl)-2H-tetrazolium inner salt] is reduced by living cells to give a colored **formazan** product that is soluble in the tissue culture medium (Figure 10.2).

### 10.3.1 Immortal Cell Lines

The ATCC maintains a vast collection of human tumor-derived cell lines. We describe below our culture and screening methods for some of the cell lines that we routinely use in our laboratories (Setzer et al., 2001, 2003).

#### 10.3.1.1 Hep G2 (Human Hepatocellular Carcinoma)

**Hep G2** (ATCC No. HB-8065) is a human hepatocellular carcinoma cell line that retains many liver-specific functions, such as secretion of a variety of serum proteins (Knowles et al., 1980). Hep G2 cells are grown in an air environment at 37°C in **Dulbecco's Modified Eagle's Medium (DMEM)** with L-glutamine and 1000 mg glucose per liter of medium, supplemented with 100,000 units penicillin and 10.0 mg streptomycin per liter of medium, and buffered with 30 mM *N*-(2-hydroxyethyl) piperazine-*N*-2-ethanesulfonic acid (**Hepes**), pH 7.35. Cells are plated using medium supplemented with 10% fetal bovine serum and maintained between passaging using medium supplemented with 10% horse serum and 5% fetal bovine serum. For the cytotoxicity assay, Hep G2 cells are plated into 96-well cell culture plates at  $1.8 \times 10^4$  cells per well and a volume of 100  $\mu$ l in each well. After 48 h, supernatant fluid is removed by suction and replaced with 100  $\mu$ l growth medium containing either 2.5  $\mu$ l of DMSO solution of extracts or compounds (1% w/w in DMSO), giving a final concentration of 250  $\mu$ g-ml<sup>-1</sup> for each extract or compound. Solutions are added to wells in four replicates. Medium controls and DMSO controls (25  $\mu$ l DMSO-ml<sup>-1</sup>) are used. **Tingenone** (Figure 10.3) (Setzer et al., 1998) in the amount of

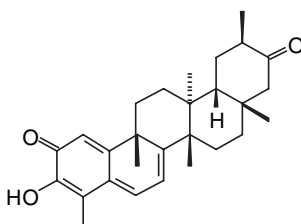

**FIGURE 10.3** Structure of tingenone.

250  $\mu\text{g}\cdot\text{ml}^{-1}$ ) is used as a positive control on each plate. After the addition of compounds, plates are incubated for 48 h at 37°C; medium is then removed by suction; and 100  $\mu\text{l}$  of fresh medium is added to each well. In order to establish percent kill rates, the MTS assay is performed (Promega, 1996). Colorimetric readings are recorded using a Molecular Devices (Sunnyvale, CA) SpectraMAX Plus microplate reader at 490 nm. Average absorbances, standard deviations, and percent kill ratios ( $\% \text{kill}_{\text{compound}}/\% \text{kill}_{\text{DMSO}}$ ) can then be calculated.  **$LC_{50}$  values** (the concentration that kills 50% of the cells) can be determined by preparing serial dilutions of the extract or purified compound in DMSO and performing the cytotoxicity assays as above. The  $LC_{50}$  values are determined using the Reed–Muench method (Ipsen and Feigel, 1970). We generally use eight replicates in  $LC_{50}$  determinations in order to obtain acceptable standard deviations.

#### 10.3.1.2 MDA-MB-231 (Human Mammary Adenocarcinoma)

The **MDA-MB-231** (ATCC No. HTB-26) human breast tumor cell line is derived from an estrogen-receptor-negative mammary adenocarcinoma (Cailleau et al., 1974). MDA-MB-231 cells are grown in an air environment at 37°C in Leibovitz's L-15 medium with L-glutamine, supplemented with 10% fetal bovine serum, 100,000 units penicillin, and 10.0 mg streptomycin per liter of medium, and buffered with 30 mM Hepes, pH 7.35. Cells are plated for testing as described above at  $2.6 \times 10^4$  cells per well. After 48 h, supernatant fluid is removed by suction and replaced with 100  $\mu\text{l}$  growth medium containing 1  $\mu\text{l}$  of DMSO solution of extracts or compounds (1% w/w in DMSO), to give a final concentration of 100  $\mu\text{g}\cdot\text{ml}^{-1}$  for each extract or compound.

#### 10.3.1.3 PC-3 (Human Prostatic Carcinoma)

Human **PC-3** prostatic carcinoma cells (ATCC No. CRL-1435) (Kaighn et al., 1979) are grown in a 3%  $\text{CO}_2$  environment at 37°C in RPMI-1640 medium with L-glutamine, supplemented with 10% fetal bovine serum, 100,000 units penicillin, and 10 mg streptomycin per liter of medium, and buffered with 15 mM Hepes and 23.6 mM  $\text{NaHCO}_3$ , pH 7.30. PC-3 cells are plated for screening at  $1.9 \times 10^4$  cells per well; testing extracts or compounds at 100  $\mu\text{g}\cdot\text{ml}^{-1}$ .

#### 10.3.1.4 5637 (Primary Bladder Carcinoma)

Human **5637** primary bladder carcinoma cells (ATCC No. HTB-9) (Fogh, 1978) are grown in a 3%  $\text{CO}_2$  environment at 37°C in RPMI-1640 medium with L-glutamine, supplemented with 10% fetal bovine serum, 100,000 units penicillin, and 10.0 mg streptomycin per liter of medium, and buffered with 28 mM  $\text{NaHCO}_3$ , pH 7.35. Bladder tumor cells are plated for screening at  $5.1 \times 10^3$  cells per well; testing extracts or compounds have concentrations at 100  $\mu\text{g}\cdot\text{ml}^{-1}$ .

### 10.3.2 Primary Tissue Culture

In order to compare the cytotoxicity of compounds against tumor cells with cytotoxicity against normal cells, it is generally desirable to use cells from primary tissue culture. A number of human primary tissue cultures are commercially available from Cambrex Bio Science, Walkersville, MD (Clonetics® primary human cell systems), but these are very expensive. Alternatively, **immortalized “normal” cell lines** are available from ATCC. In our laboratory, we used rat liver cells from primary culture as our source of “normal” cells (Setzer et al., 1992).

#### 10.3.2.1 Primary Rat Hepatocytes

Primary cultures of adult rat hepatocytes are isolated by collagenase perfusion of the liver (Moriarity and Savage, 1980). The liver of an adult male albino rat (200 to 300 g) is perfused *in situ* at 37°C through the inferior vena cava. About 200 ml of calcium-free Hanks' balanced salt solution containing 0.5% bovine serum albumin, 0.5 mM ethylene diamine tetra-acetic acid (EDTA), 1.1 mM  $\text{MgSO}_4$ , 10

unit·ml<sup>-1</sup> insulin, 1 unit·ml<sup>-1</sup> heparin, 100 unit·ml<sup>-1</sup> penicillin, 100 µg·ml<sup>-1</sup> streptomycin, and 0.2% NaHCO<sub>3</sub>, pH 7.35, are passed through the liver. The perfusion is continued with 170 ml of the above Hanks' solution, in which the EDTA and the heparin are replaced by 2.5 mM CaCl<sub>2</sub> and 0.05% collagenase. After 20 min of perfusion at 37°C, the digested liver is suspended in 20 ml of the Hanks' solution containing collagenase and are filtered through coarse (253 µm<sup>2</sup>) and fine (64 µm<sup>2</sup>) mesh nylon gauze. The filtrate is centrifuged at 4°C for 1 min at 20 g, and the resulting pellet is washed twice with calcium-free Hanks' solution without collagenase, EDTA, or heparin. The final pellet is suspended in an appropriate amount of L-15 growth medium (supplemented with 10% newborn calf serum, penicillin, and streptomycin, and 256 mM Hepes, pH 7.35) to provide a concentration of 6 to 8 × 10<sup>5</sup> cells·ml<sup>-1</sup> as determined using a hemocytometer. The cells are plated in test plates containing growth medium. The medium is replaced after 4 to 6 h incubation at 37°C with the same medium without serum. The cells are maintained in serum-free medium for 48 h prior to the addition of test compounds. Cultures are incubated with test compounds at a final concentration of 250 µg·ml<sup>-1</sup> for 24 h and are then counted.

### 10.3.3 Antiviral Assays

**Antiviral assays** are basically an extension of cytotoxicity assays. Thus, cultures of mammalian cells are infected with virus, test compounds are added, and the fate of the cells is assessed. Cytotoxicity due to viral infection can be determined (Schmidtke et al., 2001) (note that test compounds must be predetermined to be noncytotoxic to the cells under study) or viral plaques can be counted. We screened plant extracts for anti-Herpes activity using the plaque reduction assay (Setzer et al., 2001, 2003).

#### 10.3.3.1 Anti-HSV

Activity of crude plant extracts and purified compounds against **herpes simplex virus type 1 (HSV-1)** is carried out using a modification of the plaque reduction assay (Gentry and Aswell, 1975) in **baby hamster kidney (BHK)** cells (Russell, 1962). BHK cells are grown in T-25 (25 cm<sup>2</sup>) tissue culture flasks, incubated at 37°C, in a 5% CO<sub>2</sub> environment in DMEM with L-glutamine and 4.5 g glucose per liter, 8.8 ml 200 mM L-glutamine per liter, supplemented with 80 mg·l<sup>-1</sup> gentamicin sulfate, 41.2 ml fetal bovine serum per liter, and buffered with sodium bicarbonate (3.7 g·l<sup>-1</sup>), pH 7.35.

The anti-HSV assay is carried out in confluent BHK monolayers in 24-well cell culture plates. The supernatant fluid is removed, the wells are inoculated with 30 to 60 **plaque-forming units (PFUs)** in 0.2 ml culture medium, and the plates are incubated for 2 h with continuous slow agitation. The supernatant fluid is then removed, and 1 ml culture medium is added to each well, followed by 10 µl of test solution. (Crude extracts are prepared as 1% solutions in DMSO.) Additional inoculated wells receive 10 µl DMSO alone or 10 µl medium as virus controls. The plates are incubated for 30 min with intermittent agitation and then incubated further for 48 h. Plaques are counted, and qualitative cytotoxicity is assessed by microscopic inspection after 24 and 48 h. Using this anti-HSV assay, we found that a number of crude bark extracts show anti-HSV activity (no viral plaque formation) without cytotoxicity to the BHK cells (Table 10.1).

**TABLE 10.1**

Bark Extracts Exhibiting Anti-HSV Activity

Species	Family	Collection Site	Ref.
<i>Acnistus arborescens</i>	Solanaceae	Monteverde, Costa Rica	Setzer et al., 2003
<i>Cupania glabra</i>	Sapindaceae	Monteverde, Costa Rica	Setzer et al., 2003
<i>Dichapetalum axillare</i>	Dichapetalaceae	Monteverde, Costa Rica	Setzer et al., 2003
<i>Drypetes lasiogyna</i>	Euphorbiaceae	Paluma, Queensland, Australia	Setzer et al., 2001
<i>Endiandra sankeyana</i>	Lauraceae	Atherton, Queensland, Australia	Unpublished
<i>Mallotus mollissimus</i>	Euphorbiaceae	Atherton, Queensland, Australia	Unpublished
<i>Neolitsea dealbata</i>	Lauraceae	Paluma, Queensland, Australia	Setzer et al., 2001

## 10.4 Invertebrate-Based Assays

### 10.4.1 *Artemia salina* (Brine Shrimp)

It was suggested by McLaughlin (1991) that brine shrimp (*Artemia salina*) lethality can be a predictor of potential antineoplastic activity. The brine shrimp lethality assay, then, represents a simple and inexpensive alternative screening technique to identify lead compounds with “cytotoxic” activity. In our laboratory, we carry out brine shrimp lethality tests using a modification (Setzer, Talley, and Jackes, 1998) of the procedure described by McLaughlin (1991). Solutions of crude extracts (1% w/w in DMSO) are added to brine shrimp suspensions to give final concentrations of 100, 10, 1, and 0.1  $\mu\text{g}\cdot\text{ml}^{-1}$  (three replicates each plus DMSO controls). Typically, 10 ml of brine, ten newly hatched brine shrimp, and the crude extract in DMSO (100  $\mu\text{l}$ , 10  $\mu\text{l}$ , or 1  $\mu\text{l}$  of 1% DMSO solutions) are added to each 10 ml vial.  $LC_{50}$  values (concentrations of extracts that are lethal to 50% of the organisms) are then determined using the Reed–Muench method (Sam, 1993).

### 10.4.2 *Drosophila melanogaster* (Fruit Fly)

Plants must have some form of self-protection from herbivory, and it is logical to assume that many plants developed defensive strategies in the form of chemical compounds in order to meet this need for self-protection. Plants, then, can serve as sources of new insecticidal and repellent compounds. *Azadirachta indica*, the neem tree (see essay on the neem tree by P. Dayanandan in Chapter 12), has been used for hundreds of years as an insect repellent, and the plant has yielded a number of compounds (**limonoids**, **tetranortriterpenoids**) that are active as insecticides, feeding deterrents, or growth disruptors. The tetranortriterpenoid, **azadirachtin** (Figure 10.4), was isolated and shown to be remarkably effective as a deterrent, insecticide, growth disruptor, and sterilizing factor, all at very low concentrations (Tomlin, 1997). *Trichilia roka* and *T. hispida* are sources of limonoids that are antifeedant for both Lepidopteran and Coleopteran larvae (Jacobson, 1989). The Rutaceae family is also an important source of botanical insect controls. Limonoids are commonly found in this family. **Nomilin** (Figure 10.4), a limonoid from citrus seeds, is found to be nearly as effective as azadirachtin. Alkaloids from Rutaceous plants, such as *Zanthoxylum monophyllum*, *Teda trichocarpa*, *Fagara chalybea*, and *F. holstii*, all showed antifeedant activity against a variety of Lepidopteran, Orthopteran, and Coleopteran pests. A member of the Rutaceae, native to the southeastern United States, *Zanthoxylum clava-herculis* (Southern Prickly Ash), is more toxic to *Musca domestica* than pyrethrins and is ovidical to the human body louse *Pediculus humanus* (Jacobson, 1989).

There are many potential insect pests that have coevolved with their food sources, and each insect is different in many respects. There is, therefore, no simple bioassay for insecticidal screening. A wide variety of insect species were used to evaluate insecticidal or insect repellent activity, including ants (Bowers et al., 1993), mosquitoes (Rao et al., 1992; Tunon et al., 1994), moth larvae (Gallo et al., 1996; Hedin et al., 1996), and termites (Reyes-Chilpa et al., 1995). We employed the fruit fly as a model organism (Setzer et al., 1998), because there is literature precedent and because of their ease of handling.

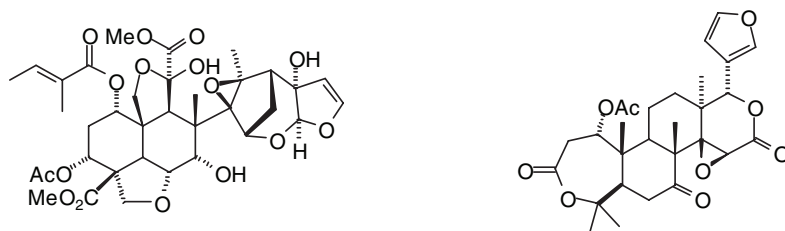

FIGURE 10.4 Structures of azadirachtin (left) and nomilin (right).

Fruit fly insecticidal activity is carried out using a modification of the procedure of McChesney and Adams (1985). Into each 100 ml vial is added a mixture of instant *Drosophila* medium (3 g; available from Carolina Biological Supply, Burlington, NC), crude extract (100 mg), and dry yeast (2 mg), which was pulverized using a mortar and pestle. Enough water is added to dilute the mixture to a volume of 20 ml. Ten recently emerged adult flies (five males, five females) are placed in each vial, and survivors are counted after 5 d. On day 7, surviving adult flies are released, and larvae are allowed to develop. Newly emerged adults are counted on day 21. Three replicates are carried out for each extract plus controls. The synthetic commercial insecticides **SEVIN®** (1-naphthyl *N*-methylcarbamate) and **DIAZINON®** (diethyl 2-isopropyl-4-methyl-6-pyrimidyl thionophosphate) are used as positive insecticidal controls. The fruit fly insecticidal assay was used to identify the *Archidendron vaillantii* (Mimosaceae) and *Balanops australiana* (Balanopaceae) bark extracts from north Queensland, Australia, to be significantly insecticidal (Setzer et al., 1998).

**Insect repellent/antifeedant activity** using the fruit fly is carried out by preparing the extracts as above. Three vials of different extract/medium mixtures and one control vial are placed in a *Drosophila* habitat (Carolina Biological Supply, Burlington, NC; a plastic box with four vials for feeding/breeding selection by the fruit flies). Recently emerged adult flies (40 females, 5 males) are placed in the habitat, and visitation into each vial is observed for 5 d. The number of visitors in each vial is counted twice per day (a total of ten separate counts for each extract plus controls). A citronella-based commercial insect repellent (**NATRAPEL®**) and *N,N*-diethyl-*m*-toluamide (**DEET®**) are used as positive controls for insect repellent activity. *Cryptocarya densiflora* (Lauraceae) bark and *Motherwellia haplosciadia* (Araliaceae) leaf extracts from north Queensland, Australia, showed insect repellent activity without insecticidal activity using this assay (Setzer et al., 1998).

#### 10.4.3 *Solenopsis invicta* (Red Imported Fire Ant)

We carried out preliminary insect repellent studies using the red imported fire ant (*Solenopsis invicta*), a serious agricultural pest, as a model insect organism (unpublished). Fire ants are carnivorous; their diet is made up of other insects, spiders, pyriopods, earthworms, and other small invertebrates, as well as carrion (Holldobler and Wilson, 1990). In our assay, a bait is prepared by maceration of mealworms (*Tenebrio molitor* larvae; available in bulk from Carolina Biological Supply Company, Burlington, NC) with dried plant extract (to make a 1% mixture of extract in mealworm gruel). A selection of baits (including negative, no extract; and positive, DEET, controls) is placed near active fire ant mounds. Visitation by fire ants is then periodically recorded. Ant visitation (total number of ants per extract) is then analyzed using the **chi-square goodness of fit test** (Zar, 1998). Comparison of **visitation frequency** (average number of ants per count and variation) is analyzed using **single-factor analysis of variance (ANOVA)** and **Tukey's multiple comparison test** (Zar, 1998). Crude bark extracts of *Acalypha macrostachya* (Euphorbiaceae), *Ardisia revoluta* (Myrsinaceae), *Dyphisa americana* (Papilionaceae), *Ocotea meziana* (Lauraceae), and *Ocotea veraguensis* (Lauraceae) from Monteverde, Costa Rica, showed insect repellent activity comparable to DEET® using this assay (unpublished).

#### 10.4.4 *Meloidogyne incognita* (Root-Knot Nematode) Nematocidal Assay

The root-knot nematode, *Meloidogyne incognita* Chitwood, is a ubiquitous plant parasite found on all five continents (Sasser and Freckman, 1987). It attacks more than 700 species of plants, including economically important crops like potatoes, sugarcane, tomatoes, cereals, beans, pineapples, carrots, tobacco, and cotton. Infected plants show retarded growth and development and yield quality, and quantities are significantly reduced. The nematodes reproduce by parthenogenesis, and only the second larval stage and males are free-living and non-parasitic. Development of this parasite up to the second-stage larvae takes place in the roots of the plant. The life cycle depends on temperature, and under ideal conditions (25°C), the nematode completes its life cycle in 4 to 6 weeks.

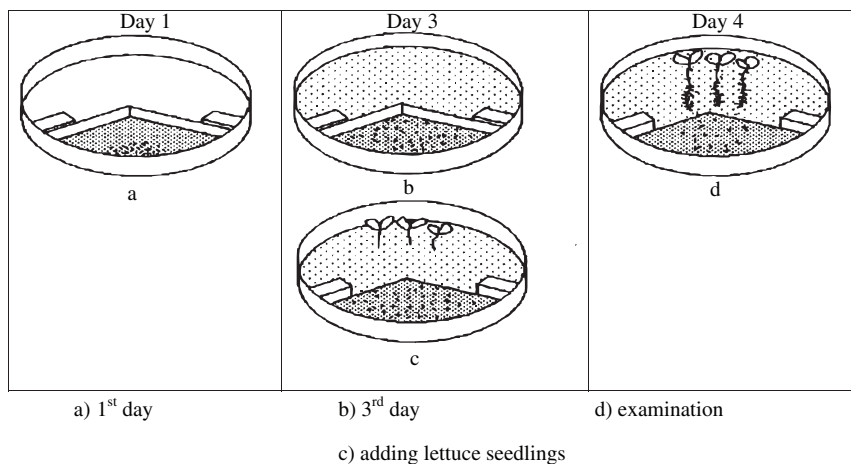

**FIGURE 10.5** Nematocidal bioassay. (a) Introduction of *M. incognita* and test compounds. (b) Addition of Sphadex medium. (c) Planting lettuce seedlings and removal of barrier. (d) Microscopic evaluation of dead, immobilized, and live nematodes.

**The Test Procedure** — The second larval stage of the plant parasitic root-knot nematode (*M. incognita*) is used as the test organism for this nematocidal bioassay. The protocol developed by Lung (1989), which was established by Hartwig (1990) and later revised by Thiele (1991) and then improved by Jandl (1988), was adapted. The improved bioassay technique (Figure 10.5) detects only the nematocidal activity of the materials tested, and effects of phytotoxic compounds are eliminated. Sphadex® G-150 (Sigma-Aldrich, St. Louis, MO) is taken as the matrix. Because the nematode larvae can move freely in between particles, the transparency of the wet Sphadex® also allows for direct observation under light microscopy. The extracts are dissolved first in methanol or acetone, and water is added to give the final concentration of the solution of 2% methanol or 7% acetone, respectively. A 6 cm diameter plastic petri dish is compartmentalized into two parts with a plastic barrier that is not fixed. The barrier is positioned by leaning it against two pieces of plastic grid glued to the bottom dish. Into the smaller compartment, which covers about 30% of the surface, 50 mg Sphadex G-150 is poured and mixed with 1.25 ml of the test solution. One hundred (100) µl suspension containing 140 to 180 second-stage larvae of *M. incognita* are introduced into the Sphadex.

On the third day, 140 mg Sphadex is added into the larger compartment and mixed with 3.5 ml water. Two hours later, three lettuce seedlings are inserted, and the barrier is removed. The nematodes are allowed to feed on the roots of the seedlings. On the fourth day, the petri dishes are examined under a binocular microscope at 100× amplification, and the dead or immobilized nematodes are recorded. The nematocidal effect is expressed in %Abbott, in terms of the decrease in the number of live nematodes attracted to lettuce roots compared to the control, using the following equation:

$$\% \text{ Abbott} = \frac{\Sigma \text{control} - \Sigma \text{test compound}}{\Sigma \text{control}} \times 100$$

All experiments are conducted in three replicates.

#### 10.4.5 *Caenorhabditis elegans* Anthelmintic Assay

In 1995, about 17 million people around the world died due to infectious diseases (World Health Organization, 1996). It is also reported that approximately 1 million individuals suffered from worm infections, with 200,000 death cases. The treatment of worm infection with anthelmintics is the first line of chemotherapeutic intervention. Drugs that are widely used include **benzimidazoles** as well as the active substances of the **avermectins** group, which are isolated from bacteria and semisynthetically

modified. The **anthelmintic properties** of compounds from medicinal plants are well known. **Santonin**, the main active substance isolated from wormwood (*Artemisia maritima* L.), and **flix acids** from *Dryopteris filix-mas* (Maxim.) are examples of plant-derived anthelmintics. Many plants worldwide are used as anthelmintics in traditional medicine. However, the active compounds and their pharmacological actions are not known, and therefore, isolation of anthelmintically active plant products is an encouraging area of research (Borris and Schaeffer, 1992).

**The Test Procedure** — The protocol for anthelmintic screening (Roos, 1998) using *Caenorhabditis elegans* (Maupas) Dougherty developed by Simpkin and Coles (1981) is used. The test is carried out in a 24-well tissue culture plate with a well volume of 2.5 ml. Each well is filled with 2 ml of M9 liquid medium. M9 solution consists of 6 g Na<sub>2</sub>HPO<sub>4</sub>, 3 g KH<sub>2</sub>PO<sub>4</sub>, 5 g NaCl, 0.25 g MgSO<sub>4</sub>·7H<sub>2</sub>O dissolved in 1000 ml water and autoclaved at 120°C for 20 min. Extract solutions, dissolved in DMSO, are added to make 500 ppm solutions, and then 10 µl *C. elegans* suspensions containing 30 to 40 larvae are subsequently introduced into each cell. The plates are incubated at 20°C for 5 d, and the number of dead nematodes is recorded using a phase contrast microscope, and anthelmintic activity is graded as shown below:

- Nematode counts and the motility of the nematodes correspond to the control
- + 0 to 20% fewer nematodes than the control; nematodes move slowly
- ++ Slightly higher nematode counts than the initial counts; nematode counts 20% less than the control; nematodes move very slowly
- +++ Same nematode counts as the initial counts, all dead

Active fractions/compounds are repeated with lower concentrations and compared to known anthelmintics, such as santonin.

#### 10.4.6 *Epilachna varivestis* (Mexican Bean Beetle) Antifeedant Assay

The use of antifeedant substances offers significant possibilities for management of insect pests of economic importance while minimizing damage to the ecosystem. **Antifeedants** are substances that cause the cessation of feeding, either temporarily or permanently depending upon their potency. For testing the antifeedant activity of selected plant extracts, the methodology developed by Steets (1975) and modified by Schwinger et al. (1984) using the Mexican bean beetle, *Epilachna varivestis* Muls. (Coleoptera: Coccinellidae) (Figure 10.6), was adapted. The simple rearing procedure and the short generation time of the insect coupled with the year-round availability of one of its host plants (the common bean, *Phaseolus vulgaris* L.) in the greenhouse makes *E. varivestis* an ideal test insect.

##### 10.4.6.1 Dual-Choice Antifeedant Assay

Leaves of suitable size are selected from 1-month-old bean plants. One half of the upper surface of the leaf is painted with methanol-dissolved extract and the other part with methanol. Treated leaves are allowed to dry and are then placed on nylon mesh on top of a moistened filter paper laid on a 15 cm diameter petri dish (lid plate). The bottom dish with a circular hole in the center (6 cm diameter) is laid on top of the leaf in such a way that the exposed leaf is divided into two equal parts with the main leaf vein acting as the demarcation line between the extract-treated and methanol-treated leaf surfaces. The methanol-treated surface serves as the control. Two fourth-instar larvae (Figure 10.6) are introduced into the 6.0 cm area, and the dish is finally covered with the lid plate (16 cm diameter) (Figure 10.7). The larvae are allowed to feed for 24 h, and the **relative feeding inhibition (RFI)** is computed using the following formula:

$$\text{RFI} = \frac{\% \text{ consumed in untreated part} + \% \text{ consumed in treated part}}{\% \text{ consumed in untreated part} - \% \text{ consumed in treated part}}$$

The number of dead larvae is also recorded. All tests are performed in five replicates.

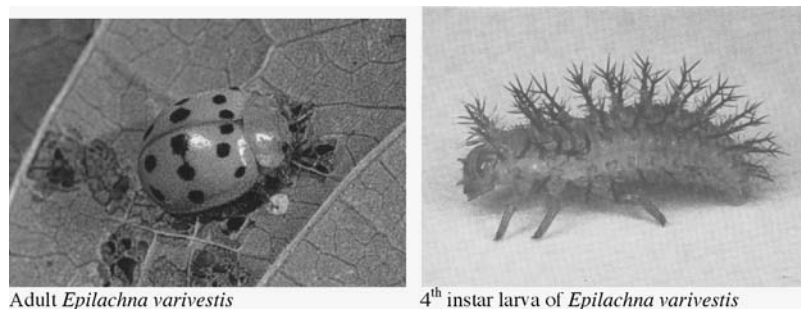

FIGURE 10.6 Mexican bean beetle, *Epilachna varivestis*.

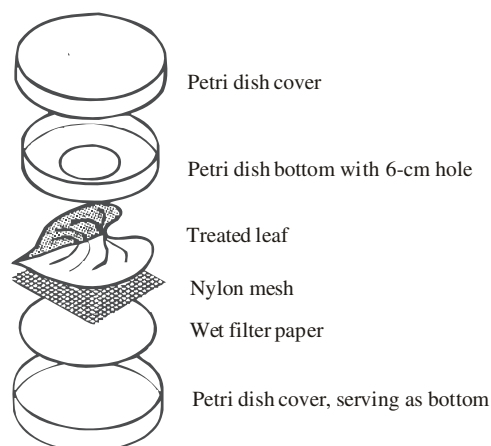

FIGURE 10.7 Setup of the test arena for antifeedant tests.

#### 10.4.6.2 Contact Toxicity

Different concentrations of extracts dissolved in acetone starting at 5000 ppm are topically applied on the dorsal part of the 1-d-old fourth instar larvae and on 2- to 3-week-old adult beetles. A total of ten individuals per experiment are treated, each with 10  $\mu$ l per concentration using a micropipette. Two controls, acetone-treated and untreated, are used. All treated insects are fed with untreated bean leaves. The mortality of the insects is recorded at 24, 48, and 72 h.

#### 10.4.6.3 No-Choice Feeding Test for Insect Growth Regulator

This test is designed for assessing possible **insect growth regulator (IGR)** activity of the extracts. The upper surface of the leaf is painted with extracts dissolved in methanol with concentrations causing 80 to 90% RFI. The setup is the same as that of the antifeedant test, except that the test dish is smaller (15 mm  $\times$  90 mm) and the entire leaf surface is treated with the extract (Figure 10.8). The larvae are fed continuously with treated leaves until they reach their prepupal stage. The adults are allowed to emerge, and larval and pupal mortalities are recorded, along with any abnormalities observed in the beetles.

#### 10.4.7 *Biomphalaria glabrata* (Freshwater Snail) Molluscicidal Assay

**Molluscicides** are compounds toxic to mollusks, which include snails, slugs, and clams. Although snails are harmless to human beings, some of them, notably the genera, *Biomphalaria*, *Bulinus*, or *Oncomelania*, are directly involved in the transmission of **schistosomiasis**, commonly known as **bilharzia**. This is a parasitic disease endemic throughout South America, Africa, the Middle East, and Asia. The WHO estimates that about 200 million people are affected by schistosomiasis, and 400 million more are



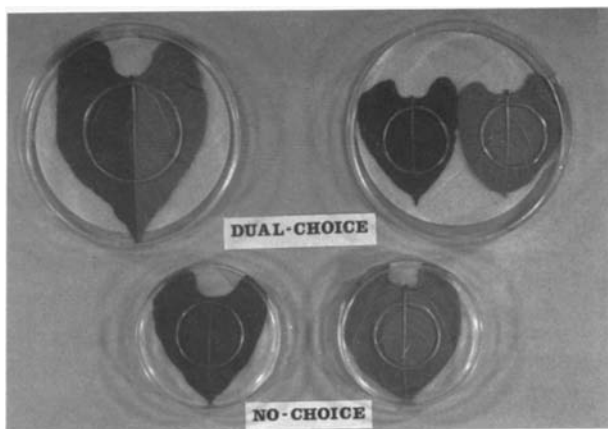

FIGURE 10.8 Setup of the dual-choice test or no-choice test for antifeedant activity.

threatened in 46 countries (WHO, 1990). Three types of schistosoma are important as human parasites: *Schistosoma haematobium* Bilharz causing urogenital bilharzia in Africa and the Middle East, *S. japonicum* Katzurada causing intestinal bilharzia in Southeast Asia, and *S. mansoni* Sambon causing intestinal bilharzia in Africa. *Schistosoma intercalatum* Fischer is also responsible for intestinal infection, but are of limited distribution (Marston and Hostettmann, 1991). In all these species, the life cycle involves an aquatic snail as an intermediate host. Schistosomiasis is most common among rural and agricultural communities living near slow-moving water or lakes. An increased intensity of transmission was observed in association with increased water exploitation through the construction of dams and establishment of irrigation schemes (Hostettmann et al., 1982).

One method of controlling schistosomiasis is chemotherapy involving antiparasitic drugs (e.g., **praziquantel**, **oxamniquine**, **metrifonate**, and **artemisinin**) (Figure 10.9) (Richter, 2003). However, this is expensive, and in many cases, there is a risk of reinfection (Marston and Hostettmann, 1985). An alternative approach is to destroy the intermediate snail host using molluscicides, and thus interrupting the parasite's life cycle.

On the other hand, snails not only pose health problems as vectors of parasites, but also, some species are important agricultural pests. The slugs (naked snails) are highly polyphagous and attack a wide range of agricultural crops. As one example, the golden apple snail (*Pomacea canaliculata* Lamarck) is an important rice (*Oryza sativa*) pest in Southeast Asia.

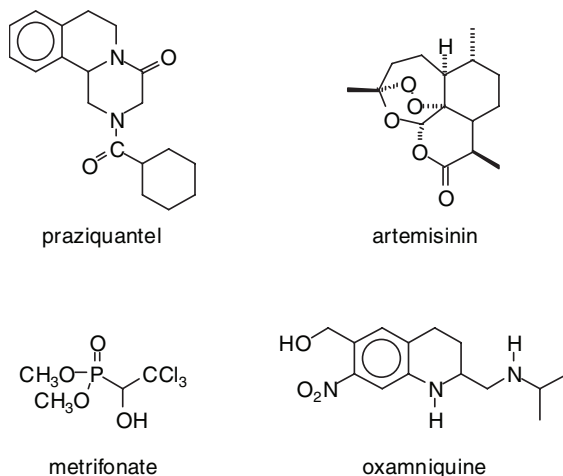
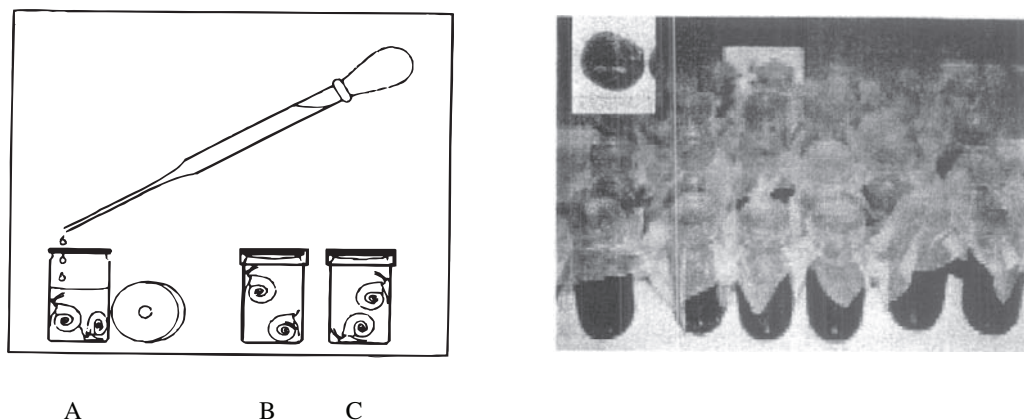

FIGURE 10.9 Chemotherapeutic agents for treatment of schistosomiasis.



**FIGURE 10.10** Molluscicidal assay. (A) Adding test compounds to snails. (B) Removal of snails from test mixture, placing in fresh water. (C) Assessment of dead snails after 24 h.

The currently available molluscicides have a broad spectrum affecting non-target organisms, and thus, disturbing the ecosystem. These synthetic molluscicides are also expensive and carry the risk of possible development of resistance by snails (Perrett and Whitfield, 1996). Use of plants with molluscicidal properties provides a simple and inexpensive alternative. Economical, toxicological, and ecological considerations also favor the use of plant molluscicides, especially in the tropical and subtropical countries where schistosomiasis is endemic, snail infestation in agricultural crops is a problem, and financial resources are often limited.

Screening for molluscicidal activity in plants is an important step in this direction. It is believed that plant molluscicides will be most useful in areas where transmission is predominantly local, with the possibility of using plants growing in the same region.

**The Test Procedure** — The test is conducted according to the standard procedure of WHO (1965) using *Biomphalaria glabrata* (Say) (Figure 10.10). The **rapid molluscicidal screening method** of Marston and Hostettmann (1985), a modified version of the Kubo and Nakanishi (1977) method, is used. The snails are reared in aquaria with water temperature of 24°C and fed with salad leaves. All plant extracts are screened at 500, 100, and 50 ppm. Two *B. glabrata* (1 cm diameter) are placed in 5 ml vials, filled with plant extract solutions in distilled water. In cases where the extracts are not soluble in water, the extracts are dissolved first in DMSO (0.5% in water) or ethanol (0.4%) + PEG (polyethylene glycol) 400 (0.2%) depending on the polarity of the extract. The vials are covered with a perforated plastic lid, and mortality is recorded at 24 h. After 24 h, the snails are removed from the test solution, washed with tap water, and transferred to a container filled with water used in rearing the snails. The snails are allowed to recover for another 24 h, and the final mortality is recorded after 48 h of treatment. All experiments are conducted in three replicates.

## 10.5 Biochemical Screens

Once a suitable target is identified, screening efforts can be directed at that particular biochemical target. These may involve inhibition of particular enzymes, the blocking of certain receptors, or interactions with other biomolecules (e.g., **DNA**, **tubulin**). Visualization of the assay is generally effected by spectrophotometric/colorimetric or fluorescence detection, electrophoresis, radiometric methods, or nuclear magnetic resonance (NMR) techniques (see Chapters 8 and 9).

### 10.5.1 Based on Spectrophotometric Detection

Biochemical assays that produce suitable chromophores as the end-products or utilize chromophores as starting materials have been utilized for many different targets. For example, determination of **radical-**

**scavenging activity** (same as **ROS, reactive oxygen species**) of plant extracts and phytochemicals was carried out by spectrophotometric analysis of the **1,1-diphenyl-2-dipicrylhydrazyl** free radical (**DPPH**) (Braca et al., 2001; Hwang et al., 2001). Inhibition of **xanthine oxidase** was monitored by spectrophotometric detection of **uric acid** (Lin et al., 2000). Inhibition of **angiotensin converting enzyme (ACE)** was quantified using the substrate **furan acryloyl-L-phenylalanyl glycyl glycine (FAPGG)** that is hydrolyzed by the enzyme to give the substituted amino acid **furan acryloyl-L-phenylalanine (FAP)** as the product chromophore (Holmquist, Bünning, and Riordan, 1979; Vermeirssen, Van Camp, and Verstraete, 2002), and intercalation of DNA by aromatic natural products was assessed by displacement of intercalated **methyl green** (Burres et al., 1992).

### 10.5.1.1 Papain Inhibition Assay

**Papain** is a prototypical cysteine protease. Notable members of this family of proteases include **cathepsin K**, which was implicated in bone resorption (Saftig et al., 1998), and **falcipain-2** from *Plasmodium falciparum*, which is used by the parasite to hydrolyze hemoglobin (Shenai et al., 2000). These enzymes, therefore, are attractive targets for chemotherapy of osteoporosis and malaria, respectively. Papain (commercially available from Sigma Chemical Co., St. Louis, MO) activity is measured by a spectrophotometric assay using **N-CBZ-Phe-Arg p-nitroanilide** (available from Bachem Bioscience Inc., King of Prussia, PA) as the spectrophotometric substrate (Percival et al., 1999). Solutions of papain (125 mg·ℓ<sup>-1</sup> papain and 6 mg·DTT ℓ<sup>-1</sup> in a buffer of 50 mM MES, 2.5 mM EDTA, 10% DMSO, pH 6.5) and CBZ-Phe-Arg-pNA (9.1 mg CBZ-Phe-Arg-pNA dissolved in 25 ml buffer, 50 mM MES, 2.5 mM EDTA, 10% DMSO, pH 6.5) are prepared. Into each well of a 96-well plate are pipetted, 50 μl papain solution + 2.5 μl test compound (1% solutions in DMSO, in quadruplicate). DMSO is used as a negative control, and **tosyl lysine chloromethyl ketone (TLCK)**, available from Sigma Chemical Co., St. Louis, MO) is used as a positive control. The plate is allowed to sit for 30 min, and then the CBZ-Phe-Arg-pNA solution (50 μl) is added to each well. The absorbance at 405 nm is recorded after 5, 20, and 45 min.

### 10.5.1.2 Trypanothione Reductase Inhibition

**African trypanosomiasis**, “**sleeping sickness**,” is caused by subspecies of the parasitic protozoa, *Trypanosoma brucei*, *T. b. gambiense*, and *T. b. rhodesiense*, and is transmitted by tsetse flies (*Glossina* spp.) (Denise and Barrett, 2001). American trypanosomiasis or **Chagas disease** (Talaro and Talaro, 1993) is caused by the parasitic protozoan *Trypanosoma cruzi*, which is transmitted by Triatomid (“kissing”) bugs. **Trypanothione reductase** is a key enzyme involved in the oxidative stress management of *Trypanosoma* parasites and was identified as an important biochemical target for the treatment of trypanosomal parasitic infections (Fairlamb, 1990; Barrett and Gilbert, 2002).

Recombinant **trypanothione reductase (TR)** (Krauth-Siegel et al., 1987) activity is measured by a spectrophotometric assay using **5,5-dithiobis(2-nitrobenzoic acid)** (Ellman’s reagent, DBS<sub>2</sub>) and **trypanothione** (available from Bachem Bioscience Inc., King of Prussia, PA) (a modification of the procedure described by Hamilton et al., 2003). Into each well of a 96-well plate are pipetted 100 μl potassium phosphate buffer (pH 8), 1.5 μl 5.5 mM NADPH, 10 μl 0.012 M DBS<sub>2</sub>, 1 μl test compound (1% solutions in DMSO), 10 μl TR enzyme (0.044 mg·ml<sup>-1</sup>). Test compounds are evaluated in quadruplicate; DMSO controls and no enzyme (positive controls) are included. The trypanothione substrate solution (10 μl of 12.5 μM) is then added to each well. The absorbance at 416 nm is recorded.

## 10.5.2 Based on Gel Electrophoresis

Alterations in biopolymer structure can be assessed using **gel electrophoresis** (see Chapter 8). The **electrophoretic mobility** of biomolecules can be used to determine interactions of phytochemicals with proteins or changes in the morphology of DNA. For example, the interaction of lignans with bovine brain **calmodulin** was assessed using **sodium dodecyl sulfate polyacrylamide gel electrophoresis (SDS-PAGE)** techniques (Rojas et al., 2003); inhibition of **topoisomerase I** mediated DNA cleavage was

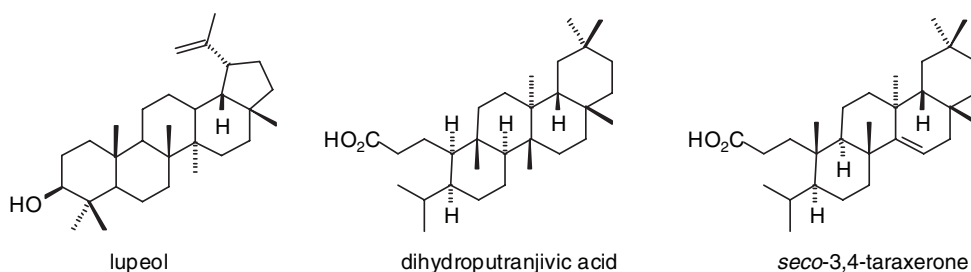

FIGURE 10.11 Structures of lupeol, dihydroputranjivic acid, and *seco*-3,4-taraxerone.

analyzed by **agarose gel electrophoresis** (see Chapter 8) (Kobayashi et al., 1995). We describe, below, the topoisomerase II inhibition assay based on agarose gel electrophoresis that we used in our laboratory.

### 10.5.2.1 Topoisomerase II Inhibition

DNA topology is regulated by enzymes known as **topoisomerases**; thus, these enzymes play essential roles in DNA replication, transcription, chromosome segregation, and DNA recombination (Nitiss and Beck, 1996). There are two major classes of topoisomerases. **Type I DNA topoisomerases** act by making a single-stranded nick, while **type II topoisomerases** nick both strands of DNA. A number of clinically important antitumor agents were shown to be topoisomerase inhibitors. Thus, for example, **camptothecin** is a specific target of topoisomerase I, and **etoposide** inhibits topoisomerase II. These enzymes continue to be attractive targets for anticancer drug discovery.

The topoisomerase II assay is based on inhibition of the relaxation of supercoiled circular DNA by topoisomerase II (Osheroff et al., 1983). pBR322 plasmid DNA (available from Sigma Chemical Co., St. Louis, MO) is used as the substrate for topoisomerase II from *Drosophila melanogaster* (commercially available from USB Corp., Cleveland, OH). Topoisomerase-mediated DNA relaxation is analyzed by agarose gel electrophoresis.

Prior to the assay, topoisomerase II is freshly diluted to a concentration of one unit- $\mu\text{l}^{-1}$  in 15 mM sodium phosphate, pH 7.1, 50 mM NaCl, 0.1 mM EDTA, 0.2 mM dithiothreitol, 0.5 mg- $\text{ml}^{-1}$  bovine serum albumin, and 10% glycerol. pBR322 plasmid DNA is diluted to a concentration of 0.3  $\mu\text{g}\cdot\mu\text{l}^{-1}$ . The standard assay mixture contains 0.3  $\mu\text{g}$  (5 nM) pBR322 plasmid DNA, 1 mM ATP, and two units topoisomerase II in 20  $\mu\text{l}$  of relaxation buffer (10 mM *tris*-HCl, pH 7.9, 50 mM NaCl, 50 mM KCl, 5 mM  $\text{MgCl}_2$ , 0.2 mM EDTA, and 15  $\mu\text{g}\cdot\text{ml}^{-1}$  bovine serum albumin). Relaxation is carried out at 30°C for 30 min and is stopped by the addition of 3  $\mu\text{l}$  of 7 mM EDTA/0.77% SDS/60% sucrose/0.05% bromphenol blue. Samples are heated to 70°C for 2 min, then 20  $\mu\text{l}$  from each sample is loaded into separate wells of a 1% agarose gel and are subjected to electrophoresis in 1  $\times$  TBE buffer (90 mM Tris-borate, pH 8.2, 2 mM EDTA) at 2 V- $\text{cm}^{-1}$  for 6.5 to 7 h. Gels are stained for 30 min with aqueous ethidium bromide (1  $\mu\text{g}\cdot\text{ml}^{-1}$ ). DNA bands are visualized by transillumination with ultraviolet (UV) light (300 nm) and photographed. Typical assays include samples with 1  $\mu\text{l}$  of test compounds in DMSO added at several concentrations, enzyme controls with no test compounds, DMSO controls, negative controls with no topoisomerase enzyme added, and etoposide as a positive control. Comparison is made of the extent of relaxation of plasmid DNA in the presence of the test compounds as compared with lanes with no compounds added and those with varying concentrations of positive inhibitor added. The concentration required to produce a 50% decrease in topoisomerase activity is determined. Using this assay, we determined that the triterpenoids, **lupeol** (Moriarity et al., 1998), **dihydroputranjivic acid**, and ***seco*-3,4-taraxerone** (Setzer et al., 2000) (see Figure 10.11) inhibit topoisomerase II.

## 10.6 Evaluation of Structural Interactions via NMR and MS Methods

The demands of sample throughput in the drug discovery process have dramatically increased over the past years for several reasons. With better understanding of biochemistry, the number of molecular targets

has multiplied, and chemical compound archives to be tested have dramatically increased due to more efficient separation technologies as well as approaches like combinatorial libraries. Over the past several years, standard **plate-based assay technologies** involving fluorescence, radioactivity, or absorbance were scaled and enhanced to accommodate the increased number of compounds especially brought on by **combinatorial chemistry**. In these approaches, the identification of a binding partner has to be inferred, or independently confirmed, because the detection of the binding event is not based on a discriminating property of the binding partner.

Only a few technologies offer direct readout in which the monitored signal provides both binding data and species identification. These methodologies include NMR measurements (Lepre et al., 2004) and a collection of techniques hyphenated with mass spectrometry (Hage and Tweed, 1997; Blom et al., 1999).

### 10.6.1 NMR-Based Methods

NMR methods can generally be divided into two groups of experiments — **ligand-based screening** and **receptor-based screening**.

#### 10.6.1.1 Ligand-Based Screening Methods

The typical implementation of ligand-based screening methods compares the NMR parameters of a mixture of compounds in the presence or absence of the receptor molecules. The advantage of this approach is that there is no dependence on the molecular weight of the receptor. In fact, the larger the molecular weight of the receptor, the more sensitive these experiments get. Furthermore, there is no need for the synthesis of isotope-labeled receptor molecules, which is normally essential in order to be observed in the NMR measurement. There is also no need for lengthy assignment measurements to get a good knowledge of the NMR parameters of the receptor. The disadvantage of this approach is the inability to localize the binding site of the small molecule in the receptor. The ability to distinguish free molecules from bound ligands is based on the small molecular weights of the compounds (<500 Da), which exhibit short relaxation rates, vanishing or weakly negative **nuclear Overhauser enhancement spectroscopy (NOESY)** cross-peaks, and large translational diffusion coefficients, when observed as free molecules. Bound compounds, on the other hand, share the NMR properties of the much larger receptor mass (>20,000 Da). Therefore, ligands have large relaxation rates, positive NOESY cross-peaks, and highly efficient spin diffusion as well as smaller diffusion coefficients. These distinct differences imply that a dramatic change in NMR parameters in the presence of receptors indicates **target binding**. Approaches based on NOESY spectroscopy were demonstrated in the application to find antagonists to E-selectin (Henrichsen et al., 1999) and angiotensin converting enzyme (Mayer and Meyer, 2000). Small molecules (MW < 1500 Da) in the free state yield small, positive NOEs; on the other hand, large molecules (MW > 10 kDa) give rise to large, negative NOEs. Ligands reversibly binding to a biomacromolecule are labeled with information of the large protein, and thus, exhibit large and negative NOEs. Consequently, binding of ligands to a large biomolecule can be monitored by the characteristics of these so-called transferred NOEs (trNOE). trNOE experiments are limited to ligands with **dissociation constants ( $K_D$ )** in the range between  $10^3$  and  $10^7$  M, because of averaging effects, due to fast chemical exchange.

#### 10.6.1.2 Diffusion Spectroscopy-Based Methods

Exploiting the differential mobility of the ligand in the free versus the bound form will result in dramatic differences of the measured diffusion coefficient (Lucas and Larive, 2003). Those compounds that bind to the much larger receptor will experience slower rotational and translational mobility due to the complex formation with the receptor.

Diffusion coefficient experiments are possible using pulse sequences that incorporate **pulsed-field gradients (PFGs)**. PFGs are generated by passing a current through an additional pair of coils in the NMR probe. To measure diffusion, z-gradient coils are generally used. These coils are coaxial with, but physically separated from, the radiofrequency coil. The strength of the applied gradient varies linearly

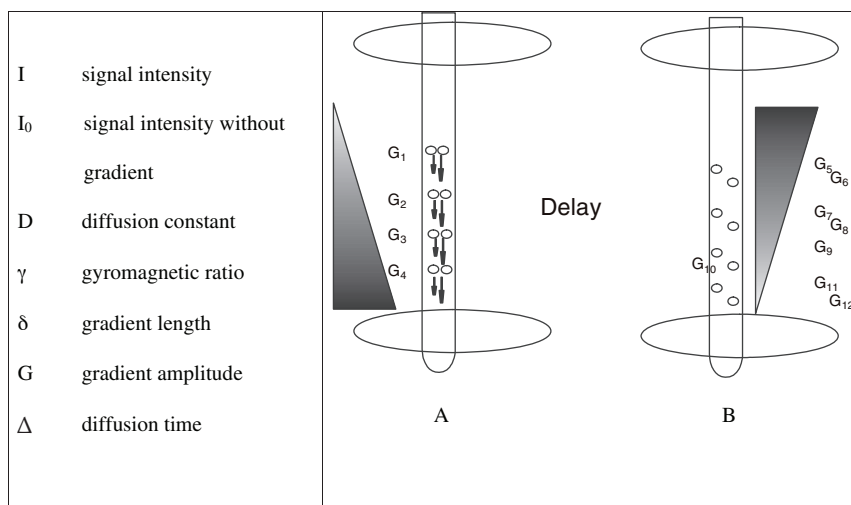

**FIGURE 10.12** Effect of gradients in a diffusion experiment. (A) Encoding gradient. (B) Decoding gradient. Arrows indicate different path length for the diffusion process.

along the sample length. **Strength** is experimentally defined in terms of gradient amplitude  $G$ , duration  $\delta$ , and the gyromagnetic ratio  $\gamma$ . Experiments are done, such that at the beginning of the experiment, the sample is encoded with a gradient, a short delay is applied when diffusion takes place, and finally, the sample is decoded with the opposite gradient. As a result of the first gradient, pulse molecules that are located at different positions along the long axis ( $z$ -axis) of the tube experience different gradient strengths. In the subsequent delay, these molecules are allowed to move along the  $z$ -axis. Finally, a second gradient with equal gradient strength, however, opposite in sign, is applied. Because bound ligands diffuse differently (slower) than unbound ligands, they move into a different opposite gradient field (Figure 10.12). In effect, the gradient pulse allows the positions of the nuclei to be tracked before and after the diffusion time, because each individual molecule experiences a net difference between the encoding gradient and the decoding gradient. The efficiency of the decoding gradient depends on how far, on average, the molecules diffuse longitudinally with respect to the direction of the applied field gradient. Because a difference in the gradients that the molecules experience results in an artificially introduced inhomogeneity, this leads to cancellation of the signal. The larger the diffusion, the larger is the difference of the encoding and decoding gradient, and thus, the smaller the intensity of the observed signal. Small, unbound molecules, for example, will decode more poorly than molecules bound to a large receptor. The larger difference will lead to stronger attenuation because the magnetization is not completely refocused. That is, the observed spectrum is lost for molecules that move long distances (i.e., small molecules) but remains nearly identical for those molecules that move very little (macromolecules with bound ligands). The resulting signal intensity can be described as follows:

$$I = I_0 \exp[-D(\gamma\delta G)^2(\Delta - \delta/3)]$$

In the actual measurement, gradient strength of the decoding gradient and the delay between the encoding and decoding gradients are varied. Diffusion experiments are taken without and with receptor so that the different behaviors can be recorded. Because the measurements are mostly one-dimensional NMR measurements, short acquisition times can be achieved. The technique is able to deal with mixtures so that a number of samples can be evaluated in one measurement. This greatly reduces time requirements for large collections of samples (e.g., combinatorial libraries or crude plant extracts). Based on this general idea, there are different diffusion experiments in order to accommodate different requirements of the sample (Table 10.2).

A successful application of this approach is the identification of high-affinity ligands for FK506 binding protein (Hajduk et al., 1997). For a detailed discussion of these experiments, the reader is referred to the original reference.

TABLE 10.2

Diffusion Spectroscopy-Based Methods

Pulse Sequence	Requirements	Advantages (+) and Limitations (-)	Potential Applications	Ref.
PGSE	$T_2 > \Delta$	Analysis of only singlets (not general) Macromolecules with short $T_2$ , such as proteins, cannot be studied	Small organic	Stejskal and Tanner, 1965; Hahn, 1950; Carr and Purcell, 1954
STE	$T_1 > \Delta$	+ $J$ -coupled spins and molecules with short $T_2$ can be analyzed Potential eddy current artifacts	Any sample; macromolecules in particular	Tanner, 1970
LED	$T_1 > \Delta$ $T_2 > \delta + \tau_r$	+ Eddy current artifacts suppressed $T_e$ delay increases experimental time Problems with chemical exchange	Same as STE	Gibbs and Johnson, 1991
BPPLED, BPPSTE	$T_1 > \Delta$ $T_2 > \delta + \tau_r$	+ Eddy current artifacts removed (BPPLED) + Static gradients removed + Chemical exchange effects minimized	Same as STE	Wu et al., 1995; Karlicek and Lowe, 1980; Dvinskikh and Furo, 2000; Otto and Larive, 2001
CPMG-BPPSTE	Same as BPPSTE with significant differences ligand versus protein	+ Suppression of protein background Decreased S/N Elimination of ligand resonances broadened by protein binding	Complex mixtures of small and large molecules	Otto and Larive, 2001; Chin et al., 2000
GOSE-BPPSTE	Same as BPPSTE	+ Selective for singlet magnetization	Same as CPMG-BPPSTE	Otto and Larive, 2001

### 10.6.1.3 SHAPES

The **SHAPES** strategy proposed by Fejzo et al. (1999) consists of screening a diverse library of drug-like molecules combined with successive rounds of follow-up screens by high-throughput screening, NMR, or other direct-binding assays. The compounds are comprised of scaffolds and side chains commonly found in known drugs. The general idea is to start with simple molecules so that the generation of lead compounds can be kept as simple as possible. This approach was successfully applied to **fatty acid binding protein (FABP-4)** (Weigelt et al., 2002). Recently, an application of the SHAPES screening was reported to target RNA (Johnson et al., 2003).

### 10.6.1.4 Receptor-Based Screening Methods

These methods incorporate the site-specific characterization afforded by assigned protein NMR spectra along with *a priori* knowledge of the protein's three-dimensional structure (either from x-ray or NMR) to drive lead generation. By identifying perturbations of assigned protein resonances, not only are ligands identified to be active, but also, their binding sites are localized. This technique is based on the fact that by adding a ligand to a protein, the resonances close to the binding site will be different when the ligand is bound to the receptor. Typically, this is monitored through  $^1\text{H}$ - $^{15}\text{N}$ -HSQC spectra (Figure 10.13). As a consequence, labeled protein has to be used in these studies. This, in turn, can be used to optimize the identified ligands even further. A major caveat of this approach is that many therapeutically important

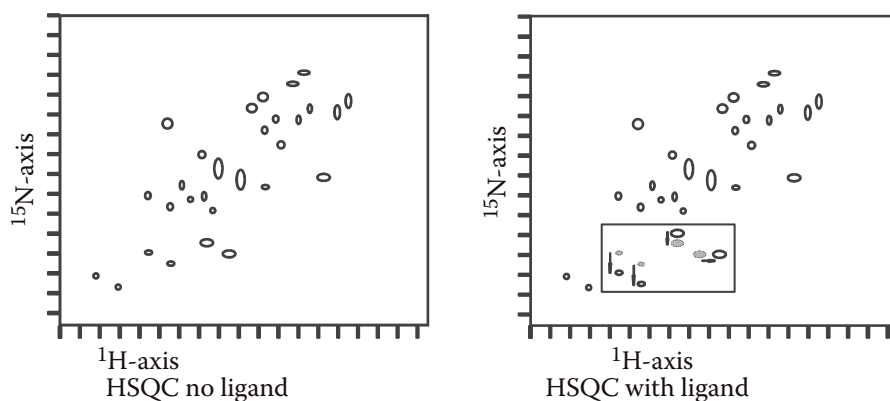

FIGURE 10.13 Typical  $^1\text{H}$ - $^{15}\text{N}$ -HSQC correlation map used to determine binding sites.

proteins are not amenable to NMR-spectroscopic investigations. This approach is limited to proteins with molecular weights smaller than 30,000. For the NMR studies, milligram quantities of soluble, nonaggregated protein must be expressed and purified. Thus, suitable expression hosts have to be found that allow isotopic labeling of the protein, critical for the resonance assignments of the proteins. The resonance assignment of the protein is a rather lengthy process, which again limits the applicability of this approach.

#### 10.6.1.5 SAR by NMR

In cases where the protein is available, an approach proposed by Shuker et al. (1996) can be used to derive potent inhibitors of proteins from weakly binding fragments. This approach was successfully applied in finding potent inhibitors of **matrix metalloproteinase stromelysin (MM-P3)** (Hajduk et al., 1997). The method involved identification, optimization, and linking of compounds that bind to proximal sites of the protein. Thus, two weakly binding ligands ( $K_D = 17 \text{ mM}$  and  $K_D = 0.02 \text{ mM}$ , respectively) were linked together to produce a potent inhibitor ( $K_D = 15 \text{ nM}$ ) of this enzyme (Figure 10.14).

Further successful application of this approach was demonstrated for the **far-upstream-element (FUSE)** binding protein (**FBP**) (Huth et al., 2004) and protein tyrosine phosphatase 1B (Liu et al., 2003).

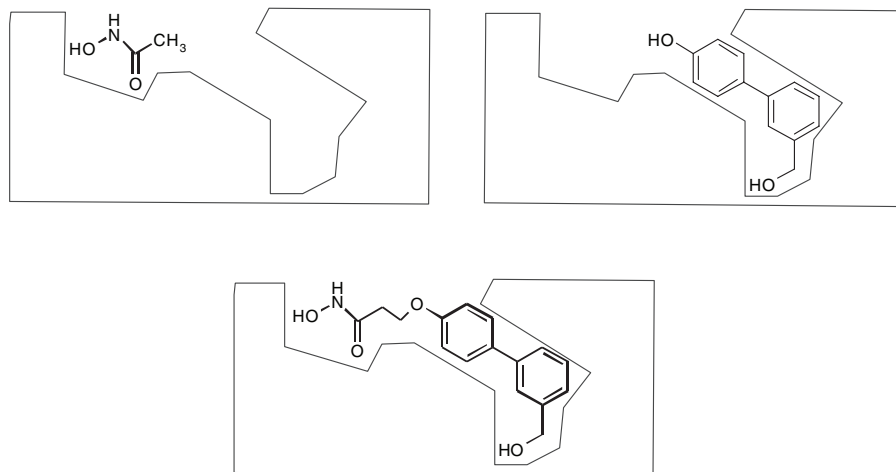

FIGURE 10.14 SAR by NMR. Top panels: Identification of two weak binders located in their respective binding sites. Bottom panel: The combination of the two structures fills the whole binding site.



### 10.6.2 MS Methods

A number of methods using only mass spectrometric detection were proposed for the screening of drug candidates by evaluating noncovalent complexes between the ligand and a target protein. A general approach uses **electrospray mass spectrometry** to directly produce ions of complexes from a condensed-phase system and then detects them in the gas phase (Loo, 1997; Heck and Van den Heuvel, 2004). The assumption in this case is that the gas-phase system mimics the condensed-phase system.

A second approach depends on an ancillary separation process such that the mass spectrometric part is limited to the detection of compounds. Separation techniques involved are **spin-column gel permeation chromatography** (Dunayevskiy et al., 1997), **affinity chromatography** (Belenky et al., 2004), and **frontal affinity chromatography** (Schriemer et al., 1998; Chan et al., 2003; Zhang et al., 2003).

Spin-column chromatography is based on gel permeation chromatography columns, which are prepared in such a way that small molecules not bound to a protein are retained on the column, whereas molecules bound to a large protein are passed through the column upon centrifugation (Siegel et al., 1998). Electrospray mass spectrometry allows for the analysis of bound ligands.

In affinity chromatography, a protein target is immobilized onto a column. Small molecule libraries are passed through the column. Captured compounds are separated from nonspecifically bound library components by centrifugal ultrafiltration. The specifically selected molecules retained on the filter are subsequently liberated from the antibodies by acidification and analyzed by HPLC coupled with electrospray (ion spray) ionization mass spectrometric detection (Wieboldt et al., 1997).

In **frontal affinity chromatography (FAC)**, a receptor is immobilized on a suitable support material and packed in a column. A mixture containing potential ligands is continuously infused through the column, rather than injected in the conventional “spike” form. Active ligands will bind to the column, but eventually, the capacity of the column will be exceeded, which results in the ligands breaking through at their infusion concentration. All nonretained compounds will break through earlier in the void volume of the system. Electrospray mass spectrometry allows for the sensitive detection of compounds that break through the column (less than  $1 \text{ pmol}\cdot\mu\text{L}^{-1}$ ), but more importantly, it provides an extra dimension to the analysis, namely, the  $m/z$  ratio. **FAC-MS** has been applied to study the binding properties of **EGFR** inhibitors (Zhu et al., 2003), hepatitis C virus (**HCV**) NS3 protease (Luo et al., 2003), and global kinase screening (Slon-Usakiewicz et al., 2005).

The main disadvantage of these approaches is the inability of the mass spectrometric method to discriminate between specific binding and nonspecific binding. Furthermore, there is no evidence from MS measurements about the binding site of the ligand or the structure of the protein–ligand complex.

Finally, a new approach based on the dramatic change of diffusion coefficients for molecules specifically binding to a large drug target was incorporated using **electrospray ionization mass spectrometry (ESI-MS)** (Clark and Konerman, 2004). A solution is injected into a capillary tube that was previously filled with a different solution with another analyte concentration. Under flow conditions, there is a competition between diffusion and dispersion due to laminar flow. The outlet of the tube is connected to the **ESI** source of a mass spectrometer, where the signal intensity of the analyte is monitored as a function of time. Analytes with large diffusion coefficients will show relatively steep transitions, whereas smaller diffusion coefficients result in more extended dispersion profiles.

---

## 10.7 Conclusions

Identification of natural products from plants that may serve as valuable sources of bioactive agents for medicinal and agricultural uses largely depends on bioactivity-directed isolation. The choices of bioassays depend a great deal on the amounts of material to be tested and the time and effort necessary to carry out the assays. Obviously, an *in vivo* assay using the organism afflicted (e.g., humans with prostate tumors or cattle infected with trypanosomes) would provide the most meaningful results. However, exploratory screening using whole animals is impractical, and various *in vitro* screening methods were developed to provide guided separation and identification of lead compounds. These *in vitro* methods have the advantage in that they can be automated with robotics and miniaturized, leading to rapid

throughput screening of large numbers of samples. In addition, the *in vitro* bioassays may provide activity information that is precluded by poor bioavailability using a whole-animal *in vivo* assay. That is, for example, natural products that inhibit the growth of tumor cells or bacteria in an *in vitro* assay may identify promising molecular structures that would benefit from semisynthetic modification. *In vitro* cell culture techniques may also identify new biochemical targets, although they do not necessarily provide bioavailability information. Conversely, biochemical screening methods provide activity information for the particular biochemical target (e.g., enzyme inhibition or receptor blocking) but provide no information about new potential targets.

---

## References

- Barrett, M.P. and I.H. Gilbert. (2002). Perspectives for new drugs against trypanosomiasis and leishmaniasis. *Curr Top Med Chem* 2: 471–482.
- Belenky, B., D. Hughes, A. Korneev, and Y. Dunayevskiy. (2004). Capillary electrophoretic approach to screen for enzyme inhibitors in natural extracts. *J Chromatogr A* 1053: 247–251.
- Bernabei, P.A., V. Santini, L. Silvestro, O. Dal Pozzo, R. Bezzini, I. Viano, V. Gattei, R. Saccardi, and P. Rossi Ferrini. (1989). *In vitro* chemosensitivity testing of leukemic cells: development of a semiautomated colorimetric assay. *Hematol Oncol* 7: 243–253.
- Blom, K.F., B.S. Larsen, and C.N. McEwen. (1999). Determining affinity-selected ligands and estimating binding affinities by online size exclusion chromatography/liquid chromatography-mass spectrometry. *J Comb Chem* 1: 82–90.
- Borris, R.B. and J.M. Schaeffer. (1992). In *Phytochemical Resources for Medicine and Agriculture*, H.N. Niggs and D. Seigler (Eds.). Plenum Press, New York, pp. 117–147.
- Bowers, W.S., F. Ortega, X. You, and P.H. Evans. (1993). Insect repellents from the Chinese prickly ash *Zanthoxylum bungeanum*. *J Nat Prod* 56: 935–938.
- Braca, A., N. De Tommasi, L. Di Bari, C. Pizza, M. Politi, and I. Morelli. (2001). Antioxidant principles from *Bauhinia tarapotensis*. *J Nat Prod* 64: 892–895.
- Burres, N.S., A. Frigo, R.R. Rasmussen, and J.B. McAlpine. (1992). A colorimetric microassay for the detection of agents that interact with DNA. *J Nat Prod* 55: 1582–1587.
- Cailleau, R., R. Young, M. Olive, and W.J. Reeves. (1974). Breast tumor cell lines from pleural effusions. *J Natl Cancer Inst* 53: 661–674.
- Carr, H.Y. and E.M. Purcell. (1954). Effects of diffusion on free precession in nuclear magnetic resonance experiments. *Phys Rev* 94: 630–638.
- Centers for Disease Control. (1994). *Addressing Emerging Infectious Disease Threats. A Prevention Strategy for the United States*. Centers for Disease Control, Washington, D.C.
- Chan, N.W.C., D.F. Lewis, P.J. Rosner, M.A. Kelly, and D.C. Schriemer. (2003). Frontal affinity chromatography-mass spectrometry assay technology for multiple stages of drug discovery: applications of a chromatographic biosensor. *Anal Biochem* 319: 1–12.
- Chin, J.A., A. Chen, and M.J. Shapiro. (2000). SPEEDY: Spinecho enhanced diffusion filtered spectroscopy. A new tool for high resolution MAS NMR. *J Comb Chem* 2: 293–296.
- Clark, S.M. and L. Konerman. (2004). Screening for noncovalent ligand–receptor interactions by electrospray ionization mass spectrometry-based diffusion measurements. *Anal Chem* 76: 1257–1263.
- Cory, A.H., T.C. Owen, J.A. Bartrop, and J.G. Cory. (1991). Use of an aqueous soluble tetrazolium/formazan assay for cell growth assays in culture. *Cancer Commun* 3: 207–212.
- Denise, H. and M.P. Barrett. (2001). Uptake and mode of action of drugs used against sleeping sickness. *Biochem Pharmacol* 61: 1–5.
- Denizot, F. and R. Lang. (1986). Rapid colorimetric assay for cell growth and survival. Modifications to the tetrazolium dye procedure giving improved sensitivity and reliability. *J Immunol Methods* 89: 271–277.
- Dunayevskiy, Y.M., J.J. Lai, C. Quinn, F. Talley, and P. Vourous. (1997). Mass spectrometric identification of ligands selected from combinatorial libraries using gel filtration. *Rapid Commun Mass Spectrom* 11: 1178–1184.
- Dvinskikh, S.V. and I. Furo. (2000). Cross-relaxation effects in stimulated-echo-type PGSE NMR experiments by bipolar and monopolar gradient pulses. *J Magn Reson* 146: 283–289.

- Fairlamb, A.H. (1990). Future prospects for the chemotherapy of human trypanosomiasis. 1. Novel approaches to the chemotherapy of trypanosomiasis. *Trans R Soc Trop Med Hyg* 84: 613–617.
- Fejzo, J., C.A. Lepre, J.W. Peng, G.W. Bemis, Ajay, M.A. Murcko, and J.M. Moore (1999). The SHAPES strategy: an NMR-based approach for lead generation in drug discovery. *Chem Biol* 6: 755–769.
- Fogh, J. (1978). Cultivation, characterization, and identification of human tumor cells with emphasis on kidney, testis, and bladder tumors. *Natl Cancer Inst Monograph* 5–9.
- Gallo, L.G., L.L. Allee, and D.M. Gibson. (1996). Insecticidal effectiveness of *Mammea americana* (Guttiferae) extracts on larvae of *Diabrotica virgifera* (Coleoptera: Chrysomelidae) and *Trichoplusia ni* (Lepidoptera: Noctuidae). *Econ Bot* 50: 236–242.
- Gentry, G.A. and J.F. Aswell. (1975). Inhibition of herpes simplex virus replication by araT. *Virology* 65: 294–296.
- Gibbs, S.J. and C.S. Johnson. (1991). A PFG NMR experiment for accurate diffusion and flow studies in the presence of eddy currents. *J Magn Reson* 93: 395–402.
- Hage, D.S. and S.A. Tweed. (1997). Recent advances in chromatographic and electrophoretic methods for the study of drug–protein interactions. *J Chromatogr B* 699: 499–525.
- Hahn, E.L. (1950). Spin echoes. *Phys Rev* 80: 580–594.
- Hajduk, P.J., E.T. Olejniczak, and S.W. Fesik. (1997). One-dimensional relaxation- and diffusion-edited NMR methods for screening compounds that bind to macromolecules. *J Am Chem Soc* 119: 12257–12261.
- Hajduk, P.J., G. Sheppard, D.G. Nettlesheim, E.T. Olejniczak, S.B. Shuker, R.P. Meadows, D.H. Steinman, G.M. Carrera, P.A. Marcotte, J. Severin, K. Walter, H. Smith, E. Gubbins, R. Simmer, T.F. Holzman, and D.W. Morgan. (1997). Discovery of potent nonpeptide inhibitors of stromelysin using SAR by NMR. *J Am Chem Soc* 119: 5818–5827.
- Hamilton, C.J., A. Saravanamuthu, I.M. Eggleston, and A.H. Fairlamb. (2003). Ellman’s-reagent-mediated regeneration of trypanothione *in situ*: substrate-economical microplate and time-dependent inhibition assays for trypanothione reductase. *Biochem J* 369: 529–537.
- Hartwig, J. (1990). Bayer AG, Geschäftsbereich Pflanzenschutz, Monheim, Germany. Private communication.
- Heck, A.J.R. and R.H.H. Van den Heuvel. (2004). Investigation of intact protein complexes by mass spectrometry. *Mass Spectrom Rev* 23: 368–389.
- Hedin, P.A., F.M. Davis, W.P. Williams, R.P. Hicks, and T.H. Fisher. (1996). Hemicellulose is an important leaf-feeding resistance factor in corn to the fall armyworm. *J Chem Ecol* 22: 1655–1668.
- Henrichsen, D., B. Ernst, J.L. Magnani, W.T. Wang, B. Meyer, and T. Peters. (1999). Bioaffinity NMR spectroscopy: identification of an E-selectin antagonist in a substance mixture by transfer NOE. *Angew Chem Int Ed* 38: 98–102.
- Holldobler, B. and E.O. Wilson. (1990). *The Ants*. Harvard University Press, Cambridge, Massachusetts.
- Holmquist, B., P. Bünning, and J.F. Riordan. (1979). A continuous spectrophotometric assay for angiotensin converting enzyme. *Anal Biochem* 95: 540–548.
- Hostettmann, K, H. Kizu, and T. Tomimori. (1982). Molluscicidal properties of some saponins. *Planta Med* 44: 34–35.
- Huth, J.R., L. Yu, I. Collins, J. Mack, R. Mendoza, B. Isaac, D.T. Braddock, S.W. Muchmore, K.M. Comess, S.W. Fesik, G.M. Clore, D. Levens, and P.J. Hajduk. (2004). NMR-driven discovery of benzoylanthranilic acid inhibitors of far upstream element binding protein binding to the human oncogene c-myc promoter. *J Med Chem* 47: 4851–4857.
- Hwang, B.Y., H.S. Kim, J.H. Lee, Y.S. Hong, J.S. Ro, K.S. Lee, and J.J. Lee. (2001). Antioxidant benzoylated flavan-3-ol glycoside from *Celastrus orbiculatus*. *J Nat Prod* 64: 82–84.
- Ipsen, J. and P. Feigel. (1970). In *Bancroft’s Introduction to Biostatistics*, 2nd ed., chap. 15, “Bioassay” (pp. 163–170). Harper & Row, New York.
- Jacobson, M. (1989). Botanical pesticides, past, present, and future. In *Insecticides of Plant Origin*, chap. 1, J.T. Arnason, B.J.R. Philogene, and P. Morand (Eds.). American Chemical Society, Washington, D.C.
- Jandl, A. (1988). *Optimierung verschiedener Parameter eines biologischen Tests auf nematizide Wirkung von Naturstoffen*. Diploma thesis. University of Hohenheim, Stuttgart, Germany.
- Johnson, E.C., V.A. Feher, J.W. Peng, J.M. Moore, and J.R. Williamson. (2003). Application of NMR SHAPES screening to an RNA target. *J Am Chem Soc* 125: 15274–15275.
- Kaighn, M.E., K.S. Narayan, Y. Ohnuki, J.F. Lechner, and L.W. Jones. (1979). Establishment and characterization of a human prostatic carcinoma cell line (PC-3). *Invest Urol* 17: 16–23.

- Karlicek, R.F. and I.J. Lowe. (1980). A modified pulsed gradient technique for measuring diffusion in the presence of large background gradients. *J Magn Reson* 37: 75–91.
- Knowles, B.B., C.C. Howe, and D.P. Aden. (1980). Human hepatocellular carcinoma cell lines secrete the major plasma proteins and hepatitis B surface antigen. *Science* 209: 497–499.
- Kobayashi, Y., Y. Yamashita, N. Fujii, K. Takaboshi, T. Kawakam, M. Kawamura, T. Mizukami, and H. Nakano. (1995). Inhibitors of DNA topoisomerase I and II isolated from the *Coptis* rhizomes. *Planta Med* 61: 414–418.
- Krauth-Siegel, R.L., B. Enders, G.B. Henderson, A.H. Fairlamb, and R.H. Schirmer. (1987). Trypanothione reductase from *Trypanosoma cruzi*. Purification and characterization of the crystalline enzyme. *Eur J Biochem* 164: 123–128.
- Kubo, I. and K. Nakanishi. (1977). Studies on warburganal, muzigadial and related compounds. *Isr J Chem* 16: 28–31.
- Lepre, C.A., J.M. Moore, and J.W. Peng. (2004). Theory and applications of NMR-based screening in pharmaceutical research. *Chem Rev* 104: 3641–3675.
- Lin, J.K., P.C. Chen, C.T. Ho, and S.Y. Lin-Shiau. (2000). Inhibition of xanthine oxidase and suppression of intracellular reactive oxygen species in HL-60 cells by theaflavin-3,3-digallate, (-)-epigallocatechin-3-gallate, and propyl gallate. *J Agric Food Chem* 48: 2736–2743.
- Liu, G., Z. Xin, Z. Pei, P.J. Hajduk, C. Abad-Zapatero, C.W. Hutchins, H. Zhao, T.H. Lubben, S.J. Ballaron, D.L. Haasch, W. Kaszubska, C.M. Rondinone, J.M. Trevillyan, and M.R. Jirousek. (2003). Fragment screening and assembly: a highly efficient approach to a selective and cell active protein tyrosine phosphatase 1B inhibitor. *J Med Chem* 46: 4232–4235.
- Loo, J.A. (1997). Studying noncovalent protein complexes by electrospray ionization mass spectrometry. *Mass Spectrometr Rev* 16: 1–23.
- Lucas, L.H. and C.K. Larive. (2003). Measuring ligand-protein binding using NMR diffusion experiments. *Concepts Magn Res A* 20A: 24–41.
- Lung, G. (1989). Eine methode zu testen von nematiziden und nematodenbeeinflussenden substanzen. *Nematologica* 35: 248–258.
- Luo, H., L. Chen, Z. Li, Z. Ding, and X. Xu. (2003). Frontal immunoaffinity chromatography with mass spectrometric detection: a method for finding active compounds from traditional Chinese herbs. *Anal Chem* 75: 3994–3998.
- Marston, A. and K. Hostettmann. (1985). Plant molluscicides. *Phytochemistry* 24: 639–652.
- Marston, A. and K. Hostettmann. (1991). Assays for molluscicidal, cercaricidal, schistosomicidal and piscicidal activities. In *Methods in Plant Biochemistry, Assays for Bioactivity*, Vol. 6, K. Hostettmann, P.M. Dey, and J.B. Harborne (Eds.). Academic Press, London, pp. 153–178.
- Mayer, M. and B. Meyer. (2000). Mapping the active site of angiotensin-converting enzyme by transferred NOE spectroscopy. *J Med Chem* 43: 2093–2099.
- McChesney, J.D. and R.P. Adams. (1985). Co-evaluation of plant extracts as petrochemical substitutes and for biologically active compounds. *Econ Bot* 39: 74–86.
- McLaughlin, J.L. (1991). Bench top bioassays for the discovery of bioactive compounds in higher plants. *Brenesia* 34: 1–14.
- Moriarity, D.M. and C.R. Savage. (1980). Interaction of epidermal growth factor with adult rat liver parenchymal cells in primary culture. *Arch Biochem Biophys* 203: 506–518.
- Moriarity, D.M., J. Huang, C.A. Yancey, P. Zhang, W.N. Setzer, R.O. Lawton, R.B. Bates, and S. Caldera. (1998). Lupeol is the cytotoxic principle in the leaf extract of *Dendropanax cf. querceti*. *Planta Med* 64: 370–372.
- Nitiss, J.L. and W.T. Beck. (1996). Antitopoisomerase drug action and resistance. *Eur J Cancer* 32A: 958–966.
- Osheroff, N., E.R. Shelton, and D.L. Brutlag. (1983). DNA topoisomerase II from *Drosophila melanogaster*. *J Biol Chem* 258: 9536–9543.
- Otto, W.H. and C.K. Larive. (2001). Improved spin-echo-edited NMR diffusion measurements. *J Magn Reson* 153: 1–4.
- Percival, M.D., M. Ouellet, C. Campagnolo, D. Claveau, and C. Li. (1999). Inhibition of cathepsin K by nitric oxide donors: evidence for the formation of mixed disulfides and a sulfenic acid. *Biochemistry* 38: 13574–13583.
- Perrett, S. and P.J. Whitfield. (1996). Currently available molluscicides. *Parasitol Today* 12: 156–159.
- Promega Technical Bulletin #245. (1996). CellTiter 96<sup>®</sup> AQ<sub>ueous</sub> one solution cell proliferation assay. Promega Corp., Madison, Wisconsin.

- Rao, D.R., R. Reuben, M.S. Venugopal, B.A. Nagasampagi, and H. Schmutterer. (1992). Evaluation of neem, *Azadirachta indica*, with and without water management, for the control of culicine mosquito larvae in rice-fields. *Med Vet Entomol* 6: 318–324.
- Reyes-Chilpa, R., N. Viveros-Rodrigues, F. Gomez Garibay, and D. Alaves-Solano. (1995). Antitermitic activity of *Lonchocarpus castilloi* flavanoids and heartwood extracts. *J Chem Ecol* 21: 455–463.
- Richter, J. (2003). The impact of chemotherapy on morbidity due to schistosomiasis. *Acta Tropica* 86: 161–183.
- Rojas, S., L. Acevedo, M. Macias, R.A. Toscano, R. Bye, B. Timmermann, and R. Mata. (2003). Calmodulin inhibitors from *Leucophyllum ambiguum*. *J Nat Prod* 66: 221–224.
- Roos, G. (1998). *Naturstoffe aus Butea monosperma (Fabaceae), Vernonia fastigiata (Asteraceae) und Thamosma africana (Rutaceae) mit anthelminthischer, nematizider und antibakterieller Wirkung*. Dissertation, University of Hohenheim, Stuttgart, Germany.
- Russell, W.C. (1962). A sensitive and precise plaque assay for herpes virus. *Nature* (London) 195: 1028–1029.
- Saftig, P., E. Hunziker, O. Wehmeyer, S. Jones, A. Boyde, W. Rommerskirch, J.D. Moritz, P. Schu, and K. von Figura. (1998). Impaired osteoclastic bone resorption leads to osteopetrosis in cathepsin-K-deficient mice. *Proc Natl Acad Sci USA* 95: 13453–13458.
- Sahm, D.H. and J.A. Washington. (1991). Antibacterial susceptibility tests: dilution methods. In *Manual of Clinical Microbiology*, A. Balows, W.J. Hausler, K.L. Herrmann, H.D. Isenberg, and H.J. Shamody (Eds.). American Society for Microbiology, Washington, D.C.
- Sam, T.W. (1993). Toxicity testing using the brine shrimp, *Artemia salina*. In *Bioactive Natural Products*, S.M. Colgate and R.J. Molyneux (Eds.). CRC Press, Boca Raton, Florida, pp. 441–456.
- Sasser, J.N. and D.W. Freckman. (1987). A world perspective on nematology: the role of the society. In *Vistas on Nematology*, J.A. Veech and D.W. Dickson (Eds.). Society of Nematologists, Hyattsville, Maryland, pp. 7–14.
- Schmidtko, M., U. Schnittler, B. Jahn, H.M. Dahse, and A. Stelzner. (2001). A rapid assay for evaluation of antiviral activity against coxsackie virus B3, influenza virus A, and herpes simplex virus type 1. *J Virol Meth* 95: 133–143.
- Schriemer, D.C., D.R. Bundle, L. Li, and O. Hindsgaul. (1998). Micro-scale frontal affinity chromatography with mass spectrometric detection: a new method for the screening of compound libraries. *Angew Chem Int Ed* 37: 3383–3387.
- Schwinger, M., B. Ehhammer, and W. Kraus. (1984). Methodology of the *Epilachna Varivestis* bioassay antifeedants demonstrated with some compounds. In *Natural Pesticides from Neem Tree and Other Tropical Plants*, H. Schmutterer and K.R.S. Ascher (Eds.). G.T.Z. Publishers, Eschborn, Germany, pp. 181–198.
- Scudiero, D.A., R.H. Shoemaker, K.D. Paull, A. Monks, S. Tierney, T.H. Nofziger, M.J. Currens, D. Seniff, and M.R. Boyd. (1988). Evaluation of a soluble tetrazolium/formazan assay for cell growth and drug sensitivity in culture using human and other tumor cell lines. *Cancer Res* 48: 4827–4833.
- Setzer, M.C., W.N. Setzer, B.R. Jackes, G.A. Gentry, and D.M. Moriarity. (2001). The medicinal value of tropical rainforest plants from Paluma, North Queensland, Australia. *Pharm Biol* 39: 67–78.
- Setzer, M.C., D.M. Moriarity, R.O. Lawton, W.N. Setzer, G.A. Gentry, and W.A. Haber. (2003). Phytomedicinal potential of tropical cloudforest plants from Monteverde, Costa Rica. *Rev Biol Trop* 51: 647–674.
- Setzer, W.N., S.M. Talley, and B.R. Jackes. (1998). Pesticidal activity and phytochemical screening of north Queensland tropical rainforest plant extracts. *Queensland Naturalist* 36: 11–20.
- Setzer, W.N., M.N. Flair, K.G. Byler, J. Huang, M.A. Thompson, A.F. Setzer, D.M. Moriarity, R.O. Lawton, and D.B. Windham-Carswell. (1992). Antimicrobial and cytotoxic activity of crude extracts of Araliaceae from Monteverde, Costa Rica. *Brenesia* 38: 123–130.
- Setzer, W.N., M.C. Setzer, A.L. Hopper, D.M. Moriarity, G.K. Lehrman, K.L. Niekamp, S.M. Morcomb, R.B. Bates, K.J. McClure, C.C. Stessman, and W.A. Haber. (1998). The cytotoxic activity of a *Salacia* liana species from Monteverde, Costa Rica, is due to a high concentration of tingenone. *Planta Med* 64: 583.
- Setzer, W.N., X. Shen, R.B. Bates, J.R. Burns, K.J. McClure, P. Zhang, D.M. Moriarity, and R.O. Lawton. (2000). A phytochemical investigation of *Alchornea latifolia*. *Fitoterapia* 71: 195–198.
- Setzer, W.N., B. Vogler, J.M. Schmidt, J.G. Leahy, and R. Rives. (2004). Antimicrobial activity of *Artemisia douglasiana* leaf essential oil. *Fitoterapia* 75: 192–200.
- Shenai, B.R., P.S. Sijwali, A. Singh, and P.J. Rosenthal. (2000). Characterization of native and recombinant falcipain-2, a principal trophozoite cysteine protease and essential hemoglobinase of *Plasmodium falciparum*. *J Biol Chem* 275: 29000–29010.

- Shuker, S.B., P.J. Hajduk, R.P. Meadows, and S.W. Fesik. (1996). Discovering high-affinity ligands for proteins: SAR by NMR. *Science* 274: 1531–1534.
- Siegel, M.M., K. Tabei, G.A. Beberitz, and E.Z. Baum. (1998). Rapid methods for screening low molecular mass compounds non-covalently bound to proteins using size exclusion and mass spectrometry applied to inhibitors of human cytomegalovirus protease. *J Mass Spectrom* 33: 264–273.
- Simpkin, K.G. and G.C. Coles. (1981). The use of *Caenorhabditis elegans* for anthelmintic screening. *J Chem Tech Biotechnol* 31: 66–69.
- Slon-Usakiewicz, J.J., J.R. Dai, W. Ng, J.E. Foster, E. Deretey, L. Toledo-Sherman, P.R. Redden, A. Pasternak, and N. Reid. (2005). Global kinase screening. Applications of frontal affinity chromatography coupled to mass spectrometry in drug discovery. *Anal Chem* 77: 1268–1274.
- Steets, R. (1975). Die wirkung von rohextrakten aus den Meliaceen *Azadirachta indica* und *Melia azadirachta* auf verschiedene insekten. *Z Angew Entomol* 77: 306–312.
- Stejskal, E.O. and J.E. Tanner. (1965). Spin diffusion measurements: spin echoes in the presence of a time-dependent field gradient. *J Chem Phys* 42: 288–292.
- Talaro, K. and A. Talaro. (1993). *Foundations in Microbiology*. W.C. Brown Publishers, Dubuque, Iowa.
- Tanner, J.E. (1970). Use of the stimulated echo in NMR diffusion studies. *J Chem Phys* 52: 2523–2526.
- Thiele, S. (1991). *Isolierung und Strukturaufklaerung neuer Tetranortriterpenoide aus Azadirachta indica A.JUSS (neem tree, Meliaceae) und Untersuchungen der nematiziden Wirkungen von Neem Extrakten*. Dissertation, University of Hohenheim, Stuttgart, Germany.
- Tomlin, C. (1997). *The Pesticide Manual*, 11th ed. British Crop Protection Council, Surrey, United Kingdom.
- Tunon, H., W. Thorsell, and L. Bohlin. (1994). Mosquito repelling activity of compounds occurring in *Achillea millefolium* L. (Asteraceae). *Econ Bot* 48: 111–120.
- Vermeirssen, V., J. Van Camp, and W. Verstraete. (2002). Optimization and validation of an angiotensin-converting enzyme inhibition assay for the screening of bioactive peptides. *J Biochem Biophys Methods* 51: 75–87.
- Walum, E., K. Strenberg, and D. Jenssen. (1990). *Understanding Cell Toxicology: Principles and Practice*. Ellis Horwood, New York, pp. 97–111.
- Weigelt, J., M. van Dongen, J. Uppenberg, J. Schultz, and M. Wikstrom. (2002). Site-selective screening by NMR spectroscopy with labeled amino acid pairs. *J Am Chem Soc* 124: 2446–2447.
- Wieboldt, R., J. Zweigenbaum, and J. Henion. (1997). Immunoaffinity ultrafiltration with ion spray HPLC/MS for screening small-molecule libraries. *Anal Chem* 69: 1683–1691.
- World Health Organization. (1965). *Molluscicide Screening and Evaluation*. *Bull WHO* 33: 567–581.
- World Health Organization. (1990). *Health Education in the Control of Schistosomiasis*. WHO, Geneva.
- World Health Organization. (1996). World Health Report 1996. <http://www.who.int/whr/1996/en/>.
- Wu, D., A. Chen, and C.S. Johnson. (1995). An improved diffusion-ordered spectroscopy experiment incorporating bipolar-gradient pulses. *J Magn Reson Ser A* 115: 260–264.
- Zar, J.H. (1998). *Biostatistical Analysis*, 4th ed. Prentice-Hall, Upper Saddle River, New Jersey.
- Zhang, B., M.M. Palcic, D.C. Schriemer, G. Alvarez-Manilla, M. Pierce, O. Hindsgaul, L. Zhu, L. Chen, H. Luo, and X. Xu. (2003). Frontal affinity chromatography combined on-line with mass spectrometry: a tool for the binding study of different epidermal growth factor receptor inhibitors. *Anal Chem* 75: 6388–6393.



# 11

## *Modes of Action at Target Sites*

Sara L. Warber, Mitchell Seymour, Peter B. Kaufman, Ara Kirakosyan,  
and Leland J. Cseke

### CONTENTS

11.1	Introduction .....	416
11.2	Cell Life Cycle and Cancer Treatment.....	416
11.2.1	Opening Remarks.....	416
11.2.2	Cell Life Cycle.....	416
11.2.3	Genistein.....	417
11.2.4	Taxoids and <i>Vinca</i> Alkaloids.....	418
11.2.5	Homoharringtonine and Protein Synthesis .....	419
11.2.6	Rhein and Necrosis .....	420
11.2.7	Mistletoe and Apoptosis.....	421
11.2.8	Section Summary .....	421
11.3	Transmembrane Signaling.....	422
11.3.1	Opening Remarks.....	422
11.3.2	Ligand-Gated Ion Channels .....	422
11.3.3	G-Protein and Second Messengers .....	423
11.3.4	Section Summary .....	424
11.4	Immunomodulation .....	426
11.4.1	Opening Remarks.....	426
11.4.2	Echinacea.....	426
11.4.3	<i>Aloe vera</i> .....	427
11.4.4	Plant Contact Dermatitis .....	427
11.4.5	Section Summary .....	429
11.5	Toxic Effects.....	429
11.5.1	Opening Remarks.....	429
11.5.2	Teratogenesis .....	429
11.5.3	Carcinogenesis.....	429
11.5.4	Toxicity.....	430
11.5.5	Section Summary .....	431
11.6	Molecular Mechanisms at Target Sites.....	431
11.6.1	Opening Remarks.....	431
11.6.2	Effects of Plant Natural Products on Human Cytochrome P450 Enzymes.....	432
11.6.3	Interactions of Plant Natural Products with Nuclear Receptors That Regulate CYP450 Activity .....	433
11.6.4	Photodynamic Therapy (PDT) and the Anticancer Action of Hypericin in St. John's Wort ( <i>Hypericum perforatum</i> ) .....	433
11.6.5	Section Summary .....	434
11.7	Conclusions .....	434
	References .....	435



---

## 11.1 Introduction

Plants and humans have sustained each other for eons. All cultures have some definable plant knowledge that includes appropriate edible plants, medicinal plants, and ceremonial plants. Even in the Western tradition, the first botanists were physicians who kept their own herb gardens for treating the sick. Modern allopathic medicine is derived predominantly from the alchemical practice, but even here, some well-known plants have become part of the scene. **Cardiac glycosides** (i.e., digitalis, from the foxglove) are well-known examples. Much of what we know about nervous system function was defined through the use of **plant alkaloids** (i.e., **muscarine**, **nicotine**, **atropine**, and **ephedrine**). As already demonstrated in this book, plants produce a wide variety of chemicals (see Chapter 1). Our knowledge and appreciation of how these other chemicals interact with the human body grow each year. The mechanisms of action of phytochemicals are far more complex than previously suspected. Plants like *Echinacea* are found to modulate the immune system through such unlikely candidates as polysaccharides. Plant-based medicines are becoming an important part of cancer chemotherapy regimes. The public, disillusioned with allopathic medicine, has an intense interest in herbal preparations, which will further stimulate research into the mechanisms of action of phytochemicals.

This chapter will examine some known mechanisms of action of specific plant preparations. We will consider how phytochemicals participate in cell-cycle interactions, signaling across cell membranes, immunomodulation, toxic reactions, as well as their molecular mechanisms at target sites.

---

## 11.2 Cell Life Cycle and Cancer Treatment

### 11.2.1 Opening Remarks

**Cancer** is one of the predominant killers in the Western world today. Despite much advancement in cancer therapy, many cancers are still ineffectively treated, become resistant, or recur. In addition, the methods of treating cancer are often difficult for patients to tolerate due to the side effects. Thus, there continues to be great interest in the search for new and better treatments. Plant-based medicines have definitely found a role in this type of treatment, and the mechanism of interaction between many phytochemicals and cancer cells has been studied extensively.

### 11.2.2 Cell Life Cycle

In order to understand phytochemical–cell interactions, it is first important to understand a little about the life cycle of human cells, including proliferation, differentiation, and cell death. The **cell life cycle** has four phases (see Figure 11.1): **G<sub>0</sub>**, **G<sub>1</sub>**, **S**, **G<sub>2</sub>**, **M**. **G<sub>0</sub>** is a stage of quiescence that can be of variable length. During this time, the cell carries out its ordinary role for the organism. If there is a commitment to proliferate, then **purines** and **pyrimidines**, the building blocks for DNA synthesis, must be produced. The cell then enters the **G<sub>1</sub>** state in which nucleotides and enzymes are synthesized. In the **S** phase, DNA synthesis occurs. Many enzymes must work together to reproduce an accurate replication of DNA for the new cell. One enzyme of this system that seems to be particularly vulnerable to exogenous plant chemicals is topoisomerase. Its job is to separate the daughter DNA strands. The next phase is **G<sub>2</sub>** when the cell prepares other structures needed for mitosis. The **M** phase is mitosis and the production of two daughter cells that will then enter the cycle themselves.

In most cell systems, there is a period of normal growth that is a time of cell proliferation. With more maturity of the tissue, the cells differentiate into the various specialized subsets required for tissue function. These differentiated cells no longer proliferate; instead, they synthesize the proteins, steroids, and other chemicals required for maintenance or function of the organism. Within the tissue, there remain stem cells capable of proliferation. In some areas, such as bone marrow (where blood cells form), skin, and the lining of the gastrointestinal tract, there is a high turnover of cells. This requires a high density of stem cells and constant proliferation.

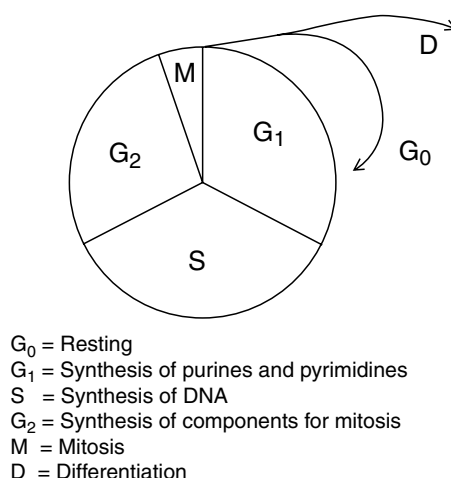

FIGURE 11.1 Cell life cycle.

Cancer cells can be thought of as cells that become capable of proliferation. Much work was done to identify **oncogenes** and **tumor suppressor genes** that are thought to control this abnormal proliferative state. One approach to therapy has been to try to induce cells to differentiate into more specialized cells, and therefore, stop proliferating.

Although stem cells and cancer cells may be nearly immortal due to their proliferative capacity, cell death does occur. **Necrosis** is the process of cell death due to external events such as hypoxia, chemical exposure, radiation injury, and many others. Cells are observed to swell, become vacuolized, and finally be digested by either their own enzymes or the enzymes of neutrophils. The critical insult is to the cell membranes, through lipid peroxidation. This causes permeability changes and allows massive influx of calcium ions. Excess calcium ions inactivate mitochondria and denature proteins and enzymes. Necrosis generally occurs in contiguous cells and is accompanied by an inflammatory response. Many currently available cancer treatments induce necrosis.

In contrast to necrosis, **apoptosis** is programmed death. Here, physiologic signals, such as hormones or growth factors, trigger rapid DNA damage, condensation of chromatin, and fragmentation of DNA. The cell, too, becomes fragmented and is phagocytized by nearby macrophages or neutrophils without causing inflammation. Several chemotherapeutic agents that cause DNA damage also lead to apoptosis. Consequently, researchers are looking more seriously at apoptosis as a goal of chemotherapy. Some natural agents may have more application in this area.

In the sections that follow, we will highlight some of the plant chemicals currently in use as anticancer agents or being studied for their potential application. We will not attempt an exhaustive coverage of this field, but rather, will present a representative one. In turn, these examples will illustrate some of the ways that phytochemicals interact with mammalian or human cells.

### 11.2.3 Genistein

Epidemiological studies showed that populations that have a high soy intake have a lower incidence of breast and prostate cancer, as well as other carcinomas. Genistein is an isoflavone (Figure 11.2) found in high quantities in soybean products. Genistein-containing soy diets were shown to decrease the incidence and number of tumors, and to increase latency in animal models of cancer (Barnes, 1995). Much work has been done in cell-culture models that demonstrate that genistein inhibits proliferation of some types of cancer cells (Peterson, 1995). Cell culture and other *in vitro* techniques were used to elucidate the mechanism by which genistein might alter cancer cell kinetics. There is evidence to support several hypotheses of the target site and mechanisms of action of genistein. Some of these are inhibition of angiogenesis (Fotis et al., 1995), interaction with **steroid hormone receptors**, inhibition of **tyrosine**

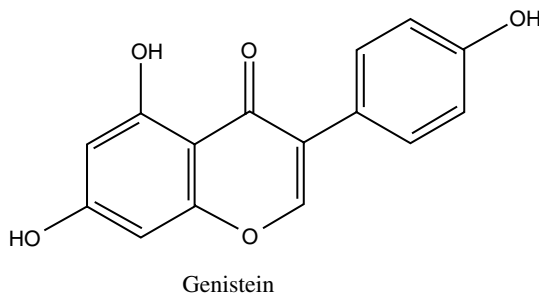

**FIGURE 11.2** Chemical structure of genistein, an isoflavone, commonly found in members of the legume family, Fabaceae.

**kinase**, inhibition of **reactive oxygen species (ROS)** formation, and interaction with **topoisomerase** (Barnes, 1995; Barnes and Peterson, 1995). In this section, we will focus on the interaction with topoisomerase, which appears to be one of the more important mechanisms in regulating cell proliferation.

DNA in its resting state (does it ever really rest?) is highly twisted to conserve intracellular space. In order for transcription to occur, the DNA must be relaxed. The topoisomerase enzymes relax the DNA by nicking single strands. This allows normal gene expression to occur and cells to proliferate. Genistein is postulated to stabilize the enzyme/DNA complex in such a way that both strands are nicked, and DNA breaks occur. Hypothetically, this leads to altered gene expression and cell differentiation and a concomitant decrease in cell proliferation. Experiments showed that at genistein concentrations high enough to induce cell differentiation, all types of cells tested had extensive DNA breakage. In a cell-free system containing supercoiled plasmid DNA and genistein, linear DNA (i.e., broken DNA) was produced only when **topoisomerase II** was present. This supports topoisomerase as the active site for genistein (Contantinou and Huberman, 1995). Further support comes from other experiments where cell lines were developed that were resistant to the effects of genistein. Resistant cells showed altered activity of topoisomerase II (Markovits et al., 1989) or markedly reduced expression of the topoisomerase II  $\beta$  isoform (Markovits et al., 1995). Because of genistein's site of activity, it will be further tested as an anticancer agent. Soy products, in general, are an important part of a diet to promote wellness.

#### 11.2.4 Taxoids and *Vinca* Alkaloids

Several anticancer agents create their effects by interrupting cell division. Because cancer cells are dividing at a more rapid rate than the normal cells around them, the chemotherapeutic agents have a proportionally greater impact on the tumor cells. The target site for the **taxoids** and the well-known ***Vinca* alkaloids** is **microtubule** formation. Microtubules are critical to spindle and aster formation in all cells as they prepare for mitosis. Microtubules also have other cellular functions, such as maintenance of cell shape, cellular motility, attachment, and intracellular transport. Tubulin dimers polymerize to form microtubules. This is in dynamic equilibrium controlled according to the cell's needs by intracellular messengers, such as calcium and guanosine triphosphate (GTP) (Rowinsky et al., 1990).

The *Vinca* alkaloids, **vinblastine** and **vincristine** (Figure 11.3), are derived from the periwinkle (*Catharanthus roseus*). They have been used for many years in treating lymphomas and acute childhood leukemia, respectively. Vincristine and vinblastine inhibit cancer cell reproduction by promoting **microtubule disassembly**. They bind to the **tubulin dimers**. When the tubulin-alkaloid complex attaches to the microtubule, polymerization is terminated, and depolymerization begins. Mitosis is arrested at metaphase (Salmon and Sartorelli, 1989).

The taxoids, **paclitaxel** (commonly known as Taxol<sup>®</sup>) and the related semisynthetic **docetaxel**, are examples of novel new anticancer agents provided by plants. Paclitaxel is extracted from the bark of the Pacific yew (*Taxus brevifolia*), as well as needles and stems of other yews (*Taxus* spp.). Docetaxel is derived from a precursor, **baccatin III**, found in the needles of the English yew (*Taxus baccata* L.).

In contrast to the *Vinca* alkaloids, paclitaxel and docetaxel (Figure 11.4) induce assembly of microtubules and stabilize microtubule networks. Cells treated *in vitro* with paclitaxel form disorganized

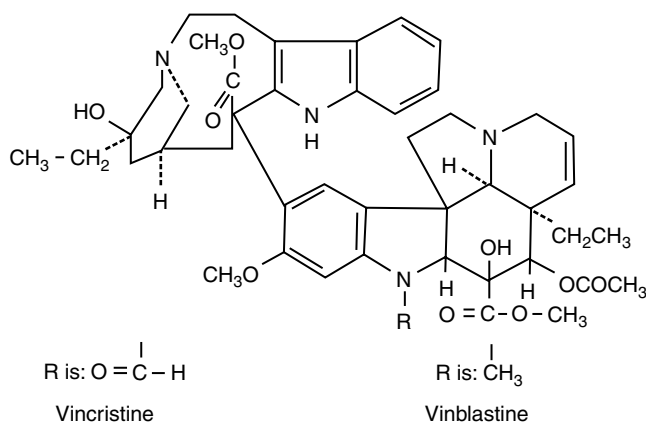

**FIGURE 11.3** Chemical structures of vincristine and vinblastine, two alkaloids from the medicinal plant, Madagascar pin, *Catharanthus roseus*.

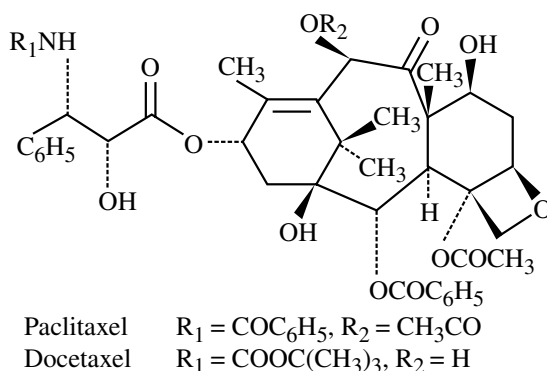

**FIGURE 11.4** Chemical structures of paclitaxel (Taxol®) and docetaxel, two taxoids from yews, *Taxus* spp., that are used for the treatment of ovarian and breast cancers.

bundles of microtubules in all phases of the cell cycle. During cell division, paclitaxel induces the formation of many abnormal spindle asters. Cells are either arrested in mitosis or in G or S phases. Docetaxel has twice the potency of paclitaxel in inducing microtubule polymerization. Treated cells accumulate in the mitotic phase of the cell cycle (Pazdur et al., 1993).

The taxoids are being used successfully in refractory ovarian cancer (Runowicz et al., 1993), breast cancer, and non-small-cell lung cancer. Their side-effect profile is largely predictable from the mechanism of action. Normal body cells with a high turnover or with processes dependent on microtubule formation, such as white blood cells, gastrointestinal mucosa, neurons, and secretory cells, are preferentially incapacitated to some degree by paclitaxel and docetaxel. These effects are generally reversible, and dose schedules were developed to maximize tumor response and minimize side effects. Overall cancer response rates vary from 30 to 70%. These taxane compounds are and will continue to be important anticancer agents, particularly if supply problems are solved (Rowinsky et al., 1990; Pazdur et al., 1993; Runowicz et al., 1993).

### 11.2.5 Homoharringtonine and Protein Synthesis

Chinese traditional medicine has been preserved, respected, and incorporated into the modern approach in that country. Many of the plants used in that system have potential anticancer efficacy. The bark of the Chinese evergreen, *Cephalotaxus harringtonia*, is used for several indications, including treatment of malignancy (Ohnuma and Holland, 1985). The alkaloids extracted from the seeds of this tree were

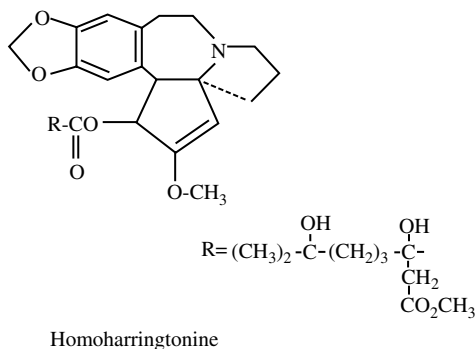

**FIGURE 11.5** Chemical structure of homoharringtonine, an anticancer drug obtained from the bark of Chinese evergreen, *Cephalotaxus harringtonia*.

tested in the National Cancer Institute (NCI) screening program of the 1960s and demonstrated cytotoxic activity. There are several related active substances, all of which are esters of the alkaloid, *cephalotaxine*.

**Homoharringtonine (HHT)** (Figure 11.5) is the most active of the alkaloids. Further testing in animal models confirmed its ability to prolong the life of animals bearing implanted tumors. HHT is now in phase II and phase III trials in humans for treatment of acute nonlymphoblastic leukemias and chronic myelogenous leukemia. The initial results are promising (Zhou et al., 1995).

HHT has its cytotoxic effects in the  $G_1$  and  $G_2$  phases of the cell cycle (Dwyer et al., 1986). These are the times of intense protein synthesis. **Protein synthesis** involves two major steps: **initiation** and **elongation**. During initiation, the messenger ribonucleic acid (mRNA), bearing the code for the new protein, associates itself with the ribosome. The first transfer RNA (tRNA) then attaches to the mRNA, bringing the initial amino acid building block for the protein. Elongation is the process by which subsequent tRNAs attach to the mRNA, and bonds are formed between the amino acids to produce the polypeptide protein. HHT inhibits the elongation step, most likely not from inhibiting the bonding of tRNA to mRNA, but by competitively inhibiting the enzyme, *peptidyl transferase*, which catalyzes the formation of the polypeptide bond (Zhou et al., 1995). There is evidence that HHT also disrupts protein synthesis in other ways, such as detaching ribosomes from endoplasmic reticulum, degrading ribosomes, inhibiting release of completed proteins from ribosomes, and inhibiting glycosylation of completed proteins (Zhou et al., 1995). Through these mechanisms, HHT may induce both apoptosis and differentiation of cancer cells, making it an important new anticancer agent.

### 11.2.6 Rhein and Necrosis

**Rhein** is an **anthraquinone** found in rhubarb (*Rheum* spp.) and other purgatives (Figure 11.6). Rhein is also **antineoplastic**. Several hypotheses exist as to the mechanism of action by which rhein exerts its antitumor effects. Studies show that it exerts an effect on the membrane level. In electron microscopic evaluation, rhein appears to distort and disrupt the membranes of mitochondria and cells. Membrane

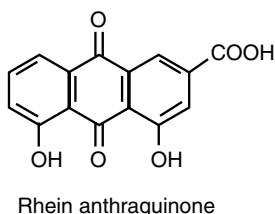

**FIGURE 11.6** Chemical structure of rhein anthraquinone, an anticancer drug found in rhubarb (*Rheum* spp.).

disruption appears to be mediated through altered **actin microfilaments**, which collapse into ring-like structures in the cell cytoplasm. In addition, the cristae of mitochondria are disrupted. This may lead to impairment of energy metabolism, variations in cellular permeability, and altered receptor molecule activity (Iosi et al., 1993). Others hypothesized that rhein alters the fluidity of membranes, and hence, the uptake of glucose (Castiglioni et al., 1993). The net result is decreased energy available for vital cellular functions and eventual cellular necrosis. Because of rhein's proposed mechanisms of action, it is a phytochemical that may warrant further examination as an antineoplastic agent.

### 11.2.7 Mistletoe and Apoptosis

Mistletoe, well known for its amorous seasonal effects, is also well known in Europe as an adjuvant cancer therapy. Aqueous extracts of *Viscum album* L. are used for their combined effect as immunostimulatory and cytotoxic agents. The polysaccharide portion of the extract is thought to be responsible for the immunostimulatory effects, much in the same manner as *Echinacea* polysaccharides (see Section 11.4.2). Some work has focused on the lectin portion of mistletoe extract. **Lectins** are proteins that cause agglutination of mammalian cells. Studies with tumor cell lines *in vitro* show that mistletoe lectins inhibit tumor growth. Further analysis indicates that the DNA in these cells is fragmented, as would be expected in apoptosis (Janssen et al., 1993). Other researchers found evidence of both membrane damage leading to necrosis and DNA damage indicative of apoptosis (Bussing et al., 1996). It may be that mistletoe extracts or purified mistletoe lectins will be validated with further studies as an effective means of treating some cancers.

### 11.2.8 Section Summary

In this section, we have seen how phytochemicals interact with various parts of the human cell life cycle (see Figure 11.7). These mechanisms can be employed to target rapidly proliferating tumor cells and induce differentiation, apoptosis, or necrosis. The *Vinca* alkaloids and the taxoids are currently used in mainstream cancer treatment. Homoharringtonine is in human trials to determine dosage schedules

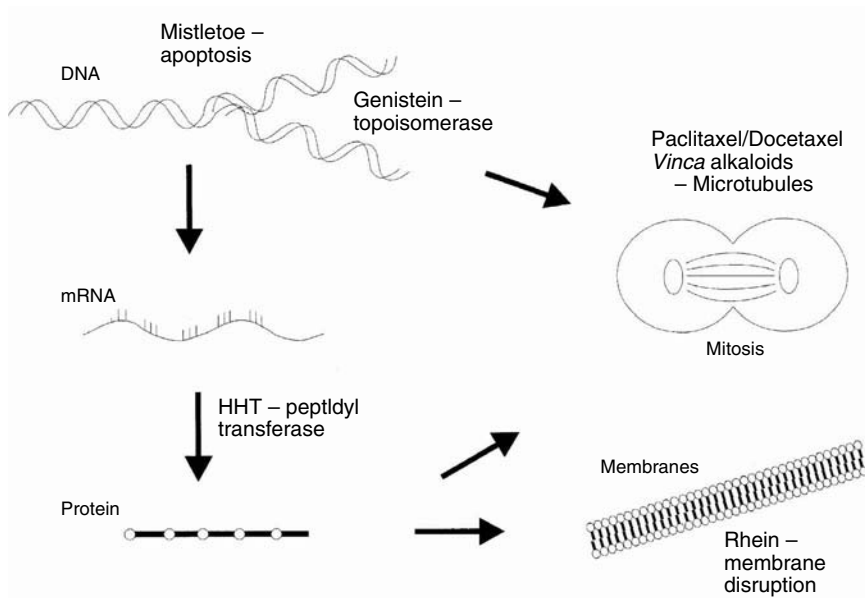

FIGURE 11.7 Anticancer mechanisms.

and effects on a broad population. Genistein, mistletoe, and rhein are promising in their mechanisms, but work remains to be done before they will be approved for use in the United States. Opportunities for research abound in these important applications of phytochemicals to the cancer epidemic of our current times.

---

## 11.3 Transmembrane Signaling

### 11.3.1 Opening Remarks

We examined ways in which plant molecules affect the synthetic capacity of cells and their ability to proliferate or complete their life cycles. Another important way that exogenous molecules interact with cells and their functions is by various types of **transmembrane signaling**. Two types of signaling, ligand-gated ion channels and G-protein/second messenger, are particularly relevant to the function of nerves and muscles. We will discuss these in detail and look at examples of how phytochemicals interact with them.

### 11.3.2 Ligand-Gated Ion Channels

Signaling of nerve cells and contraction of muscle cells are controlled in part by **ion channels**. Ion channels regulate the flow of sodium, potassium, and calcium across the cell membrane. Depending on the relative polarity on either side of the membrane, the cell will be resting, activated (depolarized), or in a recovering state (hyperpolarized) (Figure 11.8). Ion channel opening and closing can be regulated by purely electrical forces, as in the heart muscle. Cardiac cells depolarize and contract in unison via current flow at gap junctions along the membrane. Most ion channels, however, are opened or closed by the binding of chemicals — **ligands**. Binding causes conformational changes in the ion channel,

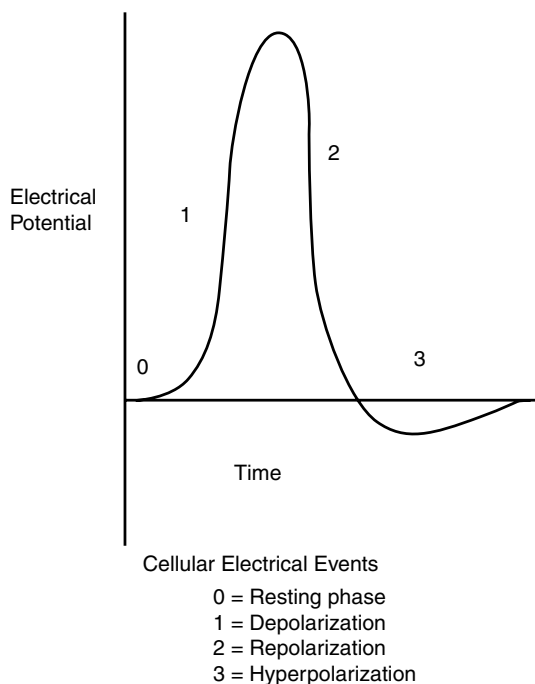

**FIGURE 11.8** Cellular electrical events. Depending on the polarity on either side of the membrane, the cell will be in one of the four phases.

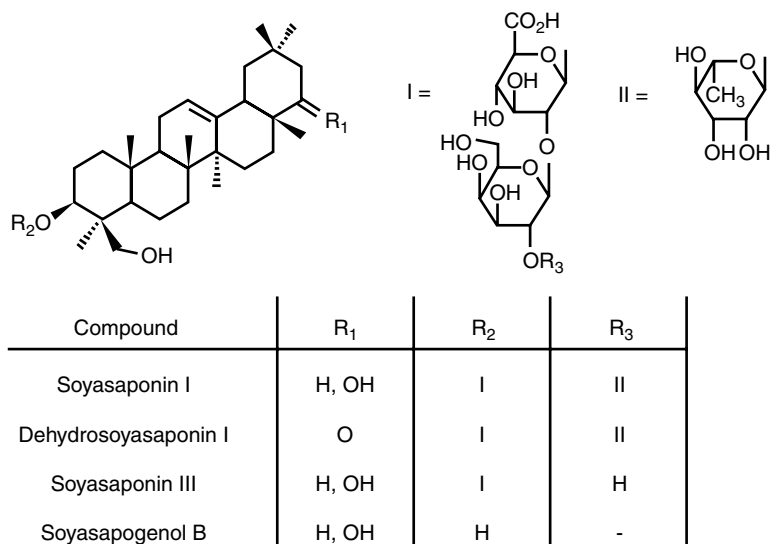

**FIGURE 11.9** Chemical structures of three triterpenoid glycosides from *Desmodium adscendens* from Ghana. These compounds modify the actions of ion channels.

allowing or inhibiting ion flow. As ions shift, the electrical potential across the membrane changes, and the cell depolarizes. Depending on cell type, depolarization results in neurotransmission or muscle contraction. A hallmark of this kind of interaction is the extremely rapid reaction induced. Phytochemicals have historically played an important role in elucidating the nature of ligand-gated ion channels. Nicotinic receptors at the neuromuscular junction on skeletal muscle are so named because the alkaloid, nicotine, causes depolarization of the muscle cells.

Plant-based medicines continue to have therapeutic value based on their ability to modify the actions of ion channels. In Ghana, *Desmodium adscendens* is used to treat asthma. The symptoms of asthma can be modified by inhibiting the contraction of smooth muscles lining the airways. *D. adscendens* extracts can inhibit contractions in guinea pig intestinal smooth muscle. Three triterpenoid glycosides (Figure 11.9) were isolated from *D. adscendens*. These glycosides increase the probability that **calcium-dependent potassium channels** of bovine tracheal smooth muscle will be open (McManus et al., 1993). If **potassium channels** are open, the cell will hyperpolarize. It is then much more difficult to depolarize the cell and cause contraction. The traditional use of this herbal medicine in treating asthma is validated by understanding its mechanism of inhibiting smooth muscle contraction.

### 11.3.3 G-Protein and Second Messengers

Transmembrane signaling via **G-proteins** and **second messengers** is far more complicated than **ligand-gated ion channel signals**, and therefore, has potential for many interactions with exogenous molecules. A G-protein sits within the membrane and is bound to **guanosine diphosphate (GDP)**. In this mechanism, ligand binding to the receptor causes a change in the G-protein. GDP is phosphorylated to GTP. This activates a cascade of enzymatic reactions that are the **second messengers**. Within this process, there is amplification of the signal. There are two different series of second-messenger reactions that can be stimulated. One is set in motion by the formation of cyclic adenosine monophosphate (cAMP), which activates **protein kinases**. These enzymes, in turn, catalyze the phosphorylation of regulatory enzymes. Cell processes are turned on or off based on the phosphorylation state of the regulatory enzymes. The other second-messenger reaction series begins with the formation of **inositol triphosphate**, which triggers release of intracellular stores of calcium ions. **Calcium**, in conjunction with **calmodulin**, activates or deactivates regulatory cellular enzymes. **Protein kinase C** is also activated and causes phosphorylation of other enzymes. No matter which second-messenger pathway is activated, the net



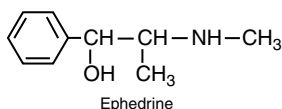

**FIGURE 11.10** Chemical structure of ephedrine from the stems of the plant, ma huang or *Ephedra sinica*. This acts to decongest the nose, relieving the symptoms of the common cold.

result is a change in the products or function of the affected cell based on the enzymes that are turned on or off. This produces the cellular response to the original message-bearing ligand. **Catacholamines**, of which there are many analogs found in natural products, act on the sympathetic nervous system effector organs through two basic types of receptors, alpha and beta. The  **$\alpha$ -receptor** reactions are mediated through the calcium/inositol system.  **$\beta$ -receptors** are connected to the **cAMP pathway**. The overall reaction of cells and organs to catacholamine stimulation will be based on the relative number and type of receptor on the individual cells.

Ma huang or ephedra (*Ephedra sinica* or *E. equisetina*) has been used for thousands of years in China. It is said to facilitate the circulation of lung Qi and control wheezing (Bensky and Foster, 1986). It is also used to promote sweating and urination. *Ephedra* spp. are often found in cold and flu remedies, “energy” formulas, and weight loss formulas (Leung and Foster, 1996). These myriad of effects might seem unreal until one realizes that all are related to stimulation of the sympathetic nervous system through  $\alpha$ - and  $\beta$ -receptors. Pharmacological studies done at the turn of the century isolated **ephedrine** (Figure 11.10) and **pseudoephedrine** from the stems of *E. sinica* (Olin, 1995a). Ephedrine directly stimulates  $\beta$ -receptors to dilate bronchioles in the lung, thus decreasing wheezing. Because of its lipid solubility, ephedrine crosses the blood–brain barrier and causes central nervous system stimulation and appetite suppression. Through indirect effects on other  $\beta$ -receptors, ephedrine and pseudoephedrine increase heart rate and the force of heart contractions. This leads to increased blood flow to the kidneys and increased urine formation. Actions on  $\alpha$ -receptors cause increased sweating and the constriction of blood vessels in the nasal mucosa. The latter effect decongests the nose, relieving the symptoms of the common cold. Over-the-counter cold preparations often contain pseudoephedrine for this purpose. All these helpful effects have made *Ephedra* spp. popular ingredients in modern herbal preparations. However, a plant with all these powerful effects may also cause harm. Heart attacks, seizures, psychotic episodes, and deaths have been associated with the use of ephedrine-containing herbal supplements. The U.S. Food and Drug Administration (FDA) has been considering the regulation of these products (Zwillich, 1996). Persons with heart problems and high blood pressure should be especially careful when using these supplements.

### 11.3.4 Section Summary

Phytochemicals can have potent effects when they stimulate cells through the body’s transmembrane signaling mechanisms. We have seen how *Desmodium* glycosides inhibit smooth-muscle contraction consistent with its traditional use in asthma. The ephedrine in ma huang has its multitude of actions mediated through G-proteins and second messengers. Another way phytochemicals can influence signal transmission is by increasing the signal, as for example, increasing neurotransmitters (see essay on St. John’s wort below). There are many forms of cell-to-cell communication in the body. Phytochemicals have an important place in the modulation of that communication.

---

#### Essay on St. John’s Wort: Increasing the Signal

St. John’s wort, *Hypericum perforatum*, has long been used in folk medicine. It is currently licensed in Germany for the treatment of anxiety, depression, and sleep disorders. One meta-analysis of 23 randomized trials with data from 1757 outpatients shows that St. John’s wort preparations are consistently superior to placebo for the relief of mild to moderately severe depression (Linde et al., 1996). Linde and Mulrow

(2003) indicated that alcoholic extracts of *H. perforatum* used in clinical trials produce a favorable side-effects profile. The exact mechanism of action of St. John's wort remains unclear; however, some excellent progress was made in understanding the mechanisms at the target site (see Section 11.6).

*H. perforatum* extracts showed efficacy mainly as a treatment for mild to moderate depression, possibly due to the presence of hyperforin (see Figure 2.27 in Chapter 2) and related phloroglucinol derivatives. Efforts led to the identification of hyperforin as an antidepressive component of therapeutically used alcoholic *Hypericum* extracts (Chatterjee et al., 1998). Moreover, new pharmacological and clinical results focused on hyperforin as the main active ingredient of the drug. Other hyperforin derivatives, including adhyperforin and furohyperforin — an oxygenated analogue also known as orthofoforin and furanoforin — are found in the lipophilic fraction of *Hypericum* extracts (Verotta et al., 2000). Rutin could also be essential for the antidepressant activity of *H. perforatum* extracts, and it was suggested that extracts designed for the treatment of depressive disorders should be manufactured from plant materials that contain sufficient amounts of rutin (Noldner and Schotz, 2002).

Crude extracts of *H. perforatum* also contain a number of other constituents with documented biological activity, including chlorogenic acid, a broad range of flavonoids, essential oil components, and xanthones.

The isolation and pharmacological activity of bisanthraquinone glycosides of *H. perforatum* were also reported (Wirz et al., 2000). In this connection, skyrin glycosides were reported for the first time from this plant. Moreover, these authors suggested that the isolated glycosides may contribute to the antidepressant effects of *H. perforatum* through an interaction with CRH-1 receptors (Wirz et al., 2000).

A number of observations confirm the view that, although the antidepressant action of *Hypericum* extracts depends mainly on hyperforin, the spectrum of primary activities may also be due to other related components or the relative mixtures of chemistries present in the dried herb. Possibly, there is some important synergistic action among the different compounds in this plant. In particular, the xanthones, tannins, hyperforins, and hypericins (see Figure 2.27 in Chapter 2) were implicated as contributors to the antidepressive activity of the herb (see review by Mennini and Gobbi, 2004).

Clinical data reviewed by Mennini and Gobbi (2004) indicate that hydroalcoholic extracts of *Hypericum perforatum* might be as valuable as conventional antidepressants for the treatment of mild to moderate depression, with fewer side effects than seen with other medications. One clinical trial using two extracts with different hyperforin contents indicated it to be the main active principle responsible for the antidepressant activity. Behavioral models in rodents confirmed the antidepressant-like effect of *Hypericum* extracts, and also, of pure hyperforin and hypericin. In a control component of the trial, a hydroalcoholic extract minus hyperforin lacked the antidepressant-like effect. According to pharmacokinetic data and binding studies, it now appears that the antidepressant effect of *Hypericum* extract is not likely to be due to an interaction of hypericin with central neurotransmitter receptors. The main *in vitro* effects of hyperforin (at concentrations of 0.1 to 1  $\mu\text{M}$ ) are nonspecific presynaptic effects. These result in nonselective inhibition of the uptake of many neurotransmitters, and the interaction with dopamine D1 and opioid receptors. Nevertheless, it is still not clear whether these mechanisms can be activated *in vivo* because after administration of *Hypericum* extract, brain concentrations of hyperforin are well below those that are active *in vitro*. In the rat, *Hypericum* extract might indirectly activate sigma receptors *in vivo* through the formation of an unknown metabolite or production of an endogenous ligand. This suggests a new target site for its antidepressant effects.

Therefore, decreased catabolism, decreased uptake, and decreased numbers of receptors result in a relative increase in the amount of neurotransmitter signals the receiving cell experiences. St. John's wort extract appears to have many potential

mechanisms that may, in fact, be acting synergistically to increase the neurotransmitter signal (see Chapter 13).

---

## 11.4 Immunomodulation

### 11.4.1 Opening Remarks

The mammalian immune system consists of many cells and signal molecules that act in concert to protect the organism from that which is “nonself.” The chief cellular effectors are **macrophages** (“big eaters”) and white blood cells. **Neutrophils** and **lymphocytes** are the most important of the white blood cells. Some of the signal molecules are **interleukin-1 (IL-1)**, **tumor necrosis factor- $\alpha$  (TNF- $\alpha$ )**, and  **$\gamma$ -interferon (IF- $\gamma$ )** also known as **IL-6**. Cells that come in contact with foreign organisms begin to secrete signal molecules to call other effector cells into the area and to activate them. The invaders are immobilized or killed by numerous strategies, including **phagocytosis**, **antibody production**, and **reactive oxygen species (ROS)** production. There is increased blood flow, and the area becomes swollen, red, warm, and painful. The next section will first examine two plants, *Echinacea* and *Aloe vera*, that may act to boost the response of the immune system in fighting disease. Then, we will discuss how plants stimulate the immune system in ways that cause the organism discomfort (i.e., allergic or hypersensitivity reactions).

### 11.4.2 Echinacea

*Echinacea* has long been known in the Native American materia medica (Gilmore, 1919). It was also known in Europe for its immune-stimulating effects and skin-repairing properties as early as 1831 (Dierbach, 1988). Today, *Echinacea* products are widely used in Europe as an aid to boost the immune system in its struggle with the viruses that cause colds and flu. Clinical trials in Germany supported this usage (Foster, 1995). In addition, research with extracts of *Echinacea* have begun to elucidate the interactions between this botanical and the mammalian immune system. Initially, **echinacoside**, a caffeic-acid glycoside that showed weak antibacterial activity, was thought to be the active ingredient. Further work showed that this was not the case (Foster, 1995). In a series of elegant experiments spanning more than a decade, M.L. Lohmann-Matthes, H. Wagner, and colleagues steadfastly expanded our knowledge of how *Echinacea* works (Stimpel et al., 1984; Leuttig et al., 1989; Roesler et al., 1991a, 1991b; Steinmuller et al., 1993). Early on, this group pinpointed polysaccharides from the aqueous extracts of *E. purpurea* as the active fraction. Further work showed that the effective polysaccharides were cell-wall-derived **arabinogalactan** and two **fucogalactoxyloglucans**. They developed a plant-cell-culture system with a supernatant that provided them with a solution of the polysaccharides that could be standardized. Then, they applied this purified extract in a host of carefully executed experiments. They showed that this polysaccharide fraction stimulates macrophages to produce signal molecules, **TNF- $\alpha$** , **IL-1**, and **IL-6 (interferon)**. These signals activate other parts of the immune system and promote the migration of other effector cells, such as neutrophils, from the bone marrow to the blood. The activated macrophages produce more ROS, phagocytize more, and are more cytotoxic to tumor cells. Overall, there is a higher rate of killing of *Listeria monocytogenes* bacteria and *Candida albicans* yeast, such that a lethal dose of either can be withstood by both immunocompetent and immunosuppressed mice that were treated with the polysaccharides. Similar results were obtained in humans. Although the polysaccharides stimulate the immune system, much as an invading organism would, they are completely nontoxic. Another group conducted preliminary work using *E. purpurea* extracts in combination with cyclophosphamide and thymostimulin to stimulate the immune system of patients with hepatocellular and advanced colorectal cancer. Their results are encouraging (Lersch et al., 1990, 1992).

These experiments give new credence to the herbalists' claims of the immune-enhancing effects of *Echinacea* spp. Soon, it may be an integral part of accepted therapy for withstanding cancer and other infectious diseases.

### 11.4.3 *Aloe vera*

Humans have used the aloe plant since the ancient times of Egypt and Greece for skin infections and wound healing (Shelton, 1991). The leaf contains three medically important and distinct parts: the leaf exudate, the leaf epidermis, and the leaf pulp. Much of the medical literature on aloe use is confusing because the part and formulation used are not specified clearly. This may account for the often widely divergent results obtained. While researchers divide and extract these different parts to find the active ingredients, many others advocate for studying the use of whole leaf preparations, because that is the way it has been used throughout history. The leaf exudate, a bitter yellow liquid, is produced by pericyclic cells (Klein and Penneys, 1988). This can be heated, concentrated, and dried to a black powder. This is the source of **drug aloes**, also known as **Cape Aloes USP**, which is used as a purgative (Grindlay and Reynolds, 1986). *Aloe ferox* is grown commercially for this purpose. Of the dried exudate, 70 to 97% is made up of **aloeresin**, **aloesin**, and **aloin** in a ratio of 4:3:2 (van Wyk et al., 1995). The exudate also contains **aloe-emodin** and **anthraquinone**, which is a gastrointestinal irritant, hence the purgative effects (Klien and Penneys, 1988). Some studies centered on a lectin purified from the leaf epidermis of *Aloe arborescens* Miller (Koike et al., 1995b). An **aloe lectin** was reported to inhibit the growth of a fibrosarcoma in mice through a host-mediated effect (Imanishi et al., 1981). A possible mechanism may be activation of the immune system, as purified aloe lectin was shown to increase mitogenic activity in mouse lymphocytes (Koike et al., 1995a). This will undoubtedly be an area for further research. The aloe leaf pulp or gel is a clear mucilaginous substance that is 98.5% water (Rowe and Parks, 1941). The mucilage is predominantly made up of polysaccharides that are partially **acetylated glucomannans** (Gowda et al., 1979). For example, an acetylated mannan, **acemannan**, extracted from *Aloe vera*, was shown to have immune-system modulating effects. This appears to be mediated through macrophages that synthesize and release **nitric oxide**, **IL-1**, and **TNF- $\alpha$**  when activated by acemannan (Peng et al., 1991; Karaca et al., 1995). The activated macrophages and other immune cells are then able to respond to viral or cancer cells. These products of aloe plants will be studied more thoroughly in the future.

The whole leaf of *Aloe vera*, or products extracted from the whole leaf, have been used directly on radiation burns, thermal burns, partial thickness wounds, stasis ulcers, and diabetic ulcers. Most researchers report an initial increase in necrosis, and then more rapid healing, when compared with other treatments or no treatment (Shelton, 1991; Klein and Penneys, 1988; Grindlay and Reynolds, 1986). This may be a reflection of the above-identified immune-modulating effects. *Aloe vera* has enjoyed a great popularity in household remedies and cosmetics. Research is just beginning to unravel the reasons why this botanical has been highly regarded by healers and the healed alike.

### 11.4.4 Plant Contact Dermatitis

There are several different ways in which plants can affect the skin of humans — some beneficial and some causing discomfort. Many plants, like *Aloe vera*, promote the healing of wounds. Other plants, such as poison ivy (*Toxicodendron* spp.), are well known for their toxicity to the skin. **Plant contact dermatitis** is subdivided based on causative mechanisms. One such division is (1) irritant contact, (2) immediate contact, (3) phytophotosensitivity, and (4) allergic contact (Juckett, 1996; Epstein, 1987). As more is learned about these mechanisms, it is clear that there is some overlap. The divisions are useful, however, in determining appropriate treatment. In each of the following sections, we will define and describe the clinical picture of each type of dermatitis. Each will be illustrated with one or two examples, along with more detail about the mechanism of interaction, when known.

**Irritant contact dermatitis** occurs when humans encounter thorns, spines, irritant hairs, and chemical substances that primarily protect plants from herbivores. In the human, these plant defenses usually cause some kind of persistent skin reaction that may be due to physical trauma or chemical interaction with skin or nerves (Southcott and Haegi, 1992). Stinging nettles, *Urtica dioica* and *U. urens*, are commonly known for the intense burning and stinging that begins just a few minutes after brushing up against the plant. The skin turns red and warm and itchy. There may be persistent itching or tingling for about 12 h. These *Urtica* spp. have glandular hairs that inject four chemicals into the skin, namely, **histamine**,

**acetylcholine**, **serotonin**, and a fourth unidentified compound. Histamine causes immediate vasodilatation and edema, producing redness and swelling. Serotonin is responsible for the pain and itch (Oliver et al., 1995). Another irritant contact dermatitis is caused by capsaicin, an alkaloid in red peppers, chili peppers, and paprika of the genus *Capsicum*. It produces redness and intense burning. **Capsaicin** stimulates a specific receptor on **cutaneous sensory neurons** that, in turn, probably increases intracellular calcium ions. This causes massive release of neuropeptides, including substance P. These molecules are responsible for both pain signal transmission to the brain via depolarization of unmyelinated type C and thin myelinated A delta sensory neurons and modulation of the local inflammatory response. Repeated application depletes the **neuropeptides**, and therefore, pain signals can no longer be transmitted. This is the basis for the use of capsaicin in products used to treat diabetic neuropathy, postherpetic neuralgia, and arthritis (Williams et al., 1995; Girolomoni and Tigelaar, 1990).

**Immediate contact dermatitis** occurs when skin previously sensitized is reexposed to the offending agent. In some people, strawberries, kiwifruit, tomato, castor bean, and others trigger a type I hypersensitivity response typified by redness, swelling, and itching (Juckett, 1996). On first exposure, the plant antigens stimulate **B lymphocytes** to produce **immunoglobulin E (IgE)** antibodies that then bind mast cells. No reaction is apparent. At the second exposure, when antigen cross-links the antibodies on the mast cell, there is an influx of calcium ions into the cell. This causes release of preformed mediators, such as **histamine**, **heparin**, enzymes, and chemotactic and activating factors, and stimulates the formation of longer-acting mediators, such as **prostaglandins** and **leukotrienes**. These mediators, among other things, cause vessels to dilate and leak fluids and recruit other blood cells to the area causing the observed skin reactions (Roitt et al., 1985).

A third type of dermatitis associated with plants is **phytophotodermatitis**. This occurs when there is direct or airborne contact or ingestion of plant **furocoumarins** and then exposure to sunlight. The result is a painful, red, itchy rash with watery blister formation that lasts 1 to 2 weeks. **Hyperpigmentation** follows, which can last for months. This type of reaction can be caused by rue (*Ruta* spp.), gas plant (*Dictamnus albus*), citruses (*Citrus* spp.), *Apiaceae* (angelica, parsley, parsnip), and others (Juckett, 1996). The best studied of the furocoumarins are **psoralens**. They cross-link DNA in the cells, and when exposed to ultraviolet (UV) light, cause cell death, inhibit normal mitosis, or cause mutations. Dermatologists use ingested psoralens (Figure 11.11) and UV-A light in the treatment of psoriasis (Epstein, 1987).

The most well-known plant–skin interaction in North America is that caused by poison ivy, poison oak, and poison sumac (*Toxicodendron* spp.). These plants cause **allergic contact dermatitis** typified by red, itchy skin with weeping blisters, scabs, and crusts, that peaks about 48 h after exposure. Affected areas may appear in a linear distribution because of the mechanism of contact or early scratching. The lesions may erupt over 3 weeks, which is the time it takes the plant resin to evaporate. It is not spread through leakage of the blisters. Delayed eruption is due to reexposure from resin on clothes, tools, or pet fur. There is usually no long-term scarring or hyperpigmentation (Quick, 1995). Similar type IV or delayed-hypersensitivity reactions can be caused by sesquiterpene lactones in the Asteraceae (thistle) family and quinones in toxic woods (Juckett, 1996; Woods and Calnan, 1976). In the *Toxicodendron* spp., the allergen is **urushiol**, a catechol nucleus with a 15-carbon lipophilic tail containing two to three unsaturated bonds. Urushiol binds to epidermal cells (keratinocytes, Langerhans cells, and endothelial cells), stimulating the release of mediators (ICAM-1, ELAM-1, VCAM-1) that form adhesive networks and promote migration (via IL-8) of T cell lymphocytes to the area. Pathology is then T cell-mediated

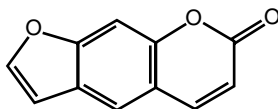

Psoralen

**FIGURE 11.11** Chemical structure of psoralen, which is used in combination with ultraviolet light for the treatment of psoriasis.

through lymphokine production, antigen-specific and nonspecific cytotoxicity, and recruitment of other effector cells (Griffiths et al., 1991; Kalish, 1990).

### 11.4.5 Section Summary

We have seen how plant and human interactions can have significant immunomodulatory effects. In the case of *Echinacea* and *Aloe*, plant polysaccharides stimulate the immune system in a beneficial way, promoting healing and increased defensive capacity. When human and plant defense systems clash, the interaction can leave humans with painful, red, swollen, itchy, and blistered skin through a variety of mechanisms. Sometimes, these very mechanisms can be used to lessen symptoms of other diseases, like psoriasis and neuropathy.

---

## 11.5 Toxic Effects

### 11.5.1 Opening Remarks

The last section on plant contact dermatitis serves as a good bridge to this portion on the harmful effects of plants. We already saw that plants have powerful potential in their interactions with humans. This can benefit or harm. Some significant aspects of the negative interactions will be covered with respect to congenital anomalies (teratogenesis), carcinogenesis, and toxicity.

### 11.5.2 Teratogenesis

**Teratogenesis** (literally “monster formation”) occurs when cell proliferation, cell migration, or cell differentiation in a developing human embryo is altered. Human embryos are most vulnerable to the effects of teratogens during the third through the ninth week of pregnancy, during a time when women may not be aware they are pregnant. About one quarter of all birth defects are genetic aberrations, and 65 to 70% are from unknown causes. Drugs and chemicals account for only about 1% of birth defects (Cotran et al., 1989). There are several plant-derived compounds that are known **teratogens**, notably, some alkaloids from angiosperms (flowering plants), such as colchicine, reserpine, tubocurarine, caffeine, nicotine, and quinine (Lewis and Elvin-Lewis, 1977a).

**Ethyl alcohol** derived from fermentation of grapes or grains is a commonly ingested plant product with recognized teratogenic effects. Fetal alcohol syndrome is diagnosed by its constellation of growth retardation, microcephaly, atrial septal defects, short palpebral fissures, maxillary hypoplasia, and other minor anomalies. The mechanism behind these effects is multifactorial. Fetal hypoxia and nutrient deficiencies may be involved. At the cellular level, enzyme activities, cell division, and maintenance of membrane integrity are altered by exposure to ethanol (Zajac and Abel, 1992).

In general, it is very difficult to establish causality in a situation where multiple factors may play a role. The high proportion of unknown causes of birth defects indicates that much of what we are exposed to may be less benign than we think. Accordingly, most drugs should be avoided in pregnancy, including plant-based remedies and beverages, unless the benefit to be obtained far outweighs the often unknown risk to the developing offspring.

### 11.5.3 Carcinogenesis

In Section 11.2, we discussed various phytochemicals and their roles in treating cancer. Natural products or their metabolites can also be implicated in causing cancer, although far more synthetic chemicals are known culprits at this time. Viruses and irradiation are also responsible for much neoplastic transformation. **Chemical carcinogenesis** is proposed to occur via a two-step process of initiation and promotion. **Initiation** is accomplished when damaged DNA is passed on to daughter cells unrepaired. Particular portions of DNA known as **proto-oncogenes** may be transformed through mutation to become active

**oncogenes.** Other genes known as tumor suppresser genes may be inhibited. These genes would normally control cell growth and differentiation. Once damaged, the stage is set for uncontrolled proliferation. This will not occur, however, unless there is a second type of stimulus called **promotion**. One well-studied promoter exerts its action through multiple effects, including activation of **protein kinase C**. This, in turn, causes a host of protein phosphorylations that regulate multiple cellular functions, including membrane receptor, ion channel, and enzymatic activity. The result is altered proliferation and differentiation and neoplasia (Cotran et al., 1989a; Boik, 1996).

The most well-known plant carcinogen is tobacco, the leaf of *Nicotiana tabacum*. It contains many compounds that may be volatilized during burning. More importantly, several aromatic hydrocarbons are known to be formed during combustion. Wherever these are applied experimentally, they cause local cancer formation. They are metabolized to **dihydrodiol epoxides**, which are strong electrophilic reactants. They exert their cancer-initiating effects by combining with nucleophilic sites on DNA, RNA, and proteins. Tobacco aromatic hydrocarbons may be complete carcinogenic agents in that they are sufficient to cause tumors without a promoter. On the other hand, tobacco acts synergistically with betel nut juice (*Areca catechu*) chewed in south Asia. The betel nut alone causes tumors in 38% of hamster cheek pouches, but when combined with tobacco, the number rises to 78%. In this study, tobacco alone did not induce malignancy; however, it caused **leukoplakia**, which may enhance susceptibility to cancer (Cotran et al., 1989b; Lewis and Elvin-Lewis, 1977b).

#### 11.5.4 Toxicity

Many plant-based medicines and herbal remedies have side effects, as do prescribed synthetic medicines. Gastrointestinal effects, such as nausea and diarrhea, and skin reactions are common to many ingested products. There are a few plant-based products with well-known toxicities to the liver and the central nervous system. The next section will explore the mechanism of toxicity of comfrey root and jimson weed seed.

Comfrey (*Symphytum officinale*) has been used for the treatment of stomach ulcers and as a blood purifier, among other things. The roots are the part most often used. They contain **pyrrolizidine alkaloids** (Figure 11.12) that can cause liver toxicity, as well as carcinogenesis and teratogenesis. These alkaloids have a 1,2 double bond and esterified hydroxyl methyl groups (see Figure 11.12). In the liver, they are dehydrogenated to pyrrole derivatives, which then act as potent alkylating agents. They react with bases in the DNA strand, cross-linking strands and causing strand breakage. Studies in rats supported the hepatotoxic, carcinogenic, and teratogenic role of comfrey root (Bisset, 1994). In humans, a form of Budd-Chiari syndrome, known as **veno-occlusive disease**, has been the primary concern. Clinical

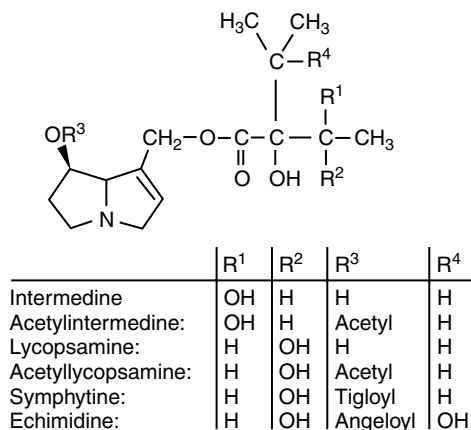

**FIGURE 11.12** Chemical structures of pyrrolizidine alkaloids, which can cause liver toxicity as well as carcinogenesis and teratogenesis.

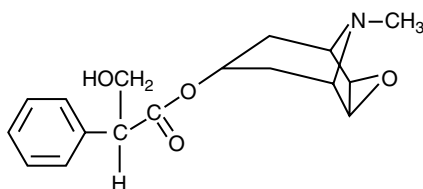

FIGURE 11.13 Chemical structures of scopolamine, a drug that is neurotoxic to humans and other animals.

manifestations are hepatomegaly and refractory ascites, often progressing to hepatic failure. Untreated, there is a high mortality rate. Pathologically, the liver shows tissue necrosis in the center of lobules, as well as dilation of the central vein. The small venules of the liver have fibrous deposition in and around them, which leads to obstruction of blood outflow and the resultant ascites. Many cases were reported in the world literature, attributable to *Symphytum* as well as pyrrolizidine alkaloid-containing species of *Heliotropium*, *Senecio*, or *Crotalaria* (McDermott and Ridker, 1990; Olin, 1995b). Internal consumption of comfrey is officially banned or discouraged in Australia, New Zealand, the United Kingdom, and Germany (Bisset, 1994).

**Neurotoxicity** is another common result of ingestion of plant products. In Section 11.3, we discussed the interaction of phytochemicals in various cellular membrane signaling mechanisms. Neurotoxicity can occur when the plant molecule acts as a blocker to neurotransmission. Jimson weed (*Datura stramonium*) has been used as a tea for the treatment of asthma. The atropine-like substances, **hyoscyamine** and **scopolamine** (Figure 11.13), are in all portions of the plant. They act to block neurotransmission by **acetylcholine**, which is the predominant neurotransmitter of the parasympathetic nervous system. The signs and symptoms of *Datura* toxicity pervade many organ systems. These include dry mouth, dry skin, blurred vision, disorientation, excitability, aggressiveness, tachycardia, tachypnea, and hyperpyrexia. Death can occur from cardiac arrest (Combs, 1997).

### 11.5.5 Section Summary

In this section, we discussed some of the problems associated with ingestion of certain toxic, teratogenic, and carcinogenic plant products. Medical literature often focuses on these negative effects alone. As we discovered in other portions of the chapter, plants can have a host of salutary effects as well. While usage of plants medicinally may be steeped in tradition, scientific investigation often uncovers the mechanisms by which phytochemicals interact with the human body. However, this area of investigation sometimes offers more questions than answers due to its complexity. There is a growing need for well-trained and thoughtful ethnobotanists, basic scientists, and clinicians to carry forward the work of understanding how best to join with the plants to create good health.

---

## 11.6 Molecular Mechanisms at Target Sites

### 11.6.1 Opening Remarks

So far, in this chapter, we explored the types of effects that natural products can have at the cellular and organismal levels. The examples that we provided have given researchers vital information about the good and bad impacts of many plant compounds on human health. However, the primary focus of natural product research has been changing over the years (see Chapters 5 and 6). Currently, much more intent is placed on elucidating the chemical and molecular mechanisms that govern the activity of a particular compound within an organism. In this section, we give a few examples of cases where progress has been made in uncovering the molecular mechanisms at work at specific target sites. With these examples in hand, we hope the reader will be better equipped to search for information on other molecular processes of interest.



### 11.6.2 Effects of Plant Natural Products on Human Cytochrome P450 Enzymes

Most **xenobiotics**, or exogenously derived chemicals, undergo chemical modifications in the body before they can be effectively eliminated. **Biotransformation** is the process by which usually lipophilic drugs are rendered more hydrophilic, and hence, more easily excreted. The metabolic conversion of drugs is generally enzymatic in nature. The cytochrome P450 (CYP450) enzyme family is the major catalyst of phase I drug biotransformation reactions. CYP450 enzymes play key roles in steroid hormone biosynthesis (Chen et al., 1993), the activation and detoxification of many drugs, the metabolism of polyunsaturated fatty acids (Jump et al., 1999), the activation of vitamins A and D<sub>3</sub> to biologically active hormones (Wikvall, 2001), the synthesis of many secondary metabolites in plants, and the metabolism of toxic (Stresser et al., 1994) and carcinogenic agents (Williams et al., 1998; Huang et al., 1999; Zhou et al., 2004). CYP enzymes are bound to the endoplasmic reticulum and are predominantly expressed in the liver, although they are also present in extrahepatic tissue such as the intestinal mucosa. In humans, 16 gene families and 29 subfamilies were identified to date. CYP3A4 is the most abundantly expressed isoform and represents 30 to 40% of the total CYP protein in the human adult liver (Donato and Castell, 2003). In the gut, CYP3A isoforms represent approximately 70% of total CYP protein. The enzymes most commonly involved in xenobiotic metabolism are CYP3A4, CYP2D6, and CYP1A2.

Many natural product constituents impact the activity of CYP450 enzymes, either by **induction**, **inhibition**, or both. The regulation of CYP enzymes by herbal products is complex and depends on the herb type, relative concentration of the active constituents, administration dose and route, target organ, and species. Prediction of herb–drug interactions is difficult, due partly to the challenging identification of the responsible constituent(s) for CYP enzyme impact. In addition, the available data cannot be directly translated to humans; *in vitro* and *in vivo* studies in other species may have limited applicability due to interspecies differences in CYP isoform distribution. Herbal product use is increasing globally; thus, more people are using botanical preparations that contain multiple, potential CYP modifiers. Botanical–CYP interactions have clinical significance, because they have an impact on the half-life and efficacy of prescribed medications. Therefore, a detailed understanding of this interaction *in vivo* is imperative in order to assess the safety of medicinal plants as part of an integrative clinical approach (Brazier and Levine, 2003; Butterweck et al., 2004; Strandell et al., 2004). Limited studies have been conducted in humans to explore botanical–CYP interactions, although these studies should clearly be research priority in order to enhance and protect public health (Zhou et al., 2004).

The majority of studies of botanical–CYP interaction are conducted *in vitro*, using isolated liver sections, primary isolated liver cells, or isolated liver microsomes. Fewer studies are conducted *in vivo*; those experiments are primarily conducted in rodent models. Botanicals or botanical constituents known to inhibit CYP *in vitro* and *in vivo* in rodent models are many and varied. Examples include *Echinacea purpurea* (purple cone flower) (Gorski et al., 2004), *Valeriana*, *Hypericum* (St. John's wort), piperine (Kang et al., 1994; Koul et al., 2000; Bhardwaj et al., 2002), garlic (Foster et al., 2001), naringenin (Ho, Saville, and Wanwimolruk, 2001), several triterpenoids (Pass and McLean, 2002), and several flavonoids (Nielsen et al., 1998; Breinholt et al., 1999; Doostdar et al., 2000; Breinholt et al., 2002; Huynh and Teel, 2002). Inhibition can be mediated by competitive, noncompetitive, or mechanism-based interactions. **Competitive inhibition** may occur between an herbal constituent and a drug, as both are often metabolized by the same CYP isoform. For example, diallyl sulfide from garlic is a competitive inhibitor of CYP2E1 (Loizou and Cocker, 2001). This interaction may provide an explanation for garlics' chemopreventive effects, as many mutagens require activation by CYP2E1. **Noncompetitive inhibition** is caused by the binding of herbal constituents containing electrophilic groups to the heme portion of CYP. **Mechanism-based inhibition** of CYP is due to the formation of a physical complex between an herbal metabolite and a CYP enzyme, altering CYP activity by limiting its interaction with and effect on alternative substrates.

CYP enzyme induction by botanicals *in vitro* and *in vivo* in rodent models is less commonly observed than CYP enzyme inhibition. Examples of botanicals and botanical constituents that enhance CYP activity include *Hypericum* (St. John's wort) (Moore et al., 2000; Obach, 2000; Komoroski et al., 2004), licorice (*Glycyrrhiza*) (Budzinski et al., 2000), anthraquinone emodin (Wang et al., 2001), and

constituents of ginseng (Kuong et al., 1991; Chang et al., 2002; Lee et al., 2002; Wang et al., 2004; Yu et al., 2005). Again, many constituents of a parent botanical have mixed effects on CYP, depending on the model employed and the dose administered. Like inhibitory associations, CYP induction by herbals also bears clinical significance. Induction of CYP3A4 by St. John's wort may explain the enhanced plasma clearance of a number of drugs, such as cyclosporine, the anti-HIV drug indinavir (Hennessy et al., 2002), and the antiplatelet drug clopidogrel (Lau et al., 2004), which are known substrates of CYP3A4.

Human *in vivo* studies employ synthetic probe CYP substrates and inhibitors to test the botanical effect on CYP activity. Examples of selective probes used in these studies include caffeine for CYP1A2 (Carrillo et al., 2000), tolbutamide for CYP2C9 (Bourrie et al., 1996), mephenytoin for CYP2C19 (Streetman et al., 2000), dextromethorphan for CYP2D6 (Wieling et al., 2000), chlorzoxazone for CYP2E1 (Lucas et al., 1999), and midazolam or erythromycin for CYP3A4 (Rivory et al., 2001). A cocktail of these selective probes can then be used to assess the activity of multiple isoforms simultaneously (Wang et al., 2001; Zhu et al., 2001). Although limited in number, human studies revealed important botanical–drug interactions. Human studies using a probe cocktail indicated that long-term (2 weeks) St. John's wort administration significantly induced intestinal and hepatic CYP3A4 but did not alter CYP2C9, CYP1A2, or CYP2D6 activities (Roby et al., 2000; Wang et al., 2001). Short-term administration had no effect on CYP3A4 activity (Wang et al., 2001). Acute oral administration of garlic oil extract and diallyl sulfide caused an insignificant decrease in CYP2E1 activity using chlorzoxazone as the substrate probe in healthy human volunteers (Loizou and Cocker, 2001), though the effect of prolonged administration was not studied. Garlic is an example of a botanical that can have mixed effects on CYP activity, depending on the prominent constituent, dosing regimen, animal species and tissue studied, and even the source of the garlic.

### 11.6.3 Interactions of Plant Natural Products with Nuclear Receptors That Regulate CYP450 Activity

In addition to directly affecting CYP activity through constituent–enzyme interaction, certain botanical constituents directly affect the cell's population of CYP450 enzymes by interacting with upstream **nuclear hormone receptors** that have an impact on gene transcription. An example of this type of regulation is the interaction between the St. John's wort constituent, hyperforin, and the pregnane X receptor (PXR). PXR is an orphan nuclear receptor and a highly promiscuous molecule that binds to diverse drugs and toxins. Examples include the antibiotic drug rifampicin, the anticancer drug paclitaxel (Taxol®), and the abortifacient drug RU-486 (Lehmann et al., 1998; Forman, 2001; Honkakoski et al., 2003). Upon activation, PXR binds to DNA and regulates a large array of genes in the liver and intestine that participate in the metabolism and excretion of potentially harmful xenobiotics, including genes encoding phase I, II, and III enzymes. The St. John's wort constituent, hyperforin, binds to the ligand binding domain of PXR. PXR then binds to the CYP3A4 promoter region and induces CYP3A4 transcription. St. John's wort induced CYP3A4 transcription and translation were identified in both *in vitro* (Moore et al., 2000; Foster et al., 2003; Komoroski et al., 2004; Strandell et al., 2004) and *in vivo* (Wang et al., 2001; Markowitz et al., 2003). Consequences of this interaction include enhanced CYP-mediated pathways, impacting drug activation, deactivation, and plasma half-life.

### 11.6.4 Photodynamic Therapy (PDT) and the Anticancer Action of Hypericin in St. John's Wort (*Hypericum perforatum*)

**Photodynamic therapy** (PDT) refers to the use of low-energy visible and near-infrared (IR) light to treat various pathological conditions, including wound healing, nerve regeneration (Lubart et al., 2005), and several types of cancer (Dolmans et al., 2003). It has been variously termed “photobio-stimulation” (Lubart et al., 2003), “phototherapy” (Smith, 2005), and “photodynamic therapy” (Dolmans et al., 2003, and references cited therein). For the purposes of this discussion, we will use the term “PDT.”

As applied to the treatment of cancer, PDT involves saturation of cancer tissue with **photosensitizing agents** (light-receptor molecules) and their activation by light irradiation (500 to 800 nm). In PDT for cancer treatment, the photosensitizing agent is injected into the bloodstream, where it then becomes absorbed by cells all over the body. After 24 to 72 h, when most of the photosensitizer has left normal cells, PDT remains in the cancer cells (Dolmans et al., 2003; Wilson, 2002; Dickson et al., 2003). One good example of a photosensitizing agent is **hypericin** (HYP) (see Figure 11.11) from St. John's wort (*Hypericum perforatum*). It accumulates in tumors to a significantly greater extent than in normal, noncancerous tissues (Lavie et al., 1998). It was demonstrated experimentally that irradiation of hypericin-treated mice led to tumor growth inhibition (Vandebogaerde et al., 1996). Similar results were obtained in human tumor cell lines, where HYP was taken up by the tumor cells, making them more vulnerable to the killing effects of light (Vanderwerf et al., 1996).

Most photosensitizers are **porphyrin derivatives**, such as hematoporphyrin or chlorins. The latter has a porphyrin ring in which one of the exo-pyrrole double bonds is hydrogenated; this structure results in intense absorption of wavelengths greater than 650 nm. When the photosensitizer absorbs a photon of red light that is delivered to the target tissue by means of laser light via **fiber optic cables** or with **light-emitting diodes (LEDs)**, the porphyrin molecule enters an excited state called the triplet state. The triplet state photosensitizer can then react with biomolecules by means of two different reactions. The type I reaction involves electron/hydrogen transfer directly from the photosensitizer, producing ions or electron/hydrogen abstraction with a substrate biomolecule to form free radicals. These free radicals then react rapidly, usually with oxygen, to form highly **reactive oxygen species (ROS)**, such as superoxide and peroxide ions, which attack cellular targets such as cancer cells. The type II reaction produces an electronically excited and highly reactive state of oxygen called singlet oxygen, which may be converted to the triplet state; or by the emission of a photon, it will return to the ground state.

The cellular targets of the ROS (e.g., singlet oxygen) include amino acids (particularly cysteine, histidine, tryptophan, tyrosine, and methionine), nucleosides (mainly guanine), and unsaturated lipids in mitochondria and nuclei. In mitochondria, PDT causes the uncoupling of respiration and oxidative phosphorylation, resulting in impairment of ATP synthesis and loss of cellular function. In nuclei, PDT was shown to cause single/double-stranded breaks and formation of alkali-labile sites in DNA, as well as induction of sister chromatid exchanges and chromosomal aberrations. PDT, in addition to killing cancer cells, appears to shrink or destroy tumors in two other ways: the photosensitizer can damage blood vessels in the tumor, thereby preventing the tumor from receiving necessary nutrients, and it may activate the immune system to attack tumor cells.

### 11.6.5 Section Summary

In this section, we explored some of the molecular mechanisms that influence the action of plant compounds at just a few target sites within the body. Our examples include (1) how specific enzymes, such as cytochrome P450 enzymes, can chemically alter drugs once they enter the body, and how these enzymes are controlled by additional induction and inhibition mechanisms; (2) how natural products can interact with receptor proteins to trigger specific responses that govern downstream gene and enzyme activity; and (3) how some plant compounds can be affected by environmental “stimulants,” such as light, to change the activity within the body at a molecular level. These are some of the “hot topics” in natural products research today, and there are new findings being made every day. While reviewing all of the literature goes beyond the scope of this chapter, we included many references for those who are interested in pursuing more information.

---

## 11.7 Conclusions

In this chapter, we covered some of the known mechanisms of action of specific plant preparations at target sites. We focused on how phytochemicals participate in cell-cycle interactions, signaling across cell membranes, immunomodulation, and toxic reactions with the body. We then went on to give just a

few examples of the molecular mechanisms that govern the final activity of many phytochemicals. Such basic mechanisms operate through signal transduction pathways, altered gene expression, apoptosis, activation or inhibition of specific enzymes, alteration of the action of neurotransmitters, and action on ROS. The relatively recent explosion in the study of the molecular mechanisms influenced by phytochemicals is considered to be essential in that it uncovers the fundamental reasons that a specific plant compound has an observable mode of action. The resulting improvement in the understanding of the true mechanism then allows researchers and doctors to move in more reliable directions for the future. We hope that this chapter allows the reader to move more easily in his or her search for a better understanding as well.

---

## References

- Barnes, S. (1995). Effect of genistein on *in vitro* and *in vivo* models of cancer. *J Nutr* 125:777S–783S.
- Barnes, S. and T.G. Peterson. (1995). Biochemical targets of the isoflavone genistein in tumor cell lines. *Proc Exp Biol Med* 208: 109–115.
- Bensky, D. and S. Foster. (1986). *Chinese Herbal Medicine. Materia Medica*. Eastland Press, Seattle, Washington.
- Bhardwaj, R.K., H. Glaeser, L. Becquemont, U. Klotz, S.K. Gupta, and M.F. Fromm. (2002). Piperine, a major constituent of black pepper, inhibits human P-glycoprotein and CYP3A4. *J Pharmacol Exp Ther* 302: 645–650.
- Bisset, N.G. (Ed.). (1994). *Herbal Drugs and Phytopharmaceuticals*. Medpharm, Stuttgart, Germany; CRC Press, Boca Raton, Florida.
- Boik, J. (1996). *Cancer and Natural Medicine*. Oregon Medical Press, Princeton, Minnesota.
- Bourrie, M., V. Meunier, Y. Berger, and G. Fabre. (1996). Cytochrome P450 isoform inhibitors as a tool for the investigation of metabolic reactions catalyzed by human liver microsomes. *J Pharmacol Exp Ther* 277: 321–332.
- Brazier, N.C. and M.A. Levine. (2003). Drug–herb interaction among commonly used conventional medicines: a compendium for health care professionals. *Am J Ther* 10: 163–169.
- Breinholt, V., S.T. Lauridsen, and L.O. Dragsted. (1999). Differential effects of dietary flavonoids on drug metabolizing and antioxidant enzymes in female rat. *Xenobiotica* 29: 1227–1240.
- Breinholt, V.M., E.A. Offord, C. Brouwer, S.E. Nielsen, K. Broesen, and T. Friedberg. (2002). *In vitro* investigation of cytochrome P450-mediated metabolism of dietary flavonoids. *Food Chem Toxicol* 40: 609–616.
- Budzinski, J.W., B.C. Foster, S. Vandenhoeck, and J.T. Arnason. (2000). An *in vitro* evaluation of human cytochrome P450 3A4 inhibition by selected commercial herbal extracts and tinctures. *Phytomedicine* 7: 273–282.
- Bussing, A. et al. (1996). Induction of apoptosis in human lymphocytes treated with *Viscum album* L. is mediated by the mistletoe lectins. *Canc Lett* 99: 59–72.
- Butterweck, V., H. Derendorf, W. Gaus, A. Nahrstedt, V. Schulz, and M. Unger. (2004). Pharmacokinetic herb–drug interactions: are preventive screenings necessary and appropriate? *Planta Med* 70: 784–791.
- Carrillo, J.A., M. Christensen, S.I. Ramos, C. Alm, M.L. Dahl, J. Benitez, and L. Bertilsson. (2000). Evaluation of caffeine as an *in vivo* probe for CYP1A2 using measurements in plasma, saliva, and urine. *Ther Drug Monit* 22: 409–417.
- Castiglioni, S. et al. (1993). Rhein inhibits glucose uptake in ehrlich ascites tumor cells by alteration of membrane-associated functions. *Anti-Cancer* 4: 407–414.
- Chang, T.K., J. Chen, and S.A. Benetton. (2002). *In vitro* effect of standardized ginseng extracts and individual ginsenosides on the catalytic activity of human CYP1A1, CYP1A2, and CYP1B1. *Drug Metab Dispos* 30: 378–384.
- Chatterjee, S.S., S.K. Bhattacharya, M. Wonnemann, A. Singer, and W.E. Muller. (1998). Hyperforin as a possible antidepressant component of hypericum extracts. *Life Sci* 63: 499–510.
- Chen, Z.Y., C.C. White, and D.L. Eaton. (1993). Decreased expression of cytochrome P450 mRNAs and related steroid hydroxylation activities in hepatic hyperplastic nodules in male F344 rats. *Toxicol Appl Pharmacol* 123: 151–159.

- Combs, S.P. (1997). Acute anticholinergic syndrome: Jimson weed strikes again. *Res Staff Phys* 43: 54–57.
- Cotran, R.S., V. Kumar, and S.L. Robbins. (1989a). In *Robbins Pathologic Basic of Disease*. Cotran, R.S., Kumar, V., Collins, T., and Robbins, S.L., Eds., W.B. Saunders, Philadelphia, Pennsylvania, pp. 520–522.
- Cotran, R.S., V. Kumar, and S.L. Robbins. (1989b). In *Robbins Pathologic Basic of Disease*. Cotran, R.S., Kumar, V., Collins, T., and Robbins, S.L., Eds., W.B. Saunders, Philadelphia, Pennsylvania, pp. 267–272.
- Dickson, E.F.G., R.L. Goyan, and R.H. Pottier. (2003). New directions in photodynamic therapy. *Cell and Mol Biol* 48: 939–954.
- Dierbach, H., cited in Tragni, E., C.L. Galli, et al. (1988). Antiinflammatory activity of *Echinacea angustifolia* fractions separated on the basis of molecular weight. *Pharm Res Comm* 20 (Suppl. 5): 87–90.
- Dolmans, D.E.J.G.J., D. Fukumura, and R.K. Jain. (2003). Photodynamic therapy for cancer. *Nat Rev Cancer* 3: 380–387.
- Donato, M.T. and J.V. Castell. (2003). Strategies and molecular probes to investigate the role of cytochrome P450 in drug metabolism: focus on *in vitro* studies. *Clin Pharmacokinet* 42: 153–178.
- Doostdar, H., M.D. Burke, and R.T. Mayer. (2000). Bioflavonoids: selective substrates and inhibitors for cytochrome P450 CYP1A and CYP1B1. *Toxicology* 144: 31–38.
- Dwyer, P.J. et al. (1986). Homoharringtonine — perspectives on an active new natural product. *J Clin Oncol* 4: 1563–1568.
- Epstein, W.L. (1987). Plant-induced dermatitis. *Annals Emer Med* 16: 950–955.
- Forman, B.M. (2001). Polymorphisms in promiscuous PXR: an explanation for interindividual differences in drug clearance? *Pharmacogenetics* 11: 551–552.
- Foster, B.C., M.S. Foster, S. Vandenhoeck, A. Krantis, J.W. Budzinski, J.T. Arnason, K.D. Gallicano, and S. Choudri. (2001). An *in vitro* evaluation of human cytochrome P450 3A4 and P-glycoprotein inhibition by garlic. *J Pharm Pharm Sci* 4: 176–184.
- Foster, B.C., S. Vandenhoeck, J. Hana, A. Krantis, M.H. Akhtar, M. Bryan, J.W. Budzinski, A. Ramputh, and J.T. Arnason. (2003). *In vitro* inhibition of human cytochrome P450-mediated metabolism of marker substrates by natural products. *Phytomedicine* 10: 334–342.
- Foster, S. (1995). Echinacea: the cold and flu remedy. *Altern Compl Ther* June/July, 254–257.
- Fotis, T. et al. (1995). Genistein, a dietary ingested isoflavonoid, inhibits cell proliferation and *in vitro* angiogenesis. *J Nutr* 125: 790S–797S.
- Gilmore, M.R. (1919). Thirty-third annual report of the Bureau of American Ethnology, U.S. Government Printing Office, Washington, D.C.
- Girolomoni, G. and R.E. Tigelaar. (1990). Capsaicin-sensitive primary sensory neurons are potent modulators of murine delayed-type hypersensitivity reaction. *J Immunol* 145: 1105–1112.
- Gorski, J.C., S.M. Huang, A. Pinto, M.A. Hamman, J.K. Hilligoss, N.A. Zaheer, M. Desai, M. Miller, and S.D. Hall. (2004). The effect of echinacea (*Echinacea purpurea*) root on cytochrome P450 activity *in vivo*. *Clin Pharmacol Ther* 75: 89–100.
- Gowda, D.C., B. Neelisiddaiah, and Y.V. Anjaneyalu. (1979). Structural studies of polysaccharides from *Aloe vera*. *Carbohydr Res* 72: 201–205.
- Griffiths, C.E.M., J.N.W.N. Barker, S. Kunkel, and B.J. Nickoloff. (1991). Modulation of leucocyte adhesion molecules, a T-cell chemotoxin (IL-8) and a regulatory cytokine (TNF- $\alpha$ ) in allergic contact dermatitis (rhus dermatitis). *Brit J Dermat* 124: 519–526.
- Grindlay, D. and T. Reynolds. (1986). The *Aloe vera* phenomenon: a review of the properties and modern uses of the leaf parenchyma gel. *J Ethnopharm* 16: 117–151.
- Hennessy, M., D. Kelleher, J.P. Spiers, M. Barry, P. Kavanagh, D. Back, F. Mulcahy, and J. Feely. (2002). St. John's wort increases expression of P-glycoprotein: implications for drug interactions. *Br J Clin Pharmacol* 53: 75–82.
- Ho, P.C., D.J. Saville, and S. Wanwimolruk. (2001). Inhibition of human CYP3A4 activity by grapefruit flavonoids, furanocoumarins and related compounds. *J Pharm Pharm Sci* 4: 217–227.
- Honkakoski, P., T. Sueyoshi, and M. Negishi. (2003). Drug-activated nuclear receptors CAR and PXR. *Ann Med* 35: 172–182.
- Huang, D.Y., T. Ohnishi, H. Jiang, A. Furukawa, and Y. Ichikawa. (1999). Inhibition by retinoids of benzo(A)pyrene metabolism catalyzed by 3-methylcholanthrene-induced rat cytochrome P-450 1A1. *Metabolism* 48: 689–692.
- Huynh, H.T. and R.W. Teel. (2002). Effects of plant-derived phenols on rat liver cytochrome P450 2B1 activity. *Anticancer Res* 22: 1699–1703.

- Imanishi, K. et al. (1981). Pharmacological studies on a plant lectin, aloctin A. I. Growth inhibition of mouse methylcholanthrene-induced fibrosarcoma (meth A) in ascites form by aloctin A. *Experientia* 37: 1186–1187.
- Iosi, F., M.T. Santini, and W. Malorni. (1993). Membrane and cytoskeleton are intracellular targets of rhein in A431 cells. *Anticancer Res* 13: 545–554.
- Janssen, O., A. Scheffler, and D. Kabelitz. (1993). *In vitro* effects of mistletoe extracts and mistletoe lectins. *Arzneim-Forsch/Drug Res* 43: 1221–1227.
- Juckett, G. (1996). Plant dermatitis. *Prostagrad Med* 100: 159–171.
- Jump, D.B., A. Thelen, and M. Mater. (1999). Dietary polyunsaturated fatty acids and hepatic gene expression. *Lipids* 34: S209–S212.
- Kalish, R.S. (1990). The use of human T-lymphocyte clones to study T-cell function in allergic contact dermatitis to urushiol. *J Invest Dermat* 94: 108S–111S.
- Kang, M.H., S.M. Won, S.S. Park, S.G. Kim, R.F. Novak, and N.D. Kim. (1994). Piperine effects on the expression of P450E1, P450B and P450A in rat. *Xenobiotica* 24: 1195–1204.
- Karaca, K., J.M. Sharma, and R. Nordgren. (1995). Nitric oxide production by chicken macrophages activated by acemannan, a complex carbohydrate extracted from *Aloe vera*. *Int J Immunopharm* 17: 183–188.
- Klein, A.D. and N.S. Penneys. (1988). *Aloe vera*. *J Am Acad Dermatol* 18: 714–720.
- Koike, T. et al. (1995a). A 35 kDa mannose-binding lectin with jemagglutinating and mitogenic activities from “Kidachi Aloe” (*Aloe arborescens* Miller var. *natalensis* Berger). *J Biochem* (Tokyo) 118: 1205–1210.
- Koike, T. et al. (1995b). The complete amino acid sequence of a mannose-binding lectin from “Kidachi Aloe” (*Aloe arborescens* Miller var. *natalensis* Berger). *Biochem Biophys Res Comm* 214: 163–170.
- Komoroski, B.J., S. Zhang, H. Cai, J.M. Hutzler, R. Frye, T.S. Tracy, S.C. Strom, T. Lehmann, C.Y. Ang, Y.Y. Cui, and R. Venkataramanan. (2004). Induction and inhibition of cytochromes p450 by the St. John’s wort constituent hyperforin in human hepatocyte cultures. *Drug Metab Dispos* 32: 512–518.
- Koul, S., J.L. Koul, S.C. Taneja, K.L. Dhar, D.S. Jamwal, K. Singh, R.K. Reen, and J. Singh. (2000). Structure–activity relationship of piperine and its synthetic analogues for their inhibitory potentials of rat hepatic microsomal constitutive and inducible cytochrome P450 activities. *Bioorg Med Chem* 8: 251–268.
- Kuong, D.D., A.I. Dovgii, N.V. Adrianov, A.I. Varenitsa, and A.I. Archakov. (1991). Induction of cytochrome P-450 by triterpensaponins in Vietnamese ginseng. *Biokhimiia* 56: 707–713.
- Lau, W.C., P.A. Gurbel, P.B. Watkins, C.J. Neer, A.S. Hopp, D.G. Carville, K.E. Guyer, A.R. Tait, and E.R. Bates. (2004). Contribution of hepatic cytochrome P450 3A4 metabolic activity to the phenomenon of clopidogrel resistance. *Circulation* 109: 166–171.
- Lavie, G., A. Toren, D. Meruelo, R. Stackievicz, S. Hazen, and M. Mandel. (1998). Photodynamic dianthrone in PDT. Dimethyl-tetrahydroxy helianthrone (DThe) and hypericin (HY). Mode of Action. 7th Biennial Congress of IPA, July 1998, Nantes, France. Congress Reports, RC23.
- Lee, H.C., S.G. Hwang, Y.G. Lee, H.O. Sohn, D.W. Lee, S.Y. Hwang, Y.S. Kwak, J.J. Wee, W.H. Joo, Y.K. Cho, and J.Y. Moon. (2002). *In vivo* effects of *Panax ginseng* extracts on the cytochrome P450-dependent monooxygenase system in the liver of 2,3,7,8-tetrachlorodibenzo-*p*-dioxin-exposed guinea pig. *Life Sci* 71: 759–769.
- Lehmann, J.M., D.D. McKee, M.A. Watson, T.M. Willson, J.T. Moore, and S.A. Kliewer. (1998). The human orphan nuclear receptor PXR is activated by compounds that regulate CYP3A4 gene expression and cause drug interactions. *J Clin Invest* 102: 1016–1023.
- Lersch, C. et al. (1990). Stimulation of the immune response in outpatients with hepatocellular carcinomas by low doses of cyclophosphamide (LDCY), *Echinacea purpurea* extracts (echinacin) and thymostimulin. *Archives Geschwulstforsch* 60: 379–383.
- Lersch, C. et al. (1992). Nonspecific immunostimulation with low doses of cyclophosphamide (LDCY), thymostimulin, and *Echinacea purpurea* extracts (echinacin) in patients with far advanced colorectal cancers: preliminary results. *Canc Invest* 10: 343–348.
- Leung, A.Y. and S. Foster. (1996). *Encyclopedia of Common Natural Ingredients*, 2nd ed. John Wiley & Sons, New York.
- Lewis, W.H. and M.P.F. Elvin-Lewis. (1977a). Cell modifiers: mutagens, teratogens, and lectins. In *Medical Botany, Plants Affecting Man’s Health*. John Wiley & Sons, New York, pp. 90–96.

- Lewis, W.H. and M.P.F. Elvin-Lewis. (1977b). Cancer. In *Medical Botany, Plants Affecting Man's Health*. John Wiley & Sons, New York, pp. 120–121.
- Linde, K. and C.D. Mulrow. (2003). St. John's wort for depression. *Cochrane Database Systematic Reviews* 2, CD000448.
- Linde, K., G. Ramirez, C.D. Mulrow, et al. (1996). St. John's wort for depression — an overview and meta-analysis of randomized clinical trials. *Brit Med J* 313: 253–258.
- Loizou, G.D. and J. Cocker. (2001). The effects of alcohol and diallyl sulphide on CYP2E1 activity in humans: a phenotyping study using chlorzoxazone. *Hum Exp Toxicol* 20: 321–327.
- Lubart, R., M. Eichler, R. Lovi, H. Friedman, and A. Shainberg. (2005). Low-energy laser irradiation promotes cellular redox activity. *Photomed and Laser Surg* 23: 3–9.
- Lucas, D., R. Ferrara, E. Gonzalez, P. Bodenez, A. Albores, M. Manno, and F. Berthou. (1999). Chlorzoxazone, a selective probe for phenotyping CYP2E1 in humans. *Pharmacogenetics* 9: 377–388.
- Luettig, B. et al. (1989). Macrophage activation by the polysaccharide arabinogalactan isolated from plant cell cultures of *Echinacea purpurea*. *J Nat Canc Inst* 81: 669–675.
- Markovits, J. et al. (1989). Inhibitory effects of the tyrosine kinase inhibitor genistein on mammalian DNA topoisomerase II. *Canc Res* 49: 5111–5117.
- Markovits, J. et al. (1995). Genistein resistance in human leukaemic CCRF-CEM cells: selection of a diploid cell line with reduced DNS topoisomerase II B isoform. *Biochem Pharm* 50: 177–186.
- Markowitz, J.S., J.L. Donovan, C.L. DeVane, R.M. Taylor, Y. Ruan, J.S. Wang, and K.D. Chavin. (2003). Effect of St. John's wort on drug metabolism by induction of cytochrome P450 3A4 enzyme. *JAMA* 290: 1500–1504.
- McDermott, W.V. and P.M. Ridker. (1990). The Budd-Chiari syndrome and hepatic venoocclusive disease. *Arch Surg* 125: 525–527.
- McManus, O.B. et al. (1993). An activator of calcium-dependent potassium channels isolated from a medicinal herb. *Biochemistry* 32: 6128–6133.
- Mennini, T. and M. Gobbi. (2004). The antidepressant mechanism of *Hypericum perforatum*. *Life Sci* 75: 1021–1027.
- Moore, L.B., B. Goodwin, S.A. Jones, G.B. Wisely, C.J. Serabjit-Singh, T.M. Willson, J.L. Collins, and S.A. Kliewer. (2000). St. John's wort induces hepatic drug metabolism through activation of the pregnane X receptor. *Proc Natl Acad Sci USA* 97: 7500–7502.
- Nielsen, S.E., V. Breinholt, U. Justesen, C. Cornett, and L.O. Dragsted. (1998). *In vitro* biotransformation of flavonoids by rat liver microsomes. *Xenobiotica* 28: 389–401.
- Noldner, M. and K. Schotz. (2002). Rutin is essential for the antidepressant activity of *Hypericum perforatum* extracts in the forced swimming test. *Planta Med* 68: 577–580.
- Obach, R.S. (2000). Inhibition of human cytochrome P450 enzymes by constituents of St. John's Wort, an herbal preparation used in the treatment of depression. *J Pharmacol Exp Ther* 294: 88–95.
- Ohnuma, T. and J.F. Holland. (1985). Homoharringtonine as a new antileukemic agent. *J Clin Oncol* 73: 604–606.
- Olin, B.R. (Ed.). (1995a). The ephedras. *The Lawrence Review of Natural Products. Facts and Comparisons*. Kluwer, St. Louis, Missouri.
- Olin, B.R. (Ed.). (1995b). Comfrey. *The Lawrence Review of Natural Products. Facts and Comparisons*. Kluwer, St. Louis, Missouri.
- Oliver, F. et al. (1995). Contact urticaria due to common stinging nettle (*Urtica dioica*) — histological, ultrastructural and pharmacological studies. *Clin Exp Dermatol* 16: 1–7.
- Pass, G.J. and S. McLean. (2002). Inhibition of the microsomal metabolism of 1,8-cineole in the common brushtail possum (*Trichosurus vulpecula*) by terpenes and other chemicals. *Xenobiotica* 32: 1109–1126.
- Pazdur, R. et al. (1993). The taxoids: paclitaxel (Taxol®) and docetaxel (Taxotere®). *Canc Treat Rev* 19: 351–386.
- Peng, S.Y. et al. (1991). Decreased mortality of Norman murine sarcoma in mice treated with the immunomodulator, acemannan. *Mol Biother* 3: 79–87.
- Peterson, G. (1995). Evaluation of the biochemical targets of genistein in tumor cells. *J Nutr* 125: 784S–789S.
- Quick, G. (1995). Scratching below the surface of poison ivy rash. *Consultant* 34: 545–549.
- Rivory, L.P., K.A. Slaviero, J.M. Hoskins, and S.J. Clarke. (2001). The erythromycin breath test for the prediction of drug clearance. *Clin Pharmacokinet* 40: 151–158.

- Roby, C.A., G.D. Anderson, E. Kantor, D.A. Dryer, and A.H. Burstein. (2000). St. John's Wort: effect on CYP3A4 activity. *Clin Pharmacol Ther* 67: 451–457.
- Roesler, J. et al. (1991a). Application of purified polysaccharides from cell cultures of the plant *Echinacea purpurea* to test subjects mediates activation of the phagocyte system. *Int J Immunopharm* 13: 931–941.
- Roesler, J. et al. (1991b). Application of purified polysaccharides from cell cultures of the plant *Echinacea purpurea* to mice mediates protection against systemic infections with *Listeria monocytogenes* and *Candida albicans*. *Int J Immunopharm* 13: 27–37.
- Roitt, J.M., J. Brostoff, and D.K. Mala. (1985). Hypersensitivity-Type I, Secs. 19.2–19.11. In *Immunology*. C.V. Mosby, St. Louis, Missouri.
- Rowe, T.D. and L.M. Parks. (1941). Phytochemical study of *Aloe vera* leaf. *J Am Pharm Assoc* 30: 262–266.
- Rowinsky, E.K., L.A. Cazenave, and R.C. Donehower. (1990). Taxol: a novel investigational antimicrotubule agent. *J Nat Canc Inst* 82: 1247–1259.
- Runowicz, C.D. et al. (1993). Taxol in ovarian cancer. *Canc (Suppl)* 71: 1591–1596.
- Salmon, S.E. and A.C. Sartorelli. (1989). Cancer chemotherapy. In *Basic and Clinical Pharmacology*. B.G. Katzung (Ed.). Appleton-Lange, Norwalk, Connecticut, p. 694.
- Shelton, R.M. (1991). *Aloe vera*: its chemical and therapeutic properties. *Int J Dermatol* 30: 679–683.
- Smith, K.C. (2005). Laser (and LED) therapy is phototherapy. *Photomed and Laser Surg* 23: 78–80.
- Southcott, R.V. and A.R. Haegi. (1992). Plant hair dermatitis. *Med J Aust* 156: 623–632.
- Steinmuller, C. et al. (1993). Polysaccharides isolated from plant cell cultures of *Echinacea purpurea* enhance the resistance of immunosuppressed mice against systemic infections with *Candida albicans*, and *Listeria monocytogenes*. *Int J Immunopharm* 15: 605–614.
- Stimpel, M. et al. (1984). Macrophage activation and induction of macrophage cytotoxicity by purified polysaccharide fractions from the plant, *Echinacea purpurea*. *Infec Immunol* 46: 845–849.
- Strandell, J., A. Neil, and G. Carlin. (2004). An approach to the *in vitro* evaluation of potential for cytochrome P450 enzyme inhibition from herbals and other natural remedies. *Phytomedicine* 11: 98–104.
- Streetman, D.S., J.S. Bertino, Jr., and A.N. Nafziger. (2000). Phenotyping of drug-metabolizing enzymes in adults: a review of *in-vivo* cytochrome P450 phenotyping probes. *Pharmacogenetics* 10: 187–216.
- Stresser, D.M., G.S. Bailey, and D.E. Williams. (1994). Indole-3-carbinol and -naphthoflavone induction of aflatoxin B1 metabolism and cytochromes P-450 associated with bioactivation and detoxication of aflatoxin B1 in the rat. *Drug Metab Dispos* 22: 383–391.
- Vandebogaerde, A.L. et al. (1996). Antitumor activity of photosensitized hypericin on A431 cell xenografts. *Anticanc Res* 16: 1619–1626.
- Vanderwerf, W.M. et al. (1996). Hypericin: a new laser phototargeting agent for human cancer cells. *Laryngoscope* 106: 479–482.
- van Wyk, B.E., M.C. van Rheede van Oudtshoorn, and G.F. Smith. (1995). Geographical variation in the major compounds of *Aloe ferox* leaf exudate. *Plant Med* 61: 250–253.
- Verotta, L., G. Appendino, J. Jakupovic, and E. Bombardelli. (2000). Hyperforin analogues from St. John's wort (*Hypericum perforatum*). *J Nat Prod* 63: 412–415.
- Wang, H.W., T.L. Chen, P.C. Yang, and T.H. Ueng. (2001). Induction of cytochromes P450 1A1 and 1B1 by emodin in human lung adenocarcinoma cell line CL5. *Drug Metab Dispos* 29: 1229–1235.
- Wang, Y.G., Y. Gao, B.X. Chai, P. Chen, H.L. Tan, Y.H. Zhao, C.R. Xiao, Y.Y. Sun, and L.J. Zhu. (2004). [Modulation of the activities and mRNA expression of cytochrome P450 isoenzymes in rat liver by *Panax ginseng* and coadministration with *Veratrum nigrum*]. *Zhongguo Zhong Yao Za Zhi* 29: 366–370.
- Wang, Z., J.C. Gorski, M.A. Hamman, S.M. Huang, L.J. Lesko, and S.D. Hall. (2001). The effects of St. John's wort (*Hypericum perforatum*) on human cytochrome P450 activity. *Clin Pharmacol Ther* 70: 317–326.
- Wieling, J., W.J. Tamminga, E.P. Sakiman, B. Oosterhuis, J. Wemer, and J.H. Jonkman. (2000). Evaluation of analytical and clinical performance of a dual-probe phenotyping method for CYP2D6 polymorphism and CYP3A4 activity screening. *Ther Drug Monit* 22: 486–496.
- Wikvall, K. (2001). Cytochrome P450 enzymes in the bioactivation of vitamin D to its hormonal form (review). *Int J Mol Med* 7: 201–209.
- Williams, J.A., E.M. Stone, B.C. Millar, B.A. Gusterson, P.L. Grover, and D.H. Phillips. (1998). Determination of the enzymes responsible for activation of the heterocyclic amine 2-amino-3-methylimidazo[4,5-f]quinoline in the human breast. *Pharmacogenetics* 8: 519–528.



- Williams, S.R., R.F. Clark, and J.V. Dunford. (1995). Contact dermatitis associated with capsaicin: Hunan hand syndrome. *Annals Emer Med* 25: 713–715.
- Wilson, B.C. (2002). Photodynamic therapy for cancer: principles. *Can J Gastroenterol* 16: 393–396.
- Wirz, A., U. Simmen, J. Heilmann, I. Calis, B. Meier, and O. Sticher. (2000). Bisanthraquinone glycosides of *Hypericum perforatum* with binding inhibition to CRH-1 receptors. *Phytochem* 55: 941–947.
- Woods, B. and C.D. Calnan. (1976). Toxic woods. *Br J Derma* 95: 1–95.
- Yu, C.T., J. Chen, X.W. Teng, V. Tong, and T.K. Chang. (2005). Lack of evidence for induction of CYP2B1, CYP3A23, and CYP1A2 gene expression by *Panax ginseng* and *Panax quinquefolius* extracts in adult rats and primary cultures of rat hepatocytes. *Drug Metab Dispos* 33: 19–22.
- Zajac, C.S. and E.L. Abel. (1992). Animal models of prenatal alcohol exposure. *Int J Epidemiol* 21: S24–S32.
- Zhou, D.C., R. Zittoun, and J.P. Marie. (1995). Homoharringtonine: an effective new natural product in cancer chemotherapy. *Bull Canc* 82: 987–995.
- Zhou, S., H.L. Koh, Y. Gao, Z.Y. Gong, and E.J. Lee. (2004). Herbal bioactivation: the good, the bad and the ugly. *Life Sci* 74: 935–968.
- Zhu, B., D.S. Ou-Yang, X.P. Chen, S.L. Huang, Z.R. Tan, N. He, and H.H. Zhou. (2001). Assessment of cytochrome P450 activity by a five-drug cocktail approach. *Clin Pharmacol Ther* 70: 455–461.
- Zwillich, T. (1996). FDA considers regulation of ephedrine as drug. *Fam Prac News* 1: 30.

# 12

## *The Uses of Plant Natural Products by Humans and Risks Associated with Their Use*

Peter B. Kaufman, Ara Kirakosyan, Maureen McKenzie, P. Dayanandan,  
James E. Hoyt, and Carl Li

### CONTENTS

12.1	Introduction .....	442
12.2	Food Plants as Sources of Medicine.....	442
12.2.1	Opening Remarks.....	442
12.2.2	Chemistry .....	447
12.2.3	Bioavailability .....	448
12.2.4	Direct Antioxidant Activity.....	448
12.2.5	Effects on Cell Signaling Pathways.....	449
12.2.6	Cancer.....	449
12.2.7	Cardiovascular Disease .....	450
12.2.8	Neurodegenerative Disease .....	451
12.2.9	Diabetes and Complications .....	452
12.2.10	Gastrointestinal Disorders.....	452
12.2.11	Antimicrobial Activity.....	452
12.2.12	Vision Improvement.....	453
12.3	Case Studies on the Uses of Plant Natural Products by Humans.....	453
12.3.1	Kudzu ( <i>Pueraria montana</i> ): Medical and Nutritional Uses of Their Isoflavones (by James E. Hoyt) .....	453
12.3.1.1	Natural History.....	453
12.3.1.2	Traditional Uses .....	453
12.3.1.3	Contemporary Agricultural Uses and Misuses.....	454
12.3.1.4	Chemistry .....	454
12.3.1.5	Western Medical Uses .....	454
12.3.1.6	Kudzu as a Treatment for Alcohol Dependency .....	455
12.3.1.7	Heart and Cerebral Disease .....	455
12.3.1.8	Phytoestrogenic Activity: Osteoporosis, Breast, Prostate, and Endometrium Cancer .....	455
12.3.1.9	Section Summary.....	456
12.3.2	Neem Tree — The Free Miracle Apothecary (by P. Dayanandan).....	456
12.3.2.1	Opening Remarks.....	456
12.3.2.2	Traditional Uses of Neem.....	456
12.3.2.3	Neem and Modern Science.....	458
12.3.2.4	Neem Chemicals .....	458
12.3.2.5	Extraction, Formulation, and Application .....	460
12.3.2.6	Modern Medicinal Uses.....	460
12.3.2.7	Cultivation .....	461
12.3.2.8	A Free Tree? .....	461
12.4	Risks of Alternative and Complementary Therapies.....	461
12.4.1	Reports by the Centers for Disease Control.....	461
12.4.2	Current Uses of Complementary and Alternative Medicine (CAM) Therapies .....	463

12.4.3 Sources of Evidence for the Use of Alternative and Complementary Therapies.....	464
12.4.4 Current Status of the National Center for Complementary and Alternative Medicine .....	465
12.4.5 Issues for Healthcare Providers .....	465
12.4.6 Regulatory, Legal, and Ethical Considerations .....	466
12.4.7 Complementary and Alternative Medicine and Public Health.....	467
12.5 Conclusions .....	468
References .....	469

---

## 12.1 Introduction

Throughout history, natural products from plants have played major, sustaining roles in the lives of humans, especially for food sources and for medicinal products. It is, therefore, appropriate that we take up initially the topic of food plants as sources of medicines, as compiled by Maureen McKenzie. Then, we cite two notable case studies on the uses of plant natural products: one on kudzu (*Pueraria montana*) by James Hoyt, and the second on neem (*Azadirachta indica*) by P. Dayanandan. We end the chapter with an in-depth account by Carl Li on the risks of complementary and alternative therapies.

---

## 12.2 Food Plants as Sources of Medicine

### 12.2.1 Opening Remarks

*Let food be thy medicine and medicine be thy food.*

—Hippocrates

Food plants and culinary herbs and spices are known to contain myriad phytochemicals with medicinal properties (Aggarwal et al., 2004). Phytochemicals are not considered essential for normal body function, as their absence does not lead to deficiency conditions like those for conventional vitamins. Nonetheless, three decades of research revealed that chronic diseases associated with aging are easier to prevent than to treat, and that consumption of phytochemical-rich fruits and vegetables, along with culinary herbs and spices, can reduce the risk of developing such conditions.

The best-studied dietary plants with pharmacomimetic phytochemicals include *Glycine max* L., Fabaceae (genistein and daidzein; Figure 12.1a and Figure 12.1b); *Vitis vinifera* L., Vitaceae, and *Vaccinium* L. spp., Ericaceae (resveratrol; Figure 12.1c); *Lycopersicon esculentum* Mill. syn. *Solanum lycopersicum* L. (lycopene; Figure 12.1d) and *Capsicum annuum* L. (capsaicin; Figure 12.1e) Solanaceae; *Curcuma longa* L. syn. *Curcuma domestica* Valetton (curcumin; Figure 12.1f) and *Zingiber officinale* Roscoe (6-gingerol; Figure 12.1g); Zingiberaceae; *Punica granatum* L. Punicaceae, *Fragaria* L. spp. and *Rubus* L. spp., Rosaceae (ellagic acid; Figure 12.1h); *Ocimum basilicum* L. and *Rosmarinus officinalis* L., Lamiaceae (ursolic acid; Figure 12.1i); *Brassica* L. spp., Brassicaceae (sulforaphane; Figure 12.2a); *Silybum marianum* (L.) Gaertn. and *Cynara cardunculus* L., Asteraceae (silybin; Figure 12.2b); *Foeniculum vulgare* Mill., Apiaceae (anethole; Figure 12.2c); *Syzygium aromaticum* (L.) Merr. and L.M. Perry, Myrtaceae (eugenol; Figure 12.2d); *Allium sativum* L., Liliaceae (allicin, Figure 12.2e); ajoene, Figure 12.2f; S-allyl cysteine, Figure 12.2g; diallyl sulfide, Figure 12.2h); and *Thea sinensis* L., Theaceae (catechin, Figure 12.2i; epigallocatechin-3-gallate, Figure 12.2j).

Others include *Cuminum cyminum* L., Apiaceae (cumin), *Pimpinella anisum* L., Apiaceae (anise), *Crocus sativus* L., Iridaceae (saffron), *Coffea arabica* L., Rubiaceae (coffee), *Theobroma cacao* L., Sterculiaceae (cocoa), and *Linum* spp. Linaceae (flaxseed) also contain bioactive carotenoids, catechins, and lignans (see Chapter 1). Flaxseed is a special example of a food plant as a source of pharmaceuticals, namely, the antitumor podophyllotoxin, deoxypodophyllotoxin, and 5-methoxypodophyllotoxin, and  $\alpha$ - and  $\beta$ -peltatins (Figure 12.3a and Figure 12.3b), synthesized in high levels by *Linum* spp., as well

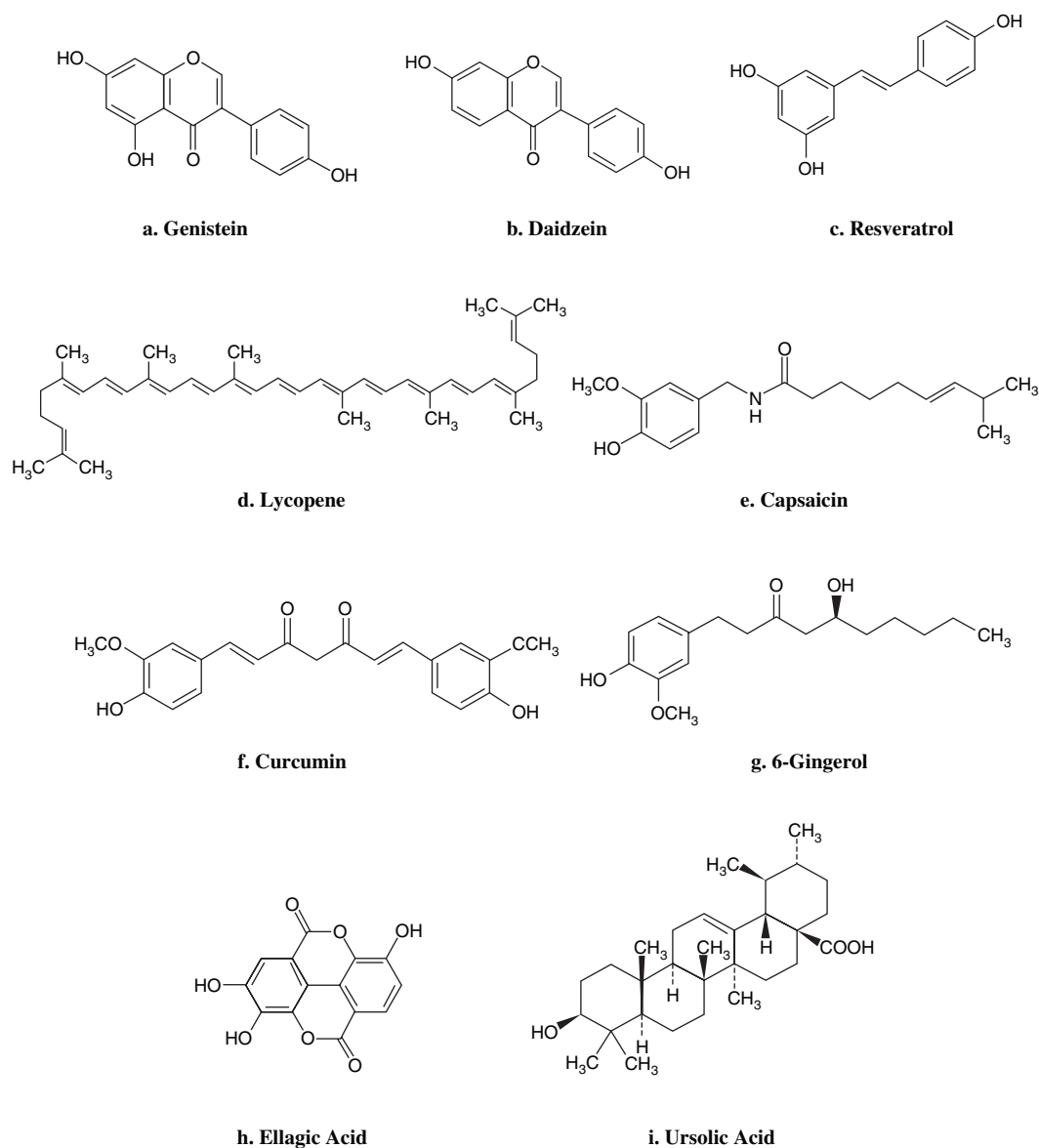

**FIGURE 12.1** The chemical structures of some of the best-studied phytochemicals: (a) genistein, (b) daidzein, (c) resveratrol, (d) lycopene, (e) capsaicin, (f) curcumin, (g) 6-gingerol, (h) ellagic acid, and (i) ursolic acid.

as in *Podophyllum* spp., Berberidaceae, the original source. The compounds, which exhibit exceptional cytotoxicity as antimetotics and topoisomerase II inhibitors, consist naturally of two phenylpropanoid units used as starting materials for the cancer drugs, etopophos, etoposide, and teniposide (Botta et al., 2001).

Phytochemicals (acting individually or synergistically) help reduce risk for a variety of chronic and inflammatory conditions. These include atherosclerosis and stroke, myocardial infarction, certain types of cancers, diabetes mellitus, allergy, asthma, arthritis, Crohn's disease, multiple sclerosis, Alzheimer's disease, osteoporosis, psoriasis, septic shock, AIDS, menopausal symptoms, and neurodegeneration. On a molecular level, phytochemical effects include the suppression of growth factor expression or signaling, activation of apoptosis, downregulation of antiapoptotic proteins, suppression of phosphatidylinositol-3-kinase/Akt, inhibition of NF- $\kappa$ B, Janus kinase-signal transducer and activator of transcription (JAK-STAT), and activator protein-1 (AP-1) signaling pathways, and downregulation of angiogenesis through

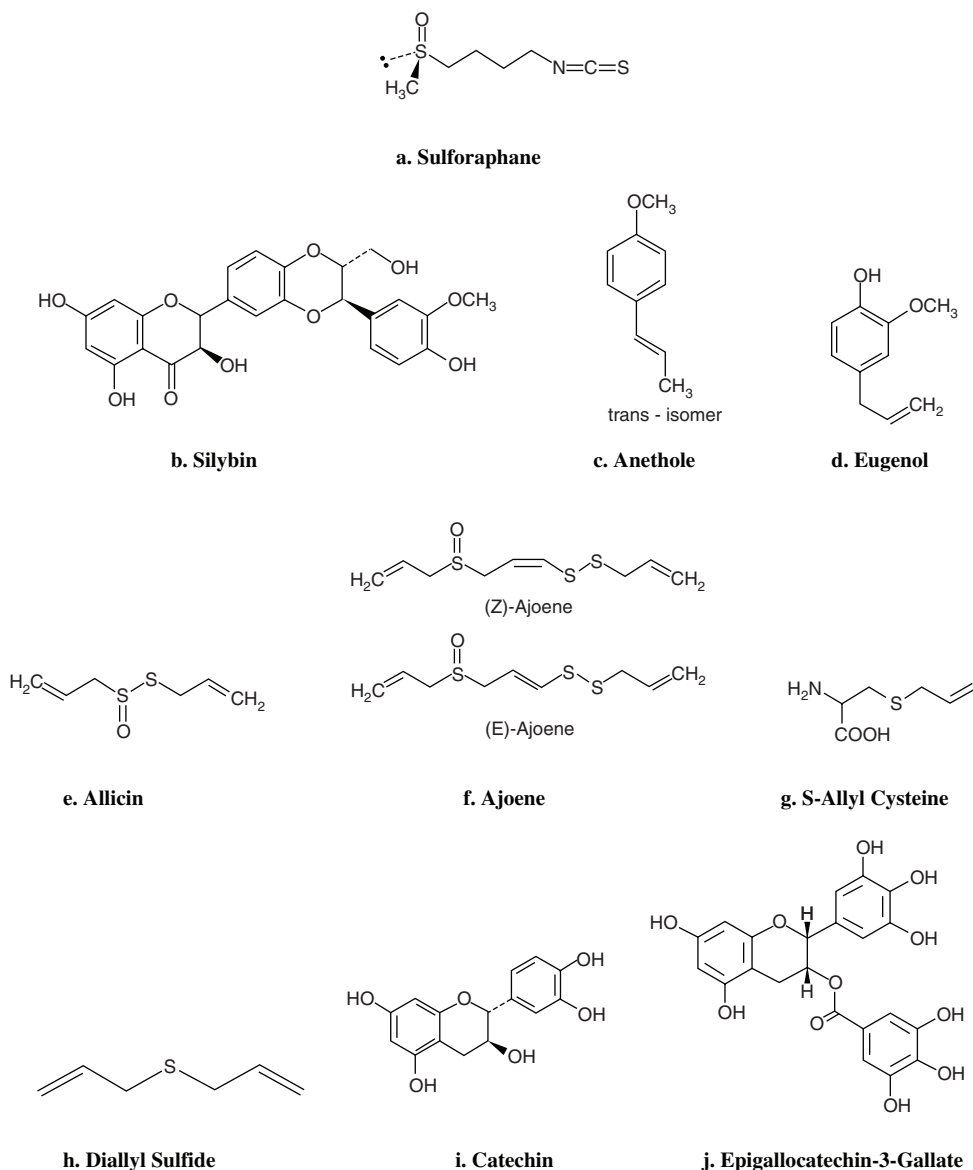

**FIGURE 12.2** The chemical structures of some of the best-studied phytochemicals: (a) sulforaphane, (b) silybin, (c) anethole, (d) eugenol, (e) allicin, (f) ajoene, (g) S-allyl cysteine, (h) diallyl sulfide, (i) catechin, and (j) epigallocatechin-3-gallate.

inhibition of vascular endothelial growth factor expression, cyclooxygenase-2, matrix metalloproteinase-9, urokinase-type plasminogen activator, adhesion molecules, and cyclin D1, among others. Certain phytochemicals suppress cancer cell proliferation, and also, reverse chemoresistance and radioresistance in patients undergoing cancer treatment (Aggarwal et al., 2004).

Recent literature reveals an explosive interest in a class of phytochemicals known as **flavonoids**. The principal types of flavonoids are anthocyanins, flavanols (including catechin monomers, theaflavin and thearubigin dimers, and proanthocyanidin polymers), flavanones, flavonols, flavones, and isoflavones. Dietary sources of flavonoids include common foods (Table 12.1), but individual intakes may vary considerably depending upon which are consumed (Manach et al., 2004). Despite varying individual intakes, correlated with cultural food availability and preferences, total flavonoid intakes in Western

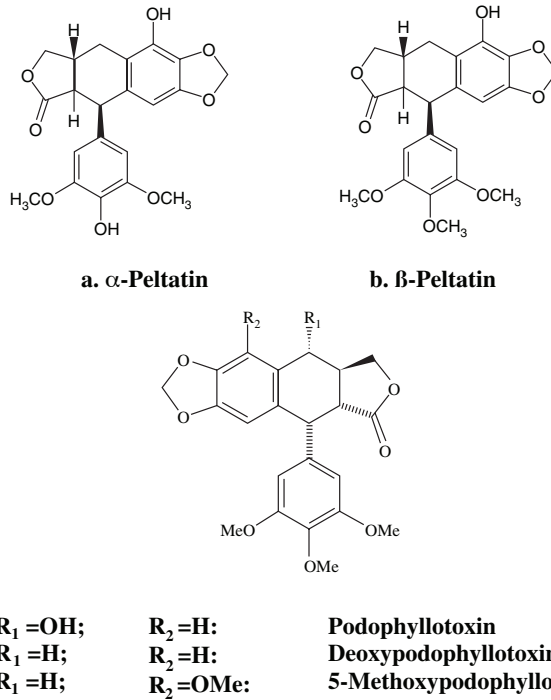

FIGURE 12.3 (1)  $\alpha$ -Peltatin, (b)  $\beta$ -peltatin, and (c) podophyllotoxin, deoxypodophyllotoxin, 5-methoxypodophyllotoxin.

TABLE 12.1

Common Dietary Sources of Flavonoids

Flavonoid Class	Food Sources
Flavonols	Onions, apples, red grapes, broccoli, berries, tea, red wine
Flavones	Parsley, celery, red peppers
Flavanones	Citrus fruits
Anthocyanidins	Berries, cherries, red wine
Catechins	Apples, berries, tea
Isoflavones	Soybeans, peanuts, kudzu, fava beans

populations average about 150 to 215 mg · d<sup>-1</sup> (Manach et al., 2004; Gu et al., 2004). The estimated intake of anthocyanins accounts for most of this figure, at least in the United States, and is far higher than the intake of other known flavonoids at 23 mg · d<sup>-1</sup> (Prior, 2003). These approximations of flavonoid content in foods are influenced by agricultural practices, environmental factors, ripening, processing, storage, and cooking.

Flavonoids are synthesized by plants via the general phenylpropanoid pathway (see Chapter 2 and Figure 12.4) (Koes et al., 2005) to provide defense against oxygen radicals (ROS, reactive oxygen species) generated during photosynthesis and damaging exposure to ultraviolet (UV)-B light (Jaakola et al., 2004). This class of polyphenolic compounds also provides for plants defense against freeze-thaw, nutrient deprivation, dehydration, herbivory, wounding, and microbial pathogen attack. Despite the lack of a fully consistent picture regarding the precise mechanisms of various flavonoids in disease prevention, the conclusion is that flavonoids serve humans in much the same way they serve plants — to protect against oxygen radicals and destructive agents and processes. The biological functions of flavonoids were extensively reviewed by The American Society for Clinical Nutrition (2005).

Among fruits, berries are an excellent source of flavonoids. Of particular interest is the genus *Vaccinium*. It is comprised of more than 450 edible species of blueberries, bilberries, huckleberries,

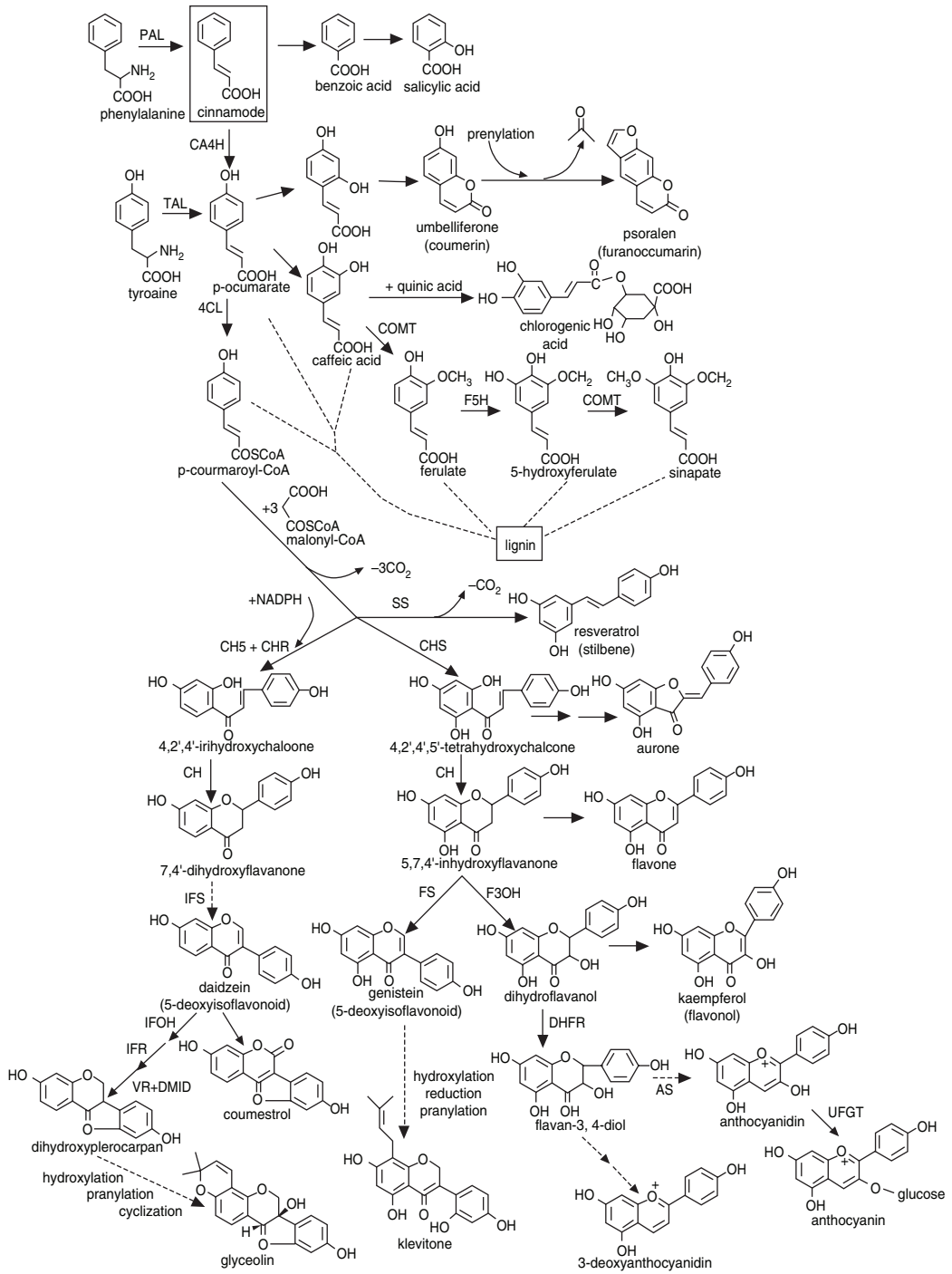

FIGURE 12.4 Biosynthetic relationships between stress-induced phenylpropanoids. (From Dixon, R.A. and N.L. Paiva. (1995). *Plant Cell* 7: 1085–1097. With permission.)

cranberries, and lingonberries. *Vaccinium* berries are recommended by experts as a top choice to include in a healthy diet, as the fruit (and leaves), compared to other berries, contains consistently abundant levels of flavonoids. The health effects of flavonoids have long been recognized for antioxidant, anti-inflammatory, antiallergic, hepatoprotective, antithrombotic, antiviral, and anticarcinogenic properties (Middleton et al., 2000; Prior, 2003). Because berries were such a large part of early human diets, our ancestors probably ate far more phenolics and, in particular, anthocyanins, than are ingested in modern diets. As such, some experts warn of a deficiency in these phytochemicals.

### 12.2.2 Chemistry

In comparison to other fruits, many members of the *Vaccinium* genus produce an exceptionally complex array of anthocyanins in high levels (Taruscio, Barney, and Exon, 2004). Anthocyanins (Figure 12.5) constitute a group of more than 500 hydrophilic plant pigments with 2-phenyl-benzopyrylium (flavylium) structures based on common aglycones, known as anthocyanidins, including cyanidin (magenta), delphinidin (blue-violet), malvidin (red-purple), pelargonidin (scarlet-orange), peonidin (magenta), and petunidin (purple), or a number of less abundant types, that may be glycosylated with glucose or other sugars, or with aromatic (cinnamic) or aliphatic acids. Due to their instability, anthocyanidins are not abundant in nature. *Vaccinium* typically contain 12 to 15 identical anthocyanins with different distribution patterns, but the number was reported to be as many as 25 to 30 in certain species (VDF FutureCeuticals, 2003), with the exception of pelargonidin-derived compounds.

*Vaccinium* species also contain substantial amounts of **phenolics**, such as flavanol precursors of anthocyanins and their glycosides. From extensive studies on the berries of commerce, *Vaccinium corymbosum* L. (highbush blueberry), *Vaccinium angustifolium* Ait. (lowbush blueberry), among many others, the principal flavanols found in *Vaccinium* are quercetin, myricetin, and, to a lesser extent, isorhamnetin and kaempferol in low levels. Flavan-3-ols, such as (+)-catechin, and (-)-epicatechin, and polymers of these compounds in proanthocyanidins of varying sizes and linkages, hydroxycinnamic acids (e.g., *p*-coumaric acid, ferulic acid, sinapinic acid, caffeic acid, ellagic acid, and chlorogenic acid), and phenolic acids (gallic acid, *p*-hydroxybenzoic acid) are characteristic in *Vaccinium* (Sellappan et al., 2002). Monomers of (-)-epicatechin, and a series of oligomers, were detected in *V. corymbosum* cultivars that consisted of (epi)catechin units exclusively singly linked B-type (Prior et al., 2001). In *Vaccinium macrocarpon* Ait. (cranberry), (-)-epicatechin was present, along with a complex series of oligomers. Both A-type, containing only one double linkage per oligomer, and B-type oligomers were present. Another study revealed that ripe fruit of *V. macrocarpon* contains three proanthocyanidin trimers possessing A-type interflavonoid linkages, among other structures (Foo et al., 2000). Other interesting classes

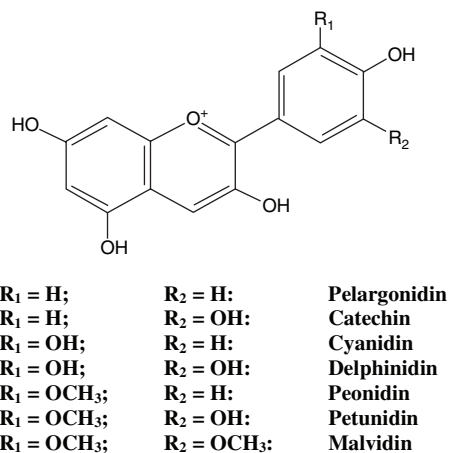

FIGURE 12.5 Anthocyanin chemical structures.



of stress-induced compounds occur in *Vaccinium*, as exemplified by the phytoalexin, *trans*-resveratrol, and the stilbenes, pterostilbene and piceatannol, that were documented in ten species of *Vaccinium* (Rimando et al., 2004). The quantity of resveratrol compounds was highest in the *vitis-idaea* variety of *Vaccinium vitis-idaea* L. (lingonberry), comparable with that in *V. vinifera* (grape), whereas pterostilbene and piceatannol were identified in *Vaccinium ashei* Reade and *Vaccinium stamineum* L. and *V. corymbosum* and *V. stamineum*, respectively. In any case, each *Vaccinium* species has its own characteristic anthocyanin and flavonoid fingerprint. Wild species were found to be consistently higher in anthocyanins, total phenolics, and antioxidant capacity, as compared with cultivated varieties (Taruscio et al., 2004).

### 12.2.3 Bioavailability

In general, the bioavailability of flavonoids is relatively low due to limited absorption and rapid elimination (Williamson, 2003). Flavonoids occur as glycosides in plants and most foods, with the exception of flavanol-type substances, namely, catechins and proanthocyanidins. Even after cooking, most flavonoid glycosides reach the small intestine intact. Only flavonoid glucosides, those specifically bound to D-glucose, and flavonoid aglycones are absorbed in the small intestine, where they are rapidly metabolized by methylation, glucuronidation, or sulfation (Manach et al., 2004). Flavonoids or flavonoid metabolites that reach the colon may be absorbed upon further metabolism by enzymes of the normal bacterial flora. Peak plasma concentrations measured after the consumption of anthocyanins, flavanols, and flavonols (including those from berries and tea) are generally less than  $1 \mu\text{M}\cdot\text{L}^{-1}$ . Because flavonoids are rapidly and extensively metabolized, the biological activities of metabolites are not always the same as those of the parent flavonoid compound (Williams et al., 2004). Therefore, an important consideration when extrapolating data from cultured cells is whether the flavonoids and metabolites were examined at physiologically relevant concentrations (Kroon et al., 2004). Differences *in vivo* in absorption, metabolism, and excretion relate to the nature of the phenolic aglycon and sugar conjugate, amount ingested, food matrix, degree of bioconversion in the gut and tissues, and nutrient and genetic status of the animal or human subject (Manach et al., 2004).

Anthocyanins are found in human plasma in particularly low concentrations 0.5 to 1 h after ingestion and fall to near baseline levels within 6 to 8 h. A small but significant increase in plasma hydrophilic and lipophilic antioxidant capacity was observed following the consumption of a single meal of whole *V. angustifolium* fruit, while other workers further demonstrated a relatively consistent increase in plasma antioxidant capacity after the consumption of 1.2 g anthocyanins from berries (Prior, 2003). Intact, unmetabolized anthocyanins were detected for all molecular structures investigated, but in different relative amounts, and overall, at very low concentrations of 0.1% or less of the dose. This may be due to the inability of human small intestine  $\beta$ -glucosidases to hydrolyze the glucoside from the anthocyanin moiety. An increase in antioxidant activity in plasma was also observed in elderly subjects who consumed *Vaccinium* daily for a month, but what remains unclear is whether anthocyanins are accumulated in tissues if consumed over an extended period of time and if the increases in serum **oxygen radical absorbing capacities (ORAC)** are due to flavonoid compounds (Prior, 2003). Various types of anthocyanins with diverse molecular structures from *Vaccinium* appeared in the urine of humans and rats after dosing, but in different relative concentrations. This demonstrated that anthocyanins are bioavailable at diet-relevant dosage rates but with variations due to chemical structure (McGhie et al., 2003). Outstanding questions regarding bioavailability are of critical importance to understanding the impact of flavonoids on human health.

### 12.2.4 Direct Antioxidant Activity

Flavonoids are efficient scavengers of ROS and metal-chelating agents *in vitro*, and this antioxidant capacity has been linked by many to health-promoting properties. Ubiquitous cyanidin and its flavonol precursor, quercetin, possess highly effective radical scavenging structures with 3,4-dihydroxy substituents in the B ring and conjugation between the A and B rings (Prior, 2003). The ORACs for peroxy radical of specific anthocyanins, expressed as  $\mu\text{mol}$  Trolox equivalents, are cyanidin (2.24) > malvidin

(2.01) > delphinidin (1.81) > peonidin (1.69) > pelargonidin (1.54) (Mazza and Oomah, 2000; Prior et al., 1998). Phenolic acids also possess potent antioxidant activity, likely due to dihydroxylation in the 3,4 positions as hydrogen donors. Consistent with composition, *Vaccinium* and *Rubus* spp. have the highest average ORAC values of all fruits (Taruscio et al., 2004, and references therein). Of commercial berries tested, *V. myrtillus* and *V. angustifolium* displayed the highest ORAC. Cyanidin derivatives are important oxygen radical scavengers in *Vaccinium*, albeit not necessarily the most abundant compound in all species, with chlorogenic acid in *V. corymbosum* and quercetin glycosides in *V. macrocarpon* and *V. vitis-idaea* serving as principal antioxidants. Wild species, such as *Vaccinium ovalifolium* Sm., growing at high latitudes under extreme UV-B exposure, possess the highest ORAC, **hydroxyl radical (HORAC)**, and **peroxynitrite (NORAC)** of all (McKenzie, 2004). An overall abundance of these compounds, along with substantial amounts of potentially antioxidant proanthocyanidins, make *V. ovalifolium* fruit unique.

### 12.2.5 Effects on Cell Signaling Pathways

The biological effects of flavonoids have been linked causally to their considerable *in vitro* antioxidant activity, but cell culture experiments suggest, instead, that the bioactivities of flavonoids are related to modulation of cell-signaling pathways (Williams et al., 2004). Because flavonoids and, in particular, anthocyanins are considered poorly bioavailable, their impact on cellular antioxidant capacity seems less plausible for observed effects than actions on cell-signaling pathways at considerably lower intracellular concentrations. In addition, flavonoid metabolites probably retain their ability to interact with cell-signaling proteins, even if their antioxidant activity is diminished. Results from numerous cell culture studies suggest that flavonoids selectively inhibit kinases that catalyze phosphorylation of target proteins at specific sites and trigger cascades involving specific phosphorylations or dephosphorylations of signal transduction proteins. These cascades ultimately affect transcription factor activity and expression of genes associated with disease prevention or development (Williams et al., 2004).

### 12.2.6 Cancer

Flavonoids manifest antimutagenic activity and antitumor properties through modulation of cell-signaling pathways related to cell growth and proliferation, and certain ones cause undifferentiated cancer cell lines to differentiate into cells exhibiting mature phenotypic characteristics (Middleton et al., 2000). The anticancer potential of *Vaccinium* preparations was demonstrated in many types of studies:

**Preservation of normal cell cycle regulation and repair of DNA damage:** Defective cell cycle regulation may result in the propagation of mutations that contribute to the development of cancer. *Vaccinium* juice suppressed mutagenicity of the polycyclic aromatic hydrocarbons 2-amino-3-methyl[4,5-f]-quinoline, and in part, by 2-amino-3,4-dimethylimidazo-[4,5-f]quinoline or 2-amino-3,8-dimethylimidazo[4,5-f]quinoxaline in Ames tester strains *Salmonella typhimurium* TA98 and TA100 (Edenharder et al., 1994). An extract of *V. macrocarpon* presscake containing flavonoids inhibited proliferation of eight human tumor cell lines of multiple origins (Ferguson et al., 2004). Initially, the extract was shown to block cell-cycle progression in the estrogen-independent breast cell line, MDA-MB-435, but the androgen-dependent prostate cell line, LNCaP, was the most sensitive of six diverse tumor cell lineages. In another study, the rate-limiting enzyme in the synthesis of polyamines, ornithine decarboxylase, the enhanced formation of which is observed in rapidly proliferating cells characteristic of cancer, was shown to be inhibited by a proanthocyanin fraction of *V. angustifolium*, and to a lesser extent, *V. myrtillus* (Bomser et al., 1996). Commercial anthocyanin-rich extracts were also shown to inhibit proliferation of colon-cancer-derived HT-29 cells at low concentrations that did not affect nontumorigenic colonic NCM460 cells (Zhao et al., 2004). Furthermore, novel triterpene cinnamates from *V. macrocarpon* were inhibitory to MCF-7 breast, ME180 cervical, and PC3 prostate tumor cell lines (Murphy et al., 2003), as were unique proanthocyanidins found to

show antiproliferative activity against human prostate and mouse liver tumor cell lines (Schmidt et al., 2004).

***Inhibition of proliferation and induction of apoptosis:*** Unlike normal cells, cancer cells proliferate rapidly and fail to respond to cell death signals by undergoing apoptosis. Of ethanol extracts of ten edible berries, that from *V. myrtillus* was most effective at inhibiting the growth of HL60 human leukemia cells and HCT116 human colon carcinoma cells *in vitro*. The extract induced apoptotic cell bodies in both, but caused nucleosomal DNA fragmentation only in HL60 cells (Katsube et al., 2003). Pure delphinidin and malvidin induced apoptosis in HL60 cells like glycosides isolated from the extract. Presscake from *V. macrocarpon* was found to regulate cell-cycle progression via annexin V, a protein involved in apoptosis (Ferguson et al., 2004).

***Stimulating phase II detoxification enzyme activity:*** Phase II detoxification enzymes catalyze reactions that promote metabolism and excretion of potentially toxic, mutagenic, or carcinogenic chemicals. One example is the liver detoxification enzyme, **NAD(P)H:(quinone-acceptor) oxidoreductase**, that functions to inactivate electrophilic forms of carcinogens, providing a mechanism for the inhibition of carcinogenesis. Extracts of four *Vaccinium* species, and a hydrophobic subfraction of *V. myrtillus*, demonstrated potent ability to induce quinone oxidoreductase in Hepa 1c1c7 cells and serve as possible dietary anticarcinogens (Bomser et al., 1995).

***Inhibiting tumor invasion and angiogenesis:*** Cancer cells invade normal tissue with matrix-metalloproteinase enzymes, and invasive tumors develop new blood vessels to fuel their rapid proliferation by a process known as **angiogenesis**. Various *Vaccinium* extracts and a commercial mixed berry powder (Optiberry™) significantly inhibited inducible monocyte chemotactic protein 1 (MCP-1) and NF- $\kappa$ B transcription associated with angiogenesis in endothelioma cells (Bagchi et al., 2004). The mixed berry powder significantly inhibited expression by human keratinocytes of both H<sub>2</sub>O<sub>2</sub>- and TNF- $\alpha$ -induced vascular endothelial growth factor (VEGF), a key regulator of tumor angiogenesis. Endothelioma cells pretreated with berry powders showed diminished hemangioma formation based on these mechanisms and provided the first *in vivo* evidence to substantiate the anti-angiogenic property of edible berries. Cyclooxygenase-2 (COX-2) is overexpressed in neoplasias, and increased activity of COX-2 promotes tumor vascularization and angiogenesis. COX-2 inhibitors, such as **nonsteroidal anti-inflammatory drugs** (NSAIDs) inhibit carcinogenesis, reduce blood flow through the tumor tissue, and thereby, inhibit angiogenic activity within the tumor. Commercial extracts of *V. angustifolium* (VitaBlue™) were shown to selectively inhibit COX-2 *in vitro* and to inhibit proliferation of an unspecified human prostate tumor cell line (VDF FutureCeuticals, 2003).

***Decreasing inflammation:*** Immune-system-mediated inflammatory processes increase levels of oxygen radicals and release of inflammatory factors that promote cell proliferation and angiogenesis and inhibit apoptosis. COX-2 enzymes are the principal pro-inflammatory enzymes that play a key role in the progression of aging and age-associated conditions, such as cancer. In studies conducted on a commercial extract of *V. angustifolium*, potent *in vitro* inhibition of COX-2 was observed, with no effect of the extract on COX-1 (VDF FutureCeuticals, 2003), whereas *V. corymbosum* and *V. macrocarpon* preparations were found by others to be inactive against the enzyme (Seeram et al., 2001). Although processes mediated by COX-2 are linked to cancer, the precise roles of anti-inflammatory activities from *Vaccinium* await clarification *in vivo*.

### 12.2.7 Cardiovascular Disease

Epidemiological studies have suggested that flavonoid consumption is linked to lower risk of cardiovascular disease (Middleton et al., 2000). Atherosclerosis, like cancer, is an inflammatory disease, and several measures of inflammation are associated with increased risk of serious events, such as myocardial infarction and stroke:

***Inhibition of cholesterol and low-density lipoprotein (LDL) oxidation and other types of oxidative stress:*** The deposition of plaques containing cholesterol and lipids in arterial walls, defined as

**atherogenesis**, starts with the uptake of oxidized LDL by endothelial macrophages, the accumulation of foam cells in the intima of the artery, and the formation of fatty streaks. Flavonoid fractions rich in anthocyanins, flavonols, and proanthocyanidins from *V. macrocarpon* and other berry species were shown to inhibit these early events in cardiovascular disease (Reed, 2002; Heinonen et al., 1998). *Vaccinium* anthocyanins and hydroxycinnamic acids ameliorate H<sub>2</sub>O<sub>2</sub> and TNF- $\alpha$  induced damage to human microvascular endothelial cells. Polyphenols from berries were able to localize into endothelial cells, subsequently reducing the vulnerability of endothelial cells to increased oxidative stress at both the membrane and in the cytosol. Furthermore, berry polyphenols reduced TNF- $\alpha$ -induced upregulation of various inflammatory mediators MCP-1, interleukin-8 (IL-8), and intercellular adhesion molecule 1 (ICAM-1) involved in the recruitment of leukocytes to sites of damage or inflammation along the endothelium (Youdim et al., 2002).

**Decreasing vascular cell adhesion molecule expression and platelet aggregation:** One of the initiating events in the development of atherosclerosis is the recruitment of inflammatory white blood cells from the blood to the arterial wall. This event is dependent on the expression of adhesion molecules by the vascular endothelial cells that line the inner walls of blood vessels. **Platelet aggregation**, one of the first steps in the formation of a blood clot that can occlude a coronary or cerebral artery, may result in myocardial infarction or stroke. Inhibiting platelet aggregation is considered an important strategy in the primary and secondary prevention of cardiovascular disease. To this end, dietary polyphenolic compounds, with emphasis on quercetin (found in appreciable levels in *Vaccinium*), were shown to inhibit collagen-stimulated platelet activation through multiple components of the glycoprotein VI signaling pathway (Hubbard et al., 2003a, 2003b). Platelet-activating factor (PAF)-induced exocytosis *in vitro* was also potently inhibited by extracts of *V. vitis-idaea* (Tunon, Olavsdotter, and Bohlin, 1995).

**Increasing endothelial nitric oxide synthase (eNOS):** Hypertension, atherosclerosis, and diabetes can reduce the flexibility of arterial walls, which contributes to poor blood flow and plaque formation. Nitric oxide produced by eNOS is needed to maintain arterial vasodilation and flexibility, and impaired nitric-oxide-dependent vasodilation is associated with increased risk of cardiovascular disease. Endothelium-derived nitric oxide bioactivity appears to be increased by supplementation with a number of polyphenols found in *Vaccinium* and other fruits, and this may explain some of the favorable effects of high phenolic intake seen in epidemiological studies (Duffy and Vita, 2003; Reed, 2002).

### 12.2.8 Neurodegenerative Disease

Effects of aging on the nervous system manifest as age-dependent higher loss of brain cells combined with parallel memory loss and behavioral changes (e.g., Alzheimer's disease) (Joseph et al., 2005, and references therein). *Vaccinium* appeared to decrease the vulnerability to oxidative stress and improve age-related declines in brain function, such as motor and cognitive behavior. Aged rats fed a *Vaccinium*-supplemented diet had significantly lower levels of NF- $\kappa$ B than did aged control diet rats, and normalized NF- $\kappa$ B levels correlated negatively and significantly with object memory scores. *Vaccinium* polyphenols also protected endothelial cells against stressor-induced upregulation of oxidative and inflammatory insults and may have beneficial actions against the initiation and development of microvasculature diseases that contribute to age-related deficits and neurological impairments. Insulin-like growth factor-1 (IGF-1), a major activator of the extracellular receptor kinase pathway that is central in learning and memory processes, is also a key modulator of hippocampal neurogenesis (Casadesus et al., 2004). All parameters of hippocampal neuronal plasticity are increased in *Vaccinium*-supplemented animals, and proliferation, extracellular receptor kinase activation, and IGF-1 peptide and receptor levels correlate with improvements in spatial memory. Additional research suggested that not only antioxidant and anti-inflammatory mechanisms might exert these beneficial effects, but also, the most important factor is the increase in cellular signaling and neuronal communication.

### 12.2.9 Diabetes and Complications

*Vaccinium* preparations, including commercial products from *V. myrtillus* and folk medicines from local species, have a long history of use for treating diabetes mellitus and complications (Thorne Research, Inc., 2001). For blood glucose normalization, *V. myrtillus* leaf infusions were administered orally to streptozotocin-diabetic rats. Results showed that plasma glucose levels consistently dropped by about 26% at two different stages of diabetes, and unexpectedly, plasma triglycerides decreased by 39% following treatment (Cignarella et al., 1996). In another *in vitro* study, cyanidin-3-glucoside and delphinidin-3-glucoside were the most effective stimulators of insulin secretion, boosting it by up to 50% from the rodent pancreatic  $\beta$ -cell line, INS-1 832/13 (Jayaprakasam et al., 2005). Antioxidative defense occurred in a short-term rat model of diabetes upon treatment with a commercial extract containing *Vaccinium*, among other components, leading to increased catalytic concentration of glutathione-S-transferase in the liver of diabetic nonobese-diabetic (NOD) mice, and a decrease in malondialdehyde concentration, which could be explained by its antihyperglycemic effect (Petlevski et al., 2003). Regarding applicability to diabetic complications, clinical trials demonstrated the efficacy of a *V. myrtillus* anthocyanin extract, marketed in Europe as a pharmaceutical product to treat various microcirculation diseases, to treat peripheral vascular disease in diabetics (reduced blood supply to the lower limbs), to have a stabilizing effect on collagen, to reduce capillary permeability and increase capillary resistance, as well as to help in the pre- and postoperative treatment of varicose veins and hemorrhoids (Lietti, 1976). Flavonoids, such as those from *Vaccinium*, inhibit aldose reductase, an enzyme that converts sugars to sugar alcohols, and is implicated with diabetic complications, such as heart disease, neuropathy, and retinopathy (Thorne Research, Inc., 2001).

#### 12.2.10 Gastrointestinal Disorders

Extracts of *V. myrtillus* and *Vaccinium uliginosum* L. (bog bilberry) are time-honored remedies for gastrointestinal complaints and inflammation and are used in traditional and alternative medicine for treatment of various types of diarrhea, including dysenteric diarrhea (Gruenwald, 2004). Interestingly, the COX-1 isozyme, which is not inhibited by *Vaccinium* extracts that inhibit COX-2, is thought to have protective activity in the gastrointestinal tract. It is the site of occurrence of adverse NSAID side effects where *Vaccinium* is administered to inhibit COX-2 in many inflammatory conditions (VDF FutureCeuticals, 2003). *V. myrtillus* preparations, in combination with oligomeric proanthocyanidins and other dietary supplements, were shown to alleviate symptoms of chronic fatigue syndrome associated with oxidative stress via cytokine induction, food intolerance, and celiac disease (Logan and Wong, 2001).

In studies conducted by Cristoni, Malandrino, and Magistretti (1989), *V. myrtillus* anthocyanosides and a derivative were shown to lower the ulcer index and to promote gastric protection, due to enhanced mucus production, without increased gastric juice production. These studies demonstrated that rats fed a commercial *V. myrtillus* extract, Myrtocyan<sup>®</sup>, which contains 25% anthocyanidins, were significantly protected from chemically induced gastric ulcers. Growth of *Helicobacter pylori*, the causative agent of ulcers, was inhibited by *Vaccinium*, and clarithromycin-resistant strains were rendered more sensitive to the antibiotic in the presence of extracts (Chatterjee et al., 2004).

#### 12.2.11 Antimicrobial Activity

*V. myrtillus* and *V. uliginosum* preparations, rich in astringent proanthocyanidins, are recognized for antibacterial properties and their ability to alleviate symptoms of viral infections, such as colds and sore throat (Gruenwald, 2004). Traditionally, *Vaccinium* juice was thought to be useful for the prevention of urinary tract infections due to acidification of the urine. More recently, purified *V. macrocarpon* proanthocyanidins were shown to be bacteriostatic by inhibiting adherence of uropathogenic *Escherichia coli* to the wall of the bladder and urinary tract, thereby preventing bacterial colonization (Howell, 2002). Two of them, with unique molecular structures, isolated from *V. macrocarpon* and *V. angustifolium* fruit, exhibit potent bacterial antiadhesion activity (Schmidt et al., 2004). *V. macrocarpon* extracts are also known to antagonize attachment of oral streptococci and reduce biofilm formation by glucosyltransferase

and fructosyltransferase, thereby protecting the tooth surface and retarding the development of dental plaque (Yamanaka et al., 2004; Steinberg et al., 2005).

### 12.2.12 Vision Improvement

During World War II, jam made from *V. myrtillus* was used to improve British pilots' night vision. Aside from purported improvement of night vision, *V. myrtillus* has been studied for its potential value in the treatment of other eye ailments, including eye strain, glaucoma, cataracts, age-related macular degeneration, optic neuropathy, and retinopathy. A recent review and references therein cover these topics in more detail (Thorne Research, Inc., 2001).

---

## 12.3 Case Studies on the Uses of Plant Natural Products by Humans

### 12.3.1 Kudzu (*Pueraria montana*): Medical and Nutritional Uses of Their Isoflavones (by James E. Hoyt)

#### 12.3.1.1 Natural History

The genus *Pueraria* is a member of the subtribe Glycininae, of the tribe Phaseoleae, of the legume family Fabaceae, and it comprises some 15 to 16 species. While the first Western description of this genus was by de Candolle in 1825, its members have been well-known and classified by Asian cultures for thousands of years, at least to the sixth century BCE, and probably earlier.

Natural distribution extends from China and Japan to South and Southeast Asia and into Oceania. Three species of *Pueraria* are used by humans. *P. montana* var *lobata*, or kudzu, is a temperate-zone species and the subject of this essay; *P. phaseoloides*, or tropical kudzu, is used as a cover crop; and the third species, *P. tuberosa*, is used for animal feed and is only eaten by humans in time of famine.

Classification of *Pueraria* in the Phaseoleae tribe is determined by the trifoliate (group of three) leaves, while placement in the subtribe Glycininae, which also includes the soybean, is due to the morphology of flowers and seeds as well as to it being insect pollinated. *Pueraria* is the second-largest genus in this subtribe.

All species of *Pueraria* have short hairy stems and are strong climbers, or rarely, shrubs. The growth habit is rambling along the ground or winding on supports such as shrubs, trees, or artificial structures. The rate of growth is phenomenal, reaching 30 cm·d<sup>-1</sup>, or 18 to 30 m in a growing season. *P. tuberosa* and kudzu have tuberous roots. Kudzu propagates by seed, cuttings, or crowns and produces a dense cover of broad leaves. Leaves fall after the first frost with growth resuming the following spring. Older vines are woody and can measure up to 10 cm in diameter. Roots grow to an average depth of 1 m, with depths up to 2.5 m reported. Root diameter ranges up to 45 to 50 cm. With its extensive and deep root system, kudzu is drought resistant; yet, it will perish if its roots are frozen. Flowers are magenta-red-purple, produced on racemes, and have a scent reminiscent of grapes. Seeds are produced in late summer to early fall after about the third year of growth, with seed production increasing in subsequent years. Kudzu is little affected by insects or pathogens, but is attacked by velvet bean caterpillars (*Anticarsia gemmatilis*) and several root nematodes. None are found in the United States. Some bacteria and fungi can also affect kudzu.

#### 12.3.1.2 Traditional Uses

Kudzu is widely distributed throughout China and Japan, and it has a long history of use by humans in its native regions. It was introduced to the highlands of New Guinea and New Caledonia at some point in prehistory, where it became a food staple even before yams (*Dioscorea* spp.). Kudzu leaves are used as a vegetable, starch is extracted from the roots, and fiber for cord and cloth is also produced from kudzu. The stems, leaves, flowers, seeds, and roots were all used in medicine. Because the species is nontoxic and easily propagated by cuttings or crowns, no selective cultivation by humans has been made for it. As a result, the wild and cultivated forms of kudzu are identical; therefore, it is not technically a domesticated species.

The earliest written record of kudzu dates to the Chinese collection, *Shih Ching*, written between 1000 and 500 BCE. Known as *ko*, it is referred to in nine poems. References to kudzu are also found in *Shen Nung Pen Ts'ao*, probably the earliest Chinese pharmacopoeia, considered by contemporary scholars to have been written during the first century BCE. The earliest written record for kudzu in Japan is from *Manyoshu*, a collection of poems written around 600 BCE.

In traditional Chinese medicine, kudzu, or *Ge Gen*, is indicated to help alleviate muscle soreness, headache, and stiff neck; to help promote healing from measles; to promote the production of fluids to cure dysentery and diarrhea; and to aid in the treatment of thirst and diabetes. Other uses include the treatment of fever, intoxication, bleeding, and sore throat. It should be noted here that traditional Chinese medicine rarely uses a single medicine in treatment, in contrast to the “magic bullet” approach that is the norm in Western practice. So, *Ge Gen* would most often be combined with other preparations for optimal results.

Based on the traditional uses of *Ge Gen*, contemporary researchers examined kudzu chemistry and preparations in the context of Western science and medicine. The following sections will address these studies.

### 12.3.1.3 Contemporary Agricultural Uses and Misuses

Kudzu was introduced to humid subtropics and warm temperate areas from South Africa and Argentina in the Southern Hemisphere to Switzerland, the Mediterranean, Crimea, the Caucasus, and the United States in the Northern Hemisphere. First introduced as an ornamental in the United States in 1876, its use was then expanded to pasturage early in the twentieth century CE, while in the 1930s, it was used extensively for erosion control in the southern United States. By the 1950s, kudzu covered 3 million ha and could be found growing over and smothering trees as well as houses, telephone poles, fences, and other structures. With aggressive control measures, kudzu's coverage was reduced. But, with global warming, its naturalized range has now extended as far north as Connecticut, New York, and even southwestern Michigan. This aggressive spreading occurs despite the fact that flowering and seed-set are greatly reduced in areas it is naturalized in, perhaps due to less-than-optimal insect pollinators.

Kudzu has the potential to be a commercially valuable plant in the United States. It produces a superb quality starch from the root as well as a long (80+ mm) fiber suitable for paper, while fibers suitable for textiles are recovered from the vines. All parts of the plant are edible, and as many as 30 chemicals and potential drugs have been identified. Because it grows like a weed, its production costs are low, and being a nitrogen-fixing legume, it helps to improve the soil. The major consideration in successfully cultivating kudzu would be controlling its escape. This is no trivial task, and in practice, the most valuable form of cultivation may be as *in vitro* cell and shoot cultures or seedlings in greenhouses for drug production.

### 12.3.1.4 Chemistry

Kudzu produces large amounts of tannins, as well as polyphenolics, including flavonoids and isoflavonoids commonly found in legumes. Flavonoids are produced by a combination of the **shikimate pathway** and the **acetate-malonate pathway** (Buchanan, Gruijssem, and Jones, 2000) sharing the early part of the pathway with other phenolics, but digresses with the formation of chalcone and its isomerization to flavanone. Isoflavone is derived from flavanone with the migration of the phenyl group from C-2 to C-3, and from isoflavone are derived many of the compounds that make kudzu such an interesting plant for humans, including **daidzin**, **daidzein**, **genistein**, **genestin**, and **puerarin**. Kudzu constitutively produces isoflavonoids in small quantities, but will dramatically increase production when challenged with infectious agents. The production of isoflavonoids can be upregulated by introducing fungal elicitors, usually cell-wall components. In the lab, heavy metal ions were also used to stimulate isoflavonoid production.

### 12.3.1.5 Western Medical Uses

Kudzu, like a great number of other plant species from around the world, has come to the attention of Western medicine. Studies of its biological activity in animals provide a Western understanding of many

of the traditional medical uses for this plant. Studies to date are with animal models or preliminary clinical trials, with further studies required before kudzu preparations are accepted into the Western pharmacopoeia. Early clinical studies indicate that kudzu preparations are safe and point to efficacy in treating several conditions, including alcoholism, cardiovascular disease, osteoporosis, and several hormone-related cancers.

### **12.3.1.6 Kudzu as a Treatment for Alcohol Dependency**

While a wide range of drugs were tested for their usefulness in treating alcoholism, all have significant drawbacks (prescription medicines, unsuitable for teens or pregnant women, potential adverse side effects). None are consistently effective. Kudzu extracts have been used for centuries as a component of the Chinese traditional medicine, XJN, used to treat inebriation. Western-model scientific testing progressed with various animal models and showed that daidzin, daidzein, and puerarin decrease alcohol consumption in those animal models, with daidzin showing the greatest effect (75% in one study on alcohol preference with female rats) (Lin, et al., 1996).

Early clinical studies found kudzu root preparations to be safe, with no measurable changes in sleep, appetite, or subjective psychological condition. No clinically adverse side effects were found that would discourage its use. Subjects did not report nausea after drinking alcohol, nor were their plasma acetaldehyde levels increased (Lukas et al., 1999). While the exact mechanism of reducing alcohol consumption using kudzu extract is unknown, there are three hypotheses under consideration. In the first, isoflavones affect alcohol metabolism. Daidzein might affect alcohol metabolism by inhibiting the elimination of alcohol, while daidzin's mechanism might be through its ability to inhibit human mitochondrial ALDH-2. In the second hypothesis, the isoflavones act on the central nervous system (CNS), altering the state of the brain reward pathways. The third hypothesis is that blood flow to the brain may be altered, which in turn, alters the amount of alcohol reaching the brain. Clearly, kudzu is interesting with regard to its potential to reduce the desire for alcohol. It was shown to be safe, and animal and preliminary clinical studies indicate that it may be effective.

### **12.3.1.7 Heart and Cerebral Disease**

Animal studies of both traditionally prepared kudzu root extracts and preparations of puerarin show significant reduction in hypertension. Studies demonstrate that this effect is probably due to beta blocking (Lu et al., 1980). Other studies showed that they have salutary effects on myocardial infarction and angina pectoris (Zeng et al., 1974). Puerarin extracts were shown to improve cerebral circulation. In China, they are used in clinical practice for both cardiovascular disease and improving cerebral-vascular function.

### **12.3.1.8 Phytoestrogenic Activity: Osteoporosis, Breast, Prostate, and Endometrium Cancer**

The isoflavones of legumes, including kudzu, are structurally similar to mammalian estrogens and can bind to estrogen receptors. They are also known in the literature as phytoestrogenic. There is a large body of epidemiological work that indicates a diet high in phytoestrogens reduces the risk of several hormone-related diseases, such as osteoporosis and cancers of the breast, prostate, and endometrium (uterus). Phytoestrogens are weakly estrogenic and may occupy and block estrogen receptor sites. This would lead to a lower cellular exposure to estrogen and has been offered as one method by which they may lower the risk of cancer. There is recent evidence that indicates that phytoestrogens may preferentially occupy different receptors, labeled ER- $\beta$  receptors, from those occupied by estrogen. This offers a higher level of complexity in hormone regulation than hitherto thought and presents a deeper mystery regarding the activity of phytoestrogenic compounds.

Phytoestrogens were shown to inhibit several enzymes involved in the synthesis of estrogen and testosterone. This indicates a possible second method by which phytoestrogens could protect against tumorigenesis, namely, by reducing the levels of hormones in specific, vulnerable tissues.

Other possible mechanisms are possible. In one example, it was shown that genistein can induce apoptosis in cancerous breast and prostate cells (Li et al., 1999; Geller et al., 1998). It is not known at



this time if this happens *in vivo*, however. Other mechanisms may be possible, such as the inhibition of DNA topoisomerase, but the research is undeveloped at this time.

### 12.3.1.9 Section Summary

Without doubt, kudzu ranks among humanity's most important nongrain plants, along with other great species, such as garlic (*Allium sativum*), ginger (*Zingiber officinale*), and neem (*Azadirachta indica*). Introduced far from its native habitat, it has become a danger to the environment of the southeastern United States, requiring constant and expensive control measures that, at best, will simply contain it while our vigilance lasts. As such, it serves as another example of a hubris that may yet overwhelm us unless we can learn to think ahead, to anticipate possible problems, and to practice precaution. That said, kudzu is a dark cloud with a silver lining because it has so many properties valuable to humanity.

## 12.3.2 Neem Tree — The Free Miracle Apothecary (by P. Dayanandan)

### 12.3.2.1 Opening Remarks

Neem is now rightly famous as a tree providing powerful natural substances with more uses than obtained from any other single tree. Neem products are sold worldwide as natural and easily biodegradable pesticides with high efficacy and low toxicity. The chemical basis for this is now well established. Certain terpenoids found in many parts of the plant, especially the seeds, are active in extremely low concentrations. The neem tree (Figure 12.6) is found throughout the Indian subcontinent, mostly under cultivation. The tree was introduced into nearly 30 countries in Africa, Central America, South America, and the Middle East. Neem, *Azadirachta indica*, is a member of the mahogany family, Meliaceae. It is closely related to an ornamental tree known as the Persian lilac (*Melia azedarach*). *Azadirachta* (*Azad-Darakth* in Persian) means "The Free Tree," referring to its many uses and easy availability (Figure 12.6). Modern scientific research during the past 30 years validated many of its traditional uses, and the plant was dubbed a miracle tree that can solve global problems. A less bitter species (*Azadirachta excelsa*), known as the edible neem, can be found in Southeast Asia, and its leaves are used as a green in some places.

### 12.3.2.2 Traditional Uses of Neem

Neem was extensively used in India for millennia for the many quality products it offered — medicines, pest control agents, timber, oil, fertilizer, gum, nectar, toothbrush, and good shade (Figures 12.7, 12.8, and 12.9). Neem wood is termite- and rot-resistant and is preferred for house construction. Neem is still



FIGURE 12.6 (See color insert following page 256.) Twigs with flowers and fruits of neem (*Azadirachta indica*) on the left and Persian lilac (*Melia azedarach*) on the right.



FIGURE 12.7 (See color insert.) Neem twig used as a toothbrush.



FIGURE 12.8 Some neem products on the Indian market.

venerated as a sacred plant associated with spirits and gods, finding a central place in village life, religion, rituals, and worship. Neem leaves are ground into a paste and applied to heal smallpox and chickenpox eruptions. Neem has been used in traditional medicine to treat bacterial, viral, fungal, and worm infections, in skin and gum care, to remove body and head lice, to mitigate the effect of jaundice, and to promote immune system function, to control diabetes and hypertension, and for general health. Neem oil extracted from the seeds is known in India as “**Margosa oil.**” It is applied to treat ulcers, ringworm, scabies, leprosy, and eczema. The oil is administered orally as a stimulant and to remove intestinal worms and to treat asthma, headaches, and rheumatic pains. The leftover neem cake after expressing oil is applied as a rich fertilizer and as a tool to aid in the control of soil nematodes. Neem twigs are used as toothbrushes to promote healthy gums and teeth. Neem extracts and oil have been used as veterinary medicine to remove ectoparasites such as mites, ticks, and maggots.

**Neem oil** has been in commercial use for a long time as an ingredient in the preparation of toothpastes, talcum powder, soaps, shampoos, and other cosmetics. More than 60 medicinal uses of neem are known



**FIGURE 12.9** Traditionally, these Indian deities are always made from neem wood. Neem is shown in the background.

in various traditional practices. Interestingly, recent scientific research is validating many of these claims, and about 100 bioactive neem chemicals are currently under investigation for their therapeutic uses in human and animal care and in agriculture. Neem chemicals are known to be bactericidal, fungicidal, and anti-inflammatory and have potential uses as antitumor and immunostimulating agents. Malarial parasites, hepatitis B virus, and AIDS virus-infected cells may also respond to neem chemicals. **Azadirachtin** is a spermicidal agent and has potential use as a contraceptive. The current scientific interest and the traditional use stimulated the production and sale of many herbal formulations: soaps and shampoos, creams and ointments as vitalizers, antibacterial hand wash, face masks, and preparations for the treatment of dandruff, lice, acne, and pimples.

### 12.3.2.3 *Neem and Modern Science*

Research in the early 1960s established that neem seed extracts possessed antifeedant properties against desert and migratory locusts. A powerful substance known as **azadirachtin**, isolated in 1968, was shown to inhibit feeding at concentrations as low as 10 to 100 ppm. Also, azadirachtin disrupted the growth and development of many insect larvae at 1 to 10 ppm concentration. Azadirachtin is structurally similar to a group of insect hormones, the ecdyosones that control the metamorphosis of larvae into pupa and adult insects. Application of azadirachtin blocks the production of **ecdysones**, preventing molting and the emergence of adults. Neem chemicals were also found to affect insect life by other modes of action. Thus, in different insects, azadirachtin and related chemicals act as antifeedants, repellents, and deterrents of oviposition, sterilants, molt inhibitors, growth retardants, and destabilizers of normal physiological activities. It is now established that azadirachtin and related triterpenoids are broad-spectrum pesticides against more than 600 insects, nematodes, and mites with low or no harmful effect on humans and other mammals. Neem chemicals are effective against many insects in the orders, Coleoptera, Diptera, Heteroptera, Lepidoptera, and Orthoptera. Azadirachtin controls whiteflies, aphids, thrips, fall armyworm, corn earworm, stem borers, beetles, mushroom flies, mealy bugs, gypsy moths, and others that affect garden vegetables and ornamental plants. Insects such as leafhoppers and plant hoppers that feed on the xylem sap are readily knocked down by azadirachtin, which is taken up by the plant systemically and is transported in the xylem. Azadirachtin is less harmful to beneficial garden organisms such as spiders, wasps, and ladybugs and pollinators like butterflies and bees.

### 12.3.2.4 *Neem Chemicals*

All parts of the neem are bitter in taste. This is due to a variety of **terpenoids** that occur in all living tissues and are especially abundant in the seed cotyledons (Figure 12.10 and Figure 12.11). (A related substance, limonin, is responsible for the bitterness associated with some citrus fruit juices.) Neem terpenoids are stored in specialized single cells known as **secretory cells** (Figure 12.12). Secretory cells occur in roots, young stems, barks, leaves, and of coarse cotyledons. Special staining reagents can reveal

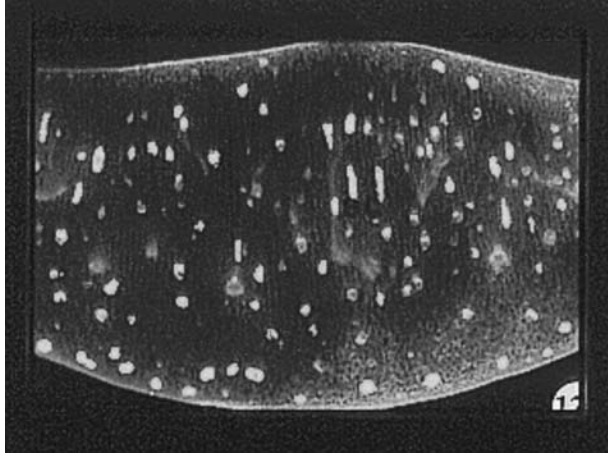

**FIGURE 12.10** (See color insert.) Light micrograph of section of neem seedling cotyledon showing two secretory cells. Stained with toluidine blue. Each cell is about 50  $\mu\text{m}$  in diameter. (Original magnification  $\times 200$ .)

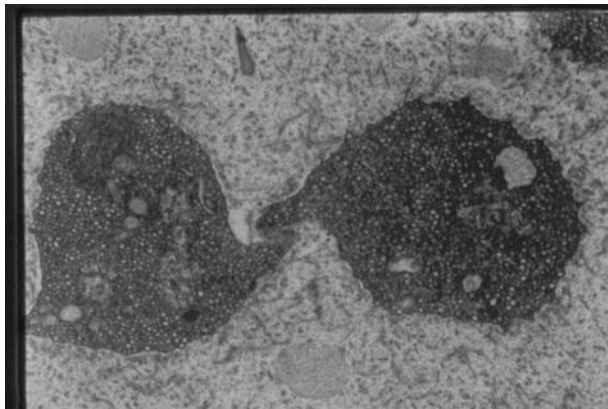

**FIGURE 12.11** Light micrograph cross-section of neem seedling cotyledon showing two secretory cells with terpenoid vesicles. The smaller secretory cell shows a central nucleus. Terpenoid vesicles are interconnected and arise from ER (endoplasmic reticulum). Diameter of the cell is about 50  $\mu\text{m}$ . (Original magnification  $\times 600$ .)

the presence of these secretory cells in simple freehand sections. Within a secretory cell, neem chemicals are synthesized and stored inside many vesicles derived from endoplasmic reticulum. Azadirachtin is a **tertranortriterpenoid**. Several triterpenoids are known, and more are being discovered. Collectively, these terpenoids provide a formidable defense against a variety of organisms that might otherwise destroy the neem tree. The neem triterpenoids belong to a group of chemicals known as **limonoids**, which are restricted to four families of plants in the order Sapindales (Rutales, in some classifications): Meliaceae (mahogany family), Rutaceae (citrus family), Simaroubaceae (tree of heaven family), and Cneoraceae, a small family of three species.

Limonoids are modified triterpenoids derived from a precursor with a **4,4,8-trimethyl-17-furanyl-steroid skeleton**. Limonoids are synthesized in the cells from 30-carbon precursors. More than 300 limonoids were isolated so far. The neem seed contains eight different groups of limonoids, the most biologically active among them being the azadirachtins. Several kinds of azadirachtins are known, with the most abundant and active one being azadirachtin-A. The other neem limonoids are **azadirone**, **gedunin**, **nimbin**, **nimbolinin**, **salannin**, **vepinin**, and **vilasinin**. Salannin and a precursor limonoid known as **meliantriol** also deter insects from feeding. Neem seeds are the major source of neem chemicals for traditional and commercial use. About 30 to 40% of fresh weight of neem seed consists of lipids that can be extracted as greenish-yellow oil. Neem oil is rich in **oleic**, **stearic**, and **palmitic acids**. In

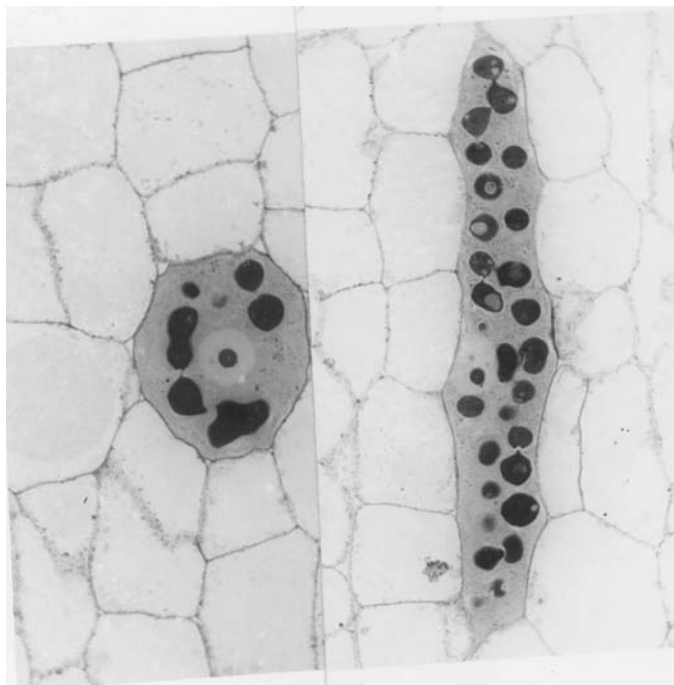

**FIGURE 12.12** Electron micrographs of a secretory cell with vesicles containing neem natural products, including azadirachtin. Each vesicle is about 10  $\mu\text{m}$  in diameter. (Original magnification  $\times 32,500$ .)

addition to the oil, neem extracts contain about 20 other nonterpenoid volatile sulfur compounds that impart characteristic odor to the oil. When pressed, the triterpenoids are extracted along with the oil. Neem seed contains 2.5 to 3% triterpenoids. The azadirachtin content varies from 0.2 to 0.6% (2 to 6 mg per gram of seed).

### 12.3.2.5 Extraction, Formulation, and Application

Neem chemicals are usually extracted from the seeds, although most triterpenoids are present in small quantities in leaves and other organs. The bulk of the seed consists of two fleshy cotyledons, about 1 cm in length. Neem chemicals can be extracted using water or other solvents, such as alcohol, hexane, and pentane (see also Chapter 8). Most farmers in India grind the kernels or leaves and extract the chemicals in water. The suspension can be sprayed over the plants. Limonoids are highly soluble in alcohols, and ethanol is the most preferred solvent for large-scale extraction and concentration of azadirachtin. Crushed seeds are soaked in alcohol either directly or after extracting the oil component with hexane. Where neem seeds are readily available, aqueous extracts are ideal for direct application with or without a wetting agent. For long-term storage and transport to distant places, azadirachtin is extracted and sold as a concentrate. Certain additives, such as **sesame oil** and **paraaminobenzoic acid**, prevent limonoids from sustaining ultraviolet damage. Sesame oil and **pyrethrins** (natural pesticides obtained from *Chrysanthemum* spp.) are sometimes added to increase the efficacy of formulations containing neem chemicals. Farmers and gardeners apply neem extracts as sprays, as wettable powders, or after diluting in the irrigation water.

### 12.3.2.6 Modern Medicinal Uses

Intense medical research is now under way to validate previous claims or discover new therapeutic uses for neem chemicals and other limonoids from related plants. Most such work is carried out with laboratory animals or cell cultures. Some promising areas are as follows: **gedunin** and **nimbolide** may control the growth of malarial parasite; **nimbolide** and **nimbidinic acid** may prove to be good diuretics; **nimbin**

might offer protection against irritation caused by aspirin in the alimentary system; in addition to azadirachtin, nimbidin may possess spermicidal activities; human tumor cells respond to triterpenoids such as **limonin**, **nomilin**, and **12,hydroxyamadorastatin**; neem extracts may kill herpes virus and heal cold sores; the antiviral properties of nimbin and nimbidin against vaccinia virus and fowl pox virus may open up new avenues for treating viral diseases of animals as well as humans. Preliminary reports suggest that azadirachtin might inhibit the multiplication of the AIDS virus. Other promising areas of research include control of fungal aflatoxins and exploitation of the anti-inflammatory properties of neem extracts to treat arthritis and promote healing in cuts, sprains, and bruises.

### 12.3.2.7 Cultivation

Neem is easy to cultivate. The tree grows in dry and wet and even marginal soils. Neem tree can tolerate high temperatures but cannot survive frost. The seeds have a high percentage of germination, but they remain viable only up to 3 weeks after harvest. Neem is a beautiful tree with fragrant flowers; the immature green fruits are very bitter, but the seed coats of ripe yellow fruits have a slimy covering that is sweet and edible. A healthy tree can reach a height of 20 to 25 m, depending upon the soil and climatic conditions, and each tree can produce 50 to 100 kg of fruits and about 10 kg of neem oil per year. With a large array of defense chemicals, one might expect neem to be totally free from all infestations. While neem trees are generally healthy, they too are prone to varying degrees of attack by more than 35 pests. One in particular, the tea-mosquito bug, can cause considerable loss due to the wilting of flowering branches.

A number of studies showed that neem can be propagated in tissue culture using a variety of explants. This has opened up the possibility of growing large amounts of cells in solid or liquid cultures and extracting neem chemicals *in vitro*. A major hurdle that must be overcome is the induction of the cultured cells to turn into secretory cells because only the secretory cells synthesize and store most of the neem chemicals.

### 12.3.2.8 A Free Tree?

Like all good things that have huge commercial potential, neem too is now in the midst of typical controversy over the use of biodiversity. Companies that invested and identified new active principles or developed procedures for extraction, stabilization, and formulations obtained more than 40 international patents. Some find a number of these claims to be not all that novel because traditional users are already aware of them. For more than 2000 years, the neem plant and knowledge about the neem plant were freely used and exchanged. It is natural, therefore, that many wish to promote such traditional uses and indigenous knowledge systems and not convert a sacred plant solely into a source of profit and dependence for poor farmers. A number of organizations, such as The Neem Foundation, are exploring equitable ways of balancing the traditional and modern scientific knowledge and methods of utilizing the extraordinary potentials of neem for the benefit of all.

---

## 12.4 Risks of Alternative and Complementary Therapies

### 12.4.1 Reports by the Centers for Disease Control

More recent evidence suggests that the adverse effects of complementary and alternative medicine (CAM) therapies reach across the spectrum of chronic diseases. In the past, the Centers for Disease Control and Prevention (CDC) documented sporadic cases of the adverse effects of CAM therapies in their *Morbidity and Mortality Weekly Reports*, specifically the adverse effects of plant-derived remedies (Centers for Disease Control and Prevention, 1995b), adrenal cortex extract injections (Centers for Disease Control and Prevention, 1996), and herbal teas (Centers for Disease Control and Prevention, 1995a). Many factors contribute to an increasing frequency of adverse reactions. Under the 1994 Dietary Supplements Health and Educational Act (DSHEA), herbal treatments are considered food products, and this allows dietary supplement manufacturers to make claims on supplement labels. So, unlike all medications prescribed by physicians, herbal supplements are not subject to randomized clinical trial testing for efficacy. Due to the lack of manufacturing standards, the quality and production of herbal supplements are not regulated

(Ko, 1999). This likely results in adulteration caused by substitution of one herb for another, manufacturing and quality problems, variability in the amount of active ingredients, improper processing and preparation, misidentification, inaccurate or incomplete label identification, or contamination. Adverse effects associated with dietary supplements might be related to herb overdoses, inherently toxic herbs, or drug–herb interactions. They might also represent an allergic response or an anaphylactic response to the herbs.

Potential adverse side effects and interactions with conventional cardiovascular therapies were identified for many herbs and supplements. For example, numerous case reports showed an increased bleeding tendency in patients taking herbal supplements in conjunction with warfarin, a medication used to prevent blood clotting (Miller et al., 2004). More food and drug interactions were reported for warfarin than for any other prescription medication (Heck et al., 2000). Some of these herbal supplements that have a potential theoretical risk for increasing the effect of warfarin include chamomile, garlic, ginger, ginkgo, anise, celery, tumeric, and willow bark (Heck et al., 2000). These products contain substances that have coumarin (found in warfarin), salicylate (a major part of aspirin), or antiplatelet properties that might lead to bleeding. Products associated with documented reports of potential interactions with concurrent administration of warfarin include dong quai, ginseng, coenzyme Q10, green tea, and vitamin E (Heck et al., 2000). Multiple pathways exist for interference with warfarin, and such interactions can lead to either excessive bleeding or clotting by increasing or reducing the effect of warfarin. More clinical human trials are needed to confirm and assess the clinical significance of these potential herbal supplement and medication interactions.

Another example of a potential herbal supplement and drug interaction is with **coenzyme Q10 (CoQ10)**, a vitamin-like, fat-soluble quinone used to treat congestive heart failure, chest pain (angina), and high blood pressure (hypertension). Potential drug interactions identified with CoQ10 include additional blood-pressure-lowering effects when administered concurrently with antihypertensive agents and negative interactions between CoQ10 and radiation therapy and chemotherapeutic agents (Miller et al., 2004). **Vitamin E** has been used in the prevention of cardiovascular disease, even though its efficacy in this situation remains unclear. Vitamin E increases bleeding when given with agents that prevent clotting and might decrease the efficacy of statins, an important class of lipid-lowering medications (Miller et al., 2004). Patients should use garlic cautiously if taking warfarin (Ko, 1999). Ginseng, used to alleviate fatigue and the common cold, might have an androgen effect, and it interacts with warfarin and other anticoagulants (Ko, 1999). There is potential for adverse effects and interactions with commonly prescribed medications used in the conventional treatment of cardiovascular disease. Some of these herbal supplements might be used as adjuncts to the conventional management of cardiovascular disease, but no evidence exists that herbal supplements should be used as the primary treatment modality for cardiovascular disease (Miller et al., 2004).

Cancer patients with kidney and liver problems appear to have the greatest risk of herbal supplement and prescription medication interactions (Cassileth, 1999). Herbal supplement and prescription medication interactions occur frequently enough and are sufficiently problematic that cancer specialists require patients to stop taking herbal supplements in the following situations: during chemotherapy to prevent herbal supplement and prescription drug interactions; before radiation, because some herbal supplements can increase the potential for photosensitivity; and prior to surgery to prevent dangerous changes in blood pressure and to prevent interactions with anesthetics and anticoagulants (Werneke et al., 2004).

In a literature review using **Medline** (an electronic scientific literature database), **Cochrane Library**, **EMBASE**, and **phytochemical databases**, case reports, case series, clinical trials, or other types of human investigations relating to herbal supplement and prescription medication interactions were included (Izzo and Ernst, 2001). The results indicate that St. John's wort (*Hypericum perforatum*) lowers blood concentrations of cyclosporine (an immunosuppressive drug used to prevent rejection of transplanted organs), amitriptyline (an antidepressant drug), digoxin (a cardiovascular drug), warfarin, and theophylline (a drug used to treat chronic obstructive pulmonary disease) and causes menstrual bleeding, delirium, or mild serotonin (a neurotransmitter) syndrome when used concomitantly with oral contraceptives, loperamide (an antidiarrheal drug), or selective serotonin-reuptake inhibitors (sertraline, paroxetine, nefazodone — all are antidepressant drugs), respectively. Ginkgo (*Ginkgo biloba*) interactions include bleeding when combined with warfarin and raised blood pressure when combined with a thiazide

diuretic. Ginseng (*Panax ginseng*) lowers blood concentrations of alcohol and warfarin and induces mania if used concomitantly with phenelzine (an antidepressant drug). Garlic (*Allium sativum*) decreases blood concentrations of warfarin and produces hypoglycemia (low blood sugar) when taken with chlorpropamide (blood-glucose-lowering drug). Kava (*Piper methysticum*) increases “off” periods in patients with Parkinson’s disease who take levodopa (a drug that treats Parkinson’s disease, a neurodegenerative disease affecting the muscular system) and can cause a semi-comatose state when given concomitantly with alprazolam (an anti-anxiety drug) (Izzo and Ernst, 2001). In a recent study, when healthy volunteers added St. John’s wort to a regimen of the human immunodeficiency virus (HIV) protease inhibitor indinavir, the serum level of indinavir decreased below the therapeutic concentration necessary for antiviral activity, leading to potential HIV treatment failure (Piscitelli et al., 2000). Following this report, the U.S. Food and Drug Administration (FDA) issued a public health advisory warning that St. John’s wort appears to induce cytochrome P-450 enzymes, liver enzymes responsible for the metabolism of many prescription medications, including those used to treat heart disease, depression, seizures, and cancers, or to prevent transplant rejection or pregnancy (oral contraceptives). These medications lose their therapeutic effects when given with St. John’s wort (Talalay, 2001).

Herbal medicines, including aconite, ephedra (to raise energy and lose weight), and licorice, can cause potentially serious cardiovascular adverse effects (Ernst, 2003a). Potentially serious adverse effects include myocardial infarction (heart attack), cardiac medication overdose, chest pain, congestive heart failure, hypertension (high blood pressure), hypotension (low blood pressure), excess anticoagulation, arrhythmias (heart rhythm problems), and death. These adverse effects might be due to adulteration and contamination of herbal products, toxic herbal ingredients, and herb supplement and medication interactions.

Other side effects of herbal supplements have come from anecdotal reports. The sensitizing capacity of many herbal remedies resulted in allergic contact dermatitis, including allergic sensitization or photosensitization (Niggemann and Gruber, 2003). Various herbal preparations have been associated with toxicity of the liver, kidney, and heart. For example, a Chinese herb (*Aristolochia fangchi*) that was inadvertently substituted for another Chinese herb was associated with urothelial carcinoma. Organophosphorus insecticides and heavy metals have contaminated herbal products.

Healthcare providers should be vigilant about potential interactions between herbal products and prescription medications. Any suspected interactions should be reported to the FDA’s Special Nutritionals Adverse Event Monitoring System, a searchable database with information about suspected adverse events associated with herbal supplements or nutritional products (Heck et al., 2000). This database can be accessed via the Internet at <http://vm.cfsan.fda.gov/%7Edms/aems.html>. Healthcare providers should recognize and report suspected interactions between herbal therapies and prescription medications, because this leads to the increasing of knowledge and awareness of herbal treatment and medication interactions, and ultimately, to improvement in the quality of patient care.

#### 12.4.2 Current Uses of Complementary and Alternative Medicine (CAM) Therapies

Using data from the 1996 **Medical Expenditure Panel Survey (MEPS)**, CAM use among children living in the United States was 1.8% (95% confidence interval, 1.3 to 2.3%) (Davis and Darden, 2003). The CAM use among children whose parents used CAM was 9.9%. This population-based estimate is lower than previous estimates of CAM use in children that ranged from 8 to 15% from studies in other countries or among highly selected groups, including children with chronic diseases or who attended healthcare clinics. Other studies suggest that as many as 70% of children with severe, chronic illness, such as cystic fibrosis or juvenile arthritis, utilize CAM therapies (Chambliss, 2001). Recommendations should be developed to guide pediatricians in their use of anticipatory guidance in the ambulatory care office setting. Pediatricians should be vigilant in seeking out information on CAM use during the child’s routine health maintenance visits. Pediatric oncologists are concerned that conventional and evidence-based cancer treatments might be repudiated in favor of CAM approaches that lack efficacy (Whitsett et al., 1999). Top research priorities on childhood CAM use include clinical research on the effectiveness and safety of CAM therapies and qualitative research on the consequences of CAM therapies on adherence to professional recommendations, patient–provider communication, and satisfaction with care (Adler and Showen, 1999).



Among adults in the United States, CAM therapy use is prevalent and has steadily increased since the 1950s (Kessler et al., 2001). In 1997, 67.6% of all respondents used at least one CAM therapy at some point in their lives. The continuing demand for CAM therapies will affect many facets of health-care delivery over the next 25 years (Kessler et al., 2001). With further evaluations of efficacy and effectiveness by researchers and increased physicians' discussions with patients, adverse effects should be minimized, and the use of efficacious CAM therapies should be maximized (Kessler et al., 2001).

### 12.4.3 Sources of Evidence for the Use of Alternative and Complementary Therapies

The increase in use of CAM therapies has been accompanied by a growth in research with an increase in an evidence-based approach and an increasing number of science-based randomized clinical trials being conducted on the efficacy of herbal remedies. Although some herbal remedies have shown promise, no large clinical trials to date demonstrated treatment efficacy equal to that of conventionally prescribed medications for diagnosed disease states (Ko, 1999).

The randomized controlled clinical trial has become the objective scientific standard for evaluating the efficacy of therapeutic procedures in humans (Talalay, 2001). The ultimate source of evidence is the double-blinded **randomized placebo-controlled clinical trial (RCT)** because the research subjects are randomly allocated into the treatment group and a control group that receives placebo. Appropriate randomization should result in the treatment and control groups being uniform with respect to the distribution of known and unknown characteristics, including known and unknown biases (systematic errors) and confounders (extraneous variables that can confuse any association between treatment exposure and disease outcome), except for the treatment exposure. If neither the investigators nor the study subjects know who was allocated into the treatment group or the control group, then the RCT was "double-blinded." Neither investigator nor study subject can influence, or bias, the assessment of the effect of the treatment on disease outcome. RCT study design features of particular importance include the following: an appropriate and large enough sample size to detect small effects of the treatment, uniform entry criteria for study subjects allocated to the treatment or control groups, objective measurable clinical disease end points, inclusion of placebo-controlled groups, reproducible administration of the treatment interventions (such as reproducible massage therapy techniques), and compliance by the study subjects preventing "crossing over" by patients in the placebo study arm into the treatment arm by surreptitiously taking the study supplement (Berman and Straus, 2004). The RCT is considered the "gold standard" because it provides high-quality data that have a high degree of validity and include a minimum of bias.

The methodologic quality of 207 RCTs on homeopathy, herbal medicine (*Hypericum* for depression, *Echinacea* for common cold), and acupuncture (for asthma and recurrent headache) was found to be highly variable (Linde et al., 2001). The majority of trials had problems with reporting or methodology or both, such as an inadequate method to conceal randomized allocation, or "blinding," of study subjects, and incomplete reporting on the handling of the dropout and withdrawal of study subjects. Larger trials published more recently in journals listed in Medline and published in English were of higher quality than trials not meeting these criteria (Linde et al., 2001).

Systematic reviews summarize the existing evidence from groups of RCTs. Assessing the methodologic quality of primary studies refers to aspects of study design, performance, and analysis, with a focus on randomization of the study subjects, blinding of the investigators and study subjects, and the handling of dropouts and withdrawal of study subjects (Linde et al., 2001). Herbal therapies were submitted to systematic reviews more frequently than any other CAM therapy (Ernst, 2003b).

The Cochrane reviews are an internationally known highly regarded source of evidence about the effects of healthcare interventions. Since 1996, systematic reviews prepared and maintained by the Cochrane Collaboration were published in The Cochrane Library. The Cochrane Collaboration, a loose-knit organization of experts in conducting systematic reviews who voluntarily contribute to the Collaboration, is an international attempt to develop evidence-based research guidelines about different treatment modalities. The Cochrane Library, also called The Cochrane Database of Systematic Reviews (Starr, 2003), contains more than 5000 RCTs and more than 60 systematic reviews of CAM therapies (Hughes, 2001). The Cochrane Database of Systematic Reviews, available at the Web site,

software.com/cochrane, provides high-quality information to healthcare providers and patients and those in research, teaching, funding, and administration.

The Cochrane Collaboration conducted systematic reviews of CAM modalities. Herbal medicine (phytotherapy) was identified as having potential benefit in the treatment of rheumatoid arthritis. The Cochrane Collaboration reviewers found 11 studies using five different herbal interventions (Little and Parsons, 2001). Seven studies comparing  $\gamma$ -linolenic acid (GLA) to placebo demonstrated some improvement in clinical outcomes, though the methodology and study quality were variable. The higher-quality studies suggest potential relief from pain, morning stiffness, and joint tenderness. Only one intervention (*Tripterygium wilfordii hook F*) reported serious side effects. The reviewers concluded that the evidence suggests some potential benefit for the use of GLA by patients with rheumatoid arthritis, although further studies are required to establish optimum dosage and treatment duration (Little and Parsons, 2001). Other Cochrane reviews can be found on their Web site.

Another source of evidence about CAM use is the scientific literature published in peer-reviewed journals. In a review of systematic reviews and meta-analyses (combining at least two studies giving pooled treatment effect parameters), clinical data on CAM therapies for pain from arthritis and related conditions were retrieved from review articles on herbal remedies, acupuncture, homeopathy, and selected nutritional supplements (Soeken, 2004). Some evidence exists supporting the efficacy of devil's claw, avocado/soybean unsaponifiables, and acupuncture in reducing pain from osteoarthritis. Moderate support exists for Phytodolor and topical capsaicin in reducing pain from osteoarthritis. Strong support exists for glucosamine, chondroitin sulfate, and **S-adenosylmethionine (SAM)** in reducing pain from osteoarthritis.

More data are needed about the underlying mechanism, severity, time of onset, pharmacologic activity, therapeutic efficacy, and therapeutic management of potential herbal product and prescription medication interactions. More randomized clinical trials with adequate samples sizes to detect meaningful effects on clinically relevant outcomes and adverse effects are needed.

#### 12.4.4 Current Status of the National Center for Complementary and Alternative Medicine

The mission of the **National Center for Complementary and Alternative Medicine (NCCAM)** in the **National Institutes of Health (NIH)** is to support rigorous research on CAM therapies, to train CAM researchers, and to disseminate information to the public and professionals about identifying, investigating, and validating CAM therapies, diagnostic and prevention modalities, disciplines, and systems. The NCCAM will focus on supporting clinical and basic CAM projects, awarding research training and career development grants, sponsoring conferences and operating informational clearinghouses, and integrating scientifically proven CAM practices into conventional medicine by publishing results and developing model CAM curricula for professional schools. In 2001, NCCAM supported RCTs for four dietary supplements: St. John's wort for depression, ginkgo to delay cognitive decline in Alzheimer's dementia patients, saw palmetto to relieve symptoms of benign prostate hyperplasia, and glucosamine and chondroitin sulfate to treat osteoarthritis (Nahin and Straus, 2001). In 2003, one of NCCAM's Centers of Excellence for Research studied antioxidant therapies.

#### 12.4.5 Issues for Healthcare Providers

With the high potential for adverse effects and drug interactions, clinicians should treat patients in a safe, evidence-based fashion. Because nearly 70% of patients who use alternative therapies do not inform their healthcare providers about their use of herbal products (Eisenberg et al., 1993), it is imperative that healthcare providers inquire into their patients' use of herbal treatments. Patients might be unwilling to inform their healthcare providers because of fear of disapproval (Frenkel and Ben Arye, 2001), anticipated disinterest (Adler and Showen, 1999), and the perception of lack of knowledge and understanding from their healthcare provider. Healthcare providers and their patients should proactively discuss the use or avoidance of CAM therapies. They should formally discuss patient's preferences and expectations, and in order to monitor for toxicity of CAM therapies, they should ask patients to maintain a symptom diary and see patients in follow-up visits (Eisenberg, 1997). Both patients and healthcare

providers must acknowledge that data on CAM therapy efficacy and toxicity remain incomplete, and that recommendations remain a matter of best judgment and not fact.

A practical aspect of ethical respect for patient autonomy is informed consent. Respect for patients' rights and dignity requires that informed consent be obtained before a patient participates in any clinical treatment or procedure. When circumstances permit, the patient should be told the following: (1) the diagnosis, (2) the general nature of the contemplated treatment or procedure, (3) the risks involved, (4) the benefits involved, (5) the prospect of success, (6) the prognosis if the treatment or procedure is not performed, and (7) alternative methods of treatment or procedure, if any (Bulen, 2003). The consent document, usually in written form, should lead to a meaningful exchange of information between health-care provider and patient. The healthcare provider should seek consent under circumstances that give the patient sufficient opportunity to consider whether to participate and that minimize possible coercion or undue influence. The ethical rules that healthcare providers follow in conventional care should be applied to treatment with CAM modalities. Case law regarding CAM therapies is sparse and underdeveloped (Ernst and Cohen, 2001). The ethical analysis of CAM therapies is still in its infancy.

Among 117 medical schools in the United States surveyed between 1997 and 1998, 75 (64%) medical schools offered at least one elective course in CAM or included these topics in required courses (Wetzel, Eisenberg, and Kaptchuk, 1998). These topics were frequently found in introduction to clinical medicine or patient–physician communication courses during the first or second years. Many schools included experiential visits to CAM therapy centers. Common topics included herbal therapies, chiropractic, acupuncture, homeopathy, and mind–body techniques. However, the content of CAM courses in medical school does not encourage critique and rigorous analysis and assessment of CAM therapy claims (Brokaw et al., 2002; Sampson, 2001). Of 56 courses offered in U.S. medical schools between 1995 and 1997, only 4 courses presented a critical orientation or offered critical arguments regarding advocacy arguments (Sampson, 2001).

#### 12.4.6 Regulatory, Legal, and Ethical Considerations

There is no regulatory process currently in place regarding the safety and efficacy of CAM therapies (Clark, 2000). In 1994, Congress passed the **Dietary Supplement Health and Education Act (DSHEA)** in response to a massive lobbying effort by the natural products industry (Lashof et al., 2002). Dietary supplements can be sold to the public without FDA approval. Unlike prescription medications, no animal investigations, clinical trials, or postmarketing surveillance are required before dietary supplements are marketed to the public. If dietary supplement manufacturers do not claim that the supplements treat a specific disease, then they are exempt from demonstrating the safety and efficacy of their products before marketing. The commodity nature of dietary ingredients in the absence of composition patents provides no incentive for manufacturers to conduct safety and efficacy research. The DSHEA places on the FDA not the burden of approval, but only the obligation to withdraw herbal products. The FDA relies on an inefficient voluntary reporting system for adverse events to show that a product is harmful. Recently, ephedra became an example of an herb no longer approved by the FDA for use as an herbal supplement.

Labels must identify the product as a “dietary supplement” and are required to provide information about the nutritional value of the dietary supplement in a box called “Supplement Facts.” Because the FDA does not review manufacturers' claims before marketing, this disclaimer must be made: “This statement has not been evaluated by the Food and Drug Administration. This product is not intended to diagnose, treat, cure, or prevent any disease” (Hoffman, 2001). For nonprescription products, such as dietary supplements, the FDA is responsible for product labels, while the Federal Trade Commission has oversight for advertising and promotion.

The DSHEA authorized five types of claims that are permissible on dietary supplement labels: nutritional claims, claims of well-being, health claims, nutrient content claims, and claims that the supplement affects the structure or function of the body (Hoffman, 2001). Because they are closest to the “disease” claims reserved for prescription medications, only health claims require approval by the FDA before the herbal product is marketed. It is a semantic distinction when a label claims that it “maintains a healthy cholesterol level” but cannot claim that it “lowers cholesterol,” unless the FDA accepts proof that it does lower cholesterol.

In passing DSHEA, Congress transferred from the manufacturer to the federal government the burden of proof to show that a dietary supplement is unsafe. Because dietary supplements often contain multiple ingredients that are difficult to characterize and quantify, and consumers using dietary supplements equate safety with the term “natural” and fail to consider supplements as the cause of their problem, tracking adverse events is difficult. Though manufacturers are not legally required to report adverse events from their products, the FDA encourages such reporting. In 1993, the FDA established the **Special Nutritionals Adverse Event Monitoring System (SNAEMS)**, part of the MedWatch program, to track adverse effects from dietary supplements and other special nutritional products. The FDA Center for Food Safety and Applied Nutrition maintains the SNAEMS and MedWatch databases that can be accessed at the agency’s Web site at [www.fda.gov](http://www.fda.gov) (Hoffman, 2001).

To date, the CAM practitioner has not been a major target of malpractice litigation (Doyle, 2001). In the past, CAM practitioners, especially chiropractors, were simply taken to court, found guilty of practicing medicine without a medical license, and required to stop practicing their specialty. Currently, many states have licensing requirements for CAM practitioners, including chiropractors, acupuncturists, and massage therapists (Eisenberg et al., 2002). Because licensing by state boards of CAM practitioners has increased during the 1990s, it is likely that the focus of litigation will shift to malpractice. As licensure and insurance coverage become more common, it is argued that injured patients might sue under the appropriate profession’s standard of care. An acupuncturist might be held to the standard of care expected of the reasonable acupuncturist. The courts have not yet determined whether conventional healthcare providers have a duty to inform their patients about CAM therapies, but it was argued that this duty to inform might become the basis for future malpractice (Doyle, 2001). Another possible basis for malpractice exists for conventional physicians who supervise CAM providers or refer patients to CAM providers. For conventional physicians counseling patients about CAM therapies, a theoretical framework for assessing potential malpractice liability classifies CAM therapies according to whether the evidence in the scientific literature supports, does not support, or is inconclusive for therapy use along the dimensions of safety and efficacy (Cohen and Eisenberg, 2002).

When the physician recommends, tolerates, or proscribes a CAM therapy that is in conflict with the patient’s wishes, the physician should consider the ethical obligations in providing treatment. The components of a risk–benefit framework include the severity and acuteness of the illness; the curability of the illness with conventional treatment; the degree of invasiveness, associated toxicities, and side effects of the conventional treatment; the availability and quality of evidence of efficacy and safety of the desired CAM therapy; the level of understanding of risks and benefits of the CAM therapy combined with the knowledge and voluntary acceptance of those risks by the patient; and the patient’s persistence of intention to use CAM therapies (Adams et al., 2002). Various degrees of illness, efficacy, safety, and patient choice can help guide a physician to recommend, tolerate, or proscribe CAM therapies. Use of this risk–benefit framework should result in treatment plans that fulfill the physician’s ethical obligations while simultaneously recognizing and allowing consideration of the uniqueness of each patient.

#### **12.4.7 Complementary and Alternative Medicine and Public Health**

The public health approach to CAM therapies entails a larger perspective reaching beyond national boundaries, incorporating cultural competence as an important value in primary health care (Trachtenberg, 2002). Clinical research and policy developments focus on clinical medicine, safety, efficacy, mechanisms of action, and regulatory issues. In contrast, public health research considers the social, cultural, political, and economic contexts in which CAM therapies might contribute to national healthcare systems.

The **World Health Organization (WHO)** Strategy for Traditional Medicine for 2002–2005 seeks to incorporate indigenous healers into the public health infrastructure of countries around the world (Bodeker and Kronenberg, 2002). The WHO estimates that most people living in developing countries receive much of their health care from traditional indigenous healthcare systems. The objectives of the strategy are to discuss the role of traditional nonconventional medicine in healthcare systems, current challenges and opportunities, and the WHO’s role and strategy for incorporating traditional medicine into healthcare practice. The WHO strategy focuses on four areas: policy; safety, efficacy, and quality; access; and

rational use (WHO, 2004). National policy and regulation issues include inadequate allocation of resources for CAM development and capacity building, lack of regulatory and legal mechanisms, and lack of CAM therapy integration into national healthcare systems. Safety, efficacy, and quality issues include lack of adequate regulation of herbal medicines, lack of standards, an inadequate evidence base, and inadequate support of research. Access issues include unsustainable use of medicinal plant resources, lack of data measuring access levels and affordability, and lack of cooperation between CAM providers and conventional practitioners. Rational use issues include lack of training of CAM providers, lack of communication between CAM and conventional practitioners, and lack of information on rational use of CAM therapies for the public.

Important issues in setting national and international public health priorities include equity, ethics, sustainability and integration, knowledge generation, knowledge management and utilization, and capacity building (Bodeker and Kronenberg, 2002). Equity issues concern both the availability of conventional medicine and the affordability of better-researched and expensive CAM therapies for those with little disposable income. In some developing countries, those who can afford health insurance are more likely to utilize a more regulated and safe CAM practice, while the poor might be more likely to purchase unregulated CAM drugs from unlicensed vendors. Ethical dilemmas are related to clinical research and intellectual property rights. Exploitation of traditional indigenous knowledge, such as using knowledge of indigenous plants for drug development without the consent of indigenous knowledge holders, is prohibited under international law. Sustainability and integration issues include the need for regulation of CAM practices and practitioners and the need for cost–benefit research that assesses outcomes when comparing CAM therapies to conventional therapies. The NCCAM research approach is viewed internationally as the knowledge generation model for conducting scientific CAM research. Knowledge management and utilization issues demand free access to comprehensive information resources on CAM therapies. Capacity building includes investing in professionals who will become leaders and in educational CAM training programs. Strengthening capacity can be attained through more research in safety, efficacy, standardization, current utilization, cost-effectiveness, customer satisfaction, priority diseases, disease prevention, well-being, and quality of life.

As national governments begin to address the issues needed to ensure the safety and efficacy of CAM therapies, a public-health agenda should be developed. This agenda should include an awareness of social, cultural, and political issues and should address values (equity and ethics), sustainability (regulation, financing, knowledge generation, knowledge management, and capacity building), and the research environment (Bodeker and Kronenberg, 2002). This strategy is required if complementary and alternative medicine is to have a significant role in national healthcare systems.

---

## 12.5 Conclusions

In this chapter, we learned how correct Hippocrates was when he said: ***“Let food be thy medicine and medicine be thy food.”*** This being so, a word of caution must be made. Today, “pharmafoods,” or genetically engineered food crops, like corn (*Zea mays*), are being produced by corporate agribusiness companies. In these food crops, genes from animal or microbial sources are inserted into the genomes of the host food crop plants to produce vaccines/immunochemicals, pesticides, and even plastics. While many of these altered traits are very beneficial to most people, some people who eat such foods may suffer possible adverse allergic reactions. Carl Li’s well-documented, balanced account in this chapter about the risks of CAM (complementary and alternative medicine) therapies, including the need to know the risks as well as the benefits associated with the use of plants as herbal medicines, rings true here. Not all food plants should be used as medicines if they could cause potential harm to humans. The **precautionary principle** is one that we should follow, where there is zero risk tolerance.

---

## References

- Adams, K.E., M.H. Cohen, D. Eisenberg, and A.R. Jonsen. (2002). Ethical considerations of complementary and alternative medical therapies in conventional medical settings. *Ann Intern Med* 137: 660–664.
- Adler, S.R. and N.C. Showen. (1999). Pediatric complementary and alternative medicine use: physician–patient communication is vital. *West J Med* 171: 158.
- Aggarwal, B.B., Y. Takada, and O.V. Oommen. (2004). From chemoprevention to chemotherapy: common targets and common goals. *Expert Opin Invest Drugs* 13: 1327–1338.
- Bagchi D., C.K. Sen, M. Bagchi, and M. Atalay. (2004). Anti-angiogenic, antioxidant, and anti-carcinogenic properties of a novel anthocyanin-rich berry extract formula. *Biochemistry (Mosc)* 69: 75–80.
- Barnes, S., M. Kirk, and L. Coward. (1994). Isoflavones and their conjugates in soy foods: extraction conditions and analysis by HPLC-mass spectrometry. *J Agric Food Chem* 42: 2466–2474.
- Berman, J.D. and S.E. Straus. (2004). Implementing a research agenda for complementary and alternative medicine. *Annu Rev Med* 55: 239–254.
- Bodeker, G. and F. Kronenberg. (2002). A public health agenda for traditional, complementary, and alternative medicine. *Am J Public Health* 92: 1582–1591.
- Bomser, J.A., D.L. Madhavi, K. Singletary, and M.A. Smith. (1995). Induction of NAD(P)H: (quinone-acceptor) oxido-reductase in murine hepatoma cells (Hepa 1c1c7) by fruit (*Vaccinium*) extracts. *FASEB J* 9: A993.
- Bomser, J., D.L. Madhavi, K. Singletary, and M.A. Smith. (1996). *In vitro* anticancer activity of fruit extracts from *Vaccinium* species. *Planta Med* 62: 311–322.
- Botta, B., G. Dell Monache, D. Misiti, A. Vitali, and G. Zappia. (2001). Aryltetralin lignans: chemistry, pharmacology and biotransformations. *Curr Med Chem* 8: 1363–1381.
- Brokaw, J.J., G. Tunnicliff, B.U. Raess, and D.W. Saxon. (2002). The teaching of complementary and alternative medicine in U.S. medical schools: a survey of course directors. *Acad Med* 77: 876–881.
- Buchanan, B.B., W. Gruissem, and R.L. Jones. (2000). *Biochemistry and Molecular Biology of Plants*. American Society of Plant Physiology, Rockville, Maryland.
- Bulen, J.A., Jr. (2003). Greenwall Bioethics Award. Complementary and Alternative Medicine. Ethical and legal aspects of informed consent to treatment. *J Leg Med* 24: 331–358.
- Casadesus, G., B. Shukitt-Hale, H.M. Stellwagen, X. Zhu, H.G. Lee, M.A. Smith, and J.A. Joseph. (2004). Modulation of hippocampal plasticity and cognitive behavior by short-term blueberry supplementation in aged rats. *Nutr Neurosci* 7: 309–316.
- Cassileth, B.R. (1999). Evaluating complementary and alternative therapies for cancer patients. *CA Cancer J Clin* 49: 362–375.
- Centers for Disease Control and Prevention. (1995a). Anticholinergic poisoning associated with an herbal tea — New York City, 1994. *MMWR Morb Mortal Wkly Rep* 44: 193–195.
- Centers for Disease Control and Prevention. (1995b). Self-treatment with herbal and other plant-derived remedies — rural Mississippi, 1993. *MMWR Morb Mortal Wkly Rep* 44: 204–207.
- Centers for Disease Control and Prevention. (1996). Infection with *Mycobacterium abscessus* associated with intramuscular injection of adrenal cortex extract — Colorado and Wyoming, 1995–1996. *MMWR Morb Mortal Wkly Rep* 45: 713–715.
- Chambliss, L.R. (2001). Alternative and complementary medicine: an overview. *Clin Obstet Gynecol* 44: 640–652.
- Chatterjee, A., T. Yasmin, D. Bagchi, and S.J. Stohs. (2004). Inhibition of *Helicobacter pylori* *in vitro* by various berry extracts, with enhanced susceptibility to clarithromycin. *Mol Cell Biochem* 265: 19–26.
- Cignarella, A., M. Nastasi, E. Cavalli, and L. Puglisi. (1996). Novel lipid-lowering properties of *Vaccinium myrtillus* L. leaves, a traditional antidiabetic treatment, in several models of rat dyslipidaemia: a comparison with ciprofibrate. *Thromb Res* 84: 311–322.
- Clark, P.A. (2000). The ethics of alternative medicine therapies. *J Public Health Policy* 21: 447–470.
- Cohen, M.H. and D.M. Eisenberg. (2002). Potential physician malpractice liability associated with complementary and integrative medical therapies. *Ann Intern Med* 136: 596–603.
- Conrick, J. (2001). *Neem: The Ultimate Herb*. Lotus Press, Twin Lakes, Wisconsin.
- Cronisti, A., S. Malandrino, and M.J. Magistretti. (1989). Effect of a natural flavonoid on gastric mucosal barrier. *Arzneimittelforschung* 39: 590–592.

- Das, D.K. (1994). Naturally occurring flavonoids: structure, chemistry, and high-performance liquid chromatography methods for separation and characterization. *Methods Enzymol* 234: 410–420.
- Davis, M.P. and P.M. Darden. (2003). Use of complementary and alternative medicine by children in the United States. *Arch Pediatr Adolesc Med* 157: 393–396.
- Dayanandan, P. and J. Ponsamuel. (2000). Ultrastructure of terpenoid secretory cells of neem (*Azadirachta indica* A. Juss.). In *Electron Microscopy in Medicine and Biology*, P.D. Gupta and H. Yamamoto (Eds.). Oxford & I.B.H. Publishing Co., New Delhi, India.
- Dixon, R.A. and N.L. Paiva. (1995). Stress-induced phenylpropanoid metabolism. *Plant Cell* 7: 1085–1097.
- Doyle, A. (2001). Alternative medicine and medical malpractice. Emerging issues. *J Leg Med* 22: 533–552.
- Duffy, S.J. and J.A. Vita. (2003). Effects of phenolics on vascular endothelial function. *Curr Opin Lipidol* 14: 21–27.
- Duke, J.A. (1981). *Handbook of Legumes of World Economic Importance*. Plenum Press, New York.
- Edenharder, R., P. Kurz, K. John, S. Burgard, and K. Seeger. (1994). *In vitro* effect of vegetable and fruit juices on the mutagenicity of 2-amino-3-methylimidazo[4,5-f]quinoline, 2-amino-3,4-dimethylimidazo[4,5-f]quinoline and 2-amino-3,8-dimethylimidazo[4,5-f]quinoxaline. *Food Chem Toxicol* 32: 443–459.
- Eisenberg, D.M. (1997). Advising patients who seek alternative medical therapies. *Ann Intern Med* 127: 61–69.
- Eisenberg, D.M., R.C. Kessler, C. Foster, F.E. Norlock, D.R. Calkins, and T.L. Delbanco. (1993). Unconventional medicine in the United States. Prevalence, costs, and patterns of use. *N Engl J Med* 328: 246–252.
- Eisenberg, D.M., M.H. Cohen, A. Hrbek, J. Grayzel, M.I. Van Rompay, and R.A. Cooper. (2002). Credentialing complementary and alternative medical providers. *Ann Intern Med* 137: 965–973.
- Ernst, E. (2003a). Cardiovascular adverse effects of herbal medicines: a systematic review of the recent literature. *Can J Cardiol* 19: 818–827.
- Ernst, E. (2003b). Complementary medicine: where is the evidence? *J Fam Pract* 52: 630–634.
- Ernst, E. and M.H. Cohen. (2001). Informed consent in complementary and alternative medicine. *Arch Intern Med* 161: 2288–2292.
- Ferguson, P.J., E. Kurowska, D.J. Freeman, A.F. Chambers, and D.J. Koropatnick. (2004). A flavonoid fraction from cranberry extract inhibits proliferation of human tumor cell lines. *J Nutr* 134: 1529–1535.
- Foo, L.Y., Y. Lu, A.B. Howell, and N. Vorsa. (2000). A-Type proanthocyanidin trimers from cranberry that inhibit adherence of uropathogenic P-fimbriated *Escherichia coli*. *J Nat Prod* 63: 1225–1228.
- Frenkel, M. and E. Ben Arye. (2001). The growing need to teach about complementary and alternative medicine: questions and challenges. *Acad Med* 76: 251–254.
- Geller, J., L. Sionit, C. Partido, L. Li, X. Tan, T. Youngkin, D. Nachtshein, and R.M. Hoffman. (1998). Genistein inhibits the growth of human-patient BPH and prostate cancer in histoculture. *Prostate* 34: 75–79.
- Gruenwald, J. (Ed.). (2004). *PDR for Herbal Medicines*. Medical Economics Company, Montvale, New Jersey.
- Gu, L., M.A. Kelm, J.F. Hammerstone, G. Beecher, J. Holden, D. Haytowitz, S. Gebhardt, and R.L. Prior. (2004). Concentrations of proanthocyanidins in common foods and estimations of normal consumption. *J Nutr* 134: 613–617.
- Heck, A.M., B.A. DeWitt, and A.L. Lukes. (2000). Potential interactions between alternative therapies and warfarin™. *Am J Health Syst Pharm* 57: 1221–1227; quiz 1228–1230.
- Heinonen, M., A.S. Meyer, and E.N. Frankel. (1998). Antioxidant activity of berry phenolics on human low-density lipoprotein and liposome oxidation. *J Agric Food Chem* 46: 4107–4112.
- Hoffman, F.A. (2001). Regulation of dietary supplements in the United States: understanding the dietary supplement health and education act. *Clin Obstet Gynecol* 44: 780–788.
- Howell, A.B. (2002). Cranberry proanthocyanidins and the maintenance of urinary tract health. *Crit Rev Food Sci Nutr* 42: 273S–278S.
- Hubbard, G.P., J.M. Stevens, M. Cicmil, T. Sage, P.A. Jordan, C.M. Williams, J.A. Lovegrove, and J.M. Gibbins. (2003a). Quercetin inhibits collagen-stimulated platelet activation through inhibition of multiple components of the glycoprotein VI signaling pathway. *J Thromb Haemost* 1: 1079–1088.
- Hubbard, G.P., S. Wolfram, J.A. Lovegrove, and J.M. Gibbins. (2003b). The role of polyphenolic compounds in the diet as inhibitors of platelet function. *Proc Nutr Soc* 62: 469–478.
- Hughes, E.F. (2001). Integrating complementary and alternative medicine into clinical practice. *Clin Obstet Gynecol* 44: 902–906.
- Izzo, A.A. and E. Ernst. (2001). Interactions between herbal medicines and prescribed drugs: a systematic review. *Drugs* 61: 2163–2175.

- Jaakola, L., K. Maatta-Riihinen, S. Karenlampi, and A. Hohtola. (2004). Activation of flavonoid biosynthesis by solar radiation in bilberry (*Vaccinium myrtillus* L.) leaves. *Planta* 218: 721–728.
- Jayaprakasam, B., S.K. Vareed, L.K. Olson, and M.G. Nair. (2005). Insulin secretion by bioactive anthocyanins and anthocyanidins present in fruits. *J Agric Food Chem* 53: 28–31.
- Joseph, J.A. (2004). Modulation of hippocampal plasticity and cognitive behavior by short-term blueberry supplementation in aged rats. *Nutr Neurosci* 7: 309–316.
- Joseph, J.A., B. Shukitt-Hale, and G. Casadesus. (2005). Reversing the deleterious effects of aging on neuronal communication and behavior: beneficial properties of fruit polyphenolic compounds. *Am J Clin Nutr* 81: 313S–316S.
- Katsube, N., K. Iwashita, T. Tsushida, K. Yamaki, and M. Kobori. (2003). Induction of apoptosis in cancer cells by bilberry (*Vaccinium myrtillus*) and the anthocyanins. *J Agric Food Chem* 51: 68–75.
- Kessler, R.C. et al. (2001). The use of complementary and alternative therapies to treat anxiety and depression in the United States. *Am J Psychiatry* 158: 289–294.
- Keung, W.M., O. Lazo, L. Kunze, and B.L. Vallee. (1995). Daidzin suppresses ethanol consumption by Syrian Golden hamsters without blocking acetaldehyde metabolism. *Proc Natl Acad Sci USA* 92: 8990–8993.
- Keung, W.M. (Ed.). (2002). *Pueraria*. Taylor & Francis, New York.
- Ko, R. (1999). Adverse reactions to watch for in patients using herbal remedies. *West J Med* 171: 181–186.
- Koes, R., W. Verweij, and F. Quattrocchio. (2005). Flavonoids: a colorful model for the regulation and evolution of biochemical pathways. *Trends in Plant Sci* 10: 236–242.
- Koul, O. and S. Wahab (Eds.). (2004). *Neem: Today and in the New Millennium*. Kluwer Academic Publishers, Dordrecht, The Netherlands.
- Kroon, P.A., M.N. Clifford, A. Crozier, A.J. Day, J.L. Donovan, C. Manach, and G. Williamson. (2004). How should we assess the effects of exposure to dietary polyphenols *in vitro*? *Am J Clin Nutr* 80: 15–21.
- Lashof, J.C., S. Margen, and J.E. Swartzberg. (2002). Regulating natural health products. *Science* 296: 46–47.
- Li, Y., S. Upadhyay, M. Bhuiyan, and S.H. Sarkar. (1999). Induction of apoptosis in breast cancer cells MDA-MB-231 by genistein. *Oncogene* 18: 3166–3172.
- Lietti, A. (1976). Studies on *Vaccinium myrtillus* anthocyanosides, I: vasoprotective and anti-inflammatory activity. *Arzneimittelforschung* 26: 829–832.
- Lin, R.C., S. Guthrie, C.-I. Xie et al. (1996). Isoflavonoid compounds extracted from *Pueraria lobata* suppress alcohol preference in a pharmacogenic rat model for alcoholism. *Alcohol Clin Exp Res* 20: 659–663.
- Linde, K., W.B. Jonas, D. Melchart, and S. Willich. (2001). The methodological quality of randomized controlled trials of homeopathy, herbal medicines and acupuncture. *Int J Epidemiol* 30: 526–531.
- Little, C. and T. Parsons. (2001). Herbal therapy for treating rheumatoid arthritis. *Cochrane Database Syst Rev* 1: CD002948.
- Logan, A.C. and C. Wong. (2001). Chronic fatigue syndrome: oxidative stress and dietary modifications. *Altern Med Rev* 6: 450–459.
- Lu, X.R., S.M. Chen, and T. Sun. (1980). Study of  $\beta$ -adrenergic receptor blocking effect of extractum of root *Pueraria hirsute*. *Acta Pharmacol Sin* 15: 218–222.
- Lukas, S.E., L.H. Lundahl, M. Lachance, S. Duggan, M. Stull, and D.Y. Lee. (1999). The Chinese herb, kudzu, alters ethanol effects in male and female subjects. *The College on the Problems of Drug Dependence*, Acapulco, Mexico.
- Manach, C., A. Scalbert, C. Morand, C. Remesy, and L. Jimenez. (2004). Polyphenols: food sources and bioavailability. *Am J Clin Nutr* 79: 727–747.
- Mazza, G. and B.D. Oomah. (2000). *Herbs, Botanicals, and Teas as Functional Foods and Nutraceuticals*, Technomic, Lancaster, Pennsylvania.
- McGhie, T.K., G.D. Ainge, L.E. Barnett, J.M. Cooney, and D.J. Jensen. (2003). Anthocyanin glycosides from berry fruit are absorbed and excreted unmetabolized by both humans and rats. *J Agric Food Chem* 51: 4539–4548.
- McKenzie, M.A. (2004). [www.denali-biotechnologies.com](http://www.denali-biotechnologies.com).
- Messina, M., V. Persky, K.D.R. Setchell, and S. Barnes. (1994). Soy intake and cancer risk: a review of the *in vitro* and *in vivo* data. *Nutr Cancer* 21: 113–131.
- Middleton, E. Jr., C. Kandaswami, and T.C. Theoharides. (2000). The effects of plant flavonoids on mammalian cells: implications for inflammation, heart disease, and cancer. *Pharmacol Rev* 52: 673–751.
- Miller, K.L., R.S. Liebowitz, and L.K. Newby. (2004). Complementary and alternative medicine in cardiovascular disease: a review of biologically based approaches. *Am Heart J* 147: 401–411.



- Murphy, B.T., S.L. MacKinnon, X. Yan, G.B. Hammond, A.J. Vaisberg, and C.C. Neto. (2003). Identification of triterpene hydroxycinnamates with *in vitro* antitumor activity from whole cranberry fruit (*Vaccinium macrocarpon*). *J Agri Food Chem* 51: 3541–3545.
- Nahin, R.L. and S.E. Straus. (2001). Research into complementary and alternative medicine: problems and potential. *Brit Med J* 322: 161–164.
- National Research Council. (2002). *Neem: A Tree for Solving Global Problems*. (Noel Vietmeyer, Ed.). National Academy Press, Washington, D.C.
- Neem. (2004). *Neem — A Medical Dictionary, Bibliography, and Annotated Research Guide to Internet References*. Icon Health Publications, San Diego, California.
- Niggemann, B. and C. Gruber. (2003). Side-effects of complementary and alternative medicine. *Allergy* 58: 707–716.
- Norten, E. (1999). *Neem: India's Miraculous Healing Plant*. J. Putz (Ed.). Healing Arts Press. Rochester, Vermont.
- Petlevski, R., M. Hadzija, M. Slijepcevic, D. Juretic, and J. Petrik. (2003). Glutathione S-transferases and malondialdehyde in the liver of NOD mice on short-term treatment with plant mixture extract P-9801091. *Phytother Res* 17: 311–314.
- Piscitelli, S.C., A.H. Burstein, D. Chaitt, R.M. Alfaro, and J. Falloon. (2000). Indinavir concentrations and St. John's wort. *Lancet* 355: 547–548.
- Prior, R.L. (2003). Fruits and vegetables in the prevention of cellular oxidative damage. *Am J Clin Nutr* 78: 570S–578S.
- Prior, R.L., G. Cao, A. Martin, E. Sofic, J. McEwen, C. O'Brien, N. Lischner, M. Ehlenfeldt, W. Kalt, G. Krewer, and C.M. Mainland. (1998). Antioxidant capacity as influenced by total phenolic and anthocyanin content, maturity, and variety of *Vaccinium* species. *J Agric Food Chem* 46: 2686–2693.
- Prior, R.L., S.A. Lazarus, G. Cao, H. Muccitelli, and J.F. Hammerstone. (2001). Identification of procyanidins and anthocyanins in blueberries and cranberries (*Vaccinium* spp.) using high-performance liquid chromatography/mass spectrometry. *J Agric Food Chem* 49: 1270–1276.
- Puri, H.S. (1999). *Neem: The Divine Tree*, *Azadirachta indica*. (Medicinal and Aromatic Plants, Industrial Profiles). CRC Press, Boca Raton, Florida.
- Reed, J. (2002). Cranberry flavonoids, atherosclerosis and cardiovascular health. *Crit Rev Food Sci Nutr* 42: 301–316.
- Rezvani, A.H. et al. (2003). Plant derivatives in the treatment of alcohol dependency. *Pharmacol Biochem and Behav* 75: 593–606.
- Rimando, A.M., W. Kalt, J.B. Magee, J. Dewey, and J.R. Ballington. (2004). Resveratrol, pterostilbene, and piceatannol in *Vaccinium* berries. *J Agric Food Chem* 52: 4713–4719.
- Sampson, W. (2001). The need for educational reform in teaching about alternative therapies. *Acad Med* 76: 248–250.
- Schmidt, B.M., A.B. Howell, B. McEniry, C.T. Knight, D. Seigler, J.W. Erdman, Jr., and M.A. Lila. (2004). Effective separation of potent antiproliferation and antiadhesion components from wild blueberry (*Vaccinium angustifolium* Ait.) fruits. *J Agric Food Chem* 52: 6433–6442.
- Schmutterer, H. (Ed.). (1995). *The Neem Tree, Source of Unique Natural Products for Integrated Pest Management, Medicine, Industry and Other Purposes*. VCH Publishers, Weinheim, Germany.
- Seeram, N.P., R.A. Momin, M.G. Nair, and L.D. Bourquin. (2001). Cyclooxygenase inhibitory and antioxidant cyanidin glycosides in cherries and berries. *Phytomedicine* 8: 362–369.
- Sellappan, S., C.C. Akoh, and G. Krewer. (2002). Phenolic compounds and antioxidant capacity of Georgia-grown blueberries and blackberries. *J Agric Food Chem* 50: 2432–2438.
- Singh, R.P. and R.C. Saxena. (1999). *Azadirachta indica* A. Juss. Science Publishers, Enfield, New Hampshire.
- Singh, R.P., M.S. Chari, A.K. Raheka, and W. Kraus. (Eds.). (1996). *Neem and Environment*. Vols. I and II. Oxford & I.B.H. Publishing, New Delhi, India.
- Soeken, K.L. (2004). Selected CAM therapies for arthritis-related pain: the evidence from systematic reviews. *Clin J Pain* 20: 13–18.
- Starr, M.C.I. (2003). The evolution of The Cochrane Library, 1988–2003. Update software: Oxford ([www.update-software.com/history/clibhist.htm](http://www.update-software.com/history/clibhist.htm)). Accessed 23 March 2004.
- Steinberg, D., M. Feldman, I. Ofek, and E.I. Weiss. (2005). Cranberry high molecular weight constituents promote *Streptococcus sobrinus* desorption from artificial biofilm. *Int J Antimicrob Agents* 25: 247–251.

- Talalay, P. (2001). The importance of using scientific principles in the development of medicinal agents from plants. *Acad Med* 76: 238–247.
- Taruscio, T.G., D.L. Barney, and J. Exon. (2004). Content and profile of flavanoid and phenolic acid compounds in conjunction with the antioxidant capacity for a variety of Northwest *Vaccinium* berries. *J Agric Food Chem* 52: 3169–3176.
- Tewari, D.N. (1992). *Monograph on Neem (Azadirachta indica A. Juss.)*. International Book Distributors, Dehra Dun, India.
- The American Society for Clinical Nutrition. (2005). Proceedings of the First International Conference on Polyphenols and Health. *Am J Clin Nutr* 81: 215S–335S.
- Thorne Research, Inc. (2001). Monograph, *Vaccinium myrtillus* (bilberry). *Altern Med Rev* 6: 500–504.
- Trachtenberg, D. (2002). Alternative therapies and public health: crisis or opportunity? *Am J Public Health* 92: 1566–1567.
- Tunon, H., C. Olavsdotter, and L. Bohlin. (1995). Evaluation of anti-inflammatory activity of some Swedish medicinal plants. Inhibition of prostaglandin biosynthesis and PAF-induced exocytosis. *J Ethnopharmacol* 48: 61–76.
- VDF FutureCeuticals, Inc. (2003). [www.futureceuticals.com](http://www.futureceuticals.com).
- Werneke, U., J. Earl, C. Seydel, O. Horn, P. Crichton, and D. Fannon. (2004). Potential health risks of complementary alternative medicines in cancer patients. *Br J Cancer* 90: 408–413.
- Wetzel, M.S., D.M. Eisenberg, and T.J. Kaptchuk. (1998). Courses involving complementary and alternative medicine at US medical schools. *JAMA* 280: 784–787.
- Whitsett, S.F., R. Anderson, and M.J. Coppes. (1999). Why are children with cancer being exposed to complementary medicine? *West J Med* 171: 150–151.
- Williams, R.J., J.P. Spencer, and C. Rice-Evans. (2004). Flavonoids: antioxidants or signalling molecules? *Free Radic Biol Med* 36: 838–849.
- Williamson, G. (2003). Common features in the pathways of absorption and metabolism of flavonoids. In *Phytochemicals: Mechanisms of Action*, M.S. Meskin, W.R. Bidlack, A.J. Davies, D.S. Lewis, and R.K. Randolph (Eds.). CRC Press, Boca Raton, Florida, pp. 21–33.
- World Health Organization. (2004). Traditional medicine. [www.who.int/medicines/organization/trm/orgtrm-main.shtml](http://www.who.int/medicines/organization/trm/orgtrm-main.shtml) (accessed March 24, 2004).
- Yamanaka, A., R. Kimizuka, T. Kato, and K. Okuda. (2004). Inhibitory effects of cranberry juice on attachment of oral streptococci and biofilm formation, *Oral Microbiol Immunol* 19: 150–154.
- Youdim, K.A., J. McDonald, W. Kalt, and J.A. Joseph. (2002). Potential role of dietary flavonoids in reducing microvascular endothelium vulnerability to oxidative and inflammatory insults. *J Nutr Biochem* 13: 282–288.
- Zeng, G.Y., Y.P. Zhoe, L.Y. Zhang, and L.L. Fan. (1974). Effects of kudzu (*Radix pueraria*) on blood pressure, reaction ability of blood vessel, cerebral and peripheral circulation in dog. *Chin Med J* 4: 265–257.
- Zhao, C., M.M. Giusti, M. Malik, M.P. Moyer, and B.A. Magnuson. (2004). Effects of commercial anthocyanin-rich extracts on colonic cancer and non-tumorigenic colonic cell growth. *J Agric Food Chem* 52: 6122–6128.



# 13

---

## *The Synergy Principle at Work with Plants, Pathogens, Insects, Herbivores, and Humans*

---

Kevin Spelman, James A. Duke, and Mary Jo Bogenschutz-Godwin

### CONTENTS

13.1 Introduction .....	475
13.2 Is Synergic Activity between Plant Metabolites an Evolutionary Strategy?.....	476
13.3 Clinical Medicine Learns from Nature's Cocktails.....	478
13.4 Plants as "Medicinal Cocktails" .....	479
13.5 Examples of Synergy .....	481
13.5.1 Antimalarial Compounds .....	481
13.5.2 Anthraquinones + Antioxidant Nutrients.....	482
13.5.3 Antibacterial Compounds.....	482
13.5.4 Antiedemic Compounds.....	483
13.5.5 Antifeedant Compounds.....	483
13.5.6 Antioxidant Panaceas .....	484
13.5.7 Anticholinergic Effects .....	485
13.5.8 Antiulcer Activities .....	486
13.5.9 Calcium Antagonists .....	487
13.5.10 <i>Catharanthus roseus</i> (L.) .....	487
13.5.11 Flavonoids .....	487
13.5.12 Fungicides .....	489
13.5.13 Garlic ( <i>Allium sativum</i> L.).....	489
13.5.14 Goitrogens .....	490
13.5.15 <i>Hypericum</i> .....	490
13.5.16 Hypertension .....	492
13.5.17 <i>Melissa</i> .....	492
13.5.18 Duke on Dragon's Blood .....	493
13.5.19 Duke's Plea for Reason: Malaria, Politics, Economics, and a Simple Plant .....	494
13.6 Conclusions .....	495
References .....	497

---

### 13.1 Introduction

Medicinal plants may never be completely understood by analyzing their component parts. Proponents of medicinal plants argue that their properties come from the interactions of multiple constituents (Kliger, 2004; Thoison et al., 2004). These interactions, in the case of medicinal plants, are known to some as **chemical synergy**. In our definition, chemical synergy exists when the action of many chemicals is greater than the arithmetical sum of the actions of individual components. Such concepts are in direct opposition to reductionist science, particularly the principle of **parsimony**, also known as **Ockham's Razor**, which states that it is futile to do with more, with what can be done with less. Few scientists

realize, however, that this principle is inherited from seventeenth century theology (Hoffman et al., 1997). Moreover, the simple modeling invoked by Ockham's Razor disallows for more complex models, such as synergy, which may delay the progress of science.

The isolation of single constituents from natural products is a classic example of simplistic modeling, and only recently has it become possible to study whole biochemical pathways leading to product synthesis (see Chapters 5 and 6). The pharmaceutical industry has thrived on purifying compounds from plant sources. In 1999, half of the top 20 best-selling drugs were derived from natural products, amounting to \$16 billion in sales (Tulp and Bohlin, 2002). Fifty percent of the new drugs in the last decades were isolated from plants (Tulp and Bohlin, 2002). Additionally, 25% of drugs prescribed are still directly isolated from plants (Cott, 1995). However, these compounds were not originally extracted and purified in the modern pharmaceutical method. Rather, they were used in whole plant form. This chemically complex, low-cost, traditional use of plants stands in stark contrast to the expensive, yet simplistic, pharmaceutical methodology of identification and isolation of single constituents.

The pharmacological tenets of selectivity, potency, and acceptable toxicity rest on the principle of parsimony, which embraces simplicity and frugality — using a single purified chemical over the complex chemical mixture found in plants. We predict that this will change in time due to the increasing reports from laboratories around the world of numerous chemicals exhibiting **synergic activity**. **Synergy** is perhaps an antonym of **antagonism**, the interaction of two or more agents such that the combined effect is less than the sum of the expected individual effects. Such phenomena allow for the subtleties of multiple low-level pharmacological perturbations. Such intricacies will require more complex modeling (and technology) to fully comprehend.

Synergy and antagonism defy the expected Cartesian result of additive activity, where the effect of two or more agents combined is exactly the sum of their individual effects. Such parsimony is rarely observed in the natural world, although in attempts to describe mechanisms, Ockham's Razor, in the nimble fingers of a scientist, often frugally cuts away all but the most obvious phenomena. However, the intricacy of biological and chemical processes clearly illuminated suggests that nature is anything but parsimonious.

---

### 13.2 Is Synergic Activity between Plant Metabolites an Evolutionary Strategy?

Many of the major metabolites present in a given plant are important for the fitness of the plant (Firm and Jones, 2000; Papadopoulou et al., 1999; Wink, 2003). Plants lacking **phytoalexins** (allelochemicals that upregulate in response to microbial invasion) become sensitive to a range of pathogens (Papadopoulou et al., 1999). For example, mutant oats that lack the **phytoalexin saponin avenacin A-1** become sensitive to many fungal disorders (Papadopoulou et al., 1999). **Allelochemicals** clearly provide protection against microbes, insects, and herbivores (Firm and Jones, 2000; Papadopoulou et al., 1999; Wink, 2003). See the essay below for an illustration of allelochemical activity.

---

#### Essay on Synergy between Allelochemicals

The genus *Nothofagus* Bl. (Fagaceae) makes up the primary forest cover in New Zealand and Chile. Due to its propagative success and wide distribution, *Nothofagus*'s allelochemical activity against the larvae of leafrollers was studied. The antifeedant activity of the species *N. alessandri* of Chile and *N. fusca* of New Zealand was shown to be due to the presence of two compounds, pinosylvin and galangin, a stilbene and a flavonoid, respectively. Individually, these compounds did not show antifeedant activity, but as a mixture, they worked in concert to provide antifeedant activity.

Further study was conducted with *N. dombeyi* and *N. pumilio*, both Chilean species, against the larvae of leafrollers. Thoison et al. (2004) found that the majority of ten

compounds did not demonstrate antifeedant activity in the model utilized. However, mixtures of the studied compounds, such as a matrix of **triterpenes** and **flavonoids**, were found to be highly active and were suggested to be responsible for the generalized resistance toward insect feeding that this long-lived species exhibits.

---

In the case of oats and perhaps other plants without (or low in) phytoalexins, the paucity of plant protective metabolites could be the difference between a successful evolutionary history and failure. For example, consider a hypothetical species with a succulent edible leaf with a well-balanced array of amino acids, fatty acids, minerals, vitamins, and other important, if not essential, nutrients. If this plant species has no distasteful antinutrient or harmful compounds in it, the likelihood of survival is reduced. We will name this plant “Tasty Leaf.” Although there are no such plants, bland head lettuce comes close. We like it. So do a lot of microbes and herbivores.

Evolutionarily, our relatively defenseless plant has little chance to survive without “distasteful” allelochemicals. It is more likely to be devoured without reproducing itself. For such a plant species to survive millions of years of evolution, it would fare far better producing some sort of deterrent to feeding. If one of Tasty Leaf’s salubrious amino acids, due to environmental stress, led to a distasteful **alkaloidal allelochemical**, we would now have an incipient species — let us call this plant “Bitter Leaf.” This new alkaloid, Alkaloid 1, repels the feeding species. Tasty Leaf’s future becomes dimmer, while distasteful Bitter Leaf is environmentally selected. Bitter Leaf continues to genetically drift, and further shifts to the genome occur. As a result, perhaps through “catalytic flexibility” (see Box 13.2), Bitter Leaf may now produce Alkaloid 2, and even Alkaloid 3 — both distasteful. If Alkaloids 1, 2, and 3 are antagonistic as allelochemicals, Bitter Leaf’s fitness is reduced. If the alkaloids are additive, Bitter Leaf’s fitness is improved. And if the alkaloids are synergic, fitness is significantly improved. In this scenario, Bitter Leaf’s evolutionary history is much brighter if the mixture of alkaloids is synergic, thus enhancing its adaptive traits, a seemingly logical path in evolution.

But how realistic is the above scenario? Gene–environment interaction was described as context dependent (Cooper, 2003). In many situations, the actions of genes are known to be modified by environmental conditions (Cooper, 2003). Therefore, plant response to hungry grazers in a given environment could select for traits that enhance the generation and retention of chemical diversity (Firn and Jones, 2000) and could be key to survival (Papadopoulou et al., 1999).

Chemically diverse metabolites in plants, modified by natural selection during evolution, occur in diverse mixtures of several structural types (Firn and Jones, 2000; Papadopoulou et al., 1999; Wink, 2003). Slight variations in similar molecules, perhaps described as a protective chemical overlap, can be seen as the evolutionary development of a chemical economy — a network of protection. This type of strategy could prove highly adaptive. One study of **sesquiterpene** synthesis in plants demonstrated that one enzyme produced 34 different compounds from a single substrate, and another enzyme produced 52 products from a single precursor (Steele et al., 1998). Such **catalytic flexibility** is likely to yield products with multiple functionalities and bioactivities. And even if the individual interaction of a particular plant metabolite might be unspecific and weak, the sum of numerous metabolite interactions can lead to a substantial effect (Wink, 2003). See the essay below for further illustration of this concept.

---

### Essay on Evolution of an Economy of Chemistry: Catalytic Flexibility

An emerging view of enzymes expands the previous model of one substrate to one enzyme generating one product. Biosynthetic diversity, the various molecules that plants produce, is generated using relatively conserved enzymatic mechanisms. “Catalytic flexibility” is being demonstrated by enzymes such as **chalcone synthase**, a polyketide synthase that is the first to be characterized in molecular detail. This enzyme, utilizing **4-coumaroyl CoA** with three molecules of **malonyl CoA**, catalyzes the production of **naringenin chalcone**, a parent compound of the plant flavonoids.

However, with an alternative folding pattern of the peptides that make up this polyketide synthase, a reshaping of sorts, the enzyme can now produce resveratrol, a stilbene, and a broad-spectrum phytoalexin. Additionally, the **polyketide synthases** can utilize various starter molecules yielding various metabolites such as benzalacetones, acridones, styrylpyrones, and benzophenones.

The **cytochrome P450** enzymes are known to be “flexible” in their ability to act on different starter molecules. An example of this is the biosynthesis in *Sorghum bicolor* of dhurrin, an antiherbivore cyanogenic glycoside. The starting substrate for dhurrin formation is L-tyrosine, which in the first six reactions of the biosynthesis is only acted on by two enzymes.

The above observations suggest that enzymes, at least the enzymes discussed, demonstrate broad substrate specificity, a plasticity of sorts that provides support for a type of catalytic flexibility of multiple products from few substrates. Multiple products offer the potential protective overlap of biological activity against a few organisms and a breadth of protection against a variety of organisms. This efficient and broad-spectrum matrix of chemistry functionally converges in protective bioactivity due to the evolutionary divergence of a few compounds to multiple compounds. This is what we refer to in this text as an *economy of chemistry* (Dixon, 1999).

---

We believe that the conditional nature of the interrelationship between genes and environment (see Chapters 2 and 3) would favor the modification of allelochemicals from one active compound to multiple active compounds, resulting in an **economy of chemistry**. This economy of chemistry, an efficient and broad-spectrum matrix of constituents that functionally converge in protective bioactivity against predators, provides a selective advantage to plants. Moreover, we suggest that such a strategy is commonplace, rather than exceptional.

Dyer et al. (2003) demonstrated this economy of chemistry by showing that three of the allelochemicals expressed by a *Piper* sp. act synergistically as allelochemicals and exhibit a broad-spectrum protection against several species of pests. Wu and colleagues (2002) point out that allelopathic effects usually result from groups of constituents, often demonstrating synergy, rather than just one chemical. Increase in selection pressure by just one pest can invoke an enhanced defense that may rely on synergy to efficiently and economically increase defenses against other pests (Poirineau et al., 2003). The efficient and economic organism has the favor of natural selection and is most likely to survive. Efficiency and economy are necessary due to the energetic cost of maintaining the biochemical pathways and the storage of these costly allelochemicals. Therefore, if these costly allelochemicals have multiple functions, the likelihood of survival is enhanced (Wink, 2003). This strategy protects against many pests in an environment and discourages the development of resistance in a specific pest, as commonly occurs with the current strategy of using a single chemical as an insecticide.

Plant breeders have taken a cue from nature by developing plants with high concentrations of allelochemicals (Stamp and Osier, 1998). Fall armyworm, tomato fruitworm, and tomato hornworm respond differently to three allelochemicals — **chlorogenic acid**, **rutin**, and **tomatine** — depending on the temperature and other chemicals present. Stamp and Osier (1998), using a number of pests, demonstrated that tomato plants armed with all three compounds had better protection. Just as plant breeders are taking a lesson from nature, using multiple chemicals as a defensive measure, the same strategy is gaining recognition in clinical medicine.

---

### 13.3 Clinical Medicine Learns from Nature’s Cocktails

The long-famous Madagascar periwinkle may contain more than 500 **indole alkaloids**, many of them antileukemic and antitumor. Two of these alkaloids, **vinblastine** and **vincristine**, have been major antileukemic drugs for close to 50 years. The mayapple (*Podophyllum peltatum*), a derivative of which

was first approved for cancer treatment in 1984, has at least four cytotoxic **lignans**, proven synergic against the herpes virus (Bedows and Hatfield, 1982). The anticancer drug etoposide, is a molecular modification of one such lignan. The yew contains more than a dozen compounds closely related to **Taxol**<sup>®</sup>, first approved for ovarian cancer treatment in 1992. All of these billion-dollar drugs are based on isolated plant constituents that in combination are quite effective against herbivores. And, it is in such combinations that clinical medicine is taking a cue from nature.

“Cocktails” of several pharmaceuticals, at lower dosages, often prove more effective than one pharmaceutical alone, at a higher dosage. In a meta-analysis of 56,000 patients with hypertension, Law et al. (2003) concluded that combinations of two or three drugs at half-standard dose were preferable to one or two drugs at standard dose due to the reduction in side effects and equivalent therapeutic effects.

In other branches of medicine, a similar approach has become standard clinical protocol. In **human immunodeficiency virus (HIV)** infection, drug cocktails have dramatically affected clinical outcomes. The combination of HIV drugs acts synergically (Bulgheroni et al., 2004) and demonstrates partial restoration of immune function (Lederman et al., 1998) and reduction of illness and death (Charurat et al., 2004).

Some cancer treatments have found combinations of drugs more effective than single agents (Baumann et al., 2004). The well-documented synergic activity of irinotecan followed by oxaliplatin combination is well tolerated and highly active in fluorouracil-resistant metastatic colorectal cancer (Bajetta et al., 2004). Preclinical data indicate that docetaxel, platinum salts, and the anti-HER2 antibody trastuzumab are highly synergic in the treatment of breast cancer (Pegram et al., 2004). The combination of topotecan and vincristine (both derived from plants) in various childhood cancers are synergic in most models of solid pediatric tumors (Thompson et al., 1999).

In tropical medicine as well, combination drugs appear to be the coming trend. *Artemisia annua* contains several **sesquiterpene lactones** that are effective against plasmodia. One of them, **artemisinin**, and its derivatives, **artesunate** and **artemether** (see Chapter 8 on bioseparations), have become the first line of treatment against malaria (Ittarat et al., 2003). In a study evaluating resistant *Plasmodium*, artesunate, when combined with standard malaria medications, reduced treatment failure, recrudescence, and gametocyte carriage (Ittarat et al., 2003). Furthermore, the addition of artemisinin with a number of antimalarial medications; mefloquine, tetracycline, and spiramycin has demonstrated marked synergism (Chawira et al., 1987).

Common bacterial infections are also treated with synergic combinations. *Enterococcus* is one of the most important genera in nosocomial infections, resulting in bacteraemia, endocarditis, and other infections. Their genetic plasticity and their ability to rapidly develop resistance against a variety of antibiotics and then to pass these resistance determinants to other more pathogenic microorganisms, has generated an urgency in the search for effective treatments and prevention. *Enterococcus faecium*, possessing both natural and acquired antibiotic resistances, is one of the enterococci that has become dangerously resistant. In vancomycin-resistant *Enterococcus faecium*, combination treatment of daily ampicillin and daily doxycycline demonstrated beneficial activity, usually displaying synergic or at least additive effects, even in macrolide-, lincosamine-, and streptogramin-resistant isolates (Brown and Freeman, 2004).

Additionally, Synercid<sup>®</sup>, the first injectable streptogramin antibiotic composed of quinupristin and dalfopristin, may offer treatment to patients with multiresistant Gram-positive infections. Individually, each component of Synercid shows bacteriostatic activity against staphylococci and streptococci. However, together, the agents exhibit synergy, leading to bactericidal activity (Delgado et al., 2000).

---

### 13.4 Plants as “Medicinal Cocktails”

While combination drug therapy highlights the safety and efficacy of synergic mixtures of specific chemicals in treatment regimes, the astute observer will acknowledge that plants, by their very nature, are combinations of chemicals. The majority of these plant compounds with bioactivities are the plant-protective allelochemicals. As synergic compounds protective against other hungry species, these metabolites are evolutionarily designed through millennia to be biologically active. Ancient humans



did not miss this fact and utilized plant's bioactivities as a method of altering health status since early human history.

We currently face antibiotic-resistant microbes such as *Mycobacterium tuberculosis*, *Staphylococcus aureus*, and *Streptococcus pneumoniae* that quickly evolve pathways around singular antimicrobial agents. Plants already demonstrated the sensible strategy of using multiple biologically active chemicals in low concentrations to outsmart the adaptable microbial pests. Too often, pharmacology follows the principle of Ockham's Razor, extracting single compounds, leaving behind other compounds and their synergies that are designed to enhance the biological activity directed at generating resistance for the plant. The whole nonhomogeneous plant, containing thousands of compounds, is not as likely to give us replicable clinical results as a single compound. For that and other reasons, modern pharmacy goes for the "silver bullet," the isolated phytochemical (often modified for proprietary, if not medical reasons), not the "herbal shotgun" and its polyvalent spread of activity. But a consistent, homogeneous mixture of four active ingredients (e.g., those four mayapple lignans) should give us more antiherpetic activity than an equivalent amount of any one of those lignans. Would results with a consistently standardized mixture of plant metabolites be as replicable in clinical trials as with a single compound? This seems like a valid supposition worthy of laboratory resources. Because plant metabolites have evolved into complex mixtures consisting of several structural types, they would likely demonstrate a synergic economy of chemistry. This would ensure a multifactorial mechanism of action (Wink, 2003) — a distinct advantage over a single target.

Plurality may prove superior to parsimony; plants, like humans, are complex networks of chemical matrices. When we take a plant medicine, we ingest a phytochemical matrix that washes over our genes. Each individual, unique in his or her genotypic peculiarities, may respond to this array of chemical exposure differently. The human genome project suggests that there are more than ten thousand drug targets and ten million **single nucleotide polymorphisms (SNPs)** (Gabriel et al., 2002). Many disorders, such as hypertension and arthritis, as well as cognitive function, are influenced by a broad range of effects spread across multiple SNPs in multiple genes (Cooper, 2003). Multifactorial processes may very well require multifactorial solutions. The naturally dilute, yet broad spectrum, effect of a **phytochemical matrix** may be a superior treatment strategy. The interaction of the low concentration of constituents found in plants with the human genome offers orders of magnitude more frequent and complex activities, and perhaps, safety, than the interactions of a concentrated single isolated phytochemical.

Even in dilute concentrations, phytochemical activity is to be expected. Plant constituents have demonstrated potency at low concentrations and a relatively high affinity and selectivity for multiple biological targets (Firm and Jones, 2000). Moreover, Rajapakse and co-workers (2002) demonstrated that very low concentrations of a chemical agent contribute to a chemical mixture's effect, even though the same concentration of the chemical when isolated exhibits no effect.

A rational pharmacological study of botanical medicine, like that of food, must encompass the complexity and variability of numerous nutrients and metabolites and their effects when ingested. A more complete phytopharmacology would best resist the temptation of uncritical application of Ockham's Razor and permit the multivariate complexity that a plant chemical matrix represents. Any "living" pharmacological model is complex, and as such, necessitates a complex model. Although such complexity opens an infinite number of hypotheses as to what constituent has what activity, as long as safety is primary, an improved patient outcome is reason to move beyond parsimony. Phytochemicals have shown complementary and overlapping effects on oxidative stress, the immune system, hormone metabolism, antibacterial and antiviral activities, and gene expression (Liu, 2002; Muller and Kersten, 2003). Given that plant metabolites are present in complex mixtures, each containing various functional groups, a phytochemical matrix will exhibit multiple functionalities and bioactivities (Wink, 2003).

Activities such as multiple enzyme, receptor or genomic modulation, and the combination of these effects, could potentiate pharmacodynamic activities. Additionally, pharmacokinetics could be prolonged by constituents considered "non-active" that alter stability, solubility, bioavailability, and half-life of "active" constituents (Spinella, 2002). The following examples demonstrate that phytochemical matrices offer the possibility of both pharmacokinetic and pharmacodynamic synergy. Increasingly, as the examples demonstrate, modeling in laboratories is moving toward the analysis of the effects of the synergy of multiple chemicals. It may be that pharmacokinetics and pharmacodynamics could achieve further

accuracy in modeling with phytochemical matrices by following the lead of such elaborate nonlinear mathematical models as those utilized in complexity theory. Complexity theory would allow for the self-organizing, collective properties of multiple chemicals to be coordinated in complex behavior. Such an approach, where the subtleties of multiple low-concentration physiological and pharmacological perturbations can be accounted for, may be necessary to observe the synergy of multiple constituents and the subsequent emergent biological response.

## 13.5 Examples of Synergy

### 13.5.1 Antimalarial Compounds

American herbalists call *Artemisia annua*, “Sweet Annie”; Chinese call it “qing hao.” In China, artemisinin alone has effected cures in more than 2000 patients affected with *Plasmodium vivax* and *P. falciparum* (Table 13.1). Many semisynthetic derivatives of artemisinin show better solubilities and efficacy. There is a developing underground promotion of the herb in the United States for yeast infections and opportunistic infections associated with AIDS. It is also being investigated for recalcitrant breast cancer.

Artemisinin combined with other malaria drugs shows substantial synergic activity against *Plasmodium*. It seems that synergy between artemisinin and the other constituents in *Artemisia annua* are likely as well. Work by Phillipson et al. (1995) shows that several flavonoids in the crude extracts of *Artemisia annua* or its tissue cultures are apparently synergic with artemisinin for antiplasmodial activity.

A total dose of 60 mg of artemisinin, from ingestion of a tea over 5 days, was as effective as the standard dose of 500 to 1000 mg of isolated pharmaceutically prepared artemisinin over the same time period. Mueller et al. (2000) prepared a tea by infusion (5 g plant to 1 ℓ water) and administered it in 250 ml doses four times a day to patients with malarial infections. Analysis of the tea demonstrated an extraction efficiency of 41.4% (12.0 mg of artemisinin per liter). Considering that artemisinin is hydrophobic, it is obvious that other plant constituents had a role in improving the solubility of artemisinin. The tea preparation, with a mere 12.0 mg·ℓ<sup>-1</sup> of artemisinin, demonstrated a rapid disappearance of parasitemia (44 patients checked by blood film) within 4 days in a total of 48 patients. This is remarkable: the total dose of artemisinin used as a standard protocol for malarial treatment is 500 to 1000 mg over 2 to 6 days (bioavailability has been established as less than 32%). The researchers commented on the possibility of synergic activity with other constituents, notably flavonoids, enhancing the antiplasmodic activity of artemisinin (Mueller et al., 2000).

The two **polymethoxyflavones**, **casticin** and **artemitin**, while inactive against *Plasmodium* alone, have been found to selectively enhance the activity of artemisinin against *P. falciparum*. “It is interesting to note that these flavonoids co-occur with artemisinin in *A. annua* and that crude extracts of the plant may indeed offer a therapeutic advantage over the purified sesquiterpene” (Elford et al., 1987). If this is the rule rather than the exception, then our screening programs have been grossly oversimplified.

Although a follow-up study (Mueller et al., 2004) demonstrated excellent results of symptom abatement with the two groups taking teas containing 47 mg (5 g of herb) or 97 mg (10 g of herb) of artemisinin versus quinine sulfate (500 mg three times a day for 7 d), the recrudescence rates were high for the *A. annua* tea groups. Nevertheless, with higher doses or more concentrated tea, this strategy may

**TABLE 13.1**

Inhibition of *Plasmodium falciparum*

Compound	IC <sub>50</sub> (nM)
Artemisinin	9.0
Artemisinin + 5 μM eupatorin	9.0
Artemisinin + 5 μM chrysosplenol-D	3.1
Artemisinin + 5 μM chrysosplenitin	2.9
Artemisinin + 5 μM cirsilineol	2.2

From Liu, K.C.-S. et al. (1989). *Planta Medica* 55: 654–655. With permission.

offer a therapy that is not only effective, but also prevents the development of resistance and is affordable for the people who need it most.

### 13.5.2 Anthraquinones + Antioxidant Nutrients

**Anthraquinones**, long known for their effects on the bowel, appear to have other activities as well. Anthraquinones from the root of daylilies, *Hemerocallis fulva* var. 'Kwanzo', were isolated and tested as cancer cell growth inhibitors. **Kwanzoquinones A–C and E, kwanzoquinone A and B, 2-hydroxy-chrysophanol**, and **rhein** inhibited the proliferation of human breast, central nervous system, colon, and lung cancer cells with GI50 values between 1.8 and 21.1  $\mu\text{g}\cdot\text{ml}^{-1}$ . Coincubating a combination of the anthraquinones with vitamins C and E demonstrated synergic anticancer activity (Cichewicz et al., 2004).

### 13.5.3 Antibacterial Compounds

Muroi and Kubo (1993) demonstrated synergy of the antibacterial compounds from tea (*Camellia sinensis*):

It could be concluded that green tea extract is effective in the prevention of dental caries because of the antibacterial activity of flavor compounds together with the antiplaque activity of polyphenols.... Synergism was found in the combination of **sesquiterpene hydrocarbons** ( $\delta$ -**cadinene** and  $\beta$ -**caryophyllene**) with indole; their bactericidal activities increased from 128-fold to 256-fold. The combination of 25  $\mu\text{g}\cdot\text{ml}^{-1}$   $\delta$ -cadinene and 400  $\mu\text{g}\cdot\text{ml}^{-1}$  indole reduced the number of viable bacterial cells at any stage of growth. (Muroi and Kubo, 1993)

More importantly, such synergies can be utilized to help prevent the development of resistance. "Usually, the rationale for using more than two antimicrobial agents is to target a broad spectrum of microorganisms and to prevent resistance mechanisms developing in microorganisms."

Muroi and Kubo, investigating the old tradition that green tea prevents tooth decay, cited a report (Onisi et al., 1981) that "supports this idea." Muroi and Kubo's data (1993) clearly prove antibacterial synergy between indole and some terpenes found in tea (Table 13.2). They have five plants that have quantitative data for cadinene: betel pepper, caraway, cotton, European pennyroyal, and basil. For **caryophyllene**, there is basil, betel pepper, biblical mint, cinnamon, citronella, clove, copaiba, cubeb, mountain mint, oregano, star anise, sage, spearmint, and thyme, which are well quantified, while we have no quantitative data for tea. For **geraniol**, about a dozen plants exceed tea, among them carrot, citronella, palmarosa, mountain mint, thyme, and wild bergamot, this latter of which (*Monarda fistulosa*) can have 20 times more than tea. For **indole**, we have only four with quantification: hyacinth, jasmine, kohlrabi, and licorice.

**TABLE 13.2**

Some Bactericidal Compounds in Tea

Compound Tested	MIC ( $\mu\text{g}\cdot\text{ml}^{-1}$ )	MBC ( $\mu\text{g}\cdot\text{ml}^{-1}$ )
$\delta$ -Cadinene	800	800
$\beta$ -Caryophyllene	>1600	>1600
Geraniol	400	400
$\beta$ -Ionone	100	200
Indole	800	1600
<i>Cis</i> -Jasmone	800	1600
Linalool	1600	1600
Nerolidol	25	200
1-Octanol	400	400
$\alpha$ -Terpineol	800	1600

From Muroi, H. and I. Kubo. (1993). *J Agric Food Chem* 41: 1102–1105. With permission.

A recent study added honeysuckle, but the indole was there only at levels of 87 ppb or less. For the compound **ionone**, tea far exceeds the others, for which we have quantitative data, at 1700 to 2900 ppm.

Other aromatic plants show antibacterial activity as well. Assaying water-soluble and water-insoluble subfractions of the methanol extract of *Thymus pectinatus*, little to no antimicrobial activity was observed in the tested subfractions. However, the whole essential oil showed strong antimicrobial activity against all microorganisms tested. True to synergic activity, the whole oil also demonstrated better activity than the well-known and well-used isolated antimicrobials, **thymol** and **carvacrol**. The authors suggest *T. pectinatus* essential oil as a natural antimicrobial and antioxidant source (Vardar-Unlu et al., 2003). Additionally, carvacrol, found in a number of aromatic plants, showed synergic effects against *Bacillus cereus* when combined at roughly a 1:1 ratio with cymene (Ultee et al., 2000).

In further research on antimicrobial activity, the **essential oils** from dill (*Anethum graveolens*), coriander (seeds of *Coriandrum sativum*), cilantro (leaves of immature *C. sativum*), and eucalyptus (*Eucalyptus dives*) were separated into heterogeneous mixtures of components by fractional distillation. After determining the minimum inhibitory concentrations (MICs) against Gram-positive bacteria, Gram-negative bacteria, and *Saccharomyces cerevisiae*, researchers found that the mixing of certain fractions resulted in synergic or antagonistic effects against microorganisms (Delaquis et al., 2002).

### 13.5.4 Antiedemic Compounds

Recently, ginkgo extracts were promoted as a topical agent (or cosmetic) to improve peripheral circulation and, hence, making them useful as slimming and moisturizing agents due to their microvasculokinetic activity. Della Loggia et al. (1996) demonstrated the anti-inflammatory activity of some ginkgo biloba constituents and their phospholipid complexes. **Ginkgolides**, **bilobalide**, a biflavonic fraction, and some pure biflavones (especially when mixed synergically) were comparable to indomethacin as anti-inflammatories. Ginkgolides inhibit the pro-inflammatory autocoid PAF (platelet-aggregating factor). Its **biflavones** inhibit histamine release from mast cells and cyclic adenosine monophosphate (cAMP) phosphodiesterases. The extract also reduces production of oxygen species by activated neutrophils.

Complexes with distearoylphosphatidylcholine, more soluble in nonpolar solvents than the parent compounds, are even more strongly lipophilic, resulting in increased bioavailability and activity. For example, the complex shows some five times more antiedemic activity of the ear at 25  $\mu\text{g}/\text{ear}$  than the free parent. The complex of a mix of ginkgolides A and B was more potent than indomethacin, while the free mixture was not quite as effective. But phospholipid alone was inactive, merely increasing the activity of ginkgolides by making them more bioavailable. Of pure biflavones, **amentoflavone** was strongest with antiedemic  $\text{IC-45} = 2 \mu\text{M}/\text{ear}$ , followed by **ginkgetin** ( $\text{IC-25} = 2 \mu\text{M}/\text{ear}$ ) and **sciadopitysin** ( $\text{IC-19} = 2 \mu\text{M}/\text{ear}$ ) cf  $\text{IC-60} = 2 \mu\text{M}/\text{ear}$  for indomethacin. The mix of the biflavone fraction (corresponding to ca 0.2  $\mu\text{M}$  of biflavones) inhibited 73% of the edema, compared with 45% for amentoflavone, the strongest competitor. Thus, the pure flavones exhibit at least additive and often synergic activity when mixed (Della Loggia et al., 1996).

### 13.5.5 Antifeedant Compounds

#### 13.5.5.1 *Neem (Azadirachta indica)*

For insect control in India, Kumar and Parmar (1996) prescribed oil-based formulations containing at least 300 ppm **azadirachtin**. Though several other constituents influence its bioactivity, **salanin** and azadirachtin best correlate with inhibition of *Spodoptera*. Looking at 42 seed sources, however, they found that azadirachtin content varied more than 2000-fold (ND to 2323 ppm), **nimbin** >18,000-fold (ND to 18,132 ppm), and salanin >45,000-fold (ND to 47,150 ppm), assuming that ND = 1 ppm. Obviously, if the activity is based on one constituent, this is problematic.

The effective doses ( $\text{ED}_{50}$ ) against neonate *Spodoptera larvae* were 0.29 ppm for azadirachtin, >400 for nimbin, and 72 for salanin, while for whole oils (none containing more than 2323 ppm azadirachtin), the  $\text{ED}_{50}$  ranged from 1.8 to 3550 ppm (Kumar and Parmar, 1996). Intriguingly, Koul et al. (2003) showed synergic activity as well with groups of neem constituents. They demonstrated parallel pathways

converging on the common outcome of insecticidal activity. Although azadirachtin is considered a key constituent, other constituents demonstrated both feeding deterrence and physiological toxicity. The synergic activity observed did not occur between nonazadirachtin limonoids that possessed similar modes of action; rather, it occurred between the nonazadirachtin limonoids having varying modes of action. Koul et al. (2003) suggested that this could be useful in using mixtures of constituents for insecticides rather than isolated constituents. Additionally, this offers an advantage for the neem materials with low levels of azadirachtin content.

### 13.5.6 Antioxidant Panaceas

The **cumulative antioxidant index (CAI)** hypothesis implies that the more antioxidants and the less oxidized cholesterol we carry in our bodies, the less our chances of coronary problems (Duke, 1992c). The CAI is calculated as follows:

$$\frac{(\text{Vitamin E}) \times (\text{Vitamin C}) \times (\beta\text{-carotene}) \times (\text{Selenium})}{(\text{Cholesterol})}$$

The fact that the values are multiplied rather than added implies synergy rather than additive relations between these antioxidants. Rosemary is the herb of remembrance. Can rosemary shampoos slow the effects of Alzheimer's disease? Like many green leaves, rosemary contains  **$\beta$ -carotene, ascorbic acid, tocopherol, and selenium**. Many other antioxidants could complement the conventional vitamins. Classically, rosemary is considered a good antioxidant herb. It contains close to two dozen named antioxidants, over and beyond the CAI antioxidants. Antioxidants from rosemary, competitive with butylated hydroxyanisole (BHA) and butylated hydroxytoluene (BHT), already make up a \$2 million annual business in the United States. Rosemary has received much press in the past for its antioxidant activity. Lamaison et al. (1991) showed that oregano is higher than rosemary in antioxidant activity. Screening 100 mints for antioxidant activity, Lamaison et al. (1991) found that oregano, *Origanum vulgare* ssp. *vulgare*, had the greatest total antioxidant activity.

The antioxidant activity of mints is due partially to **rosmarinic acid**, flavonoids, and other hydroxycinnamic acid derivatives. Lamaison et al. (1991) did not mention the vitamins. Fujita et al. (1988) evoked data suggesting that **rosmarinic acid** was almost twice as good as  $\alpha$ -tocopherol as a radical scavenger (at least to prevent peroxidation of linolenic acid). But oregano is high in rosmarinic acid (55,000 ppm) compared to rosemary (25,000 ppm). Oregano is 2.5 times more potent in colorimetrically measured total antioxidant activity. Data are reported by ED<sub>50</sub> in micrograms per milliliter, roughly ppm, which decreases the absorbance (color) of the free radical by 50%. The ED<sub>50</sub> of oregano is roughly 16 ppm, while that of rosemary is 40. Thus, it takes 2.5 times as much rosemary to accomplish the same amount of antioxidant activity as oregano, at least under the conditions of this study (Lamaison et al., 1991).

There is much more than rosmarinic acid in rosemary. Chen et al. (1992) compared three or more than a dozen antioxidants to rosemary. They apparently did not measure rosmarinic acid, which has several other interesting activities as well as antioxidant activity. They mentioned **tocopherol**, which of the vitamins A, C, and E, usually gets the biggest press as an antioxidant, preventing various maladies. But vitamin E (tocopherol) is usually in the plant at levels of 1 to 20 ppm. And, not to be surprised, tocopherol and rosmarinic acid combined show synergic antioxidant activity (Jayasinghe et al., 2003).

Chen et al. (1992) present Table 1 in their work, which shows that there can be as much as 100,000 ppm **carnosic acid** in the hexane extract; 60,000 ppm in the acetone extract; and only traces in the methanolic extract. Rosmarinic acid can be close to 25,000 ppm in the plant (dry weight basis).

Of course, antioxidant activity is ubiquitous in the plant kingdom, which is sensible because the absorption of photons from the sun involves oxidative processes. Plants are, therefore, loaded with molecular antioxidant compounds. Besides rosmarinic acid, the **flavonoids** are well known to be potent antioxidants. When Szent Györgyi first isolated vitamin C (ascorbate), he quickly realized that the vitamin C and "vitamin P" later to be known as the bioflavonoids (**rutin, quercetin, and hesperidin**), were necessary to get the best biological activity from vitamin C. Vitamin C and many of the flavonoids

together exhibit synergic activity (Bors et al., 1995). Szent Györgyi called the activity of the flavonoids “ascorbate-protective” (Bors et al., 1995).

Skaper et al. (1997) demonstrated that ascorbic acid enhances the cytoprotective effects of the flavonoid quercetin and its glycoside, **rutin**, against oxidative stress-induced death of human skin fibroblasts. The vitamin C both lowered the EC<sub>50</sub> and prolonged the time over which the flavonoid was active in rescuing cells from oxidative injury. In postulating why ascorbate would have such an effect, one proposal directed attention to the cooperative activities between quercetin (or rutin) and ascorbic acid. This may result from a reduction by ascorbate of the oxidized flavonoid.

Although still needing confirmation in whole cell systems, ascorbate regenerates quercetin and its 3-glycoside, rutin, from the respective aroxyl radical (Skaper et al., 1997). We see this interaction as a synergic effect, where the vitamin C, in concert with the flavonoids, provides a constant resupply of the flavonoid, which can, in turn, continue its free radical scavenging. So far we are aware that, these are the first data to provide a proposal for the synergic action of flavonoids and ascorbic acid in rescuing cells from death caused by oxidative stress (Skaper et al., 1997).

Other research on flavonoids supports the hypothesis that combinations are superior to isolated constituents. Lipid peroxidation is believed to be a key event in atherogenesis. Using human plasma to observe **lipid peroxidation (LPO)**, Filipe et al. (2001) observed the protective effect of flavonoids and their interaction with **urate** (an important endogenous plasma antioxidant). They found that some flavonoid combinations are effective against LPO. Their results also showed that some flavonoids not only protected the endogenous urate from oxidative degradation, but also, demonstrated an antioxidant synergy with urate (Filipe et al., 2001).

**Ferulic acid**, an aromatic compound, was also used in LPO investigations. When ferulic acid is combined with **α-tocopherol**, **β-carotene**, and **vitamin C**, the system demonstrated synergy in inhibition of LPO in liver microsomal membranes. The same combination was also found to have a synergic effect on reducing the reactive oxygen species production in fibroblasts. The researchers commented that the compounds in this mixture cooperate in preserving physiological integrity of cells exposed to free radicals (Trombino et al., 2004).

Antioxidants have been demonized as of late, with a few studies demonstrating a worsening effect on cancer or cardiovascular disease when a single antioxidant is used. If synergy is the rule rather than the exception, then using a single antioxidant, although pharmacologically common, may not be physiologically wise. A combination of antioxidants, like the above ascorbate and quercetin combination, is more likely to be something our physiology will recognize as useful (Liu, 2003). Studies have shown that the intake of combinations of nutrients/antioxidants decreases the rates of cancer and other chronic diseases (Bidoli et al., 2003; Li et al., 1993; La Vecchia et al., 2001; Hardy et al., 2003). But very likely, best results might occur with, not just a combination of two antioxidants, but with a number of antioxidants together (Hardy et al., 2003; Liu, 2003). Fuhrman et al. (2000) concluded that a tomato oleoresin’s effect on LDL oxidation was five times superior to that of isolated **lycopene**, due to a synergic combination of lycopene, vitamin E, **glabridin** (a flavonoid), garlic, and the well-known phenolics **rosmarinic acid** and **carnosic acid**. They suggest that a combination of antioxidants offers a superior antiatherogenic activity to that of an isolated antioxidant, such as lycopene. They also demonstrated that lycopene’s antioxidant activity in the above model was enhanced by other nutrients, such as β-carotene or vitamin E (Fuhrman et al., 2000).

### 13.5.7 Anticholinergic Effects

**Cineole** (200 to 10,000 ppm in rosemary) can stimulate rats even upon inhalation. Cineole is dermally absorbed 100 times more through the skin in oil-based massage than through inhalation aromatherapy and can speed up transdermal absorption of other dermally active compounds, sometimes 100-fold (Buchbauer, 1990). Cineole also readily crosses the blood–brain barrier. That would be expected to apply also to rosemary’s **carvacrol**, **fenchone**, **limonene**, and **thymol**, all of which are reported to have anticholinesterase activities. Dermal absorption is more rapid in areas rich with hair follicles, like the scalp. Rosmarinic acid, at least in a murine model, has shown a 60% bioavailability (Ritschel et al., 1989).

TABLE 13.3

Plants Highest in a Specific Terpene

Terpene	1 (highest levels)	2	3	4	5 (lowest of top 5)
Carvacrol	<i>Monarda fistulosa</i>	<i>Thymus vulgaris</i>	<i>Satureja montana</i>	<i>Origanum vulgare</i> subsp. <i>hirtum</i>	<i>Monarda punctata</i>
Carvone	<i>Apium graveolens</i>	<i>Carum carvi</i>	<i>Mentha longifolia</i>	<i>Mentha arvensis</i> var. <i>piperascens</i>	<i>Mentha spicata</i>
Cineole	<i>Curcuma longa</i>	<i>Alpinia galanga</i>	<i>Rosmarinus</i> <i>officinalis</i>	<i>Melaleuca</i> <i>leucadendra</i>	<i>Melaleuca</i> <i>viridiflora</i>
Fenchone	<i>Foeniculum</i> <i>vulgare</i>	<i>Cistus ladaniferus</i>	<i>Rosmarinus</i> <i>officinalis</i>	<i>Peumus boldus</i>	<i>Plectranthus</i> <i>coleoides</i>
Limonene	<i>Citrus limon</i>	<i>Apium graveolens</i>	<i>Canarium indicum</i>	<i>Apium graveolens</i>	<i>Carum carvi</i>
Thymol	<i>Citrus limon</i>	<i>Trachyspermum</i> <i>ammi</i>	<i>Mondarda</i> <i>punctata</i>	<i>Thymus vulgaris</i>	<i>Pycnanthemum</i> <i>nudum</i>
$\alpha$ -Pinene	<i>Pinus insularis</i>	<i>Pinus kesiya</i>	<i>Pinus gerardiana</i>	<i>Apium graveolens</i>	<i>Pinus palustris</i>
$\beta$ -Pinene	<i>Pinus insularis</i>	<i>Pinus kesiya</i>	<i>Pinus palustris</i>	<i>Pinus roxburghii</i>	<i>Pinus gerardiana</i>

From Dr. Duke's Phytochemical and Ethnobotanical Databases (<http://www.ars-grin.gov/duke>).

Certainly, the literature indicates that several choline- and acetylcholine-conserving compounds, **carvacrol**, **carvone**, **cymene**, **cineole**, **fenchone**, **limonene**, **terpinene**, and **thymol**, may be dermally absorbed and do cross the blood–brain barrier. Does that mean that rosemary shampoo can help preserve brain levels of choline and acetylcholine, enhanced by bean and lentil soups (naturally rich in choline)? Does that mean that a daily regime of five choline-rich legume dishes plus scalp massage with rosemary/lecithin, followed by rosemary shampoo, and finally a rosemary bath, could help stave off Alzheimer's disease? There are herbs considerably richer than rosemary in antioxidant and acetylcholine-conserving dermally absorbed compounds. Oil extracts of these, used in dermal massage, could then have acetylcholine conserving effects.

Thanks to the potential of synergy between the acetylcholine inhibitors, rosemary may truly deserve its title as the “herb of remembrance.” Rosemary contains at least five dermally absorbed antioxidants and at least five dermally absorbed anticholinesterase compounds, some of which readily cross the blood–brain barrier. We speculate that some of them would work like tacrine, the first anticholinesterase inhibitor approved by the U.S. Food and Drug Administration (FDA) for Alzheimer's disease. It helps about 25% of patients and is hepatotoxic to about the same percentage of livers.

The essential oil of *Salvia lavandulaefolia* is also generating interest in terms of acetylcholinesterase activity. Perry and colleagues (2000), while working with the terpenoids found in *S. lavandulaefolia*, such as  $\alpha$ -**pinene**, **1,8-cineole**, and **camphor**, found them to be weak uncompetitive reversible inhibitors of human erythrocyte acetylcholinesterase. However, they found the whole oil to have significant inhibitory activity on acetylcholinesterase. Provided that the inhibitory activity of the essential oil is primarily due to the main inhibitory terpenoid constituents identified, *S. lavandulaefolia* appears to have major synergic antiacetylcholinesterase activity among its constituents (Perry et al., 2000).

A 50% enzyme inhibition for the oil would occur at approximately 160 mg· $\ell^{-1}$  if the values of the constituent terpenes individually acted in an additive manner. This is approximately 5000 times the concentration of essential oil (0.03 mg· $\ell^{-1}$ ), providing 50% inhibition (Houghton, 2004). Obviously, if there is not an unidentified constituent responsible, there is significant synergic activity between the constituents.

A list of **terpenes** and plants with highest levels on a scale of 1 to 5 is presented in Table 13.3.

### 13.5.8 Antiulcer Activities

Beckstrom-Sternberg and Duke (1994) indicated that ginger has 13 antiulcer compounds. This is almost double the number of antiulcer compounds found in sesame and cayenne, each containing seven. Ginger rhizomes were fractionated for assaying antiulcer activity. One fraction, which inhibited gastric ulcers (murine), contained four compounds:  $\alpha$ -**zingiberene**,  $\beta$ -**sesquiphellandrene**,  $\beta$ -**bisabolene**, and **ar-**

**curcumene.** The total fraction exhibited 97.7% inhibition at 125 ppm. However, this concentration of the total fraction contained only trace or negligible quantities of the four compounds, resulting in a theoretical combined inhibition of only 1.47%. The total fraction was over 66 times more effective than the summed effects of the individual chemicals. This is once again a strong indication of synergy if an unknown compound does not account for the remaining inhibitory activity. A necessary follow-up test for synergy would involve assaying the four pure compounds and mixtures thereof at different concentrations to determine whether other components of the fraction or the fractionation process were factors.

### 13.5.9 Calcium Antagonists

Harmala et al. (1992) reported 15 calcium-antagonistic compounds from roots of *Angelica archangelica*. One, **archangelicin**, showed significantly higher calcium-antagonistic activity than verapamil. The calcium antagonists reported from *Angelica* are **2'-angeloyl-3'-isovaleryl-vaginate**, **archangelicin**, **bergapten**, **byakangelicin-angelate**, **imperatorin**, **isoimperatorin**, **isopimpinellin**, **8-(2-(3-methylbutoxy)-3-hydroxy-3-methylbutoxy)-psoralen**, **osthole**, **ostruthol**, **oxypeucedanin**, **oxypeucedanin-hydrate**, **phellopterin**, **psoralen**, and **xanthotoxin** (Harmala et al., 1992).

Another plant with significant quantities of calcium-antagonistic compounds in the seeds is *Ammi majus* (bishop's weed): **bergapten** (400 to 3100 ppm), **imperatorin** (100 to 8000 ppm), **isopimpinellin**, **oxypeucedanin** (3000 ppm), **oxypeucedanin-hydrate** (400 ppm), **xanthotoxin** (2300 to 20,000 ppm) (Harmala et al., 1992). Thus far, we have no reports of the potent archangelicin outside of *Angelica*, nor do we know how archangelicin compares with other more widely distributed coumarins.

*Angelica* may contain more than 1300 ppm limonene, the compound in grapefruit suspected to potentiate certain pharmaceutical calcium blockers. Add caraway and celery seed, rich sources of limonene, to make Duke's "angelade," a mixture of apiaceous vegetables loaded with calcium blockers and hypotensive compounds. Angelade could be a superior, yet safer, generic calcium blocker.

### 13.5.10 *Catharanthus roseus* (L.)

Eli Lily grew Madagascar periwinkle, *G. Don* (Apocynaceae) — rosy periwinkle, a most important antileukemic plant — in Texas for years. There are at least nine reportedly "antitumor" compounds present in this plant, namely, **leurosine**, **perivine**, **quercetin**, **reserpine**, **serpentine**,  **$\beta$ -sitosterol**, **ursolic acid**, **vinblastine**, and **vincristine**. There are also at least nine reportedly "hypoglycemic" compounds, namely, **catharanthine**, **leurosine**, **lochnerine**, **quercetin**,  **$\beta$ -sitosterol**, **tetrahydroalstonine**, **ursolic acid**, **vindoline**, and **vindolinine**. And, there are at least eight reportedly "hypotensive" compounds that include **ajmalicine**, **choline**, **kaempferol**, **mitraphylline**, **reserpine**, **serpentine**, **vincamine**, and **vinceine** (Duke, 1992a,b).

Geoffrey Cordell, a University of Chicago scientist, told Duke that more than 500 alkaloids have been reported from this important medicinal plant species. If it now costs close to one billion dollars to prove a new drug to be safe and efficacious, would it not make sense that some of those funds would be spent on finding a synergic mixture of a few of these 500 alkaloids? We think that this strategy has the potential of reducing iatrogenesis due to the toxicity of isolated constituents.

### 13.5.11 Flavonoids

When Duke met with Najla Guthrie, who vigorously champions the principles of synergy in cancer prevention, she said that the whole is better than the sum of its parts. Workers in her laboratory are performing the tests that we urged so often, when, in retrospective reading, we see that the authors' data suggest a synergy between closely related compounds in a given plant species. As long as one is testing the individual active ingredients, looking for the "magic bullet," why not mix pure ingredient A with pure ingredient B (or C...Z) and see whether the mixtures are synergistic, additive, or antagonistic? We predict you will find the phenomena of synergies in more combinations than you will find the evolutionarily nonadaptive antagonisms.



Two citrus flavonoids, **hesperetin** and **naringenin**, found in oranges and grapefruit, respectively, and four noncitrus flavonoids, **baicalein**, **galangin**, **genistein**, and **quercetin**, showed an  $IC_{50}$  of 18, 18, 5.9, 56.1, 140.0, and 10.4  $\mu\text{g}\cdot\text{ml}^{-1}$ , respectively, against breast cancer cells *in vitro*. So et al. (1996) also tried 13 different 1 + 1 mixtures of these compounds. In most cases (12 of the 13), the  $IC_{50}$  of the mixture was lower than the arithmetic mean of the two compounds'  $IC_{50}$ , indicating synergy. "All of the combinations of flavonoids, except naringenin + hesperetin, inhibited the proliferation of MDA-MB-435 human breast cancer cells *in vitro* at much lower concentrations than either of the individual compounds alone" (So et al., 1996). The lack of synergism between hesperetin and naringenin may have been related to the fact that they belong to the same class of flavonoids. Combinations with quercetin, a flavonoid found in most fruits and vegetables, were most effective. This could be important if similar synergistic relations can be demonstrated for inhibition of *in vivo* tumorigenesis. Cytotoxicity was exceedingly low ( $LC_{50} > 500 \mu\text{g}\cdot\text{ml}^{-1}$ ) in all cases (So et al., 1996).

When **genistein** and **curcumin** were added together to estrogen-positive human breast MCF-7 cells, the result, due to a synergic action of the genistein and curcumin, was a total inhibition of induction of the cancerous cells. The inducers used were the highly estrogenic activity of mixtures of endosulfane/chlordane/DDT. The authors concluded that their results suggest that the combination of genistein and curcumin in the diet have the potential to reduce the proliferation of estrogen-positive cells induced by mixtures of pesticides or 17- $\beta$  estradiol (Verma et al., 1997). Both genistein and curcumin were reported to act as MDR inhibitors. Because both of these phytochemicals are very common (genistein in many edible legumes, and curcumin in turmeric, curry, and mustard) and the exposure of xenoestrogens is so prolific, with further investigation, we may find that curried beans (dhal) may be an excellent protective strategy against certain cancers.

Genistein also induced DNA damage in two different prostate tumor cell lines (androgen receptor-positive LNCaP and androgen receptor-negative PC-3) at  $<10 \mu\text{M}$ , a physiologically relevant concentration. Daidzein inhibited cell growth at 10 to 100  $\mu\text{M}$ , yet had no effect on DNA damage at up to 500  $\mu\text{M}$ . Thus, despite their structural similarities, these different phytoestrogens inhibit prostate tumor cell growth by independent mechanisms (Mitchell et al., 2000).

Mertens-Talcott et al. (2003) showed anticarcinogenic activity using a combination of **quercetin** and **ellagic acid**. These polyphenolics, commonly found in fruits, were studied in a human leukemia cell line (MOLT-4) on cell death and proliferation-related variables. **Ellagic acid** significantly potentiated the effects of quercetin (at 5 and 10  $\mu\text{mol}\cdot\ell^{-1}$  each) in the reduction of proliferation and viability and the induction of apoptosis. **Isobolographic analysis** of the cell proliferation data was used to confirm the synergy and demonstrated significant alteration of cell cycle kinetics. Ellagic acid and quercetin interaction demonstrated a synergic anticarcinogenic potential (Mertens-Talcott et al., 2003).

A commercial product with a ratio of 25:1 decaffeinated green tea concentrate to a *Capsicum* vanilloid-containing preparation was tested for its inhibition of cancer cells. This was determined in culture by assays of tNOX, a catechin-vanilloid target protein, known to be a cell surface growth-related enzyme specific to cancer. The activity of tNOX was inhibited synergically by the mixture that exhibited efficacy against the cancer cells (Morre and Morre, 2003).

Using a murine carcinoma hepatic cell line (Hepa1c1c7) and a human prostate cancer cell line (LNCaP), a variety of flavonoids were screened for activity. Cell viabilities of Hepa1c1c7 and LNCaP were determined after a 48 or 72 h treatment, respectively. Combination treatments (25 to 50  $\mu\text{m}\cdot\ell^{-1}$ ) of **quercetin**, **kaempferol**, and **naringenin** went beyond additive growth inhibition in both cell lines. The researchers suggested that the inhibition was due to the combination of constituents creating a synergic activity against the prostate cancer cells (Campbell et al., 2003).

In a model using human oral (KB, CAL27), colon (HT-29, HCT116, SW480, SW620), and prostate (RWPE-1, RWPE-2, 22Rv1) cancer cell lines, Seeram et al. (2004) investigated the antiproliferative effects of a cranberry extract (200  $\mu\text{g}\cdot\text{ml}^{-1}$ ). The extract was compared with isolated fractions of cranberry. The total polyphenol fraction was the most active fraction against all cell lines, with 96.1 and 95% inhibition of KB and CAL27 oral cancer cells, respectively. Seeram and team found synergic antiproliferative effects resulting from the combination of **anthocyanins**, **proanthocyanidins**, and **flavonol glycosides** as compared with isolated phytochemicals (Seeram et al., 2004).

### 13.5.12 Fungicides

Sweet basil oil (*Ocimum* sp.) and two of its major constituents (**linalool** and **eugenol**) were tested against a number of fungal species, including *Sclerotinia sclerotiorum*, *Rhizopus stolonifer*, *Vuill.*, and *Mucor* sp. in a closed system. Linalool alone showed a moderate antifungal activity, while eugenol showed no activity. However, the combination of the two in a ratio similar to their concentrations in the original oil was found to synergistically enhance the antifungal properties of basil oil (Edris and Farrag, 2003). Could it be that the ratios of these constituents were evolutionarily perfected for their collective protective effects (e.g., antifungal)?

Pitarokili et al. (2003) came to the conclusion that synergy existed among volatile metabolites of *Salvia fruticosa* plants. The essential oils were slightly effective against *Fusarium oxysporum* f. sp. *dianthi* and *Fusarium proliferatum*, whereas against *Rhizoctonia solani*, *Sclerotinia sclerotiorum*, and *Fusarium solani* f. sp. *cucurbitae*, the oils exhibited highly significant antifungal activities. In an effort to evaluate the individual contributions of the main components of the oils to the antifungal property, pure commercial **1,8-cineole** and **camphor** were tested for their fungitoxicity to the radial growth of five fungi at concentrations up to 500  $\mu\text{l}\cdot\ell^{-1}$ . The higher effectiveness of the oils led Pitarokili et al. (2003) to believe that other components of the total oils can exert, if not a direct activity, at least a synergic enhancement of camphor action.

Grapes contain several antifungal compounds (e.g., **caffeic acid**, **chlorogenic acid**, **pterostilbene**, **resveratrol**, and **viniferin**). These compounds were not likely idly generated. They probably evolved to protect the grape from its fungal enemies. Because evolution favors those plants that have the best defense systems against bacteria, fungi, herbivores, insects, and viruses that plague the plant, it seems logical that synergic activity between constituents would be the rule rather than the exception.

If caffeic acid is viricidal at 62 ppm and ellagic acid at 200 ppm, the combination of the two would be expected to be active at 131 ppm. If there were synergy, the combination would be viricidal at less than 131 ppm. If there were antagonism, the combination would be active only at more than 131 ppm. There are also more than a dozen antioxidant and cancer-preventive compounds in grape. Might we also assume that these work synergically? Considering the economy of chemistry discussed in the introduction, we would suppose so.

In 1997, one of the compounds, resveratrol, received a lot of press as a heart-healthy anticancer compound. The press (Jang et al., 1997) promoted the fruit of grape as the best source of the resveratrol. However, there may be 100 times more resveratrol in the grape leaves than in the fruits. One could possibly capitalize on the heart-healthy synergies of some of the fungicidal compounds in grape leaves by enjoying the Mediterranean “stuffed grape leaves” with a lot of celery, garlic, olive oil, onion, pimento, and a little rice. Perhaps for even further potential of synergy, one could chase down this culinary antifungal/antioxidant meal with a glass of red wine with all its procyanidins and traces of resveratrol.

### 13.5.13 Garlic (*Allium sativum* L.)

Garlic and onion are reported to inhibit platelet aggregation. **Ajoene** was identified as one of the active ingredients in garlic. Block et al. (1984) mention at least three compounds in garlic that inhibit platelet aggregation: (1) **diallyl trisulfide**, (2) **2-vinyl-4H-1,3-dithiin**, and (3) ajoene. **Adenosine**, **allicin**, and **alliin** are three more antiaggregants, at least *in vitro*. **Quercetin** is another antiaggregant, apparently present in traces only in garlic, at 300 ppm in chives, and from 10 ppm in white onions to 65,000 ppm in the outer skin of red onions (Beier and Nigg, 1992).

*Allium* sp. oils (garlic or onion) showed marked antineoplastic effects, representing both growth suppression and differentiation activities on leukemia HL60 cells. The combination of these oils with all-*trans* retinoic acid or with dimethylsulfoxide (DMSO) led to marked differentiation of the cells, and their effects were estimated to be synergic (Ariga et al., 2000).

At least five garlic compounds inhibit cholesterol synthesis *in vitro* (Sendl et al., 1992). Results suggested that garlic and a wild garlic relative may reduce serum cholesterol levels, if taken in sufficient amounts, primarily by inhibiting cholesterol synthesis. Sendl et al. (1992) suggested that this effect likely arises from a mixture of sulfur-containing thiosulfonates. Further research suggested that this mechanism

is due to inhibition of HMC CoA reductases, the same mechanism used by the commonly prescribed statin drugs (Ferri et al., 2003; Mathew et al., 2004).

At least with rabbits, synergy seems involved in lipolytic activity. “The total extract (i.e., containing all constituents of garlic) was the most effective. Extracts prepared with urea and/or alcohol reacted similarly, though more weakly. On the other hand, aqueous extracts, which had been boiled, resulting in loss of the thiosulfates, did not produce well-defined results” (Koch and Lawson, 1996). One fat-digesting enzyme, **lipase**, is inhibited by agents that bind sulfhydryl compounds, and ajoene, allicin, and diallyl trisulfide all bind rapidly to sulfhydryl compounds. Allicin may “synergize” adenosine, which, alone, is poorly absorbed. “Only in the presence of substances with lipophilic and hydrophilic areas in the same molecule, e.g., allicin, can adenosine be absorbed into the blood” (Koch and Lawson, 1996). At only 12 mg·kg<sup>-1</sup>, “garlic and onion oils (steam distilled), dipropyl disulfide, and diallyl sulfide were all found to have significant hypolipidemic effects (lowering fat levels) in both normal rats and hyperlipidemic rats (those with elevated fat levels), although the garlic oil consistently gave the best results” (Koch and Lawson, 1996).

One can also add **phytic acid** to the fibrinolytic (antiaggregant, antithrombotic) compounds in that chemical factory called garlic. Koch and Lawson (1996) mention a garlic-extract-factor (“identical with phytic acid”) that increases the prothrombin time. **Cycloalliin** is still another compound in garlic that elevates fibrinolytic activity. They report on one garliphile whose blood took twice as long to clot when she was on garlic as when she curtailed her garlic consumption. There are many antiaggregant compounds to complement the fibrinolytic activity. Fresh garlic (100 to 150 mg·kg<sup>-1</sup>; 6 to 9 g for a 60 kg adult) leads to complete inhibition of thrombocyte aggregation for one to two hours after consumption. Adenosine and allicin inhibit platelet aggregation without affecting cyclooxygenase and lipoxygenase metabolites of arachidonic acid. The trisulfides inhibit platelet aggregation as well as thromboxane synthesis along with induction of new lipoxygenase metabolites. As antiaggregants, the best dry garlic powder tablets were as effective as garlic or garlic homogenates, but steam-distilled oils were only 35% as active and oil macerates only 12% as active. Ajoene, a compound unique to the oil macerates, had the highest specific activity, slightly more active than 1,2-vinyldithiin, diallyl trisulfide, or allicin, and considerably more active than diallyl disulfide, allyl methyl trisulfide (EC<sub>50</sub> = 10 μM), or 1,3-vinyldithiin.

Besides diallyl trisulfide, other polysulfides, such as **dimethyl trisulfide** and **allyl methyl trisulfide**, are active. Simple monosulfides are less active or inactive. Diallyl mono-, di-, and trisulfides have less than half the activity of ajoene. Some authors (not Lawson) believe alliin is the antiaggregant. Phenolics (see Chapter 1), structurally similar to flavonoids, are also believed to be involved. Too much garlic intake may reverse results, so moderation is best in all things. High concentrations of aggregating agents (saturated fats) can abolish platelet inhibition caused by low-dosed garlic preparations (Koch and Lawson, 1996).

### 13.5.14 Goitrogens

Thiocyanate, the first discovered goitrogen (generating goiter), was a less effective goitrogen at twice the concentration found in cabbage than was cabbage itself. Goitrogenicity of cabbage and other cruciferous plants can be explained as being due to combined additive or synergistic action of **thiocyanate**, **goitrin**, and **allyl isothiocyanate**. These compounds are enzymatically hydrolyzed from various **glucosinolates**. Brussels sprouts has the highest observed glucosinolate levels, namely, 1430 to 1760 ppm on a fresh weight basis and ten times that much on a zero moisture basis if they are 90% water (Beier and Nigg, 1992). There are almost 100 glucosinolates known, one cabbage containing at least 12 totaling 663 ppm (fresh weight basis, estimated 6300 ppm if calculated on a dry weight basis). If the plant-protecting activities of glucosinolates are synergistic, might not their cancer-preventive properties also be synergistic?

### 13.5.15 *Hypericum*

*Hypericum perforatum* (St. John’s wort) used to be the darling of the natural products industry. “Used to be,” because of the controversy over herb–drug interactions that now exists. Cott (2001) discussed

the reduction of plasma levels of indinavir, cyclosporin, and digoxin with patients using both *Hypericum* and the mentioned pharmaceuticals. Nevertheless, this phytotherapeutic agent is still extraordinary in its usefulness. In Germany, the most popular prescription drug of any type, natural or synthetic, for the treatment of mild depression is a concentrated extract of the flowers of St. John's wort, often simply called *Hypericum*. There, just under 200,000 prescriptions per month have been filled for just one *Hypericum* product (Jarsin), compared with about 30,000 per month for fluoxetine (Prozac®).

Over the decades it has been interesting to watch the "active" constituent of *Hypericum* change (or at least the viewpoint of what is active change). Originally, it was believed that the activity of *Hypericum* was due to monoamine oxidase inhibitor (MAO-I) by the **naphodianthrones, hypericin** and **pseudo-hypericin** (Bladt and Wagner, 1994; Thiede and Walper, 1994). These compounds also show significant activity at D(3)- and D(4)-dopamine receptors and  $\beta$ -adrenergic receptors (Denke et al., 2000). As a result, St. John's wort products, standardized to contain concentrations of hypericin, began to sprout on the shelves of stores that sold herbal products.

Dr. Jerry Cott, at one time chief of the Pharmacologic Treatment Program of the National Institute of Mental Health, told us that even though *Hypericum* is a leading antidepressant, its MAO inhibitory activity is much less than we previously believed. The MAO inhibition, and perhaps other reported activities, may occur only in the test tube. But clearly, something in *Hypericum* makes it considerably better than a placebo, making *Hypericum* outsell all other antidepressants combined in Germany.

Continued research plucked out further constituents that demonstrated activity. Three xanthenes from a Brazilian *Hypericum* species also selectively inhibited MAO-A and MAO-B (Hostettmann, 1995). One was comparable to harmaline from the famed Amazonian hallucinogen, ayahuasca, which might also be useful in depression.

Additionally, **amentoflavone**, a flavonoid dimer occurring in *Hypericum*, demonstrated a high affinity for the benzodiazepine receptor (Baureithel et al., 1997; Hanrahan et al., 2003). And although amentoflavones are not known to readily pass through the blood-brain barrier, other constituents of *Hypericum* appear to facilitate this process (Gutmann et al., 2002). Amentoflavone also showed significant inhibition binding to serotonin (5-HT(1D), 5-HT(2C)), D(3)-dopamine, and  $\delta$ -opiate (Denke et al., 2000).

The **phloroglucinol, hyperforin**, also showed significant antidepressant activity when isolated from extracts of *Hypericum perforatum*. Experimental studies clearly demonstrate its activity in different behavioral models of depression (Zanoli, 2004). Moreover, clinical studies linked the therapeutic efficacy of *Hypericum* extracts to their hyperforin content, in a dose-dependent manner. The activity appears to be via reuptake inhibition. Hyperforin inhibits the reuptake of serotonin, dopamine, norepinephrine,  $\gamma$ -aminobutyric acid, and L-glutamate (Zanoli, 2004). Reuptake inhibition is also the mechanism of activity for the newest class of antidepressants, known as **SSRIs (selective serotonin reuptake inhibitors)** that are now the most widely prescribed antidepressants worldwide (Golden, 2004). Of the 24.5 million estimated national number of physician visits by patients with depression in 2001, 89% were given antidepressant pharmaceuticals in the United States (Stafford et al., 2001). But the frequency of side effects is astounding. One study suggested that 86% of patients using SSRIs have at least one side effect, while 55% experience one or more bothersome side effects. Interestingly, physicians tended to underestimate the occurrence and how bothersome the side effects were (Hu et al., 2004). Even though manufacturers are now standardizing concentrations of hyperforin in some St. John's wort products, hyperforin has shown less activity than other St. John's wort constituents, with the exception of the D(1)-dopamine receptor (Butterweck et al., 2002).

So what is the "active" constituent of St. John's wort? Hyperforin, the flavonoids **rutin, hyperoside, isoquercitrin, quercitrin**, the biflavonoids **biapigenin** (Schulte-Lobbert et al., 2004) and amentoflavone (Baureithel et al., 1997; Hanrahan et al., 2003), as well as the **naphodianthrones** hypericin and pseudohypericin (Bladt and Wagner, 1994; Thiede and Walper, 1994) all show activity. America's late emeritus pharmacognosist Varro Tyler (1997) said that "different chemical compounds in St. John's wort work together to relieve mild depression in several different ways. The advantage of this combined action is fewer side effects for the consumer because the total response is not due to a single strong action." Butterweck et al. (2002) hypothesized that additive or synergistic activity of multiple constituents may be responsible for the antidepressant efficacy of St. John's wort. We suggest that the "active" part of St. John's wort is the matrix of chemicals that make up the plant.

### 13.5.16 Hypertension

One **phthalide**, **3-*n*-butyl-phthalide**, occurring in celery, is said to relax the smooth muscle linings of the blood vessels, thereby lowering blood pressure. Phthalide works directly by dilating vessels. Many current antihypertensive agents work by more roundabout mechanisms and may have troubling side effects, such as fainting, drowsiness, or impotence. Remember that drowsiness might also be a side effect of celery, because phthalides are natural sedatives as well. Perhaps this sedative activity could translate into reduced stress, further translating into reduced cardiopathy. Unfortunately, celery is rather high in sodium, which is often counterindicated in hypertension. But, in addition to the phthalides, celery is fairly well endowed with a few other hypotensive compounds, including **ascorbic acid**, **bergapten** (sometimes phototoxic), fiber, magnesium, and **rutin**. So, there are at least six hypotensive ingredients in celery. Duke (2002) recounted a study showing that celery juice proved hypotensive in 14 of 16 males taking 40 ml (a generous shot-glass full) orally three times a day with honey or syrup.

Celery is closely related to the herb, angelica, mentioned earlier (Harmala et al., 1992) as containing 15 calcium-antagonistic compounds. Celery has three of these: **bergapten** 1 to 520 ppm, **isopimpinellin** 4 to 122 ppm, and **xanthotoxin** 6 to 183 ppm. Parsnip and parsley are even better endowed with the coumarin calcium blockers. We are not about to suggest ingestion of **coumarins** in foods as calcium antagonists, but we are asking our federal health watchers: would angelade, that is, juiced angelica, caraway, carrot, celery, fennel, parsley, and parsnip, be as safe, efficacious, and inexpensive as the calcium channel blocker verapamil? Could this be a partial explanation of the lower incidence of cardiopathy in vegetarians? Celery contains hypotensive, hypocholesterolemic, and calcium-blocker phytochemicals. As for antiarrhythmic compounds, there are apigenin, apiin, magnesium, and potassium present. Aside from a single biochemical effect, do these multiple activities have a synergic outcome on health? We refer to the introduction, where the study by Law et al. (2003) was discussed. Law and colleagues showed that two or more pharmaceuticals used at low dose, often proved more effective than one pharmaceutical used at higher doses, and they showed that using multiple low-dose agents was safer because of a reduction in side effects (Law et al., 2003). Could consumption of plants as medicine, with their multiple activities and low dose of constituents, represent a much more comprehensive strategy for health?

Duke replaced his antigout, hypouricemic allopurinol, with celery seed extracts, two capsules, and four stalks of celery a day for more than 8 years and experienced no gout attacks. With more than two dozen anti-inflammatory compounds ( **$\alpha$ -pinene**, **apigenin**, **ascorbic-acid**, **bergapten**, **butylidene-phthalide**, **caffeic acid**, **chlorogenic acid**, **cnidilide**, **copper**, **coumarin**, **eugenol**, **ferulic acid**, **gentisic acid**, **isopimpinellin**, **linoleic acid**, **luteolin**, **magnesium**, **mannitol**, **myristicin**, **protocatechuic acid**, **quercetin-3-galactoside**, **rutin**, **scopoletin**, **thymol**, **umbelliferone**, and **xanthotoxin**) and high in COX-2 inhibitor, apigenin, and a generous dose of **uric acid**, reducing fiber, celery seed might prove synergically useful in gout and other types of arthritis. Interestingly, celery seed was suggested for gout by Hildegard von Bingen and Ayurvedic doctors more than a millennium ago.

### 13.5.17 *Melissa*

*Melissa* (lemon balm) volatile oil is used as a sedative, a spasmolytic, and an antibacterial agent. The sedative action is attributed largely to **citronellal** with other terpenes (see Chapter 1), such as **citronellol**, **geraniol**, **caryophyllene**, **linalool**, **citral**, **limonene**, and **eugenol**, contributing to the effect.

Buchbauer stated that mere inhalation of lemon balm oil has a “very good sedative effect.... You need not a massage” (1993). Elsewhere, Buchbauer warned that dermal absorption of these essential oil ingredients may be 100 times greater than by inhalation or “aromatherapy” (Buchbauer, 1990).

The sedative ingredients mentioned by Tyler (1992) occur in many aromatic plants and may be even more concentrated in arid-land plants than in *Melissa*. If, as Buchbauer states, inhalation has a measurable effect, and dermal application is 100 times stronger, one might look for pronounced sedation with *Melissa* in the bath or in an oil-based massage. From Duke (1992a), we list the quantitative values (see Tables 13.4 and 13.5) for some of these reportedly sedative compounds we calculated for *Melissa*.

The optimistic interpretation of the above data is that we could, on a dry weight basis at least, expect no more than 975 ppm of the major “actor,” citronellal, and no more than 250 ppm of the other “supporting

TABLE 13.4

Alternative Sources of “Sedative” Terpenes

Terpene	Lemon Balm	Lemon Eucalyptus	Ginger	Juniper	Java Citronella
Caryophyllene	9–238	15–780	—	12–120	84–147
Citra	—	—	0–13,500	—	8–14
Citronella	1–2 (1975) <sup>a</sup>	50–18,020	2–145	160	1000–2289
Citronellol	—	230–4000	2–6500	—	440–770
Eugenol	—	—	—	—	66–233
Geraniol	1–2	250–1000	2–345	—	1064–3150
Limonene	—	20–1420	17–1050	76–910	80–350
Linalool	1–10	15–180	2–1500	—	40–105

<sup>a</sup> The count is 1–975 ppm if [+]-citronellal is included.

Note: All quantities are in ppm.

From Duke, J.A. (1992). *CRC Handbook of Biologically Active Phytochemicals and Their Activities*. CRC Press, Boca Raton, FL. With permission.

TABLE 13.5

Lesser Sources of “Sedative” Terpenes

Terpene	Tangerine	Lemongrass	Lemon Verbena	Basil	Lime
Caryophyllene	—	30–266	0–3196	30–250	2–9
Citra	1080–3480	260–182	560–7000	—	—
Citronella	—	—	—	140	1–20
Citronellol	—	10–170	3–2419	—	1–50
Eugenol	—	—	35–8575	—	—
Geraniol	10–36	5–420	1–1000	—	1–4
Limonene	—	42–1050	2–934	4700–7500	6500–9400
Linalool	1–10	5–35	5–8730	9–20	3–610

Note: All quantities are in ppm.

From Duke, J.A. (1992). *CRC Handbook of Biologically Active Phytochemicals and Their Activities*, CRC Press, Boca Raton, FL. With permission.

actors” from *Melissa*, if our database reflects the true world. *Eucalyptus citriodora* and *Java citronella* certainly look more promising.

If lemon balm, with its 1 to 2 ppm (to 975 ppm, if you count [+]-citronellal) citronellal and no more than 250 ppm “supporting actors,” is a good sedative; lemon-scented *Eucalyptus citriodora* with up to 18,000 ppm citronellal should be a better sedative, as should leaves of *Citrus limon* (up to 89,000 ppm in the essential oil) and *Cymbopogon winterianus* (to 2250 ppm). Even the fruits of juniper, used in making gin, may contain 140 ppm citronellal, and ginger (rich in other “supporting actors” and richest in citronellol) may contain 145 ppm citronellal, all on a dry weight basis. We can see the makings of a good sedative bedtime gin and citronellal, gin and any safe lemon-scented leaf you can find, plus a little basil (high in **citronellol**), biblical mint (*Mentha longifolia*, rich in **caryophyllene** and **linalool**), caraway (rich in **limonene**), coriander (rich in linalool), cloves (highest in **eugenol** and good tasting), and ginger and thyme (high in **geraniol**). The gin might induce sleep, if these reputed herbal sedatives did not. Our database suggests that gin, with eucalyptus lemonade, could be a very pleasant sedative.

### 13.5.18 Duke on Dragon’s Blood

A longtime associate of Duke, Antonio Montero Pisco, the shamanistic forest “medicine man” planted dragon’s blood and some 250 other Amazonian medicinal plants in two Medicinal Plant Gardens in Peru, one in Lareto, the other in Madre de Dios.

Dragons’ blood, known to the shaman as “sangregrado,” and to others as “sangre de drago,” is a euphorbiaceous (spurge family) weed tree, *Croton lechleri*, also very important to the former Shaman

Pharmaceuticals Company, San Francisco, California, who got two drugs derived from the plant into clinical trials. Shaman Pharmaceutical's Provir™ effectively treated 89% of patients with diarrhea in a phase-II trial, according to their press release of November 7, 1996. They had successfully completed a phase-II trial of 75 patients afflicted with acute diarrhea, including travelers' diarrhea and nonspecific diarrhea of unknown etiology. Overall, 89% of the 75 patients treated with their trademarked Provir experienced rapid return to normal bowel function. Of 71 patients available for follow-up, none experienced recurrence. No significant adverse reactions were reported. Of 25 traveler's diarrhea patients getting 1 to 2 g·d<sup>-1</sup> Provir, 72% returned to normal in 48 h instead of the usual 5 to 7 d. For reasons not discussed, the 1 g dose was more effective than the 2 g dose. Provir acts by inhibiting the secretion of chloride ions from the epithelial cells lining the small intestine and the subsequent accumulation of fluid in the intestine. In contrast to conventional treatments, Provir is not absorbed systemically and appears to have no effect on gastrointestinal motility. This indicates a potential use for treatment of bacterial, parasitic, and viral diarrhea.

Pisco uses whole dragon's blood topically, among other things, to treat cuts and sores. Pisco uses the whole dragon's blood rather than isolated "silver bullets" from the dragon's blood. Most pharmaceutical firms go for the isolated "**silver magic bullet**" rather than the synergic whole. Recently, Dutch scientists demonstrated synergy of dimethylcedrusine, pycnogenol, and taspine, parts of that whole extract called dragon's blood. They were synergic in causing wounds in exfoliated rats to heal. The isolated compounds caused granulation of excision wounds in 4 d, while the synergic whole extract accomplished the job in just 1 d. That is why we would use dragon's blood, should we get a cut or abrasion in tropical Peru. And if we were to contract cholera in Peru and had no doctor or pharmaceutical available, we would take orally whole dragon's blood preparation. Pisco recommended the whole dragon's blood, which, at least for some indications, has proven better than the sum of its parts.

### 13.5.19 Duke's Plea for Reason: Malaria, Politics, Economics, and a Simple Plant

In the introduction, we noted that many pharmaceuticals are synergic in antimalarial drug cocktails with **artemisinin**, the silver bullet from *Artemisia annua*. But when pharmaceutical firms isolate artemisinin, they not only create a drug financially beyond the reach of most people suffering from malaria, they also raise the probability of generating drug resistance (see Chapter 8 on bioseparations). *Artemisia annua* as an inexpensive weed can contain at least ten natural antiseptic, if not also antimalarial compounds, some proven synergic with each other. Malarial resistance is less likely to develop to this natural cocktail of ten phytochemicals. Pharmacologists, physicians, and philanthropists, such as Bill Gates, might be surprised (we would not) if the weed proved as effective as the overexpensive artesunate and artemisinin. Perhaps the herb alone, with its cocktail of natural chemicals, would be as effective as the expensive pharmaceutical cocktail. Using a million dollars worth of the natural chemical cocktail might accomplish more for underdeveloped countries than a billion dollars worth of the pharmaceutical cocktail. The natural cocktail would surely be cheaper, might be safer, and almost assuredly would be less likely to generate drug resistance. We will never know for sure until there are clinical comparisons. However, there might not be any comparative trials, because such trials (like the 2002 *JAMA* comparison of St. John's wort with Zoloft® which showed equal ineffectiveness) might show that the cheap natural drug was comparable to the billion dollar pharmaceutical; the cheaper natural drug might be advantageous to the public while creating a distinct disadvantage for the pharmaceutical firms. Given the above research cited on *Artemisia annua*, this seems distinctly possible. Imagine an Africa (or any other malarial country) where all people had access to malarial medication.

Readers can find the *Artemisia annua* cocktail of antimalarials (**artemetin, artemisinin, ascaridole, casticin, chryso splenetin, chryso splenol-D, cirsilineol, eupatorin, oleanolic-acid, and quercetin**) in the United States Department of Agriculture (USDA) database ([www.ars-grin.gov/duke](http://www.ars-grin.gov/duke)).

There is also a USDA query termed a "**Multiple Activity Menu (M.A.M.)**" ([www.ars-grin.gov/duke/dev/all.html](http://www.ars-grin.gov/duke/dev/all.html)). With that query, one can ask the database for the more promising biological activities against a given disease, and a listing of the contained phytochemicals (see below for *Artemisia annua* and malaria) reported to possess those activities.

**TABLE 13.6**Multiple Activity Menu; *Artemisia annua* and Malaria

Antihepatotoxic	Oleanolic acid; quercetin; scoparone; scopoletin
Antimalarial	Artemetin; artemisinin; ascaridole; casticin; chryso-splenetin; chryso-splenol-D; cirsilineol; eupatorin; oleanolic acid; quercetin
Antiplasmodial	Chryso-splenetin; chryso-splenol-D; oleanolic acid; quercetin
Antipyretic	$\alpha$ -Bisabolol; borneol; menthol
Antiseptic	1,8-Cineole; $\alpha$ -bisabolol; $\alpha$ -terpineol; arteannuin-B; $\beta$ -pinene; camphor; carvacrol; carvone; geraniol; kaempferol; limonene; linalool; menthol; oleanolic acid; rhamnocitrin; scopoletin; terpinen-4-ol; thymol
Hepatoprotective	Borneol; isorhamnetin; kaempferol; luteolin; oleanolic-acid; quercetin; rhamnetin; scoparone; scopoletin
Immunostimulant	Astragalin; coumarin; eupatorin
Larvicide	Urninaldehyde; linalool; thymol
MDR-inhibitor	Artemisinin; chryso-splenetin; chryso-splenol-D
Parasiticide	Artemetin; casticin; chryso-splenetin; chryso-splenol-D; cirsilineol; eupatorin
Protisticide	$\alpha$ -Bisabolol; artemetin; casticin; chryso-splenetin; kaempferol

We can conduct such queries for most important medicinal species for many significant pathologies, like malaria.

Table 13.6 is modified from the USDA M.A.M. query. We can conduct such queries for most important medicinal species (>1000 species), for many important pathologies (~100 ailments), like malaria. We can even design beverages, salads, and soups to contain a dozen, for example, MDR-inhibiting phytochemicals. An antimalarial gin tincture of cinchona bark and sweet annie (*Artemisia annua*) is one such beverage.

## 13.6 Conclusions

Plants persist due to millions of years of evolution perfecting the allelochemistry they developed. We believe that evolutionary optimization of these chemical defenses would imply synergy, a potentiation of biological activity perfected over a planetary time scale. Plant-based isolated constituents, coupled with the pharmacological tenets of selectivity, potency, and acceptable toxicity, provided a remarkable contribution to medicine. Our argument is not an argument against the benefits of single chemicals. Many advancements in medicine resulted from the isolation and purification of chemical compounds.

However, there appear to be unique features of herbal medicines that contribute to both the efficacy and safety of plant medicines. Throughout the history of eukaryotic organisms and humanoid development, many, if not all, of the phytochemicals that plants generated for protection were ingested. Due to an evolutionary history of recurrent interactions between complex phytochemistry and eukaryotic biology, a plant's multiconstituent nature could form a higher order of organization with biological systems. This economy of chemistry, an efficient and broad-spectrum matrix of constituents, acts on not just one target, but on multiple targets, functionally converging on protective bioactivity against pests. It seems logical to speculate, if not conclude, that the same evolved synergies for biological activity apply to the medicinal bioactivity of plants to humans. This creates the possibility of different biochemical pathways convening on a positive physiological outcome (Wang et al., 2004; Williamson, 2001) and allows for the emergence of synergy. Furthermore, the use of phytomedicines, as compared with isolated chemicals, may offer a safer clinical strategy in the treatment of many diseases (Ernst, 2003).

As phytomedicines gain popularity, it is essential to educate the medical and scientific establishment that the pharmacological model of isolating constituents may not be the best methodology for the study of herbal medicines. The potentiation (or antagonism) provided by perturbation of multiple pharmacological targets converging in parallel biochemical pathways is often missed by standard laboratory searches for activity. If a chemical matrix is necessary for activity in phytomedicines, then many remedies from the purification process from whole plant to isolated constituent may be overlooked (Wang et al.,



2004; Williamson, 2001). Ultimately, effective research into the mechanisms of actions of phytomedicines will need to account for the possibility, indeed the probability, of synergistic activity between multiple constituents.

Although demonstration of synergy in research laboratories is rapidly increasing, there is limited demonstration of synergy in the literature for two main reasons (Wang et al., 2004). First, most laboratories follow the logic of Ockham's Razor in their modeling and do not look for synergic activity. Single chemicals interacting with one receptor or enzyme system, although informative, keeps researchers focused on a narrow level of function. This obstructs the observation of higher levels of organization that are likely involved in chemical matrices. Second, proving synergic activity requires an enormous commitment of time and resources. Individual components of a mixture would have to be tested and then compared with an equivalent dose in a mixture, a process beyond the means of many institutions (Wang et al., 2004).

Additionally, due to the economics of the pharmaceutical industry, it has proven economically more attractive to pharmaceutical firms to select what a particular model demonstrates as the most active compounds within a species, and to abandon the synergic mix that we suppose is common. We predict that as pathogens develop resistance to singular chemical drugs, we will see the utilization of more drug combinations and cocktails. Perhaps the medical community will realize that phytochemical matrices can lead to superior medicines, such as reproducible extracts of these herbs containing several closely related synergic phytochemicals in their evolutionary ratios. We will then use rather than ignore this economy of chemistry, a technology developed by nature. Instead of costly synergic mixtures of unnatural compounds, like the \$16,000-a-year AIDS cocktail, there could be a development of low-toxicity synergic formulas of antiviral, antiyeast, antieboli, antibacterial, antiescherichial, anticancer, and antitumor compounds. Ironically, they will have evolved from the opposite direction to the same logical point that the crude herb industry has found — using extracts of biologically active plants containing synergic mixes of phytochemicals that evolved to protect life from predation.

Moreover, there will be an even greater synergy when the best of complementary alternative medicine and allopathic medicines are truly integrated into a holistic medical model that uses the best of all available medicines. Until the holistic reach of the “herbal shotgun” has been compared in unbiased scientific head-on trials with the solitary “silver synthetic bullet,” we will not know which is superior. Is the synergic mixture of compounds in *Hypericum* better (and less expensive, more efficacious, safer) as an antidepressant and antiviral treatment protocol than Prozac™ and Acyclovir™? Is the natural mixture of sterols in saw palmetto better than pure isolated  $\beta$ -sitosterol or synthetic finasteride? Is the synergic mixture of **parthenolides** in feverfew (*Chrysanthemum parthenium*) better, cheaper, or safer than Sumatriptan™ at treating migraine? Is the natural mixture of lignans in mayapple (*Podophyllum peltatum*) better, cheaper, or safer at killing cancers *in vivo* as has been shown for arresting herpes virus *in vitro*, than isolated purified lignans, or semisynthetic derivatives thereof? Is the mixture of choline-sparing compounds in rosemary and sage better, cheaper, or safer than Tacrine™ for treating and preventing Alzheimer's disease? We do not yet know the answers to any of these and a hundred other similar herbal-alternative questions.

Allowing for such research will require not only a paradigm shift for many medical scientists, but also an acceptance of the profound response of biology to the internal and external environments. Such a perceptual shift makes space for the potential of plants as medicine and the ability of an organism, as a unique genome, to translate this complex information into its phenotype. Hoffman and co-workers express our view well:

But we would argue that in the complex dance of ingenuity that is modern science, in the gaining of reliable knowledge, one should beware of the inherent weaknesses of the beautiful human mind. The most prominent shortcoming is not weak logic, but prejudice, preferring simple solutions. The uncritical application of Ockham's Razor plays to that weakness. What is worse, it dresses up that weakness in the pretense of logical erudition (1997).

---

## References

- Ariga, T., K. Tsuj, T. Seki, T. Moritomo, and J. Yamamoto. (2000). Antithrombotic and antineoplastic effects of phyto-organosulfur compounds. *Biofactors* 13: 251–255.
- Bajetta, E., E. Beretta, M. Di Bartolomeo, D. Cortinovis, E. Ferrario, G. Dognini, L. Toffolatti, and R. Buzzoni. (2004). Efficacy of treatment with irinotecan and oxaliplatin combination in FU-resistant metastatic colorectal cancer patients. *Oncology* 66: 132–137.
- Baumann, F., M. Bjeljac, S.S. Kollias, B.G. Baumert, S. Brandner, V. Rousson, Y. Yonekawa, and R.L. Bernays. (2004). Combined thalidomide and temozolomide treatment in patients with glioblastoma multiforme. *J Neurooncol* 67: 191–200.
- Baureithel, K.H., K.B. Buter, A. Engesser, W. Burkard, and W. Schaffner. (1997). Inhibition of benzodiazepine binding *in vitro* by amentoflavone, a constituent of various species of *Hypericum*. *Pharm Acta Helv* 72: 153–157.
- Beckstrom-Sternberg, S.M. and J.A. Duke. (1994). Potential for synergistic action of phytochemicals in spices. In *Spices, Herbs and Edible Fungi*, G. Charalambous (Ed.). Elsevier, Amsterdam; New York, pp. 201–223.
- Bedows, E. and G.M. Hatfield. (1982). An investigation of the antiviral activity of *Podophyllum peltatum*. *J Nat Prod* 45: 725–729.
- Beier, R.C. and H.N. Nigg. (1992). Natural toxicants in food. In *Phytochemical Resources for Medicine and Agriculture*, H.N. Nigg and D.S. Seigler (Eds.). Plenum Press, New York, pp. 247–238.
- Bidoli, E., C. Bosetti, C. La Vecchia, F. Levi, M. Parpinel, R. Talamini, E. Negri, L.D. Maso, and S. Franceschi. (2003). Micronutrients and laryngeal cancer risk in Italy and Switzerland: a case-control study. *Cancer Causes Control* 14: 477–484.
- Bladt, S. and H. Wagner. (1994). Inhibition of MAO by fractions and constituents of hypericum extract. *J Geriatr Psychiatry Neurol* 7 (Suppl 1): S57–S59.
- Block, E., S. Ahmad, M.K. Jain, R.W. Creceley, R. Apitz Castro, and M.R. Cruz. (1984). (E,Z) Ajoene: a potent antithrombic agent from garlic. *J Am Chem Soc* 106: 8295–8296.
- Bors, W., C. Michel, and S. Schikora. (1995). Interaction of flavonoids with ascorbate and determination of their univalent redox potentials: a pulse radiolysis study. *Free Radic Biol Med* 19: 45–52.
- Brown, J., and B.B. Freeman, III. (2004). Combining quinupristin/dalfopristin with other agents for resistant infections. *Ann Pharmacother* 38: 677–685.
- Buchbauer, G. (1990). Phytopharmaka und pharmakologie. *Deutsche Apot Zeit* 130: 2407–2410.
- Buchbauer, G. (1993). Discussion on *Melissa officinalis* essential oil. (J.A. Duke, Ed.), telephone conversation, Beltsville, MD.
- Bulgheroni, E., P. Citterio, F. Croce, M. Lo Cicero, O. Vigano, F. Soster, T.C. Chou, M. Galli, and S. Rusconi. (2004). Analysis of protease inhibitor combinations *in vitro*: activity of lopinavir, amprenavir and tipranavir against HIV type 1 wild-type and drug-resistant isolates. *J Antimicrob Chemother* 53: 464–468.
- Butterweck, V., A. Nahrstedt, J. Evans, S. Hufeisen, L. Rauser, J. Savage, B. Popadak, P. Ernsberger, and B.L. Roth. (2002). *In vitro* receptor screening of pure constituents of St. John's wort reveals novel interactions with a number of GPCRs. *Psychopharmacology (Berl)* 162: 193–202.
- Campbell, J., J. King, M. Lila, and J.J. Erdman. (2003). Antiproliferation effects of tomato polyphenols in Hepa1c1c7 and LNCaP cell lines. *J Nutrition* 133: 3858S–3859S.
- Charurat, M., W. Blattner, R. Hershov, A. Buck, C.D. Zorrilla, D.H. Watts, M. Paul, S. Landesman, S. Adeniyi-Jones, and R. Tuomala. (2004). Changing trends in clinical AIDS presentations and survival among HIV-1-infected women. *J Womens Health (Larchmt)* 13: 719–730.
- Chawira, A.N., D.C. Warhurst, B.L. Robinson, and W. Peters. (1987). The effect of combinations of qinghaosu (artemisinin) with standard antimalarial drugs in the suppressive treatment of malaria in mice. *Trans R Soc Trop Med Hyg* 81: 554–558.
- Chen, Q., H. Shi, and C.T. Ho. (1992). Effects of rosemary extracts and major constituents on lipid oxidation and soybean lipoxygenase activity. *J Am Oil Chem Soc* 69: 999–1002.
- Cichewicz, R.H., Y. Zhang, N.P. Seeram, and M.G. Nair. (2004). Inhibition of human tumor cell proliferation by novel anthraquinones from daylilies. *Life Sci* 74: 1791–1799.

- Cooper, R.S. (2003). Gene–environment interactions and the etiology of common complex disease. *Ann Intern Med* 139: 437–440.
- Cott, J. (1995). Medicinal plants and dietary supplements: sources for innovative treatments or adjuncts: an introduction. *Psychopharm Bull* 31: 131–137.
- Cott, J.M. (2001). Herb–drug interactions: focus on pharmacokinetics. *CNS Spectr* 6: 827–832.
- Delaquis, P.J., K. Stanich, B. Girard, and G. Mazza. (2002). Antimicrobial activity of individual and mixed fractions of dill, cilantro, coriander and eucalyptus essential oils. *Int J Food Microbiol* 74: 101–109.
- Delgado, G., Jr., M.M. Neuhauser, D.T. Bearden, and L.H. Danziger. (2000). Quinupristin-dalfopristin: an overview. *Pharmacotherapy* 20: 1469–1485.
- Della Loggia, R., S. Sosa, A. Tubaro, P. Morazzoni, E. Bombardelli, and A. Griffini. (1996). Anti-inflammatory activity of some Ginkgo biloba constituents and their phospholipid-complexes. *Fitoterapia* 67: 257–264.
- Denke, A., H. Schempp, D., Weiser, and E.F. Elstner. (2000). Biochemical activities of extracts from *Hypericum perforatum* L. 5th communication: dopamine–hydroxylase-product quantification by HPLC and inhibition by hypericins and flavonoids. *Arzneimittelforschung* 50: 415–419.
- Dixon, R.A. (1999). Plant natural products: the molecular genetic basis of biosynthetic diversity. *Curr Opin Biotechnol* 10: 192–197.
- Duke, J.A. (1992a). *Handbook of Biologically Active Phytochemicals and Their Activities*. CRC Press, Boca Raton, Florida.
- Duke, J.A. (1992b). *Handbook of Phytochemical Constituents of GRAS Herbs and Other Economic Plants*. CRC Press, Boca Raton, Florida.
- Duke, J.A. (1992c). Mint tease and the cumulative antioxidant index. *Trends Food Sci Tech* 3: 120.
- Duke, J.A. (2002). *Handbook of Medicinal Herbs*, 2nd ed. CRC Press, Boca Raton, Florida.
- Dyer, L.A., C.D. Dodson, J.O. Stireman, M.A. Tobler, A.M. Smilanich, R.M. Fincher, and D.K. Letourneau. (2003). Synergistic effects of three Piper amides on generalist and specialist herbivores. *J Chem Ecol* 29: 2499–2514.
- Edris, A.E. and E.S. Farrag. (2003). Antifungal activity of peppermint and sweet basil essential oils and their major aroma constituents on some plant pathogenic fungi from the vapor phase. *Nahrung* 47: 117–121.
- Elford, B.C., M.F. Roberts, J.D. Phillipson, and R.J. Wilson. (1987). Potentiation of the antimalarial activity of qinghaosu by methoxylated flavones. *Trans R Soc Trop Med Hyg* 81: 434–436.
- Ernst, E. (2003). Herbal medicines put into context. *BMJ* 327: 881–882.
- Ferri, N., K. Yokoyama, M. Sadilek, R. Paoletti, R. Apitz-Castro, M.H. Gelb, and A. Corsini. (2003). Ajoene, a garlic compound, inhibits protein prenylation and arterial smooth muscle cell proliferation. *Br J Pharmacol* 138: 811–818.
- Filipe, P., V. Lanca, J.N. Silva, P. Morliere, R. Santus, and A. Fernandes. (2001). Flavonoids and urate antioxidant interplay in plasma oxidative stress. *Mol Cell Biochem* 221: 79–87.
- Firm, R.D. and C.G. Jones. (2000). The evolution of secondary metabolism — a unifying model. *Mol Microbiol* 37: 989–994.
- Fuhrman, B., N. Volkova, M. Rosenblat, and M. Aviram. (2000). Lycopene synergistically inhibits LDL oxidation in combination with vitamin E, glabridin, rosmarinic acid, carnosic acid, or garlic. *Antioxidants & Redox Signaling* 2: 491–506.
- Fujita, Y., I. Uehara, Y. Morimoto, M. Nakashima, T. Hatano, and T. Okuda. (1988). Studies on inhibition mechanism of autoxidation by tannins and flavonoids. II. Inhibition mechanism of caffeetannins isolated from leaves of *Artemisia* species on lipoxygenase dependent lipid peroxidation. *Yakugaku Zasshi* 108: 129–135.
- Gabriel, S.B., S.F. Schaffner, H. Nguyen, J.M. Moore, J. Roy, B. Blumenstiel, J. Higgins, M. DeFelice, A. Lochner, M. Faggart, S.N. Liu-Cordero, C. Rotimi, A. Adeyemo, R. Cooper, R. Ward, E.S. Lander, M.J. Daly, and D. Altshuler. (2002). The structure of haplotype blocks in the human genome. *Science* 296: 2225–2229.
- Golden, R.N. (2004). Making advances where it matters: improving outcomes in mood and anxiety disorders. *CNS Spectr* 9: 14–22.
- Gutmann, H., R. Bruggisser, W. Schaffner, K. Bogman, A. Botomino, and J. Drewe. (2002). Transport of amentoflavone across the blood–brain barrier *in vitro*. *Planta Med* 68: 804–807.
- Hanrahan, J.R., M. Chebib, N.L. Davucheron, B.J. Hall, and G.A. Johnston. (2003). Semisynthetic preparation of amentoflavone: a negative modulator at GABA(A) receptors. *Bioorg Med Chem Lett* 13: 2281–2284.

- Hardy, G., I. Hardy, and P.A. Ball. (2003). Nutraceuticals — a pharmaceutical viewpoint: part II. *Curr Opin Clin Nutr Metab Care* 6: 661–671.
- Harmala, P., H. Vuorela, K. Tornquist, and R. Hiltunen. (1992). Choice of solvent in the extraction of *Angelica archangelica* roots with reference to calcium blocking activity. *Planta Med* 58: 176–183.
- Hoffman, R., V.I. Minkin, and B.K. Carpenter. (1997). Ockham's Razor and chemistry. *Internat J Philos Chem* 3: 3–28.
- Hostettmann, K. (1995). *Phytochemistry of Plants Used in Traditional Medicine*. Clarendon Press, Oxford; New York.
- Houghton, P. (2004). Activity and constituents of sage relevant to the potential treatment of symptoms of Alzheimer's disease. *HerbalGram* 61: 38–53.
- Hu, X.H., S.A. Bull, E.M. Hunkeler, E. Ming, J.Y. Lee, B. Fireman, and L.E. Markson. (2004). Incidence and duration of side effects and those rated as bothersome with selective serotonin reuptake inhibitor treatment for depression: patient report versus physician estimate. *J Clin Psychiatry* 65: 959–965.
- Ittarat, W., A.L. Pickard, P. Rattanasingchan, P. Wilairatana, S. Looareesuwan, K. Emery, J. Low, R. Udomsangpetch, and S.R. Meshnick. (2003). Recrudescence in artesunate-treated patients with falciparum malaria is dependent on parasite burden not on parasite factors. *Am J Trop Med Hyg* 68: 147–152.
- Jang, M., L. Cai, G.O. Udeani, K.V. Slowing, C.F. Thomas, C.W. Beecher, H.H. Fong, N.R. Farnsworth, A.D. Kinghorn, R.G. Mehta, R.C. Moon, and J.M. Pezzuto. (1997). Cancer chemopreventive activity of resveratrol, a natural product derived from grapes. *Science* 275: 218–220.
- Jayasinghe, C., N. Gotoh, T. Aoki, and S. Wada. (2003). Phenolics composition and antioxidant activity of sweet basil (*Ocimum basilicum* L.). *J Agric Food Chem* 51: 4442–4449.
- Kliger, B., V. Maizes, S. Schachter, C.M. Park, T. Gaudet, R. Benn, R. Lee, and R.N. Remen. (2004). Core competencies in integrative medicine for medical school curricula: a proposal. *Acad Med* 79: 521–531.
- Koch, H.P. and L.D. Lawson. (1996). *Garlic: The Science and Therapeutic Application of Allium sativum L. and Related Species*, 2nd ed. Williams & Wilkins, Baltimore.
- Koul, O., J.S. Multani, G. Singh, W.M. Daniewski, and S. Berlozecki. (2003). 6-hydroxygedunin from *Azadirachta indica*. Its potentiation effects with some non-azadirachtin limonoids in neem against lepidopteran larvae. *J Agric Food Chem* 51: 2937–2942.
- Kumar, J. and B. Parmar. (1996). Physicochemical and chemical variation in neem oils and some bioactivity leads against *Spodoptera litura* F. *J Agric Food Chem* 44: 02137–02143.
- La Vecchia, C., A. Altieri, and A. Tavani. (2001). Vegetables, fruit, antioxidants and cancer: a review of Italian studies. *Eur J Nutr* 40: 261–267.
- Lamaison, J.L., C. Petitjean-Freytet, F. Duband, and A.P. Carnat. (1991). Rosmarinic acid content and antioxidant activity in French Lamiaceae. *Fitoterapia* 62: 166–171.
- Law, M.R., N.J. Wald, J.K. Morris, and R.E. Jordan. (2003). Value of low dose combination treatment with blood pressure lowering drugs: analysis of 354 randomised trials. *BMJ* 326: 1427.
- Lederman, M.M., E. Connick, A. Landay, D.R. Kuritzkes, J. Spritzler, M. St. Clair, B.L. Kotzin, L. Fox, M.H. Chiozzi, J.M. Leonard, F. Rousseau, M. Wade, J.D. Roe, A. Martinez, and H. Kessler. (1998). Immunologic responses associated with 12 weeks of combination antiretroviral therapy consisting of zidovudine, lamivudine, and ritonavir: results of AIDS Clinical Trials Group Protocol 315. *J Infect Dis* 178: 70–79.
- Li, J.Y., B. Li, W.J. Blot, and P.R. Taylor. (1993). Preliminary report on the results of nutrition prevention trials of cancer and other common diseases among residents in Linxian, China. *Zhonghua Zhong Liu Za Zhi* 15: 165–181.
- Liu, R.H. (2002). Supplement quick fix fails to deliver. *Food Technol Int* 1: 71–72.
- Liu, R.H. (2003). Health benefits of fruit and vegetables are from additive and synergistic combinations of phytochemicals. *Am J Clin Nutr* 78: 517S–520S.
- Mathew, B.C., N.V. Prasad, and R. Prabodh. (2004). Cholesterol-lowering effect of organosulphur compounds from garlic: a possible mechanism of action. *Kathmandu Univ Med J (KUMJ)* 2: 100–102.
- Mertens-Talcott, S.U., S.T. Talcott, and S.S. Percival. (2003). Low concentrations of quercetin and ellagic acid synergistically influence proliferation, cytotoxicity and apoptosis in MOLT-4 human leukemia cells. *J Nutr* 133: 2669–2674.
- Mitchell, J.H., S.J. Duthie, and A.R. Collins. (2000). Effects of phytoestrogens on growth and DNA integrity in human prostate tumor cell lines: PC-3 and LNCaP. *Nutr Cancer* 38: 223–228.

- Morre, D.J. and D.M. Morre. (2003). Synergistic capsicum-tea mixtures with anticancer activity. *J Pharm Pharmacol* 55: 987–994.
- Mueller, M.S., I.B. Karhagomba, H.M. Hirt, and E. Wemakor. (2000). The potential of *Artemisia annua* L. as a locally produced remedy for malaria in the tropics: agricultural, chemical and clinical aspects. *J Ethnopharmacol* 73: 487–493.
- Mueller, M.S., N. Runyambo, I. Wagner, S. Borrmann, K. Dietz, and L. Heide. (2004). Randomized controlled trial of a traditional preparation of *Artemisia annua* L. (Annual Wormwood) in the treatment of malaria. *Trans R Soc Trop Med Hyg* 98: 318–321.
- Muller, M. and S. Kersten. (2003). Nutrigenomics: goals and strategies. *Nat Rev Genet* 4: 315–322.
- Muroi, H. and I. Kubo. (1993). Combination effects of antibacterial compounds in green tea flavor against *Streptococcus mutans*. *J Agric Food Chem* 41: 1102–1105.
- Onisi, M., F. Ozaki, F. Yoshino, and Y. Murakami. (1981). An experimental evidence of caries preventive activity of non-fluoride component in tea. *Koku Eisei Gakkai Zasshi* 31: 158–162.
- Papadopoulou, K., R.E. Melton, M. Leggett, M.J. Daniels, and A.E. Osbourn. (1999). Compromised disease resistance in saponin deficient plants. *Proc Natl Acad Sci USA* 96: 12923–12928.
- Pegram, M.D., T. Pienkowski, D.W. Northfelt, W. Eiermann, R. Patel, P. Fumoleau, E. Quan, J. Crown, D. Toppmeyer, M. Smylie, A. Riva, S. Blitz, F. Press, D. Reese, A. Lindsay, and D.J. Slamon. (2004). Results of two open-label, multicenter phase II studies of docetaxel, platinum salts, and trastuzumab in HER2-positive advanced breast cancer. *J Natl Cancer Inst* 96: 759–769.
- Perry, N.S., P.J. Houghton, A. Theobald, P. Jenner, and E.K. Perry. (2000). In-vitro inhibition of human erythrocyte acetylcholinesterase by salvia lavandulaefolia essential oil and constituent terpenes. *J Pharm Pharmacol* 52: 895–902.
- Philipson, J.D., C.W. Wright, G.C. Kirby, and D.C. Warhurst. (1995). Phytochemistry of some plants used in traditional medicine for the treatment of protozoal disease. In *Vol Proc Phytochem Soc Eur*, K. Hostettman, A. Marston, M. Maillard, and M. Hamburger, Eds., Clarendon Press, Oxford.
- Pitarokili, D., O. Tzakou, A. Loukis, and C. Harvala. (2003). Volatile metabolites from *Salvia fruticosa* as antifungal agents in soilborne pathogens. *J Agric Food Chem* 51: 3294–3301.
- Poitrineau, K., S.P. Brown, and M.E. Hochberg. (2003). Defence against multiple enemies. *J Evol Biol* 16: 1319–1327.
- Rajapakse, N., E. Silva, and A. Kortenkamp. (2002). Combining xenoestrogens at levels below individual no-observed-effect concentrations dramatically enhances steroid hormone action. *Environ Health Perspect* 110: 917–921.
- Ritschel, W.A., A. Starzacher, A. Sabouni, A.S. Hussain, and H.P. Koch. (1989). Percutaneous absorption of rosmarinic acid in the rat. *Methods Find Exp Clin Pharmacol* 11: 345–352.
- Schulte-Lobbert, S., G. Holoubek, W.E. Muller, M. Schubert-Zsilavec, and M. Wurglics. (2004). Comparison of the synaptosomal uptake inhibition of serotonin by St. John's wort products. *J Pharm Pharmacol* 56: 813–818.
- Seeram, N.P., L.S. Adams, M.L. Hardy, and D. Heber. (2004). Total cranberry extract versus its phytochemical constituents: antiproliferative and synergistic effects against human tumor cell lines. *J Agric Food Chem* 52: 2512–2517.
- Sendl, A., M. Schliack, R. Loser, F. Stanislaus, and H. Wagner. (1992). Inhibition of cholesterol synthesis *in vitro* by extracts and isolated compounds prepared from garlic and wild garlic. *Atherosclerosis* 94: 79–85.
- Skaper, S.D., M. Fabris, V. Ferari, M.D. Carbonare, and A. Leon. (1997). Quercetin protects cutaneous tissue-associated cell types including sensory neurons from oxidative stress induced by glutathione depletion: cooperative effects of ascorbic acid. *Free Radic Bio Med* 22: 669–678.
- So, F.V., N. Guthrie, A.F. Chambers, M. Moussa, and K.K. Carroll. (1996). Inhibition of human breast cancer cell proliferation and delay of mammary tumorigenesis by flavonoids and citrus juices. *Nutr Cancer* 26: 167–181.
- Spinella, M. (2002). The importance of pharmacological synergy in psychoactive herbal medicines. *Altern Med Rev* 7: 130–137.
- Stafford, R.S., E.A. MacDonald, and S.N. Finkelstein. (2001). National patterns of medication treatment for depression, 1987 to 2001. *Prim Care Companion J Clin Psychiatry* 3: 232–235.
- Stamp, N.E. and T.L. Osier. (1998). Response of five insect herbivores to multiple allelochemicals under fluctuating temperatures. *Entomologia Experimentalis et Applicata* 88: 81–96.

- Steele, C.L., J. Crock, J. Bohlmann, and R. Croteau. (1998). Sesquiterpene synthases from grand fir (*Abies grandis*). Comparison of constitutive and wound-induced activities, and cDNA isolation, characterization, and bacterial expression of  $\delta$ -selinene synthase and  $\gamma$ -humulene synthase. *J Biol Chem* 273: 2078–2089.
- Thiede, H.M. and A. Walper. (1994). Inhibition of MAO and COMT by hypericum extracts and hypericin. *J Geriatr Psychiatry Neurol* 7 (Suppl 1): S54–S56.
- Thoisson, O., T. Sevenet, H.M. Niemeyer, and G.B. Russell. (2004). Insect antifeedant compounds from *Nothofagus dombeyi* and *N. pumilio*. *Phytochemistry* 65: 2173–2176.
- Thompson, J., E.O. George, C.A. Poquette, J. Cheshire, L.B. Richmond, S.S. de Graaf, M. Ma, C.F. Stewart, and P.J. Houghton. (1999). Synergy of topotecan in combination with vincristine for treatment of pediatric solid tumor xenografts. *Clin Cancer Res* 5: 3617–3631.
- Trombino, S., S. Serini, F. Di Nicuolo, L. Celleno, S. Ando, N. Picci, G. Calviello, and P. Palozza. (2004). Antioxidant effect of ferulic acid in isolated membranes and intact cells: synergistic interactions with  $\alpha$ -tocopherol,  $\beta$ -carotene, and ascorbic acid. *J Agric Food Chem* 52: 2411–2420.
- Tulp, M. and L. Bohlin. (2002). Functional versus chemical diversity: is biodiversity important for drug discovery? *Trends Pharmacol Sci* 23: 225–231.
- Tyler, V.E. (1992). Phytomedicines in western Europe: their potential impact on herbal medicine in the United States. In *Human Medicinal Agents from Plants*, D.I. Kinghorn and M.F. Balandrin (Eds.). American Chemical Society, Washington, D.C. Reprinted in *Herbal Gram* 30: 24–30, 67, 68, 77.
- Tyler, V.E. (1997). The honest herbalist — secrets of St. John's wort. *Prevention* 49: 74–79.
- Ultee, A., R.A. Slump, G. Steging, and E.J. Smid. (2000). Antimicrobial activity of carvacrol toward *Bacillus cereus* on rice. *J Food Prot* 63: 620–624.
- Vardar-Unlu, G., F. Candan, A. Sokmen, D. Daferera, M. Polissiou, M. Sokmen, E. Donmez, and B. Tepe. (2003). Antimicrobial and antioxidant activity of the essential oil and methanol extracts of *Thymus pectinatus* Fisch. et Mey. Var. *pectinatus* (Lamiaceae). *J Agric Food Chem* 51: 63–67.
- Verma, S.P., E. Salamone, and B. Goldin. (1997). Curcumin and genistein, plant natural products, show synergistic inhibitory effects on the growth of human breast cancer MCF-7 cells induced by estrogenic pesticides. *Biochem Biophys Res Commun* 233: 692–696.
- Wang, L.G., S.K. Mencher, J.P. McCarron, and A.C. Ferrari. (2004). The biological basis for the use of an anti-androgen and a 5- $\alpha$ -reductase inhibitor in the treatment of recurrent prostate cancer: case report and review. *Oncol Rep* 11: 1325–1329.
- Williamson, E.M. (2001). Synergy and other interactions in phytomedicines. *Phytomedicine* 8: 401–409.
- Wink, M. (2003). Evolution of secondary metabolites from an ecological and molecular phylogenetic perspective. *Phytochemistry* 64: 3–19.
- Wu, H., T. Haig, J. Pratley, D. Lemerle, and M. An. (2002). Biochemical basis for wheat seedling allelopathy on the suppression of annual ryegrass (*Lolium rigidum*). *J Agric Food Chem* 50: 4567–4571.
- Zanoli, P. (2004). Role of hyperforin in the pharmacological activities of St. John's Wort. *CNS Drug Rev* 10: 203–218.



# 14

---

## *Plant Conservation*

---

Mary Jo Bogenschutz-Godwin, James A. Duke, Maureen McKenzie, and Peter B. Kaufman

### CONTENTS

14.1	Introduction .....	503
14.2	Preservation of Natural Habitats and Ecosystems.....	504
14.2.1	National Parks .....	504
14.2.2	Sustainable Biopreserves for Indigenous Peoples.....	504
14.2.3	Work of the Nature Conservancy .....	505
14.3	Prevention of Destruction of Natural and Wilderness Areas .....	506
14.3.1	Work of the World Wildlife Fund.....	506
14.3.2	Work of the Sierra Club.....	506
14.4	Growing Rare and Endangered Plants in Botanical Gardens and Arboreta .....	507
14.4.1	Involvement of Botanical Gardens and Arboreta .....	507
14.4.2	Importance of Environmental Education.....	508
14.4.3	Importance of Cloning Rare and Endangered Plant Species for Distribution.....	510
14.4.4	Importance of Saving Plants from Extinction in Their Native Habitats .....	513
14.5	Plant Seed Banks for Germplasm Preservation.....	516
14.5.1	Plant Introduction Stations in the United States .....	516
14.5.2	National Center for Genetic Resources Preservation in Fort Collins, Colorado.....	517
14.5.3	International Rice Research Institute in Los Baños, Philippines.....	518
14.5.4	International Potato Center in Lima, Peru.....	519
14.5.5	Crucifer Genetics Center in Madison, Wisconsin .....	520
14.5.6	Commercial Seed Companies That Save and Sell Heirloom Seeds of Rare and Endangered Plants .....	520
14.5.7	Seed Banks in Botanical Gardens Established for International Seed Exchange .....	521
14.6	Botanical Prospecting — Ethnobotanical Field Research.....	522
14.7	The Concept of “Ranching” Wild <i>Vaccinium</i> Species with Superior Properties as a Nutraceutical and Potential Pharmaceutical .....	528
14.8	Conclusions .....	532
	References .....	532

---

### 14.1 Introduction

Far too much human-caused exploitation of fragile plant communities and ecosystems has been occurring in recent times at an accelerating pace. This is happening in tropical rain forests worldwide due to their destruction from mining, lumber, wood products, livestock grazing, and farming. In temperate regions, this is due to the clear-cutting of forests, collection of wood from trees and shrubs for fuel, overgrazing by livestock, mining, damming river systems, and urban sprawl. In arctic regions, it is the result of massive clear-cuts of boreal forests for pulpwood for paper manufacture, lumber, and wood products. The Worldwatch Institute in Washington, D.C., has been doing a great job of documenting these calamities over the past two decades. Their prognosis is not good for the future regarding the Earth's



natural resources. Humans, with their burgeoning populations, have been engaged in overly exploitive activities that squander natural products that occur in vast ecosystems. As a result, they are living way beyond the carrying capacity in many regions of the planet.

The purpose of this chapter is to point out ways in which this trend may be reversed. You will see that this involves preserving natural and wilderness areas; getting involved in sustainable harvesting of plants in these ecosystems; saving rare, threatened, and endangered species of plants in “gene banks,” seed banks, tissue culture banks, nurseries, botanical gardens and arboreta, and parks and shrines; and growing plants in an ecologically friendly way. If we follow these strategies, we will help sustain the supply of natural products we obtain from plants, and at the same time, help to provide a livelihood for many people who depend upon these products for their income.

---

## 14.2 Preservation of Natural Habitats and Ecosystems

### 14.2.1 National Parks

Natural resource policies aim to provide people the opportunity to enjoy and benefit from natural environments evolving by natural processes with minimal influence by human actions. The **National Park Service (NPS)** will ensure that lands within park boundaries are protected. Where parks contain nonfederal lands, the NPS uses cost-effective protection methods. Preservation of character and resources of wilderness areas designated within a park, while providing for appropriate use, is the primary management responsibility. The National Parks and Conservation Association is a national nonprofit membership organization dedicated to defending, promoting, and enhancing our national parks, and educating the public about the NPS. It was established in 1919 to protect parks and monuments against private interests and commercialism and to block inappropriate development within parks. Most recently, this organization has done a magnificent job of mobilizing citizen action to prevent clear-cutting of timber and mining within and adjacent to the national parks. They also helped to protect these parks from undue human intrusion with recreational vehicles, helicopters, campers, and “vehicles” of all types (including boats, jeeps, motorcycles, mountain bikes, snowmobiles, and dune buggies). Limiting access to the national parks because of “people pressure” and consequent overcrowding has become the norm. Together, these efforts help, but citizen action groups, such as the **National Parks and Conservation Association**, the **Sierra Club**, the **Nature Conservancy**, the **Wilderness Society**, the **Natural Resources Defense Fund**, and the many other organizations that operate in individual states, must be ever vigilant and ready for concerted action.

### 14.2.2 Sustainable Biopreserves for Indigenous Peoples

Based on a recent United Nations Conference on Environment and Development (UNCED), the United States has placed forest management and protection as a priority of UNCED. Further, discussions by U.S. government agencies and nongovernmental organizations concluded that a provision needs to be included on the needs of indigenous peoples who use the forests for their livelihood, social organization, or cultural identity, and who have an economic stake in sustainable forest use (Plotkin and Famolare, 1992). Actions include promoting means for indigenous peoples and members of local communities to actively participate in decision-making processes for any proposed forest-related actions where their interests are affected (Plotkin and Famolare, 1992). Other propositions are to identify ways to enhance the value of standing forests through policy reform, more accurately reflecting the costs and benefits of alternative forestry activities, in addition to identifying economically valuable forest species, including timber and nontimber species, and the development of improved and sustainable extraction methods (Moran, 1992).

Nabhan (1992) indicated that the following criteria offer the best guidelines for ensuring that indigenous peoples and other peasant communities benefit from applied ethnobotanical development, and that projects sustain rather than deplete or destroy biodiversity.

- The project should attempt to improve the objective and subjective well-being of local communities rather than seek cheap production sites and import inexpensive labor.
- Cultivation in fields or agroforestry management should be considered if there are threats that wild harvests will deplete the resource.
- Wildland management and sensitive harvesting practices should be introduced in cases where the resource might sustain economic levels of extraction in the habitat.
- The plant(s) chosen should offer multiple products or be adapted to diversified production systems.
- When possible, programs should build on local familiarity, use, and conservation traditions for the plant being developed.
- If possible, these programs should be based on locally available genetic resources, technologies, and social organizations to enable local people to retain control over the future of the resource.

We now turn to the topic of ethnobotany and the sustainable use of plant resources based on work of the **World Wildlife Fund**, **UNESCO**, and the **Royal Botanic Gardens at Kew**, United Kingdom. The **People and Plants Initiative** is creating support for ethnobotanists from developing countries who work with local people on issues relating to conservation of plant resources and indigenous ecological knowledge. Rather than promoting the discovery and marketing of new products, emphasis is placed on subsistence use and small-scale commercialization of plants, which benefit rural communities. In cases of large-scale commercialization of wild plants, emphasis is on improving harvesting methods and mechanisms that allow communities to benefit from an increasing share of profits (Royal Botanic Gardens, Kew, 1996a).

One example is provided by the Kuna Indians of Panama. They successfully established the world's first internationally recognized forest park created by indigenous people. The reserve provides revenues directly to the Kuna from the sale of research rights, and from ecotourists who come to learn about the rain forest. Coupled with this, it helps protect and preserve their native heritage. Scientists conducting research in the park are required to hire the Kuna to assist and accompany them during their stay. The Kuna control access to sites and require reports on all research. These terms allow the Kuna to patrol and protect outlying areas while learning from the scientists.

Head and Heismann (1990), in *Lessons of the Rainforest*, tell about the organization called **Environmental Restoration in Southern Colombia (CRIC)**. It is composed of 56 Indian communities that are organized to protect Indian lands, resources, culture, and rights in an area where the forest was destroyed by mines and cattle ranches. CRIC began a forestry program with three tree nurseries that provided seedlings to communities that agreed to plant a minimum of 1000 trees of native species. To date, one community completed nine reforestation programs.

### 14.2.3 Work of the Nature Conservancy

The main objective of the **Nature Conservancy** is to protect plants, animals, and ecological communities that represent biodiversity. To do this, they rely on conservation science to guide their work. Conservation science programs encompass biological, ecological, and technological knowledge that is used to identify and protect sensitive biodiversity, and in management methods and practices are used to ensure its survival. The **Natural Heritage Program** and the **Conservation Data Center Network** programs collectively track in their databases the protected status and locations of rare and endangered species and ecological communities. Over the past four decades, the Nature Conservancy protected more than 8.1 million acres (3.28 million ha) of habitat based on information about the location, range, and status of rare species. This number is even higher for total acreage protected to date: it is 9.3 million acres (3.77 million ha) of land in the United States and 40 million acres (16.19 million ha) throughout Latin America, the Caribbean, and the Asia/Pacific regions. It operates the largest system of privately owned nature preserves in the world.

In carrying out its work, the Nature Conservancy addresses ecological function and influences of people and develops better conservation planning methods and tools that will allow planning across immense biologically defined regions and the range of a particular ecological community. Stewardship

of land and its resources is an important component of the work of the conservancy. In protecting areas identified as critical for biodiversity protection, boundaries of those areas are carefully chosen to encompass important biological components and the ecological processes that sustain them. Its presence in local communities enables it to address ecosystem protection, find solutions to environmental problems, and form partnerships. An organization-wide network electronically links all the Nature Conservancy's offices to support the information systems plan that provides up-to-date information (The Nature Conservancy, 1996).

---

## 14.3 Prevention of Destruction of Natural and Wilderness Areas

### 14.3.1 Work of the World Wildlife Fund

The **World Wildlife Fund (WWF)** has several important objectives, including (1) halting global trade in endangered animals and plants; (2) creating and preserving parks and protected areas around the world; (3) working to create strongholds for thousands of irreplaceable plant and animal species as well as protecting those and other areas from threats beyond their boundaries; (4) working with local leaders, groups, governments, and international funding institutions to coordinate conservation and improve living standards to help alleviate development pressures that may put wildlands in danger; and (5) organizing, supporting, and strengthening conservation efforts around the world (World Wildlife Fund, 1995).

**National Environmental Trust Funds**, pioneered by the WWF in Bhutan and the Philippines, attract the attention of international aid agencies because they prove effective in attracting millions of dollars for conservation in addition to enlisting the participation of governments, nongovernmental organizations, local conservation organizations, and community groups. By spending the annual income from their endowments, these trust funds constitute a reliable source of long-term funding for conservation.

The **Biodiversity Support Program** (a USAID-funded consortium of the WWF), the Nature Conservancy, and the World Resources Institute published a work entitled, *Sustainable Harvest of Non-Timber Plant Resources in Tropical Moist Forest: An Ecological Primer*, authored by Charles N. Peters. This book is designed to help forest managers simultaneously harvest products and conserve forests. It provides a basis in forest ecology and addresses ways that communities can determine what and how much can be harvested over time without depleting the natural resource base on which their livelihood may depend.

The WWF uses **Geographic Information Systems (GIS)** technology to identify priority areas with the greatest biological wealth and the greatest degree of threat, with a focus on conservation priorities. The WWF works closely with the North American Commission for Environmental Cooperation to help ensure that its work promotes conservation initiatives, such as the North American ecoregion mapping and planning project for biodiversity management. It follows the trade agreement's effect on commodities production and health of forests, wildlife, and natural resources in North America. It also supports the Forest Stewardship Council, which developed criteria for identifying timber companies that produce environmentally sound, economically viable products. This council consists of social, environmental, and indigenous groups from more than 24 countries, as well as representatives from the timber industry whose mission is to promote ecologically sustainable forest management. In Madagascar, the WWF brokered a debt-for-nature swap that has trained more than 350 local conservation agents and created a network of locally managed tree plantations. It is also helping to develop alternatives to cattle production and slash-and-burn agriculture in order to protect native forests (World Wildlife Fund, 1995).

### 14.3.2 Work of the Sierra Club

The Sierra Club was founded by John Muir in 1892 in San Francisco, California, to help preserve the pristine beauty of the Sierra Nevada mountain range in California. Today, it is a national organization with chapters throughout the United States. It continues to expand, stop abuse of wilderness lands, save endangered species, and protect the global environment. It helps to create and enlarge national parks, preserve forests, designate wilderness areas, halt dams, and prevent destruction of priceless habitats. The Sierra Club helped save Alaska's Arctic National Wildlife Refuge from exploitation of oil companies,

establish National Park and Wilderness Preservation Systems, and safeguard more than 132 million acres of public land.

This organization launched the **Critical Ecosystems Program**, which is designed to protect and restore 21 regional ecosystems in the United States and Canada. This program is involved in designing protection for public and private lands that are the core habitats for native species. It established task forces for each ecoregion, drawing together activists with expertise in various areas to develop strategies to save those regions. What are these strategies for the different ecoregions?

- Atlantic Coast and Great Northern Forest — preserve biodiversity by restoring and sustaining habitat for the full array of native plants and animals, establish sound forestry policy, and preserve wilderness
- Central Appalachia, Southern Appalachian Highlands, and American Southeast — save from development, as much as possible, the shoreline stretching 2000 mi (3200 km) from Florida to the mouth of the Rio Grande River
- Interior Highlands, Great Lakes, Great North American Prairie — establish a system of national parks, reform Forest Service policies on grazing, oil and gas development, and coal mining on grasslands
- Mississippi Basin, Rocky Mountains, and Colorado Plateau — enact legislation to protect 5 million roadless acres in Utah, eliminate timber sales that threaten old-growth ponderosa pine stands, do away with subsidized timber sales in all national forests, and protect the Grand Canyon by restricting development on its boundaries
- Southwest Deserts, Great Basin/High Desert, Sierra Nevada, Pacific Northwest, and Pacific Coast — permanently protect the remaining ancient forests on federal land
- Alaska Rainforest, the Boreal Forest extending from Alaska to Newfoundland, Hudson Bay/James Bay Watershed, the Arctic, and Hawaii — prevent further destruction of endangered and threatened plant and animal habitats (Elder, 1994)

---

## 14.4 Growing Rare and Endangered Plants in Botanical Gardens and Arboreta

### 14.4.1 Involvement of Botanical Gardens and Arboreta

According to the **New York Botanical Garden**, of approximately 250,000 species of flowering plants, it is estimated that some 60,000 of these may become extinct by the year 2050, and more than 19,000 species of plants are considered to be threatened or endangered from around the world. More than 2000 species of plants native to the United States are threatened or endangered, with as many as 700 species becoming extinct in the next 10 years (New York Botanical Garden, 1995). The New York Botanical Garden currently grows ten species of plants on the Federal Endangered Species List. They are striving to preserve rare and endangered plants and participate with other institutions in doing this. The Garden is a Participating Institution in the **Center for Plant Conservation (CPC)**, serving as a rescue center for six native plant species that are imminently threatened, which form part of the **National Collection of Endangered Plants**, and are grown and studied to be conserved (New York Botanical Garden, 1995). The CPC is located at the **Missouri Botanical Garden** in St. Louis. This center is dedicated to conserving rare plants native to the United States in an integrated plant conservation context through a collaborative program of *ex situ* plant conservation, research, and education. It is made up of a consortium of 25 botanical gardens and arboreta (Center for Plant Conservation, 1996). A national survey by the CPC in 1988 found that more than three quarters of the endangered flora of the United States is in six areas: Hawaii, California, Texas, Florida, Puerto Rico, and the Virgin Islands. It designated these areas as conservation priority regions. The CPC Priority Regions Program addresses the need for conservation through programs of land conservation; management; off-site collection in seed banks, botanical gardens, and other institutions; research; and site surveys (Center for Plant Conservation, 1996). The National

Collection of Endangered Plants contains seeds, cuttings, and whole plants of 496 rare plant species native to the United States. The collection is stored at 25 gardens and arboreta that form part of the CPC.

The **Royal Botanic Gardens at Kew**, United Kingdom, support six *ex situ* and *in situ* conservation projects. The activities range from acting as the U.K. Scientific Authority for Plants for **CITES (Convention on International Trade in Endangered Species of Wild Fauna and Flora)**, cooperating in the recovery and reintroduction of endangered species, and aiding in the production of management plans for sustainable development and protected areas (Royal Botanic Gardens, Kew, 1996b).

The **Wrigley Memorial and Botanical Gardens** at Catalina Island, California, is still another example. The Gardens' emphasis is on California island endemic plants. Many of these plants are extremely rare, with some listed on the **Endangered Species List**.

#### 14.4.2 Importance of Environmental Education

The main purpose of environmental education is to instill an understanding and appreciation of natural resources and to develop support for preserving these resources. It promotes awareness of human impact on the environment, builds knowledge and skills needed to ascertain environmental issues, and enhances the ability to apply that knowledge and skills in issue remediation. There are implications here that are associated with loss of habitats, extinction of species, and their possible biomedical uses. We come to understand that indigenous inhabitants are as endangered as the forest in which they live. Tropical rain forests are considered to be nonrenewable old growth forests.

The **Environmental Protection Agency (EPA)** created an environmental education office to advance and support national education efforts to develop an environmentally conscious and responsible public and to inspire a sense of personal responsibility for the care of the environment. It awards nearly 250 grants annually worth approximately \$3 million as seed money to support environmental education projects.

Among the newly formed conservation and education organizations is the not-for-profit **Amazon Center for Environmental Education and Research (ACEER)** Foundation with which Dr. James Duke was associated since its inception. Since 1991, ACEER has been a dynamic force for rain forest conservation. It provides students, teachers, citizen naturalists, and researchers from around the world an opportunity to learn about the need to conserve the magnificent biodiversity and cultural richness of Amazonia (see Figure 14.1 through Figure 14.9). ACEER operates an education center in the Peruvian Amazon, north of the city of Iquitos, which is visited by more than 2000 individuals per year; the Dr. Alwyn H. Gentry Laboratory is attached to the center and is the focal point for Amazonian research at the ACEER. A major feature of the ACEER's facilities is the **Canopy Walkway system**, the only one of its kind in South America. It allows researchers and visitors to ascend to the very top of the rain forest canopy for observation and study. In 1996, due to the efforts of ACEER board member Dr. James A. Duke, the ACEER created the **ReNuPeRu Ethnobotanical Garden**, a 6 ha site showcasing more than 200 economically important plants growing in their native habitat. The curator for the garden is Don Antonio Montero Pisco, a local shaman. Ultimately, the experience gained at the garden will be transferred to local villages to promote the sustainable economic development and use of ethnobotanicals by the peoples of Amazonia (see Figure 14.10 through Figure 14.23). As a 501(c) (Nabhan, 1992) nonprofit organization, ACEER offers a wide range of education and research programs. In the area of education, annual credit-bearing and noncredit workshops on rain forest ecology, environmental education, pharmacy from the rain forest, and shamanic healing techniques and medicines are offered. The ACEER also hosts student interns, masters, doctoral, and postdoctoral researchers from major universities around the world. An Adopt-a-School program fosters cultural exchanges between American and rural Amazonian schools while providing critical educational supplies for the Peruvian schools. A Peruvian Teachers Training workshop enhances environmental education curriculum development throughout Amazonia, while a Peruvian Scientists Training workshop instructs natural resources scientists on how to use satellite technology and sophisticated geographic information system computer systems to study ecosystems. An ACEER research project recently mapped the spatial distribution of 15 native medicinal plant habitats. Other research evaluated a wide range of topics, including primate biodiversity, the taxonomy of bromeliads, parental behavior in a previously undescribed species of frog, the ecology of



**FIGURE 14.1** View from Amazon Center for Environmental Education and Research (ACEER) canopy walkway at the top of the Amazonian rain forest north of the city of Iquitos in Peru. (Photo courtesy of Dr. James A. Duke.)



**FIGURE 14.2** Same as Figure 14.1, but different view. (Photo courtesy of Dr. James A. Duke.)

bats, water-quality studies of lake and river systems, and more. Through the VINES program, volunteers from around the world may participate in ACEER education and research programs at its center in the rain forest. Another interesting educational feature is the close linkage of the not-for-profit ACEER with **International Expeditions (I.E.)**, a closely related for-profit organization. Among many other responsibilities, I.E. conducts regular continuing-education-credit courses in a series called “Pharmacy from the Rain Forest.” In 1997, for example, 1- to 2-week courses were given, not only in Peru (Figure 14.1 to Figure 14.23), but also, in Costa Rica, Kenya, and Tanzania. (For further information on Pharmacy Ecotour, or to join Jim Duke on a rain forest ecotour, call 1-800-633-4734.) The ACEER is guided by a distinguished international board of directors, as well as three advisory boards — one for environmental education, one for science, and the other dedicated to the ACEER’s Peruvian operations. (To learn more about the ACEER Foundation, please contact ACEER Foundation, Ten Environs Park, Helena, Alabama 35080; 1-800-255-8206 [phone], 205-425-1711 [fax].)



**FIGURE 14.3** Same as Figure 14.1, but different view. (Photo courtesy of Dr. James A. Duke.)



**FIGURE 14.4** View of ACEER canopy walkway in Peruvian Amazon rain forest. (Photo courtesy of Dr. James A. Duke.)

#### **14.4.3 Importance of Cloning Rare and Endangered Plant Species for Distribution**

Germplasm of vegetatively propagated plant material is cheaper to maintain in tissue culture (Akerle et al., 1991), is less expensive to ship, and has the potential to yield more plants more quickly. It is one of the preferred ways to preserve rare and endangered plant species and to distribute these species to other botanic gardens and arboreta around the world. Where conditions allow, some tissue-cultured plant material can be used to reintroduce species that have become lost or extinct in the wild.

One of the preferred methods of tissue culture is shoot-tip culture (**mericlone**). It is becoming the preferred tissue for the exchange of clonal material. Tissue cultures produced from shoot-tip cultures can produce disease-free germplasm, particularly with respect to viruses. Shoot-tip explants are devoid of any vascular tissue, and hence, are typically free of any viral pathogens. This protocol was developed



FIGURE 14.5 Same as Figure 14.4, but different view. (Photo courtesy of Dr. James A. Duke.)



FIGURE 14.6 Same as Figure 14.4, but close-up view of ACEER canopy walkway. (Photo courtesy of Dr. James A. Duke.)

by George Morel in France as a way to rescue virus-infected orchid plants and rapidly propagate virus-free stock. This process is used for the micropropagation of virus-free stock of any plant species. Great success stories are seen in the shoot-tip propagation of virus-free potatoes, strawberries, cassava, pelargoniums, and orchids.

*In vitro* (“in glass,” microorganism-free cultures) disease elimination techniques help to ensure international exchange of germplasm, particularly because viral transmission through seed is known to occur (Akerele et al., 1991). It allows for a far greater number of plants to be produced in a given time than by conventional propagation methods. The Micropropagation Unit at Kew Botanic Gardens propagates plants that are rare, endangered, or difficult to propagate conventionally. Techniques include micropropagation from vegetative material and *in vitro* germination of seeds and spores. A large number of tropical **epiphytic** (growing on other plants) and **terrestrial** (growing in the soil) orchids are grown from seed *in vitro* under sterile conditions. Of these, many are members of island floras and are in jeopardy.





**FIGURE 14.7** Individual traversing ACEER canopy walkway. (Photo courtesy of Dr. James A. Duke.)



**FIGURE 14.8** Canadian Herbalist, Terry Willard, 100 ft (ca. 30 m) high on ACEER canopy walkway. (Photo courtesy of Dr. James A. Duke.)



**FIGURE 14.9** Heliconia plant in flower in the understory vegetation of Amazonian rain forest at ACEER. (Photo courtesy of Dr. James A. Duke.)



**FIGURE 14.10** View from Machu Picchu of Andes mountain vegetation above Amazonian rain forest. (Photo courtesy of Dr. James A. Duke.)

#### **14.4.4 Importance of Saving Plants from Extinction in Their Native Habitats**

Why is it important to save rare and endangered species of plants from going extinct in their native habitats?

- The rate at which whole ecosystems are being destroyed in the boreal forests in northern latitudes and the tropical rain forest across equatorial regions, we will see the disappearance of countless numbers of plant species, many of which were never identified, much less studied for their potential economic utility.
- The disappearing plants may be potential sources of new medicines, foods, flavorings, natural pesticides, dyes, fibers, and wood products.



**FIGURE 14.11** View from Machu Picchu of Andes mountain vegetation in canyon. (Photo courtesy of Dr., James A. Duke.)



**FIGURE 14.12** View of fragile forest vegetation in Peruvian Andes Mountains. (Photo courtesy of Dr. James A. Duke.)



**FIGURE 14.13** View of fragile forest vegetation in Peruvian Andes Mountains. (Photo courtesy of Dr. James A. Duke.)



**FIGURE 14.14** Peruvian mountain musicians in full costume performing with drums and flutes. (Photo courtesy of Dr. James A. Duke.)

- With the extinction of plants, and the loss of the ecosystems where they exist, indigenous peoples are displaced, and their cultures are irreplaceably disrupted.
- Likewise, with the extinction of plant species, many animal species that depend on the plants for food and shelter disappear. The loss of animal and insect species can also lead to the extinction of plant species where those plants rely on animal or insect pollination for reproduction.
- Just think — if even one population of plants becomes extinct, all its unique phytochemical germplasm and properties also disappear (Balick et al., 1996).

In order to counteract this alarming loss of plant species worldwide, conservation organizations have to realize that we must, as quickly as possible, safeguard entire natural ecosystems from destruction by human activities. If we do this now, we create a sustainable environment not only for these plants, but also for the animals and indigenous peoples who reside there.



**FIGURE 14.15** Peruvian women in native garb with llamas in Andes mountain pasture above their village. (Photo courtesy of Dr. James A. Duke.)



**FIGURE 14.16** Peruvian Andes mountain Amerinds in full costume providing music with seashells. (Photo courtesy of Dr. James A. Duke.)

---

## 14.5 Plant Seed Banks for Germplasm Preservation

### 14.5.1 Plant Introduction Stations in the United States

Four regional plant-introduction stations in the United States are in Pullman, Washington; Ames, Iowa; Geneva, New York; and Griffin, Georgia. They are responsible for the management, regeneration, characterization, evaluation, and distribution of seeds of more than one third of the accessions of the national system (i.e., nearly 197,000 accessions of almost 4000 plant species). At Ames, Iowa, approximately 40,079 accessions are held; the primary crops preserved include maize, grain amaranth, oilseed brassicas (e.g., rape, canola, mustard), sweet clover, cucumber, pumpkin, summer squash, acorn squash, zucchini squash, gourds, beets, carrots, sunflower, and millets. At Geneva, New York, approximately 14,180 accessions are held; the primary crops preserved include tomato, birdsfoot trefoil, brassicas, and



**FIGURE 14.17** Peruvian Andes women and children in full costume in their mountain village. (Photo courtesy of Dr. James A. Duke.)



**FIGURE 14.18** Peruvian Andes mountain village marketplace showing some of the locally grown vegetables on display for sale. (Photo courtesy of Dr. James A. Duke.)

onion. At Griffin, Georgia, approximately 82,277 accessions are held; the primary crops preserved here include sweet potato, sorghum, peanut, pigeon pea, forage grasses, forage legumes, cowpea, mung bean, pepper, okra, melons, sesame, and eggplant. At the Pullman, Washington, station, approximately 60,277 accessions are held; the primary crops preserved there include common bean, onion, lupine, pea, safflower, chickpea, clovers, wild rye, lettuce, lentils, alfalfa, forage grasses, horsebean, common vetch, and milk vetch.

#### **14.5.2 National Center for Genetic Resources Preservation in Fort Collins, Colorado**

This center houses the base collection for long-term, backup storage of the National Plant Germplasm Storage active collections. It was recently expanded and its facilities were remodeled, quadrupling the storage area and adding modern research and processing laboratories. It features quality cold-storage facilities for conventional seed storage and cryopreservation (low-temperature preservation, using liquid



**FIGURE 14.19** Peruvian Andes mountain village marketplace where many different kinds of potatoes are on display for sale. (Photo courtesy of Dr. James A. Duke.)



**FIGURE 14.20** Peruvian Andes mountain village marketplace where various medicinal and culinary herbs are being sold. (Photo courtesy of Dr. James A. Duke.)

nitrogen at  $-196^{\circ}\text{C}$ ) storage capacity for seeds, pollen, and vegetatively propagated germplasm. The **National Seed Storage Laboratory (NSSL)** can store more than one million samples. The base collection of the NSSL is not duplicated in its entirety in any other gene bank. Furthermore, of the more than 268,000 accessions, about 60,628 are not duplicated at other sites.

### 14.5.3 International Rice Research Institute in Los Baños, Philippines

Rice (*Oryza sativa*) is the third best-represented crop in plant gene banks. This is most likely due to the fact that rice is a staple food crop in much of Asia. One of the main gene banks for tropical rice is at the **International Rice Research Institute (IRRI)**. Japan and the United States maintain major collections of temperate rices and act as a backup for IRRI and the **International Institute for Tropical Agriculture (IITA)** materials. IRRI has assembled the world's largest rice collection. It represents the largest germplasm collection for any crop and is regarded as one of the best-managed gene banks. It has computerized



**FIGURE 14.21** Peruvian Amerind basket maker. (Photo courtesy of Dr. James A. Duke.)



**FIGURE 14.22** Peruvian village marketplace where Peruvian Amerind is eating her dinner. Items she has tied up are wrapped in banana (*Musa* sp.) leaves. (Photo courtesy of Dr. James A. Duke.)

rice collection data on samples that contain 45 morphological and agronomic characteristics for each entry. As many as 38 genetic evaluation and utilization traits are added, covering disease and pest resistance to tolerance to adverse soils and climates. Its germplasm collection is gradually regenerated, and fresh seed is put in medium- and long-term storage. Approximately 2000 rice varieties and much wild material remains to be collected. The gene bank at IRRI is expected to continue growing until it reaches about 130,000 accessions (Plucknett et al., 1987; Chang, 1982).

#### **14.5.4 International Potato Center in Lima, Peru**

Potato (*Solanum tuberosum*) is the fourth leading world crop, exceeding all other in annual production of starch, protein, and several other important “nutrients” (Niederhauser, 1993). It is susceptible to many diseases and pests and receives the most chemical inputs of any crop (Martin, 1988). Improved potato cultivars present a great potential benefit to the economic, environmental, and nutritional future of the world potato growers and consumers (Bamberg et al., 1995).





**FIGURE 14.23** Peruvian Amerinds in tropical rain forest carving an oar from local rain forest tree wood. (Photo courtesy of Dr. James A. Duke.)

The **International Potato Center (CIP)** accepted the global mandate for potato genetic resources when it was founded. By 1980, more than 80% of total cultivated potato germplasm was collected. Wild species of potato were also systematically collected. The cultivated potato collection samples are grown annually at high altitudes and are stored in conservation facilities. Duplicates of all lines are replaced by a new CIP harvest in each succeeding year (Reid et al., 1993).

Potato cultivars are distributed worldwide from CIP. Microtubers are more tolerant of physical and environmental disturbances, and a few cultures are tolerant of delays in transit (Bamberg et al., 1995). They are now in use for distributing germplasm of potato from CIP and yam from the IITA. The CIP helped to initiate a joint database with potato gene banks around the world by sharing evaluation data and technical procedures, making professional exchanges, cooperating on prioritization and organization of collecting expeditions, duplicating the storage of accessions, and conducting cooperative research (Bamberg et al., 1995).

#### 14.5.5 Crucifer Genetics Center in Madison, Wisconsin

The **Crucifer Genetics Center (CrGC)** was established for the purpose of developing, acquiring, maintaining, and distributing information about seed stocks of various crucifers (members of the cabbage family, Brassicaceae) as well as crucifer-specific symbionts, namely, pathogens (organisms that cause disease in crucifers). It distributes seed from various genetic stocks of rapid-cycling brassicas (short life cycle from seed to seed); some wild crucifer species; a large number of mutants of *Brassica*, *Raphanus* (radish), and *Arabidopsis* (a cress); and pathogen symbiont cultures. The CrGC has been instrumental in introducing rapid-cycling brassicas into laboratory teaching experiments for students in elementary and high schools and in colleges and universities for the study of plant genetics, development (flowering and fruiting), physiology (gravitropism, phototropism, and hormone action), and plant pathology. One of these plants, *Arabidopsis*, was shown to develop from seed to seed in outer space on NASA's space shuttle. For humans, conservation of crucifer germplasm, as done at the CrGC, is important for humans; many of the brassicas are important in preventing cancer in humans (e.g., broccoli).

#### 14.5.6 Commercial Seed Companies That Save and Sell Heirloom Seeds of Rare and Endangered Plants

Because of the loss of crop diversity with the advent of the green revolution and the breeding of crop varieties grown as monocultures, we lost thousands of varieties of plants because they are no longer

sold. This has happened with rice, wheat, and maize. With the loss of crop diversity, we also witnessed a loss in disease and insect pest resistance, a loss of protein and essential nutrients in many of the grain crops, a loss in desirable flavor and texture in many vegetables, and an increase in the use of fertilizers, pesticides, and irrigation water. Many of the desirable cultivars of apples and roses, once grown very widely, almost completely disappeared from commercial seed or nursery catalogs.

The situation today is changing rapidly. Many of the “old-fashioned” rose cultivars or apple cultivars are now reappearing in the catalogs, primarily driven by consumer demand for more plant diversity and varieties that do not require so much in the way of fertilizer, pesticide, and water inputs. The same can be said for cucurbits (squash and melon), maize, legume crops (peas, beans, and their relatives), herbs, prairie plants, medicinal plants, woodland wildflowers, native trees and shrubs useful in landscaping and in forest restoration projects, aquatic plant species used in ponds to purify water polluted by sewage treatment plants, and species of plants that are good scavengers of heavy metal pollutants in soils. Let us cite just a few examples of sources of seeds of rare and endangered plants:

- **Henry Doubleday Institute** at Ryton Gardens, Coventry, United Kingdom, has a heritage seed program, whereby it distributes heirloom and rare varieties of seed plants that are generally not commercially available. The seed is not registered with the European Community, so it cannot be sold, but it can be donated. We do not know if their seeds are exportable to the United States.
- The **Seed Guild** is an organization located in Lanark, United Kingdom, which buys seed from botanical gardens from throughout the world, making them available to amateur gardeners and commercial outlets. The Guild provides an opportunity to obtain unusual and rare seeds that are not generally on commercial seed lists. Their annual newsletter provides information on seed-collecting expeditions and new sources of seed supply.
- Three commercial seed companies: Redwood Seed Company (Redwood City, California) is an alternative seed company; Sandy’s Exotic Plant Seed Company (Fairchild, Washington) has available rare, exotic, and unusual seeds from around the world; and Prairie Moon Nursery (Winona, Minnesota) sells seeds of rare ferns, cacti, forbs (herbaceous plants), grasses, sedges, rushes, trees, shrubs, vines, and prairie mixtures.

#### 14.5.7 Seed Banks in Botanical Gardens Established for International Seed Exchange

The **Royal Botanic Gardens Kew Seed Bank**, located at Wakehurst Place, United Kingdom, was founded in 1974. It provides storage for seeds of some 4000 plant species from more than 100 countries. It is the most diverse collection anywhere in the world. It also holds a long-term collection of seeds sampled from wild populations within the United Kingdom and the world’s arid and semiarid lands. Their emphasis is placed on threatened plant populations and in the drylands, especially for plants of local economic value. Some 3750 plant species are conserved according to internationally accepted standards for long-term conservation. When numbers permit, seed is offered for distribution. Samples are made available through a list of seeds published every other year and distributed to organizations doing research work. Those taking the seeds must agree to a commercialization agreement in the event of any commercial success, which ensures a policy of apportioning profits to the seeds’ country of origin. This policy aims to abide with the spirit of the 1992 Rio Earth Summit and to keep pace with subsequent changes in national and international attitudes and legislation (The Royal Botanic Gardens, Kew, 1996a).

The CPC, located at the Missouri Botanic Garden in St. Louis maintains a Memorandum of Understanding (MOU) with the U.S. Department of Agriculture NSSL in Ft. Collins, Colorado. Under this MOU, the NSSL stores seeds from rare U.S. plants in the Center’s National Collection of Endangered Plants at no cost to the center or its participating institutions. The CPC’s **National Collection of Endangered Plants** represents perhaps the most fundamental reserve of plant germplasm for many of the rarest plants in the United States.

---

## 14.6 Botanical Prospecting — Ethnobotanical Field Research

There is a correlation between plant genetic resources and the development of new pharmaceutical products. This correlation integrates biological, ecological, chemical, medical, legal, and economic aspects. The issues can involve property, resource and access right, reciprocity, technology transfer, export, and patent and royalty rights (Reid et al., 1993). The force behind biodiversity prospecting is the demand for new genes and chemical compounds and to research the supply of these resources in wildland diversity. Interest has increased in the pharmaceutical industry. Development and improvement of screening techniques increased the rate for chemical testing. Ethnopharmacology is another force. This field, which involves the use of plants and animals in traditional medicine, can greatly increase the probability of finding a valuable drug. Drug exploration based on indigenous knowledge may prove to be more cost and time effective than random screenings.

In the United States, approximately 25% of prescriptions are for drugs with ingredients that are derived from plant extracts or their derivatives. The demand for genetic resources in agriculture will grow as techniques for genetic manipulation improve and research investments show a return. Between 1985 and 1990, the number of biotechnology patent applications grew by 15% annually (Raines, 1991–1992). As an example, two drugs derived from the rosy periwinkle (*Catharanthus roseus*), vincristine and vinblastine, earned \$100 million per drug for Eli Lilly Company (Farnsworth, 1988). In addition, more than \$600 million of paclitaxel (Taxol®) was sold in 1996, and more than half that figure of etoposide (from *Podophyllum* or mayapple) was sold.

The stakes in drug development are high, and payoff is uncertain. Finding a valuable compound has a high cost, because the probability of locating one with a desired action is low. It is often necessary to test as many as 10,000 substances in order to find one that may reach the drug market (Reid et al., 1993). Developing a successful drug can require the screening of some 1000 plant species. Research and development cost is generally high, an average of \$231 million per drug, with nearly 12 years needed to go from source to market (DiMasi et al., 1991).

International laws directly affect biodiversity prospecting. **Intellectual Property Rights and Human and Indigenous Rights** are measures to be used for the protection of traditional cultural manifestations (cultivated plants, medicines, and knowledge of useful properties of plants) (Akerle et al., 1991). These laws guarantee rights to participate in the use, management, access, and conservation of these resources and should involve sharing in the benefits. The objectives of such laws should include conservation of plant and animal diversity, sustainable development of genetic resources, and the fair and equitable sharing of the resultant benefits (Reid et al., 1993).

INBio is a private, nonprofit organization established to facilitate conservation and sustainable use of biodiversity. Other private, nonprofit intermediaries are based in developed countries. In the United States, for example, the New York Botanical Garden, the Missouri Botanical Garden, and the University of Chicago have all contracted with private pharmaceutical companies and public research organizations to provide samples of biodiversity for pharmaceutical development. It is important that pharmaceutical companies involved in such contracts return an equitable share of their profits from any plant-derived drugs they develop from such plants to the indigenous peoples from whom these plants and the knowledge about their medical uses are obtained. Good role models are provided by Denali BioTechnologies, LLC, Anchorage, Alaska, and Shaman Pharmaceutical Company in San Francisco, California.

---

### Essay on Bioprospecting in Alaska

Encompassing 586,412 square miles, Alaska is one-third the size of the contiguous United States. Great climatic variations occur in this vast area and include temperatures ranging from  $-80^{\circ}\text{F}$  in winter to  $100^{\circ}\text{F}$  in summer, with corresponding total darkness or daylight, and precipitation of less than 6 in. in the far north to more than 150 in. in the southeast. Extreme climate and rugged, complex geology make Alaska unforgiving of human occupation and sparsely inhabited (population 650,000) but

exert remarkable effects on the flora that present opportunities for the identification of novel natural products.

Noteworthy is a relatively young, but complex, flora (Figure 14.24 through Figure 14.32) characterized by many species that achieve their northernmost range extension in Alaska (Hulten, 1968). Influenced by warm Pacific currents, an old-growth, temperate forest encompassing the Tongass and Chugach National Forests, spans the coastline from the Inside Passage in Southeast through Prince William Sound and the Gulf of Alaska to Kodiak Island. Taiga (spruce-birch) forest dominates the interior, whereas tundra vegetation covers the cold, arid North Slope, Seward Peninsula, and wetter western coastal plain. A unique tundra-type vegetation in the Aleutian Islands is created by cool year-round temperatures and ample rainfall. Mountain ranges throughout southern and central Alaska support alpine vegetation, whereas prehistoric glaciation patterns created refugiums, especially in the Yukon Flats, for rare plants



**FIGURE 14.24** Fireweed in Brotherhood Park in Juneau, Alaska, backdropped by Mendenhall Glacier and the Coast Mountains, Tongass National Forest, Alaska. (Photo courtesy of Ken Graham Agency, Girdwood, AK.)



**FIGURE 14.25** Alaska, Unalaska Island. (Photo courtesy of Ken Graham Agency, Girdwood, AK.)



**FIGURE 14.26** Old-growth temperate rain forest (Sitka spruce, *Picea sitchensis*, and western hemlock, *Tsuga heterophylla*) in Kadashan Valley, Chichagof Island, Tongass National Forest in southeast Alaska. (Photo courtesy of Ken Graham Agency, Girdwood, AK.)



**FIGURE 14.27** Skunk cabbage (*Symplocarpus foetidus*) sprouts in boggy woods, Alaska. (Photo courtesy of Ken Graham Agency, Girdwood, AK.)



**FIGURE 14.28** Devil's club (*Echinopanax horridum*) and black cottonwood (*Populus trichocarpa*) in Alaskan woods. (Photo courtesy of Ken Graham Agency, Girdwood, AK.)



**FIGURE 14.29** Richardson's saxifrage (*Boykinia richardsonii*) in Denali National Park, Alaska. (Photo courtesy of Ken Graham Agency, Girdwood, AK.)



**FIGURE 14.30** Pink plumea (*Polygonum bistorta*), a member of the buckwheat family, Polygonaceae, along the Denali highway, Alaska. (Photo courtesy of Ken Graham Agency, Girdwood, AK.)

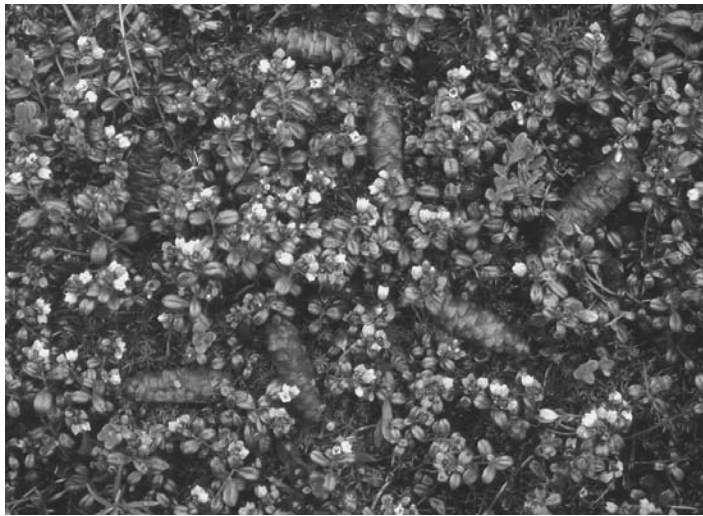

**FIGURE 14.31** Blooming lingonberry (*Vaccinium vitis-idaea*) and spruce (*Picea* sp.) cones in Denali National Park, Alaska. (Photo courtesy of Ken Graham Agency, Girdwood, AK.)

that predate the Ice Age (McDaniel, 1996). As an anthropological crossroad via Beringia, Alaska harbors plants from different continents in unlikely remote subarctic and arctic habitats.

Approximately 89% of Alaska's land is government held, and more than half of this is allocated to national and state parks, preserves, recreation areas, wildlife refuges, conservation areas, and military installations. Another 10% belongs to Alaska Native corporations, formed under the **Alaska Native Claims Settlement Act (ANCSA)** of 1971, and the remaining 1% belongs to private interests. Despite some development



**FIGURE 14.32** Whitish gentian (*Gentiana algida*) flowers in the tundra near Thorofare Pass, Denali National Park, Alaska. (Photo courtesy of Ken Graham Agency, Girdwood, AK.)

from petroleum, mining, construction, tourism, fishing, and timber industries, expansive areas remain pristine. Alaska remains largely inaccessible by road. Frontier lifestyles in remote settlements and Native villages coexist with modern economic and technological imperatives.

Unlike other Native Americans and indigenous peoples, Alaska Natives (Figure 14.33 and Figure 14.34) never faced displacement to reservations. The ANCSA settlement with the federal and state governments transferred, by tribal demographics, \$962.5 million and surface/subsurface rights for 40 million acres of land to 13 regional corporations and more than 200 village corporations (Alaska Native Claims Settlement Act, 1971). Through birthright, individuals with at least one-quarter Aleut, Athabascan Indian, Tlingit, Haida, Tsimshian, Koniag, or Inupiat, Yu'pik, Bering Straits (Siberian), or Chugach Eskimo heritage became shareholders in the regional and village corporations. Two exceptions to ANCSA, a reservation and tribal government, persist today by choice of their members. The main objectives of ANCSA were to secure citizenship for Alaska Natives, with attendant legal rights and responsibilities, and independence from government welfare through economic self-determinism.

Although ANCSA corporations are financially successful, Alaska Native lifestyles continue to revolve around traditional subsistence activities, such as seasonal hunting and gathering. Land, with the food and medicinal plants and wildlife it bears, is a rigorously guarded resource of the Native corporations and affiliated tribal councils. The tribal councils affirm and protect cultural and spiritual values, thousands of years old, from continuing erosion through Western lifestyle acculturation and loss of elders.

Perhaps more immediately compelling than plant conservation in Alaska is preservation of the Native peoples' traditional knowledge. Upon Western contact, Alaska Natives were considered generally healthy despite harsh living conditions (Fortuine, 1988). The past 30 years of modernization, however, coincide with dramatic increases in diabetes (Shraer et al., 1996; Murphy et al., 1995), certain cancers (Baquet, 1996; Lanier et al., 1996), and infectious diseases (Fortuine, 1985/1986) in the Alaska Native population. Thus, acculturation is implicated in the etiology of these conditions and suggests disease chemopreventive roles for traditional Native foods and health practices. Of 2000 common Alaskan plants, many belong to the Apiaceae, Asteraceae, Betulaceae, Bassicaceae, Fabaceae, Polygonaceae, Rosaceae, and Salicaceae families (Hulten, 1968; Welsh, 1974) and are rich dietary sources of vitamin, antioxidant, biofla-



**FIGURE 14.33** Barrow, Alaska. Inupiat Eskimos, Bertha Leavitt (age 80) and her granddaughter, Nor Del, pick flowers in the Alaskan tundra. (Photo courtesy of Ken Graham Agency, Girdwood, AK.)



**FIGURE 14.34** Tlingit grandfather and grandson at Saxman, AK. (Photo courtesy of Ken Graham Agency, Girdwood, AK.)



vonoid, sterol, and phytoestrogen compounds. Nearly 20% of these are traditional medicinal plants (Fortune, 1988) under investigation for pharmacologically active components relevant to a variety of therapeutic applications.

### Acknowledgments

The following individuals are gratefully acknowledged for helpful discussions in the preparation of this essay: Dr. Ken Winterberger, U.S. Forest Service, PNW Regional Research Laboratories, Anchorage, AK; Patrick M. Anderson, Esq., Juneau, AK; Carl R. Propes, Jr., MTNT, Ltd., McGrath, AK; and Ashley Schmiedeskamp, Cook Inlet Region, Inc., Anchorage, AK.

---

## 14.7 The Concept of “Ranching” Wild *Vaccinium* Species with Superior Properties as a Nutraceutical and Potential Pharmaceutical

The beneficial properties of berries were understood instinctively by humans throughout the millennia, and of these, *Vaccinium* species have been revered by indigenous peoples for their food and medicinal values. Now modern science provides a biochemical basis for the health-promoting effects of *Vaccinium*, a staple wherever humans established a culture in cooler, higher latitude or altitude regions of the world.

Several *Vaccinium* species of worldwide economic importance can be found in the United States. The most widely cultivated is *Vaccinium corymbosum* L. (highbush blueberry), grown from the mid-Atlantic to California, Oregon, and Washington, and from the upper Midwest to the mid-South, with Michigan and New Jersey leading production. *Vaccinium angustifolium* Ait. (lowbush, or “wild”, blueberry) is adapted to the far north and is commercially important in Maine and eastern Canada, as well as in parts of New Hampshire, Massachusetts, Michigan, and Wisconsin. *Vaccinium ashei* Reade (rabbiteye blueberry) is well adapted to the warmer climates of the South. In addition to blueberries, the genus also includes *Vaccinium macrocarpon* Ait. (cranberry), another principal crop of more northern locations.

During the past decade, demand for blueberries and cranberries has grown dramatically as a result of increased awareness in the scientific community and by consumers of their healthful properties. In addition to greater amounts consumed annually as fresh, frozen, and processed fruit, these berries have become important components of **nutraceuticals** or dietary supplements. Cranberry extract, used primarily for maintenance of urinary tract health, is the 14th most popular dietary supplement, whereas *Vaccinium myrtillus* L. (European bilberry), a close relative of *V. angustifolium*, placed 21st for its beneficial effects on retinal and vascular health (*Nutrition Business Journal*, 2004). Extracts of *V. myrtillus* are widely used in prescription and over-the-counter medications. Preparations derived from its fruit are recognized in *The Complete German Commission E Monograph: Therapeutic Guide to Herbal Medicines* (Blumenthal, 1998) and in the *PDR for Herbal Medicine*, which also cites the bog bilberry, *Vaccinium uliginosum* L. (Gruenwald, 2004). There are currently more than 180 *Vaccinium* phytopharmaceutical products available worldwide. As these medications become increasingly popular, European crops can no longer meet the global demand. In response to this shortfall, extracts of generally similar North American *V. angustifolium* are now being considered as an alternative to more expensive *V. myrtillus* extracts (Kalt and Dufour, 1997).

Three species that are not currently used in commerce, but that stand out with regard to their recognized importance in the subsistence diets of Native Americans and Alaska Natives, are *Vaccinium ovatum* Pursh (evergreen huckleberry), *Vaccinium ovalifolium* Sm. (Alaska black huckleberry), and *V. uliginosum*. Although *V. ovatum* possesses a remarkable array of flavonoids with beneficial properties (Taruscio et al., 2004), its occurrence within its natural range and adaptability to cultivation is considered too limited to be commercially viable. *V. ovalifolium* forms dense thickets up to subalpine levels and is the most common woodland and coastal forest berry, providing most of those picked in maritime, rain forest

habitats of Alaska. *V. uliginosum* is a low-spreading, dwarf, alpine species, and is the ubiquitous, best-known, and most-used berry in Alaska for food purposes (Matz, 1996).

*V. ovalifolium* is equally remarkable as *V. ovatum* in its profile of **flavonoid compounds** (Taruscio et al., 2004), and, like *V. uliginosum*, it grows prolifically without cultivation of any sort throughout Alaska. Some experts estimate that hundreds of millions of pounds of fruits of the *Vaccinium* species are available each growing season (Matz, 1996). *V. ovalifolium* grows in the coastal areas of Alaska, which is, in large part, a mountainous rain forest habitat with dense vegetation. *V. uliginosum* occurs on vast expanses of wet tundra habitat throughout the state. Despite spectacular annual yield, these berries are cyclical in year-to-year productivity and occur in remote areas with extremely rugged terrain that makes harvest of large quantities difficult and expensive. As a result, picking machinery cannot be employed, and berries must be hand gathered with claw-like implements. While these physical obstacles are considerable, there is the additional inherent danger of gathering berries where grizzly and black bears are eating voraciously in preparation for hibernation.

Irrespective of barriers to large-scale commercialization, **DENALI BioTechnologies, L.L.C.**, Alaska's only biotechnology company, has gathered sufficient quantities of *V. ovalifolium* and *V. uliginosum* to formulate its first nutraceutical product, **AuroraBlue™**. Replete with flavonoids, including 15 prominent **anthocyanins**, a multitude of **polyphenolics**, high levels of monomeric, oligomeric, and, most importantly, high-molecular-weight **proanthocyanidin polymers**, AuroraBlue is comprised of >90% *V. ovalifolium*, <10% *V. uliginosum* and subspecies, and <1% of various other *Vaccinium* species that occur concomitantly in their stands. The unique profile contributed to AuroraBlue by *V. ovalifolium* suggests a chemotaxonomic position for this species somewhere between the blueberry, bilberry, huckleberry, and cranberry, with the individual health-promoting characteristics of each bundled into one (DENALI BioTechnologies, 2004). Recent studies revealed that preparations of wild *V. ovatum* and *V. ovalifolium* are the most effective **oxygen radical scavengers** in the Ericaceae. *V. ovalifolium* specimens growing at high latitudes (greater than the 55th parallel) have the highest **oxygen radical absorbing capacity (ORAC)** values of any *Vaccinium* species tested to date (DENALI BioTechnologies, 2004; Taruscio et al., 2004).

As demand for **AuroraBlue** has increased, DENALI embarked on a **ranching program** to facilitate the gathering and supply of commercial quantities of berries. These efforts are directed, not only to improving yield, but also, to protecting and preserving the fragile and special ecosystems of the tundra and only temperate rain forest in the world. The challenges DENALI faces are associated with successfully using nonintrusive approaches for greater productivity and preservation of the unique biochemical composition of ranches *V. ovalifolium* and *V. uliginosum*. Consistent with the truly wild features of the product, ranches plants are neither genetically manipulated nor supported with conventional fertilizers, pesticides, or herbicides. In ranching stands, soil pH, nutrient composition, and other characteristics must mimic the original growth habitat. Should adjustment of nutrient composition of the soil be required, wild salmon waste is the fertilizer of choice. Based on experience, DENALI's principal ranching approaches include the following:

*Utilization of clear-cut stands:* Left over from logging activities in Alaska's forested lands, clear-cut stands typically support vigorous growth of *Vaccinium* plants previously restricted by shade from the old-growth tree canopy. In most cases, *Vaccinium* is dependent upon the presence of associated plants of other genera that comprise its communities or complexes in the forest, and clear-cut stands retain these critical ecological relationships (Tirmentein, 1990). As a result of enhanced exposure to more intense sunlight, each bush grows taller with larger leaves, and fruit is more abundant, larger, and darker in epidermal pigmentation. The desirable flavonoid composition of plants in clear-cut stands is maintained, also, as the phenylpropanoid pathway from which flavonoids arise is triggered by **UV-B light** (Dixon and Paiva, 1995). Thus, clear-cuts offer excellent areas for *Vaccinium* ranching.

*Utilization of burned stands:* Whereas controlled burning is a management technique employed in other areas, annual summertime wildfires are typical throughout Alaska. Subsequent to naturally occurring forest fires, some of the earliest and most prolific regrowth may be achieved by *Vaccinium*, but for *V. ovalifolium*, regrowth is variable (Tirmentein, 1990). Above-ground

portions of the plants are commonly killed by fire, but underground rhizomes survive wildfires or controlled burns. Survival typically decreases with higher fire intensity and severity, although some rhizomes survive even hot wildfires, as long as soil is sufficiently deep to offer some protection. Some plants may survive even after lethal heat penetration to depths of 3.5 to 4.7 in. (9 to 12 cm). If affected, rhizomes are typically most susceptible to heat damage during the period of active growth in the spring and early summer, which is prior to the most prevalent time for wildfires later in the season. The advantage of burning is freedom from competing genera that recover more slowly for some years following the burn.

*Enrichment:* In DENALI's experience over the past 5 years, stands that have been heavily picked by hand tend to produce more fruit the following year, as a considerable percentage of berries removed from the bush fall to the ground for reseeding. The stands seem to display a modest subsequent gain in plant density as well as in fruit density per plant. In general, *Vaccinium* seeds are thought to be poorly viable, although refrigerated and frozen fruit can be used to begin seedlings for over 10 years after being held in storage (Tirmentein, 1990). Interestingly, refrigerated berries appear as fresh as when picked for up to 6 months at 4°C. As a result of these observations, thinly populated stands are enriched with seeds from plants originating in nearby more heavily populated stands. Because these seeds are likely to be borne on plants emergent from the same rhizome system, they are considered to be genetically comparable.

Wild species are preferably relocated directly to ranching stands through hardwood cuttings, bare root specimens, or by container (USDA, NRCS, 2004). Specimens are transferred from their native habitat during dormancy, typically before the snow has melted in the spring and after leaves have dropped in the fall. Compared to cultivated highbush blueberries that thrive at a planting density of 1400 to 1700 per acre (C. Dailey, personal communication, 2005), wild stock prefers a higher planting density of 2700 to 4800 per acre. Like cultivated *Vaccinium* species, wild species can be propagated vegetatively through hardwood cuttings that are rooted and raised in a greenhouse for about 1 year before planting out but will require at least 2 to 3 years of acclimation before fruiting. Although tissue-cultured plants also succeed in the field, they may have a different form than plants derived from hardwood cuttings, tending to spread at the base, making ultimate machine harvesting difficult, whereas hardwood cuttings will grow more upright. In addition, tissue-cultured stock is no longer considered wild, a distinction that lowers the market value of berries used for AuroraBlue.

Thus, ranching will provide a more economical approach to the provision of commercial quantities of truly wild Alaska berries (Figure 14.35 through Figure 14.37). As a result of these efforts, Alaska will be able to develop a sustainable economic sector based on a renewable resource that is far more environmentally friendly than the traditional industries of oil drilling, mining, fishing, and tourism. Valuable relationships are being formed between DENALI and state and borough economic development organizations, rural villages, Native corporations and associations, and private landholders to create an emergent nutraceutical industry in Alaska. This industry will provide benefits to all who produce and consume wonderful *Vaccinium* fruits for their widely appreciated health-promoting properties.



**FIGURE 14.35** (See color insert following page 256.) Photo of *Vaccinium* (bilberry) branch with blue fruits from plant growing in the wild in Alaska.



**FIGURE 14.36** Photo of bag of wild *Vaccinium* (bilberry) plants collected in the wild in Alaska to be used for propagation in a nursery located at the same latitude in Alaska as part of a “ranching” operation under the auspices of DENALI BioTechnologies, LLC.



**FIGURE 14.37** Photo of habitat in the wild in Alaska where *Vaccinium* (bilberry) plants are obtained from clones of bushes to grow in nurseries as part of a “ranching” operation.

---

## 14.8 Conclusions

The rain forests remain a major source of medicinal genetic resources, some of which may yield drugs to treat numerous diseases or symptoms. Approximately 15% of angiosperm species were examined for their medicinal potential, many of these from temperate and subtropical regions. The majority of tropical plants of the rain forests, which represent about 40% of all angiosperm species, have yet to be studied. Ironically, the most diverse rain forests, those of Latin America, have been least studied, by both aborigines and modern scientists. The rain forests possess an incredible potential for supplying botanical resources and medicinal and nutritional benefits. In the process of realizing this potential, one must adequately address conservation, preservation, sustainable harvesting, socioeconomic development, and indigenous culture issues, to name a few.

Due to the mass extinction process, as a result of rain forest destruction, it is predicted that a large number of plant species will become extinct within the next decade or so. Along with this extinction is the loss for their potential and the alteration of habitat and indigenous cultures. Currently, measures are being taken in these areas, but more needs to be done and at an accelerated rate. Education and support of development and conservation programs are stepping stones to the protection and use of these botanical resources.

---

## References

- Akerele, O., V. Heywood, and H. Synge. (1991). *Conservation of Medicinal Plants*. Cambridge University Press, United Kingdom.
- Alaska Native Claims Settlement Act. (1971). United States Code, Title 43, Chapter 33, December 18, 1971.
- Balick, M., E. Elisabetsky, and S. Laird. (1996). *Medicinal Resources of the Tropical Forest*, Columbia University Press, New York.
- Bamberg, J.G., Z. Huaman, and R. Hoekstra. (1995). International cooperation in potato germplasm. *Crop Sci Soc Amer* 23: 177–182.
- Baquet, C.R. (1996). Native Americans' cancer rates in comparison with peoples of color. *Cancer* 78 (Suppl. 7): 1538–1544.
- Blumenthal, M. (Ed.). (1998). *The Complete German Commission E Monographs — Therapeutic Guide to Herbal Medicine*. American Botanical Council, Austin, Texas.
- Center for Plant Conservation. (1996). Missouri Botanical Garden, St. Louis. [www.mobot.org/CPC/welcome.html](http://www.mobot.org/CPC/welcome.html).
- Chang, T.T. (1982). Personal communication.
- DENALI BioTechnologies, L.L.C. (2004). [www.denali-biotechnologies.com](http://www.denali-biotechnologies.com).
- DiMasi, J.A., R.W. Hansen, H.G. Grabowski, and L. Lasagna. (1991). Cost of innovation in the pharmaceutical industry. *J Health Econ* 10: 107–142.
- Dixon, R.A. and N.L. Paiva. (1995). Stress-induced phenylpropanoid metabolism. *Plant Cell* 7: 1085–1097.
- Elder, J. (1994). The big picture. *Sierra* March/April: 52–56.
- Farnsworth, N.R. (1988). Screening plants for new medicines. In *Biodiversity*, E.O. Wilson and F.M. Peters (Eds.). National Academy Press, Washington, D.C., pp. 83–97.
- Fortuine, R. (1985/1986). Early evidence of infections among Alaska Natives. *Alaska History* 2: 39–56.
- Fortuine, R. (1988). The use of medicinal plants by Alaska Natives. *AK Med* November/December: 189–223.
- Gruenewald, J. (Ed.). (2004). *PDR for Herbal Medicines*. Medical Economics Company, Montvale, New Jersey.
- Head, S. and R. Heismann. (1990). *Lessons of the Rainforest*. Sierra Club Books, San Francisco, CA.
- Hulten, E. (1968). *Flora of Alaska and the Neighboring Territories. A Manual of the Vascular Plants*. Stanford University Press, Palo Alto, California.
- Kalt, W. and D. Dufour. (1997). Health functionality of blueberries. *Hort Technol* 7: 216–221.
- King, S.R. (1992). *Conservation and Tropical Medicinal Plant Research. Biodiversity Prospecting*. World Resources Institute, Washington, D.C.

- Lanier, A.P., J.J. Kelly, B. Smith, A.P. Harpster, H. Tantilla, C. Amadon, D. Beckworth, C. Key, and A.M. Davidson. (1996). Alaska Native cancer update: incidence rates 1989–1993. *Cancer Epidemiol. Biomarkers Prev* 5: 749–751.
- Martin, M. (1988). Potato production and chemical dependency. *Am Potato J Symp. Suppl.*: 1–4.
- Matz, G. (1996). Alaska: the great land of berries. *Alaska Geographic. Native Cultures in Alaska*, pp. 94–99.
- McDaniel, S. (1996). Hunting prehistory: scientists wonder if rare plants in Yukon-Charley Preserve are ice age remnants. *Anchorage Daily News*, July 21, K1–4.
- Moran, K. (1992). Ethnobiology and U.S. Policy. In *Sustainable Harvest and Marketing of Rain Forest Products*, M. Plotkin and L. Famolare (Eds.). Island Press, Washington, D.C.
- Murphy, N.J., C. Shraer, M.C. Thiele, E.J. Boyko, L.R. Bulkow, B.J. Doty, and A.P. Lanier. (1995). Dietary change and obesity associated with glucose intolerance in Alaska Natives. *J Am Diet Assoc* 95: 676–682.
- Nabhan, G.P. (1992). Native plant products from the arid neotropical species: assessing benefits to cultural, environmental, and genetic diversity. In *Sustainable Harvest and Marketing of Rainforest Products*, M. Plotkin and L. Famolare (Eds.). Island Press, Washington, D.C., pp. 289–301.
- New York Botanical Garden. (1995). Endangered and threatened plants at the New York Botanical Garden. [www.nybg.org/Gardens/NYBG/Gardens/ndanger.html](http://www.nybg.org/Gardens/NYBG/Gardens/ndanger.html).
- Niederhauser, J.S. (1993). International cooperation and the role of the potato in feeding the world. *Am Potato J* 70: 385–403.
- Nutrition Business Journal*. (2004). Top 50 Herbs in the U.S.: 2004 — Chart 83. <http://store.yahoo.com/nbj/new2019top75.html>.
- Plotkin, M. and L. Famolare. (1992). *Sustainable Harvest and Marketing of Rain Forest Products*. Island Press, Washington, D.C.
- Plucknett, D.L., N.J.H. Smith, J.T. Williams, and N.M. Anishetty. (1987). Genes in the bank. In *Gene Banks and the World's Food*. Plucknett, D.L. and Smith, N.J.H., Eds., Princeton University Press, New Jersey, pp. 233–247.
- Raines, L.J. (1991–1992). Protecting biotechnology's pioneers. *Issues in Sci and Technol* Winter: 33–39.
- Reid, W.V., S.A. Laird, R. Gámez, A. Sittenfeld, D.H. Janzen, M.A. Gollin, and C. Juma. (1993). *A New Lease on Life. Biodiversity Prospecting*. World Resources Institute, Washington, D.C.
- Royal Botanic Gardens, Kew. (1996a). People and Plants; Ethnobotany and the Sustainable Use of Plant Resources. WWF-UNESCO-Royal Botanic Gardens, Kew, United Kingdom. [www.rb-gkew.org.uk/ceb/ppi.html](http://www.rb-gkew.org.uk/ceb/ppi.html).
- Royal Botanic Gardens, Kew. (1996b). Conservation at the Royal Botanic Gardens, Kew, U.K. [www.rb-gkew.org.uk/conservation/index.html](http://www.rb-gkew.org.uk/conservation/index.html).
- Shraer, C.D., S.O. Ebbesson, E. Boyko, E. Nobmann, A. Adler, and J. Cohen. (1996). Hypertension and diabetes among Siberian Yu'pik Eskimos of St. Lawrence Island, Alaska. *Pub Health Rep* 111 (Suppl. 2): 51–52.
- Taruscio, T.G., D.L. Barney, and J. Exon. (2004). Content and profile of flavanoid and phenolic acid compounds in conjunction with the antioxidant capacity for a variety of Northwest *Vaccinium* berries. *J Agric Food Chem* 52: 3169–3176.
- The Nature Conservancy. (1996). Technology for Conservation: The Information Systems Initiative, Meeting the Needs of Conservation in the 21st Century. [www.tnc.org/news/techcons/index.html](http://www.tnc.org/news/techcons/index.html).
- Tirmenstein, D. (1990). *Vaccinium ovalifolium*. In *Fire Effects Information System*. U.S. Department of Agriculture, Forest Service, Rocky Mountain Research Station, Fire Sciences Laboratory (Producer). [www.fs.fed.us/database/feis/](http://www.fs.fed.us/database/feis/).
- USDA, NRCS. (2004). *The PLANTS Database*, Version 3.5 (<http://plants.usda.gov>). National Plant Data Center, Baton Rouge, Louisiana.
- Welsh, S.L. (1974). *Anderson's Flora of Alaska and Adjacent Parts of Canada*. Brigham Young University Press, Provo, Utah.
- World Wildlife Fund. (1995). Annual report. Shepard Poorman Communications Corp., Indianapolis, Indiana.



# 15

---

## *Relationship between People and Plants*

---

Sara L. Warber and Katherine N. Irvine

### CONTENTS

15.1 Introduction: Historical Context of Herb Usage .....	535
15.2 Effects of Plants on Humans .....	536
15.2.1 Plant Phytochemicals .....	536
15.2.2 Presence of Plants .....	536
15.3 Effects of Humans on Plants .....	537
15.3.1 Human Words.....	537
15.3.2 Human Touch .....	537
15.3.3 Human Thought .....	538
15.3.4 Energy Medicine Research with Plants.....	538
15.4 Reasons for Adopting a Relationship Position: Global Cultural Patterns .....	538
15.4.1 Natural Law or Rhythm Is Best.....	538
15.4.2 People and Land/Nature Are One.....	539
15.4.3 Plants Have Spirit.....	539
15.4.4 Connection of Human and Plant Brings Healing.....	540
15.4.5 Right Action .....	541
15.5 Emerging Standards for Herbal Preparation.....	542
15.5.1 Cultivation .....	542
15.5.2 Ethical Human–Plant Relations .....	542
15.5.3 Certification .....	543
15.6 Conclusions and Future Directions.....	544
References .....	544

---

### 15.1 Introduction: Historical Context of Herb Usage

Plants are playing an increasing role in human health. About 25% of commonly used prescription drugs are derived from traditionally used medicinal plants ([www.who.int/mediacentre/factsheets/fs134/en/](http://www.who.int/mediacentre/factsheets/fs134/en/)). Within the United States, plant-based natural products, such as Echinacea (*Echinacea* spp.) or St. John's wort (*Hypericum perforatum*), are among the most prevalent forms of complementary or alternative medicine (CAM) used, accounting for almost 19% of CAM users ([http://nccam.nih.gov/news/camsurvey\\_fs1.htm#domain](http://nccam.nih.gov/news/camsurvey_fs1.htm#domain)). In 2002, the United States imported more than 200 million kg of medicinal and aromatic botanical raw materials with a total value of about \$332 million (Brinkmann, 2004). Other developed countries are seeing a similar prevalence of use. Ernst and Dixon (2004) reported that 56% of the population in West Germany uses natural remedies for a wide range of conditions (e.g., flu, stomach ulcer, bronchitis). Herbal remedies accounted for more than half of the available over-the-counter remedies available in the United Kingdom in 1996. In less-industrialized areas, such as Africa, approximately 80% of the population continues to use herbal medicine for its primary care ([www.who.int/mediacentre/factsheets/fs134/en/](http://www.who.int/mediacentre/factsheets/fs134/en/)).



The idea that the natural world, in particular, plants, has benefits for human health is not new. Seeds from medicinal plants in use today have been found on frozen humans dating back at least 60,000 years. The first known *Materia Medica*, or book of plant medicines, was written on clay tablets in Sumaria about 2000 BC, and the currently used Chinese *Materia Medica* was written in approximately the first century AD. On a larger scale, even just the presence of plants has been thought to be beneficial. Frederick Law Olmsted, a landscape architect during the early part of the twentieth century, was renowned for incorporating parks with lots of trees into cities and residential areas (Todd, 1982). Central Park, located in the heart of New York, New York, is a clear example of Olmsted's belief in the importance of providing opportunities for city dwellers to rejuvenate themselves through interaction with a natural setting. Access to the natural world was also once considered integral to health care and healthcare settings. In medieval times, hospitals were often located adjacent to monasteries, providing courtyards for walking, sitting, and growing medicinal herbs (Gerlach-Spriggs et al., 1998; Griswold, 1996).

The growing worldwide interest in and use of plant-based medicine, however, raises challenging issues for current and future availability of products from the natural world for health care. With an ever-increasing population, will the natural world be able to sustain increasing demand? Previous chapters in this book presented scientific evidence for pharmaceutical benefits of plants for health in the form of herbal medicine. This chapter expands this inquiry into the evidence of bidirectional effects of nature, in the form of plants on humans, and the reverse, of humans on plants. We look at scientific evidence that highlights this relationship between plants and humans. We then draw on various cultural conceptualizations of the relationship between nature, especially plants, and people to further expand our understanding of appropriate ethical practices. Finally, we highlight emerging commercial standards for herbal use and call for sustainable standards that acknowledge this special relationship between humans and plants.

---

## 15.2 Effects of Plants on Humans

### 15.2.1 Plant Phytochemicals

Any discussion of the effect of plants on people is incomplete without thinking about the effect of plants on health through diet. Plants, in the forms of fruits and vegetables, are a widely accepted component of a healthy diet ([www.med.umich.edu/umim/clinical/pyramid/fruits.htm](http://www.med.umich.edu/umim/clinical/pyramid/fruits.htm)). The colors, flavors, and fragrances of these plant foods, for example, the deep green of kale (*Brassica oleracea* var. *acephala*), a ripe strawberry (*Fragaria chiloensis*), or the smell of onions (*Allium cepa*), are caused by **phytochemicals**. Many of these phytochemicals act as **antioxidants**, preventing cellular destruction and abnormalities ([www.5aday.com/html/phytochem/references.php](http://www.5aday.com/html/phytochem/references.php); [www.med.umich.edu/umim/clinical/pyramid/fruits.htm](http://www.med.umich.edu/umim/clinical/pyramid/fruits.htm)). Preliminary research suggests that these phytochemicals are found in higher concentrations in organically grown than in conventionally grown vegetables (Asami et al., 2003; [www.ota.com/organic/benefits/nutrition.html](http://www.ota.com/organic/benefits/nutrition.html)).

### 15.2.2 Presence of Plants

A growing body of research suggests that interaction with the natural environment, in the form of plants, positively influences multiple dimensions of human health and well-being, including physical, mental, spiritual, and social health (Frumkin, 2001; Irvine and Warber, 2002; Kaplan and Kaplan, 1989). Two theories provide a framework for studying this effect. One, the **nature interaction/stress reduction theory** proposes that nature interaction may counteract the negative physiological effects of stress (Ulrich et al., 1991). Situations that can contribute to feeling stressed include life events (Turner and Wheaton, 1995), chronic strains (Pearlin et al., 1981), daily hassles (Dohrenwend et al., 1984), and lifetime trauma (Breslau et al., 1999). Regardless of the source, research demonstrated that the body's physiological **stress response** is the same (Selye, 1946, 1956). This "fight or flight" response, mediated by the autonomic nervous system, includes increased blood pressure and heart rates (Cannon, 1929). It is theorized that interaction with a non-threatening natural setting enhances the parasympathetic outflow,

which, in turn, offsets the physiological response to a stressful situation. Laboratory studies find that the magnitude of the stress response is higher when viewing images of predominantly built compared to natural settings, and that recovery from a stressful event is faster when viewing images of nature, as measured by blood pressure and muscle tension (Parsons et al., 1998; Ulrich et al., 1991). The effect of nature on the stress response has, to date, only been studied in the laboratory.

The second theory, **attention restoration theory (ART)**, grounded in cognitive psychology, proposes that nature may counteract mental fatigue (Kaplan, 1995). Tasks undertaken each day (e.g., problem solving) and stimuli encountered (e.g., traffic), many of which are abundant in our modern-day living, draw on a resource critical to effective functioning: the capacity to purposefully direct attention (James, 1892/1985; Kaplan, 1995). ART postulates that, in contrast, settings that are natural and stimuli such as animals or plants provide a respite for the need to direct attention. Of particular interest is evidence that nature interaction facilitates recovery from mental fatigue (Cimprich, 1992; Tennessen and Cimprich, 1995; Taylor et al., 2001) and affords the opportunity for reflection (Kaplan and Kaplan, 1989; Kaplan and Talbot, 1983; Herzog et al., 1997; Irvine, 1997, 2004). These findings extend to the inner-city settings in which exposure to “green” environments was shown to increase social interaction (Coley et al., 1997), decrease domestic aggression and violence (Kuo and Sullivan, 2001), and increase the ability to manage day-to-day tasks and major life issues (Kuo and Sullivan, 2001).

---

## 15.3 Effects of Humans on Plants

The above section illustrates both theory and research that suggest that the presence of plants can have a beneficial effect on the health and well-being of humans. Is it possible that people can affect the health of plants? Several researchers explored this reverse relationship with intriguing results.

### 15.3.1 Human Words

Much like people, plants are made up of approximately two-thirds water. Anyone with a garden or houseplant knows that water is essential for the health of plants. Water is drawn up through the roots of plants, into the stem, and out to the leaves, where it eventually departs through openings (**stomata**) in the leaves into the surrounding air. In an indirect way, the water provided by a person to an edible plant is ultimately returned to the person. A researcher in Japan, Masaru Emoto, explored the effects of human words and thoughts on the formation of crystals in water (Emoto, 2004). He found that water forms beautiful crystals when exposed to words such as “love,” “gratitude,” or “thank you.” On the contrary, words such as “fool” or “do it” resulted in poorly formed or no formation of crystals at all. Emoto also explored the effect of music (e.g., classical, heavy metal) and electromagnetic waves on the formation of crystals in water and the ability of water from different sources (e.g., city water system, spring water) to form crystals. If people’s words affect the water within the plants, then likely, they will affect the plants as well.

### 15.3.2 Human Touch

Plants are also affected by people through touch. Many of us have heard of, or perhaps experienced, the effect of touch on the leaves of certain plants, such as mimosa (*Mimosa pudica*). When touched, the leaves visibly drop to a limp position. This discovery was made by a pioneer in the study of plants, Jagadish Chandra Bose, a versatile scientist from India who conducted intricate research during the early part of the 1900s (Shepherd, 1999). Using self-designed instrumentation, he demonstrated not only the visible response to touch, but also, the invisible responses of plants to other forms of human intervention, such as heat, light, gravity, and electricity (Bose, 1906, 1913). More recent evidence indicates that **thigmonastic** or physical contact with plants by humans, such as stroking or rubbing stems, leaves, or flowers, will “turn on” the expression of so-called “touch genes” (Braam, 2005). This has implications for plant survival: insurance of pollination (as in hand-pollinated tomatoes [*Lycopersicon esculentum*]),

the trapping of insect herbivores (as in insectivorous plants), and even the climbing of plants on human-placed supports (stakes) to ensure greater exposure to light.

### 15.3.3 Human Thought

The reactions of plants to events in their environments were further explored by Cleve Backster. An expert in **polygraphs**, or lie detectors, Backster used polygraphs to measure plants' reactions to events. He demonstrated the reaction of plants to human intention (e.g., the intention to burn a leaf), activity occurring in a plant's territory, death of non-human forms of life (e.g., brine shrimp), and the presence or absence of a plant's caretaker (Backster, 2003). Although controversial, in part due to a lack of replication of these studies, Backster's findings suggest that plants may react, in ways we do not yet understand, to humans in their surroundings.

### 15.3.4 Energy Medicine Research with Plants

An additional area of research comes from the field of energy medicine. **Biofield energy healing** is based on the premise that an individual can channel energy for use in healing. Therapeutic touch, practiced by nurses worldwide, and Reiki, a modern adaptation of an ancient Eastern tradition, are two such examples. Grad (1963, 1964) demonstrated an effect of therapeutic touch on corn plants (*Zea mays*); plants exposed to therapeutic touch grew more vigorously than plants that were not. Again, this adds evidence to the notion that humans can affect plants as much as plants affect humans.

---

## 15.4 Reasons for Adopting a Relationship Position: Global Cultural Patterns

In the West, our dominant culture has tended to support the idea that humans are separate from nature, and that nature exists to support the human agenda or perceived needs. Only in recent decades has the ecology movement highlighted the interrelatedness of the fate of the natural world and the fate of humans. In the medical and public health literature, the concept that the environment is being degraded and has adverse effects on human health predominates. Little is thought about the intrinsic value of nature and the potential ethical conflict that might arise between humans and plants when plants are sought for medicine. From a global view, other cultures, both past and present, inform our thinking about the relationship of humans and nature. In this section, we will look at some examples of principles from other cultures that may illuminate alternate ethical positions of humans and nature, especially plants. This cross-cultural perspective will then help us to formulate appropriate actions within commercial herbal production and the practice of medicine.

### 15.4.1 Natural Law or Rhythm Is Best

Many cultures have explicit precepts about the "right" relationship between humans and nature. Taoism is one of the most clear in its gentle guiding of the human toward harmony with the natural law or rhythm. In Taoism, there is a concept called *wu wei*, "without doing, causing, or making." *Wei* comes from the symbols for a clawing hand and a monkey, while *wu wei* means not going against the nature of things. *Wu wei* refers to behavior that arises from a sense of oneself as connected to others and to one's environment. The tendency of the human mind is to separate oneself from reality, meaning the world of natural laws. This then requires increasing effort by the human to fix things, create new orders, and manufacture items to ease life's perceived burdens. In contrast, the concept of *wu wei* fosters an inner sensitivity to the natural rhythm of things. Life lived in this way is efficient, like water flowing over rocks; it is not mechanical, not linear, and minimal effort is required, because we are working with, not against, the natural laws. This behavior simply flows through us because it is the right action, appropriate to its time and place, and serving the purpose of greater harmony and balance (Hoff, 1982; [www.jadedragon.com/archives/june98/tao.html](http://www.jadedragon.com/archives/june98/tao.html)).

### 15.4.2 People and Land/Nature Are One

Many cultures identify humans and the land and, by extension, nature, much more closely with each other than is commonly done in the West. Concepts from Australia, Fiji, and Africa, although widely scattered in geographic origin, create a trail that marks the deep interconnection between humans, nature, and place. This connection is grounded in the concept of a spirit-filled world, of which humans are one equal piece. In Marlo Morgan's (1999) fictional work, she succinctly describes aboriginal Australian thinking when the heroine explains, "My people...lived in oneness with the earth, all its creatures, and each other" (Morgan, 1999, p. 309). Later, the character elaborates, "Every physical thing on planet earth comes from the One Divine Source and all are made from identical fragments of energy. We are one with all creation" (Morgan, 1999, p. 310).

This idea of interconnection is also present in Fijian culture. Richard Katz (1993), in his anthropological work, *The Straight Path*, highlighted the relationship of the people and the land with the ancestral or cosmological gods, known as the *Vu*. "One respects the land and the people and the traditions that govern both; ultimately one's respect is for the *Vu*, since land, people and traditions express the way and will of the *Vu*" (Katz, 1993, p. 28). He explains what he has been taught about the special connection between people and land:

*Vanua* literally means land, but also refers to the social and cultural aspects of the physical environment identified with a social group... For a *vanua* to be recognized, it must have people living on it and supporting and defending its rights and interests. A land without people is likened to a person without a soul. The people are the souls of the physical environment... The land is the physical or geographical entity of the people upon which their survival... depends. It is a major source of life; it provides nourishment, shelter, and protection... Land is thus an extension of the self. Likewise the people are an extension of the land. Land becomes lifeless and useless without the people, and likewise, the people are helpless and useless without the land to thrive on. (Ravuvu, 1987, p. 76, cited in Katz, 1993, p. 26.)

The Fijian principles admonish us to value and respect the land, suggesting that we are nothing when not in relationship with the land. This relationship is a reflection of the connection between human, nature, and spirit. In Africa, Malidoma Somé explained a similar worldview: "Our base is in the Spirit World,... the indigenous mind sees Spirit or the potential for the existence of Spirit in every object; [because] we are hungry for instructions in navigating an often-uncertain world" (Somé, 1998, p. 31). He goes on to explain, "Human beings long for connection, and our sense of usefulness derives from the feeling of connectedness. When we are connected — to our own purpose, to the community around us, and to our spiritual wisdom — we are able to live and act with authentic effectiveness" (Somé, 1998, p. 36). He further stated that, "To attend to the world of Spirit... is to connect to the geography in which you find yourself" (Somé, 1998, p. 36).

These three cultures demonstrate how the land, and nature associated with it, is a reflection of spirit. Humans are likewise spirit, but no more important than others. Humans are at their best when connected to each other and the land and spirit source.

### 15.4.3 Plants Have Spirit

If we accept that nature is filled with spirit, then the plants that we would harvest for medicine must also be filled with spirit. Somé challenges us, asking, "What if they (the elements of nature) are not inanimate objects, as people in the West have been taught to believe, but rather living presences? How would we need to change if we granted to a tree the kind of life that we usually reserve for so-called intelligent beings?" (Somé, 1998, p. 47).

An example of how we might live in relationship with plant spirits is the accord given to the *yaqona* plant (*Piper methysticum*, commonly known as Kava) by the Fijian people.

*Yaqona* accompanies every ceremony; otherwise, the *Vu* are not present (recall from above that the *Vu* are the ancestral or cosmological gods). *Yaqona* is the "nourishment of the gods." Its exchange opens and closes all ceremony and underpins all material and social exchange. It can be offered as the whole

plant, as dried roots, or as finely ground powder. “Though *yaqona* is literally a plant, it is in essence a spiritual messenger” (Katz, 1993, p. 47). While the exchange of *yaqona* takes place between humans, it is actually being exchanged by the *Vu* related to the people. *Yaqona*, when mixed with water, is a mildly psychoactive drink, producing congenial interaction, relaxation, and finally sleepiness. In traditional culture, its use is highly ceremonial and solemn, as befitting the connection to the *Vu*. An elder said, “The *Vu* speak through the *yaqona*. We must be wide awake in order to hear them” (Katz, 1993, p. 54).

Many other cultures, including the Native cultures of North America, acknowledge the spirit of plants, for example, by making offerings to the plant spirit when harvesting the plants (Peat, 1994; Warber et al., 2003). The next section explores how healing is inextricably linked with the connection of human and plant spirit.

#### 15.4.4 Connection of Human and Plant Brings Healing

Oftentimes, we wonder at the causes of sickness and the means for return to health. In the Western worldview, there are known pathogens or altered biochemical processes that cause disease and known molecules to fight the pathogens and fix the biomechanisms of our bodies. This system has been remarkably robust in curing infection and addressing acute catastrophic conditions. But it has not been as successful in ameliorating chronic conditions with multifactorial causation, including the interplay of psychosocial issues with biologic disease. Many people find themselves searching beyond conventional Western medicine for the answers to their health challenges. Indigenous people often have another point of view about the basis for illness and healing. Somé explains, drawing on his indigenous African teachings:

Our relationship to the natural world and its natural laws determines whether or not we are healed. ...every tree, plant, hill, mountain, rock, and each thing that was here before us... has healing power whether we know it or not. So if something in us must change, spending time in nature provides a good beginning. This means that within nature, within the natural world, are all of the materials and tenets needed for healing human beings. (Somé, 1998, p. 38.)

He specifically describes an encounter with a tree’s spirit during his initiation ritual. He felt a kind of deep love and connection with that spirit that could not be denied. For him, it was transformative and healing, reuniting him with nature and his village community after 13 years of French mission schooling (Somé, 1998).

Somé’s experience is echoed around the globe in a story told by South American trained shamana and pharmacist, Connie Grauds. She speaks eloquently of a new kind of medicine where we let the spirit of nature, of plants, enter into the healing process (Grauds, 2001). She tells stories where there is no ingestion of the plant, and yet, a healing shift occurs in the patient. One such story involves a woman with depression who had tried both conventional medicine and St. John’s wort (*Hypericum perforatum*), the best studied of herbal antidepressants. Following a momentary intuition, Grauds recommended that the woman volunteer at a retreat center garden. The woman’s first assignment was to weed a large bed of lavender. Six hours later she was a changed person. She began to incorporate more lavender into her life (i.e., color, smells, bath oils) but never ingested the plant and continued to grow in health (Grauds, 2001). It might be argued that it is, in fact, the spirit of lavender, not the biochemistry of lavender, that is healing this woman.

An ancient source of medicine wisdom is to ask plants for information and receive it telepathically or by other non-ordinary means. This is documented by physicist F. David Peat in his book, *Lighting the Seventh Fire*, that seeks to bridge between Native North American worldview and the Western scientific ontology. He reflects with wonder on a remembered world where animals and plants spoke to humans, teaching them of right behavior and medicinal uses of plants (Peat, 1994). In South America, shamans also have a spiritual relationship with the plants (Grauds, 2001). Don Antonio, Grauds’ teacher from the Amazon rain forest, instructed her, “Stay close to nature. Silence yourself and listen. The plants have secrets to tell you. They can help you and your patients. When a shaman wants to learn the medicinal

properties of any plant, he asks the plant, then listens closely, and the information comes directly from the plant itself. ...[of course] one must also test and experiment with the plant and prove its medicinal value” (Grauds, 2001, p. 168).

From diverse cultures, we see united themes. Plants have spirits, humans can understand this spirit when they silence themselves, and listening to the plant spirits brings knowledge of both medicinal properties and healing that can be life-changing. In the next section, we consider the ethical stance such worldviews would lead us to embrace.

### 15.4.5 Right Action

We turn back again to the Australian Aborigines to hear an admonishment to right action that pertains to even our modern utilitarian world:

You are a guest on this planet, and as such, are expected to leave it as you found it, or in better condition. You are accountable for caring for the other life-forms that cannot speak for or help themselves. You are accountable for promises you make, agreements you enter into, and for the results of all your actions.... In order to help balance the scales, you must become responsible for everything you say and do. You must learn to honor and cherish life and try to sustain it. (Morgan, 1999, pp. 311–312.)

How do we follow these principles and still benefit from the medicine offered to us by the plants? How do we act when we want the medicine from a plant? If we are equally spirits, then acknowledgment, honor, relationship, care, and trust are required. If we would ask for the biochemical healing properties from the physical body of the plant, how much more powerful if we ask for the spirit of the plant to also enter into the healing relationship.

North American Anishinaabe healer, herbalist, and botanist, Keewaydinoquay, in her teachings (Warber et al., 2003) elaborated four ethical principles related specifically to gathering plants for medicine. These four principles take into account the indigenous ethic that we have been building here and are consistent with the scientific evidence that documents a reciprocal beneficial relationship between humans and plants.

*First principle — Respect.* Prior to gathering, the plant spirit must be contacted prayerfully and honored. The honoring is often done by leaving tobacco or a mixture of sacred herbs. This act of prayer and honoring shows the human spirit’s respect for the spirit of the plant people. It acknowledges their equality in the right to continuance. It opens communication between the human and plant. The plant spirit is welcomed to communicate to the waiting and listening human, such that the plant has a choice in the matter at hand as well as the human.

*Second principle — Purpose.* Simply put, there must be a clear purpose for gathering that is explained to the plant spirit. The spirit of the plant is asked if it will extend itself for the intended healing. One must understand that the plant is being asked to give part of itself: its lifeblood (sap), its children (flowers), its future generations (roots), for the needs of humans. This need is spelled out as clearly as possible. Again, the astute gatherer will be listening for understanding, agreement, and the offering of self that comes from each individual plant.

*Third principle — Stewardship.* Gathering is limited both by true need and availability. Gathered plants must be handled competently. One does not gather more than is realistically needed for the purpose at hand, even if that plant is not scarce. Gathering is limited by availability both in the specific locality and across the landscape. For example, if there are 25 to 50 individual plants, then only a few may be harvested. If there is local abundance of an otherwise scarce plant, then there should be hundreds or thousands of individuals before gathering is even considered. When only leaves are required, it is better to take a few leaves from many plants rather than take all the leaves from one plant. Unless the root is the medicinal part required, one should always leave it in place, as many plants will propagate from the rootstock. Plants that are gathered should be handled competently. For example, moldy plant material becomes

unusable and is a waste of the gift of those plants' lives. It is important to use what is gathered or to store it in a protected way for future need.

*Fourth principle — Regeneration.* Finally, when one asks for the gift of the plant's healing powers, one also makes a promise to the plant's spirit. The promise is that the gatherer will personally see to the continuance of these plant-people. This implies that the gatherer will have sufficient knowledge of the reproductive habits of the plant to materially help the process. The gatherer is also bound to actively protect the habitat required by the plants. This creates a true social contract with benefit to all parties. This contract also directly countermands any thought of gathering to extinction. Keeping this promise fulfills a commitment to the plant-people and to the future generations of humans.

These principles emphasize the importance of respect, purpose, stewardship, and regeneration in the collection of herbs. Respectful relations between equally important entities are the rule. Collection is not frivolous or excessive. The source of life for the particular being must be protected. Great care must be taken not to threaten the survival of the species. This includes the protection of the current living individuals and the offspring of these individuals for the future. These principles remind us of the necessity to consider the needs of many future generations as equal to our own (Warber et al., 2003).

---

## 15.5 Emerging Standards for Herbal Preparation

Now we turn to the practical aspects of bringing plant material to market in the form of herbal preparations. Each step along the way would ideally honor the relationship between plants and humans, as well as provide for the sustainability of both the plant populations and the humans engaged in the endeavor. This would create the "best medicine" for all. Throughout this book, the authors addressed good scientific practice and conservation. In this section, we examine current issues of cultivation and certification. We end by envisioning a "plant-human partnership certification" that would ensure the respectful and sustainable production of the highest-quality herbal medicines.

### 15.5.1 Cultivation

The Rain Forest Alliance estimates that currently 25% of all botanical species in trade continue to be collected from the wild, a practice called **wildcrafting** ([www.rainforestalliance.org/news/archives/news/news44.html](http://www.rainforestalliance.org/news/archives/news/news44.html)). If uncontrolled, this practice can negatively impact plant population density and decrease biodiversity. In fact, overharvesting through wildcrafting has been problematic throughout the world. Examples include goldenseal (*Hydrastis canadensis*) in the United States and devils claw (*Harpagophytum procumbens*) in Southern Africa. One approach to conservation is to invest in cultivation. An excellent example of successful cultivation is the American ginseng (*Panax quinquefolius*). In 1993 more than 150,000 pounds of wild-dug ginseng were exported. During the same period, more than 1.5 million pounds of cultivated ginseng were also exported (Foster, 1994).

Although many wild-grown plants and herbs can be successfully cultivated, this may produce large areas of landmass devoted to monocrops of herbs, which in turn, may impact biodiversity both locally and worldwide. The World Health Organization suggests the creation of herbal crop projects in regions where a plant naturally occurs. This would allow the plant to grow in its natural habitat under conditions to which it is well-adapted. Furthermore, these locally cultivated medicinal plants may have stabilizing effects on regional economy ([www.who.int/medicines/library/trm/medicinalplants/agriculture.shtml](http://www.who.int/medicines/library/trm/medicinalplants/agriculture.shtml)).

### 15.5.2 Ethical Human-Plant Relations

Whether plants are wildcrafted or cultivated, envisioning a relationship between humans and plants calls forth the necessity of respectful harvesting practices. When plants are harvested with cooperation on a

spiritual level, the medicines produced are thought to have enhanced effects. As discussed above, this is the belief in many cultures, and the theory could be subjected to scientific validation. Either way, the ethical gathering practices described above also speak to sustainability and maintenance of biodiversity in ways that are important for our ability to use herbal medicines both now and in the future.

### 15.5.3 Certification

Currently available standards for plant products include **organic certification**, **biodynamic certification**, **fair trade certification**, and **third-party or governmental certification**. The first two speak to the methods of cultivation, the third addresses the economic sustainability of the process, and the last focuses on identity and purity. What is lacking is a certification that tells us that the spirit of the plant was honored in the growth, collection, and processing of the medicine.

A growing number of consumers demand that cultivation be done in an **organic fashion** to avoid potential untoward health effects caused by pesticides and growth enhancers (i.e., inorganic fertilizers or enzymes). In response to this consumer demand, the United States created minimum standards for labeling a plant product as organic. Other organizations independently certify organic products based on a higher standard. **Biodynamic certification** tells the conscientious consumer somewhat more, because the certification is tied to the **anthroposophic philosophy** and a way of life that encompasses sustainability. Fair trade certification indicates that there has been a fair price paid to the farmers and workers, and that traditional farming methods were used that maintain biodiversity. At this time, however, there are only a few fair trade standards, specifically for tea leaf, cacao bean, and coffee bean, although others are being proposed (Brinkmann, 2004).

Currently, purity and identity standards are set by several organizations in the United States, including the United States Pharmacopeia (USP) and National Sanitary Foundation International (NSF). NSF worked to establish the American National Standards for Dietary Supplements that set limits for contaminants, establish criteria for quantifying active ingredients, and set criteria for compliance with good manufacturing practices and labeling requirements. The USP sets its own standards, and the Dietary Supplement Health and Education Act of 1994 recognizes the USP National Formulary 22 as the nation's official compendia for dietary supplement standards (Whybark, 2004). These standards are useful, but only if manufacturers voluntarily adhere to them. Consumer confidence in the United States was shaken by numerous reports of variability in the contents of herbal products (Ye et al., 2004). To address this, several types of conformity assessment can be undertaken. One level is self-declaration by a manufacturer. Another is one-time verification, such as the non-voluntary evaluations done by ConsumerLab.com. And a third, and perhaps more reliable, is third-party verification that includes initial testing of compliance to standards and follow-up testing to ensure ongoing compliance. Currently in the United States, third-party verifications are done by ConsumerLab.com, the National Nutritional Foods Association TruLabel Program, the NSF Certification Program, and the USP Dietary Supplement Verification Program (Whybark, 2004). In early 2005, the NSF announced collaboration with the American Herbal Pharmacopoeia (AHP), a nonprofit organization that seeks to set standards for natural products. Both organizations share a vision of supporting increased confidence in botanical dietary supplements by combining their areas of expertise ([www.nsf.org/business/newsroom/press\\_release.asp?p\\_id=9606](http://www.nsf.org/business/newsroom/press_release.asp?p_id=9606)).

Worldwide, 70 countries have created some type of national regulation of herbal medicine, but the specifics vary tremendously from place to place ([www.who.int/mediacentre/factsheets/fs134/en/](http://www.who.int/mediacentre/factsheets/fs134/en/)). In Canada, for example, the government takes an active role in certifying the entire process of the natural products industry. This has led to greater consumer confidence and a stable market for herbal products. The *Codex Alimentarius*, created by the Food and Agriculture Organization (FAO) of the United Nations and the World Health Organization (WHO), promotes unified standards for the processing of food products, and more recently, has expanded into dietary supplements ([www.codexalimentarius.net/web/index\\_en.jsp](http://www.codexalimentarius.net/web/index_en.jsp)). In Europe, because of the expense associated with meeting the standards, it has tended to eliminate small companies from the ability to compete in the market. While the uniformity of identity and purity is desirable, the above standards are insufficient for promoting a relationship-based process and ensuring sustainability.



We advocate for the creation of a new standard for natural health products that all consumers would desire to ensure them of the best medicine, and all growers, harvesters, processors, and sellers would be eager to seek. This standard, the **plant–human partnership certification**, would include standards of organic cultivation or responsible regenerative wildcrafting; harvesting and processing of plant materials that respect the spirit of the plant and ensure identity and purity; and an economic structure that considers fair exchange for all humans involved. When all plants and humans in the process are shown respect, the medicine gathers healing intention throughout the path from nature to the bedside. The humans are healed and brought into greater harmony with nature and the land. Together, the plants and humans create a sustainable system to be passed on to the future generations of each.

---

## 15.6 Conclusions and Future Directions

Clearly, there is a burgeoning interest in herbal remedies to address a variety of human health concerns. The chapters in this book highlighted how plants and their constituents can be utilized. They also presented methods of investigation for determining how these products are useful. Beyond the science in service of human use of plants, there is evidence that plants and humans affect each another in measurable ways beyond direct ingestion of plants by humans. Further, indigenous cultures spanning the globe admonish us to recognize the essential spirit of nature, and specifically, the plants. Based on indigenous wisdom, specific ethical standards for harvesting herbs for medicine have been elaborated. Finally, the available processes for certification of the quality herbal products are reviewed, and a new level of certification that recognizes mutually respectful and sustainable plant–human partnership is proposed. Attention to the relationship of plants and humans and adoption of such a certification would ensure the continuous availability of the highest-quality herbal products for the health of the people, produced with respect for the health of the planet.

---

## References

- Asami, D.K., Y.J. Hong, D.M. Barrett, and A.E. Mitchell. (2003). Comparison of the total phenolic and ascorbic acid content of freeze-dried and air-dried marionberry, strawberry, and corn grown using conventional, organic, and sustainable agricultural practices. *J Agric Food Chem* 51: 1237–1241.
- Backster, C. (2003). *Primary Perception: Biocommunication with Plants, Living Foods, and Human Cells*. White Rose Millennium Press, California.
- Bose, J.C. (1906). *Plant Response as a Means of Physiological Investigation*. Longmans, Green and Company, London.
- Bose, J.C. (1913). *Researches on Irritability of Plants*. Longmans, Green and Company, London.
- Braam, J. (2005) In touch: plant responses to mechanical stimuli. *New Phytologist* 165: 373–389.
- Breslau, N., H.D. Chilcoat, R.C. Kessler, and G.C. Davis. (1999). Previous exposure to trauma and PTSD effects of subsequent trauma: results from the Detroit Area Survey of Trauma. *Am J Psychiatry* 156: 902–907.
- Brinkmann, J. (2004). The medicinal plant supply chain: creating social and environmental sustainability. *Herbalgram* 64: 56–60.
- Cannon, W.B. (1929). *Bodily Changes in Pain, Hunger, Fear, and Rage*. C T Branford, Boston.
- Cimprich, B. (1992). Attentional fatigue following breast cancer surgery. *Res Nurs Health* 15: 192–207.
- Coley, R.L., F.E. Kuo, and W.C. Sullivan. (1997). Where does community grow: the social context created by nature in urban public housing. *Environ and Behav* 29: 468–494.
- Dohrenwend, B.S., B.P. Dohrenwend, M. Dodson, and P.E. Shrout. (1984). Symptoms, hassles, social supports, and life events: problem of confounded measures. *J Abnorm Psychol* 93: 222–230.
- Emoto, M. (2004). *The Hidden Messages in Water*. (D. A. Thayne, Translator). Beyond Words Publishing, Hillsboro, Oregon.

- Ernst, E. and A. Dixon. (2004). Alternative medicines in Europe. In E. Mossialos, M. Mrazek, and T. Walley (Eds.). *Regulating Pharmaceuticals in Europe: Striving for Efficiency, Equity, and Quality*. Open University Press, Berkshire, United Kingdom, pp. 307–322.
- Foster, S. (1994). Commercial herb production: conservation by cultivation. *Herbalgram* 32: 38.
- Frumkin, H. (2001). Beyond toxicity: human health and the natural environment. *Am J Prev Med* 20: 234–240.
- Gerlach-Spriggs, N., R.E. Kaufman, and S.B. Warner, Jr. (1998). *Restorative Gardens: The Healing Landscape*. Yale University Press, New Haven, Connecticut.
- Grad, B. (1963). A telekinetic effect on plant growth. *Int J Parapsychol* 5: 117–133.
- Grad, B. (1964). A telekinetic effect of plant growth: II experiments involving treatment of saline in stoppered bottles. *Int J Parapsychol* 6: 473–498.
- Grauds, C. (2001). *Jungle Medicine*. Citron Bay Press, Marin County, California.
- Griswold, M. (1996). A history of the sanctuary garden. *Design Q* 169: 2–10.
- Herzog, T.R., A.M. Black, K.A. Fountaine, and D.J. Knotts. (1997). Reflection and attentional recovery as distinctive benefits of restorative environments. *J Environ Psychol* 17: 165–170.
- Hoff, B. (1982). *The Tao of Pooh*. E.P. Dutton, New York.
- Irvine, K.N. (1997). *Stewardship in the Management of Private Forests: Some Psychological Dimensions*. Unpublished master's thesis. University of Michigan, Ann Arbor.
- Irvine, K.N. (2004). *Work Breaks and Well-Being: The Effect of Nature on Hospital Nurses*. Doctoral dissertation. University of Michigan, Ann Arbor.
- Irvine, K.N. and S.L. Warber. (2002). Greening healthcare: practicing as if the natural environment really mattered. *Alternative Ther in Health and Med* 8: 76–83.
- James, W. (1892/1985). *Psychology: The Briefer Course*. (Edited by Gordon Allport). University of Notre Dame Press, Notre Dame, Indiana.
- Kaplan, R. and S. Kaplan. (1989). *The Experience of Nature: A Psychological Perspective*. Cambridge University Press, Cambridge. Republished in 1996 by Ulrich's, Ann Arbor, Michigan.
- Kaplan, S. (1995). The restorative benefits of nature: toward an integrative framework. *J Environ Psychol* 15: 159–182.
- Kaplan, S. and J.E. Talbot. (1983). Psychological benefits of a wilderness experience. In *Behavior and the Natural Environment*, I. Altman and J.F. Wohlwill (Eds.). Plenum Press, New York, pp. 163–203.
- Katz, R. (1993). *The Straight Path: A Story of Healing and Transformation in Fiji*. Addison-Wesley, New York.
- Kuo, F.E. and W.C. Sullivan. (2001). Aggression and violence in the inner city: effects of environment via mental fatigue. *Environ and Behav* 33: 543–571.
- Morgan, M. (1999). *Mutant Message from Forever*. Perennial/Harper Collins, New York.
- Parsons, R., L.G. Tassinary, R.S. Ulrich, M.R. Hebl, and M. Grossman-Alexander. (1998). The view from the road: implications for stress recovery and immunization. *J Environ Psychol* 18: 113–139.
- Pearlin, L.I., E.G. Menaghan, M.A. Lieberman, and J.T. Mullin. (1981). The stress process. *J Health Soc Behav* 22: 337–356.
- Peat, F.D. (1994). *Lighting the Seventh Fire: The Spiritual Ways, Healing, and Science of the Native American*. Birch Lane Press, New York.
- Selye, H. (1946). The general adaptation syndrome and diseases of adaptation. *J Clin Endocrinol* 6: 217–230.
- Selye, H. (1956). *The Stress of Life*. McGraw-Hill, New York.
- Shepherd, V.A. (1999). Bioelectricity and the rhythms of sensitive plants — the biophysical research of Jagadis Chandra Bose. *Current Sci* 77: 189–195.
- Somé, M.P. (1998). *The Healing Wisdom of Africa: Finding Life Purpose through Nature, Ritual, and Community*. Jeremy P. Tarcher/Putnam, New York.
- Taylor, A.F., F.E. Kuo, and W.C. Sullivan. (2001). Coping with ADD: the surprising connection to green play settings. *Environ and Behav* 33: 54–77.
- Tennessen, C.M. and B. Cimprich. (1995). Views to nature: effects on attention. *J Environ Psychol* 15: 77–85.
- Todd, J.E. (1982). *Frederick Law Olmsted: A Biography*. Twayne, Boston.
- Turner, R.J. and B. Wheaton. (1995). Checklist measurement of stressful life events. In *Measuring Stress: A Guide for Health and Social Scientists*, S. Cohen, R.C. Kessler, and L.U. Gordon (Eds.). Oxford University Press, New York, pp. 29–53.
- Ulrich, R.S., R.F. Simons, B.D. Losito, E. Fiorito, M.A. Miles, and M. Zelson. (1991). Stress recovery during exposure to natural and urban environments. *J Environ Psychol* 11: 201–230.

- Warber, S.L., M.D. Feters, and P.B. Kaufman. (2003). Environmental ethics: finding a moral compass for human–plant interaction. *Alternative Ther in Health and Med* 9: 100–105.
- Whybark, M.K. (2004). Third-party evaluation programs for the quality of dietary supplements. *Herbalgram* 64: 30–33.
- Ye, F.H., S. Wang, J. Jiang, J. Wu, J. Shao, X. Cheng, Y. Tu, and D.Y. Zhang. (2004). Quality evaluation of commercial extracts of *Scutellaria baicalensis*. *Nutr & Cancer* 49: 217–222.

# Appendix

---

## *Information Retrieval on Natural Products in Plants*

---

---

### Basic Questions to Ask

In this book, we included a great deal of useful and up-to-date information about a vast array of natural products in plants. How does one go about getting more information about a given natural product of interest for a given plant species? We found it useful to research information about natural products of medicinal value in plants by asking the following questions:

1. Where does the plant of interest grow in nature, and how has it been used by indigenous peoples in their traditional medicine?
2. How does one go about propagating and growing this plant in the greenhouse or field so as to be able to do experiments on it, to examine the compounds of interest, to upregulate the biosynthesis of the compounds of interest, or to simply use it as a “show and tell” on medicinal plants to students, patients, or scientists working on the plant?
3. How does the plant synthesize the compound of interest; that is, what is the biochemical pathway leading to the synthesis of the compound, and what are the enzymes involved at each step in the pathway (if known)?
4. Is it possible to upregulate the biosynthesis of the compound of interest by means of environmental stress treatments, by cultural practices, by herbivory, or by enhancing or turning off gene expression for particular steps in the biosynthetic pathway?
5. Can one mass produce the compound of interest in plant cell suspension cultures, in greenhouse bioreactors, or even in space on board a space station?
6. Does the compound of medicinal interest to humans have any special adaptive functions in the plant itself? Does it repel predators? Does it act as a poison? Does it prevent attack by predacious insects or pathogenic bacteria, fungi, or viruses?
7. How does the compound of interest act at target sites in humans to prevent or arrest a particular disease? Is it a single compound doing the most effective job, or is it due to synergistic action between two or more compounds (chemically related or chemically unrelated) produced by the same plant or coming from two or more plant species?
8. If this plant is rare, endangered, or threatened in its natural habitat, what is being done to save it from extinction and to make it thrive either in the wild or in cultivation? Were good sources of seeds or propagules of this plant obtained commercially or from seed/plant/tissue culture germplasm “banks?”

---

### Surfing the Web

The Internet (“the Web” or “the Net”) provides a vast amount of data for biologists. From manuscript to posting on the Web is a small step. Word-processing documents, spreadsheets, and digital graphics are all easily made available on the Net.

The difficulty with the Net in its current form is two-fold. First, data must be prepared in machine form. At first glance, this may not seem to be a significant problem, as most new data are already collected as computer files, entered into graphing and spreadsheet programs and prepared on word processors. However, data collected and published before the widespread use of computers remain generally unavailable on the Net, and the conversion of these data to machine form remains very slow due to lack of funding. The result is that the Net contains relatively recent information, reflecting the current fashions in scientific research, but little from earlier work that may be of possible significance to a researcher's studies.

The second problem is that of finding information on the Net. The Net can be viewed as a world of data with no map. Research is required to produce the "rudders" for navigating. There are some tools for searching keywords, such as Yahoo!® or Google™, but these provide only a starting point for a process that is essentially serendipitous. Librarians trained in searching the Net are extremely important. Net search tools, however, are only just getting to the point where researchers can easily extract the desired data with only minimal assistance from information specialists.

The Net also provides data in truly unique and powerful forms not readily available in the past. For example, molecular modeling programs such as RasMol provide three-dimensional models of chemical compounds. A researcher can download molecule databases to his or her desktop computer and examine the molecule in various forms (spacefill, stick and ball,  $\alpha$ -helix/ $\beta$ -sheet, etc.) and rotate that molecule about three axes. Viewing structures and "interacting" with them in this fashion is more compelling than the two-dimensional images of conventional print.

### Some Means of Access to Net Information

- Online catalogs are the oldest and best-developed network resource, having been in existence since the mid-1980s. Catalogs are electronic versions of library card catalogs with the added advantage of providing rapid searching by author, subject, and keywords. Most libraries added other services first available in paper form, such as Biological Abstracts® and AGRICOLA. Many libraries are now providing full-text retrieval systems for select journals, and there is a growing interlibrary network of catalogs that allows the researcher to remotely survey several libraries and place interlibrary loan requests from his or her home campus.
- Searching tools provide keyword searches across the Net. They function like keyword searches for library catalogs, but instead of searching specific book and journal collections, they search for word matches on Web pages. The results can often be interesting but not especially relevant to a researcher and, as a result, are usually the start, rather than the end, of a search process.
- Mail lists and news lists provide "newsletters" focused on specific areas of interest. The major difference between the two is that you must subscribe to a mail list (i.e., it has a limited distribution), while a news list is available to anyone with news reader client software (e.g., NewsWatcher and Nuntius). The News List includes numerous entries of interest to biologists in the "bionet" and "sci" sections; however, because they are open to all, the individual items can be of variable quality. Mail lists are generally found using search tools.

---

### A List of Useful Web Sites

We compiled a listing of some of the most useful (or perhaps just entertaining) Web sites for the study of natural products from plants. We hope that they will provide those who are interested with a quick and easy way to access a mind-boggling amount of information on this topic.

#### Search Engines

Agricola (<http://agricola.nal.usda.gov>) — Bibliographic database of citations to the agricultural literature created by the National Agricultural Library and its cooperators.

- Electronic Sites of Botany, Plant Biology & Science Journals ([www.e-journals.org/botany](http://www.e-journals.org/botany)) — Links to the electronic sites of major journals publishing articles about plants and plant biology.
- Entrez PubMed ([www.ncbi.nlm.nih.gov/entrez](http://www.ncbi.nlm.nih.gov/entrez)) — National Library of Medicine's search service providing access to more than 10 million citations in Medline.
- Google Scholar (<http://scholar.google.com>) — A general search service that is applicable to scientific research.
- Science Direct ([www.sciencedirect.com](http://www.sciencedirect.com)) — An information source for scientific, technical, and medical research, including search services for scientific citations.
- Scirus ([www.scirus.com/srsapp](http://www.scirus.com/srsapp)) — Search engine that fetches only scientific Web sites.

## Information on Plants and Their Uses

- The American Society of Plant Biologists Home Page ([www.aspb.org](http://www.aspb.org)) — A society designed to promote the growth and development of plant biology, to encourage and publish research in plant biology, and to promote the interests and growth of plant science.
- Dr. Duke's Phytochemical and Ethnobotanical Databases ([www.ars-grin.gov/duke](http://www.ars-grin.gov/duke); [www.ars-grin.gov/duke/dev/all.html](http://www.ars-grin.gov/duke/dev/all.html)) — Search plants by chemical, activity or ethnobotanical use. Includes lists of browsable databases and rain forest information.
- Fairchild Tropical Garden Virtual Herbarium ([www.virtualherbarium.org](http://www.virtualherbarium.org)) — The Virtual Herbarium is a text and photographic database of the specimens in the Fairchild Tropical Garden Herbarium and includes the Florida Atlantic University herbarium as well as the Buswell collection from the University of Miami, Florida.
- Folk Medicine at UCLA ([www.folkmed.ucla.edu](http://www.folkmed.ucla.edu)) — Includes a searchable database by keyword, usage, condition, belief, date, region, or ethnicity of origin.
- Handbook of Energy Crops ([www.hort.purdue.edu/newcrop/duke\\_energy/dukeindex.html](http://www.hort.purdue.edu/newcrop/duke_energy/dukeindex.html)) — A list used to access the medicinal uses and chemistry of 200 potential energy species.
- HerbalGram ([www.herbalgram.org](http://www.herbalgram.org)) — Offers publications, information, and education on herbal medicine.
- Internet Directory for Botany ([www.botany.net/IDB](http://www.botany.net/IDB)) — An index to botanical information available on the Internet. It consists of two parts — an alphabetical directory and a categorical directory.
- Missouri Botanical Garden w3TROPICOS (<http://mobot.mobot.org/W3T/Search/vast.html>) — Database of plant names, information on them, and the sources of information, including improved access to the Missouri Botanical Garden's VAST (VAScular Tropicos) nomenclatural database.
- Native American Ethnobotany (<http://herb.umd.umich.edu>) — A database of foods, drugs, dyes, and fibers of Native American peoples, derived from plants.
- Neem Foundation ([www.neemfoundation.org](http://www.neemfoundation.org)) — A foundation dedicated to making available all information about neem to all people. The input for this site comes from very competent scientists, farmers, and other professionals.
- Plants of Monteverde Species Lists ([www.cs.umb.edu/~whaber/Monte/Plant/Plt-lst.html](http://www.cs.umb.edu/~whaber/Monte/Plant/Plt-lst.html)) — A list of vascular plants found in the Monteverde region of northwestern Costa Rica.
- Small Guide to Nature's Fragrances (<http://hjem.get2net.dk/bojensen/EssentialOilsEng/Essential-Oils.htm>) — Aspects of the chemistry of the essential oils.
- Tale of Taxol ([www.research.fsu.edu/researchr/fall2002/taxol.html](http://www.research.fsu.edu/researchr/fall2002/taxol.html)) — Information on the use of Pacific yews in the quest for Taxol®.
- Transgenica ([www.transgenica.com](http://www.transgenica.com)) — Botanical database arranged in an index format by common name — contains extensive information on natural products.
- Virtual Library of Botany/Plant Biology ([www.ou.edu/cas/botany-micro/www-vl](http://www.ou.edu/cas/botany-micro/www-vl)) — Contains an abundance of information on botany and related subjects.

## Health and Drug Information

- Ask Dr. Weil ([www.drweil.com](http://www.drweil.com)) — A guide to eating well for optimum health by Dr. Andrew Weil.
- Centers for Disease Control and Prevention ([www.cdc.gov](http://www.cdc.gov)) — Government agency designed to promote health and quality of life by preventing and controlling disease, injury, and disability.
- Drug Discovery Online ([www.drugdiscoveryonline.com](http://www.drugdiscoveryonline.com)) — Informative synopsis of news, product updates, discussion forums, and online chat regarding all aspects of drug discovery. Said to be a valuable source of information for the drug industry and professionals.
- History of Malaria ([www.cdc.gov/malaria/history](http://www.cdc.gov/malaria/history)) — Information on malaria. Provided by the U.S. Centers for Disease Control and Prevention.
- Natural Medicines — Comprehensive Database ([www.naturaldatabase.com](http://www.naturaldatabase.com)) — Provides information on products, effectiveness of natural products, interaction between natural products and other drugs, diseases, and conditions for which natural products are recommended.
- Natural Products Industry Insider ([www.naturalproductsinsider.com](http://www.naturalproductsinsider.com)) — Provides timely news information for executives involved in manufacturing and marketing natural products.
- Natural Products Information (<http://druginfo.umkc.edu/NaturalProducts.htm>) — Natural product information at University of Missouri–Kansas City.
- U.S. Environmental Protection Agency ([www.epa.gov](http://www.epa.gov)) — Government agency responsible for protecting the natural environment.
- U.S. Food and Drug Administration Center for Food Safety and Applied Nutrition (<http://vm.cfsan.fda.gov>) — Government agency responsible for maintaining the safety of food and drug products.

## Research Tools and Information on Chemicals

- Biocatalysis/Biodegradation Database (<http://umbbd.ahc.umn.edu>) — The University of Minnesota Biocatalysis/Biodegradation Database provides information on microbial biocatalytic reactions and biodegradation pathways as well as natural product metabolism.
- BioCyc Database Collection (<http://biocyc.org>) — BioCyc is a collection of Pathway/Genome Databases. Each database in the BioCyc collection describes the genome and metabolic pathways of a single organism.
- Cyberlipid Center ([www.cyberlipid.org](http://www.cyberlipid.org)) — Information on lipids: their history, structure, use, and analysis.
- Entrez Cross-Database Search ([www.ncbi.nlm.nih.gov/gquery/gquery.fcgi](http://www.ncbi.nlm.nih.gov/gquery/gquery.fcgi)) — Retrieves molecular biology data and bibliographic citations from the National Center for Biotechnology Information (NCBI) integrated databases.
- ExPASy Proteomics Tools (<http://us.expasy.org/tools>) — ExPASy World Wide Web (WWW) molecular biology server of the Swiss Institute of Bioinformatics (SIB) sequence analysis tools.
- Flavornet and Human Odor Space ([www.flavornet.org/flavornet.html](http://www.flavornet.org/flavornet.html)) — Flavornet is a gas chromatography–olfactometry (GCO) compilation of natural product aroma compounds found in human odor space. The list includes gas chromatography (GC) retention indices.
- GenomeNet ([www.genome.ad.jp](http://www.genome.ad.jp)) — Contains a broad range of searches for information on genes, genomes, and pathways, including the Kyoto Encyclopedia of Genes and Genomes (KEGG).
- Natural Products ([www.cem.msu.edu/~reusch/VirtualText/biomol.htm](http://www.cem.msu.edu/~reusch/VirtualText/biomol.htm)) — A collection of information on important classes of natural products.
- Pedro's BioMolecular Research Tools ([www.public.iastate.edu/~pedro/research\\_tools.html](http://www.public.iastate.edu/~pedro/research_tools.html)) — A collection of WWW links to information and services useful to molecular biologists.

Phytochemical Compounds ([www.genome.jp/dbget-bin/get\\_htext?Phyto](http://www.genome.jp/dbget-bin/get_htext?Phyto)) — One page contained within GenomeNet that has links to information on a huge number of alkaloid, phenolic, and terpenoid compounds.

Phytochemistry Tutorials ([http://friedli.com/herbs/phytochem/phyto\\_tutorial.html](http://friedli.com/herbs/phytochem/phyto_tutorial.html)) — An herbalist's site but contains useful information on a range of compounds synthesized by plants.

Plant Hormones ([www.plant-hormones.info](http://www.plant-hormones.info)) — A comprehensive site on plant hormones from the University of Bristol, United Kingdom.

SpecAlign (<http://physchem.ox.ac.uk/~jwong/specalign>) — An alignment tool for spectral data.

University of Arizona Chemistry Department Natural Products Database (<http://npd.chem.arizona.edu>) — Proton nuclear magnetic resonance (NMR) database of natural products.

University of Florida Citrus Color and Flavor Chemistry ([www.crec.ifas.ufl.edu/rouseff](http://www.crec.ifas.ufl.edu/rouseff)) — Includes a database of flavor components listed in order of gas chromatography (GC) retention indices.



