

NITROGEN FIXATION: ORIGINS, APPLICATIONS, AND RESEARCH PROGRESS

Nitrogen-fixing Leguminous Symbioses

Edited by

Michael J. Dilworth, Euan K. James,
Janet I. Sprent and William E. Newton



 Springer

Nitrogen-fixing Leguminous Symbioses

Nitrogen Fixation: Origins, Applications,
and Research Progress

VOLUME 7

Nitrogen-fixing Leguminous Symbioses

Edited by

Michael J. Dilworth

Murdoch University, Perth, Australia

Euan K. James

University of Dundee, UK

Janet I. Sprent

University of Dundee, UK

and

William E. Newton

*Virginia Polytechnic Institute and State University,
Blacksburg, Virginia, USA*

 Springer

Library of Congress Control Number: 2008920616

ISBN 978-1-4020-3545-6 (HB)
ISBN 978-1-4020-3548-7 (e-book)

Published by Springer,
P.O. Box 17, 3300 AA Dordrecht, The Netherlands.

www.springer.com

Background figure caption:-

“A seed crop of clover (*Trifolium hirtum*) in flower near Moora, Western Australia. Photograph courtesy of Mike Davies, Senior Technical Officer, Pasture Research Group of Agriculture WA and reproduced with permission.”

Vol. 7-specific figure caption:-

“The flower head shown is of *Lotononis angolensis*, growing in the perennial legume breeding program at the Centre for Rhizobium Studies (CRS), Murdoch University, Western Australia. *L. angolensis* offers a suite of characteristics, which include drought, grazing, and acidity tolerance, and has future use potential in broad-acre agriculture for infertile soils (see Chapter 12). *L. angolensis* is nodulated by an unique root-nodule bacterium that has yet to be taxonomically defined. The picture was provided by Ron Yates (Department of Agriculture and Food, Western Australia) and is used with both his and the CRS Director’s permission.”

Printed on acid-free paper

All Rights Reserved

© 2008 Springer Science+Business Media B.V.

No part of this work may be reproduced, stored in a retrieval system, or transmitted in any form or by any means, electronic, mechanical, photocopying, microfilming, recording or otherwise, without written permission from the Publisher, with the exception of any material supplied specifically for the purpose of being entered and executed on a computer system, for exclusive use by the purchaser of the work.

TABLE OF CONTENTS

Preface to the Series	ix
Preface	xiii
List of Contributors	xvii
Chapter 1. Evolution and Diversity of Legume Symbiosis	
<i>J. I. Sprent</i>	1
1. Introduction	1
2. The Diversity of Legume Nodules	1
3. The First 700 Million Years	3
4. The Last 60 Million Years	8
5. The Present	17
6. Conclusions	18
References	18
Chapter 2. Ecology of Root-Nodule Bacteria of Legumes	
<i>P. H. Graham</i>	23
1. Introduction	23
2. Taxonomy of the Root-Nodule Bacteria	24
3. Population Structure of Rhizobia in Soil and Rhizosphere	28
4. Above and Below Ground Diversity and Symbiotic Function	33
5. Strain Competitiveness, Rhizosphere Colonization, and Persistence	38
6. Edaphic Factors Affecting Rhizobia	41
7. Future Dimensions of Rhizobial Ecology	43
References	43
Chapter 3. Maintaining Cooperation in the Legume-Rhizobia Symbiosis: Identifying Selection Pressures and Mechanisms	
<i>E. T. Kiers, S. A. West, and R. F. Denison</i>	59
1. Introduction	59
2. Explaining Cooperation: The Problem	60
3. Explaining Cooperation: The Hypothesis	61
4. Cheating and Mixed Nodules	70
5. Future Directions	71
6. Conclusion	72
Acknowledgements	72
References	73

Chapter 4. Inoculation Technology for Legumes	
<i>D. F. Herridge</i>	77
1. Introduction	77
2. The Need to Inoculate	78
3. Selection of Rhizobial Strains for Use in Inoculants	88
4. Inoculants in the Market Place	92
5. Pre-inoculated and Custom-Inoculated Seed	101
6. Co-inoculation of Legumes with Rhizobia and Other Beneficial Microorganisms	102
7. Quality Control of Legume Inoculants	103
8. Constraints to Inoculant Use and Future Prospects	107
9. Concluding Statements	109
References	109
Chapter 5. Fine-tuning of Symbiotic Genes in Rhizobia: Flavonoid Signal Transduction Cascade	
<i>H. Kobayashi and W. J. Broughton</i>	117
1. Introduction	117
2. NodD and <i>Nod</i> -boxes: Central Elements in Transduction of Flavonoid Signals	118
3. Functions of Genes Controlled by <i>Nod</i> -boxes	122
4. Fine-tuning Expression of Symbiotic Genes in Restricted-Host Range Rhizobia	130
5. Post-genomic Studies: Do Flavonoids Regulate Other Genes?	140
6. Conclusion and Perspectives: Roles of Flavonoid-inducible Regulons in Symbiosis, Signaling and Adaptation	142
References	143
Chapter 6. Cell Biology of Nodule Infection and Development	
<i>N. Maunoury, A. Kondorosi, E. Kondorosi, and P. Mergaert</i>	153
1. Introduction	153
2. Nod Factor Signalling	156
3. Cortical Cell Activation Leading to Primordium Formation and Infection	160
4. Secondary Signals for Nod Factor-induced Cell Activation	163
5. Differentiation of N ₂ -fixing Cells: The Role of Endoreduplication	169
6. Bacteroid Differentiation	173
7. Nitrogen Fixation	177
8. Senescence of Nodules	178
References	180

Chapter 7. Genetics: A Way to Unravel Molecular Mechanisms
Controlling the Rhizobial-legume Symbiosis

<i>P. Smit and T. Bisseling</i>	191
1. Introduction	191
2. Model Legumes	192
3. Genetic Dissection of the Nod Factor-signaling Pathway	194
4. Nature of the Nod Factor Receptors	199
5. The DMI Proteins	201
6. NSPs are Nod Factor-response Factors	202
7. NIN is a Nod Factor-responsive Factor	203
8. Autoregulation of Nodule Number	204
9. Concluding Remarks	205
References	206

Chapter 8. Legume Genomics Relevant to N₂ Fixation

<i>L. Schauser, M. Udvardi, S. Tabata, and J. Stougaard</i>	211
1. Introduction	211
2. Genomes	212
3. Transcriptome Analysis	219
4. Proteomics	223
5. Metabolomics	226
6. Genetic Analysis Using Genomics	228
7. Comparative Genomics	230
8. Conclusions	233
References	233

Chapter 9. Physiology of Root-nodule Bacteria

<i>P. S. Poole, M. F. Hynes, A. W. B. Johnston, R. P. Tiwari, W. G. Reeve, and J. A. Downie</i>	241
1. Introduction	241
2. Introduction to Central Metabolism	242
3. Metabolism and the Environment	251
4. Micronutrition, Metals, and Vitamins	254
5. Environmental Responses of Rhizobia	259
6. Changes in Gene Expression in Bacteroids	266
7. Stress Responses in Rhizobia	267
References	276

Chapter 10. Carbon and Nitrogen Metabolism in Legume Nodules	
<i>C. P. Vance</i>	293
1. Legume Root Nodules are Carbon and Nitrogen Factories	293
2. Nodule Carbon Metabolism	296
3. Sucrose Synthase	297
4. Phosphoenolpyruvate Carboxylase	299
5. Carbonic Anhydrase	300
6. Malate Dehydrogenase	301
7. Initial Assimilation of Fixed-N	302
8. Glutamine Synthetase	305
9. Glutamate Synthase	306
10. Aspartate Aminotransferase	308
11. Asparagine Synthetase	309
12. Ureide Biosynthesis	310
13. Genomic Insights	313
14. Overview	315
References	315
Chapter 11. Oxygen Diffusion, Production of Reactive Oxygen and Nitrogen Species, and Antioxidants in Legume Nodules	
<i>F. R. Minchin, E. K. James, and M. Becana</i>	321
1. Introduction	321
2. Physiological Evidence for a Variable Oxygen Diffusion Barrier	324
3. Structure of the Cortical Oxygen Diffusion Barrier	327
4. Development of the Cortical Oxygen Diffusion Barrier	336
5. Regulation of the Cortical Oxygen Diffusion Barrier	338
6. Infected Zone Control	341
7. Reactive Oxygen and Nitrogen Species in Nodules	342
8. Antioxidants in Nodules	345
9. Concluding Remarks	351
References	353
Chapter 12. Prospects for the Future Use of Legumes	
<i>J. G. Howieson, R. J. Yates, K. J. Foster, D. Real, and R. B. Besier</i>	363
1. Introduction	363
2. Current and Past Legume-usage Patterns	365
3. New Uses for Legumes	368
4. Matching Legumes and the Symbiosis to Edaphic and Economic Parameters	380
5. Utilising the Basic Advances	384
6. Conclusions	386
References	387
Subject Index	395

PREFACE TO THE SERIES

Nitrogen Fixation: Origins, Applications, and Research Progress

Nitrogen fixation, along with photosynthesis as the energy supplier, is the basis of all life on Earth (and maybe elsewhere too!). Nitrogen fixation provides the basic component, fixed nitrogen as ammonia, of two major groups of macromolecules, namely nucleic acids and proteins. Fixed nitrogen is required for the N-containing heterocycles (or bases) that constitute the essential coding entities of deoxyribonucleic acids (DNA) and ribonucleic acids (RNA), which are responsible for the high-fidelity storage and transfer of genetic information, respectively. It is also required for the amino-acid residues of the proteins, which are encoded by the DNA and that actually do the work in living cells. At the turn of the millennium, it seemed to me that now was as good a time as any (and maybe better than most) to look back, particularly over the last 100 years or so, and ponder just what had been achieved. What is the state of our knowledge of nitrogen fixation, both biological and abiological? How has this knowledge been used and what are its impacts on humanity?

In an attempt to answer these questions and to capture the essence of our current knowledge, I devised a seven-volume series, which was designed to cover all aspects of nitrogen-fixation research. I then approached my long-time contact at Kluwer Academic Publishers, Ad Plaizier, with the idea. I had worked with Ad for many years on the publication of the Proceedings of most of the International Congresses on Nitrogen Fixation. My personal belief is that congresses, symposia, and workshops must not be closed shops and that those of us unable to attend should have access to the material presented. My solution is to capture the material in print in the form of proceedings. So it was quite natural for me to turn to the printed word for this detailed review of nitrogen fixation. Ad's immediate affirmation of the project encouraged me to share my initial design with many of my current co-editors and, with their assistance, to develop the detailed contents of each of the seven volumes and to enlist prospective authors for each chapter.

There are many ways in which the subject matter could be divided. Our decision was to break it down as follows: nitrogenases, commercial processes, and relevant chemical models; genetics and regulation; genomes and genomics; associative, endophytic, and cyanobacterial systems; actinorhizal associations; leguminous symbioses; and agriculture, forestry, ecology, and the environment. I feel very fortunate to have been able to recruit some outstanding researchers as co-editors for this project. My co-editors were Mike Dilworth, Claudine Elmerich, John Gallon, Euan James, Werner Klipp, Bernd Masepohl, Rafael Palacios, Katharina Pawlowski, Ray Richards, Barry Smith, Janet Sprent, and Dietrich Werner. They

worked very hard and ably and were most willing to keep the volumes moving along reasonably close to our initial timetable. All have been a pleasure to work with and I thank them all for their support and unflagging interest.

Nitrogen-fixation research and its application to agriculture have been ongoing for many centuries – from even before it was recognized as nitrogen fixation. The Romans developed the crop-rotation system over 2000 years ago for maintaining and improving soil fertility with nitrogen-fixing legumes as an integral component. Even though crop rotation and the use of legumes was practiced widely but intermittently since then, it wasn't until 1800 years later that insight came as to how legumes produced their beneficial effect. Now, we know that bacteria are harbored within nodules on the legumes' roots and that they are responsible for fixing N_2 and providing these plants with much of the fixed nitrogen required for healthy growth. Because some of the fixed nitrogen remains in the unharvested parts of the crop, its release to the soil by mineralization of the residue explains the follow-up beneficial impact of legumes. With this realization, and over the next 100 years or so, commercial inoculants, which ensured successful bacterial nodulation of legume crops, became available. Then, in the early 1900's, abiological sources of fixed nitrogen were developed, most notable of these was the Haber-Bosch process. Because fixed nitrogen is almost always the limiting nutrient in agriculture, the resulting massive increase in synthetic fixed-nitrogen available for fertilizer has enabled the enormous increase in food production over the second half of the 20th century, particularly when coupled with the new "green revolution" crop varieties. Never before in human history has the global population enjoyed such a substantial supply of food.

Unfortunately, this bright shiny coin has a slightly tarnished side! The abundance of nitrogen fertilizer has removed the necessity to plant forage legumes and to return animal manures to fields to replenish their fertility. The result is a continuing loss of soil organic matter, which decreases the soil's tilth, its water-holding capacity, and its ability to support microbial populations. Nowadays, farms do not operate as self-contained recycling units for crop nutrients; fertilizers are trucked in and meat and food crops are trucked out. And if it's not recycled, how do we dispose of all of the animal waste, which is rich in fixed nitrogen, coming from feedlots, broiler houses, and pig farms? And what is the environmental impact of its disposal? This problem is compounded by inappropriate agricultural practice in many countries, where the plentiful supply of cheap commercial nitrogen fertilizer, plus farm subsidies, has encouraged high (and increasing) application rates. In these circumstances, only about half (at best) of the applied nitrogen reaches the crop plant for which it was intended; the rest leaches and "runs off" into streams, rivers, lakes, and finally into coastal waters. The resulting eutrophication can be detrimental to marine life. If it encroaches on drinking-water supplies, a human health hazard is possible. Furthermore, oxidation of urea and ammonium fertilizers to nitrate progressively acidifies the soil – a major problem in many agricultural areas of the world. A related problem is the emission of nitrogen oxides (NO_x) from the soil by the action of microorganisms on the applied fertilizer and, if fertilizer is surface broadcast, a large proportion may be volatilized and lost as ammonia. For

urea in rice paddies, an extreme example, as much as 50% is volatilized and lost to the atmosphere. And what goes up must come down; in the case of fertilizer nitrogen, it returns to Earth in the rain, often acidic in nature. This uncontrolled deposition has unpredictable environmental effects, especially in pristine environments like forests, and may also affect biodiversity.

Some of these problems may be overcome by more efficient use of the applied fertilizer nitrogen. A tried and tested approach (that should be used more often) is to ensure that a balanced supply of nutrients (and not simply applying more and more) is applied at the right time (maybe in several separate applications) and in the correct place (under the soil surface and not broadcast). An entirely different approach that could slow the loss of fertilizer nitrogen is through the use of nitrification inhibitors, which would slow the rate of conversion of the applied ammonia into nitrate, and so decrease its loss through leaching. A third approach to ameliorating the problems outlined above is through the expanded use of biological nitrogen fixation. It's not likely that we shall soon have plants, which are capable of fixing N_2 without associated microbes, available for agricultural use. But the discovery of N_2 -fixing endophytes within the tissues of our major crops, like rice, maize, and sugarcane, and their obvious benefit to the crop, shows that real progress is being made. Moreover, with new techniques and experimental approaches, such as those provided by the advent of genomics, we have reasons to renew our belief that both bacteria and plants may be engineered to improve biological nitrogen fixation, possibly through developing new symbiotic systems involving the major cereal and tuber crops.

In the meantime, the major impact might be through agricultural sustainability involving the wider use of legumes, reintroduction of crop-rotation cycles, and incorporation of crop residues into the soil. But even these practices will have to be performed judiciously because, if legumes are used only as cover crops and are not used for grazing, their growth could impact the amount of cultivatable land available for food crops. Even so, the dietary preferences of developed countries (who eats beans when steak is available?) and current agricultural practices make it unlikely that the fixed-nitrogen input by rhizobia in agricultural soils will change much in the near-term future. A significant positive input could accrue, however, from matching rhizobial strains more judiciously with their host legumes and from introducing "new" legume species, particularly into currently marginal land. In the longer term, it may be possible to engineer crops in general, but cereals in particular, to use the applied fertilizer more efficiently. That would be a giant step the right direction. We shall have to wait and see what the ingenuity of mankind can do when "the chips are down" as they will be sometime in the future as food security becomes a priority for many nations. At the moment, there is no doubt that commercially synthesized fertilizer nitrogen will continue to provide the key component for the protein required by the next generation or two.

So, even as we continue the discussion about the benefits, drawbacks, and likely outcomes of each of these approaches, including our hopes and fears for the future, the time has arrived to close this effort to delineate what we know about nitrogen fixation and what we have achieved with that knowledge. It now remains

for me to thank personally all the authors for their interest and commitment to this project. Their efforts, massaged gently by the editorial team, have produced an indispensable reference work. The content is my responsibility and I apologize upfront for any omissions and oversights. Even so, I remain confident that these volumes will serve well the many scientists researching nitrogen fixation and related fields, students considering the nitrogen-fixation challenge, and administrators wanting to either become acquainted with or remain current in this field. I also acknowledge the many scientists who were not direct contributors to this series of books, but whose contributions to the field are documented in their pages. It would be remiss of me not to acknowledge also the patience and assistance of the several members of the Kluwer staff who have assisted me along the way. Since my initial dealings with Ad Plaizier, I have had the pleasure of working with Arno Flier, Jacco Flipsen, Frans van Dunne, Claire van Heukelom and Melanie van Overbeek; all of whom provided encouragement and good advice – and there were times when I needed both!

It took more years than I care to remember from the first planning discussions with Ad Plaizier to the completion of the first volumes in this series. Although the editorial team shared some fun times and a sense of achievement as volumes were completed, we also had our darker moments. Two members of our editorial team died during this period. Both Werner Klipp (1953-2002) and John Gallon (1944-2003) had been working on Volume II of the series, *Genetics and Regulation of Nitrogen-Fixing Bacteria*, and that volume is dedicated to their memory. Other major contributors to the field were also lost in this time period: Barbara Burgess, whose influence reached beyond the nitrogenase arena into the field of iron-sulfur cluster biochemistry; Johanna Döbereiner, who was the discoverer and acknowledged leader in nitrogen-fixing associations with grasses; Lu Jiaxi, whose “string bag” model of the FeMo-cofactor prosthetic group of Mo-nitrogenase might well describe its mode of action; Nikolai L’vov, who was involved with the early studies of molybdenum-containing cofactors; Dick Miller, whose work produced new insights into MgATP binding to nitrogenase; Richard Pau, who influenced our understanding of alternative nitrogenases and how molybdenum is taken up and transported; and Dieter Sellmann, who was a synthetic inorganic chemist with a deep interest in how N₂ is activated on metal sites. I hope these volumes will in some way help both preserve their scientific contributions and reflect their enthusiasm for science. I remember them all fondly.

Only the reactions and interest of you, the reader, will determine if we have been successful in capturing the essence and excitement of the many sterling achievements and exciting discoveries in the research and application efforts of our predecessors and current colleagues over the past 150 years or so. I sincerely hope you enjoy reading these volumes as much as I’ve enjoyed producing them.

William E. Newton
Blacksburg, February 2004

PREFACE

Leguminous Nitrogen-Fixing Symbioses

Our first task is to thank all those who assembled the various chapters in this, the final volume in the series on *Nitrogen Fixation: Origins, Applications and Research Progress*. We appreciate the enormous investment in time and effort they have made to produce the comprehensive coverage of the topics considered here, and we trust that the editorial process has been neither too lengthy nor too traumatic.

“It takes two to tango” is an adage with direct application to the process of N₂ fixation in legumes, where the machinery for a successful symbiosis is sophisticated and complex. It requires highly specific signals and responses from both partners in the symbiosis. But, although we now know very much more about how these signals and responses operate with a few legumes and their partners, we also have to recognise that the enormous variation in both the legume and its microsymbiont(s) may mean many more signals and responses to identify. Where in earlier times we had only to cope with a few genera with “rhizobium” somewhere in their names, we now have to accept many more that do not have that sobriquet and come from the β -proteobacteria. Those of us who have isolated bacteria from nodule squashes in the past and discarded anything that grew much faster than we expected must now wonder how many legume-nodulating bacteria we overlooked in the process. Peter Graham’s massive table of legume-nodulating bacterial genera and species in Chapter 2 emphasizes just how diverse these organisms are; he pleaded for a late revision so that he could cope with the steady flow of new genera!

Janet Sprent’s Chapter 1 reminds us that the legumes have an enormous diversity in being able to nodulate or not, in the route to nodulation, and in the eventual nodule type. Whether those legumes now unable to nodulate never found out how or somehow lost the capability are both interesting questions raised. How many times nodulation evolved is a difficult question to answer. Modern evidence at least lends support to a prejudice, which many of us have, that it happened certainly more than once and possibly quite frequently. More modern techniques for legume taxonomy appear to group legumes with similar nodulation modes and types much better than previously.

Legumes form nodules with a wide range of nodulating bacteria, some of which fix N₂ effectively and some of which do not. Kiers and colleagues (Chapter 3) suggest that the legume has developed ways to impose sanctions on the poor performers which may have implications for the proportion of the more effective strains to increase in the soil population and, thereby, lead to improved N₂ fixation. One hopes that the legumes’ sanctions are more effective than many political ones. Further, where “new” legumes are introduced into a particular environment with a highly effective inoculant strain, the trend is often towards the development of

increasing numbers of ineffective strains (see Chapter 12). One wonders whether natural environments containing legumes and nodulating bacteria move rather towards an equilibrium of effective and ineffective strains, which may vary with the legume species and the environment. Nodules on indigenous legumes in Australian soils, which presumably have had a long period where sanctions favoring effective strains could have been operative, very often appear largely ineffective. This is obviously a simplistic judgement which needs more rigorous investigation.

Understanding the behaviour of populations of nodule bacteria in soils in terms of composition and temporal change is fundamental to their successful introduction by inoculation. Graham discusses rhizobial ecology (in Chapter 2) with interesting analyses of the geographic distribution of organisms that infect beans and soybean and of the effects of edaphic factors on population composition. He also considers what functions nodule bacteria play in plant-soil systems apart from nodulating legumes.

Successfully inoculating legumes to produce N_2 -fixing crops and trees is a continuously-evolving technology in terms of inoculant isolation, field testing, manufacture, quality control, carriers, and methods of application. Herridge (in Chapter 4) analyses criteria for deciding when to inoculate and makes the point that the small cost of inoculation compared to crop failure without it is a potent argument for erring on the side of safety.

The complexity of the signal systems involved in nodulation grows ever greater (see Chapters 5, 6, 7 and 8). With variations in combinations of compounds produced by legumes, multiple Nod-factor structures, multiple *nod*-boxes and multiple NodD proteins, the possible permutations and combinations for control of nodulation have ballooned. The impact of Type III and Type IV protein secretion systems, which produce nodulation outer proteins, has also become important. And what about all the other plant flavonoid-activated genes in the nodule bacteria?

Analysis of what happens in the legume during rhizobial infection is concentrated in the two model legumes, *Medicago truncatula* and *Lotus japonicus*, with another focus on the economically-important *Glycine max*. Much has been learned about what Nod factors do to legume roots and root hairs and where they do it, as well as the roles of plant auxins and ethylene in the nodulation process. The mysterious role of polyploidy in infected-nodule cells now appears to be to drive symbiotic (infected) cell expansion and differentiation. Although we know much more about how these two model legumes nodulate *via* root hairs, we should not neglect crack and epidermal infection processes.

Plant genetics and genomics are playing important roles in deciphering the molecular mechanisms involved with nodule formation and function. It's intriguing that some of these plant genes are essential for both nodulation and arbuscular mycorrhizal (AM) infections, with the greater antiquity of the AM symbiosis suggesting that some have been re-used in the formation of nodule symbiosis. The availability of techniques and resources for rapid positional cloning in the model legumes will facilitate generation of mutants for detailed analysis of function.

Our knowledge of the physiology of the root-nodule bacteria has necessarily had to expand as more and more genera are recognised as able to nodulate legumes. Poole and his colleagues (Chapter 9) review central C and N metabolism in "classical" rhizobia, their use of unusual compounds produced by legumes, and

some important aspects of their micronutrient nutrition. Chemotaxis and quorum-sensing are other characteristics whose significance for nodulation have been recently established. Molecular explanations of some of the responses shown by rhizobia to osmotic, pH, or oxidative stresses have now become available.

All of this is, of course, about setting up N₂ fixation in the nodule bacteroids. Understanding carbon and nitrogen metabolism in nodules is about two basic questions (see Chapter 10). Where does the carbon come from and go to? How does the nitrogen get from the ammonia coming from nitrogenase into amino acids and ureides for export to the tops? Many of the biochemical pathways relevant to dicarboxylate supply to bacteroids are now much clearer, and the enzymology of N metabolism is much better documented. But the earlier belief that bacteroids excreted only ammonia to the plant is now being seriously questioned, with amino acids, like alanine, being proposed as fixed-N transporters.

In nodules, O₂ is paradoxically essential for the ATP generation required for N₂ fixation and potentially damaging to nitrogenase itself. Many of its reduction products – reactive oxygen species – may have deleterious effects on other systems, perhaps leading to nodule senescence. How legumes regulate O₂ access to the N₂-fixing regions of the nodule in response to environmental conditions is discussed in Chapter 11, along with a consideration of where those regulatory mechanisms operate in different nodule types. Plant and bacterial defences against damage from reactive oxygen and nitrogen species are also considered in detail.

The wider challenges, as Vance notes, are to understand “how the plant and bacteria integrate and regulate information into a coherent model that defines growth and development” and how “to use these insights and improve the well-being of humankind through food security and nutrition”.

In a final reality check (in Chapter 12), Howieson and colleagues discuss how current patterns of legume use developed, and what other uses (*e.g.*, pharmaceutical production) we might make of them in the future. Emphasising the huge variety of unstudied legumes, they pay particular attention to using perennial legumes for agriculture, and the difficulties in doing so. Appropriately, they close their chapter and the book saying “the continued exploitation of the enormous natural genetic variation available in both legumes and their microsymbionts will contribute to continued field application of biological nitrogen fixation which is undeniably one of the key biological processes on this planet.”

Michael J. Dilworth
Perth, W. Australia

Euan K. James
Dundee, Scotland, UK

Janet I. Sprent
Dundee, Scotland, UK

William E. Newton
Blacksburg, VA, USA

June 2007

LIST OF CONTRIBUTORS

Manuel BECANA

Estacion Experimental de Aula Dei,
Consejo Superior de Investigaciones
Cientificas, Apto 202, 50080
Zaragoza, SPAIN
Email: becana@eead.csis.es

R. Brown BESIER

Department of Agriculture and Food,
Western Australia, South Perth,
W. AUSTRALIA 6151
Email: bbesier@agric.wa.gov.au

Ton BISSELING

Laboratory of Molecular Biology,
Department of Plant Sciences,
Wageningen University and
Research Center, 6703 HA
Wageningen, THE NETHERLANDS
Email: ton.bisseling@wur.nl

William J. BROUGHTON

Laboratoire de Biologie Moléculaire
des Plantes Supérieures, Université
de Genève, Sciences III, 30 quai
Ernest-Ansermet, Genève,
SWITZERLAND
Email:
william.broughton@bioveg.unige.ch

R. Ford DENISON

Plant Sciences Department,
University of California at Davis,
Davis, CA 95616, USA
Email: rfdenison@ucdavis.edu

Michael J. DILWORTH

Centre for Rhizobium Studies,
Murdoch University, Murdoch,
W. AUSTRALIA 6150
Email: M.Dilworth@murdoch.edu.au

J. Allan DOWNIE

John Innes Centre, Colney Lane,
Norwich NR4 7UH, England, UK
Email: allan.downie@bbsrc.ac.uk

Kevin J. FOSTER

Department of Agriculture and Food,
Western Australia, South Perth,
W. AUSTRALIA 6151
Email: kfooster@agric.wa.gov.au

Peter H. GRAHAM

Department of Soil, Water, and
Climate, University of Minnesota,
St. Paul, MN 55108, USA
Email: graha019@umn.edu

David F. HERRIDGE

NSW Department of Primary
Industries, Tamworth Agricultural
Institute, 4 Marsden Park Road,
Calala, NSW, AUSTRALIA 2340
Email:
david.herridge@agric.nsw.gov.au

John G. HOWIESON

Centre for Rhizobium Studies,
Murdoch University, Murdoch,
W. AUSTRALIA 6150
Email: j.howieson@murdoch.edu.au

Michael F. HYNES
Biological Sciences, University of
Calgary, Calgary T2N 1N4,
CANADA
Email: hynes@ucalgary.ca

Euan K. JAMES
School of Life Sciences, University
of Dundee, Dundee DD1 5EH,
Scotland, UK
Email: e.k.james@dundee.ac.uk

Andrew W. B. JOHNSTON
School of Biological Sciences,
University of East Anglia, Norwich
NR4 7TJ, England, UK
Email: A.Johnston@uea.ac.uk

E. Toby KIERS
Faculteit der Aard en
Levenswetenschappen,
De Boelelaan 1085-1087, Vrije
Universiteit Amsterdam, 1081 HV
Amsterdam, THE NETHERLANDS
Email: ekiers@falw.vu.nl

Hajime KOBAYASHI
Building 68-659, Massachusetts
Institute of Technology,
77 Massachusetts Ave,
Cambridge, MA 02139, USA
Email: hkobayas@MIT.EDU

Adam KONDOROSI
Institute des Sciences du Végétal,
Centre National de la Recherche
Scientifique, 91198 Gif-sur-Yvette,
FRANCE
Email: Adam.Kondorosi@isv.cnrs-
gif.fr

Eva KONDOROSI
Institute des Sciences du Végétal,
Centre National de la Recherche
Scientifique, 91198 Gif-sur-Yvette,
FRANCE
Email: Eva.Kondorosi@isv.cnrs-
gif.fr

Nicolas MAUNOURY
Institute des Sciences du Végétal,
Centre National de la Recherche
Scientifique, 91198 Gif-sur-Yvette,
FRANCE
Email: Nicolas.Maunory@isv.cnrs-
gif.fr

Peter MERGAERT
Institute des Sciences du Végétal,
Centre National de la Recherche
Scientifique, 91198 Gif-sur-Yvette,
FRANCE
Email: Peter.Mergaert@isv.cnrs-
gif.fr

Frank R. MINCHIN
Institute for Grassland and
Environmental Research,
Aberystwyth SY23 3EB, Wales, UK
Email: frank@minchinf.fsnet.co.uk

William E. NEWTON
Department of Biochemistry,
Virginia Polytechnic Institute and
State University,
Blacksburg, VA 24061, USA
Email: wenewton@vt.edu

Philip S. POOLE
School of Biological Sciences,
University of Reading, Reading
RG6 6AJ, England, UK
Email: p.s.poole@reading.ac.uk

Daniel REAL

Co-operative Research Centre for
Plant-Based Management of
Dryland Salinity, University of
Western Australia, Nedlands,
W. AUSTRALIA 6151
Email: dreal@cyllene.uwa.edu.au

Wayne G. REEVE

School of Biological Sciences and
Biotechnology, Murdoch University,
Murdoch, W. AUSTRALIA 6150
Email: W.Reeve@murdoch.edu.au

Leif SCHAUSER

Bioinformatics Research Center,
Høegh-Guldbergs Gade 10, Building
1090, DK-8000 Aarhus C,
DENMARK
Email: schauser@birc.au.dk

Patrick SMIT

Laboratory of Molecular Biology,
Department of Plant Sciences,
Wageningen University and
Research Center, 6703 HA
Wageningen, THE NETHERLANDS
Email: Patrick.Smit@wur.nl

Janet I. SPRENT

32 Birkhill Avenue, Wormit,
Fife DD6 8PW, Scotland, UK
Email: JISprent@aol.com

Jens STOUGAARD

Department of Molecular Biology,
University of Aarhus, Gustav Wieds
Vej 10, DK-8000 Aarhus C,
DENMARK
Email: stougaard@mb.au.dk

Satoshi TABATA

Kazusa DNA Research Institute,
1532-3 Yana, Kisarazu, Chiba 292,
JAPAN
Email: tabata@kazusa.or.jp

Ravi P. TIWARI

School of Biological Sciences and
Biotechnology, Murdoch University,
Murdoch, W. AUSTRALIA 6150
Email: R.Tiwari@murdoch.edu.au

Michael UDVARDI

Molecular Plant Nutrition Group,
Max Planck Institute of Molecular
Plant Physiology, Am Mühlenberg 1,
D-14476 Golm, GERMANY
Email: udvardi@mpimp-
golm.mpg.de

Carroll P. VANCE

USDA Agricultural Research
Service, 411 Borlaug Hall, 1991
Upper Buford Circle, St. Paul,
MN 55108, USA
Email: vance004@umn.edu

Stuart A. WEST

Institute of Cell, Animal and
Population Biology, University of
Edinburgh, Edinburgh EH9 3JT,
Scotland, UK
Email: Stu.West@ed.ac.uk

Ron J. YATES

Department of Agriculture and Food,
Western Australia, South Perth,
W. AUSTRALIA 6151
Email: ryates@agric.wa.gov.au

Chapter 1

EVOLUTION AND DIVERSITY OF LEGUME SYMBIOSIS

J. I. SPRENT

32 Birkhill Avenue, Wormit,
Fife DD6 8PW, Scotland, UK.

1. INTRODUCTION

The potential for nodulation in extant plants appears to be confined to a branch of angiosperms known as the Rosid I clade (Soltis *et al.*, 2000). All legumes are found in one branch of this clade (Figure 1). However, it is becoming increasingly evident that the genetic basis of nodulation in legumes (and probably actinorhizal plants too; see Volume 6, *Nitrogen-fixing Actinorhizal Symbioses* of this series) has been acquired following duplication and modification of older genetic elements, some of which date back to the origin of land plants and even earlier. Before tracing some of these elements, a brief description of different types of extant nodule will be given, followed by an historical consideration of events necessary before legumes evolved and nodulation became a possibility. This discussion leads to a consideration of nodulation and non-nodulation in the three subfamilies of legumes and how and when nodules may have evolved. Throughout, the emphasis will be on the plant partner of this symbiosis.

2. THE DIVERSITY OF LEGUME NODULES

2.1. *The Rosid I Clade and the Leguminosae*

In their detailed analysis of angiosperm phylogeny, Soltis *et al.* (2000) discussed a large clade, Eurosid I, with three subclades; one, the N₂-fixing clade, contains all of the known genera that nodulate either with the filamentous bacterial genus *Frankia*

(the actinorhizal plants, see Pawlowski and Sprent, 2007) or with rhizobia (Figure 1). The N_2 -fixing clade comprises four orders and numerous families, of which the Leguminosae is by far the largest and which is sister to a group including the genus *Polygala* that has no known nodulating members.

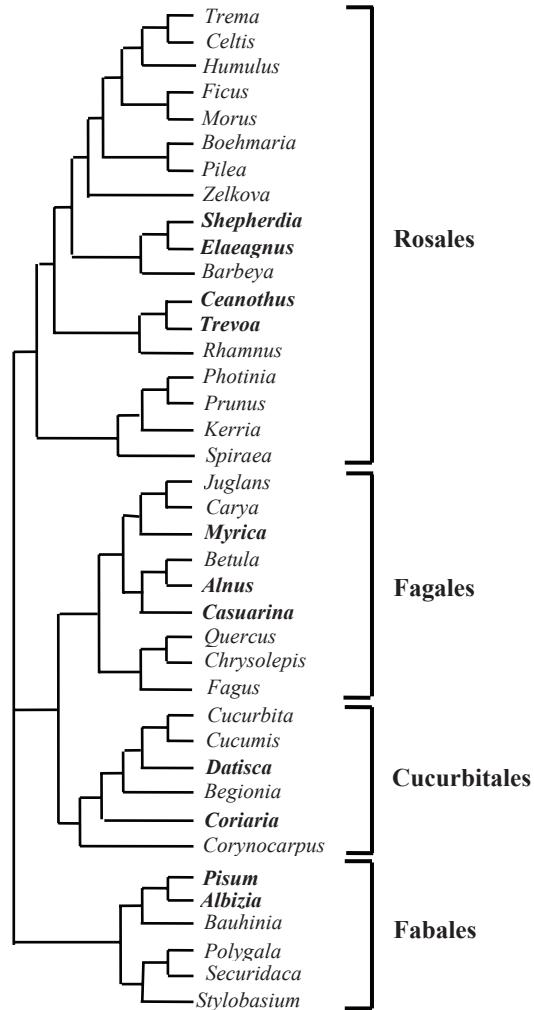

Figure 1. The nitrogen-fixing part of the Rosid I clade.
Nitrogen-fixing genera are shown in bold.
After Soltis et al., 2000. Copyright reserved by JIS.

The actinorhizal plants are scattered among the remaining three orders (genera in bold type). Note that closely related genera, such as *Alnus* and *Betula*, may be nodulated and non-nodulated, respectively. *Trema*, a genus at the top of this clade,

is very closely related to *Parasponia*, the only non-legume known to nodulate with rhizobia (indeed, it was originally identified as *Trema*). However, *Parasponia* nodules are structurally similar to actinorhizal nodules in that they have central vascular tissue and peripheral infected tissue. Cells of the latter retain their rhizobia within fixation threads, as found in some primitive legume nodules (Sprent and Sprent, 1990, see also section 3.5.). A detailed comparison of legume and actinorhizal nodules can be found in Pawlowski and Sprent (2007).

Both plant and rhizobial taxonomists are expert at disagreeing about what to call their pet organisms/families. Thus, the legume family is called Fabaceae by some (mainly in the USA and Australia) and Leguminosae by others. Yet others still retain a division into three families - Caesalpiaceae, Mimosaceae and Papilionaceae, but the vast amount of molecular evidence accumulated in the last fifteen years or so makes this three-family division untenable. Lewis and Schrire (2003) put forward grounds for using Leguminosae rather than Fabaceae, a practice followed in the monumental new volume *Legumes of the World* (Lewis *et al.*, 2005) and in this chapter.

2.2. Types of Legume Nodule and Nodulation Processes

Figure 2 illustrates the main morphological types of legume nodule and their internal structure and Table 1 gives brief descriptions of the major types. Details of infection and development of some of the types of nodule can be found in chapters by Kobayashi and Broughton (Chapter 5), by Maunory *et al.* (Chapter 6) and by Smit and Bisseling (Chapter 7).

3. THE FIRST 700 MILLION YEARS

3.1. Early Land Plants: Evolution of Signals, Mycorrhizas, and Hemoglobin

Exactly when plants colonised land is not clear, but it has been suggested that green algae and fungi may have done this about 1,000Ma bp (1,000 million years before present). This may have allowed the formation of the first symbiosis with green plants, lichens (Heckman *et al.*, 2001). If fungi were present from the first, the scene was set for the development of mycorrhizas. It is generally agreed that arbuscular mycorrhizas (AM) were important in helping the evolving orders of terrestrial plants obtain nutrients from a rather inhospitable 'soil' and indeed fossil evidence for them dates back to at least 400Ma bp (Remy *et al.*, 1994). These early mycorrhizas were not associated with roots (which had not yet evolved) and were formed on above- as well as below-ground axes (Nicolson, 1975). In order to establish mycorrhizas, a signalling system evolved in which the fungus and the plant could recognise suitable partners. The plant genes needed for this signalling appear to have been highly conserved and in some cases also used in nodulation processes (Szczyglowski and Amyot, 2003). Their modes of action are considered in Chapters 4-6 of this volume. Recent work has shown that some of the steps used in mycorrhizal colonization are also used by colonizing rhizobacteria, such as

Pseudomonas fluorescens (Sanchez *et al.*, 2004). In this case (the host plant was *Medicago truncatula*), there was more commonality between rhizobacterial and AM colonization than between rhizobacterial and nodulation signals.

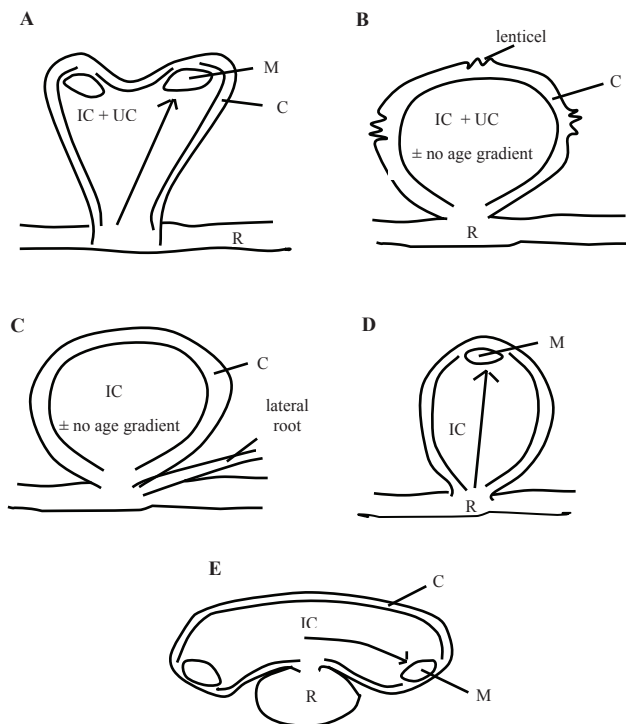

Figure 2. Major types of nodule shape and structure.

A: indeterminate nodule as found in all three sub-families, with one or more apical meristem(s) (M), infected tissue with a mixture of infected (IC) and uninfected (UC) cells (the arrow indicates an age gradient with the head pointing to the youngest cells), nodule cortex (C), subtending root (R).

B: desmodioid nodule with lentils on the outside and infected tissue of uniform age.

C: aeshynomenoid nodule.

D: indeterminate nodule, superficially like that of A, but with uniformly infected tissue in the centre; this type may be common in tribe Genisteeae.

E: lupinoid nodule.

In other cases, rather than single genes being conserved, there has apparently been gene duplication plus divergence of the structure and function of products of these duplicated genes. One of the earliest such cases is the superfamily of hemoglobin molecules. Hemoglobins are of ancient origin with one family, the truncated hemoglobins, being found in a wide variety of bacteria, plants and protozoa, but not metazoa or archaea (Wittenberg *et al.*, 2002).

Table 1. Types of nodule and their main features (modified from Sprent, 2000).

Category	Features
<i>Aeschynomenoid</i>	Determinate growth, oblate form Associated with lateral or (for stem nodules) adventitious roots Infection via cracks where roots emerge Central infected tissue with few or no uninfected cells Found in legumes of the dalbergia clade Nodules on <i>Sesbania</i> are a flexible variant of this type
<i>Desmodioid</i>	Determinate growth, usually more-or-less spherical Surface with distinct lenticels Infection usually via root hairs Central infected tissue interspersed with uninfected cells
ureide-exporting	Found in tribes Desmodieae, Phaseoleae and Psoraleae
amide-exporting	Found in former tribe Loteae (<i>i.e.</i> , excluding Coronilleae)
<i>Indeterminate</i>	Nodules with apical meristems, often branched may be perennial and woody and with suberised cortex Usually infected via root hairs, but occasionally with crack infection (<i>e.g.</i> , the mimosoid genus <i>Neptunia</i>) or direct epidermal infection (<i>e.g.</i> , <i>Mimosa scabrella</i>) Found in all mimosoid and most papilionoid legumes, with a variant in some members of Genisteae
<i>Lupinoid</i>	Nodules with lateral meristems girdling the subtending root. Infection not usually involving root hairs Infected cells in lobes that lack uninfected cells Only known for the genus <i>Lupinus</i> , but some features also found in related genera from tribe Genisteae
<i>Primitive</i>	Bacteroids are retained within fixation threads Always indeterminate, may have sclereids on the surface Found in all caesalpinoid legume genera, in some genera of papilionoid legumes, but not known in mimosoid legumes

The ancestral gene(s) for other hemoglobins appear to have separated into plant and animal forms long before vascular plants evolved (Hardison, 1996). At about this time (possibly 1500Ma bp), a nematode form of hemoglobin evolved and has remained separate from other animal hemoglobins to the present time. This is interesting in view of similarities between nodule and nematode gall formation as discussed in section 3.2. Extant plants may have one or both of two families of

hemoglobin, usually referred to as symbiotic and non-symbiotic forms, which may have been ancestral to the separation of monocots from eudicots (Guldner *et al.*, 2004). Even so, monocots and eudicots, which probably separated about 150Ma bp, have different forms of the non-symbiotic hemoglobins (Hardison, 1996). However, data are only available from a few species in each group and since a major branch of dicots appears to have separated from the angiosperm lineage before monocots (Soltis *et al.*, 2000), more data are needed. Nodulated plants, both legume and non-legume, contain one or more type(s) from each family. All bind O₂ to a greater or lesser extent, enabling their use for various purposes, including detoxification and O₂ transport. In many cases, they are induced by hypoxic conditions and may have evolved in flooded underground organs when plants first colonised land. A recent suggestion is that, together with nitrate and NO, plant hemoglobins may provide an alternative to fermentation in enabling plant cells to avoid anoxic stress (Igamberdiev and Hill, 2004). They may also have a role in arbuscule-containing cells of legume and non-legume mycorrhizas (Vieweg *et al.*, 2004), although the control of the promoter systems is different in mycorrhizas and nodules (Fehlberg *et al.*, 2005), suggesting an ancient physiological role in symbiosis. However, this could not have been associated with N₂ fixation. On the other hand, recent work with nodules has demonstrated a close link between some forms of leghemoglobin and N₂ fixation, different forms being produced sequentially and coupled to the induction of genes necessary for N₂ fixation (Downie, 2005; Ott *et al.*, 2005).

Another set of genes of ancient origin and important function are those encoding apyrases, which are important in controlling such vital functions as ATP:ADP ratios and signalling molecules. They have been implicated in a number of nodulation (and AM) processes (see Chapters 6 and 7). It appears likely that gene duplication and speciation at about the time of legume evolution may have resulted in some forms of apyrase genes being recruited for nodulation functions (Cannon *et al.*, 2003). There are other examples of duplicated genes and even whole genomes in legumes, some of which are discussed in Chapters 6 and 8.

3.2. Organised Roots and Root Outgrowths, Hormonal Control

One of the prerequisites for the formation of nodules and other outgrowths of roots, such as ectomycorrhizas (ECM) and nematode galls, is the ability to produce meristems. Nutman (1948) proposed that nodules are only produced near sites where lateral roots are initiated. Recent studies with the model legume *Medicago truncatula* have shown that a gene *LATD* (lateral root organ defective) is required for both lateral root and nodule development (Bright *et al.*, 2005). The ability to regulate differentiation using microRNAs appears to have been highly conserved in land plants, probably dating back over 400Ma bp (Floyd and Bowman, 2004). In their comprehensive review of the evolution and significance of roots, Raven and Edwards (2001) discuss the evidence that roots may have evolved more than once, pointing out that the unique root structure, the root cap, would also need to have evolved more than once. The main function of the root cap is to facilitate prolonged

growth through soil, a function less critical for root outgrowths, such as ectomycorrhizas and nodules, which have more limited growth (although both legume and actinorhizal nodules may grow to over 10 cm in length, often with multiple branches). Unfortunately, root caps (and indeed roots generally) do not readily fossilize, but there is evidence that roots may have evolved about 400Ma bp (Raven and Edwards, 2001). For this to have occurred, the pathways for production of the major plant hormones, in particular auxins, cytokinins and ethylene, must also have been present. Indeed, in view of the widespread production of plant hormones by extant bacteria and fungi, they may have evolved much earlier.

Compared with AM, the evolution of ectomycorrhizas (ECM) has been less well studied and few comparisons made between nodules and ECM, although the two are morphologically much more similar than either is to AM. An exception (Pawlowski and Sprent, 2005) is where AM fungi lead to the formation of myconodules. ECM are much less common than AM, are most commonly found in woody plants, and are often considered to be largely confined to temperate regions. However, many important tropical legumes, but few of temperate regions, have ECM. Fitter and Moyersoer (1996) suggested that ECM evolved twice, once in a gymnosperm lineage and once in angiosperms, but exactly when is not clear. Marmeisse *et al.* (2004) go further in suggesting several independent origins of ECM. Based on a study of Asian dipterocarps and their Madagascan relatives (the Sarcocaulaceae), Ducouso *et al.* (2004) concluded that ECM in these families were present at least 88Ma bp.

Nematodes can be important plant parasites and infection of roots by many of them leads to the production of galls. There are several parallels between the formation of lateral roots, nematode galls, and nodulation, such as the use of auxins and flavonoids (Mathesius, 2003). Genes, such as *ccs52*, which control endoreduplication in at least some nodule infected cells (see Chapter 6), are active in producing the giant cells in galls from which the nematodes get their nourishment (reviewed by Mathesius, 2003). A more surprising, recent result is that *nodL*, a gene coding for an *N*-acetyltransferase previously thought to be confined to rhizobia, occurs in some nematodes, where it has apparently been acquired by horizontal gene transfer *via* a nematode-inhabiting bacterium (Bird *et al.*, 2003). When this occurred in evolutionary terms is not clear, but it suggests that signal interchange may be similar between plants and parasites or symbionts. Further, it shows that animals as well as plants can acquire bacterial DNA (for example, from *Agrobacterium*).

Although legume nodules have many shoot-like characters, such as a peripheral vascular system, Gualtieri and Bisseling (2000) draw interesting parallels between their development and that of the essentially root-like actinorhizal nodule. Sprent (2001) developed these ideas, noting papers from the older literature showing roots growing out of legume nodules. Unfortunately, most modern work on nodule structure and development uses very young plants and sterile conditions rather than the real world.

One of the many adjustments plants had to make to successfully colonise dry land was to overcome the need for water for the transfer of male to female gametes. This change, which may have occurred about 380Ma ago and is first noted in

gymnosperms, led to the formation of pollen tubes to conduct male gametes to ovules. Pollen tubes develop by tip growth similarly to the growth of an infection thread down a legume (or actinorhizal) root hair. Evidence now suggests that at least some components of the genetic control of these two processes are similar and may have resulted from past gene duplication (Rodriguez-Llorente *et al.*, 2004).

3.3. Separation of Monocots and Dicots and C_4 Plants

Until recently, the separation of monocots and dicots was seen as possibly the most fundamental split in the evolution of angiosperms. However, molecular evidence now clearly shows that some dicots separated from the main angiosperm line before the formation of the monocot lineage (Soltis *et al.*, 2000). Nodulation has only been found in one clade (see Figure 1 and section 2.5.) of the lineage known as the eudicots. It may be significant that monocots are not readily infected by *Agrobacterium*, a genus so closely related to some rhizobia that its inclusion in *Rhizobium* has been suggested. Many *Agrobacterium*-infected plants produce galls, often where a plant is damaged. It is tempting to suggest that the so-called ‘crack’ infection of legumes by rhizobia is similar and is the primitive state, a point that will be discussed later.

Recent molecular evidence, coupled with fossil evidence, suggests that legumes evolved about 60Ma bp, with all three sub-families being established within 5-10Ma (Lavin *et al.*, 2005). Concomitant with the legume diversification, atmospheric carbon dioxide levels were initially high (1000–1500 ppm or more) but beginning to fall, so that by about 25Ma bp, they were close to those found today (Pagani *et al.*, 2005). Falling carbon dioxide levels have been suggested as a factor in the evolution of C_4 photosynthesis (Sage, 2004). However, this metabolic pathway has evolved many times, in many monocot and dicot families, and over many years. Most such families, and even some genera, have a mixture of C_4 and C_3 species. Although generally associated with dry and/or saline environments, some C_4 plants are found in wetlands. Sage (2004) suggests that the best way of considering C_4 plants is that they have adapted to cope with high rates of photorespiration and carbon deficiency rather than drought or salinity. The fact remains that many C_3 plants flourish in dry, wet, and saline environments and these include a number of nodulated species, both legume and actinorhizal. There is no evidence of a nodulated plant that is also C_4 , although legumes in particular were actively evolving at the same time and probably in the same locations as C_4 plants. Clearly, many tropical pasture legumes are today found in association with C_4 grasses, such as species of *Paspalum*.

4. THE LAST 60 MILLION YEARS

4.1. Legume Fossils and Molecular Evolution Data

Examining the fossil record for signs of legume nodule evolution has proved frustrating, not least because nodules, like roots, do not feature in the fossil record.

Sprent (2001) attempted to correlate fossils similar to extant legume genera and their nodulation status. In all three subfamilies, there was evidence that both nodulated and non-nodulated genera may have been present. More recently, Lavin *et al.* (2005) have extensively analysed molecular data in the context of legume diversification, rooting these data by reference to well-established fossil specimens. This, and other recent studies referenced in Lewis *et al.* (2005), cast doubt on the widely held view that Caesalpinioideae is ancestral to the other subfamilies. The following discussion examines the current occurrence of nodulation against the evidence for the time of evolution of the three subfamilies proposed by Lavin *et al.* (2005).

4.2. *Caesalpinioideae*

Of the 171 genera (about 2250 species), nodulation is only fully confirmed for eight (*Campsiandra*, *Chamaecrista*, *Dimorphandra*, *Erythrophleum*, *Melanoxydon*, *Moldenhauwera*, *Sclerolobium* and *Tachigali*), although there are unconfirmed reports for some others and many have not been examined (Sprent, 2001). All nodules in Caesalpinioideae are indeterminate and often branched (see Figure 2).

Of the nodulating genera, only one (*Chamaecrista*) is included in the analysis of Lavin *et al.* (2005), but this genus has about 330 species and is the eighth largest in the whole family (Lewis *et al.*, 2005). It is pantropical in distribution with some herbaceous species extending into temperate USA. In addition to herbs, the genus has shrubs of various sizes and quite large trees. Its nodules are unique within the subfamily, in that their infected cells may have bacteroids retained within fixation threads (as in all other caesalpinoid and a few papilionoid nodules) or released into symbiosomes (as in all mimosoid and most papilionoid nodules) (Naisbitt *et al.*, 1992; Sprent, 2001). It therefore appears to be a key genus. Taxonomically, it has been included in tribe Cassieae, but this is likely to change as new molecular evidence becomes available. Lewis (2005a) places it, together with *Cassia* and *Senna* (non-nodulating but formerly congeneric with *Chamaecrista*), between two parts of tribe Caesalpinieae and quite separate from other caesalpinoid tribes. As all of the other known nodulating caesalpinoid genera are in tribe Caesalpinieae (Sprent, 2001), this placement seems entirely appropriate from a nodulation viewpoint, although it must be noted that there are 49 genera in the tribe that probably cannot nodulate. With the exception of *Erythrophleum*, which is found in Africa, parts of Asia and Northern Australia, and *Chamaecrista*, all nodulated species are from South America. Caesalpinoid tribes Cercideae and Detarieae have no known nodulating genera and will not be considered here. More descriptions of the nodulated tree genera of all three subfamilies can be found in Sprent (2005).

4.3. *Mimosoideae*

Seventy eight genera (3270 species) are currently recognised in this subfamily and it includes the second and fifth most speciose genera (*Acacia* and *Mimosa*, respectively). Although nodulation is much more common than in

Ceasalpinioideae, distinct groups appear unable to nodulate. The sub-family is currently divided into four tribes: Mimoseae, Ingeae, Mimozygantheae and Acacieae. In this tribal division, the former tribe Parkieae is placed in the Mimoseae, but the generic content of this combined tribe is likely to change (Luckow, 2005). All (at least 9) mimosoid genera (as opposed to species, see later) that appear unable to nodulate are in tribe Mimoseae (Sprent, 2001). The question arises as to whether they have never nodulated or whether they have had this ability and then lost it; both seem possible. Many of the non-nodulating genera are considered basal within the subfamily (Luckow, 2005), but molecular analysis (Lavin *et al.*, 2005) includes insufficient of these genera to permit further speculation. *Pentaclethra* is interesting in that one of its two species (*macrophylla*, from Africa) does not nodulate, whereas the other (*macroloba* from tropical America) does. This unusual situation (only 3 legume genera have both nodulating and non-nodulating species) likely results from a loss of nodulating ability.

Fortunato (2005), in considering the monogeneric tribe Mimozygantheae, notes that this nodulating genus may soon be included in Mimoseae.

Tribe Acacieae (Lewis, 2005b) is also in a state of flux. The monotypic genus *Faidherbia albida* (formerly *Acacia albida*) has been transferred to tribe Ingeae, leaving only *Acacia* in this tribe. However, it is clear that *Acacia* is not a single genus, but defining how many genera it should be split into and what these should be called has been a matter of much discussion and some acrimony. For convenience, most workers are currently using three subgenera, *Acacia*, *Aculeiferum* and *Phyllodineae*, but with the recognition that *Aculeiferum* is likely to be further subdivided. Following the International Botanical Congress in Vienna (7/2005), a vote was taken as to whether the subgenus *Acacia* should retain this name (as would be normal taxonomic practice) or whether the predominantly Australian *Phyllodineae* should bear this name. The vote was very close, with the Australians just winning. Thus, the *Phyllodineae* should now be called *Acacia* and be placed within tribe Ingeae. The former subgenus *Acacia* becomes *Vachellia* and *Aculeiferum* becomes *Senegalia*. The latter is known not to be monophyletic and is likely to be divided into two genera in the future, one of which may be called *Acaciella* (Lewis, 2005b; see also Maslin, 2005). These genera comprise tribe Acacieae. Although the tribal affinities are generally accepted, I suspect that it will be some time before the new generic names will be widely adopted, especially by those who regard *Acacia* as an archetypal African genus.

Are any of these taxonomic niceties relevant to nodulation and N₂ fixation? Definitely! *Acacia* (*Vachellia*) and *Phyllodineae* (*Acacia*) have no known non-nodulating species, but they do differ in that, whereas all have AM, many *Phyllodineae* also have ectomycorrhizas (ECT), which may make them especially suited to colonization of harsh environments, such as mine spoils (Sprent, 2001; Sprent and Parsons, 2000). On the other hand, at least 16 species in *Aculeiferum* are unable to nodulate, probably because they have lost this ability (Sprent, 2001).

It is possible that all genera in tribe Ingeae can nodulate, with the probable exception of *Zapoteca*, although there are no reports for several (Sprent, 2001).

Nodules in the Mimosoideae are remarkably uniform in structure - indeterminate, often branched, with the central region containing both infected and

uninfected cells and often with a suberised cortex that may help protect against desiccation (Sprent, 2001). Their rhizobia, on the other hand, vary greatly and include β -rhizobia of the genera *Cupriavidus* (synonyms *Ralstonia*, *Wautersia*) and *Burkholderia*, both of which nodulate species of *Mimosa* (Chen *et al.*, 2003; 2005), *Abarema*, and *Pithecellobium* (both tribe Ingeae; Barrett and Parker, 2005).

4.4. Papilionoideae

At present, this subfamily has 764 genera and 13,800 species, divided into 28 tribes by Lewis *et al.* (2005). As with the other subfamilies, there are likely to be changes in the tribal affiliations in the next few years. Only a few tribes will be considered here, where they have particular relevance to nodulation. They are cited under the crown node terminology of Lavin *et al.* (2005), which assigns nodes that are the earliest likely ancestor of a group that later branches (Figure 3). As with Mimosoideae, there are a number of basal genera that appear unable to nodulate and also some that have probably lost this ability.

Tribe Swartzieae has had a chequered career, both in terms of number of genera within it and in its placement within subfamilies, having moved between Caesalpinioideae and Papilionoideae several times. Its current home in the Papilionoideae looks likely to be permanent, but its generic content subject to change.

Of the 17 genera included in the tribe by Ireland (2005), only four (*Ateleia*, *Bobgunnia*, *Cyathostegia* and *Swartzia*) are confirmed to be nodulating and most of the rest confirmed as non-nodulating. In the molecular analysis of Lavin *et al.* (2005), all the nodulating genera are in a branch of a clade whose node is estimated to be about 51Ma bp, separating it from the non-nodulating genera. This suggests that the latter have never been able to nodulate, and further that the former may represent one occasion when nodulation may have evolved.

Tribes Sophoreae (Pennington *et al.*, 2005) and Dipterygeae (Barham, 2005) have also been the subject of considerable revision, with the former still in a state of flux. Dipterygeae currently has three genera, none of which nodulates. Sophoreae has 45 genera (Pennington *et al.*, 2005) and, of these, 11 have definite reports of nodulation, 13 appear unable to nodulate, and the remaining 21 have no reports on their nodulation status (Sprent, 2001). Molecular analysis is not yet sufficiently comprehensive for detailed comments to be made on the relations between the non-nodulating genera in this tribe and those of the Swartzieae. However, nodulation may be a useful taxonomic criterion to include (Sprent, 2000), as has been shown (accidentally) for the division of the genus *Sophora* into two, *Sophora* (nodulating) and *Styphnolobium* (non-nodulating) (Sousa and Rudd, 1993).

With a very few exceptions, all the remaining genera of Papilionoideae are either known to be, or likely to be, nodulated. They will be considered in groups, largely as shown by the molecular analysis of Lavin *et al.* (2005), emphasising their nodule characters. For more detailed discussion of characters and affiliations (but not nodulation) of individual tribes, see Lewis *et al.* (2005) and, for nodulation details, see Sprent (2001). Note that, whereas Lewis *et al.* (2005) and Sprent (2001)

include all legume genera, Lavin *et al.* (2005) contains only those for which sufficient molecular evidence is available.

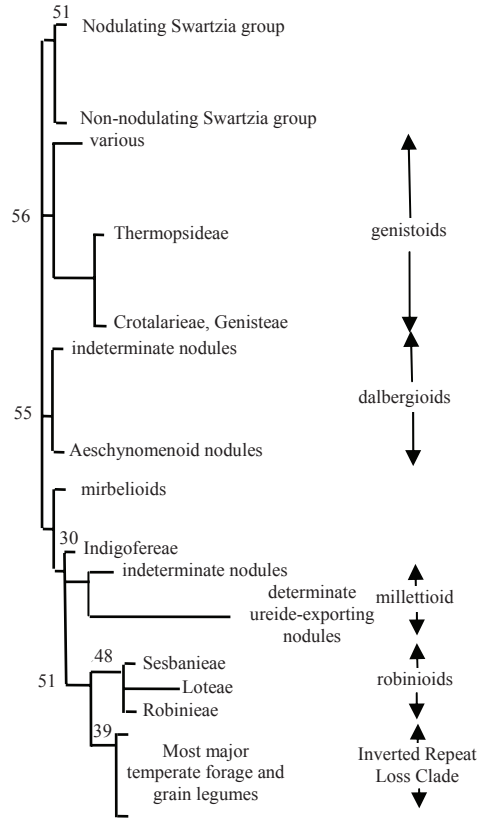

Figure 3. Outline of the major groups of papilionoid legumes. Figures indicate the possible times of their evolution as noted in the text. Lines do not indicate scale. Data taken from Lavin *et al.* (2005).

A genistoid crown node (so named because it includes tribe Genisteae) originated at about 56Ma bp, and within it are elements of a number of tribes. Almost all species are woody shrubs or trees. Although nodulation is widespread, nodule characters are heterogeneous. One subgroup, which includes the genus *Ormosia* from tribe Sophoreae, has typical indeterminate, often branched, nodules. Next to this is a smaller group of four genera, two of which (*Cyclolobium* and *Poecilanthé*) have nodules of the primitive type that retain bacteroids within fixation threads (Sprent, 2001). Interestingly, the next group of genera, which includes *Sophora* and *Thermopsis* (from tribes Sophoreae and Thermopsidae, respectively), have infected cells with some primitive features, but falling short of housing bacteroids within fixation threads (Sutherland *et al.*, 1994). A smaller

group includes a species of *Crotalaria*, a genus that was the first to be shown to have species nodulated by bacteria other than rhizobia, in this case, the α -proteobacterial genus *Methylobacterium* (Sy *et al.*, 2001). The final group consists of tribe Genisteeae, which has some unique nodule characters.

Lupinus has been long known to have 'collar' nodules of unusual morphology, with lateral meristems girdling the subtending root, although girdling is often incomplete except for the upper tap root (Corby, 1988). The infection process is usually intercellular, without the formation of infection threads, and the infected tissue contains large groups of infected cells without uninfected (interstitial) cells, but with groups separated by files of uninfected cells. Control of oxygen diffusion during N₂ fixation also varies from that of the widely studied species, such as soybean and clover (Iannetta *et al.*, 1995). In addition, *Lupinus* is the only known legume genus to be naturally amycorrhizal. Not in the analysis of Lavin *et al.* (2005), another genistoid legume, *Chamaecytisus proliferus*, also has some unusual features. Although infection threads are formed initially, these abort and nodulation follows from a crack-infection process (described below). Nodules have indeterminate morphology, but internal structure similar to that of lupin (Vega-Hernández *et al.*, 2001). We are currently looking at other genera in this group to see if these are common features.

Dating from about 55Ma bp, the dalbergioid crown node is particularly interesting from a nodulation point of view. It consists of a large number of genera, formerly in tribes Dalbergieae, Aeschynomeneae, and Adesmieae plus two genera from Desmodieae, which Corby (1988) noted had nodules atypical of the tribe. The new group was defined mainly on molecular characters, but including some classical morphological and other characters of which the most valuable was the aeschynomenoid type of nodule (Lavin *et al.*, 2001). This type of nodule was first described for groundnut (peanut; *Arachis hypogaea*) by Chandler (1978). Its characteristic features are: (a) infection through breaks where lateral roots (or adventitious roots in the case of certain spp of *Aeschynomene* that have stem nodules) emerge, commonly called 'crack infection'; (b) invasion without infection threads; (c) infected tissue uniform, without interstitial cells; and (d) determinate growth. The only known exceptions to this type of nodule in the dalbergioid group are in genera *Hymenolobium* and *Andira*, which on molecular grounds are separated from the rest of the group and which have bacteroids retained within fixation threads. A further two genera, *Nissolia* and *Chaetocalyx*, appear to have lost the ability to nodulate. Other anomalies are *Pterocarpus* (where African, Guyanian and Venezuelan species nodulate, but Brazilian ones do not) and possibly *Grazielodendron* (for which there are some negative reports on nodulation). *Inocarpus*, listed in Sprent (2001) as negative for nodulation, is now known to have typically aeschynomenoid nodules (R. Leakey, pers. comm.).

Slightly more recent (48Ma bp) is the rather smaller mirbelioid crown node, which contains the endemic Australian tribe Bossiaeeae and the Mirbelieae, which is also found in Papua New Guinea. From many points of view, this is a fascinating group. The main radiation of these two tribes took place (after Australia became an island about 32Ma bp) in the last 10Ma when Australia became increasingly more arid (Crisp *et al.*, 2004). Many of the soils in which they grow are very low in

nutrients, which may explain why, outside some species of *Acacia* (see above), members of these tribes are the only known legumes to be dual mycorrhizal (AM + ECT) with some also having cluster roots (Sprent, 1994). All appear to have indeterminate nodules. Soils similar to those of Western Australia, where many of these legumes grow, can be found in the Cape region of South Africa. It also has a group of endemic genera, in the endemic tribe Podalyrieae and the largely African tribe Crotalariaeae, both included in the genistoid crown node. Genera of interest include *Cyclopi*a (Podalyrieae) and *Aspalathus* (Crotalariaeae), both of which may have cluster roots as well as AM (Deschodt and Strijdom, 1976).

Tribe Indigofereae appears to have separated from other papilionoid groups at least 50Ma bp. Its type genus, *Indigofera*, is the third largest genus of legumes with a pantropical distribution and indeterminate, often branched, nodules.

The millettoid crown node is dated at 45Ma bp and is both large and complex, especially with respect to nodulation characters. It has two main parts, which again (unintentionally) divide along characters of nodule morphology, structure, and function. The older of these two parts comprises most of tribe Millettieae (formerly Tephrosieae). With the removal of *Poecilanth*e and *Cyclolobium* to the genistoid node, the remaining genera in the upper part of the millettoid node all have indeterminate nodules with, as far as is known, infected cells with bacteria in symbiosomes. However, Schrire (2005) retains *Dahlstedtia* in the core group and this genus has bacteroids retained in infection threads. The more recent part of the millettoid node contains tribes Desmodieae, Phaseoleae and Psoraleae. The first of these is now often included in Phaseoleae. Members of all three tribes typically have determinate nodules, with central tissue containing a mixture of infected and interstitial cells (Figure 2) and, where tested, the typical products exported from N₂ fixation in nodules are ureides rather than amides. There are occasional reports of genera with two types of nodule (Corby, 1988), e.g., *Cajanus* and *Kennedy*a. Sprent (2001) suggested that determinate nodules may under some conditions resume growth and become branched, but the subject of genera with dimorphic nodules needs to be re-examined. The tribe Phaseoleae contains many important crop plants, such as soybean, beans, and cowpeas.

A very large crown node (hologalegina) dating from about 51Ma bp is divided into two main parts, the robinoid crown node (48Ma bp) and the IRLC crown node (39Ma bp). Both have some distinctive nodule attributes. In the robinoid node, there are three interesting areas. The first includes species of *Sesbania*, now put in its own tribe, Sesbanieae, rather than being part of Robinieae (Lavin and Schrire, 2005). The species *Sesbania rostrata* has been intensively studied because of its various unique nodule characters. It nodulates on both stems and roots and its nodule morphology varies between more-or-less aescynomenoid with crack infection to indeterminate with root-hair infection, depending on growth conditions, particularly flooding. Comparing the two types of invasion process showed that root-hair infection had more stringent conditions than crack infection (Goormachtig *et al.*, 2004). Stem nodules, which are not found on other species of the genus, may be photosynthetic and are initiated by *Azorhizobium caulinodans*, a species that can grow *ex planta* on N₂ as sole nitrogen source. Sister to tribe Sesbanieae is tribe Loteae, which now includes former tribe Coronilleae. Loteae is the sole example of

molecular data being at odds with nodule data, which separates Loteae from Coronilleae. Genera in the former tribe Coronilleae have typically indeterminate nodules, whereas nodules in Loteae are classically determinate in morphology and structure. *Lotus japonicus* is one of the model legumes currently under intensive study (see Chapters 7 and 8). Externally, nodules on *Lotus* look exactly like those of soybean or other members of the Phaseoleae, but are functionally different in exporting amides rather than ureides (Sprent and Sprent, 1990). The remainder of the robinoid node is made up of tribe Robineae, which largely consists of temperate and sub-tropical tree genera with indeterminate nodules (Sprent, 2005).

The IRLC (inverted repeat lacking clade) (39Ma bp) lacks the inverted part of the chloroplast genome that characterises much of the Papilionoideae. It contains many economically important tribes, such as Trifolieae, Fabeae (formerly Vicieae) and part of the tribe Millettieae, as well as the largest of all legume genera, *Astragalus*. Nodules are indeterminate. Many of the genera have been intensively studied (e.g., *Pisum sativum*, various *Trifolium* spp. and the model legume *M. truncatula*). Nodulation in these and other genera is detailed in other chapters.

4.5. Which Type of Nodule is Primitive?

The type of nodule is often characteristic of certain groups of legumes. Indeed, it has been used as a taxonomic character since the pioneering work of Corby (1981; 1988), whose studies were based on morphological features. This work was continued by Sprent and colleagues, who also took account of microscopic structure and functional features, such as the nature of export products (summarised in Sprent, 2000). Both groups have considered which of the various nodule types might be primitive. Sprent *et al.* (1989) suggested that situations, where infection occurs either between epidermal cells or *via* cracks where roots emerge, might be more primitive than a root-hair infection pathway, especially if (as in aeshynomenoid nodules) infection threads are never found. The complex processes involved in root-hair infection and infection-thread development (see Chapters 5, 6 and 7) would then be bypassed. However, the infection processes are now known to be more flexible than once thought. For example, species of *Neptunia* may have a crack infection when grown under waterlogged conditions and a root-hair infection when grown under drained conditions (James *et al.*, 1992; 1994). This is the only known case where crack infection is followed by infection-thread formation. In *Sesbania rostrata* (described above), flooding affects both nodule form and infection process. A possible advantage of crack infection is that it can occur anywhere on a root system where lateral roots emerge, including quite old woody roots (Figure 2).

Corby (1981) considered indeterminate nodules to be primitive and both aeshynomenoid and desmodioid types to be derived. His argument was based on the smaller size and determinate growth of these two types and also that it fitted with the then recognised relationships between the various tribes of Papilionoideae (Polhill, 1981). Sprent *et al.* (1989), who were only considering woody legumes, agreed with this suggestion for aeshynomenoid nodules (desmodioid nodules being

very unusual in trees and therefore not considered). They pointed out that it would require a line of evolution separate from those species with root-hair infection and infection-thread formation, if their infection process were the primitive one. Now that the evidence of Lavin *et al.* (2005) shows that the dalbergioid crown node is rooted at a date similar to that (give or take a few million years!) of both the genistoid group and the mimosoid group, it seems logical to invoke a non-hair pathway as primitive, or at least, not derived. A further possibility is that both types of infection pathways evolved in parallel as separate events. This would be consistent with the 'primitive' type of nodule (Table 1), where bacteroids are not released from infection threads, a condition thought to be essential for full functioning of well studied legumes (see Chapters 5, 6 and 7). The caesalpinioid and papilionoid genera, in which this type of nodule with unreleased bacteroids is found, are all trees, which may or may not be relevant. Unfortunately, we still have no rigorous analysis of the development of such nodules.

The situation is clearer for desmodioid nodules, which according to Polhill (1981) and Corby (1981) would be derived - a concept supported by the molecular evidence of Lavin *et al.* (2005). In the latter analysis, the tribes that have desmodioid nodules are in quite separate groups, the Desmodieae and Phaseoleae in the Millettoid group and the Loteae in the Robinioid group. This distribution and the differences in nodule physiology make it likely that this nodule type evolved on two occasions, but whether they did so from genera with other nodule forms is not known.

4.6. Evolution of Nodulation

Doyle and co-workers (*e.g.*, Doyle *et al.*, 1997) have considered the possible origin of nodulation in the light of modern molecular data and concluded that nodulation in legumes may have evolved on three separate occasions, once in the ancestors of Papilionoideae, once in the ancestor of *Tachigali* and *Erythrophleum* (Caesalpinioideae), leading also to nodulation in Mimosoideae, and once in *Chamaecrista* (Caesalpinioideae). This last case needs to be reviewed in the light of the recent evidence (see above) that *Chamaecrista* may be more closely related to other nodulated caesalpinioid legumes than was thought. On the other hand, it now seems unlikely that Mimosoideae evolved from Caesalpinioideae, so perhaps an extra nodulation event is needed. Until more genera are included in the molecular studies, it is pointless to speculate further, but the concept of several nodulation events remains likely. It is also likely that the ability to nodulate has been lost in a number of genera as indicated in the discussion of the three sub-families.

4.7. Biogeography and Biomes

For many years, people have been trying to decide when and where legumes evolved and how they arrived at their present global distribution. The earliest suggestion was that legumes evolved in tropical America and spread to Africa when the two continents were still attached. However, we now know that the continents

separated before legumes evolved. The second idea, in favor until very recently (see, for example, the excellent discussion in Doyle and Luckow, 2003), was that legumes took the scenic route from S America, heading north *via* a boreal land bridge and then turning south *via* India to arrive in Africa and elsewhere. Unfortunately, this idea has also hit problems because North and South America were not connected until 3Ma bp and so alternatives are being sought.

Schrire *et al.* (2005) have tried to interpret current and past legume distribution in terms of biomes [a rather flexible term, but generally related to community classification at the macroscale level; the various usages of the term are discussed by Pennington *et al.* (2004)] and how climate changed as continents moved. This interpretation will not be discussed in detail here because it has problems explaining the current distribution of nodulated legumes. For example, how did *Mimosa* get from South and Central America to Madagascar without stopping long in mainland Africa? Many workers are now beginning to think the unthinkable, that plants can travel long distances across water, possibly by island hopping or by wind (Renner, 2004). Apart from Doyle and Luckow (2003), none of these ideas about legume distribution takes nodulation into account, which is a pity as some interesting patterns are emerging (see below).

5. THE PRESENT

It is interesting to examine the geographical distribution of nodulated legumes and their dependence on nodulation and nitrogen fixation. Proceeding from high to low latitudes, a number of trends can be distinguished. First, there are very few caesalpinoid or mimosoid legumes native to either high latitudes or high altitudes, both of which share some common features. With the occasional exception, such as the non-nodulating caesalpinoid tree genus *Gleditsia*, which has extended into warm temperate regions, all legumes at higher latitudes are able to nodulate and are usually found to do so in natural conditions. Second, with increasing latitude, legume trees become scarcer and herbaceous forms, both annual and perennial, become more common. In the Northern hemisphere, legumes are found above the Arctic Circle, where they nodulate and fix N₂ with cold-adapted rhizobia (*e.g.*, Schulman *et al.*, 1988). With the exception of some species of *Lotus*, all legumes of high latitudes have indeterminate, often perennial nodules. These can commence growth very rapidly after periods of adverse conditions, such as cold or drought, whereas desmodioid nodules are short lived and must be replaced when plant growth is resumed. In the polar and sub-polar regions of the Southern hemisphere, there are few places where legumes might be able to grow; some of these, like the Malvinas (Falkland Islands), have no native nodulated plants in their flora, relying on the cyanobacterial symbiosis with the *Gunnera* (Sprent, 2001).

A final, but very important feature associated with latitude is that of host specificity and nodule effectiveness. The vast majority of work on this topic has been carried out on papilionoid legumes of temperate areas (see Chapters 3-6), where there is good evidence for close cooperation between host and endosymbiont, to their mutual benefit (see Chapter 3). However, in warmer temperate and tropical

areas, particularly under dry conditions, a single host species may be nodulated by a variety of rhizobial genera and species and a single rhizobial strain may nodulate many hosts. A typical example is that of some species of Australian acacias, where nodules range from being effectively parasitic on their host plants to being highly effective (Burdon *et al.*, 1999). Thus, the very elegant controls exerted on each partner by the other cannot be fully operative (Sprent, 2003).

From a longitudinal perspective, some interesting features are associated with tropical rain forests. In many parts of Asia, these contain few legumes whereas, in Africa and South America, legume trees abound. In African rainforests, most legume trees are from non-nodulating, ceasalpinioid tribes, whereas there are trees in the Amazon and Orinoco rainforests from all subfamilies and the majority of them nodulate. However, in some African forests, the few trees that can nodulate do so very copiously and might possibly share their fixed nitrogen with other trees of the forest through mycorrhizal networks. These aspects are discussed in more detail elsewhere (see Sprent, 2005).

6. CONCLUSIONS

Over the last ten years, a number of suggestions have been made as to when, where, and how many times nodulation evolved in legumes. Although much new evidence has been published on the phylogeny of legumes, it is still not clear how many nodulation events occurred, although it now appears likely that nodulation occurred early in the evolution of the family. Multiple nodulation events are indicated by the fact that basal members of all three sub-families appear not to nodulate. Current evidence also suggests that there was an early divergence between nodules where individual cells were each infected by a branch of an infection thread and those where a few cells were infected and then divided repeatedly (dalbergioids and some genistoids). When the former situation follows from a root-hair infection, it may allow greater specificity between host and bacteria than the latter. If more attention is given to nodulation characters, the relations between some of the basal genera of legumes may be better resolved. In the next few years, the number of bacteria known to nodulate legumes is likely to increase further and some indication of the importance of these particular ecosystems may be gained.

REFERENCES

- Barham, J. (2005). Dipterygeae. In G. Lewis, B. Schrire, B. Mackinder, and M. Lock, (Eds.), *Legumes of the world*, (pp.250-251). Kew, UK: Royal Botanic Gardens.
- Barrett, C. F., and Parker, M. A. (2005). Prevalence of *Burkholderia* sp. nodule symbionts on four mimosoid legumes from Barro Colorado Island, Panama. *Syst. Appl. Microbiol.*, 28, 57-65.
- Bird, D., Opperman, C. H., and Davies, K. G. (2003). Interactions between bacteria and plant-parasitic nematodes: Now and then. *Int. J. Parasitol.*, 33, 1269-1276.
- Bright, L. J., Liang, Y., Mitchell, D. M., and Harris, J. M. (2005). The *LATD* gene of *Medicago truncatula* is required for both nodule and root development. *Mol. Plant-Microb. Interact.*, 18, 521-532.
- Burdon, J. J., Gibson, A. H., Searle, S. D., Woods, M. J., and Brockwell, J. (1999). Variation in the effectiveness of symbiotic associations between native rhizobia and temperate Australian *Acacia*: Within-species interactions. *J. Appl. Ecol.*, 36, 398-408.

- Cannon, S. B., McCombie, W. R., Sato, S., Tabata, S., Denny, R., *et al.* (2003). Evolution and micro-synteny of the apyrase gene family in three legume genomes. *Mol. Genet. Genom.*, *270*, 347-361.
- Chandler, M. R. (1978). Some observations on the infection of *Arachis hypogaea* L. by *Rhizobium*. *J. Exp. Bot.*, *29*, 749-755.
- Chen, W-M, James, E. K., Prescott, A. R., Kierans, M., and Sprent, J. I. (2003). Nodulation of *Mimosa* spp. by the β -proteobacterium *Ralstonia taiwanensis*. *Mol. Plant-Microb. Interact.*, *16*, 1051-1061.
- Chen, W-M., Janes, E. K., Chou, J-H., Sheu, S-Y., Yang, S-Z., and Sprent, J. I. (2005). β -rhizobia from *Mimosa pigra*, a newly discovered invasive plant in Taiwan. *New Phytol.*, *268*, 661-675.
- Corby, H. D. L. (1981). The systematic value of leguminous root nodules. In R. M. Polhill and P. H. Raven (Eds.) *Advances in legume systematics*, Part 2 (pp. 657-669). Kew, UK: Royal Botanic Gardens.
- Corby, H. D. L. (1988). Types of rhizobial nodule and their distribution among the Leguminosae. *Kirkia*, *13*, 53-123.
- Crisp, M., Cook, L., and Steane, D. (2004). Radiation of the Australian flora: What can comparisons of molecular phylogenies across multiple taxa tell us about the evolution of diversity in present-day communities? *Phil. Trans. Roy. Soc. B*, *359*, 1551-1571.
- Deschodt, C. C., and Strijdom, B. W. (1976). Effective nodulation of *Aspalathus linearis* ssp. *linearis* by rhizobia from other *Aspalathus* species. *Phytophylactica*, *8*, 103-104.
- Downie, J. A. (2005). Legume haemoglobins: Symbiotic nitrogen fixation needs bloody nodules. *Curr. Biol.*, *15*, 196-198.
- Doyle, J. J., and Luckow, M. A. (2003). The rest of the iceberg. Legume diversity and evolution in a phylogenetic context. *Plant Physiol.*, *131*, 900-910.
- Doyle, J. J., Doyle, J. L., Ballenger, J. A., Dickson, E. E., Kafita, T., and Ohashi, H. (1997). A phylogeny of the chloroplast gene *rbcL* in the Leguminosae: Taxonomic correlations and insights into the evolution of nodulation. *Amer. J. Bot.*, *84*, 541-554.
- Ducousso, M., Béna, G., Bourgeois, C., Buyck, B., Eyssartier, G., *et al.* (2004). The last common ancestor of Sarcocaulaceae and Asian dipterocarp trees was ectomycorrhizal before the India-Madagascar separation about 88 million years ago. *Mol. Ecol.*, *13*, 231-236.
- Fehlberg, V., Vieweg, M. F., Dohmann, E. M. N., Hohnjec, N., Pühler, A., *et al.* (2005). The promoter of the leghaemoglobin gene *VjLb29*: Functional analysis and identification of modules necessary for its activation in the infected cells of root nodules and in the arbuscular-containing cells of mycorrhizal roots. *J. Exp. Bot.*, *56*, 799-806.
- Fitter, A. H., and Moyersoen, B. (1996). Evolutionary trends in root-microbe symbioses. *Phil. Trans. R. Soc. Lond. B*, *351*, 1367-1375.
- Floyd, S. K., and Bowman, J. L. (2004). Ancient microRNA target sequences in plants. *Nature*, *428*, 485-486.
- Fortunato, R. H. (2005). Mimosoizanthaceae. In G. Lewis, B. Schrire, B. Mackinder, and M. Lock, (Eds.), *Legumes of the world*, (pp. 184-185). Kew, UK: Royal Botanic Gardens.
- Gualtieri, G., and Bisseling, T. (2000). The evolution of nodulation. *Plant Mol. Biol.*, *42*, 181-194.
- Goormachtig, S., Capoen, W., James, E. K., and Holsters, M. (2004). Switch from intracellular to intercellular invasion during water stress-tolerant legume nodulation. *Proc. Natl. Acad. Sci. USA*, *101*, 6303-6308.
- Guldner, E., Desmarais, E., Galtier, N., and Godelle, B. (2004). Molecular evolution of plant haemoglobin: Two haemoglobin genes in nymphaeaceae *Euryale ferox*. *J. Evol. Biol.*, *17*, 48-54.
- Hardison, R. C. (1996). A brief history of hemoglobins: Plant, animal, protist and bacteria. *Proc. Natl. Acad. Sci. USA*, *93*, 5675-5679.
- Heckman, D. S., Geiser, D. M., Eidell, B. R., Stauffer, R. L., Kardos, N. L., and Hedges, S. B. (2001). Molecular evidence for the early colonization of land by fungi and plants. *Science*, *293*, 1129-1933.
- Iannetta, P. P. M., James, E. K., Sprent, J. I., and Minchin, F. R. (1995). Time-course of changes involved in the operation of the oxygen diffusion barrier in white lupins. *J. Exp. Bot.*, *46*, 565-575.
- Igamberdiev, A. U., and Hill, R. D. (2004). Nitrate, NO and haemoglobin in plant adaptation to hypoxia: An alternative to classic fermentation pathways. *J. Exp. Bot.*, *55*, 2473-2482.
- Ireland, H. E. (2005). Swartzia. In G. Lewis, B. Schrire, B. Mackinder, and M. Lock, (Eds.), *Legumes of the world*, (pp. 215-225). Kew, UK: Royal Botanic Gardens.
- James, E. K., Sprent, J. I., Sutherland, J. M., McInroy, S. G., and Minchin, F. R. (1992). The structure of nitrogen fixing root nodules in the aquatic mimosoid legume *Neptunia plena*. *Ann. Bot.*, *14*, 173-180.

- James, E. K., Iannetta, P. P. M., Naisbitt, T., Goi, S. R., Sutherland, J. M., *et al.* (1994). A survey of N₂-fixing nodules in the Leguminosae with particular reference to intercellular glycoproteins and the control of oxygen diffusion. *Proc. Roy. Soc. Edin.*, 102B, 429-432.
- Lavin, M., Pennington, R. T., Klitgaard, B. B., Sprent, J. I., de Lima, H. C., and Gasson, P. E. (2001). The Dalbergioid legume (Fabaceae): Delimitation of a pantropical monophyletic clade. *Amer. J. Bot.*, 88, 503-533.
- Lavin, M., and Schrire, B. D. (2005). Sesbanieae. In G. Lewis, B. Schrire, B. Mackinder, and M. Lock (Eds.), *Legumes of the world*, (pp. 452-453). Kew, UK: Royal Botanic Gardens.
- Lavin, M., Herendeen P. S., and Wojciechowski, M. F. (2005). Evolutionary rates analysis of Leguminosae implicates a rapid diversification of lineages during the tertiary. *Syst. Biol.*, 54, 575-594.
- Lewis, G. P. (2005a). Cassieae. In G. Lewis, B. Schrire, B. Mackinder, and M. Lock (Eds.), *Legumes of the world*, (pp. 112-135). Kew, UK: Royal Botanic Gardens.
- Lewis, G. P. (2005b). Acacieae. In G. Lewis, B. Schrire, B. Mackinder, and M. Lock (Eds.), *Legumes of the world*, (pp. 187-191). Kew, UK: Royal Botanic Gardens.
- Lewis, G. P., and Schrire, B. D. (2003). Leguminosae or Fabaceae. In B. B. Klitgaard and A. Bruneau (Eds.) *Advances in legume systematics*, Part 10, (pp.1-3). Kew, UK: Royal Botanic Gardens.
- Lewis, G., Schrire, B., Mackinder, B., and Lock, M. (2005). *Legumes of the world*. Kew, UK: Royal Botanic Gardens.
- Luckow, M. (2005). Mimoseae. In G. Lewis, B. Schrire, B. Mackinder, and M. Lock (Eds.), *Legumes of the world*, (pp.162-183). Kew, UK: Royal Botanic Gardens.
- Marmeisse, R., Guidot, A., Gay, G., Lambilliotte, R., Sentenac, H., *et al.* (2004). *Hebeloma cylindrosporium* – a model species to study ectomycorrhizal symbiosis from gene to ecosystem. *New Phytol.*, 163, 481-498.
- Maslin, B. R. (2005). World wide wattle. <http://www.worldwidewattle.com>
- Mathesius, U. (2003). Conservation and divergence of signalling pathways between roots and soil microbes - the *Rhizobium*-legume symbiosis compared to the development of lateral roots, mycorrhizal interactions and nematode-induced galls. *Plant Soil*, 255, 105-119.
- Naisbitt, T., James, E. K., and Sprent, J. I. (1992). The evolutionary significance of the genus *Chamaecrista* as determined by nodule structure. *New Phytol.*, 122, 487-492.
- Nicolson, T. H. (1975). Evolution of vesicular-arbuscular mycorrhizas. In F. E. Sanders, B. Mosse and P. B. Sanders (Eds), *Endomycorrhizas*, (pp. 25-34). London, UK: Academic Press.
- Nutman, P. S. (1948). Physiological studies on nodule formation I. The relation between nodulation and lateral root formation in red clover. *Ann. Bot.*, 12, 81-96.
- Ott, T., van Dongen, J. T., Günther, C., Krussel, L., Desbrosses, G., *et al.* (2005). Symbiotic leghemoglobins are crucial for nitrogen fixation in legume root nodules but not for general plant growth and development. *Curr. Biol.*, 15, 531-535.
- Pagani, M., Zachos, J. C., Freeman, K. H., Tipple, B., and Bohaty, S. (2005). Marked decline in atmospheric carbon dioxide concentrations during the Palaeogene. *Science*, 309, 600-603
- Pawlowski, K. and Sprent, J. I. (2007). Comparison between actinorhizal and legume symbioses. In K. Pawlowski and W. E. Newton (Eds.), *Nitrogen-fixing actinorhizal symbioses* (pp. 261-288). Dordrecht, The Netherlands: Springer.
- Pennington, R. T., Cronk, Q. C. B., and Richardson, J. A. (2004). Introduction and synthesis: Plant phylogeny and the origin of major biomes. *Phil. Trans. Roy. Soc. Lond. B*, 359, 1455-1464.
- Pennington, R. T., Stirton, C. H. and Schrire, B. D. (2005). Sophoreae. In G. Lewis, B. Schrire, B. Mackinder, and M. Lock (Eds.), *Legumes of the world*, (pp. 227-249). Kew, UK: Royal Botanic Gardens.
- Polhill, R. M. (1981). Papilionoideae. In R. M. Polhill, and P. H. Raven (Eds.), *Advances in legume systematics*, Part 1, (pp. 191-208). Kew, UK: Royal Botanic Gardens.
- Raven, J. A., and Edwards, D. (2001). Roots: Evolutionary origins and biogeochemical significance. *J. Exp. Bot.*, 52, 381-401.
- Remy, W., Taylor, T. N., Hass, H., and Kerp, H. (1994). Four hundred-million-year-old vesicular arbuscular mycorrhizae. *Proc. Natl. Acad. Sci. USA*, 91, 11841-11843.
- Renner, S. (2004). Plant dispersal across the tropical Atlantic by wind and sea currents. *Int. J. Plant Sci.*, 165, S23-33 (Suppl. S)

- Rodríguez-Llorente, I. D., Pérez-Hormaeche, J., El Mounadi, K., Dary, M., Caviades, M. A., *et al.* (2004). From pollen tubes to infection threads: Recruitment of floral pectic genes for symbiosis. *Plant J.*, *39*, 587-598.
- Sage, R. F. (2004). The evolution of C₄ photosynthesis. *New Phytol.*, *161*, 341-370.
- Sanchez, L., Weidmann, S., Brechenmacher, L., Batoux, M., van Tuinen, D., *et al.* (2004). Common gene expression in *Medicago truncatula* roots in response to *Pseudomonas fluorescens* colonization, mycorrhiza development and nodulation. *New Phytol.*, *161*, 855-863.
- Schrire, B. D. (2005). Millettieae. In G. Lewis, B. Schrire, B. Mackinder, and M. Lock (Eds.), *Legumes of the world*, (pp. 367-387). Kew, UK: Royal Botanic Gardens.
- Schrire, B. D., Lavin, M., and Lewis, G. P. (2005). Global distribution patterns of the Leguminosae: Insights from recent phylogenies. In I. Friis and H. Balslev (Eds.), *Plant diversity and complexity patterns: Local, regional and global dimensions*. *Biol. Skr.*, *55*, 375-422.
- Schulman, H. M., Lewis, M. C., Tipping, E. M., and Bordeleau, L. M. (1988). Nitrogen fixation by three species of Leguminosae in the Canadian high Arctic tundra. *Plant Cell Environ.*, *11*, 721-728.
- Soltis, D. E., Soltis, P. S., Chase, M. W., Mort, M. E., Albach, D. C., *et al.* (2000). Angiosperm phylogeny inferred from 18S rDNA, *rbcl*, and *atpB* sequences. *Bot. J. Linn. Soc.*, *133*, 381-461.
- Sousa, S. M., and Rudd, V. E. (1993). Revision del genero *Styphnolobium* (Leguminosae: Papilionoideae: Sophoreae). *Ann. Missouri Bot. Garden*, *80*, 270-283.
- Sprent, J. (1994). Nitrogen acquisition systems in the Leguminosae. In J. I. Sprent and D. McKey (Eds.), *Advances in legume systematics, Part 5, The nitrogen factor* (pp. 1-23). Kew, UK: Royal Botanic Gardens.
- Sprent, J. I. (2000). Nodulation as a taxonomic tool. In P. S. Herendeen and A. Bruneau (Eds.), *Advances in legume systematics, Part 9*, (pp. 21-44). Kew, UK: Royal Botanic Gardens.
- Sprent, J. I. (2001). *Nodulation in legumes*. Kew, UK: Royal Botanic Gardens (146 pp.).
- Sprent, J. I. (2003). Mutual sanctions. *Nature*, *422*, 672-674.
- Sprent, J. I. (2005). Nodulated legume trees. In D. Werner and W. E. Newton (Eds.), *Nitrogen fixation in agriculture, forestry, ecology, and the environment* (pp. 113-141). Dordrecht, The Netherlands: Springer.
- Sprent, J. I., and Parsons, R. (2000). Nitrogen fixation in legume and non-legume trees. *Field Crops Res.*, *65*, 183-196.
- Sprent, J. I., and Sprent, P. (1990). *Nitrogen fixing organisms: Pure and applied aspects*. London, UK: Chapman & Hall.
- Sprent, J. I., Sutherland, J. M., and de Faria, S. M. (1989). Structure and function of nodules from woody legumes. In C. H. Stirtton and J. L. Zarucchi (Eds.), *Monographs in systematic botany* 29, (pp. 559-578). St Louis, MO: Missouri Botanical Gardens.
- Sutherland, J. M., McInroy, S. G., James, E. K., and Naisbitt, T. (1994). Nodule structure with special reference to the tribes Sophoreae, Genisteae and Thermopsidae. In J. I. Sprent and D. McKey (Eds.), *Advances in legume systematics, Part 5, The nitrogen factor* (pp. 41-55). Kew, UK: Royal Botanic Gardens.
- Sy, A., Giraud, E., Jourand, P., Garcia, N., Willems, A., *et al.* (2001). Methylophilic *Methylobacterium* bacteria nodulate and fix nitrogen in symbiosis with legumes. *J. Bacteriol.*, *183*, 214-220.
- Szczyglowski, K., and Amyot, L. (2003). Symbiosis, inventiveness by recruitment? *Plant Physiol.*, *131*, 935-940.
- Vega-Hernández, M. C., Pérez-Galdona, R., Dazzo, F. B., Jarabo-Lorenzo, A., Alfayate, M. C., *et al.* (2001). Novel infection process in the indeterminate root nodule symbiosis between *Chamaecytisus proliferus* (tagasaste) and *Bradyrhizobium* sp. *New Phytol.*, *150*, 707-721.
- Vieweg, M. F., Fruhling, M., Quant, H. J., Heim, U., Baumlein, H., *et al.* (2004). The promoter of the *Vicia faba* L. leghemoglobin gene *VfLb29* is specifically activated in the infected cells of root nodules and in the arbuscule-containing cells of mycorrhizal roots from different legume and non-legume plants. *Mol. Plant-Microbe Interact.*, *17*, 62-69.
- Wittenberg, J. B., Bolognesi, M., Wittenberg, B. A., and Guertin, M. (2002). Truncated hemoglobins: A new family of hemoglobins widely distributed in bacteria, unicellular eukaryotes and plants. *J. Biol. Chem.*, *277*, 871-874.

Chapter 2

ECOLOGY OF THE ROOT-NODULE BACTERIA OF LEGUMES

P. H. GRAHAM

*Department of Soil, Water, and Climate,
University of Minnesota, St Paul, MN 55108, USA.*

1. INTRODUCTION

Nitrogen (N_2) fixation is one of the most important biological processes on earth, with a commonly accepted estimate for global N_2 fixation of 175 million metric tons (Tg) annually (Burns and Hardy, 1975). Annual estimates for the contribution of grain, pasture, and natural-ecosystem legumes to this total range from 25 to 90 Tg (Kinzig and Sokolow, 1994; Smil, 1999). However, nitrogen from below-ground organs is rarely included in such figures, so they are likely to underestimate real fixation levels. Kipe-Nolt and Giller (1993) suggest that 10% of legume N may be left in the root at harvest, with additional N passed directly into the soil during the senescence of nodules and fine roots (Giller, 2001).

Nodulation and N_2 fixation in this symbiosis require that host and microorganism are compatible, but also that the soil environment be appropriate for the exchange of signals that precedes infection (Hirsch *et al.*, 2003; Leibovitch *et al.*, 2001; Zhang *et al.*, 2002). Soil environment is also critical to the persistence of rhizobia in the soil between hosts (Gibson *et al.*, 1976; Parker *et al.*, 1977; Vlassak *et al.*, 1997). Earlier reviews have chronicled the influence of biotic and abiotic soil factors on *Rhizobium* ecology (Alexander, 1982; Amarger, 2001; Bushby, 1982; Fahraeus and Ljunggren, 1968; Parker *et al.*, 1977; Schmidt and Robert, 1985; Sessitsch *et al.*, 2002; Trinick, 1982). A problem in many of these reviews was in adequately describing change at the population level. Tools, such as intrinsic antibiotic resistance (Beynon and Josey, 1980), serology (Bohloul and Schmidt,

1973; Purchase and Vincent, 1949; Purchase *et al.*, 1951), and multilocus enzyme electrophoresis (Pinero *et al.*, 1988; Eardly *et al.*, 1990), have all helped toward a more detailed examination of *Rhizobium* population structure in soil, and how this is influenced by host and environment. However, only with the development of molecular (Hirsch *et al.*, 2003; Thies *et al.*, 2001; Wilson, 1995) and computational tools has the consideration of large populations of rhizobia on a routine basis been possible. These changes, the resurgence of interest in the relationship between below-ground diversity and above-ground function (Bever *et al.*, 1997), and the emerging knowledge of root-nodule bacteria as cereal endophytes and biocontrol agents (Chaintreuil *et al.*, 2000; Hilali *et al.*, 2001) justify the present review.

2. TAXONOMY OF THE ROOT-NODULE BACTERIA

The genus *Rhizobium* was initially defined by the ability of these organisms to induce nodule formation in legumes (Baldwin and Fred, 1929; Fred *et al.*, 1932), with species recognition biased toward agronomically important hosts. Criticisms of this host-dependent approach culminated in a change to a more polyphasic taxonomy (Graham *et al.*, 1991), including morphological and biochemical characteristics, genetic fingerprinting (Versalovic *et al.*, 1994), fatty-acid methyl ester (FAME) analysis (Jarvis and Tighe, 1994; Tighe *et al.*, 2000), and 16S rRNA gene-sequence analysis (Laguerre *et al.*, 1994; Ludwig *et al.*, 1998). This approach, and the study of rhizobia from many new legume species, has resulted in the description of additional genera and species of root-nodule bacteria. It has also led to the discovery of a range of traits in these organisms beyond those envisaged by earlier workers in this field.

The 12 genera and some 50 species of root- and stem-nodule bacteria currently recognized (Sawada *et al.*, 2003) include: (i) both α - and β -proteobacteria (Chen *et al.*, 2003; 2005; Moulin *et al.*, 2001) and organisms that are also facultative autotrophs (Lambert *et al.*, 1985; Lepo *et al.*, 1980); (ii) phototrophs (Chaintreuil *et al.*, 2000; So *et al.*, 1994; Wong *et al.*, 1994); (iii) denitrifiers (Garcia-Plazaola *et al.*, 1993; Polcyn and Lucinzki, 2003; Rosen and Ljunggren, 1996); and (iv) microorganisms that can have plant growth-promoting (Biswas *et al.*, 2000; Chabot *et al.*, 1996; Peng *et al.*, 2002) and phosphate-solubilizing activity (Chabot *et al.*, 1996; Halder and Chakrabarty, 1993). Only a few of these organisms fix significant amounts of N_2 outside their host (Dreyfus *et al.*, 1988; Elliott *et al.*, 2006; Kurz and LaRue, 1975; McComb *et al.*, 1975; Pagan *et al.*, 1975).

The organisms that are symbiotic with legumes include recently-recovered isolates from the genera *Blastobacter*, *Burkholderia*, *Devosia*, *Ensifer*, *Methylobacterium*, *Ochrobactrum*, *Phyllobacterium*, and *Ralstonia* (Chaintreuil *et al.*, 2000; Jourand *et al.*, 2004; Moulin *et al.*, 2001; Rivas *et al.*, 2003; Sy *et al.*, 2001; Trujillo *et al.*, 2005; Valverde *et al.*, 2005; van Berkum and Eardly, 2002; Willems *et al.*, 2003), each still represented by relatively few species. Whether the collective name “rhizobia” will be extended to include β -proteobacteria, such as *Ralstonia* and *Burkholderia*, remains to be determined.

Further changes to the taxonomy of the rhizobia are likely. Recombination in 16S-rRNA genes (van Berkum *et al.*, 2003) means that rRNA-sequence analysis is less stable as a taxonomic trait than previously thought, and that alternate phylogenies may be constructed using other symbiotic and housekeeping genes. Lateral gene transfer within and between specific clades of root-nodule bacteria may also have led to misclassification of some organisms, and difficulties in identifying others. Thus, *Rhizobium gallicum*, *R. mongolense*, and *R. yanglinense* (van Berkum *et al.*, 1998) appear synonymous (Silva *et al.*, 2005; Vinuesa *et al.*, 2005a) and Silva *et al.* (2005) have suggested that these species be combined within a single species with several biovars. The classification of numerous other organisms, each able to nodulate the common bean (*Phaseolus vulgaris* L.) (Martinez-Romero, 2003; Michiels *et al.*, 1998), is also problematic.

Currently recognized genera and species are shown in Table 1, but additions to this list of root- and stem-nodule bacteria occur almost weekly. Several significant rearrangements that are likely to affect the species and genera listed have also been proposed (van Berkum *et al.*, 2006; Young *et al.*, 2001; 2003). As this list grows so too does the need to examine new organisms both for unusual traits that could influence their ecological performance and for overlap between taxonomy and biodiversity. Both Eardly and van Berkum (2004) and Vinuesa and Silva (2004) have recently suggested a population-genetic approach to rhizobial speciation.

Table 1. Recognized genera and species of legume root- and stem-nodule bacteria

Genera/species	Principal and other reported hosts	Description and Emendments
<u>Allorhizobium</u>		
<i>A. undicola</i>	<i>Neptunia natans</i> , <i>Acacia</i> , <i>Faidherbia</i> , <i>Lotus</i>	de Lajudie <i>et al.</i> (1998a); considered within <i>Rhizobium</i> by Sawada <i>et al.</i> (2003).
<u>Azorhizobium</u>		
<i>A. caulinodans</i>	<i>Sesbania rostrata</i>	Dreyfus <i>et al.</i> (1988).
<i>A. doebereineriae</i>	<i>Sesbania virgata</i>	Moreira <i>et al.</i> (2006).
<u>Blastobacter</u>		
<i>B. denitrificans</i>	<i>Aeschynomene indica</i>	van Berkum & Eardly (2002); considered within <i>Bradyrhizobium</i> by van Berkum <i>et al.</i> (2006).
<u>Bradyrhizobium</u>		
<i>B. canariense</i>	<i>Chamaecytisus</i> , <i>Lupinus</i>	Vinuesa <i>et al.</i> (2005a,b); Stepkowski <i>et al.</i> (2005).
<i>B. elkanii</i>	<i>Glycine max</i>	Kuykendall <i>et al.</i> (1993).
<i>B. japonicum</i>	<i>Glycine max</i>	Jordan (1984).
<i>B. liaoningense</i>	<i>Glycine max</i>	Xu <i>et al.</i> (1995).

(Continued)

Table 1. (Continued)

Genera/species	Principal and other reported hosts	Description and Emendments
<i>B. yuanmingense</i>	<i>Lespedeza</i> , <i>Medicago</i> , <i>Melilotus</i>	Yao <i>et al.</i> (2002).
<u><i>Burkholderia</i></u>		
<i>B. caribensis</i>	<i>Mimosa diplotricha</i> , <i>M. pudica</i>	Achouak <i>et al.</i> (1999); Vandamme <i>et al.</i> (2002).
<i>B. cepacia</i>	<i>Alysicarpus glumaceus</i>	Vandamme <i>et al.</i> (2002).
<i>B. phymatum</i>	<i>Machaerium lunatum</i> , <i>Mimosa</i>	Vandamme <i>et al.</i> (2002); Elliott <i>et al.</i> (2006).
<i>B. tuberum</i>	<i>Aspalathus spp.</i>	Vandamme <i>et al.</i> (2002).
<u><i>Devosia</i></u>		
<i>D. neptuniaae</i>	<i>Neptunia natans</i>	Rivas <i>et al.</i> (2003).
<u><i>Ensifer</i></u>		
<i>E. adhaerens</i>		Willems <i>et al.</i> (2003); considered within <i>Sinorhizobium</i> by Sawada <i>et al.</i> (2003)
<u><i>Mesorhizobium</i></u>		
<i>M. amorphae</i>	<i>Amorpha fruticosa</i>	Wang <i>et al.</i> (1999); (2002a).
<i>M. chacoense</i>	<i>Prosopis alba</i>	Velasquez <i>et al.</i> (2001).
<i>M. ciceri</i>	<i>Cicer arietinum</i>	Nour <i>et al.</i> (1994).
<i>M. huakuii</i>	<i>Astragalus sinicus</i> , <i>Acacia</i>	Chen <i>et al.</i> (1991); Jarvis <i>et al.</i> (1997).
<i>M. loti</i>	<i>Lotus corniculatus</i>	Jarvis <i>et al.</i> (1982); (1997).
<i>M. mediterraneum</i>	<i>Cicer arietinum</i>	Nour <i>et al.</i> (1995); Jarvis <i>et al.</i> (1997).
<i>M. plurifarium</i>	<i>Acacia senegal</i> , <i>Prosopis</i> <i>juriflora</i> , <i>Leucaena</i>	de Lajudie <i>et al.</i> (1998b).
<i>M. septentrionale</i>	<i>Astragalus adsurgens</i>	Gao <i>et al.</i> (2004).
<i>M. temperatum</i>	<i>Astragalus adsurgens</i>	Gao <i>et al.</i> (2004).
<i>M. tianshanense</i>	<i>Glycyrrhiza pallidiflora</i> , <i>Glycine</i> , <i>Caragana</i> , <i>Sophora</i>	Chen <i>et al.</i> (1995); Tan <i>et al.</i> (1997).
<u><i>Ralstonia (Cupriavidus)</i></u>		
<i>R. taiwanensis</i>	<i>Mimosa</i>	Chen <i>et al.</i> (2001).
<u><i>Rhizobium</i></u>		
<i>R. etli</i>	<i>Phaseolus vulgaris</i> , <i>Mimosa</i> <i>affinis</i>	Segovia <i>et al.</i> (1993); Wang <i>et al.</i> (1999).
<i>R. galegae</i>	<i>Galega orientalis</i> , <i>G. officinalis</i>	Lindstrom (1989).

<i>R. gallicum</i>	<i>P. vulgaris, Leucaena, Macroptilium, Onobrychis</i>	Amarger <i>et al.</i> (1997).
<i>R. giardinii</i>	<i>P. vulgaris, Leucaena, Macroptilium, Desmanthus</i>	Amarger <i>et al.</i> (1997); Beyhaut <i>et al.</i> (2006).
<i>R. hainanense</i>	<i>Desmodium sinuatum, Stylosanthes, Vigna, Arachis, Centrosema</i>	Chen <i>et al.</i> (1997).
<i>R. huautlense</i>	<i>Sesbania herbacea</i>	Wang <i>et al.</i> (1998).
<i>R. indigoferae</i>	<i>Indigofera</i>	Wei <i>et al.</i> (2002).
<i>R. leguminosarum</i> bv <i>trifolii</i>	<i>Trifolium</i>	Dangeard (1926); Jordan (1984).
bv <i>viciae</i>	<i>Lathyrus, Lens, Pisum, Vicia</i>	Dangeard (1926); Jordan (1984).
bv <i>phaseoli</i>	<i>P. vulgaris</i>	Dangeard (1926); Jordan (1984).
<i>R. loessense</i>	<i>Astragalus, Lespedeza</i>	Wei <i>et al.</i> (2003).
<i>R. mongolense</i>	<i>Medicago ruthenica, Phaseolus vulgaris</i>	van Berkum <i>et al.</i> (1998).
<i>R. sullae</i>	<i>Hedysarum coronarium</i>	Squartini <i>et al.</i> (2002).
<i>R. tropici</i>	<i>P. vulgaris, Dalea, Leucaena, Macroptilium, Onobrychis</i>	Martinez-Romero <i>et al.</i> (1991).
<i>R. yanglingense</i>	<i>Amphicarpaea, Coronilla, Gueldenstaedtia</i>	Tan <i>et al.</i> (2001).
<u><i>Sinorhizobium</i></u>		
<i>S. abri</i>	<i>Abrus precatorius</i>	Ogasawara <i>et al.</i> (2003).
<i>S. americanus</i>	<i>Acacia spp.</i>	Toledo <i>et al.</i> (2003).
<i>S. arboris</i>	<i>Acacia senegal, Prosopis chilensis</i>	Nick <i>et al.</i> (1999).
<i>S. fredii</i>	<i>Glycine max</i>	Scholla and Elkan (1984); Chen <i>et al.</i> (1988).
<i>S. indiaense</i>	<i>Sesbania rostrata</i>	Ogasawara <i>et al.</i> (2003).
<i>S. kostiense</i>	<i>Acacia senegal, Prosopis chilensis</i>	Nick <i>et al.</i> (1999).
<i>S. kummerowiae</i>	<i>Kummerowia stipulacea</i>	Wei <i>et al.</i> (2002).
<i>S. medicae</i>	<i>Medicago truncatula, M. polymorpha, M. orbicularis</i>	Rome <i>et al.</i> (1996).
<i>S. meliloti</i>	<i>Medicago, Melilotus, Trigonella</i>	Dangeard (1926); de Lajudie <i>et al.</i> (1994).
<i>S. morelense</i>	<i>Leucaena leucocephala</i>	Wang <i>et al.</i> (2002b).
<i>S. saheli</i>	<i>Acacia, Sesbania</i>	de Lajudie <i>et al.</i> (1994); Boivin <i>et al.</i> (1997).
<i>S. terangae</i>	<i>Acacia, Sesbania</i>	de Lajudie <i>et al.</i> (1994); Lortet <i>et al.</i> (1996).

3. POPULATION STRUCTURE OF RHIZOBIA IN SOIL AND RHIZOSPHERE

Antonovics (1976), in a paper regarded as a milestone of plant-population genetics, stressed the need to consider genetic and ecological factors in concert. His first tenet states “The ecological amplitude of a species (both within and among communities) has a genetic component. Explaining the abundance and distribution of organisms is basically a genetic problem”. As evident from the preceding paragraphs, it appears that similar principles govern the population structure of both free-living (Horner-Devine *et al.*, 2004) and mutualistic bacteria.

Studies on rhizobial diversity in soil, explored initially through serology and enzyme-electrophoresis, have blossomed with the advent of polymerase chain reaction (PCR)- and DNA sequence-based methodologies. The microsymbionts of common bean provide but one example. *P. vulgaris* was independently domesticated in both Central America and Andean South America. Results from accelerator mass spectrometry placed initial domestication of beans in the Andean region at around 4400BP, whereas for Mesoamerican beans, domestication occurred nearer 2800BP (Kaplan and Lynch, 1999). A third minor gene pool has been suggested for the northern Andean area (Islam *et al.*, 2002). The occurrence of multiple domestication events in each center of origin, coupled with the isolation of these domesticates in the mountain valleys of the Andes, is likely to have contributed to the fixation of plant traits. Notable differences among bean races are evident (Beebe *et al.*, 2000; Singh *et al.*, 1991; Tohme *et al.*, 1996), with hybridization between Andean and Mesoamerican bean lines often resulting in progeny that are genetically crippled. This isolation could also have permitted the regionalization of pathogens and microsymbionts (Gepts, 1988b), including the development of specificities between host and *Rhizobium* (Aguilar *et al.*, 2004; Bernal and Graham, 2001). The former authors even suggest that co-evolution of host and rhizobia in these different regions has given rise to differences in compatibility among bean cultivars and rhizobia. If so, this poses some problems for inoculant strain selection and use, but might also explain the sometimes poor performance of bean cultivars in symbiosis.

Rhizobium etli is the predominant microsymbiont throughout the region to which *P. vulgaris* is indigenous (Aguilar *et al.*, 1998; Bernal and Graham, 2001; Souza *et al.*, 1994), though *R. gallicum* (Mexico; Silva *et al.*, 2003), *R. tropici* (Colombia; Graham *et al.*, 1982), and isolates with the 16S rRNA gene alleles of *R. leguminosarum* bv *phaseoli* (Colombia; Eardly *et al.*, 1995), have also been reported in this region. Genetic diversity within *R. etli* populations in Central and Andean South America is significant. Bernal and Graham (2001) identified two clusters among Ecuadorian isolates that were distinct both from rhizobia collected in Mexico and from strains collected from *Phaseolus aborigineus* in Argentina. Aguilar *et al.* (2004) noted parallel differences in the restriction fragment length polymorphism of *nodC*-PCR products. Many non-symbiotic *R. etli* also occur in the soils of this region (Segovia *et al.*, 1991). Although the level of linkage disequilibrium can vary with population, it is often pronounced (Pinero *et al.*, 1988; Souza *et al.*, 1994; Vinuesa and Silva, 2004).

Bean movement out of the centers of origin of the crop occurred predominantly after Spanish colonization, although Hart and Scarry (1999) suggest that beans were well established in the agriculture of the Great Plain and North-Eastern American Indians as early as 1300 AD. Lewis and Clarke, the American explorers, were fed beans by the Mandans in North Dakota in 1804, well before the settlement of this region and the book "Buffalo Birdwoman's Garden" (Wilson, 1917) provides an early account of how different bean cultivars were traditionally used by the Hidatsa. Rhizobia could have been carried as contaminants on the seed during bean movement from Central America to the Northern USA and to other areas of the world where beans are now grown (Herrera-Cervera *et al.*, 1999; Perez-Ramirez *et al.*, 1998). However, numbers of rhizobia transported in this way would probably have been low. Traditionally, harvested bean seed collected from fields in Central and South America carried 0-80 rhizobial cells seed⁻¹ (B. Tlusty and P.H. Graham, unpublished data), a level at which *Rhizobium* founder effects in any new area of crop production to which limited quantities of this seed was moved would seem likely. Founder effects have also been noted among the rhizobia for clover (Hagen and Hamrick, 1996). It is conceivable that *R. etli* could also have been disseminated as endophytes within corn seed (see section 5.1), again with limitations on the diversity of the microorganisms carried.

Because beans in the USA have rarely been inoculated, we examined the diversity of bean rhizobia trapped from soil in eight different regions of the USA where bean production is significant. Diversity levels were generally lower than reported for bean rhizobia at the center of origin of the crop. The level was particularly low in soil collected from a traditionally grown bean plot at the Fur Trader Museum (Chadron, Nebraska), an organic farm in Buhl, Idaho, and in a field thought to have been used for bean production by Native Americans at Double Ditch, North Dakota. This result was counter-intuitive, but perhaps reflects the more limited seed sources available to such growers. As evident in Figure 1 (B. Tlusty and P.H. Graham, unpublished data), different BoxA1R-PCR fingerprints appeared dominant at each site. This could be the result either of differences in the rhizobia accidentally introduced over time or stem from preferences for specific rhizobia among the different bean types grown in each of these regions. Eminent rhizobia in soil populations seems a more common phenomenon than we had thought, even though McInnes *et al.* (2004) noted that a single-strain type occupied >30% of nodules in *ca.* 75% of the *Rhizobium* population studies they reviewed.

Organisms with 16S rRNA-gene sequences similar to those of *R. etli* have also been recovered from the nodules of several different prairie legumes (Beyhaut *et al.*, 2006; Tlusty *et al.*, 2005; M. Martir, personal communication), suggesting either genetic recombination in soil or that this organism is not as specific in its host requirements as previously thought.

Based on phaseolin-seed type, it is suggested that beans spread both from Mesoamerica into the Caribbean and northern South America, and ultimately into Brazil and from Andean South America to Europe and perhaps then Africa (Gepts, 1988a). From recent studies on the biodiversity and taxonomy of the bean rhizobia from soils in these different areas of production (Table 2), it is clear that *R. etli* has not always maintained its position as the primary microsymbiont of *P. vulgaris* in

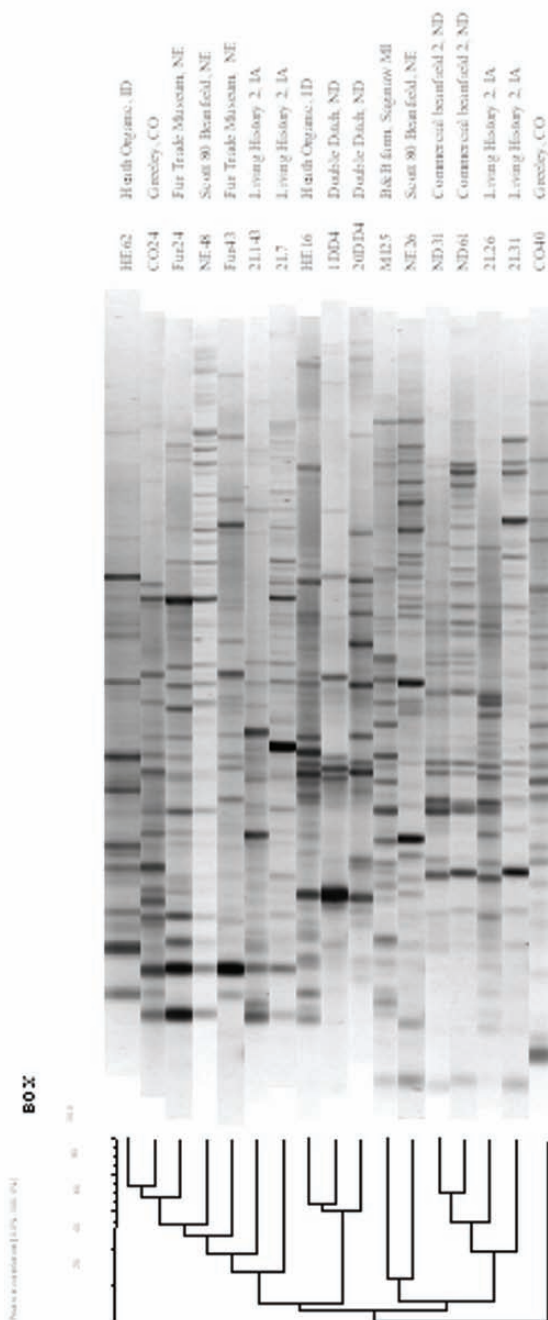

Figure 1. Box AIR-PCR profiles for representative strains of bean rhizobia from eight different areas of bean production in the USA. The sites considered include farms employing either conventional or organic systems of bean production, historical sites where beans have been grown for many years, and areas thought to have been historical Native American gardens.

these new areas. Thus, Geniaux *et al.* (1993) and Amarger *et al.* (1994; 1997) identified *R. leguminosarum* bv *phaseoli*, *R. tropici*, *R. gallicum*, and *R. giardinii* as microsymbionts for this host in France, whereas in Brazil, 48-97% of rhizobia recovered from bean soils of acid pH belonged to the species *R. tropici* (Andrade *et al.*, 2002; Hungria *et al.*, 1997). Interestingly, *R. gallicum* and *R. giardinii* are also infective and effective with the prairie legumes *Dalea purpurea* and *Desmanthus illinoensis*, respectively (Beyhaut *et al.*, 2006; Tlustý *et al.*, 2005), raising further questions on the biogeography and possible differences in mechanisms of spread among fast-growing rhizobia. Although it is not always possible to identify the factors contributing to the differences in the species of rhizobia recovered from beans, some of the host and edaphic factors that might be important are discussed in subsequent sections.

A similar story involving both fast- and slow-growing nodule bacteria is emerging in the case of soybean (*Glycine max* L. Merr.). Microsymbionts for soybean include both fast- (*Sinorhizobium fredii* and *Rhizobium xinjiangensis*) and slow-growing (*Bradyrhizobium japonicum* and *B. elkanii*) rhizobia (van Berkum and Eardly, 1998), with both groups of organism evident in most soils in China, where the crop originated (Dowdle and Bohlool, 1985; Yang *et al.*, 2001). Very high levels of strain diversity are evident, with differences in both the rhizobial specificity of the cultivars grown and the microsymbiont's tolerance of soil pH being important factors in the relative dominance of the different rhizobia at any particular site (Buendia-Claveria *et al.*, 1994; Camacho *et al.*, 2002; Yang *et al.*, 2001).

Soybean emerged as a domesticate in central and northern China between 1100 and 700 BC, with movement into India, Nepal, Burma, Thailand, Indochina, Korea, Japan, Malaysia, Indonesia, and the Philippines before the first millennium AD (Smartt and Hymowitz, 1985). Several host-genetic traits that affect symbiosis with rhizobia occur at different frequency in these secondary regions of soybean production (Devine, 1984; Hungria *et al.*, 2006a; Pulver *et al.*, 1982). Soybean was not introduced into the United States until 1804, and major germplasm collection and evaluation not initiated until the 1920's (Probst and Judd, 1973). The result has been that most soybean breeding in the USA has been done using a very narrow germplasm base (Dellaney *et al.*, 1983), with the consequence that American varieties can be both more specific in rhizobial requirement and need inoculation in conditions where Asian landraces are heavily nodulated (Pulver *et al.*, 1982). This led Mpeperekii *et al.* (2000) to suggest that small landholders in Africa should emphasize symbiotically promiscuous varieties, derived from varieties such as "Gilbert", whereas farmers with access to agricultural inputs should use improved varieties with greater yield potential but that would require inoculation. Indigenous bradyrhizobia capable of nodulating symbiotically promiscuous soybean cultivars in Africa clustered into 11 phylogenetic groups on the basis of restriction fragment length polymorphism in the 16S rRNA gene (Abaidoo *et al.*, 2000) and were distinct from introduced inoculant bradyrhizobia (Abaidoo *et al.*, 2000; 2002). As with other rhizobia, the numbers of these organisms in soil can vary and so affect the symbiotic performance of both promiscuous and *Bradyrhizobium*-specific

soybean cultivars, which are dependent on population size and the effectiveness and persistence in soil of their respective rhizobia (Sanginga *et al.*, 1996).

Table 2. Variation in the frequency with which different species of rhizobia are recovered from soil in different areas of bean production.

	Percentage of strains recovered belonging to a given species					
	<i>R. etli</i>	<i>R. tropici</i>	<i>R. giardinii</i>	<i>R. gallicum</i>	<i>R. leguminosarum</i>	Other
<u>Within centers of origin</u>						
Argentina						
Aguilar <i>et al.</i> (1998)	~100					
Colombia ¹						
Eardly <i>et al.</i> (1995)	48				11(41) ²	
Ecuador						
Bernal and Graham (2001)	~100					
Mexico						
Souza <i>et al.</i> (1994)	~100					
Silva <i>et al.</i> (2003)	86			14		
<u>Outside centers of origin</u>						
Brazil						
Hungria <i>et al.</i> (1997)	97					
Ethiopia						
Beyenne <i>et al.</i> (2004)	(98) ³					
France						
Geniaux <i>et al.</i> (1993)	17	1	10	42	29	
Senegal/Gambia						
Diouf <i>et al.</i> (2000)	88	7				
Spain						
Herrera-Cervera <i>et al.</i> (1999)	54		5	21	1	18
Rodriguez <i>et al.</i> (2000)	73		6	10	4	6
Tunisia						
Mhamdi <i>et al.</i> (2002)	24		2	29	20	9
USA						
Thusty and Graham (unpublished data)	15	13		(60) ³	(60)	

¹ The type strain of *R. tropici* (CIAT 899) was also isolated from Colombian soil (Graham *et al.*, 1982).

² 41% of the strains tested were distinct from *R. leguminosarum* on the basis of enzyme electrophoresis, but had the 16S-rRNA allele of this species.

³ Strains differed in species placement according to the method used.

The situation in the rapidly expanding soybean-production area of Brazil is very different, but equally fascinating. Commercial soybean production in Brazil

did not begin until the 1940s and, into the 1960s, was limited to the southern region of this country (Hungria *et al.*, 2006a). Expansion into the “Cerrados” of Brazil in the 1960s and 1970s necessitated varieties that were calcium-use efficient, had a longer juvenile period, and were more tolerant of high temperature and aluminum toxicity (Spehar, 1995). This expansion also necessitated a strong inoculant strain-selection program because most soils in the region were devoid of soybean rhizobia, and a number of the strains initially introduced were poorly adapted to the unique soil conditions of the Cerrado. By 2001/2002, soybean production in Brazil had expanded onto 6.97 million ha, with a total production of 20.396 Tg, but was still very dependent on rhizobial inoculation. Although more than 90% of the area then in soybean had been previously inoculated, and many soils contained in excess of 10^3 bradyrhizobia g^{-1} , about 60% of farmers still practised inoculation (Hungria *et al.*, 2006b). Yield responses to re-inoculation in 29 trials reviewed by Hungria *et al.* (2006b) averaged 8%. This is a strikingly different result to that achieved with similar initial inoculant strains in the USA and will warrant further comment below on strain evolution and change.

4. ABOVE AND BELOW GROUND DIVERSITY AND SYMBIOTIC FUNCTION

Bever *et al.* (1997) formalized the relationship between above-ground plant species and symbiotic or rhizosphere soil microorganism communities, suggesting that feedback between above- and below-ground species could affect the diversity and function of each. Although much of the subsequent research has emphasized mycorrhiza, feedback between host legumes and their rhizobia is likely to be of at least equal significance. Reynolds *et al.* (2003) broaden this concept to include the key influence of microorganisms in accessing different nutrient pools in soil. Both authors suggest that positive feedback between plants and below-ground microorganisms will serve to reduce diversity, whereas a negative feedback may enhance it, and that spatially-structured soil communities might react differently from those that are more uniformly distributed. Ettema and Wardle (2002) and Wardle (2002) explore above- and below-ground community structure in greater depth, but unfortunately pay limited attention to the legume-root nodule symbiosis and the organisms involved.

4.1. Host Influence on Rhizosphere Diversity and Symbiotic Function

Plant effects on rhizosphere-community structure are under intense scrutiny. Grayston *et al.* (2001; 2004) found fungi more numerous in unimproved pastures, but bacteria enriched in the rhizosphere of improved pasture species. Fungal dominance was associated with the availability of carboxylic acids, phenolics, and neutral amino acids, with bacteria favored where sugars or citric acid were in greater supply. For legumes, spatial and temporal variation in exudates (Marschner *et al.*, 2002; Veneklaas *et al.*, 2003) are also likely to have significant impact on rhizosphere-community structure, including that of the rhizobia. The ability of the

legume host to influence growth of specific rhizobia in the rhizosphere has been known for many years (van Egerat, 1975); so too has the effect of the leguminous host on the rhizobia recovered from soil (Bernal and Graham, 2001; Handley *et al.*, 1998). It is, therefore, surprising that changes in rhizobial-community structure with differences in exudate composition in the host have yet to be detailed. The expectation that exudate composition will influence rhizobial-population structure in the rhizosphere is implicit in projects to elicit opine production by legumes (Oger *et al.*, 2004) and in recent studies of host/*Rhizobium* interaction under environmental stress (Graham *et al.*, 2003; Tesfaye *et al.*, 2003; Veneklaas *et al.*, 2003).

P. vulgaris can again be used as an example in considering host-legume effects in nodulation. This promiscuous host is nodulated by six species of *Rhizobium*, five species of *Sinorhizobium*, and several bradyrhizobia (Martinez-Romero, 2003), yet exhibits specificities in nodulation and nitrogen fixation even within the centers of origin of the crop. Thus, Chaverra and Graham (1992) noted differences in the compatibility of 40 bean cultivars with strains of Mesoamerican and Andean bean rhizobia, whereas Bernal and Graham (2001) and Aguilar *et al.* (2004) found local and exogenous cultivars to recover substantially different populations of bean rhizobia from the same soil. Results with *Vicia*, *Lens* and *Lathyrus* parallel those with *P. vulgaris* (Handley *et al.*, 1998; Slattery *et al.*, 2004); the latter authors noting effective nodulation of field pea in 66% of the fields they tested, where faba bean was effectively nodulated in only 33% of these fields. Mutch and Young (2004) have suggested that the wild species *Vicia cracca*, *V. hirsuta*, *V. sativa*, *Lathyrus pratensis*, *L. aphaca*, and *L. nissolia* share microsymbionts somewhat indiscriminately, whereas the introduced crop species, *Pisum sativum* and *Vicia faba*, are much less promiscuous. Souza *et al.* (1994) also noted that cultivated beans were less promiscuous in the rhizobia with which they nodulated than were ancestral *Phaseolus*.

A number of studies have used a root-tip marking procedure, which was modified from that of Stephens and Cooper (1988), both to show differences in compatibility between host and rhizobia and to demonstrate host preference in nodulation (Bernal, 1993; Chaverra and Graham, 1992; Montealegre and Graham, 1996; Montealegre *et al.*, 1995; Rosas *et al.*, 1998). Bernal (1993), for example, evaluated cultivars, which were representative of the bean clusters distinguished by Singh *et al.* (1991) for speed of nodulation, with 32 Andean and Argentinean bean rhizobia and found speed of nodulation generally faster for the Andean bean cultivars than for those from Mesoamerica.

Quorum sensing uses intercellular signal molecules to coordinate changes in behavior among individual cells, and requires local concentrations of signal-producing bacteria (Hirsch *et al.*, 2003). In rhizobia, this is mediated by N-acyl homoserine lactone signal molecules (Wisniewski-Dye and Downie, 2002) and can be mimicked by host secretions (Bauer and Teplitski, 2001; Fray, 2002). Twelve to twenty compounds, which have the biological effects of N-acyl homoserine lactones, have been recovered from pea and *Medicago truncatula* (Gao *et al.*, 2003; Teplitski *et al.*, 2000), and substantial change with plant developmental age shown. The impact of these quorum-sensing compounds and their plant mimics on the

ecology of rhizobia in the rhizosphere, and on the nodulation process itself, remains to be determined. However, Rodelas *et al.* (1999) have identified a three-gene operon (*rhiABC*) in *R. leguminosarum* that affects nodulation and is strongly induced by a *N*-acyl homoserine lactone.

4.2. Host Sanctions and the Legume-Rhizobium Symbiosis

Bever and Simms (2000) developed a model on the evolution of nitrogen fixation in legumes, which is based on the premise that bacteroid rhizobia do not survive nodule senescence. In their model, the only ecological benefit to the rhizobia was from enhanced root exudates made available to kin rhizobia outside the nodule. This led them to a consideration of cheaters in symbiosis; rhizobia able to induce nodulation, but not to undergo the changes associated with transformation to the bacteroid state. Their first premise is incorrect. McDermott *et al.* (1987) found more than 10^9 viable rhizobia g^{-1} in determinate soybean-nodule tissue, and Sutton (1983) noted that, even in indeterminate nodules where bacteroids undergo significant structural modification, perhaps 1.5% of *Rhizobium* cells survive release from the nodule. In our laboratory, direct counts made on individual 4-month-old indeterminate nodules of purple prairie clover (*Dalea purpurea*) recovered 10^7 - 10^9 viable rhizobia per nodule, with a strong correlation between nodule size and number of viable cells recovered (P.H. Graham and B. Tlustý, unpublished data).

It is interesting that significant levels of the osmotic protectant, trehalose, have been found in the nodules of species such as soybean, and become the most abundant non-structural carbohydrate in these nodules as they senesce (Muller *et al.*, 2001). Because addition of trehalose to inoculant cultures during growth can increase the survival of these cells on seed by two- to four-fold (Streeter, 2003), trehalose production could be a factor in the survival of rhizobia within the nodules on many host species. Certainly, the dramatic increase in soil rhizobia following growth of an appropriate host legume (Thies *et al.*, 1995) is unlikely to be due to either rhizosphere multiplication or to cheaters alone.

The concern of Bever and Simms with cheating by rhizobia has stimulated an interesting discussion. West *et al.* (2002) review possible rewards for rhizobia active in N_2 fixation and sanctions for organisms that cheat and give, as an obvious example of the latter, the withdrawal of carbohydrate supply to ineffective nodules. In a classic study, where N_2 in the atmosphere was replaced with argon to prevent N_2 fixation by whole plants or individual nodules, Kiers *et al.* (2003) found numbers of rhizobia per plant or per nodule to decrease once fixation was prevented. Other possible mechanisms for sanction have been reported. Thus, Lodwig *et al.* (2003) used *Rhizobium* amino acid-transport mutants to show that, during symbiosis, the plant supplies amino acids to the microsymbiont, allowing them to shut down ammonium assimilation. In return, ammonium generated during fixation and amino acids, such as glutamate and aspartate, are cycled back to the plant for asparagine and glutamine synthesis. Rhizobia within the nodule are usually protected against host-defence mechanisms, protecting the plant from pathogens. Early decay in this protection might also be a way to sanction rhizobia that cheat.

Most studies with “cheaters” have emphasized fixed-N as the product “traded” by mutualist rhizobia. We should not forget that the plant might consider other products in deciding on the need for sanctions. Even if fixed-N is traded by rhizobia, it may not be to the benefit of the rhizobia to maximize rates of N₂ fixation, especially under natural conditions where much of the nitrogen fixed is returned to the soil. For a reconstructed prairie in Wisconsin, Brye *et al.* (2002) noted unexplained increases in soil N of 130 kg ha⁻¹ annum⁻¹, with symbiotic N₂ fixation a likely source of the added N. At this rate, build up of soil microbial N in a prairie could be rapid, resulting in likely inhibition of subsequent nodulation and N₂ fixation. A decline in N₂ fixation in a stand of *Acacia koa* over a 10-year period was reported by Pearson and Vitousek (2001). It would be interesting to contrast benefits to the rhizobia from fully- and less-effective symbiosis under natural conditions and how this varies from the crop situation, where much of the fixed-N is removed in the grain.

4.3. Ecosystem Fragmentation and Host Diversity and Function

Agricultural expansion impacts and fragments natural ecosystems; human activities have already transformed 33-50% of the earth’s surface. Consequences include extinction of some plant species and reduction in the population size, diversity, and function of others (Young and Clarke, 2000). Heavy nitrogen fertilization, as practiced in many first-world countries, and N deposition add to these effects by encouraging invasive plant species and reducing plant diversity (Bobbink *et al.*, 1998; Weiss, 1999). In contrast, N depletion, C addition, or fire favors enhanced plant biodiversity (Baer *et al.*, 2003; Blumenthal *et al.*, 2003) and is likely to be of particular benefit to legumes. Studies on both legume and rhizobial diversity and nitrogen fixation in natural ecosystems fragmented by agricultural expansion have been limited.

We are using the purple prairie clover, *D. purpurea*, to study such effects in more detail. *D. purpurea* is a self-incompatible perennial extremely deep-rooted and symbiotically promiscuous plant, which may persist for a number of years at the same location. *Dalea* plants per prairie fragment can vary from <20 to >1000, our hypothesis being that inbreeding depression among limited numbers of plants in a small prairie fragment could, over time, lead to both reduced N₂ fixation in the host and subsequent differences in associated rhizobia. Separation between hosts and compatible rhizobia among such fragments could lead to the extinction of specific rhizobia and mean that suitable rhizobia are no longer available when the fragments are re-colonized by accidentally-introduced or wind-dispersed seed. In an initial study with the rhizobia associated with *D. purpurea* in three remnant prairies in Minnesota and Iowa, Tlusty *et al.* (2005) found different species of rhizobia dominant in nodule formation at each site. Although *R. gallicum* and organisms similar to *R. etli* were most commonly recovered from *Dalea* (Graham *et al.*, 1999; Tlusty *et al.*, 2005), significant numbers of the rhizobia that associated with this host in the more perturbed Kellogg-Weaver Dunes prairie closely identified with *M. huaukii* and *M. amorphae*.

4.4. Role of the Rhizobium in Host Diversity and Function

Rhizobia in the rhizosphere of their hosts produce population density-dependent responses that influence infection (Loh *et al.*, 2001), surface lipopolysaccharides and glucans, both of which determine attachment between host and rhizobia and subsequent nodulation (Lagares *et al.*, 1992; Antipchuk and Kosenko, 2004), as well as one or more nodulation factors, which influence host range (Parniske and Downie, 2003). Rhizobia, like their host, also regulate nodule number (Graham, 1973; Nutman, 1962), with successful nodule formation helping to determine host diversity and function. Laguerre *et al.* (2003) characterized rhizobia associated with *V. faba* and *P. sativum*, using both genomic and symbiotic markers, and showed significant differences between soil, rhizosphere, and nodule populations. *V. faba* was nodulated almost exclusively by isolates with the same symbiotic genotype, whereas both genomic and symbiotic background affected nodulation of *P. sativum*. Differences in compatibility for nodulation could determine the “pecking order” among the diversity of strains apparently shared by wild pea and *Vicia* plants (Mutch and Young, 2004).

Thompson (1998) notes that biologists often distinguish between evolutionary and ecological time, but points out that, for some evolutionary processes, metapopulation structure can rapidly alter the genetic boundaries of species. He cites as example interspecific interactions within natural communities, and suggests that coevolution can occur within the timescale of decades.

Rapid evolutionary change is certainly evident among soybean rhizobia in the Cerrados of Brazil. As indicated earlier, cropping of this region did not expand significantly until the 1960's, and was initially dependent on inoculation with a very few strains of rhizobia, including CB1809, 532C and SEMIA5020 (Hungria *et al.*, 2006a). Currently, however, these soils exhibit very high *Bradyrhizobium* diversity (Chen *et al.*, 2002; Ferreira *et al.*, 2000), with many isolates having similar protein and lipopolysaccharide profiles to the original inoculant rhizobia, but now differing in colony morphology, DNA fingerprints, rates of N₂ fixation, and strain competitiveness (Ferreira *et al.*, 2000; Galli-Terasawa *et al.*, 2003; Santos *et al.*, 1999). Hungria and Vargas (2000) suggest that genetic instability is increased by the high temperature/acid soil conditions of the Cerrado, and note that superior genetic stability is essential for any strain recommended for use in commercial inoculants in Brazil. Presumably because of the adverse conditions, Hungria *et al.* (2006b) note striking responses to re-inoculation of soybean, even when soils contain in excess of 10³ rhizobia g⁻¹.

For the similarly stressful environment of southern Australia, Howieson and Ballard (2004) also suggest that genetic transformation *in situ* is generating new strain variability but, in this case, limiting symbiotic performance. They cite the example of *Biserrula pelecinus*, where only five years after introduction of a unique *Mesorhizobium* sp. as inoculant, a low percentage of nodule isolates already show evidence of recombination (Nandasena, 2005). Vinuesa *et al.* (2005b) also note frequent homologous recombination within, but not across, *Bradyrhizobium* lineages recovered in north-western Africa, but with lateral gene transfer of the *nifH*

locus across lineages also quite common. This tended to result in strains grouped according to their hosts, and not by species assignment.

5. STRAIN COMPETITIVENESS, RHIZOSPHERE COLONIZATION, AND PERSISTENCE

Rhizobial strain success in nodule occupancy (also loosely termed strain competitiveness) is affected by many traits of both host and rhizobia. For a strain to show high nodule occupancy, it must persist in soil in the absence of the host or between growing seasons, must actively colonize the host rhizosphere and undergo attachment when the host is reintroduced (Parker *et al.*, 1977; Lodeiro and Favelukes, 1999), and then complete infection events during a relatively narrow window of time (Bhuvanawari *et al.*, 1980; 1981). Because of these demands, we have earlier suggested that high nodule occupancy does not result from strain competitiveness *per se*, but rather from the ability to complete infection events in a timely manner (Graham and McDermott, 1989). This is supported by the studies of Lupwayi *et al.* (1996), who effectively predicted the relative “competitiveness” of strain pairs from their individual speed in nodulation without ever bringing them together. In this study, predicting strain competitiveness using root-tip marking was only problematic where the strains considered were comparable in speed of nodulation, and other factors determined relative inoculant success. Under such circumstances, dual nodule occupancy was also enhanced, a not unexpected result given that 10+ rhizobia may be enclosed within the shepherd’s crook during the early stages of infection-thread development (Sahlman, 1963). That “competitiveness” is in large measure determined by compatibility between host and rhizobia and by consequent speed of infection, is also consistent with the ability of preferred strains to overcome delays in inoculation compared to a “competitor” (Montealegre and Graham, 1996). This, however, is not the only factor involved.

Strain “competitiveness” is also influenced by the position of specific rhizobia in the soil or rhizosphere. When first introduced into the soil, inoculant rhizobia have both the numbers and a position near the crown of their host to ensure that they produce a significant percentage of the first-formed nodules (McDermott and Graham, 1989). However, these nodules do not persist for the entire growing season (Bergersen, 1958) and, when new nodules are needed, the infectible region of the root is at some distance from the site of initial rhizobial placement, a disadvantage for inoculant rhizobia (Lopez-Garcia *et al.*, 2002; McDermott and Graham, 1989). Studies that evaluate the effect of several years of reinoculation on inoculant strain-nodule occupancy are not common, though Dunigan *et al.* (1984) and Mendes *et al.* (2004) noted a significant increase in nodule occupancy after several seasons of inoculation. In the latter case, this figure declined rapidly once re-inoculation stopped. Denison and Kiers (2004) estimate the chance that a given rhizobial cell in soil will give rise to a nodule (with the huge increase in numbers of rhizobia released into the soil at the end of the growing season that this implies) is about one in a million! A change in any trait that affects the fitness of this cell for rhizosphere growth or saprophytic competence will be seen as affecting

competitiveness and persistence. Thus, single-strain comparisons with arbitrary proportions of each organism added, with no attempt made to simulate rhizobial distribution in soil, are at best a crude approximation of host/rhizobial interaction in the soil. As with other areas considered in this paper, molecular approaches are needed that will permit a more population-oriented approach to the interaction of rhizobia in the soil and rhizosphere.

The reasons for differences in compatibility between host and rhizobium are still only partially understood. At the extreme, gene-for-gene differences in host and nodule bacteria can lead to nodulation failure (Firmin *et al.*, 1993; Hogg *et al.*, 2002; Roddam *et al.*, 2002). Furthermore, nodulation may occur and be effective when only the one strain is present, but not be favored for that strain where there is greater strain diversity present (Bernal *et al.*, 2004). Limited infectiveness can often be compensated for by numbers of available rhizobia (Ferrety *et al.*, 1994). Plant receptor-like kinases required for recognition of lipochitooligosaccharide signal molecules (Oldroyd and Downie, 2004; Radutoiu *et al.*, 2003) could provide opportunity for differences in recognition during infection. Strain and host differences in the proportion of infected root hairs giving rise to nodules (Dart, 1977) are also likely to be important. We have not yet begun to understand the determinants of strain persistence in the soil.

5.1. *Rhizobia as Endophytes and Agents of Biocontrol*

Legumes and cereals are often intercropped, a traditional system that enhances land-use efficiency and reduces farmer dependence on a single plant species (Wooley *et al.*, 1991). Given the proximity over time of cereal and *Rhizobium*, it is not surprising that a number of these organisms have acquired the ability to act as endophytic, as well as nodule, organisms. Several nodule-forming β -proteobacteria have also been recovered from plant tissue. Endophytic rhizobia include: *R. leguminosarum* bv *trifolii* with rice (Yanni *et al.*, 1997; 2001), wheat (Bieberdeck *et al.*, 2000; Evans *et al.*, 2001; Hilali *et al.*, 2001), and cotton (Hafeez *et al.*, 2004); *R. etli* with corn (Gutierrez-Zamora and Martinez-Romero, 2001); photosynthetic bradyrhizobia with wild rice *Oryza breviligulata* (Chaintreuil *et al.*, 2000); and rhizobia from pea on barley and canola (Lupwayi *et al.*, 2004).

Biswas *et al.* (2000) found the response of rice to infection by *Rhizobium* to be highly specific with both stimulatory and inhibitory interactions possible. Reported benefits in this and other studies have included enhanced seedling emergence, improved radicle elongation and root weight, greater single-leaf net photosynthetic rates and plant dry-matter production, and significantly enhanced grain and straw yields (Biswas *et al.*, 2000; Gutierrez-Zamora and Martinez-Romero, 2001; Hilali *et al.*, 2001; Peng *et al.*, 2002; Yanni *et al.*, 1997). With sorghum (Matiru *et al.*, 2005), shoot weight was increased 8-55%, concentrations of phosphorus and potassium in root tissue enhanced 17-250%, and root length promoted 21-32%. With *O. breviligulata*, Chaintreuil *et al.* (2000) recorded low but significant N_2 -fixing activity measured by acetylene reduction (1.7 nmoles C_2H_4 produced plant^{-1} hour^{-1}), but this is by no means common. Instead, Khalid *et al.* (2004) found a

highly significant correlation in plant growth-promoting rhizobacteria between auxin production and plant benefit. Soil factors also influence host benefit. Hilali *et al.* (2001) noted a marked growth response with three strains in a loamy sand at Rabat, whereas there was no response and six of the strains had deleterious effects on plant growth in a silty clay soil at Merchoch.

Gutierrez-Zamora and Martinez-Romero (2001) recovered both infective and non-infective rhizobia in the maize root system, perhaps a factor in the elevated levels of non-infective *R. etli* recovered from soils used for corn and bean production in Mexico (Segovia *et al.*, 1991). In later studies, Rosenblueth and Martinez-Romero (2004) found some strains of *R. etli* and the *R. tropici* strain CIAT899 more competitive for maize-root colonization than others, and suggested that this might be due to tolerance of a maize antimicrobial compound (6-methoxy-2-benzoxazolinone).

Endophytic rhizobia initially colonize the root-cap surface, with many rhizobia remaining either attached to cells that have sloughed off (Chaintreuil *et al.*, 2000) or in the rhizoplane (Schloter *et al.*, 1997). Both authors note subsequent intercellular invasion with microcolonies formed in intercellular spaces between deeper cortical cells, and colonization of some, mostly lysed, cells.

Inoculation of cereals in advance of the legume to be planted and nodulated has been proposed on several occasions (Diatloff, 1969; Evans *et al.*, 2001) but has rarely been logical where the intended legume host could be equally effectively nodulated by routine seed inoculation. One situation, where prior inoculation using a cereal could be of benefit, however, is in the restoration of prairies in the northern USA and Canada. In this case, six or more different legumes may be included in the prairie seed mix, but seeded at relatively low numbers ha⁻¹. Further, fall seeding may expose both legumes and rhizobia to freezing and thawing during the subsequent winter period, with significant delays before legume-seed germination occurs in the following spring. Winter wheat is often used as a cover crop in this system, and could be used as a surrogate host for inoculant rhizobia pending germination of the prairie legumes. Marked differences between wheat cultivars in their ability to support growth of the *D. purpurea* inoculant strain UMR6808 have been shown, with the cultivars Roughrider and Seward outstanding, and with up to 4.12×10^9 rhizobia plant⁻¹ recovered 4 weeks after inoculation. (T. Doan and P.H. Graham, unpublished data).

Because rhizobia are excellent rhizosphere organisms and may also produce plant growth hormones (Perrine *et al.*, 2004; Vincent, 1977), siderophores (Dilworth *et al.*, 1998; Modi *et al.*, 1985; Rioux *et al.*, 1986; van Rossum *et al.*, 1994), and antibiotic substances (Schwinghamer, 1971; Triplett, 1988), they have also been used as plant growth-promoting rhizobacteria, particularly in the control of *Fusarium* and *Pithium* root disease (Bardin *et al.*, 2004; Essalmani and Lahlou, 2003; Estevez de Jensen *et al.*, 2002). Villacieros *et al.* (2003) noted colonization of the alfalfa rhizosphere by *Pseudomonas fluorescens* decreased by one order of magnitude when it was co-inoculated with *Sinorhizobium*; in the same study, *S. meliloti* extensively colonized root hairs, whereas *Ps. fluorescens* did not. Essalmani and Lahlou (2003) found that living rhizobial cells were unable to protect

against *Fusarium oxysporum* without contact with the pathogen; culture filtrate and killed bacteria did not need this contact. They suggested that the filtrate and killed bacteria stimulated plant resistance. Synergism between *Rhizobium* and other rhizosphere organisms has been noted in a number of studies (Estevez de Jensen *et al.*, 2002; Villacieros *et al.*, 2003), but not usually characterized. In an unusual relationship between *P. sativum*, *Rhizobium*, and *Streptomyces lydicus*, Tokala *et al.* (2002) found that the presence of the actinomycete increased nodule number, with *S. lydicus* then colonizing the surface layers of the nodules, enhancing nodule size and iron uptake, but reducing the poly- β -hydroxybutyrate content of bacteroids. *Azospirillum* is also known to act synergistically with *Rhizobium* (Burdman *et al.*, 1997; Molla *et al.*, 2001). The success of rhizobia as biocontrol organisms has been at best intermittent and it is likely, from the observations made above, to be a property possessed only by certain strains. It needs to be screened for in *Rhizobium* in much the same way that it has been evaluated with *Pseudomonas*. To this point, no such screening has been undertaken.

6. EDAPHIC FACTORS AFFECTING RHIZOBIA

Edaphic factors have long been known to influence soil rhizobia and a number of reviews have already documented the importance of different edaphic stresses to rhizobial persistence, subsequent nodulation, and nitrogen fixation. Stresses considered have included soil acidity (Dilworth *et al.*, 2001; Graham, 1992; Howieson and Ballard, 2004; Slattery *et al.*, 2001; 2004), temperature (Bordeleau and Prevost, 1994; Eaglesham and Ayanaba, 1984; Prevost *et al.*, 2003), nutrient constraints and metal excesses (Dakora and Phillips, 2002; Hirsch *et al.*, 1993; O'Hara, 2001), and salt or osmotic stress (El Sheikh, 1998; Miller and Wood, 1996; Zahran, 1999). Giller (2001) also provides a general overview of environmental constraints to nodulation and nitrogen fixation. As indicative of the importance of environmental stresses to rhizobia, Brockwell *et al.* (1991) noted an average of 89,000 *S. meliloti* g⁻¹ soil in soils of pH >7.0, but only 37 of these organisms g⁻¹ in soils of pH <6.0. Similar changes were noted by Slattery *et al.* (2004) for *R. leguminosarum* by *viciae* and *M. ciceri*, however, populations of *Bradyrhizobium* increased as pH declined. Even such declines in cell numbers with pH do not tell the whole story because, where rhizobia have been recovered from acid soil, they have often proven to be acid-sensitive, of only limited function, and restricted in soil to niches of above average pH (Richardson and Simpson, 1988; 1989).

Change in soil pH, temperature, or nutrient status can also favor the competitive ability and nodule frequency of specific rhizobia. Thus, Voss *et al.* (1984) recovered strain CAR43 from 65% of nodules on *P. vulgaris* in a soil of pH 5.1, but from less than 1% of nodules at pH 6.7, whereas the acid-tolerant *R. tropici* strain CIAT899 is recognized for much greater competitive ability at acid pH than at pH 7.0 (Frey and Blum, 1994; Streit *et al.*, 1995; Vargas and Graham, 1989). In contrast, Yang *et al.* (2001) noted enhanced nodule occupancy by fast-growing soybean rhizobia at alkaline pH. Cold- and heat-tolerant isolates have also been reported in a number of studies (Drouin *et al.*, 2000; Eaglesham and Ayanaba, 1984;

Ek Jander and Fahraeus, 1971; Prevost *et al.*, 2003; Zhang *et al.*, 2002), with G. Catroux (personal communication) noting that rhizosphere bacteria isolated from soybean at 12°C are very different to those recovered at 28°C. Acid- (Aarons and Graham, 1991; Ballen *et al.*, 1998; Vinuesa *et al.*, 2003), temperature- (Drouin *et al.*, 2000; Michiels *et al.*, 1994; Narberhaus *et al.*, 1998, Ono *et al.*, 2001), nutrient stress- (Al Niemi *et al.*, 1997; Smart *et al.*, 1984; Summers *et al.*, 1998), and osmotic shock-proteins have been identified in rhizobia and, undoubtedly, will become the focus of further genetic and informatic analysis (Dilworth *et al.*, 2001).

Although numerous examples are given above, the number that involves environmental stress at a population level is limited. Anyango *et al.* (1995) examined the diversity of bean rhizobia in two Kenyan soils that differed in pH. In the Naivasha soil (pH 6.8), 40 of 41 isolates corresponded to *R. etli*, whereas at Dakaini (pH 4.5), 35 of the isolates tested were *R. tropici*. Strains of *R. tropici* are common in Brazilian bean soils (Grange and Hungria, 2004; Hungria *et al.*, 1997) and, because of their greater pH and temperature tolerance (Graham *et al.*, 1982; 1994; Martinez-Romero *et al.*, 1991; Michiels *et al.*, 1994), have been emphasized in bean-inoculant strain-selection programs for the Brazilian Cerrados (Hungria *et al.*, 2000; 2003; Mostasso *et al.*, 2002). Surprisingly, Andrade *et al.* (2002) also recovered relatively high numbers of *R. leguminosarum* from acid bean soils in Brazil that had been limed to pH values of 4.12 to 4.68, with an index of richness based on ITS groups increasing from 2.2 to 5.7 along the lime-application gradient. In initial studies that we have undertaken, *R. tropici* IIA and IIB isolates did not appear to differ markedly in acid-pH and temperature tolerance, although the latter were generally more resistant to streptomycin and captan (Bernal *et al.*, 2004) and tolerated Apronmax-fungicide seed treatment. Nutrient supply, including heavy metal excess, can also influence both rhizobial and mycorrhizal community structure (Hirsch *et al.*, 1993; Vandenkoornhuyse *et al.*, 2003; I. Christiansen, as cited by Graham *et al.*, 2003).

Genotype x environment interaction is a recognized part of plant breeding with superior genotypes expected to perform well across a range of environments (Edmeades *et al.*, 2004). Sessitsch *et al.* (2002) suggest that the same approach is needed in rhizobial-strain selection. Because plants may also contribute to strain response, for example in nodulation at acid pH (Vargas and Graham, 1988; Howieson *et al.*, 2000), this approach needs to be extended to jointly consider host and *Rhizobium* in relation to the environment. Rhizobial strains exhibit different levels of adaptation to soil stress and, as with plants, may differ in the mechanisms contributing to this adaptation. Citing acidity as an example, Sessitsch *et al.* (2002) suggest that strains, which are acid-tolerant in the laboratory, may vary in tolerance under field conditions because of variation in the intensity of the different factors contributing to acid soil-stress. They suggest the “cross-row technique” (Howieson and Ewing, 1986) as a means of testing rhizobial survival and colonization ability in target soils. This works well in evaluating individual strains for use as inoculants, however, either where there are host-specificity and/or symbiotic differences or where the soils have abundant indigenous rhizobia, a rhizobial population approach to this test could have value. One example might include a contrast between the relatively acid-tolerant *Medicago murex* and the sensitive *M. sativa* (Cheng *et al.*,

2002, 2004) and another involve soybean inoculant-strain persistence and the change in soils of the Brazilian Cerrado (Hungria *et al.*, 2006a).

7. FUTURE DIMENSIONS OF RHIZOBIAL ECOLOGY

As this review differs from some earlier ones in its emphasis on advances made using population approaches, so too are the future dimensions of rhizobial ecology likely to be very different from approaches discussed here. In the short term, we can expect a much greater emphasis on host/*Rhizobium* interaction and the consequences for rhizobial population size, spatial distribution, and specific function. Although “competition” for nodulation sites is currently understudied, the ability to undertake studies with populations of rhizobia should rapidly enhance our knowledge of the control of nodule-strain occupancy. A balance will have to be struck between culture-dependent and culture-independent approaches, but it is likely that the latter will become increasingly important and sophisticated.

Kent and Triplett (2002) highlight pioneering studies across the field of microbial ecology, including the effect of rhizobiatoxin production on sensitive members of the *P. vulgaris* rhizosphere community as estimated using ribosomal intergenic spacer analysis (Robledo *et al.*, 1998). They also note the study of Schallmach *et al.* (2000) in which low N conditions enhanced the proportion of α -proteobacteria relative to other bacteria in the area of the root tip. Similarly, Leveau and Lindow (2002) review the role of recently developed bioreporter molecules in microbial ecology, whereas Persello-Cartieaux *et al.* (2003) note research opportunities opened by molecular signaling effected by plant perception of eubacterial flagellins.

Finally, microbial-community dynamics have been linked to rhizosphere carbon flow through the pairing of ^{13}C stable-isotope pulse labeling and analysis of phospholipid fatty acids (Griffiths *et al.*, 2004; Lu *et al.*, 2004; Treonis *et al.*, 2004). These and other techniques still in development should enable us to focus on individual organisms in both the soil and rhizosphere and monitor the effect of plant and environmental factors on their activity and interaction with other organisms.

REFERENCES

- Aarons, S. R., and Graham, P. H. (1991). Response of *Rhizobium leguminosarum* bv *phaseoli* to acidity. *Plant Soil*, 134, 145-151.
- Abaidoo, R. C., Keyser, H. H., Singleton, P. W., and Borthakur, D. (2000). *Bradyrhizobium* spp. (TGx) isolates nodulating the new soybean cultivars in Africa are diverse and distinct from bradyrhizobia that nodulate North American soybeans. *Int. J. Syst. Evol. Microbiol.*, 50, 225-234.
- Abaidoo, R. C., Keyser, H. H., Singleton, P. W., and Borthakur, D. (2002). Comparison of molecular and antibiotic resistance profile methods for the population analysis of *Bradyrhizobium* spp. (TGx) isolates that nodulate the new TGx soybean cultivars in Africa. *J. Appl. Microbiol.*, 92, 109-117.
- Achouak, W., Christen, R., Barakat, M., Martel, M. H., and Heulin, T. (1999). *Burkholderia caribensis* sp. nov., an exopolysaccharide-producing bacterium isolated from vertisol microaggregates in Martinique. *Int. J. Syst. Bacteriol.*, 49, 787-794.
- Aguilar, O. M., Lopez, M. V., Riccillo, P. M., Gonzalez, R. A., Pagano, M., Grasso, D. H., *et al.* (1998). Prevalence of the *Rhizobium etli*-like allele in genes coding for 16S rRNA among the indigenous

- rhizobial populations found associated with wild beans from the southern Andes in Argentina. *Appl. Environ. Microbiol.*, *64*, 3520-3524.
- Aguilar, O. M., Riva, O., and Peltzer, E. (2004). Analysis of *Rhizobium etli* and of its symbiosis with wild *Phaseolus vulgaris* supports coevolution in centers of host diversification. *Proc. Nat. Acad. Sci. USA*, *101*, 13548-13553.
- Alexander, M. (1982). Ecology of *Rhizobium*. In M. Alexander (Ed.), *Biological nitrogen fixation. Ecology, technology and physiology* (pp. 39-50). New York, NY: Plenum Press.
- Al Niemi, T. S., Summers, M. L., Elkins, J. G., Kahn, M. L., and McDermott, T. R. (1997). Regulation of the phosphate stress response in *Rhizobium meliloti* by *PhoB*. *Appl. Environ. Microbiol.*, *63*, 4978-4981.
- Amarger, N. (2001). Rhizobia in the field. *Adv. Agron.*, *73*, 109-168.
- Amarger, N., Bours, M., Revoy, F., Allard, M. R., and Laguerre, G. (1994). *Rhizobium tropici* nodulates field-grown *Phaseolus vulgaris* in France. *Plant Soil*, *161*, 147-156.
- Amarger, N., Macheret, V., and Laguerre, G. (1997). *Rhizobium gallicum* sp. nov. and *Rhizobium giardinii* sp. nov. from *Phaseolus vulgaris* nodules. *Int. J. Syst. Bacteriol.*, *47*, 996-1006.
- Andrade, D. S., Murphy, P. J., and Giller, K. E. (2002). The diversity of *Phaseolus*-nodulating rhizobial populations is altered by liming of acid soils planted with *Phaseolus vulgaris* L. in Brazil. *Appl. Environ. Microbiol.*, *68*, 4025-4034.
- Antipchuk, A. F., and Kosenko, L. V. (2004). The influence of lipopolysaccharides and glucans from two *Rhizobium leguminosarum* bv *viciae* strains on the formation and efficiency of their symbioses with pea plants. *Mikrobiologiya*, *73*, 51-55.
- Antonovics, J. (1976). The input from population genetics: "The new ecological genetics". *Syst. Bot.*, *1*, 233-245.
- Anyango, B., Wilson, K. J., Beynon, J. L., and Giller, K. E. (1995). Diversity of rhizobia nodulating *Phaseolus vulgaris* L. in two Kenyan soils with contrasting pHs. *Appl. Environ. Microbiol.*, *61*, 4016-4021.
- Baer, S. G., Blair, J. M., Collins, S. L., and Knapp, A. K. (2003). Soil resources regulate productivity and diversity in newly established tallgrass prairie. *Ecol.*, *84*, 724-735.
- Baldwin, I. L., and Fred, E. B. (1929). Nomenclature of the root nodule bacteria of the leguminosae. *J. Bacteriol.*, *17*, 141-150.
- Ballen, K. G., Graham, P. H., Jones, R. K., and Bowers, J. H. (1998). Acidity and calcium interaction affecting cell envelope stability in *Rhizobium*. *Can. J. Microbiol.*, *44*, 582-587.
- Bardin, S. D., Huang, H. C., Pinto, J., Amundsen, E. J., and Erickson, R. S. (2004) Biological control of *Pythium* damping off of pea and sugar beet by *Rhizobium leguminosarum* bv *viciae*. *Can. J. Bot.*, *82*, 291-296.
- Bauer, W. D., and Teplitski, M. (2001). Can plants manipulate bacterial quorum sensing? *Aust. J. Plant Physiol.*, *28*, 913-921.
- Beebe, S., Skroch, P. W., Tohme, J., Duque, M. C., Pedraza, F., and Nienhuis, J. (2000). Structure of genetic diversity among common bean landraces of Middle American origin based on correspondence analysis of RAPD. *Crop Sci.*, *40*, 264-273.
- Bergersen, F. J. (1958). The bacterial component of soybean root nodules: Changes in respiratory activity, cell dry weight and nucleic acid content with increasing nodule age. *J. Gen. Microbiol.*, *19*, 312-323.
- Bernal, G. (1993). Characterization of Ecuadorian and Argentinean bean rhizobia and their specificity with *Phaseolus vulgaris* from different gene pools. M.S. thesis, University of Minnesota, MN, USA.
- Bernal, G., and Graham, P. H. (2001). Diversity in the rhizobia associated with *Phaseolus vulgaris* L. in Ecuador, and comparisons with Mexican bean landraces. *Can. J. Microbiol.*, *47*, 526-534.
- Bernal, G. R., Tlusty, B., Estevez de Jensen, C., van Berkum, P., and Graham, P. H. (2004). Characteristics of rhizobia nodulating beans in the central region of Minnesota. *Can. J. Microbiol.*, *50*, 1023-1031.
- Bever, J. D., Westover, K. M., and Antonovics, J. (1997). Incorporating the soil community into plant population dynamics: the utility of the feedback approach. *J. Ecol.*, *85*, 561-573.
- Bever, J. D., and Simms, E. L. (2000). Evolution of nitrogen fixation in spatially structured populations of *Rhizobium*. *Heredity*, *85*, 366-372.
- Beyene, D., Kassa, S., Ampy, F., Asseffa, A., Gebremedhin, T., and van Berkum, P. (2004). Ethiopian soils harbor natural populations of rhizobia that form symbioses with common bean (*Phaseolus vulgaris* L.). *Arch. Microbiol.*, *181*, 129-136.

- Beyhaut, E., Tlustý, B., van Berkum, P., and Graham, P. H. (2006). *Rhizobium giardinii* is the microsymbiont of Illinois Bundleflower (*Desmanthus illinoensis* (Michx.) Macmillan) in midwestern prairies. *Can. J. Microbiol.*, *52*, 903-907.
- Beynon, J. L., and Josey, D. P. (1980). Demonstration of heterogeneity in a natural population of *Rhizobium phaseoli* using variation in intrinsic antibiotic resistance. *J. Gen. Microbiol.*, *118*, 437-442.
- Bhuvaneswari, T. V., Bhagwat, A. A., and Bauer, W. D. (1981). Transient susceptibility of root cells in four legumes to nodulation by rhizobia. *Plant Physiol.*, *68*, 1144-1149.
- Bhuvaneswari, T. V., Turgeon, B. G., and Bauer, W. D. (1980). Early events in the infection of soybean (*Glycine max* L. Merr.) by *Rhizobium japonicum*. I. Localization of infectible root cells. *Plant Physiol.*, *66*, 1027-1031.
- Bieberdeck, V. O., Lupwayi, N. Z., Hanson, K. G., Rice, W. A., and Zentner, R. P. (2000). Effect of long-term rotation with lentils on rhizosphere ecology and on endophytic rhizobia in wheat. XVIIth North American Conference on Symbiotic Nitrogen Fixation, Quebec, Canada, p. 80.
- Biswas, J. C., Ladha, J. K., Dazzo, F. B., Yanni, Y. G., and Rolfe, B. G. (2000). Rhizobial inoculation influences seedling vigor and yield of rice. *Agron. J.*, *92*, 880-886.
- Blumenthal, D. M., Jordan, N. R., and Russelle, M. P. (2003). Soil carbon addition controls weeds and facilitates prairie restoration. *Ecol. Applic.*, *13*, 605-615.
- Bobbink, R., Hornung, M., and Roelofs, J. G. M. (1998). The effects of air-borne nitrogen pollutants on species diversity in natural and semi-natural European vegetation. *J. Ecol.*, *86*, 717-738.
- Bohlool, B. B., and Schmidt, E. L. (1973). Persistence and competition aspects of *Rhizobium japonicum* observed in soil by immunofluorescence microscopy. *Soil Sci. Soc. Am. J.*, *37*, 561-564.
- Boivin, C., Ndoye, I., Lortet, G., Ndiaye, A., de Lajudie, P., and Dreyfus, B. (1997). The *Sesbania* root symbionts *Sinorhizobium saheli* and *S. teranga* bv *sesbaniae* can form stem nodules on *Sesbania rostrata*, although they are less adapted to stem nodulation than *Azorhizobium caulinodans*. *Appl. Environ. Microbiol.*, *63*, 1040-1047.
- Bordeleau, L. M., and Prevost, D. (1994). Nodulation and nitrogen fixation in extreme environments. *Plant Soil*, *161*, 115-125.
- Brockwell, J., Pilka, A., and Holliday, R. A. (1991). Soil pH is a major determinant of the numbers of naturally occurring *Rhizobium meliloti* in non-cultivated soils in central New South Wales. *Aust. J. Exp. Agric.*, *31*, 211-219.
- Brye, K. R., Norman, J. M., and Gower, S. T. (2002). Assessing the progress of a tallgrass prairie restoration in Southern Wisconsin. *Amer. Midl. Nat.*, *148*, 218-235.
- Buendia-Claveria, A. M., Rodriguez-Navarro, D. N., Santamaria-Linaza, C., Ruiz-Sainz, J. E., and Temprano-Vera, F. (1994). Evaluation of the symbiotic properties of *Rhizobium fredii* in European soils. *Syst. Appl. Microbiol.*, *17*, 155-160.
- Burdman, S., Kigel, J., and Okon, Y. (1997). Effects of *Azospirillum brasilense* on nodulation and growth of common bean (*Phaseolis vulgaris* L.). *Soil Biol. Biochem.*, *29*, 923-929.
- Burns, R. C., and Hardy, R. W. F. (1975). *Nitrogen fixation in bacteria and higher plants*. Berlin, Germany: Springer Verlag (189 pp.).
- Bushby, H. V. A. (1982). Ecology. In W. J. Broughton (Ed.), *Nitrogen fixation Vol. 2: Rhizobium* (pp. 34-75). Oxford, UK: Clarendon Press.
- Camacho, M., Santamaria, C., Temprano, F., Rodriguez-Navarro, D. N., Daza, A., Espuny, R., et al. (2002). Soils of the Chinese Hubei province show a very high diversity of *Sinorhizobium fredii* strains. *Syst. Appl. Microbiol.*, *25*, 592-602.
- Chabot, R., Antoun, H., and Cescas, M. P. (1996). Growth promotion of maize and lettuce by phosphate-solubilizing *Rhizobium leguminosarum* biovar *phaseoli*. *Plant Soil*, *184*, 311-321.
- Chaintreuil, C., Giraud, E., Prin, Y., Lorquin, J., Ba, A., Gillis, M., et al. (2000). Photosynthetic bradyrhizobia are natural endophytes of the African wild rice *Oryza breviligulata*. *Appl. Environ. Microbiol.*, *66*, 5437-5447.
- Chaverra, M. H., and Graham, P. H. (1992). Cultivar variation in traits affecting early nodulation of common bean. *Crop Sci.*, *32*, 1432-1436.
- Chen, L. S., Figueredo, A., Villani, H., Michajluk, J., and Hungria, M. (2002). Diversity and symbiotic effectiveness of rhizobia isolated from field-grown soybean nodules in Paraguay. *Biol. Fertil. Soils*, *35*, 448-457.
- Chen, W. M., James, E. K., Chou, J. H., Sheu, S. Y., Yang, S. Z., and Sprent, J. I. (2005). beta-Rhizobia from *Mimosa pigra*, a newly discovered invasive plant in Taiwan. *New Phytol.*, *168*, 661-675.

- Chen, W. M., Laevens, S., Lee, T. M., Coenye, T., de Vos, P., Mergeay, M., *et al.* (2001). *Ralstonia taiwanensis* sp. nov., isolated from root nodules of *Mimosa* species and sputum of a cystic fibrosis patient. *Int. J. Syst. Evol. Microbiol.*, *51*, 1729-1735.
- Chen, W. M., Moulin, L., Bontemps, C., Vandamme, P., Bena, G., and Boivin-Masson, C. (2003). Legume symbiotic nitrogen fixation by beta proteobacteria is widespread in nature. *J. Bacteriol.*, *185*, 7266-7272.
- Chen, W. X., Li, G. S., Qi, Y. L., Wang, E. T., Yuan, H. L., and Li, J. L. (1991). *Rhizobium huakuii* sp. nov. isolated from the root nodules of *Astragalus sinicus*. *Int. J. Syst. Bacteriol.*, *41*, 275-280.
- Chen, W. X., Tan, Z. Y., Gao, J. L., Li, Y., and Wang, E. T. (1997). *Rhizobium hainanense* sp. nov. isolated from tropical trees. *Int. J. Syst. Bacteriol.*, *47*, 870-873.
- Chen, W. X., Wang, E. T., Wang, S. Y., Li, Y. B., Chen, X. Q., and Li, Y. (1995). Characteristics of *Rhizobium tianshanense*, sp. nov., a moderately and slowly growing root nodule bacterium isolated from an arid saline environment in Xinjiang, People's Republic of China. *Int. J. Syst. Bacteriol.*, *45*, 153-159.
- Chen, W. X., Yan, G. H., and Li, J. L. (1988). Numerical taxonomic study of fast-growing soybean rhizobia and a proposal that *Rhizobium fredii* be assigned to *Sinorhizobium* gen. nov. *Int. J. Syst. Bacteriol.*, *38*, 392-397.
- Cheng, Y., Howieson, J. G., O'Hara, G. W., Watkin, E. L. J., Souche, G., Jaillard, B., *et al.* (2004). Proton release by roots of *Medicago murex* and *Medicago sativa* growing in acidic conditions, and implications for rhizosphere pH changes and nodulation at low pH. *Soil Biol. Biochem.*, *36*, 1357-1365.
- Cheng, Y., Watkin, E. L. J., O'Hara, G. W., and Howieson, J. G. (2002). *Medicago sativa* and *Medicago murex* differ in the nodulation response to soil acidity. *Plant Soil*, *238*, 31-39.
- Dakora, F. D., and Phillips, D. A. (2002). Root exudates as mediators of mineral acquisition in low-nutrient environments. *Plant Soil*, *245*, 35-47.
- Dangeard, P. A. (1926). Recherches sur les tubercules radicaux des legumineuses. *Le Botaniste Series* 16, Paris (270 pp.).
- Dart, P. J. (1977). Infection and development of leguminous nodules. In R. W. F. Hardy and W. S. Silver (Eds.) *A Treatise on nitrogen fixation, Section 3: Biology* (pp. 367-472). New York, NY: John Wiley and Sons.
- De Lajudie, P., Laurent-Fulele, E., Willems, A., Torck, U., Coopman, R., Collins, M. D., *et al.* (1998a). *Allorhizobium undicola* gen. nov., sp. nov., nitrogen fixing bacteria that efficiently nodulate *Neptunia natans* in Senegal. *Int. J. Syst. Bacteriol.*, *48*, 1277-1290.
- De Lajudie, P., Willems, A., Nick, G., Moreira, F., Moulouba, F., Hoste, B., *et al.* (1998b). Characterization of tropical tree rhizobia and description of *Mesorhizobium plurifarum* sp. nov. *Int. J. Syst. Bacteriol.*, *48*, 369-382.
- De Lajudie, P., Willems, A., Pot, B., Dewettinck, D., Maestrojuan, G., Neyra, M., *et al.* (1994). Polyphasic taxonomy of rhizobia: Emendation of the genus *Sinorhizobium* and description of *Sinorhizobium meliloti* comb. nov., *Sinorhizobium saheli* sp. nov., and *Sinorhizobium teranga* sp. nov. *Int. J. Syst. Bacteriol.*, *44*, 715-733.
- Delannay, X., Rodgers, D. M., and Palmer, R. G. (1983). Relative genetic contributions among ancestral lines to North American soybean cultivars. *Crop Sci.*, *23*, 944-949.
- Denison, R. F., and Kiers, E. T. (2004). Lifestyle alternatives for rhizobia: Mutualism, parasitism and forgoing symbiosis. *FEMS Microbiol. Lett.*, *237*, 187-193.
- Devine, T. E. (1984). Genetics and breeding of nitrogen fixation. In M. Alexander (Ed.) *Biological nitrogen fixation. Ecology, technology and physiology* (pp. 127-154). New York, NY: Plenum Press.
- Diatloff, A. (1969). The introduction of *Rhizobium japonicum* to soil by seed inoculation of non-host legumes and cereals. *Aust. J. Exp. Agric. Anim. Husb.*, *9*, 357-360.
- Dilworth, M. J., Carson, K. C., Giles, R. G. F., Byrne, L. T., and Glenn, A. R. (1998). *Rhizobium leguminosarum* bv *viciae* produces a novel cyclic trihydroxamate siderophore, vicibactin. *Microbiology*, *144*, 781-791.
- Dilworth, M. J., Howieson, J. G., Reeve, W. G., Tiwari, R. P., and Glenn, A. R. (2001). Acid tolerance in root nodule bacteria and selecting for it. *Aust. J. Exp. Agric.*, *41*, 435-446.
- Diouf, A., Lajudie, P., Neyra, M., Kersters, K., Gillis, M., Martinez-Romero, E., and Gueye, M. (2000). Polyphasic characterization of rhizobia that nodulate *Phaseolus vulgaris* in West Africa (Senegal and Gambia). *Int. J. Syst. Evol. Microbiol.*, *50*, 159-170

- Dowdle, S. F., and Bohlool, B. B. (1985). Predominance of fast-growing *Rhizobium japonicum* in a soybean field in the People's Republic of China. *Appl. Environ. Microbiol.*, *50*, 1171-1176.
- Dreyfus, B., Garcia, J. L., and Gillis, M. (1988). Characterization of *Azorhizobium caulinodans* gen.nov., sp. nov. a stem-nodulating nitrogen-fixing bacterium isolated from *Sesbania rostrata*. *Int. J. Syst. Bacteriol.*, *38*, 89-98.
- Drouin, P., Prevost, D., and Antoun, H. (2000). Physiological adaptation to low temperatures of strains of *Rhizobium leguminosarum* bv *viciae* associated with *Lathyrus* spp. *FEMS Microbiol. Ecol.*, *32*, 111-120.
- Dunigan, E. P., Bollich, P. K., Hutchinson, R. L., Hicks, P. M., Zaunbrecher, F. C., et al. (1984). Introduction and survival of an inoculant strain of *Rhizobium japonicum* in soil. *Agron. J.*, *76*, 463-466.
- Eaglesham, A. R. J., and Ayanaba, A. (1984). Tropical stress ecology of rhizobia, root nodulation and legume fixation. In N. S. Subba Rao (Ed.), *Current developments in biological nitrogen fixation* (pp. 1-35). London, UK: Edward Arnold Publishers.
- Eardly, B. D., Materon, L. A., Smith, N. H., Johnson, D. A., Rumbaugh, M. D., and Selander, R. K. (1990). Genetic structure of natural populations of the nitrogen-fixing bacterium *Rhizobium meliloti*. *Appl. Environ. Microbiol.*, *56*, 187-194.
- Eardly, B. D., Wang, F. S., Whittam, T. S., and Selander, R. K. (1995). Species limits in *Rhizobium* populations that nodulate the common bean (*Phaseolus vulgaris*). *Appl. Environ. Microbiol.*, *61*, 507-512.
- Eardly, B., and van Berkum, P. (2004). Use of population genetic structure to define species limits in the *Rhizobiaceae*. *Symbiosis*, *38*, 109-122.
- Edmeades, G. O., McMaster, G. S., White, J. W., and Campos, H. (2004). Genomics and the physiologist: Bridging the gap between genes and crop response. *Field Crops Res.*, *90*, 5-18.
- Ek Jander, J., and Fahraeus, G. (1971). Adaptation of *Rhizobium* to subarctic environment in Scandinavia. *Plant Soil, Spec. Vol.*, 129-137.
- Elliott, G. N., Chen, W. M., Chou, J-H., Wang, H-C., Sheu, S-Y, Perin, L., et al. (2007) *Burkholderia phymatum* is a highly effective nitrogen-fixing symbiont of *Mimosa* spp. and fixes nitrogen *ex planta*. *New Phytol.*, *173*, 168-180.
- El Sheikh, E. A. E. (1998). Effects of salt on rhizobia and bradyrhizobia: A review. *Ann. Appl. Biol.*, *132*, 507-524.
- Essalmani, H., and Lahlou, H. (2003). Bioprotection mechanisms of the lentil plant by *Rhizobium leguminosarum* against *Fusarium oxysporum* f. sp. *lentis*. *C.R. Biol.*, *326*, 1163-1173.
- Estevez de Jensen, C., Kurle, J. E., Percich, J. A., and Graham, P. H. (2002). Integrated management strategies of bean root rot with *Bacillus subtilis* and *Rhizobium* in Minnesota. *Field Crops Res.*, *74*, 107-115.
- Ettema, C. H., and Wardle, D. A. (2002). Spatial soil ecology. *Trends Ecol. Evol.*, *17*, 177-183.
- Evans, J., Eberbach, P., Lockett, D., and Cormack S. (2001). Pre-season soil establishment of legume inoculant rhizobia is not effective for the nodulation of lupin and faba bean crops in acidic soils. *Aust. J. Exp. Agric.*, *41*, 1149-1160.
- Fahraeus, G., and Ljunggren, H. (1968). Pre-infection phases of the legume symbiosis. In T. R. G. Gray and D. Parkinson (Eds.), *The Ecology of soil bacteria* (pp. 396-421). Liverpool, UK: Liverpool University Press.
- Ferreira, M. C., Andrade, D. D., Chueire, L. M. D., Takemura, S. M., and Hungria, M. (2000). Tillage method and crop rotation effects on population sizes and diversity of bradyrhizobia nodulating soybean. *Soil Biol. Biochem.*, *32*, 627-637.
- Ferrey, M. L., Graham, P. H., and Russelle, M. P. (1994). Nodulation efficiency of *Bradyrhizobium japonicum* strains with genotypes of soybean varying in the ability to restrict nodulation. *Can. J. Microbiol.*, *40*, 456-460.
- Firmin, J. L., Wilson, K. E., Carlson, R. W., Davies, A. E., and Downie, J. A. (1993). Resistance to nodulation of cv Afghanistan peas is overcome by *nodX*, which mediates an O-acetylation of the *Rhizobium leguminosarum* lipo-oligosaccharide nodulation factor. *Mol. Microbiol.*, *10*, 351-360.
- Fray, R. G. (2002). Altering plant-microbe interaction through artificially manipulating bacterial quorum sensing. *Ann. Bot.*, *89*, 245-253.
- Fred, E. B., Baldwin, I. L., and McCoy, E. (1932). Root nodule bacteria and leguminous plants. Madison, WI: University of Wisconsin Press (332 pp.).

- Frey, S. D., and Blum, L. K. (1994). Effect of pH on competition for nodule occupancy by Type 1 and Type 11 strains of *Rhizobium leguminosarum* bv *phaseoli*. *Plant Soil*, *163*, 157-164.
- Galli-Terasawa, L. V., Glienke-Blanco, C., and Hungria, M. (2003). Diversity of a soybean rhizobial population adapted to a Cerrados soil. *World J. Microbiol. Biotechnol.*, *19*, 933-939.
- Gao, J. L., Turner, S. L., Kan, F. L., Wang, E. T., Tan, Z. Y., Qui, Y. H., *et al.* (2004). *Mesorhizobium septentrionale* and *Mesorhizobium temperatum* isolated from *Astragalus adsurgens* growing in the northern regions of China. *Int. J. Syst. Evol. Microbiol.*, *54*, 2003-2012.
- Gao, M., Teplitski, M., Robinson, J. B., and Bauer, W. D. (2003). Production of substances by *Medicago truncatula* that affect bacterial quorum sensing. *Mol. Plant-Microbe Interact.*, *16*, 827-834.
- García-Plazaola, J. I., Becerril, J. M., Arrese-Igor, C., Gonzalez-Murua, C., and Aparicio-Tejo, P. M. (1993). The contribution of *Rhizobium meliloti* to soil denitrification. *Plant Soil*, *157*, 207-213.
- Geniaux, E., Laguerre, G., and Amarger, N. (1993). Comparison of geographically distant populations of *Rhizobium* isolated from root nodules of *Phaseolus vulgaris*. *Mol. Ecol.*, *2*, 295-302.
- Gepts, P. (1988a). Phaseolin as an evolutionary marker. In P. Gepts (Ed.), *Genetic resources of Phaseolus beans* (pp. 215-241). Dordrecht, The Netherlands: Kluwer Academic Publishers.
- Gepts, P. (1988b). A middle American and an Andean common-bean gene pool. In P. Gepts (Ed.), *Genetic resources of Phaseolus beans* (pp. 375-390). Dordrecht, The Netherlands: Kluwer Academic Publishers.
- Gibson, A. H., Date, R. A., Ireland, J. A., and Brockwell, J. (1976). A comparison of competitiveness and persistence among five strains of *Rhizobium trifolii*. *Soil Biol. Biochem.*, *8*, 395-401.
- Giller, K. E. (2001). *Nitrogen fixation in tropical cropping systems*. Wallingford, UK: CABI Publishing (423 pp.).
- Graham, P. H. (1973). Plant-*Rhizobium* interaction and its importance to agriculture. In A. M. Srb, (Ed.), *Genes, enzymes and populations* (pp. 321-330). New York, NY: Plenum Publishing.
- Graham, P. H. (1992). Stress tolerance in *Rhizobium* and *Bradyrhizobium*, and nodulation under adverse soil conditions. *Can. J. Microbiol.*, *38*, 475-484.
- Graham, P. H., Ballen, K. G., Montealegre, C., Jones, R. H., Fischer, B., and Luque, E. (1999). Characterization of rhizobia associated with *Dalea* spp. in natural prairies and revegetation areas in Minnesota. In E. Martinez and G. Hernandez (Eds.) *Highlights of nitrogen fixation* (pp. 69-75). New York, NY: Kluwer Academic/Plenum Press.
- Graham, P. H., Draeger, K. J., Ferrey, M L., Conroy, M. J., Hammer, B. E., Martinez-Romero, E., *et al.* (1994). Acid pH tolerance in strains of *Rhizobium* and *Bradyrhizobium*, and initial studies on the basis for acid tolerance of *Rhizobium tropici* UMR 1899. *Can. J. Microbiol.*, *40*, 198-207.
- Graham, P. H., and McDermott, T. R. (1989). *Bradyrhizobium*, root and rhizosphere interactions to improve soybean productivity. In R. D. Munson (Ed.), *The Physiology, biochemistry, nutrition and bioengineering of soybeans: Implications for future management* (pp. 1-21). St. Louis, MO: FAR/PPI.
- Graham, P. H., Rosas, J. C., Estevez de Jensen, C., Peralta, E., Tlustý, B., Acosta-Gallegas, J., *et al.* (2003). Addressing edaphic constraints to bean production: The bean/cowpea CRSP project in perspective. *Field Crops Res.*, *82*, 179-192.
- Graham, P. H., Sadowsky, M. J., Keyser, H. H., Barnet, M., Bradley, R. S. Cooper, J. E., *et al.* (1991). Proposed minimal standards for the description of new genera and species of root- and stem-nodulating bacteria. *Int. J. Syst. Bacteriol.*, *41*, 582-587.
- Graham, P. H., Viteri, S. E., Mackie, F., Vargas, A. T., and Palacios, A. (1982). Variation in acid soil tolerance among strains of *Rhizobium phaseoli*. *Field Crops Res.*, *5*, 121-128.
- Grange, L., and Hungria, M. (2004). Genetic diversity of indigenous common bean (*Phaseolus vulgaris*) rhizobia in two Brazilian ecosystems. *Soil. Biol. Biochem.*, *36*, 1389-1398.
- Grayston, S. J., Campbell, C. D., Bardgett, R. D., Mawdsley, J. L., Clegg, C. D., Ritz, K., *et al.* (2004). Assessing shifts in microbial community structure across a range of grasslands of different management intensity using CLPP, PLFA and community DNA techniques. *Appl. Soil Ecol.*, *25*, 63-84.
- Grayston, S. J., Griffith, G. S., Mawdsley, J. L., Campbell, C. D., and Bardgett, R. D. (2001). Accounting for variability in soil microbial communities of temperate upland grassland ecosystems. *Soil Biol. Biochem.*, *33*, 533-551.
- Griffiths, R. I., Maneffield, M., Ostle, N., McNamara, N., O'Donnell, A. G., Bailey, M. J., *et al.* (2004). ¹³C₂ pulse labeling of plants in tandem with stable isotope probing: Methodological considerations for examining microbial function in the rhizosphere. *J. Microbiol. Meth.*, *58*, 119-129.

- Gutierrez-Zamora, M. L., and Martinez-Romero, E. (2001). Natural endophytic association between *Rhizobium etli* and maize (*Zea mays* L.). *J. Biotechnol.*, *91*, 117-126.
- Hafeez, F. Y., Safdar, M. E., Chaudhry, A. U., and Malik, K. A. (2004). Rhizobial inoculation improves seedling emergence, nutrient uptake and growth of cotton. *Aust. J. Exp. Agric.*, *44*, 617-622.
- Hagen, M. J., and Hamrick, J. L. (1996). Population level processes in *Rhizobium leguminosarum* bv *trifolii*: The role of founder effects. *Mol. Ecol.*, *5*, 707-714.
- Halder, A. K., and Chakrabarty, P. K. (1993). Solubilization of inorganic phosphate by *Rhizobium*. *Folia Microbiol.*, *38*, 325-330.
- Handley, B. A., Hedges, A. J., and Beringer, J. E. (1998). Importance of host plants for detecting the population diversity of *Rhizobium leguminosarum* biovar *viciae* in soil. *Soil Biol. Biochem.*, *30*, 241-249.
- Hart, J. P., and Scarry, C. M. (1999). The age of common beans (*Phaseolus vulgaris*) in the Northeastern United States. *American Antiquity*, *64*, 653-658.
- Herrera-Cervera, J. A., Caballero-Mellado, G., Laguerre, G., Tichy, H. V., Requena, N., Amarger, N., et al. (1999). At least five rhizobial species nodulate *Phaseolus vulgaris* in a Spanish soil. *FEMS Microbiol. Ecol.*, *30*, 87-97.
- Hilali, A., Prevost, D., Broughton, W. J., and Antoun, H. (2001). Effects of inoculation with strains of *Rhizobium leguminosarum* biovar *trifolii* on the growth of wheat in two different soils from Morocco. *Can. J. Microbiol.*, *47*, 590-593.
- Hirsch, A. M., Bauer, W. D., Bird, D. M., Cullimore, J., Tyler, B., and Yoder, J. I. (2003). Molecular signals and receptors controlling rhizosphere interactions between plants and other organisms. *Ecology*, *84*, 858-868.
- Hirsch, P. R., Jones, M. J., McGrath, S. P., and Giller, K. E. (1993). Heavy metals from past applications of sewage sludge decrease the genetic diversity of *Rhizobium leguminosarum* biovar *trifolii* populations. *Soil Biol. Biochem.*, *25*, 1485-1490.
- Hoflich, G., Wiehe, W., and Hecht-Buchholz, C. (1995). Rhizosphere colonization of different crops with growth-promoting *Pseudomonas* and *Rhizobium* bacteria. *Microbiol. Res.*, *150*, 139-147.
- Hogg, B., Davies, A. E., Wilson, K. E., Bisseling, T., and Downie, J. A. (2002). Competitive nodulation blocking of cv Afghanistan pea is related to high levels of nodulation factors made by some strains of *Rhizobium leguminosarum* bv *viciae*. *Mol. Plant-Microbe Interact.*, *15*, 60-68.
- Horner-Devine, M. C., Carney, K. M., and Bohannan, B. J. M. (2004). An ecological perspective on bacterial diversity. *Proc. Roy. Soc. (London) B*, *271*, 113-122.
- Howieson, J., and Ballard, R. (2004). Optimizing the legume symbiosis in stressful and competitive environments within southern Australia - some contemporary thoughts. *Soil Biol. Biochem.*, *36*, 1261-1273.
- Howieson, J., and Ewing, M. A. (1986). Acid tolerance in the *Rhizobium meliloti*-*Medicago* symbiosis. *Aust. J. Agric. Res.*, *37*, 55-64.
- Howieson, J. G., O'Hara, G. W., and Carr, S. J. (2000). Changing roles for legumes in Mediterranean agriculture: Developments from an Australian perspective. *Field Crops Res.*, *65*, 107-122.
- Hungria, M., Andrade, D. D., Chueire, L. M. D., Probanza, A., Gutierrez-Manero, F. J., and Megias, M. (2000). Isolation and characterization of new efficient and competitive bean (*Phaseolus vulgaris* L.) rhizobia from Brazil. *Soil Biol. Biochem.*, *32*, 1515-1528.
- Hungria, M., Andrade, D. D., Collozzi, A., and Balota, E. L. (1997). Interactions among soil organisms and bean and maize grown in monoculture or intercropped. *Pesq. Agropec. Brasil*, *32*, 807-818.
- Hungria, M., Campo, R. J., and Mendes, I. C. (2003). Benefits of inoculation of the common bean (*Phaseolus vulgaris*) crop with efficient and competitive *Rhizobium tropici* strains *Biol. Fertil. Soils*, *39*, 88-93.
- Hungria, M., Campo, R. J., Mendes, I. C., and Graham, P. H. (2006a). Contribution of biological nitrogen fixation to the N nutrition of grain crops in the tropics; the success of soybean (*Glycine max* L. Merr.) in South America. In R. P. Singh, N. Shankar, and P. K. Jaiwal (Eds.), *Focus on plant agriculture. 1. Nitrogen nutrition in sustainable plant productivity* (pp. 43-93). Houston, TX: Studium Press LLC.
- Hungria, M., Francini, J. C., Campo, R. J., and Graham, P. H. (2006b). The importance of nitrogen fixation to the soybean cropping in South America. In D. Werner and W. E. Newton (Eds.), *Nitrogen fixation in agriculture, forestry, ecology, and the environment* (pp. 25-42). Dordrecht, The Netherlands: Springer.

- Hungria, M., and Vargas, M. A. T. (2000). Environmental factors affecting N₂ fixation in grain legumes in the tropics, with an emphasis on Brazil. *Field Crops Res.*, *65*, 151-164.
- Islam, F. M. A., Basford, K. E., Redden, R. J., Gonzalez, A. V., Kroonenberg, P. M., and Beebe, S. (2002). Genetic variability in cultivated common bean beyond the two major gene pools. *Genet. Resour. Crop Evol.*, *49*, 271-283.
- Jarvis, B. D. W., Pankhurst, C. E., and Patel, J. J. (1982). *Rhizobium loti*, a new species of root nodule bacteria. *Int. J. Syst. Bacteriol.*, *32*, 378-380.
- Jarvis, B. D. W., and Tighe, S. W. (1994). Rapid identification of *Rhizobium* species based on cellular fatty acid analysis. *Plant Soil*, *161*, 31-41.
- Jarvis, B. D. W., van Berkum, P., Chen, W. X., Nour, S. M., Fernandez, M. P., Cleyet-Marel, J. C., and Gillis, M. (1997). Transfer of *Rhizobium loti*, *Rhizobium huakuii*, *Rhizobium ciceri*, *Rhizobium mediterraneum* and *Rhizobium tianshanense* to *Mesorhizobium* gen. nov. *Int. J. Syst. Bacteriol.*, *47*, 895-898.
- Jordan, D. C. (1984). Family III. *Rhizobiaceae* Conn 1938. In N. R. Krieg and J. C. Holt (Eds.), *Bergey's manual of systematic bacteriology, Vol 1* (pp. 234-254). Baltimore, MD: Williams and Wilkins.
- Jourand, P., Giraud, E., Béna, G., Sy, A., Willems, A., Gillis, M., et al. (2004). *Methylobacterium nodulans* nov. sp., for a group of aerobic, facultatively methylotrophic, legume root-nodule forming and nitrogen-fixing bacteria. *Int. J. Syst. Evol. Microbiol.*, *54*, 2269-2273.
- Kaplan, L., and Lynch, T. F. (1999). *Phaseolus* (Fabaceae) in archaeology. AMS radiocarbon dates and their significance for pre-Colombian agriculture. *Econ. Bot.*, *53*, 261-272.
- Kent, A. D., and Triplett, E. W. (2002). Microbial communities and their interactions in soil and rhizosphere ecosystems. *Annu. Rev. Microbiol.*, *56*, 211-236.
- Khalid, A., Arshad, M., and Zahir, Z. A. (2004). Screening plant growth-promoting rhizobacteria for improving growth and yield of wheat. *J. Appl. Microbiol.*, *96*, 473-480.
- Kiers, E. T., Rousseau, R. A., West, S. A., and Denison, R. F. (2003). Host sanctions and the legume-*Rhizobium* mutualism. *Nature (Lond.)*, *425*, 78-81.
- Kinzig, A. P., and Sokolow, R. H. (1994). Human impacts on the nitrogen cycle. *Physics Today*, *47*, 24-31.
- Kipe-Nolt, J. A., and Giller, K. E. (1993). A field evaluation using the ¹⁵N isotope dilution method of lines of *Phaseolus vulgaris* bred for increased nitrogen fixation. *Plant Soil*, *152*, 107-114.
- Kurz, W. G. W., and LaRue, T. A. (1975). Nitrogenase activity in rhizobia in absence of plant host. *Nature (Lond.)*, *256*, 407-409.
- Kuykendall, L. D., Saxena, B., Devine, T. E., and Udell, S. E. (1993). *Bradyrhizobium elkanii* sp. nov. Validation of the publication of new names and new combinations previously effectively published outside the IJSB, List No 45. *Int. J. Syst. Bacteriol.*, *43*, 398-399.
- Lagares, A., Caetano-Anolles, G., Niehaus, K., Lorenzen, J., Ljunggren, H. D., Pühler, A., and Favelukes, G. (1992). A *Rhizobium meliloti* lipopolysaccharide mutant altered in competitiveness for nodulation of alfalfa. *J. Bacteriol.*, *174*, 5941-5952.
- Laguerre, G., Allard, M. R., Revoy, F., and Amarger, N. (1994). Rapid identification of rhizobia by restriction fragment length polymorphism analysis of PCR-amplified 16S rRNA genes. *Appl. Environ. Microbiol.*, *60*, 56-63.
- Laguerre, G., Louvrier, P., Allard, M. R., and Amarger, N. (2003). Compatibility of rhizobial genotypes within natural populations of *Rhizobium leguminosarum* biovar *viciae* for nodulation of host legumes. *Appl. Environ. Microbiol.*, *69*, 2276-2283.
- Lambert, G. R., Cantrell, M. A., Hanus, F. J., Russell, S. A., Haddad, K. R., and Evans, H. J. (1985). Intra- and interspecies transfer and expression of *Rhizobium japonicum* hydrogen uptake genes and autotrophic growth capability. *Proc. Nat. Acad. Sci. USA*, *82*, 3232-3236.
- Leibovitch, S., Migner, P., Zhang, F., and Smith, D. L. (2001). Evaluation of the effect of Soyasignal technology on soybean yield (*Glycine max* (L.) Merr.) under field conditions over 6 years in Eastern Canada and the Northern United States. *J. Agron. Crop Sci.*, *187*, 281-292.
- Lepo, J. E., Hanus, F. J., and Evans, H. J. (1980). Chemoautotrophic growth of hydrogen uptake positive strains of *Rhizobium japonicum*. *J. Bacteriol.*, *141*, 664-670.
- Leveau, J. H. J., and Lindow, S. E. (2002). Bioreporters in microbial ecology. *Curr. Opin. Microbiol.*, *5*, 259-265.
- Lindstrom, K. (1989). *Rhizobium galegae*, a new species of legume root nodule bacteria. *Int. J. Syst. Bacteriol.*, *39*, 365-367.

- Lodeiro, A. R., and Favelukes, G. (1999). Early interactions of *Bradyrhizobium japonicum* and soybean roots: Specificity in the process of adsorption. *Soil Biol. Biochem.*, 31, 1405-1411.
- Lodwig, E. M., Hosie, A. H. F., Bourdes, A., Findlay, K., Allaway, D., Karunakaran, R., et al. (2003). Amino-acid cycling drives nitrogen fixation in the legume-*Rhizobium* symbiosis. *Nature (Lond.)*, 422, 722-726.
- Loh, J. T., Yuen-Tsai, J. P., Stacey, M. G., Lohar, D., Welborn, A., and Stacey, G. (2001). Population density-dependent regulation of the *Bradyrhizobium japonicum* nodulation genes. *Mol. Microbiol.*, 42, 37-46.
- Lopez-Garcia, S. L., Vasquez, T. E. E., Favelukes, G., and Lodeiro, A. R. (2002). Rhizobial position as a main determinant in the problem of competition for nodulation in soybean. *Environ. Microbiol.*, 4, 216-224.
- Lortet, G., Mear, N., Lorquin, J., Dreyfus, B., De Lajudie, P., Rosenberg, C., and Boivin, C. (1996). Nod-factor thin-layer chromatography profiling as a tool to characterize symbiotic specificity of rhizobial strains - application to *Sinorhizobium saheli*, *S. teranga*, and *Rhizobium* sp. strains isolated from *Acacia* and *Sesbania*. *Mol. Plant-Microbe Interact.*, 9, 736-747.
- Lu, Y. H., Murase, J., Watanabe, A., Sugimoto, A., and Kimura, M. (2004). Linking microbial community dynamics to rhizosphere carbon flow in a wetland rice soil. *FEMS Microbiol. Ecol.*, 48, 179-186.
- Ludwig, W., Amann, R., Martinez-Romero, E., Schonhuber, W., Bauer, S., Neef, A., and Schliefer, K.-H. (1998). rRNA based identification and detection systems for rhizobia and other bacteria. *Plant Soil*, 204, 1-19.
- Lupwayi, N. Z., Clayton, G. W., Hanson, K. G., Rice, W. A., and Biederbeck, V. O. (2004). Endophytic rhizobia in barley, wheat and canola roots. *Can. J. Plant Sci.*, 84, 37-45.
- Lupwayi, N. Z., Stephens, P. M., and Noonan, M. J. (1996). Relationship between timing of infection and nodulation competitiveness of *Rhizobium meliloti*. *Symbiosis*, 21, 233-248.
- Marschner, P., Neumann, G., Kania, A., Weiskopf, L., and Lieberei, R. (2002). Spatial and temporal dynamics of the microbial community structure in the rhizosphere of cluster roots of white lupin (*Lupinus albus* L.). *Plant Soil*, 246, 167-174.
- Martinez-Romero, E. (2003). Diversity of *Rhizobium-Phaseolus vulgaris* symbiosis: Overview and perspectives. *Plant Soil*, 252, 11-23.
- Martinez-Romero, E., Segovia, L., Mercante, F. M., Franco, A. A., Graham, P., and Pardo, M. A. (1991). *Rhizobium tropici*, a novel species nodulating *Phaseolus vulgaris* beans and *Leucaena* sp trees. *Int. J. Syst. Bacteriol.*, 41, 417-426.
- Matiru, V. N., Jaffer, M. A., and Dakora, F. D. (2005). Rhizobial infection of African landraces of sorghum (*Sorghum bicolor* L.) and finger millet (*Eleusine coracana* L.) promotes plant growth and alters tissue nutrient concentration under axenic conditions. *Symbiosis*, 40, 7-15.
- McComb, J. A., Elliott, J., and Dilworth, M. J. (1975). Acetylene reduction by *Rhizobium* in pure culture. *Nature (Lond.)*, 256, 409-410.
- McDermott, T. R., and Graham, P. H. (1989). *Bradyrhizobium japonicum* inoculant mobility, nodule occupancy and acetylene reduction in the soybean root system. *Appl. Environ. Microbiol.*, 55, 2493-2498.
- McDermott, T. R., Graham, P. H., and Brandwein, D. H. (1987). Viability of *Bradyrhizobium japonicum* bacteroids. *Arch. Microbiol.*, 148, 100-106.
- McInnes, A., Thies, J. E., Abbott, L. K., and Howieson, J. G. (2004). Structure and diversity among rhizobial strains, populations and communities: a review. *Soil Biol. Biochem.*, 36, 1295-1308.
- Mendes, I. C., Hungria, M., and Vargas, M. A. T. (2004). Establishment of *Bradyrhizobium japonicum* and *B. elkanii* strains in a Brazilian Cerrado oxisol. *Biol. Fertil. Soils*, 40, 28-35.
- Mhamdi, R., Laguerre, G., Aouani, M. E., Mars, M., and Amarger, N. (2002). Different species and symbiotic genotypes of field rhizobia can nodulate *Phaseolus vulgaris* in Tunisian soils. *FEMS Microbiol. Ecol.*, 41, 77-84.
- Michiels, J., Dombrecht, B., Vermeiren, N., Xi, C., Luyten, E., and Vanderleyden, J. (1998). *Phaseolus vulgaris* is a non-selective host for nodulation. *FEMS Microbiol. Ecol.*, 26, 193-205.
- Michiels, J., Verreth, C., and Vanderleyden, J. (1994). Effects of temperature stress on bean-nodulating *Rhizobium* strains. *Appl. Environ. Microbiol.*, 60, 1206-1212.
- Miller, K. J., and Wood, J. M. (1996). Osmoadaptation by rhizosphere bacteria. *Annu. Rev. Microbiol.*, 50, 101-136.

- Modi, M., Shah, K. S., and Modi, V. V. (1985). Isolation and characterization of catechol-like siderophore from cowpea *Rhizobium* RA-1. *Arch. Microbiol.*, *141*, 156-158.
- Molla, A. H., Shamsuddin, Z. H., Halimi, M. S., Morziah, M., and Puteh, A.B. (2001). Potential for enhancement of root growth and nodulation of soybean coinoculated with *Azospirillum* and *Bradyrhizobium* in laboratory systems. *Soil Biol. Biochem.*, *33*, 457-463.
- Montealegre, C., and Graham, P.H. (1996). Preference in the nodulation of *Phaseolus vulgaris* cv RAB39. 2. Effect of delayed inoculation or low cell representation in the inoculant on nodule occupancy by *Rhizobium tropici* UMR1899. *Can. J. Microbiol.*, *42*, 844-850.
- Montealegre, C., Graham, P. H., and Kipe-Nolt, J. A. (1995). Preference in the nodulation of *Phaseolus vulgaris* cultivar RAB39. *Can. J. Microbiol.*, *41*, 992-998.
- Moreira, F. M. S., Cruz, L., Faria, S. M., Marsh, T., Martinez-Romero, E., et al. (2006). *Azorhizobium dobereineriae* sp. nov. Microsymbiont of *Sesbania virgata* (Caz.) Pers. *Syst. Appl. Microbiol.*, *29*, 197-206.
- Mostasso, L., Mostasso, F. L., Dias, B. G., Vargas, M. A. T., and Hungria, M. (2002). Selection of bean (*Phaseolus vulgaris* L.) rhizobial strains for the Brazilian Cerrados. *Field Crops Res.*, *73*, 121-132.
- Moulin, L., Munive, A., Dreyfus, B., and Boivin-Masson, C. (2001). Nodulation of legumes by members of the β subclass of Proteobacteria. *Nature (Lond.)*, *411*, 948-950.
- Mpeperek, S., Javaheri, F., Davis, P., and Giller, K. E. (2000). Soybeans and sustainable agriculture. Promiscuous soybeans in southern Africa. *Field Crops Res.*, *65*, 137-149.
- Muller, J., Boller, T., and Wiemken, A. (2001). Trehalose becomes the most abundant non-structural carbohydrate during senescence of soybean nodules. *J. Exp. Bot.*, *52*, 943-947.
- Mutch, L. A., and Young, J. P. W. (2004). Diversity and specificity of *Rhizobium leguminosarum* biovar *viciae* on wild and cultivated legumes. *Mol. Ecol.*, *13*, 2435-2444.
- Nandasena, K. G. (2005). *Rapid evolution of diversity in the root nodule bacteria of Biserrula peccinosa* L. Ph.D. thesis, Murdoch University, Western Australia.
- Narberhaus, F., Weiglhofer, W., Fischer, H. M., and Hennecke, H. (1998). Identification of the *Bradyrhizobium japonicum degP* gene as part of an operon containing small heat-shock protein genes. *Arch. Microbiol.*, *169*, 89-97.
- Nick, G., de Lajudie, P., Eardly, B. D., Suomalainen, S., Paulin, L., Zhang, X. P., et al. (1999). *Sinorhizobium arboris* sp. nov. and *Sinorhizobium kostiensis* sp. nov. isolated from leguminous trees in Sudan and Kenya. *Int. J. Syst. Bacteriol.*, *49*, 1359-1368.
- Nour, S. M., Fernandez, M. P., Normand, P., and Cleyet-Marel, J. C. (1994). *Rhizobium ciceri* sp. nov., consisting of strains that nodulate chickpeas (*Cicer arietinum* L.). *Int. J. Syst. Bacteriol.*, *44*, 511-522.
- Nour, S. M., Cleyet-Marel, J. C., Normand, P., and Fernandez, M. P., (1995). Genomic heterogeneity of strains nodulating chickpeas (*Cicer arietinum* L.) and description of *Rhizobium mediterraneum* sp. nov. *Int. J. Syst. Bacteriol.*, *45*, 640-648.
- Nutman, P. S. (1962). The relation between root hair infection by *Rhizobium* and nodulation in *Trifolium* and *Vicia*. *Proc. Roy. Soc. (London)* B, *156*, 122-137.
- Ogasawara, M., Suzuki, T., Mutoh, I., Annapurna, K., Arora, N. K., Nishimura, Y., and Maheshwari, D. K. (2003). *Sinorhizobium indiaense* sp. nov. and *Sinorhizobium abri* sp. nov. isolated from tropical legumes, *Sesbania rostrata* and *Abrus precatorius*, respectively. *Symbiosis*, *34*, 53-68.
- Oger, P. M., Mansouri, H., Nesme, X., and Dessaux, Y. (2004). Engineering root exudation of *Lotus* toward the production of two novel carbon compounds leads to the selection of distinct microbial populations in the rhizosphere. *Microbiol. Ecol.*, *47*, 96-103.
- O'Hara, G. W. (2001). Nutritional constraints on root nodule bacteria affecting symbiotic nitrogen fixation: A review. *Aust. J. Exp. Agric.*, *41*, 417-433.
- Oldroyd, G. E. D., and Downie, J. A. (2004). Calcium, kinases and nodulation signalling in legumes. *Nat. Rev. Mol. Cell. Biol.*, *5*, 566-576.
- Ono, Y., Mitsui, H., Sato, T., and Minamisawa, K. (2001). Two *RpoH* homologs responsible for the expression of heat shock protein genes in *Sinorhizobium meliloti*. *Mol. Gen. Genet.*, *264*, 902-912.
- Pagan, J. D., Child, J. J., Scowcroft, W. R., and Gibson, A. H. (1975). Nitrogen fixation by *Rhizobium* cultured on a defined medium. *Nature (Lond.)*, *256*, 406-407.
- Parker, C. A., Trinick, M. J., and Chatel, D. L. (1977). Rhizobia as soil and rhizosphere inhabitants. In R. W. F. Hardy and A. H. Gibson (Eds.), *A Treatise on dinitrogen fixation. IV. Agronomy and ecology* (pp. 311-352). New York, NY: John Wiley and Sons.
- Parniske, M., and Downie, J. A. (2003). Locks, keys and symbioses. *Nature (Lond.)*, *425*, 569-570.

- Pearson, H. L., and Vitousek, P. M. (2001). Stand dynamics, nitrogen accumulations, and symbiotic nitrogen fixation in regenerating stands of *Acacia koa*. *Ecol. Appl.*, *11*, 1381-1394.
- Peng, S. B., Biswas, J. C., Ladha, J. K., Gyaneshwar, P., and Chen, Y. Z. (2002). Influence of rhizobial inoculation on photosynthesis and grain yield of rice. *Agron. J.*, *94*, 925-929.
- Perez-Ramirez, N. O., Rogel, M. A., Wang, E., Castellanos, J. Z., and Martinez-Romero, E. (1998). Seeds of *Phaseolus vulgaris* bean carry *Rhizobium etli*. *FEMS Microbiol. Ecol.*, *26*, 289-296.
- Perrine, F. M., Rolfe, B. G., Hynes, M. F., and Hocart, C. H. (2004). Gas chromatography-mass spectrometry analysis of indoleacetic acid and tryptophan following aqueous chloroformate derivitisation of *Rhizobium* exudates. *Plant Physiol. Biochem.*, *42*, 723-729.
- Persello-Cartieaux, F., Nussaume, L., and Robaglia, C. (2003). Tales from the underground: Molecular plant rhizobacteria interactions. *Plant Cell Environ.*, *26*, 189-199.
- Pinero, D., Martinez, E., and Selander, R. K. (1988). Genetic diversity and relationships among isolates of *Rhizobium leguminosarum* biovar *phaseoli*. *Appl. Environ. Microbiol.*, *54*, 2825-2832.
- Polcyn, W., and Lucinski, R. (2003). Aerobic and anaerobic nitrate and nitrite reduction in free-living cells of *Bradyrhizobium* sp. (*Lupinus*). *FEMS Microbiol. Lett.*, *226*, 331-337.
- Prevost, D., Drouin, P., Laberge, S., Bertrand, A., Cloutier, J., and Levesque, G. (2003). Cold-adapted rhizobia for nitrogen fixation in temperate regions. *Can. J. Bot.*, *81*, 1153-1161.
- Probst, A. H., and Judd, R. W. (1973). Origin, U.S. history and development, and world distribution. In B. E. Caldwell and R. W. Howell (Eds.), *Soybeans: Improvement, production and use* (pp. 1-15). Madison, WI: American Society of Agronomy.
- Pulver, E. L., Brockman, F., and Wein, H. C. (1982). Nodulation of soyabean cultivars with *Rhizobium* spp. and their response to inoculation with *Rhizobium japonicum*. *Crop Sci.*, *22*, 1065-1070.
- Purchase, H. F., and Vincent, J. M. (1949). A detailed study of the field distribution of strains of clover nodule bacteria. *Proc. Linn. Soc. NSW*, *74*, 227-236.
- Purchase, H. F., Vincent, J. M., and Ward, L. M. (1951). The field distribution of strains of nodule bacteria from species of *Medicago*. *Aust. J. Agric. Res.*, *2*, 261-272.
- Radutoiu, S., Madsen, L. H., Madsen, E. B., Felle, H. H., Umehara, Y., Grønlund, M., et al. (2003). Plant recognition of symbiotic bacteria requires two LysM receptor-like kinases. *Nature (Lond.)*, *425*, 585-592.
- Reynolds, H. L., Packer, A., Bever, J. D., and Clay, K. (2003). Grassroots ecology: Plant-microbe soil interactions as drivers of plant community structure and dynamics. *Ecology*, *84*, 2281-2291.
- Richardson, A. E., and Simpson, R. J. (1988). Enumeration and distribution of *Rhizobium trifolii* under a subterranean clover-based pasture growing in an acid soil. *Soil Biol. Biochem.*, *20*, 431-438.
- Richardson, A. E., and Simpson, R. J. (1989). Acid tolerance and symbiotic effectiveness of *Rhizobium trifolii* associated with a *Trifolium subterraneum* L. based pasture growing in acid soil. *Soil Biol. Biochem.*, *21*, 87-95.
- Rioux, C. R., Jordan, C. L., and Rattray, J. B. M. (1986). Anthranilate-promoted iron uptake in *Rhizobium leguminosarum*. *Arch. Biochem. Biophys.*, *248*, 183-189.
- Rivas, R., Willems, A., Subba-Rao, N. S., Mateos, P. F., Dazzo, F. B., Kroppenstedt, R. M., et al. (2003). Description of *Devosia neptuniae* sp. nov. that nodulates and fixes nitrogen in symbiosis with *Neptunia natans*, an aquatic legume from India. *Syst. Appl. Microbiol.*, *26*, 47-53.
- Robledo, E. A., Borneman, J., and Triplett, E. W. (1998). Effects of bacterial antibiotic production on rhizosphere microbial communities from a culture independent perspective. *Appl. Environ. Microbiol.*, *64*, 5020-5022.
- Roddam, L. F., Lewis-Henderson, W. R., and Djordjevic, M. A. (2002). Two novel chromosomal loci influence cultivar-specific nodulation failure in the interaction between strain ANU794 and subterranean clover cv. Woogenellup. *Funct. Plant Biol.*, *29*, 473-483.
- Rodelas, B., Lithgow, J. K., Wisniewski-Dye, F., Hardman, A., Wilkinson, A., Economou, A., et al. (1999). Analysis of quorum-sensing-dependent control of rhizosphere-expressed (*rhi*) genes in *Rhizobium leguminosarum* bv *viciae*. *J. Bacteriol.*, *181*, 3816-3823.
- Rodriguez-Navarro, D. N., Buendia, A. M., Camacho, M., Lucas, M. M., and Santamaria, C. (2000). Characterization of *Rhizobium* spp. bean isolates from south-west Spain. *Soil Biol. Biochem.*, *32*, 1601-1613.
- Rome, S., Fernandez, M. P., Brunel, B., Normand, P., and Cleyet-Marel, J. C. (1996). *Sinorhizobium medicae* sp. nov. isolated from annual *Medicago* spp. *Int. J. Syst. Bacteriol.*, *46*, 972-980.

- Rosas, J. C., Castro, J. A., Robleto, E. A., and Handelsman, J. (1998). A method for screening *Phaseolus vulgaris* L. germplasm for preferential nodulation with a selected *Rhizobium etli* strain. *Plant Soil*, 203, 71-78.
- Rosen, A., and Ljunggren, H. (1996). Denitrification by *Rhizobium meliloti* 2. Field and laboratory studies with soil. *Swed. J. Agric. Res.*, 26, 153-160.
- Rosenblueth, M., and Martinez-Romero, E. (2004). *Rhizobium etli* maize populations and their competitiveness for root colonization. *Arch. Microbiol.*, 181, 337-344.
- Sahlman, K. (1963). An electron microscope study of root-hair infection by rhizobium. *J. Gen. Microbiol.*, 33, 425-427.
- Sanginga, N., Abaidoo, R., Dashiell, K., Carsky, R. J., and Okogum, A. (1996). Persistence and effectiveness of rhizobia nodulating promiscuous soybeans in moist savanna zones of Nigeria. *Appl. Soil Ecol.*, 3, 215-224.
- Santos, M. A., Vargas, M. A. T., and Hungria, M. (1999). Characterization of soybean *Bradyrhizobium* strains adapted to the Brazilian savannas. *FEMS Microbiol. Ecol.*, 30, 261-272.
- Sawada, H., Kuykendall, L. D., and Young, J. M. (2003). Changing concepts in the systematics of bacterial nitrogen-fixing legume symbionts. *J. Gen. Appl. Microbiol.*, 49, 155-179.
- Schallmach, E., Minz, D., and Jurkevitch, E. (2000). Culture independent detection of changes in root-associated bacterial populations of common bean (*Phaseolus vulgaris* L.) following nitrogen depletion. *Microb. Ecol.*, 40, 309-316.
- Schlöter, M., Wiehe, W., Assmus, B., Steindl, H., Becke, H., Hoflich, G., and Hartmann, A. (1997). Root colonization of different plants by plant-growth-promoting *Rhizobium leguminosarum* bv *trifolii* R39 studied with monospecific polyclonal antisera. *Appl. Environ. Microbiol.*, 63, 2038-2046.
- Schmidt, E. L., and Robert, F. M. (1985). Recent advances in the ecology of *Rhizobium*. In H. J. Evans, P. J. Bottomley, and W.E. Newton (Eds.), *Nitrogen fixation research progress* (pp. 379-385). Dordrecht, The Netherlands: Martinus Nijhoff Publishers.
- Scholla, M. H., and Elkan, G. H. (1984). *Rhizobium fredii* sp. nov., a fast growing species that effectively nodulates soybeans. *Int. J. Syst. Bacteriol.*, 34, 484-486.
- Schwinghamer, E. A. (1971). Antagonism between strains of *Rhizobium trifolii* in culture. *Soil Biol. Biochem.*, 3, 355-363.
- Segovia, L., Pinero, D., Palacios, R., and Martinez-Romero, E. (1991). Genetic structure of a soil population of nonsymbiotic *Rhizobium leguminosarum*. *Appl. Environ. Microbiol.*, 57, 426-433.
- Segovia, L., Young, J. P. W., and Martinez-Romero, E. (1993). Reclassification of American *Rhizobium leguminosarum* biovar *phaseoli* type 1 strains as *Rhizobium etli* sp. nov. *Int. J. Syst. Bacteriol.*, 43, 374-377.
- Sessitsch, A., Howieson, J. G., Perret, X., Antoun, H., and Martinez-Romero, E. (2002). Advances in *Rhizobium* research. *Crit. Rev. Plant Sci.*, 21, 323-378.
- Silva, C., Vinuesa, P., Eguiarte, L. E., Martinez-Romero, E., and Sousa, V. (2003). *Rhizobium etli* and *Rhizobium gallicum* nodulate common bean (*Phaseolus vulgaris*) in a traditionally managed milpa plot in Mexico: Population genetics and biogeographic implications. *Appl. Environ. Microbiol.*, 69, 884-893.
- Silva, C., Vinuesa, P., Eguiarte, L. E., Sousa, V., and Martínez-Romero, E. (2005). Evolutionary genetics and biogeographic structure of *Rhizobium gallicum sensu lato*, a widely distributed bacterial symbiont of diverse legumes. *Mol. Ecol.*, 14, 4033-4050.
- Singh, S. P., Nodari, R., and Gepts, P. (1991). Genetic diversity in cultivated common bean. 1. Allozymes. *Crop Sci.*, 31, 19-23.
- Slattery, J. F., Coventry, D. R., and Slattery, W. J. (2001). Rhizobial ecology as affected by the soil environment. *Aust. J. Exp. Agric.*, 41, 289-298.
- Slattery, J. F., Pearce, D. J., and Slattery, W. J. (2004). Effects of resident rhizobial communities and soil type on the effective nodulation of pulse legumes. *Soil Biol. Biochem.*, 36, 1339-1346.
- Smart, J. B., Dilworth, M. J., and Robson, A. D. (1984). Effect of phosphorus supply on phosphorus uptake and alkaline phosphatase in rhizobia. *Arch. Microbiol.*, 140, 281-286.
- Smart, J., and Hymowitz, T. (1985). Domestication and evolution of grain legumes. In R. J. Summerfield and E. H. Roberts (Eds.), *Grain legume crops* (pp. 32-72). London, UK: Collins.
- Smil, V. (1999). Nitrogen in crop production: An account of global flows. *Glob. Biogeochem. Cycle*, 13, 647-662.

- So, R. B., Ladha, J. K., and Young, J. P. W. (1994). Photosynthetic symbionts of *Aeschynomene* spp. form a cluster with bradyrhizobia on the basis of fatty acid and rRNA analyses. *Int. J. Syst. Bacteriol.*, *44*, 392-403.
- Souza, V., Eguiarte, L., Avila, G., Cappello, R., Gallardo, C., Montoya, J., and Pinero, D. (1994). Genetic structure of *Rhizobium etli* biovar phaseoli associated with wild and cultivated bean plants (*Phaseolus vulgaris* and *Phaseolus coccineus*) in Morelos, Mexico. *Appl. Environ. Microbiol.*, *60*, 1260-1268.
- Spehar, C. R. (1995). Impact of strategic genes in soybean on agricultural development in the Brazilian tropical savannahs. *Field Crops Res.*, *41*, 141-146.
- Squartini, A., Struffi, P., Doring, H., Selenska-Pobell, S., Tola, E., Giacomini, A., et al. (2002). *Rhizobium sullae* sp. nov. (formerly '*Rhizobium hedysari*'), the root nodule microsymbiont of *Hedysarum coronarium*. *Int. J. Syst. Evol. Microbiol.*, *52*, 1267-1276.
- Stephens, P. M., and Cooper, J. E. (1988). Variation in speed of infection of "no root hair zone" of white clover and nodulating competitiveness among strains of *Rhizobium trifolii*. *Soil Biol. Biochem.*, *20*, 465-476.
- Stepkowski, T., Moulin, L., Krzyzanska, A., McInnes, A., Law, I. J., and Howieson, J. (2005). European origin of *Bradyrhizobium* populations infecting lupins and serradella in soils of Western Australia. *Appl. Environ. Microbiol.*, *71*, 7041-7052.
- Streeter, J. G. (2003). Effect of trehalose on survival of *Bradyrhizobium japonicum* during desiccation. *J. Appl. Microbiol.*, *95*, 484-491.
- Streit, W., Botero, L., Werner, D., and Beck, D. (1995). Competition for nodule occupancy on *Phaseolus vulgaris* by *Rhizobium etli* and *Rhizobium tropici* strains can be efficiently monitored in an ultisol during the early stages of growth using a constitutive *gus*-gene fusion. *Soil Biol. Biochem.*, *27*, 1075-1081.
- Summers, M. L., Elkins, J. G., Elliott, B. A., and McDermott, T. R. (1998). Expression and regulation of phosphate stress inducible genes in *Sinorhizobium meliloti*. *Mol. Plant-Microbe Interact.*, *11*, 1094-1101.
- Sutton, W. D. (1983). Nodule development and senescence. In W. J. Broughton (Ed.), *Nitrogen fixation, Vol. 3, Legumes* (pp. 144-212). Oxford, UK: Oxford University Press.
- Sy, A., Giraud, E., Jourand, P., Garcia, N., Willems, A., de Lajudie P., et al. (2001). Methylophilic *Methylobacterium* bacteria nodulate and fix nitrogen in symbiosis with legumes. *J. Bacteriol.*, *183*, 214-220.
- Tan, Z. Y., Kan, F. L., Peng, G. X., Wang, E. T., Reinhold-Hurek, B., and Chen, W. X. (2001). *Rhizobium yanglingense* sp. nov. isolated from arid and semi-arid regions in China. *Int. J. Syst. Evol. Microbiol.*, *51*, 909-914.
- Tan, Z. Y., Xu, X. D., Wang, E. T., Gao, J. L., Martinez-Romero, E., and Chen, W. X. (1997). Phylogenetic and genetic relationships of *Mesorhizobium tianshanense* and related rhizobia. *Int. J. Syst. Bacteriol.*, *47*, 874-879.
- Teplitski, M., Robinson, J. B., and Bauer, W. D. (2000). Plants secrete substances that mimic bacterial N-acyl homoserine lactone signal activities and affect population density-dependent behaviors in associated bacteria. *Mol. Plant-Microbe Interact.*, *13*, 637-648.
- Tesfaye, M., Dufault, N. S., Dornbusch, M. R., Allan, D. L., Vance, C. P., and Samac, D. A. (2003). Influence of enhanced malate dehydrogenase expression by alfalfa on diversity of rhizobacteria and soil nutrient availability. *Soil Biol. Biochem.*, *35*, 1103-1113.
- Thies, J., Holmes, E. M., and Vachot, A. (2001). Application of molecular techniques to studies in *Rhizobium* ecology: A review. *Aust. J. Exp. Agric.*, *41*, 299-319.
- Thies, J. E., Woomer, P. L., and Singleton, P. W. (1995). Enrichment of *Bradyrhizobium* spp. populations in soil due to cropping of the homologous host legume. *Soil Biol. Biochem.*, *27*, 633-636.
- Thompson, J. N. (1998). Rapid evolution as an ecological process. *Trends Ecol. Evol.*, *13*, 329-332.
- Tighe, S. W., de Lajudie, P., Dipietro, K., Lindstrom, K., Nick, G., and Jarvis, B. D. W. (2000). Analysis of cellular fatty acids and phenotypic relationships of *Agrobacterium*, *Bradyrhizobium*, *Mesorhizobium*, *Rhizobium* and *Sinorhizobium* species using the Sherlock Microbial Identification System. *Int. J. Syst. Evol. Microbiol.*, *50*, 787- 801.
- Tlustý, B., van Berkum, P., and Graham, P. H. (2005). Characteristics of the rhizobia associated with *Dalea* spp. in the Ordway, Kellogg-Weaver Dunes and Hayden prairies. *Can. J. Microbiol.*, *51*, 15-23.

- Tohme, J., Gonzalez, D. O., Beebe, S., and Duque, M. C. (1996). AFLP analysis of gene pools of a wild bean core collection. *Crop Sci.*, *36*, 1375-1384.
- Tokala, R. K., Strap, J. L., Jung, C. M., Crawford, D. L., Salove, M. H., Deobald, L. A., *et al.* (2002). Novel plant microbe rhizosphere interaction involving *Streptomyces lydicus* WYEC108 and the pea plant (*Pisum sativum*). *Appl. Environ. Microbiol.*, *68*, 2161-2171.
- Toledo, I., Lloret, L., and Martinez-Romero, E. (2003). *Sinorhizobium americanus* sp. nov., a new *Sinorhizobium* species nodulating native *Acacia* spp. in Mexico. *Syst. Appl. Microbiol.*, *26*, 54-64.
- Treonis, A. M., Ostle, N. J., Stott, A. W., Primrose, R., Grayston, S. J., and Ineson, P. (2004). Identification of groups of metabolically active rhizosphere microorganisms by stable isotope probing of PLFAs. *Soil Biol. Biochem.*, *36*, 533-537.
- Trinick, M. J. (1982). Biology. In W. J. Broughton (Ed.) *Nitrogen fixation, Vol. 2, Rhizobium* (pp. 76-146). Oxford, UK: Clarendon Press.
- Triplett, E. W. (1988). Isolation of genes involved in nodulation competitiveness from *Rhizobium leguminosarum* bv *trifolii* T24. *Proc. Nat. Acad. Sci. USA*, *85*, 3810-3814.
- Trujillo, M. E., Willems, A., Abril, A., Planchuelo, A. M., *et al.* (2005). Nodulation of *Lupinus albus* by strains of *Ochrobactrum lupini* nov. sp. *Appl. Environ. Microbiol.*, *71*, 1318-1327.
- Valverde, A., Velásquez, E., Fernández-Santos, F., Vizcaíno, N., Rivas, R., Mateos, P. F., *et al.* (2005). *Phyllobacterium trifolii* sp. nov. nodulating *Trifolium* and *Lupinus* in Spanish soils. *Int. J. Syst. Evol. Microbiol.*, *55*, 1985-1989.
- van Berkum, P. B., and Eardly, B. D. (1998). Molecular evolutionary systematics of the Rhizobiaceae. In H. P. Spaink, A. Kondorosi, and P. J. J. Hooykaas (Eds.), *The Rhizobiaceae. Molecular biology of model plant associated bacteria* (pp. 1-24). Dordrecht, The Netherlands: Kluwer Academic Publishers.
- van Berkum, P., and Eardly, B. D. (2002) The aquatic budding bacterium *Blastobacter denitrificans* is a nitrogen-fixing symbiont of *Aeschynomene indica*. *Appl. Environ. Microbiol.*, *68*, 1132-1136.
- van Berkum, P., Beyene, D., Bao, G., Campbell, T. A., and Eardly, B. D. (1998). *Rhizobium mongolense* sp. nov. is one of three rhizobial genotypes identified which nodulate and form nitrogen-fixing symbioses with *Medicago ruthenica* [(L.) Ledebour]. *Int. J. Syst. Bacteriol.*, *48*, 13-22.
- van Berkum, P., Leibold, J. M., and Eardly, B. D. (2006). Proposal for combining *Bradyrhizobium* spp. (*Aeschynomene indica*) with *Blastobacter denitrificans* and to transfer *Blastobacter denitrificans* (Hirsch and Muller, 1985) to the genus *Bradyrhizobium* as *Bradyrhizobium denitrificans* (comb. nov.). *Syst. Appl. Microbiol.*, *29*, 207-215.
- van Berkum, P., Terefevork, Z., Paulin, L., Suomalainen, S., Lindstrom, K., and Eardly, B. D. (2003). Discordant phylogenies within the *rrn* loci of rhizobia. *J. Bacteriol.*, *185*, 2988-2998.
- Vandamme, P., Goris, J., Chen, W. M., de Vos, P., and Willems, A. (2002). *Burkholderia tuberum* sp. nov. and *Burkholderia phymatum* sp. nov., nodulate the roots of tropical legumes. *Syst. Appl. Microbiol.*, *25*, 507-512.
- Vandenkoornhuysse, P., Ridgway, K. P., Watson, I. J., Fitter, A. H., and Young, J. P. W. (2003). Co-existing grass species have distinctive arbuscular mycorrhizal communities. *Mol. Ecol.*, *12*, 3085-3095.
- van Egerat, A. W. S. M. (1975). Changes in free ninhydrin positive compounds of young pea plants as affected by different nutritional and environmental conditions. *Plant Soil*, *42*, 15-36.
- van Rossum, D., Muyotcha, A., van Verseveld, H. W., Stouthamer, A. H., and Booger, F. C. (1994). Siderophore production by *Bradyrhizobium* spp. strains nodulating groundnut. *Plant Soil*, *163*, 177-187.
- Vargas, A. A. T., and Graham, P. H. (1988). *Phaseolus vulgaris* cultivar and *Rhizobium* strain variation in acid-pH tolerance and nodulation under acid conditions. *Field Crops Res.*, *19*, 91-101.
- Vargas, A. A. T., and Graham, P. H. (1989). Cultivar and pH effects on competition for nodule sites between isolates of *Rhizobium* in beans. *Plant Soil*, *117*, 195-200.
- Velásquez, E., Igual, J. M., Willems, A., Fernandez, M. P., Munoz, E., Mateos, P. F., *et al.* (2001). *Mesorhizobium chacoense* sp. nov., a novel species that nodulates *Prosopis alba* in the Chaco Arido region (Argentina). *Int. J. Syst. Evol. Microbiol.*, *51*, 1011-1021.
- Veneklaas, E. J., Stevens, J., Cawthray, G. R., Turner, S., Grigg, A. M., and Lambers, H. (2003). Chickpea and white lupin rhizosphere carboxylates vary with soil properties and enhance phosphorus uptake. *Plant Soil*, *248*, 187-197.
- Versalovic, J., Schneider, M., de Bruijn, F. J., and Lupski, J. R. (1994). Genomic fingerprinting of bacteria using repetitive sequence based polymerase chain reaction. *Meth. Mol. Cell Biol.*, *5*, 25-40.

- Villacieros, M., Power, B., Sánchez-Contreras, M., Lloret, J., Roke, I., Orezabal, M. M., *et al.* (2003). Colonization behaviour of *Pseudomonas fluorescens* and *Sinorhizobium meliloti* in the alfalfa (*Medicago sativa*) rhizosphere. *Plant Soil*, 251, 47-54.
- Vincent, J. M. (1977). *Rhizobium*: General microbiology. In R. W. F. Hardy and W. S. Silver (Eds.), *A Treatise on dinitrogen fixation, Section 3, Biology* (pp. 277-366). New York, NY: John Wiley and Sons.
- Vinuesa, P., Leon-Barrios, M., Silva, C., Willems, A., Jarabo-Lorenzo, A., Perez-Galdona, R., *et al.* (2005a). *Bradyrhizobium canariense* sp. nov., an acid-tolerant endosymbiont that nodulates endemic genistoid legumes (Papilionoideae: Genistae) from the Canary Islands, along with *Bradyrhizobium japonicum* bv. *Genistearum*, *Bradyrhizobium* genospecies alpha and *Bradyrhizobium* genospecies beta. *Int. J. Syst. Evol. Microbiol.*, 55, 569-575.
- Vinuesa, P., Neumann-Silkow, F., Pacios-Bras, C., Spaik, H. P., Martinez-Romero, E., and Werner, D. (2003). Genetic analysis of a pH-regulated operon from *Rhizobium tropici* CIAT899 involved in acid tolerance and nodulation competitiveness. *Mol. Plant-Microbe Interact.*, 16, 159-168.
- Vinuesa, P., and Silva, C. (2004). Thirteen species delineation and biogeography of symbiotic bacteria associated with cultivated and wild legumes. In D. Werner (Ed.), *Biological resources and migration* (pp. 143-155). Berlin, Germany: Springer.
- Vinuesa, P., Silva, C., Werner, D., and Martinez-Romero, E. (2005b). Population genetics and phylogenetic inference in bacterial molecular systematics: The role of migration and recombination in *Bradyrhizobium* species cohesion and delineation. *Mol. Phylog. Evol.*, 34, 29-54.
- Vlassak, K. M., Mercante, F., Stralio, R., Franco, A., Vuylsteke, M., and Vanderleyden, J. (1997). Evaluation of the intrinsic competitiveness and saprophytic competence of *Rhizobium tropici* IIB strains. *Biol. Fertil. Soils*, 24, 274-282.
- Voss, M., Jardim Freire, J. R., and Selbach, P. A. (1984). Efeito de niveis de calcario no solo e na capacidade de competicao de estirpes. *Pesq. Agropec. Bras.*, 19, 433-439.
- Wang, E. T., Rogel, M. A., Sui, X. H., Chen, W. X., Martinez-Romero, E., and van Berkum, P. (2002a) *Mesorhizobium amorphae*, a rhizobial species that nodulates *Amorpha fruticosa*, is native to American soils. *Arch. Microbiol.*, 178, 301-305.
- Wang, E. T., Tan, Z. Y., Willems, A. Y., Fernandez-Lopez, M., Reinhold-Hurek, B., and Martinez-Romero, E. (2002b). *Sinorhizobium morelense* sp. nov., a *Leucaena leucocephala*-associated bacterium that is highly resistant to multiple antibiotics. *Int. J. Syst. Evol. Microbiol.*, 52, 1687-1693.
- Wang, E. T., van Berkum, P., Beyene, D., Sui, X. H., Dorado, O., Chen, W. X., and Martinez-Romero, E. (1998). *Rhizobium huautlense* sp. nov., a symbiont of *Sesbania herbacea* that has a close phylogenetic relationship with *Rhizobium galegae*. *Int. J. Syst. Bacteriol.*, 48, 687-699.
- Wang, E. T., van Berkum, P., Sui, X. H., Beyene, D., Chen, W. X., and Martinez-Romero, E. (1999). Diversity of rhizobia associated with *Amorpha fruticosa* isolated from Chinese soils and description of *Mesorhizobium amorphae* sp. nov. *Int. J. Syst. Bacteriol.*, 49, 51-65.
- Wardle, D. A. (2002). *Communities and ecosystems: Linking the aboveground and belowground components*. Princeton, NJ: Princeton University Press (392 pp.).
- Wei, G. H., Tan, Z. Y., Zhu, M. E., Wang, E. T., Han, S. Z., and Chen, W. X. (2003). Characterization of rhizobia isolated from legume species within the genera *Astragalus* and *Lespedeza* grown in the Loess Plateau of China and description of *Rhizobium loessense* sp. nov. *Int. J. Syst. Evol. Microbiol.*, 53, 1575-1583.
- Wei, G. H., Wang, E. T., Tan, Z. Y., Zhu, M. E., and Chen, W. X. (2002) *Rhizobium indigoferae* sp. nov. and *Sinorhizobium kummerowiae* sp. nov., respectively isolated from *Indigofera* spp. and *Kummerowia stipulacea*. *Int. J. Syst. Evol. Microbiol.*, 52, 2231-2239.
- Weiss, S. B. (1999). Cars, cows, and checkerspot butterflies: Nitrogen deposition and management of nutrient-poor grasslands for a threatened species. *Conserv. Biol.*, 13, 1476-1486.
- West, S. A., Kiers, E. T., Pen, I., and Denison, R. F. (2002). Sanctions and mutualism stability: When should less beneficial mutualists be tolerated. *J. Evol. Biol.*, 15, 830-837.
- Willems, A., Fernandez-Lopez, M., Munoz-Adelantado, E., Goris, J., de Vos, P., Martinez-Romero, E., *et al.* (2003). Description of new *Ensifer* strains from nodules and proposal to transfer *Ensifer adhaerens* Casida 1982 to *Sinorhizobium* as *Sinorhizobium adhaerens* comb. nov. Request for an opinion. *Int. J. Syst. Evol. Microbiol.*, 53, 1207-1217.
- Wilson, G. L. (1917). Buffalo birdwoman's garden. Agriculture of the Hidatsa indians. St. Paul, MN: Minnesota Historical Society Press, 1987 edition (129 pp.).

- Wilson, K. J. (1995). Molecular techniques for the study of rhizobial ecology in the field. *Soil Biol. Biochem.*, 27, 501-514.
- Wisniewski-Dye, F., and Downie, J. A. (2002). Quorum sensing in *Rhizobium*. *Antonie van Leeuwenhoek*, 81, 397-407.
- Wong, F. Y. K., Stackebrandt, E., Ladha, J. K., Fleischman, D. E., Date, R. A., and Fuerst, J. A. (1994). Phylogenetic analysis of *Bradyrhizobium japonicum* and photosynthetic stem-nodulating bacteria from *Aeschynomene* species grown in separated geographical regions. *Appl. Environ. Microbiol.*, 60, 940-946.
- Wooley, J., Lepiz, R., Aquinas-Portes y Castro, T., and Voss, J. (1991). Bean cropping systems in the tropics and subtropics and their determinants. In A. van Schoonhoven and O. Voysest (Eds.), *Common beans: Research for crop improvement* (pp. 679-706). Cali, Colombia: CIAT.
- Xu, L. M., Ge, C., Cui, Z., Li, J., and Fan, H. (1995). *Bradyrhizobium liaoningense* sp. nov., isolated from the root nodules of soybeans. *Int. J. Syst. Bacteriol.*, 45, 706-711.
- Yang, S. S., Bellogin, R. A., Buendia, A., Camacho, M., Chen, M., Cubo, T., et al. (2001). Effect of pH and soybean cultivars on the quantitative analyses of soybean rhizobia populations. *J. Biotech.*, 91, 243-255.
- Yanni, Y. G., Rizk, R. Y., Corich, V., Squartini, A., Ninke, K., Philip-Hollingsworth, S., et al. (1997). Natural endophytic association between *Rhizobium leguminosarum* bv *trifolii* and rice roots and assessment of its potential to promote rice growth. *Plant Soil*, 194, 99-114.
- Yanni, Y.G., Rizk, R.Y., El-Fattah, F. K. A., Squartini, A., Corich, V., Giacomini, A., et al. (2001). The beneficial plant growth promoting association of *Rhizobium leguminosarum* bv *trifolii* with rice roots. *Aust. J. Plant Physiol.*, 28, 845-870.
- Yao, Z. Y., Kan, F. L., Wang, E. T., Wei, G. H., and Chen, W. X. (2002). Characterization of rhizobia that nodulate legume species of the genus *Lespedeza* and description of *Bradyrhizobium yuanningense* sp. nov. *Int. J. Syst. Evol. Microbiol.*, 52, 2219-2230.
- Young, A. G., and Clarke, G. M. (2000). *Genetics, demography and viability of fragmented populations*. Cambridge, UK: Cambridge University Press (438 pp.).
- Young, J. M. (2003). The genus *Ensifer* (Casida, 1982) takes priority over *Sinorhizobium* (Chen et al., 1988) and *Sinorhizobium morelense* (Wang et al., 2002) is a later synonym of *Ensifer adhaerens* (Casida, 1982). Is the combination '*Sinorhizobium adhaerens*' (Casida, 1982) Willems et al., 2003 legitimate? Request for an opinion. *Int. J. Syst. Evol. Microbiol.*, 53, 2107-2110.
- Young, J. M., Kuykendall, L. D., Martinez-Romero, E., Kerr, A., and Sawada, H. (2001). A revision of *Rhizobium* (Frank, 1889), with an emended description of the genus, and the inclusion of all species of *Agrobacterium* (Conn, 1942) and *Allorhizobium undicola* (de Lajudie et al., 1998) as new combinations: *Rhizobium radiobacter*, *R. rhizogenes*, *R. rubi*, *R. undicola* and *R. vitis*. *Int. J. Syst. Evol. Microbiol.*, 51, 89-103.
- Zahran, H. H. (1999). *Rhizobium* legume symbiosis and nitrogen fixation under severe conditions and in an arid climate. *Microbiol. Mol. Biol. Rev.*, 63, 968-989.
- Zhang, H., Charles, T. C., Driscoll, B. T., Prithiviraj, B., and Smith, D. L. (2002). Low temperature-tolerant *Bradyrhizobium japonicum* strains allowing improved soybean yield in short-season areas. *Agron. J.*, 94, 870-875.

Chapter 3

MAINTAINING COOPERATION IN THE LEGUME-RHIZOBIA SYMBIOSIS: IDENTIFYING SELECTION PRESSURES AND MECHANISMS

E. T. KIERS¹, S. A. WEST², AND R. F. DENISON¹

¹*Plant Sciences Department, University of California,
Davis, CA 95616, U.S.A.*

²*Institute of Cell, Animal and Population Biology, University of Edinburgh,
Edinburgh EH9 3JT, Scotland, UK.*

1. INTRODUCTION

Mutualistic symbioses include a wide range of interactions among a diverse set of organisms. The symbiosis between legumes and rhizobia is a classic mutualistic relationship. In return for carbohydrates provided by the host legume, the rhizobia supply fixed-nitrogen to the legume. Although reciprocally beneficial, the stability of this cooperative relationship poses a dilemma to evolutionary theory. Why do symbioses persist over millennia, if additional resources could be gained by either partner through the exploitation of the mutualism? N₂ fixation is clearly beneficial to the host plant because it supplies fixed-nitrogen needed for growth and photosynthesis. But N₂ fixation is energetically costly to the bacteria and so decreases the resources that could be allocated to their growth and reproduction. Why then do rhizobia fix N₂ to benefit the host plant when expending those resources on reproduction could increase the fitness of the rhizobia themselves? We have suggested (Denison, 2000; West *et al.* 2002a; 2002b) and then shown experimentally (Kiers *et al.*, 2003) that legumes penalize rhizobia that fail to fix N₂. Such sanctions selectively favor the most beneficial rhizobia and hence can stabilize the mutualistic interaction (Denison, 2000; West *et al.*, 2002a; 2002b).

2. EXPLAINING COOPERATION: THE PROBLEM

Basic alignment of interests between host and symbiont will tend to select, in an evolutionary sense, for continued cooperation. Current theory suggests that the stability of cooperation is promoted by “passage of symbiont from parent to offspring (vertical transmission), genotypic uniformity of symbionts within individual hosts, spatial structure of populations leading to repeated interactions between would-be mutualists, and restricted options outside the relationship for both partners” (Herre *et al.*, 1999). However, symbioses between legumes and rhizobia follow none of these restrictions with the possible exception of spatial structuring. Rhizobia are saprophytes and reproduce outside the host. Rhizobia are transmitted horizontally through the soil, not passed directly from parent to offspring, and plants are typically infected by more than one strain of rhizobia (Dowling and Broughton, 1986; Lindemann *et al.*, 1974; Vlassak and Vanderleyden, 1997). This last point implies that rhizobia, which supply their host with fixed-nitrogen, may indirectly benefit competing strains of rhizobia infecting the same individual plant.

To be more specific, if an individual plant hosts a single lineage of rhizobial symbiont, then the shared fate of host and symbiont may favor cooperation (Crespi, 2001; Frank, 1994a; 1998; Herre, 1993). But as the number of strains per plant increases, evolutionary theory predicts a rise in symbiont parasitism (Axelrod and Hamilton, 1981; Frank, 1994a; 1994b; Leigh and Rowell, 1995; Maynard-Smith and Szathmary, 1995). This is the classic tragedy of the commons problem from human economics (Hardin, 1968). Although unwavering cooperation among lineages infecting a given plant would increase their collective access to resources, each symbiont lineage is selected to allocate resources mainly to its own growth and reproduction, to the detriment of its host and fitness of other lineages. Consequently, ‘free-rider’ rhizobia, those that cheat by extracting carbohydrates from the host while fixing little to no N_2 , are predicted to spread at the expense of efficient N_2 -fixing strains (Denison, 2000; West *et al.*, 2002a).

Data from the field have confirmed the existence of less effective rhizobia because rhizobial strains have been shown to vary considerably in the benefits they provide to the host (Denton *et al.*, 2000; Thrall *et al.*, 2000). Strains fixing little to no N_2 are widespread in both natural and agricultural soils (Burdon *et al.*, 1999; Singleton and Stockinger, 1983). N_2 fixation is an energy-intensive process (Gutschick, 1981). Clear trade-offs exist between allocation of carbohydrate to respiration in support of N_2 fixation versus hoarding of carbohydrate by rhizobia to support their own growth and reproduction (Denison, 2000). This is demonstrated in the work of Hahn and Studer (1986), who showed that *Bradyrhizobium japonicum* mutants that do not fix N_2 accumulate higher amounts of the energy-rich poly- β -hydroxybutyrate (PHB) than their N_2 -fixing parent strains, when both strains share the same nodule. Cevallos *et al.* (1996) found that rhizobial mutants, which were unable to synthesize PHB, would continue to fix N_2 for longer periods than the PHB-producing parents. These data suggest a negative correlation between PHB accumulation and N_2 -fixation rate (Kretovich *et al.*, 1977) as well as a possible individual benefit for rhizobia that cheat their plant hosts by failing to invest in N_2 fixation (Denison, 2000).

Cooperation may still be maintained in the presence of cheating symbionts if costs associated with tolerating cheaters are negligible (Schwartz and Hoeksema, 1998). However, investment in nodule production and maintenance is high for legumes, consuming as much as 20% of net photosynthate production (Pate, 1986), which suggests that supporting ineffective rhizobia is a substantial drain on the host. Investment in nodules can pay off for plants if the increase in net photosynthesis supported by N_2 fixation (Bethlenfalvay *et al.*, 1978) exceeds the photosynthate cost, but there is no guarantee that all rhizobia admitted will provide a net benefit.

The tendency of hosts to associate with better cooperators may increase the evolutionary stability of certain mutualisms (Ferriere *et al.*, 2001). If plants could distinguish between marginally effective and highly effective rhizobial strains at the time of infection, there would be little host carbohydrate loss to cheating strains. However, because N_2 fixation does not begin until several days after infection, it appears pre-infection recognition and exclusion of cheaters would have to be based solely on signaling mechanisms. Despite elaborate recognition signals (Hirsch, 1999), legumes do not seem to exclude parasitic rhizobia that are closely related to their usual symbiotic partners (Amarger, 1981; Hahn and Studer, 1986). The short generation time of rhizobia compared to plants and the ability of rhizobia to modify their own extracellular signals (Roche *et al.*, 1991), perhaps mimicking cooperative strains, favors the parasitic symbiont in breaking possible signaling codes.

Given that there are high energy costs of mutualism, that the hosts lack an ability to recognize parasitic rhizobia at time of infection, and that genetically diverse symbiont populations on the host create a tragedy of the commons, we would expect less effective rhizobia to proliferate in soil populations. Indeed, a breakdown in cooperation seems inevitable over only a few generations. How, then, do we explain the stability of the legume-rhizobia symbiosis over tens of millions of years?

3. EXPLAINING COOPERATION: THE HYPOTHESES

3.1. Hypothesis 1: Shared Interest

A classical explanation for cooperation between different species is based on the concept of 'shared interest' (Frank, 1998). It might seem that rhizobia have a shared interest in increasing the overall plant growth and photosynthesis of their host by providing fixed-nitrogen (Bethlenfalvay *et al.*, 1978), because this would presumably increase overall levels of resources available to the rhizobia. In this hypothesis, high levels of N_2 fixation are favored because cooperating with the host increases resource supply to all rhizobia infecting a given plant, which gives their descendants a competitive advantage against other rhizobia. However, the conditions for cooperation to be maintained under a shared interest model are quite restrictive. West *et al.* (2002a) present a series of models that suggest natural selection will maintain high levels of rhizobial N_2 fixation if: (i) there is high relatedness (r) among rhizobial strains sharing a host; and (ii) the relative importance of N_2 fixation to overall plant photosynthesis (source of carbohydrates for rhizobia) is high (s is low if soil N is

scarce, for example) (Figure 1). As these parameters change to low relatedness of rhizobial strains and low relative importance of N_2 fixation to plant resources, low levels of N_2 fixation are predicted (West *et al.*, 2002a).

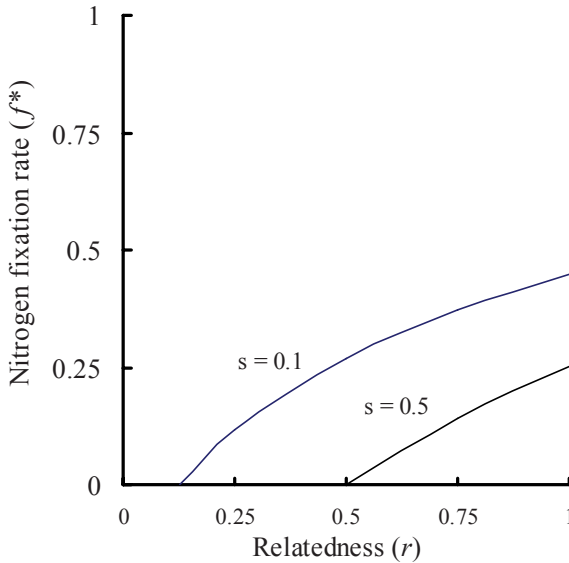

Figure 1. Shared Interest Model. The unbeatable N_2 -fixation rate (f^*) is plotted against the relatedness between the rhizobial strains in a plant (r).

Different lines represent values of (s), the relative importance of N_2 fixation by rhizobia to plant resources and growth. Low rates of fixation are predicted when there is low relatedness of the rhizobia on a root system and when N_2 fixation has a smaller effect (high s) on plant resources. Reproduced from West *et al.* (2002a) with permission of the Royal Society.

Most plants are infected by more than one strain of rhizobia (Dowling and Broughton, 1986). These high numbers of rhizobial strains infecting each plant host create conditions that select for low levels of N_2 fixation. Data from electrophoretic markers suggest an average of approximately 10 rhizobial strains per plant with a range of 4-18 (Hagen and Hamrick, 1996a; 1996b; Souza *et al.*, 1997). This selection for a breakdown in cooperation in a multiply-infected host is analogous to the evolution of virulence in multiple parasites infecting a single host (Ebert, 1998; Frank, 1998; Herre, 1993; Williams and Nesse, 1991). Each symbiont is selected to increase its own growth at the expense of costly cooperative efforts like N_2 fixation (Axelrod and Hamilton, 1981; Leigh and Rowell, 1995; Maynard-Smith and Szathmary, 1995). The shared interest hypothesis fails to explain the maintenance of cooperation because multiple symbiont strains on the host create a tragedy of the commons in which individual interests are selected above collective interests.

3.2. Hypothesis 2: Kin Selection in the Rhizosphere

The hypothesis that the evolutionary persistence of N_2 fixation depends on the channeling of plant resources to related kin in the soil rhizosphere has been suggested in several papers (Bever and Simms, 2000; Crespi, 2001; Olivieri and Frank, 1994; Simms and Bever, 1998). The rhizosphere hypothesis relies on a kin-selected benefit of resources supplied by altruistic kin (Jimenez and Casadesus, 1989) inside the nodule. It assumes that the nodule rhizobia that fix N_2 are terminally differentiated and at a reproductive dead end (but see below), and can best perpetuate their genes by shuttling resources to reproductively viable (undifferentiated) kin in the rhizosphere (Simms and Bever, 1998). It maintains that N_2 fixation provides greater root exudations and that these resources can be used by genetically-related rhizobia in the soil. A more specific version of the rhizosphere hypothesis is known as the 'rhizopine concept', which assumes that inositol-like compounds called 'rhizopines' are excreted by N_2 -fixing nodules and then metabolized mainly by specific rhizobial kin in the soil (Murphy *et al.*, 1995; Olivieri and Frank, 1994; Simms and Bever, 1998).

The rhizopine hypothesis is supported by the following observations: (i) the expression of genes for the synthesis of rhizopines is controlled by genes linked to N_2 -fixing activity; (ii) in *Sinorhizobium meliloti* and *Rhizobium leguminosarum*, Sym plasmids encode rhizopine metabolism; and (iii) nodulation competitiveness is improved by rhizopine-catabolizing ability (Provorov, 1998). However, competition experiments, using transgenic rhizobia differing in their ability to produce or consume rhizopines, "were not consistent with the hypothesis that the sole role of rhizopines is to act as proprietary growth substances for free-living populations of the producing strain" (Gordon *et al.*, 1996).

Fierce competition among soil bacteria (including unrelated saprophytes and both non-mutualistic and mutualistic rhizobia) for resources in the rhizosphere undercut the effectiveness of resource shuttling by nodule rhizobia to their soil kin (West *et al.*, 2002a). Open access to plant exudates could increase the relative fitness of rhizosphere mutualists and non-mutualists alike (Denison *et al.*, 2003). The rhizosphere hypothesis acknowledges this vulnerability to invasion by unrelated soil bacteria but counters the problem by suggesting that rhizopines can only be metabolized by a few rhizobial strains and that spatial structuring of soil (poor mixing to limit dispersal of rhizobia) will prevent invasion by unrelated strains. It is suggested that rhizopine specificity restricts resource consumption to related mutualists whereas spatial structuring increases relatedness between nodule and soil rhizobia resulting in the direct transfer of resources between nodule and soil kin (Bever and Simms, 2000; Simms and Bever, 1998).

Nonetheless, the rhizosphere hypothesis is unlikely to explain cooperative stability for the following reasons.

First, the rhizosphere hypothesis assumes that rhizobia in the nodule leave no direct descendants. Although nodules differ in their ability to leave direct descendants, species with determinate nodules (*Glycine*, *Lotus*, and *Phaseolus*) tend to have bacteroids (the differentiated N_2 -fixing rhizobial form) that retain their

reproductive ability (Gresshoff and Rolfe, 1978; McDermott *et al.*, 1987; Zhou *et al.*, 1985). This implies that selection can act directly on the N₂-fixing form of rhizobia (the bacteroids) and need not rely on a rhizosphere kin-selected benefit (Denison, 2000). Even in indeterminate nodules (*Pisum*, *Trifolium* and *Medicago*), the undifferentiated rhizobia found in the infection threads are thought to be reproductively viable (Sprent *et al.*, 1987) and to recolonize the soil after nodule senescence (Timmers *et al.*, 2000; Vance *et al.*, 1980). Natural selection would, therefore, favor bacteroids that preferentially shuttle resources to these genetically identical kin within the nodule, which may contain more rhizobia than 10 kg of soil (West *et al.*, 2002a), rather than to a mixed population of rhizobia and other species in the rhizosphere. West *et al.* (2002a) suggested that accumulation of the energy-rich PHB molecule (potentially useful for reproduction and soil survival of rhizobia) could be useful to researchers in identifying the rhizobial form that survives senescence of the nodule. In determinate nodules, differentiated bacteroids hoard PHB, whereas in indeterminate nodules, it is the undifferentiated rhizobia (and not bacteroids) that accumulate PHB, at least in some species (Vance *et al.*, 1980; Wong and Evans, 1971). Importantly, in both nodule types, some reproductively viable rhizobia are thought to survive nodule senescence, although natural selection will act on different forms (differentiated rhizobia in determinate nodules and undifferentiated rhizobia in indeterminate nodules). We, therefore, reject the assumption that all nodule rhizobia are reproductively dead and that soil kin are the only form that can benefit from N₂ fixation. If there are possible legume-rhizobia combinations that do not result in the reproduction of any direct descendants from rhizobia inside nodules, then kin-selected rhizosphere benefits may prove to be an important selective mechanism in those cases.

Second, the rhizosphere hypothesis suggests that spatial structuring (population viscosity) of rhizobial soil populations is key to the stability of the legume-rhizobia mutualism (Bever and Simms, 2000). Although spatial structuring of populations may increase kin-selected benefits by reducing mixing with non-mutualistic strains, increased spatial structuring also increases local competition among clonally identical rhizobia, which could reduce any kin-selected benefits for greater N₂ fixation (Frank, 1998; Queller, 1992; West *et al.*, 2002a). Indeed, under the simplest scenario, the benefits of spatial structuring to kin selection are often exactly balanced by changes in scale of competition (Frank, 1998; Queller, 1994; Taylor, 1992; West *et al.*, 2001).

Third, the rhizosphere hypothesis proposes that specific exudates from the host plant selectively benefit related kin in the rhizosphere. Specificity of rhizopines might prevent some soil bacteria from being able to catabolize rhizopines, but mutants closely related to the parental strain could easily arise. For instance, a rhizobial mutant that lost the genes for infecting legumes but retained the ability to metabolize rhizopines would outcompete and displace its mutualistic parent strain, assuming that the benefits of symbiosis to rhizobia depend on rhizopine exudation to the rhizosphere (Denison, 2000). Even if specific rhizosphere resources were available, benefits to rhizosphere rhizobia are likely trivial when compared to resource benefits gained by rhizobia *inside* the nodule (Denison, 2000; West *et al.*, 2002a). Carbon is shuttled to bacteroids and fuels fixation as well as the creation of

new bacteroids (Lodwig and Poole, 2003). Access to carbon resources is presumably greatest for rhizobia inside the nodule rather than in the rhizosphere. Any resources exuded from the root will be the object of fierce competition with saprophytic and non-mutualist bacteria (Denison, 2000; West *et al.*, 2002a). These bacteria have been shown to outnumber rhizobia by two-to-three orders of magnitude (Hirsch, 1996) and are likely better competitors for most resources than rhizobia - rhizopines may be an exception - as their entire life cycle is spent in the soil. In contrast, PHB hoarding by bacteroids in determinate nodules or transfer of rhizopines to reproductive clonemates inside indeterminate nodules can specifically support nodule populations of rhizobia. Clearly, fitness benefits to rhizobia in nodules outweigh benefits to rhizobia in the soil, but research is still needed to be certain whether increases in rhizobial soil populations following nodule senescence (Brockwell *et al.*, 1987; Bushby, 1993) are the result of either shuttling resources to rhizosphere populations or the release of viable rhizobia from the nodule.

3.3. Hypothesis 3: Amino-Acid Cycling and Bacteroid Environment

Cycling of amino acids has been proposed as a mechanism to directly link a bacteroid's own N₂ fixation with the supply of resource received, not just the overall C or N status of the host plant (Lodwig *et al.*, 2003). The coupled exchange is proposed to involve the transfer of amino acids to the nodule bacteroids, which permits the shut down of ammonium assimilation. The bacteroids cycle the amino acids and return them to the host, for asparagine biosynthesis in the case of pea (*Pisum sativum*) (Lodwig *et al.*, 2003). This type of dependence would act as a selective pressure to maintain cooperative stability in which neither partner dominates the symbiosis (Sprent, 2003). A more generalized model, which coupled bacteroid carbon metabolism to plant nitrogen metabolism, has been proposed by Kahn *et al.* (1985).

We agree with Sprent (2003) that 'checks and balances' are the key to maintaining cooperation between legume plants and their symbiotic N₂-fixing rhizobia. However, in order for exchange-control systems to have any evolutionary effect, they must actually reduce the survival and reproduction of those rhizobial strains failing to provide the plant host with fixed-nitrogen (Kiers *et al.*, 2003). In nodules on pea, the host plant studied by Lodwig *et al.* (2003), withholding resources to the differentiated N₂-fixing bacteroids would not impose effective selection pressure because pea bacteroids are unable to reproduce anyway (Gresshoff and Rolfe, 1978; McDermott *et al.*, 1987; Zhou *et al.*, 1985). Upon senescence of pea nodules, therefore, the bacteroids die and only the undifferentiated rhizobia, which never fixed N₂ in symbiosis, escape into the soil from dying pea nodules (see above). Consequently, bacteroid-directed resource control does not provide a generalized evolutionary explanation for the maintenance of the legume-rhizobial mutualism in either pea or other species with indeterminate nodules (Kiers *et al.*, 2003). Even if bacteroids were reproductive in this species, the exchange control system would need to affect their survival and reproduction, not just their ability to

export fixed-N. Ludwig *et al.* (2003) did not track the reproductive success of the rhizobia in the nodules and, therefore, did not establish whether failure to cycle amino acids actually reduced the reproductive fitness of bacteroids.

Plant-mediated bacteroid control could be important for rhizobia whose bacteroids do have direct descendants (Denison, 2000). Udvardi and Kahn (1993) suggested that individual bacteroids could benefit from N₂ fixation because fixation maintains an appropriate pH inside the peribacteroid unit that envelops the bacteroids and also ensures access to plant resources by coupling plant N metabolism to bacteroid C metabolism. Control of bacteroid O₂ supply (Layzell and Hunt, 1990), coupled with the export of fixed-nitrogen, may also act to limit the spread of cheating rhizobia (Denison, 2000; Udvardi and Kahn, 1993). Brewin (1991) proposed that to oppose plant-induced digestion at low pH, bacteroids release ammonia. These mechanisms of bacteroid-directed exchange control could be important, but the suggested physiological links between the failure to fix N₂ and reductions in rhizobial fitness have not been demonstrated.

3.4. Hypothesis 4: Post-Infection Sanctions

One recent attractive idea is that cooperation between species can be enforced if individuals are able to either actively reward cooperation or punish less cooperative behavior. This idea has been termed ‘sanctions’ (Denison, 2000) and is conceptually analogous to ‘policing’ mechanisms that have been shown to stabilize cooperation within species (Frank, 1995; Ratnieks *et al.*, 2001). Plant sanctions can be defined as the preferential supply of resources (or alternatively the severing of resources) to nodules based on the amount of fixed-N supplied by the nodules (Denison, 2000; Kiers *et al.*, 2003; Simms and Taylor, 2002; West *et al.*, 2002a; 2002b).

The sanctions hypothesis proposes that the host makes the reproductive success of rhizobial strains contingent on their ability to export fixed-N. This would provide a selection pressure to maintain rhizobial fixation even under conditions where fixation rates are otherwise predicted to be low (*i.e.*, when the tragedy of the commons occurs, with high genetic diversity and low relatedness (r) of symbionts). This idea has been shown to be theoretically robust in models and not dependent upon whether plants assess the level of N₂ fixation either absolutely or relative to the other rhizobia infecting the plant (West *et al.*, 2002a; 2002b). In contrast to the low rates of fixation demonstrated in a shared interest model (Figure 1), high fixation rates are predicted when plants preferentially supply resources to nodules fixing more N₂ (Figure 2). Importantly, the predicted fixation rate shows very little sensitivity to (r), the relatedness of rhizobial strains in a plant. The high within-host diversity of symbionts found would, therefore, have little influence on the fixation rate of the strains (West *et al.*, 2002a). In the presence of nodule sanctions, rhizobia that fix little N₂ are denied access to resources, even if (perhaps *especially* if) other nodules on the same host plant are supplying plenty of fixed-N. This essentially eliminates the tragedy of the commons on the level of the root system. Kin selection remains an important selection component but on the level of the individual nodule and not on the level of the root or surrounding rhizosphere (West *et al.*, 2002a).

If the evolutionary persistence of symbiotic N_2 fixation by rhizobia is the result of selection pressures by the host, are there similar selection pressures on the hosts to favor the evolution of these sanctions? In clear-cut cases of mutualistic partners that defect (*e.g.*, yucca moths; Pellmyr and Huth, 1994), imposition of sanctions (preferential abortion of flowers) creates an obvious selective advantage. But when partners provide some intermediate level of benefit, sanctions may actually inflict a cost on the host. For natural selection among plants to favor the evolution of sanctions, they must provide a fitness benefit to individual plants. By simultaneously considering the optimal fraction of nodules senesced and the initial investment in nodules, West *et al.* (2002b) concluded that sanctions are favored when the advantage of increasing the efficiency of the symbiont partner is greater than the expenditure of reducing the *total* advantage of the partners (*i.e.*, reducing the overall amount of N_2 fixation). This result, plus finding that increasing the severity of sanctions selects for more mutualistic behavior of symbionts (West *et al.*, 2002a), suggests a co-evolutionary mechanism for continued stability of cooperation.

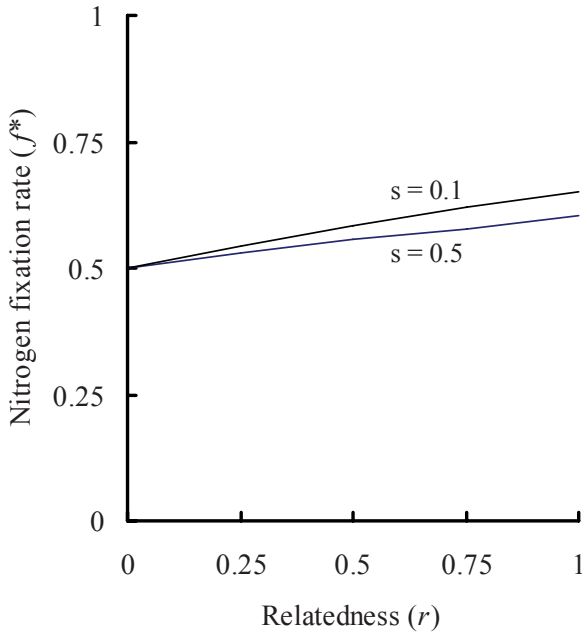

Figure 2. Fixed-threshold plant sanctions.

The unbeatable N_2 -fixation rate (f^*) is plotted against the relatedness between the rhizobial strains in a plant (r). Different lines represent values of (s), the relative importance of N_2 fixation by rhizobia to plant resources and growth. High rates of N_2 fixation are predicted regardless of both relatedness (r) of the rhizobia and the effect on plant resources (s) because of selective partitioning of resources.

Reproduced from West *et al.* (2002a) with permission of the Royal Society.

The models of West *et al.* (2002a; 2002b) described above assume nodule-level sanctions. That is, a host is assumed to have the ability to identify individual nodules that are evading their N₂-fixing duties. Kiers *et al.* (2003) tested this assumption and the general sanctions hypothesis by mimicking cheating strains and monitoring host response. In a series of experiments at three spatial scales (whole plant, half root systems and individual nodules), fixing strains were forced to cheat when air was replaced with an N₂-free atmosphere. By replacing air (N₂:O₂, 80:20 v/v) with argon (Ar:O₂, 80:20 v/v), and a trace of N₂, N₂ fixation was reduced to about 1% of normal, which was low enough to elicit a potential plant response while ensuring no direct N limitation to rhizobia. Nodules were allowed to develop under standard atmospheric conditions and then cheating was imposed on target nodules by manipulating the atmosphere to prevent further N₂ fixation. The benefits of this method include precise control of when and where rhizobia fix N₂ and the absence of possible confounding differences between strains, such as basic metabolic differences that might be associated with non-fixing strains.

The results (Figure 3) demonstrated a significant fitness cost to those rhizobia failing to fix N₂ (Kiers *et al.*, 2003). As predicted by the sanctions hypothesis, N₂-fixing rhizobia consistently grew to larger numbers than non-fixing rhizobia. At all three spatial scales tested (plant, half root, or single nodule level), plants detected cheating by rhizobia and responded in ways that reduced their fitness. Two-fold differences in population size were found between rhizobia released into the microcosm rhizosphere after only one plant generation, *i.e.*, a 50% fitness cost for not fixing N₂. Survival of these N₂-fixing rhizobia over five months in sterile sand was also significantly higher than survival of non-fixing rhizobia, possibility indicating differences in stored resources. Differences in resource allocation between fixing and non-fixing treatments were observed when host plants were exposed to both cheating and N₂-fixing rhizobia on a single root system (split-root and single nodule experiments). When given the option of selective partitioning between fixing and non-fixing nodules, the host consistently supplied more resources (as shown by higher nodule fresh weight and higher root dry weights) to the N₂-fixing treatment.

The host plant is essentially faced with two options to successfully sanction cheating rhizobia; either reduce resources required for rhizobial growth or attack the rhizobia directly. A direct attack (*e.g.*, using acid hydrolysis) on non-fixing nodules could be effective in reducing losses to non-fixing rhizobia and (as a side-effect) in preventing cheating populations from escaping into the soil. Reducing carbohydrate supply to the nodules could limit the spread of cheating bacteria, but it has been reported that, when nodules are starved of carbohydrates, the rhizobia begin to attack host cell organelles and cell walls to obtain their energy (Thornton, 1930). If hosts could limit respiration of the rhizobia by decreasing internal nodule O₂ concentration, this might restrict growth of non-fixing nodule rhizobia (Denison, 2000; Udvardi and Kahn, 1993) and also decrease the likelihood of a rhizobial attack on the plant. Changes in nodule O₂ permeability had previously been documented in response to cessation of N₂ fixation on a whole-root system basis (Sheehy *et al.*, 1983) and to various stresses (Denison *et al.*, 1983; Hartwig *et al.*, 1987).

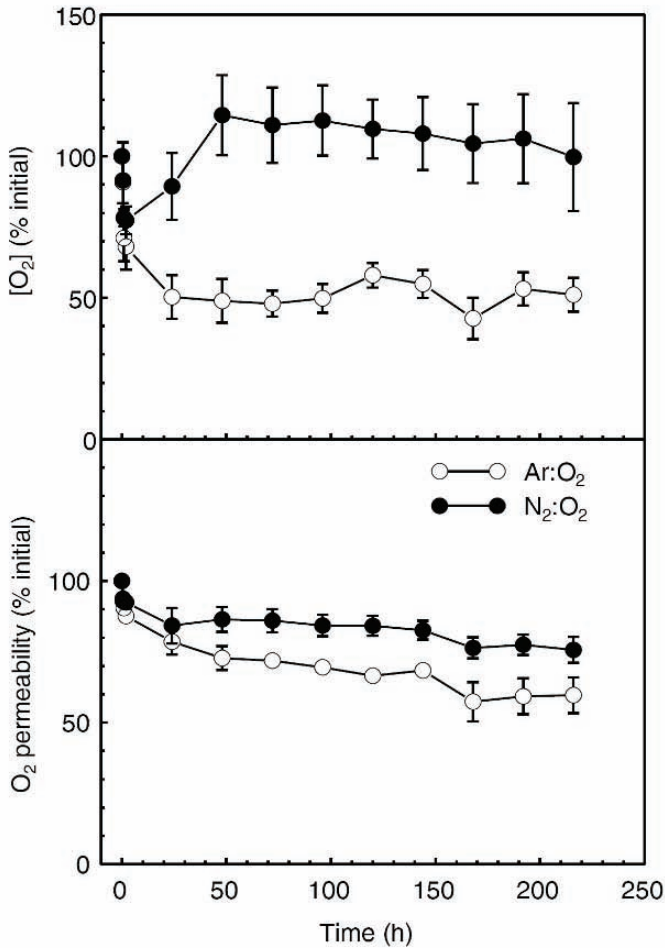

Figure 3. O₂ relations in single nodules where rhizobia were allowed to fix (N₂:O₂) or prevented from fixing (Ar:O₂).

Within 48 hours, non-fixing nodules had significantly lower interior O₂ concentration under 20% O₂ as calculated from leghemoglobin oxygenation. Data are presented as % of initial concentration to standardize for any initial differences.

Reproduced with permission of Nature Publishing Group.

Preventing individual nodules from fixing N₂ elicited a direct plant response (Kiers *et al.*, 2003). Within 48 hours, nodule permeability to O₂ and internal nodule

O₂ concentration were significantly lower in non-fixing nodules than in N₂-fixing nodules (Figure 3). This has been suggested as the primary mechanism for the sanctioning of cheating rhizobia (Kiers *et al.*, 2003). As indicated by a lack of significant differences in O₂-saturated respiration, photosynthate supply did not seem to limit rhizobial respiration more than in the control. However, decreasing nodule O₂ concentration need not be the sole mechanism for sanctioning control. Legumes may use a suite of control mechanisms that limit the spread of cheating bacteria. It is suspected that the response of lowering O₂ concentration is specific to rhizobial defection and not simply lack of fixed-N, because nodule O₂ permeability also decreases when soil fixed-N supply increases (Denison and Harter, 1995).

It appears that, on average, rhizobia that infect legumes and fix N₂ must leave more descendants (higher inclusive fitness) than those that do not. Fixation of N₂ by rhizobia appears to be maintained through domination by one partner, enforcing good behavior by the other, perhaps through manipulation of resources, such as O₂. The penalty for non-compliance (sanctions) acts to reduce the fitness of the cheating partner and to create a strong selection pressure for continued cooperation.

4. CHEATING AND MIXED NODULES

We have presented evidence in agreement with other symbiotic systems (West and Herre, 1994) that one partner (the legume) dominates the relationship *via* asymmetrical control of the mutualistic rhizobial partner by reducing O₂ supply to nodules that fail to fix N₂. If this is a strong selection pressure, why then do cheaters exist at all? One possible explanation is that multiple strains of rhizobia can infect single nodules and that sanctions occur at the level of the nodule (or more generally that there is genetic diversity of symbionts at the level at which sanctions are applied). Nodule-level sanctions will be most effective if there is only one strain of rhizobia per nodule (Denison, 2000), but some single nodules do contain more than one (Rolfe and Gresshoff, 1980; Demezas and Bottomley, 1986; Trinick *et al.*, 1983). When rhizobial strains share a nodule, there is a degree of protection for the defecting strain. Cheating strains have been shown to accumulate PHB at the expense of the fixing strain when sharing a single nodule (Hahn and Studer, 1986).

This situation can, therefore, create a tragedy of the commons at a different level, undercutting the evolutionary effects of nodule-level sanctions (Denison, 2000) and making sanctions at the nodule level only partially effective. Although the frequency of mixed nodules under field conditions is largely unknown (Simms and Bever, 1998), the persistence of the cheating polymorphism may well be a result of strains sharing a nodule. Plant sanctions could be aimed at individual bacteroids within a nodule (Udvardi and Kahn, 1993; Denison, 2000) and, in determinate nodules such as on soybeans, this could effectively reduce the occurrence of more parasitic strains. However, in indeterminate nodules, sanctions against bacteroids would be ineffective at limiting the evolution of parasitism because selection acts only on the reproductively viable fraction of the nodule, the undifferentiated rhizobia in the infection threads. If the abundance of cheaters in a particular indeterminate nodule is high, the nodule could be tagged for sanctions but, in mixed nodules, this

could affect both fixing and non-fixing strains. There is a great need for empirical work to determine both the frequency of mixed nodules in the field and the mechanism by which sanctions occur. Comparing occurrences of mixed rhizobial genotypes in determinate and indeterminate nodules could clarify the importance of different selection pressures, such as kin selection in indeterminate nodules.

5. FUTURE DIRECTIONS

Sanctions could potentially be very important in stabilizing mutualisms between species because they can select for cooperation under a wide range of conditions, especially in cases where cooperation is hard to explain by other theories. Model predictions and empirical data support the sanctions hypothesis, although several simplifying assumptions have been made. For instance, static models were used to identify plant and rhizobial strategies favored by natural selection (West *et al.*, 2002a; 2002b). If different stages of plant growth were incorporated into dynamic models, we could predict growth-dependent N_2 -fixation rates and associated sanction severity. Because N_2 -fixing strategies for rhizobia may differ over the lifetime of a plant, increasingly sophisticated models could examine rhizobial strategies for strains infecting perennial and annual legumes. The static models assumed that less mutualistic rhizobia fixed less N_2 from the start (West *et al.*, 2002b). The more complex tactic of fixing N_2 initially and then defecting could be advantageous to rhizobia attempting to avoid sanctions. More detailed models will be useful in exploring the selective advantages of specific rhizobial and plant strategies but are unlikely to annul the basic conclusions presented above.

Proper testing of these model predictions will require both field and microcosm studies. Estimates of the frequency of mixed nodules will be important in establishing how selection pressures may differ in determinate and indeterminate nodules. Field data monitoring changes in relative abundance of less mutualistic rhizobia in response to agricultural practices (Kiers *et al.*, 2002) and changes in vegetation could be useful predictors in the evolution and subsequent management of symbiont communities.

An implication of this work is that shifts in symbiotic functioning could also result from agronomic breeding practices. Studies suggest that a host plant's ability to form effective symbioses is a heritable trait that may be selected for or against in plant breeding programs (Hetrick *et al.*, 1993; Maske, 1989). It is conceivable that breeding under high fertilizer regimes could also have modified the ability of legumes to enforce cooperation of symbionts. Presumably, dependence on biologically fixed nitrogen would be greater in the wild ancestors of agronomic crops with natural selection favoring legumes able to detect and sanction ineffective rhizobia. Studies are currently underway to evaluate how 70 years of soybean breeding have modified the sanctioning response. This is an important question because we may be selecting for cultivars that fail to maximize the amount of nutrients derived from symbiosis, and perhaps also inadvertently encouraging the spread of less effective symbionts.

Microcosm studies have the potential to yield interesting results as both host and symbiont can be grown and manipulated in a laboratory setting. Future studies could consider the complexity of ‘conditional outcomes’ on host and symbiont strategies. This complexity includes the influences of changes in resource availability, increases and decreases of genetic diversity of symbiont populations, and variable fixation strategies. Altering the timing and composition of gas treatments to simulate rhizobia with different fixation patterns will be useful to determine how closely plants can track changes in rhizobial fixation.

Experiments could aim to determine if plants evaluate rhizobia on a ‘relative’ basis to other strains infecting the plant or if plants employ a ‘fixed’ sanction strategy on rhizobial symbionts based on a predetermined fixation minimum (West *et al.*, 2002a). Further data are needed to determine the level at which sanctions are applied in different species (at either nodule or individual bacteroid) and to determine whether there are differences in sanctioning strategy between indeterminate and determinate nodules. These questions need to be part of a larger query to investigate the fate and resource-hoarding ability of rhizobia from senescing indeterminate and determinate nodules. Monitoring the accumulation and/or transfer of energy-rich compounds might be useful in future studies to link resource dynamics with rhizobial fitness success.

6. CONCLUSION

Controlling the reproductive fate of a symbiont can impose a strong selective pressure for cooperation. Host sanctions or other indirect methods of resource control may be central in favoring cooperation in a diversity of mutualistic symbiosis (Bshary and Grutter, 2002; Gardner and West, 2004; Heinrich and Boyd, 2001; Pellmyr and Huth, 1994; West and Herre, 1994; Yu, 2001). The dominating partner, in this case apparently the legume, imposes a penalty on the symbiont for noncompliance. Both organisms still benefit from the mutualistic relationship but the control is asymmetrical. Given the importance of the legume-rhizobia symbiosis to natural and agricultural ecosystems, identifying selection pressures that maintain this cooperation should become a priority. Research dedicated to discovering the factors that stabilize the legume-rhizobia symbiosis may help us manipulate selection pressures to maximize the benefits derived from the symbiosis. Understanding the evolution of cooperation in the legume-rhizobia symbiosis may also provide a theoretical framework to evaluate host control in other mutualistic systems.

ACKNOWLEDGEMENTS

This work was supported by an NSF grant (R.F.D.), an NSF Graduate Fellowship and Land Institute Fellowship (E.T.K.), and the Royal Society, the BBSRC and the NERC (S.A.W.).

REFERENCES

- Amarger, N. (1981). Competition for nodule formation between effective and ineffective strains of *Rhizobium meliloti*. *Soil Biol. Biochem.*, *13*, 475-480.
- Axelrod, R., and Hamilton, W. D. (1981). The evolution of cooperation. *Science*, *211*, 1390-1396.
- Bethlenfalvay, G. J., Abu-Shakra, S. S., and Phillips, D. A. (1978). Interdependence of nitrogen nutrition and photosynthesis in *Pisum sativum* L. II. Host plant response to nitrogen fixation by *Rhizobium* strains. *Plant Physiol.* *62*, 131-133.
- Bever, J. D., and Simms, E. L. (2000). Evolution of nitrogen fixation in spatially structured populations of *Rhizobium*. *Heredity*, *85*, 366-372.
- Brewin, N. J. (1991). Development of the legume root nodule. *Annu. Rev. Cell Biol.*, *7*, 191-226.
- Brockwell, J., Roughley, R. J., and Herridge, D. F. (1987). Population dynamics of *Rhizobium japonicum* strains used to inoculate three successive crops of soybean. *Aust. J. Agric. Res.*, *38*, 61-74.
- Bshary, R., and Grutter, A. S. (2002). Asymmetric cheating opportunities and partner control in a cleaner fish mutualism. *Anim. Behav.*, *63*, 547-555.
- Burdon, J. J., Gibson, A. H., Searle, S. D., Woods, M. J., and Brockwell, J. (1999). Variation in the effectiveness of symbiotic associations between native rhizobia and temperate Australian *Acacia*: Within-species interactions. *J. Appl. Ecol.*, *36*, 398-408.
- Bushby, H. V. A. (1993). Colonization of rhizospheres by *Bradyrhizobium* sp. in relation to strain persistence and nodulation of some pasture legumes. *Soil Biol. Biochem.*, *25*, 597-605.
- Cevallos, M. A., Encarnacion, S., Leija, A., Mora, Y., and Mora, J. (1996). Genetic and physiological characterization of a *Rhizobium etli* mutant strain unable to synthesize poly- β -hydroxybutyrate. *J. Bacteriol.*, *178*, 1646-1654.
- Crespi, B. J. (2001). The evolution of social behavior in microorganisms. *Trends Ecol. Evol.*, *16*, 178-183.
- Demezas, D. H., and Bottomley, P. J. (1986). Inter-strain competition between representatives of indigenous serotypes of *Rhizobium trifolii*. *Appl. Environ. Microbiol.*, *52*, 1020-1025.
- Denison, R. F. (2000). Legume sanctions and the evolution of symbiotic cooperation by rhizobia. *Am. Nat.*, *156*, 567-576.
- Denison, R. F., Weisz, P. R., and Sinclair, T. R. (1983). Analysis of acetylene reduction rates of soybean nodules at low acetylene concentrations. *Plant Physiol.*, *73*, 648-651.
- Denison, R. F., and Harter, B. L. (1995). Nitrate effects on nodule oxygen permeability and leghemoglobin. Nodule oximetry and computer modeling. *Plant Physiol.*, *107*, 1355-1364.
- Denison, R. F., Bledsoe, C., Kahn, M., O'Gara, F., Simms, E. L., and Thomashow, L. S. (2003). Cooperation in the rhizosphere and the "free rider" problem. *Ecology*, *84*, 838-845.
- Denton, M. D., Coventry, D. R., Bellotti, W. D., and Howieson, J. G. (2000). Distribution, abundance and symbiotic effectiveness of *Rhizobium leguminosarum* bv. *trifolii* from alkaline pasture soils in South Australia. *Aust. J. Exp. Agric.*, *40*, 25-35.
- Dowling, D. N., and Broughton, W. J. (1986). Competition for nodulation of legumes. *Annu. Rev. Microbiol.*, *40*, 131-157.
- Ebert, D. (1998). Experimental evolution of parasites. *Science*, *282*, 1432-1435.
- Ferrière, R., Bronstein, J. L., Rinaldi, S., Law, R., and Gauduchon, M. (2002). Cheating and the evolutionary stability of mutualisms. *Proc. Roy. Soc. London B*, *269*, 773-780.
- Frank, S. A. (1994a). Genetics of mutualism: The evolution of altruism between species. *J. Theoret. Biol.*, *170*, 393-400.
- Frank, S. A. (1994b). Kin selection and virulence in the evolution of protocells and parasites. *Proc. Roy. Soc. London B*, *258*, 153-161.
- Frank, S. A. (1995). Mutual policing and repression of competition in the evolution of cooperative groups. *Nature*, *377*, 520-522.
- Frank, S. A. (1998). *Foundations of Social Evolution*. Princeton, NJ: Princeton University Press.
- Gardner, A., and West, S. A. (2004). Cooperation and punishment, especially in humans. *Am. Nat.*, *164*, 736-764.
- Gordon, D. M., Ryder, M. H., Heinrich, K., and Murphy, P. J. (1996). An experimental test of the rhizopine concept in *Rhizobium meliloti*. *Appl. Environ. Microbiol.*, *62*, 3991-3996.
- Gresshoff, P. M., and Rolfe, B. G. (1978). Viability of *Rhizobium* bacteroids isolated from soybean nodule protoplasts. *Planta*, *142*, 329-333.

- Gutschick, V. P. (1981). Evolved strategies in nitrogen acquisition by plants. *Am. Nat.*, *118*, 607-637.
- Hagen, M. J., and Hamrick, J. L. (1996a). A hierarchical analysis of population genetic structure in *Rhizobium leguminosarum* bv. *trifolii*. *Mol. Ecol.*, *5*, 177-186.
- Hagen, M. J. and Hamrick, J. L. (1996b). Population level processes in *Rhizobium leguminosarum* bv. *trifolii*: The role of founder effects. *Mol. Ecol.*, *5*, 707-714.
- Hahn, M., and Studer, D. (1986). Competitiveness of a *nif* *Bradyrhizobium japonicum* mutant against the wild-type strain. *FEMS Microbiol. Lett.*, *33*, 143-148.
- Hardin, G. (1968). The tragedy of the commons. The population problem has no technical solution; it requires a fundamental extension in morality. *Science*, *162*, 1243-1248.
- Hartwig, U., Boller, B., and Nösberger, J. (1987). Oxygen supply limits nitrogenase activity of clover nodules after defoliation. *Ann. Bot.*, *59*, 285-291.
- Henrich, J., and Boyd, R. (2001). Why people punish defectors? Weak conformist transmission can stabilize costly enforcement of norms in cooperative dilemmas. *J. Theoret. Biol.*, *208*, 79-89.
- Herre, E. A. (1993). Population structure and the evolution of virulence in nematode parasites of fig wasps. *Science*, *259*, 1442-1445.
- Herre, E. A., Knowlton, N., Mueller, U. G., and Rehner, S. A. (1999). The evolution of mutualisms: Exploring the paths between conflict and cooperation. *Trends Ecol. Evol.*, *14*, 49-53.
- Hetrick, B. A. D., Wilson, G. W. T., and Cox, T. S. (1993). Mycorrhizal dependence of modern wheat cultivars and ancestors: A synthesis. *Can. J. Bot.*, *71*, 512-518.
- Hirsch, A. M. (1999). Role of lectins (and rhizobial exopolysaccharides) in legume nodulation. *Curr. Opin. Plant Biol.*, *2*, 320-326.
- Hirsch, P. R. (1996). Population dynamics of indigenous and genetically modified rhizobia in the field. *New Phytol.*, *133*, 159-171.
- Jimenez, J., and Casadesus, J. (1989). An altruistic model of the *Rhizobium*-legume association. *J. Heredity*, *80*, 335-337.
- Kahn, M. L., Kraus, J., and Somerville, J. E. (1985). A model of nutrient exchange in the *Rhizobium*-legume symbiosis. In H. J. Evans, P. J. Bottomley and W. E. Newton (Eds.), *Nitrogen fixation research progress* (pp. 193-199). Dordrecht, The Netherlands: Nijhoff Publishing.
- Kiers, E. T., West, S. A., and Denison, R. F. (2002). Mediating mutualisms: The influence of farm management practices on the evolutionary maintenance of symbiont cooperation. *J. Appl. Ecol.*, *39*, 745-754.
- Kiers, E. T., Rousseau R. A., West, S. A., and Denison, R. F. (2003). Host sanctions and the legume rhizobium mutualism. *Nature*, *425*, 78-81.
- Kretovich, V. L., Romanov, V. I., Yushkova, L. A., Shramko, V. I., and Fedulova, N. G. (1977). Nitrogen fixation and poly- β -hydroxybutyric acid content in bacteroids of *Rhizobium lupini* and *Rhizobium leguminosarum*. *Plant Soil*, *48*, 291-302.
- Layzell, D. B., and Hunt, S. (1990). Oxygen and the regulation of nitrogen-fixation in legume nodules. *Physiol. Plant.*, *80*, 322-327.
- Leigh, Jr., E. G., and Rowell, T. E. (1995). The evolution of mutualism and other forms of harmony at various levels of biological organization. *Écologie*, *26*, 131-158.
- Lindemann, W. C., Schmidt, E. L., and Ham, G. E. (1974). Evidence for double infection within soybean nodules. *Soil Sci.*, *118*, 274-279.
- Lodwig, E. M., Hsieh, A. H. F., Bourdès, A., Findlay, K., Allaway, D., Karunakaran, R., et al. (2003). Amino-acid cycling drives nitrogen fixation in the legume-Rhizobium symbiosis. *Nature*, *422*, 722-726.
- Lodwig, E. M., and Poole, P. (2003). Metabolism of *Rhizobium* bacteroids. *Crit. Rev. Plant Sci.*, *22*, 37-78.
- Maske, G. G. B. (1989). Genetical analysis of the efficiency of VA mycorrhiza with spring wheat. *Agric. Ecosys. Environ.*, *29*, 273-280.
- Maynard-Smith, J., and Szathmary, E. (1995). *The Major Transitions in Evolution*. Oxford, UK: W.H. Freeman.
- McDermott, T. R., Graham, P. H., and Brandwein, D. H. (1987). Viability of *Bradyrhizobium japonicum* bacteroids. *Arch. Microbiol.*, *148*, 100-106.
- Murphy, P. J., Wexler, W., Grzemski, W., Rao, J. P., and Gordon, D. (1995). Rhizopines - their role in symbiosis and competition. *Soil Biol. Biochem.*, *27*, 525-529.
- Olivieri, I., and Frank, S. A. (1994). The evolution of nodulation in rhizobium: Altruism in the rhizosphere. *J. Heredity*, *85*, 46-47.

- Pate, J. S. (1986). Economy of symbiotic nitrogen fixation. In T.J. Givnish (Ed.), *On the economy of plant form and function* (pp. 299-326). Cambridge, UK: Cambridge University Press.
- Pellmyr, O., and Huth, C. J. (1994). Evolutionary stability of mutualism between yuccas and yucca moths. *Nature* 372, 257-260.
- Provorov, N. A. (1998). Coevolution of rhizobia with legumes: Facts and hypotheses. *Symbiosis*, 24, 337-368.
- Queller, D. C. (1992). Does population viscosity promote kin selection? *Trends Ecol. Evol.*, 7, 322-324.
- Queller, D. C. (1994). Genetic relatedness in viscous populations. *Evol. Ecol. Res.*, 8, 70-73.
- Ratnieks, F. L. W., Monnin, T., and Foster, K. R. (2001). Inclusive fitness theory: Novel predictions and tests in eusocial Hymenoptera. *Ann. Zool. Fennici*, 38, 201-214.
- Roche, P. F., Debelle, F., Mailliet, F., Lerouge, P., Faucher, C., Dénarié, J., and Prome, J. C. (1991). Molecular basis of symbiotic host specificity in *Rhizobium meliloti*: *nodH* and *nodPQ* genes encode the sulfation of lipo-oligosaccharide signals. *Cell*, 67, 1131-1143.
- Rolfe, B. G., and Gresshoff, P. M. (1980). *Rhizobium trifolii* mutant interactions during the establishment of nodulation in white clover. *Aust. J. Biol. Sci.*, 33, 491-504.
- Schwartz, M. W., and Hoeksema, J. D. (1998). Specialization and resource trade: Biological markets as a model of mutualisms. *Ecology*, 79, 1029-1038.
- Sheehy, J. E., Minchin, F. R., and Witty, J. F. (1983). Biological controls of the resistance to oxygen flux in nodules. *Ann. Bot.*, 52, 565-571.
- Simms, E. L., and Bever, J. D. (1998). Evolutionary dynamics of rhizopine within spatially structured rhizobium populations. *Proc. Roy. Soc. London B*, 265, 1713-1719.
- Simms, E. L., and Taylor, D. L. (2002). Partner choice in nitrogen-fixation mutualisms of legumes and rhizobia. *Integ. Comp. Biol.*, 42, 369-380.
- Singleton, P. W., and Stockinger, K. R. (1983). Compensation against ineffective nodulation in soybean. *Crop Sci.*, 23, 69-72.
- Souza, V., Bain, J., Silva, C., Bouchet, V., Valera, A., Marquez, E., et al. (1997). Ethnomicrobiology: Do agricultural practices modify the population structure of the nitrogen fixing bacteria *Rhizobium etli* biovar *phaseoli*. *J. Ethnobiol.*, 17, 249-266.
- Sprent, J. I., Sutherland, J. M., and de Faria, S. M. (1987). Some aspects of the biology of nitrogen-fixing organisms. *Phil. Trans. Roy. Soc. London B*, 317, 111-129.
- Sprent, J. I. (2003). Mutual sanctions. *Nature*, 422, 672-674.
- Taylor, P. D. (1992). Altruism in viscous populations - an inclusive fitness model. *Evol. Ecol.*, 6, 352-356.
- Thornton, H. G. (1930). The influence of the host plant in inducing parasitism in lucerne and clover nodules. *Proc. Roy. Soc. London B*, 106, 110-122.
- Thrall, P. H., Burdon, J. J., and Woods, M. J. (2000). Variation in the effectiveness of symbiotic associations between native rhizobia and temperate Australian legumes: Interactions within and between genera. *J. Appl. Ecol.*, 37, 52-65.
- Timmers, A. C. J., Soupene, E., Auriac, M. C., de Billy, F., Vasse, J., Boistard, P., et al. (2000). Saprophytic intracellular rhizobia in alfalfa nodules. *Mol. Plant-Microbe Interact.*, 13, 1204-1213.
- Trinick, M. J., Rhodes, R. L., and Galbraith, J. H. (1983). Competition between fast- and slow-growing tropical legume rhizobia for nodulation of *Vigna unguiculata*. *Plant Soil*, 73, 105-115.
- Udvardi, M. K., and Kahn, M. L. (1993). Evolution of the (Brady)Rhizobium-legume symbiosis: Why do bacteroids fix nitrogen? *Symbiosis*, 14, 87-101.
- Vance, C. P., Johnson, L. E. B., Halvorsen, A. M., Heichel, G. H., and Barnes, D. K. (1980). Histological and ultrastructural observations of *Medicago sativa* root nodule senescence after foliage removal. *Can. J. Bot.*, 58, 295-309.
- Vlassak, K. M., and Vanderleyden, J. (1997). Factors influencing nodule occupancy by inoculant rhizobia. *Crit. Rev. Plant Sci.*, 16, 163-229.
- West, S. A., and Herre, E. A. (1994). The ecology of the New World fig parasitizing wasps *Idarnes* and implications for the evolution of the fig-pollinator mutualism. *Proc. Roy. Soc. London B*, 258, 67-72.
- West, S. A., Murray, M. G., Machado, C. A., Griffin, A. S., and Herre, E. A. (2001). Testing Hamilton's rule with competition between relatives. *Nature*, 409, 510-513.
- West, S. A., Kiers, E. T., Simms, E. L., and Denison, R. F. (2002a). Sanctions and mutualism stability: Why do rhizobia fix nitrogen? *Proc. Roy. Soc. London B*, 269, 685-694.
- West, S. A., Kiers, E. T., Pen, L., and Denison, R. F. (2002b). Sanctions and mutualism stability: When should less beneficial mutualists be tolerated? *J. Evol. Biol.*, 15, 830-837.

- Williams, G. C., and Nesse, R. M. (1991). The dawn of Darwinian medicine. *Quart. Rev. Biol.*, 66, 1-22.
- Wong, P. P., and Evans, H. J. (1971). Poly- β -hydroxybutyrate utilization by soybean (*Glycine max* Merr.) nodules and assessment of its role in maintenance of nitrogenase activity. *Plant Physiol.*, 47, 750-755.
- Yu, D. W. (2001). Parasites of mutualisms. *Biol. J. Linn. Soc.*, 72, 529-546.
- Zhou, J. C., Tchan, Y. T., and Vincent, J. M. (1985). Reproductive capacity of bacteroids in nodules of *Trifolium repens* (L.) and *Glycine max* (L.) Merr. *Planta*, 163, 473-482.

Chapter 4

INOCULATION TECHNOLOGY FOR LEGUMES

D. F. HERRIDGE

*NSW Department of Primary Industries,
Tamworth Agricultural Institute,
4 Marsden Park Rd, Calala, NSW, Australia 2340*

1. INTRODUCTION

Inoculation of legumes with rhizobia is one of the success stories of world agriculture. Guthrie (1896) stated “it will prove to be one of the most valuable contributions ever made by science to practical agriculture. It is of special interest to us in Australia”. Guthrie showed remarkable foresight because now, more than 100 years later, legumes growing on 25 million ha of land in Australia fix US\$3–4 billion worth of N annually. Essentially all of that fixed-N can be attributed to current and past inoculation (Brockwell, 2004; Bullard *et al.*, 2005).

Early attempts at inoculation were rudimentary, like moving soil from fields of well-nodulated legumes to legume-free fields (Fred *et al.*, 1932). In early 20th century Canada, farmers were advised to treat legume seed with a mixture of glue and sieved air-dried soil from fields of well-nodulated plants of the target species (Walley *et al.*, 2004). Inoculation of legume seeds using pure cultures of rhizobia became possible after the groundbreaking work of both Hellriegel and Beijerinck in Europe in the 1880s (Perret *et al.*, 2000). Beijerinck first isolated and grew pure cultures of rhizobia and used them to infect legumes growing in sterile soil. Within a couple of years, cultures of rhizobia were available in the marketplaces of Europe for farmers to inoculate a range of species (Guthrie, 1896). Both inoculation of seed and soil were advocated.

Since that time, the production and distribution of legume inoculants have become established industries in many countries. Opinions differ on the current quantities of inoculants used by farmers. Singleton *et al.* (1997) suggested world

production of peat-based inoculants was about 2,000 tonnes annually, sufficient for 20 million ha of sown legumes, whereas Phillips (2004) calculated the area of legumes inoculated each year at 44 million ha or 25% of the sown legume area.

Phillips (2004) also reported that production and marketing of inoculants could be divided neatly into two. The Americas and Europe, which represented the primary commercial market, was supplied by just four manufacturers. Asia, the second market, was more fragmented with many manufacturers in both public and private sectors. More importantly, data (Phillips, 2004) suggest that farmers are discriminating in their use of inoculants. In North America, long-established crops, such as soybean, have low rates of inoculant application (15%) compared with very high rates (95%) for more recently cultivated pulses. Conversely, in Asia, where pulses have been grown for centuries, application rates are low (35%), but such low application rates may also reflect problems of supply rather than a management decision by the farmer (Thein and Hein, 1997).

This chapter summarises current knowledge about the production and use of legume inoculants. A number of excellent reviews have been published on the subject during the past 15 years, including Smith (1992), Brockwell *et al.* (1995), Bashan (1998), Stephens and Rask (2000), Lupwayi *et al.* (2000), Date (2001), Catroux *et al.* (2001), Deaker *et al.* (2004), and Bullard *et al.* (2005). In keeping with convention, the term “rhizobia” is used throughout to describe organisms within the genera *Allorhizobium*, *Azorhizobium*, *Bradyrhizobium*, *Mesorhizobium*, *Rhizobium* and *Sinorhizobium* (O’Hara *et al.*, 2003; Sprent, 2001).

2. THE NEED TO INOCULATE

2.1. Defining the Need

Legumes will potentially respond to inoculation if the demand for fixed-N by the plant cannot be met from the soil fixed-N supply and N₂ fixed as a result of nodulation by soil rhizobia already present. Soil fixed-N supply will mostly be insufficient to satisfy the total fixed-N demand of the growing legume, creating a need for effective nodulation. The challenge for farmers is knowing when to supplement the resident rhizobial population with additional rhizobia – the question of “When to inoculate?”

Guthrie (1896) was in no doubt that the benefits of inoculation would only be manifest in soil lacking the appropriate rhizobia, cautioning that inoculation would have little value in soil that had previously grown vigorous legumes of the same species. Sixty years later, Allen and Allen (1961) listed four criteria that would suggest a need for inoculation: (i) the absence of the same or a symbiotically-related legume in the land’s immediate past history; (ii) poor nodulation when the same crop was grown on the land previously; (iii) when the legume followed a non-legume in the rotation; and (iv) when the land was undergoing reclamation.

Defining the need to inoculate may not be that simple. Considerable research has been conducted during the past 40 years to assess effects of inoculation on both legume nodulation and yield and to relate qualitative (*i.e.*, genetic) and quantitative

changes in soil rhizobia to inoculation response. It is worth stating at this point that there are far less problems with over or unnecessary inoculation than with not using inoculants when they are needed. Unnecessary inoculation represents a small cost of production, whereas N-deficient crops mean substantial reduction of product and revenue.

2.2. Experimental Evidence for the Need to Inoculate

In field experiments assessing effects of inoculation on legume nodulation and yield, treatments generally include several rhizobial strains, plus un-inoculated and fertiliser-N controls. At various times during the growing season, plants are harvested and assessed for nodulation and biomass and/or grain yields. Such time-consuming experiments provide site- and season-specific results that are difficult to extrapolate without additional data on land use, soil fixed-N supply, and rhizobial numbers.

The International Network of Legume Inoculation Trials (INLIT) of the University of Hawaii's NifTAL project (Singleton *et al.*, 1992) assessed the need for inoculation in tropical agricultural systems. Responses to inoculation occurred for a range of species across regions (Table 1), most commonly for green gram (mungbean) and soybean and infrequently for common bean and pigeonpea.

Table 1. Inoculation responses of commonly-grown legumes in the INLIT program, conducted by the University of Hawaii (NifTAL) (from Singleton *et al.*, 1992).

Species	No. of trials	% trials with significant response to inoculation
Green gram	40	70
Soybean	40	65
Black gram	15	53
Groundnut	26	50
Cowpea	9	56
Chickpea	31	48
Lentil	27	48
<i>Leucaena</i>	8	38
Pigeonpea	8	13
Common bean	10	10
Other	14	36
Total	228	50

Factors contributing to variations in inoculation response were further examined in NifTAL's follow-up program, the Worldwide Rhizobial Ecology Network (WREN). These included edaphic characteristics, crop fixed-N demand and soil fixed-N supply and, most importantly, the number of infective rhizobia in the soil at sowing. Data from the 21 experiments in 17 countries showed that large responses to inoculation (139% yield increase) occurred with very high frequency

(93%) when populations of soil rhizobia were $<10 \text{ g}^{-1}$. For populations in the range $10\text{--}100 \text{ g}^{-1}$ soil, the size and frequency of response fell dramatically to 8% and 67%, respectively. Empirical modelling suggested a threshold of $100 \text{ rhizobia g}^{-1}$ soil for the response to inoculation to be economic, even though responses occurred (9% magnitude and 43% frequency) when soil populations were $>100 \text{ g}^{-1}$ soil. Responses to inoculation were not to be expected above a second threshold of $1000 \text{ rhizobia g}^{-1}$ soil (Thies *et al.*, 1991a; 1991b).

More recently, Vessey (2004) assessed the benefits of inoculating grain and pasture legumes in the northern Great Plains of the U.S. and Canada. For soybean, lentil, pea and fababean, 35–54% of the trials showed a positive effect of inoculation. Chickpea benefited in all trials but common bean responded to inoculation in only 31% of cases. Over all species, inoculation increased legume yield in 45% of cases.

Table 2. Summary of inoculation responses of grain legumes in soils of the northern Great Plains of the U.S. and Canada known to contain infective rhizobia (from Vessey, 2004)

Species	No. of site-years	% site-years with response to inoculation	Comments
Chickpea	8	100	No history of chickpea cultivation.
Soybean	26	54	Lack of response related to high soil nitrate and poor inoculant establishment
Lentil	30	53	Very large responses in established lentil areas on low N soils
Pea	58	36	Responses vary from nil to <i>ca.</i> 30%. Pea rhizobia widespread in soils
Fababean	23	35	More consistent responses than pea and lentil at same sites
Common bean	13	31	Strong cultivar effect on response to inoculation
Overall	158	45	

Most responses occurred when legume demand for fixed-N was relatively high, the soils were low in nitrate, or when populations of rhizobia in the soils (assessed as nodulation of the uninoculated controls) were either low or not sufficiently effective. Vessey (2004) concluded that inoculation was advisable for these species in the northern Great Plains, even when the particular soil had, or was likely to have, a population of infective rhizobia. Vessey's recommendation was made despite the fact that inoculation would probably be ineffectual for about half of the legume sowings.

This conservative approach to recommending inoculation is common and usually justified by the argument that unnecessary inoculation is preferable to the loss of economic yield resulting from inadequate nodulation and crop fixed-N deficiency (Hynes *et al.*, 1995; Kutcher *et al.*, 2002; McKenzie *et al.*, 2001).

Guidelines for inoculation that are specific for a farmer's sowing of a particular legume into a particular field should, however, be achievable.

2.3. Other Approaches to Determining the Need to Inoculate

Bonish (1979) used dilutions of soil samples to inoculate clover seedlings growing in test tubes to demonstrate simultaneously the population size and N₂-fixing capacity of the rhizobia in a soil. With subterranean clover and lucerne, Brockwell *et al.* (1988) concluded that a 28-day plant growth (N₂-fixation assay), termed the whole soil inoculation technique (WSIT), combined with a serial-dilution, plant-infection count of numbers of rhizobia, provided a reliable guide to the need for inoculation. The WSIT test is clearly most useful as a measure of the nodulating and N₂-fixing capacity of a soil inoculum for a particular legume. To that end, the symbiotic capacities of a range of soils from south-eastern Australia were measured for species and cultivars of clovers and medics with the aim of improving incompatible symbioses through management and breeding (Ballard and Charman, 2000; Ballard *et al.*, 2002; 2003; Charman and Ballard, 2004; Howieson and Ballard, 2004).

2.4. Rhizobial Numbers in Soil – Threshold for Inoculation

Determining the need for inoculation in a particular soil without having to do a field or laboratory test would be ideal. To do so requires that the size of the resident rhizobial population be predicted (see section 2.6) and matched against the minimum required for optimum nodulation and N₂ fixation. Finding agreement on this minimum number of rhizobia required in the soil for optimum nodulation and N₂ fixation is more problematic. The number could vary for different legumes and vary also with edaphic and environmental influences.

Despite the difficulties, 300 rhizobia g⁻¹ soil would appear to be a realistic threshold value to differentiate between soils that would or would not respond to inoculation. The number is consistent with the NifTAL modelling, published WSIT data, and other experiments (Ballard *et al.*, 2003; Denton *et al.*, 2000; Thies *et al.*, 1991a; 1991b). Research performed during the 1970s and 1980s, particularly in the USA, supported mandatory inoculation of legumes if the resident population was <100 rhizobia g⁻¹ soil, but viewed inoculation as unnecessary for populations >1000 rhizobia g⁻¹ soil (Weaver and Frederick, 1974a; 1974b).

There is a proviso, however, which is that moderately or highly effective rhizobia are well represented in the soil population. The value is irrelevant for soils containing rhizobial populations that are infective but essentially ineffective for a particular host legume. The legume in question may then need to be inoculated at greatly increased rates for the effective inoculant rhizobia to out-compete the resident, non-effective soil rhizobia (Ireland and Vincent, 1968; Weaver and Frederick, 1974a; 1974b).

2.5. Measuring Rhizobial Numbers in Soil

Scientists at NifTAL defined rhizobial populations in terms of climate (rainfall and temperature), soil physical and chemical properties (pH, clay content and water-holding capacity), and legume presence. In one study, soybean rhizobia were introduced into soil at 18 sites, representing a matrix of soil types and climates, and rhizobial numbers in the soils measured for the next two years (Woomer *et al.*, 1992). The numbers of rhizobia declined with time, with rates of decline influenced largely by climate and soil pH (Figure 1). Numbers were affected positively by rainfall and negatively by high temperature and low soil pH.

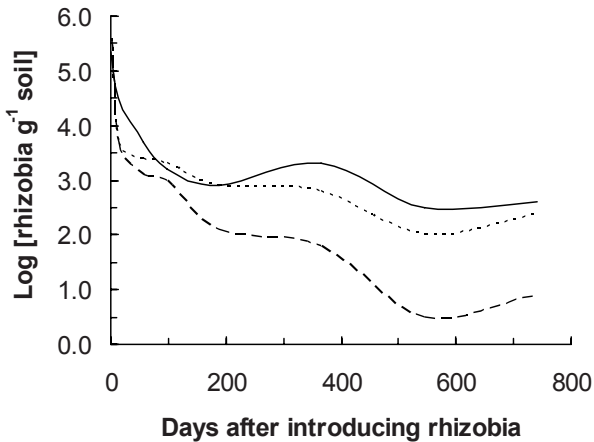

Figure 1. Decline with time in numbers of soybean rhizobia (*B. japonicum*) introduced into soils in cool/wet (—), warm/moist (.....) and hot/dry (---) environments on the island of Maui, Hawaii (from Woomer *et al.*, 1992).

The relationship between the presence of legumes and their rhizobia in soils is well established (Barclay *et al.*, 1994; Brockwell, 2001; Brockwell *et al.*, 1991; Brockwell and Robinson, 1970; Coventry and Hirth, 1992; Ireland and Vincent, 1968; Peoples *et al.*, 1995; Woomer *et al.*, 1988), but the factors controlling legume numbers also usually directly affect the rhizobia. Thus, in pastures, rhizobial numbers will be affected by the presence of the host legume and by edaphic and climatic factors that act either directly on the rhizobia or *via* the legume.

Arguably, the major edaphic factor is soil pH. Populations of medic rhizobia at 84 sites in eastern Australia ranged from near zero to 6.8×10^5 g⁻¹ soil, numbers closely matching the presence of the medic and strongly influenced by soil pH (Figure 2; Brockwell *et al.*, 1991). Soil pH effects vary with different species of rhizobia. Data accumulated from a number of studies shows pH effects on populations of clover and medic rhizobia in the top 10 cm of about 400 soils from Australia's agricultural regions (Figure 3). Soils containing >300 clover rhizobia g⁻¹ were in the pH_{Ca} range 3.7–7.9, but soils containing >300 medic rhizobia g⁻¹ were in the pH range 5.3–8.5. The acid soil limit for clover rhizobia appears to be about

pH_{Ca} 3.5 (see also Wood and Shepherd, 1987), but for medic rhizobia the limit appears to be about pH_{Ca} 4.7. Based on an inoculation-response threshold of 300 rhizobia g⁻¹ soil, 18% and 25% of the soils may have benefited from inoculation of sown clover and medic, respectively. Significantly, the soils were sampled during autumn, winter and spring, when rhizobial numbers were highest. In most agricultural soils, at least in Australia, numbers decline during the more hostile summers and early autumns, when soils are generally drier and temperatures hotter (e.g., Chatel and Parker, 1973; Evans *et al.*, 1988; Richardson and Simpson, 1988).

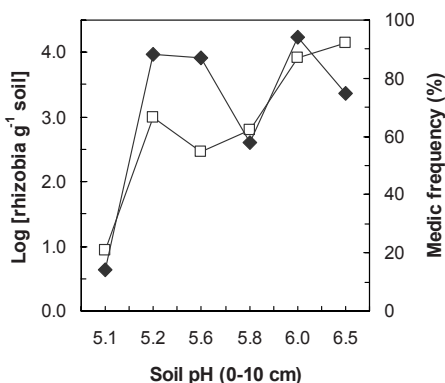

Figure 2. Effects of soil pH_{Ca} on medic frequency (◆) and numbers of rhizobia (□) in soils. Values from the 84 sites in the study summarised according to soil groups. Soil pH_{Ca} values calculated as (soil pH_{water} - 0.6). From Brockwell *et al.* (1991).

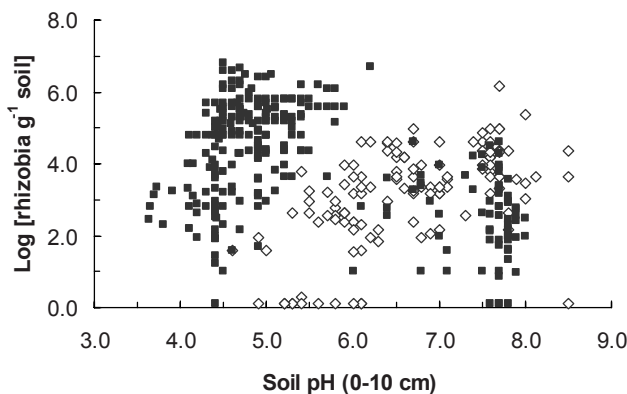

Figure 3. Effects of soil pH_{Ca} on numbers of both medic (◇) and clover rhizobia (■) in soils. The soils were collected from about 400 sites across Australia's agricultural regions. From Ballard and Charman (2000) and unpublished data; Ballard *et al.* (2002); (2003); Barclay *et al.* (1994); Bowman *et al.* (1998); Charman and Ballard (2004); Coventry and Hirth (1992); Denton *et al.* (2000); Evans *et al.* (1988); Richardson and Simpson (1988); Slattery and Coventry (1993).

Not all soil rhizobia are in the top 10 cm of the profile. Richardson and Simpson (1988) reported reasonable numbers of clover rhizobia to at least a depth of 25 cm in an acidic clay loam (Figure 4). Rhizobial numbers in soil were higher in spring compared with autumn, with positive effects from liming and pasture resowing. Rupela *et al.* (1987) showed that chickpea rhizobia were distributed in the soil profile to depths of at least 1.2 m. Depending on whether sampling preceded or followed chickpea growth, numbers varied between 10^2 and 10^3 g^{-1} soil. In both studies, populations were 10–100-fold greater in the top 10 cm than at depth. Because it is unlikely that rhizobial populations would be high at depth, but low or absent near the surface, sampling the top 10 cm of soil to determine the rhizobial population size would appear reasonable. However, rhizobia below 10 cm depth may play an active role in legume nodulation, particularly during late growth.

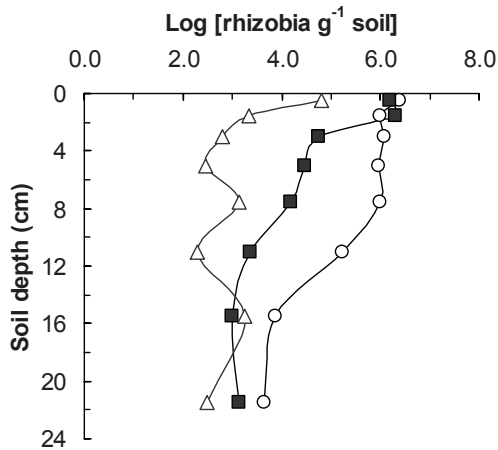

Figure 4. Numbers of clover rhizobia in soil under sown pasture in spring (○), natural pasture in spring (■) and natural pasture in autumn (Δ).
Redrawn from Richardson and Simpson (1988).

Factors other than presence of the host legume and soil pH also affect soil populations of rhizobia. Howieson and Ballard (2004) suggested that low clay content, low rainfall, high soil nitrate, salinity, and extremes of temperature stress rhizobia and reduce numbers. Their observations are consistent with those of the NifTAL programs (Figure 1) and of many other studies. The seriousness of these stress effects will likely be different for different rhizobial types.

2.6. Predicting Rhizobial Numbers in Soil

So, how do we progress with respect to the concept of predicting soil populations and, therefore, the need to inoculate, based on readily-collectable information on the history and/or current presence of the legume, hostility of the soil and environment, and soil pH. Legumes in pastures may show substantial spatial and temporal

variations, making it difficult to predict effects of legume presence on rhizobial numbers in the soil. For crop legumes, the key information for predicting effects of legume presence is time since the legume was last sown, information that is usually readily available.

The numbers of soybean rhizobia showed a steady decline following introduction into soil (Woomer *et al.*, 1992), with the decline accelerated by hot dry conditions (Figure 1). Other studies of crop legume rhizobia showed similar reductions in population size with time (Croizat *et al.*, 1982; Kucey and Hynes, 1989; Peoples *et al.*, 1995; Slattery and Coventry, 1989; Triplett *et al.*, 1993). What can be generalised is that populations of rhizobia build up to 10^5 – 10^6 g^{-1} soil in the presence of the crop and decline subsequently in its absence. In the more benign environments, *e.g.* fertile clay soils in a cool temperate climate, populations decline by about 0.5 log units per year but may remain at relatively high levels after 8–10 years (Figure 5).

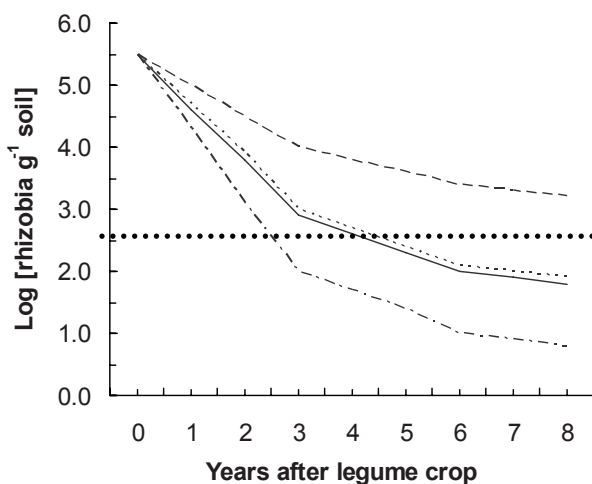

Figure 5. Schematic relationship of numbers of rhizobia in soil (0–10 cm) and years since a host legume was last grown.

For clay soil-cool environment (---), clay soil-hot environment (.....), sandy soil-cool environment (—), and sandy soil-hot environment (-.-.). The dotted line at 300 rhizobia g^{-1} soil is the threshold, above which inoculation would not be warranted. Values accumulated from Croizat *et al.* (1982); Kucey and Hynes (1989); Peoples *et al.* (1995); Slattery and Coventry (1989); Triplett *et al.* (1993); Weaver *et al.* (1972).

Soil pH is as critical for survival of the crop-legume rhizobia in the soil as it is for the pasture-legume rhizobia. Slattery *et al.* (2004), using the WSIT, reported dramatic effects of soil pH on the incidence of rhizobia nodulating vetch, lentil, pea, fababean, chickpea and lupin. The incidence of all rhizobia, except those for lupin, increased with increasing soil pH.

Compiling the data of Evans *et al.* (1993b), Carter *et al.* (1995), Ballard *et al.* (2004), and Evans (2005) showed that, for soils of pH <5.0, numbers of

R. leguminosarum bv. *viciae* declined rapidly in the absence of a host legume and essentially disappeared after 3 years (Figure 6). At no stage were the populations above the inoculation threshold of 300 g^{-1} soil. In less acidic soils ($\text{pH} > 5.0$), rhizobial numbers remained at higher levels for longer with populations not falling below 300 g^{-1} soil until about the sixth year.

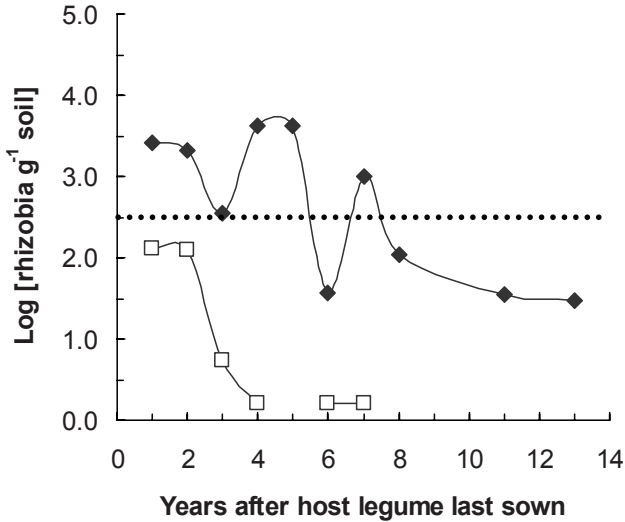

Figure 6. Decline in numbers of *R. leguminosarum* bv. *viciae* in soils of $\text{pH} (\text{CaCl}_2) > 5.0$ (◆) and < 5.0 (□) after sowing of either pea, fababeans, lentil, or vetch.

The dotted line at 300 rhizobia g^{-1} soil is the threshold, above which inoculation would not be warranted. Values compiled from Carter *et al.* (1995); Ballard *et al.* (2004); Evans (2005); Evans *et al.* (1993b).

Amarger (1988) quantified *R. leguminosarum* bv. *viciae* populations in 57 French soils, finding optima between pH 6.0–8.0 (populations *ca.* 10^5 g^{-1} soil) and lower and upper limits of pH 4.7 and 8.5. These critical soil pH values are very similar to those derived from the reports of Evans *et al.* (1993a; 1993b) and Carter *et al.* (1995) and are essentially identical to those for the medic rhizobia (Figure 3).

2.7. Predicting the Need to Inoculate

It should be possible to predict the need to inoculate the pea-fababeans group of legumes by using both a threshold value of 300 rhizobia g^{-1} soil and the relationships between soil pH , years since the crops were sown, and numbers of *R. leguminosarum* bv. *viciae* in soil (as constructed from Figures 5 and 6 and the data of Amarger (1988) in Figure 7). The modelled scenarios are for non-extreme environments. Rhizobial numbers would need to be reduced by 1 log unit for either hostile soil or environment and by 2 log units for the combination of hostile soil and hostile environment (see Figure 5).

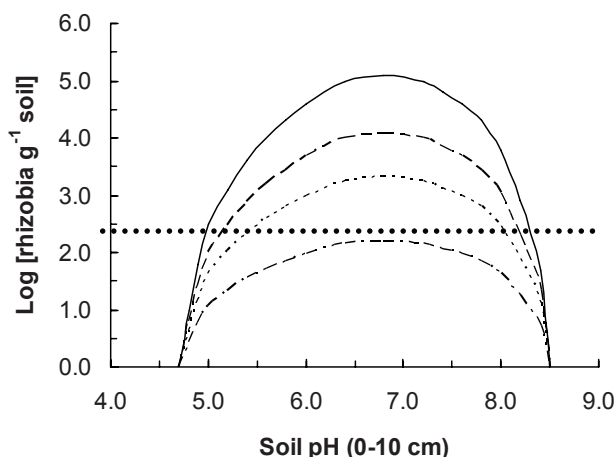

Figure 7. Schematic relationship between numbers of *R. leguminosarum* bv. *viciae* in soil to a depth of 10 cm and soil pH_{Ca} .

The top curve (—) represents a current crop of pea, fababean, lentil or vetch; the other curves are for 1 (---), 3 (.....) and 6 (-.-.-) years after sowing. The dotted line at 300 rhizobia g^{-1} soil is the threshold above which inoculation would not be warranted.

The situations that warrant inoculation, *i.e.*, when soil pH and years since the crop was last grown combine to reduce populations below 300 g^{-1} soil, are highlighted with a tick (check mark) in Table 3.

Table 3. Soil pH and crop history effects on likely response to inoculation for pea, lentil, vetch or fababean

Soil pH	Years since last sowing of pea, lentil, vetch, or fababean					
	1	2	3	4	5	6
5.0	√	√	√	√	√	√
5.5				√	√	√
6.0					√	√
6.5	Unlikely response to inoculation					√
7.0						√
7.5					√	√
8.0				√	√	√
8.5	√	√	√	√	√	√

As stated above, the scenarios are for soils with a reasonable clay content and moderate climate. Similar guidelines could be devised for other crop legumes, provided basic data on soil pH effects on rhizobial numbers were available. With the pasture and forage legumes, legume presence is more appropriate than time since the legume was last sown (Brockwell *et al.*, 1991).

3. SELECTION OF RHIZOBIAL STRAINS FOR USE IN INOCULANTS

3.1. *Desirable Traits for Inoculant Strains*

The search for new inoculant strains is ongoing and driven by the need to: (i) provide rhizobia for new legume cultivars and species; (ii) extend legume cultivation into new and/or hostile environments; and (iii) optimise productivity of currently-grown species. Keyser *et al.* (1992) and Brockwell *et al.* (1995) list the following characters as desirable for inoculant strains.

They should be able to:

- produce nodules and fix N₂ with the target legume - clearly, this is the primary attribute of an inoculant strain;
- compete in nodule formation with populations of rhizobia already present in the soil;
- fix N₂ with a wide range of host genotypes and species across different environments;
- form nodules and fix N₂ in the presence of soil nitrate;
- grow well in artificial media, in inoculant carriers, and in the soil;
- survive well on inoculated seed and in the carrier in storage;
- persist in the soil, particularly for annually regenerating legumes;
- migrate from the initial site of inoculation;
- colonise the soil in the absence of the legume host;
- tolerate environmental stresses;
- maintain genetic stability;
- be compatible with agrochemicals.

3.2. *The Australian Experience*

In Australia, 156 different rhizobial strains have been used in inoculants since 1953 (Bullard *et al.*, 2005), when 17 strains were used for just 25 legume species. By 2004, with a greatly expanded range of legumes in use, there were 35 inoculant strains covering 100 legumes, about three-quarters of which are pasture and forage species, mostly grown in temperate areas of the country. A second driver for more strains was the recognition of host \times strain specificity, resulting in a need, *e.g.*, for five different inoculant strains for clovers and two for medics.

Table 4 lists the current strains used in the major inoculant groups, their year of introduction, and their country of isolation. All the current Australian inoculants contain a single rhizobial strain, although this was not always the case (Bullard

et al., 2005). Most inoculant strains in Australia originated from outside the country and some strains, *e.g.*, CB1809, TA1, and CC829, have been used for many years. For the most part, however, there has been a steady turnover of inoculant strains over time.

Table 4. Rhizobial strains used in the major inoculant groups in Australia (from Bullard et al., 2005)

Inoculant group	Strains used since 1953	Current strain	Introduced in	Field isolate from -
Lucerne	10	RRI128	2000	Australia
Annual medic	10	WSM1115	2002	Greece
White clover	9	TA1	1956	Australia
Sub clover	7	WSM409	2000	Sardinia
<i>Lotus pedunculatus</i>	1	CC829	1958	Unknown
Serradella	3	WSM471	1996	Australia
Shaftal clover	1	CC2483g	1987	Macedonia
Pea	11	SU303	1992	Australia
Fababean	3	WSM1455	2002	Greece
Lupin	4	WU425	1970	Australia
Chickpea	2	CC1192	1977	Israel
Soybean	5	CB1809	1966	USA

Laboratories involved in the development and release of inoculant rhizobia use a variety of protocols for selecting particular strains. Howieson *et al.* (2000) reported that the program for inoculant strain selection at the Centre for *Rhizobium* Studies (CRS) in Western Australia involved four phases:

- phase 1 - rhizobial germplasm acquisition and maintenance as lyophilised cultures.
- phase 2 - glasshouse experiments to authenticate isolates as rhizobia and to screen for nodulation and N₂ fixation with particular hosts.
- phase 3 - assessment of elite strains from phase 2 in the field over 2–3 years for nodulation and N₂ fixation, and for ability to survive in and colonise soil in the absence of the host (cross-row experiments).
- phase 4 - final assessment of the most elite strains from phase 3, determined by independent researchers over a wide range of environments.

The above approach was used at the CRS in the mid 1990s to select inoculant strains for the pea, lentil, vetch and fababean group of legumes and associated species of *Pisum*, *Lens*, *Vicia* and *Lathyrus*. Strain SU303 was then the inoculant for all four genera but it was replaced by WSM1274 in 1998 for the *Lens-Vicia* group. SU303 remained the inoculant strain for the *Lathyrus-Pisum* group.

Subsequent experiments at the CRS and elsewhere in Australia showed that strain WSM1455 produced about 10% more yield of fababean and lentil than WSM1274 over a range of field sites and fixed an average of 27% more N with a wider range of species under glasshouse conditions (Howieson *et al.*, 2000; O'Hara

et al., 2002; J. Slattery, pers. comm.). In 2002, WSM1455 replaced WSM1274 as the inoculant strain for the *Lens-Vicia* group (Bullard *et al.*, 2005).

Strain WSM1483 was more effective on lentil than WSM1455 and equally effective on fababean, but lacked the broad-host range of the latter, being infective but either ineffective or partially effective with species of *Lathyrus*, *Pisum* and *Vicia* (Table 5). Because these species would be grown on the same land as lentil and fababean, inoculation with WSM1483 could have created a soil population of ineffective or partially effective but competitive (infective) rhizobia.

Table 5. Symbiotic interactions between potential inoculant strains of *R. leguminosarum* *bv.* *viciae* and their host legumes.

Legume	Strain of <i>R. leguminosarum</i> <i>bv.</i> <i>viciae</i>			
	WSM1274	WSM1455	WSM1483	SU303
Bitter vetch	?	E	E	e
<i>Lathyrus</i>	e	E	e	E
Pea	E	E	e	E
Narbon bean	E	E	I	E
Common vetch	E	E	e	E
Grasspea	e	E	I	e
Lentil	e	E	E	E
Fababean	E	E	E	E

E = effective nodulation; *e* = partially effective nodulation; *I* = ineffective nodulation; ? = unknown

The CRS program for strain selection thus encompasses most of the desirable traits listed above either directly or indirectly. Traits not tested routinely during strain selection are manufacturability, genetic stability, shelf life of inoculant, survival on seed, and compatibility with required seed-applied agrochemicals.

The experience in Australia is that virtually any strain can be manufactured into an inoculant. Generating acceptable numbers in the inoculant carrier, however, may be difficult with certain strains and replacements may be sought. For CB376, the highly-effective inoculant strain for *Lotononis bainesii*, the quality standard of 10^9 cells g^{-1} peat at manufacture was lowered to 2×10^8 g^{-1} peat because of the difficulty in achieving the former (Bullard *et al.*, 2005).

Genetic stability of inoculant strains, on the other hand, has been an ongoing issue for Australian inoculant manufacture and quality assurance since commercial production began 50 years ago (Bullard *et al.*, 2005). At least 19 inoculant strains have since been identified as varying in colony morphology and/or symbiotic traits (Bullard *et al.*, 2005; McInnes *et al.*, 2005). In most cases, the variations were picked up during quality assessment so avoiding nodulation failure in the field.

Variation in colony morphology, commonly associated with different levels of exopolysaccharide (EPS) production, is of little consequence for commercial inoculant production. Five of the current Australian inoculant strains produce both dry and mucoid colony variants (McInnes *et al.*, 2005). On the other hand, variation in symbiotic traits that may or may not be related to EPS production can have dire consequences and is not tolerated. McInnes *et al.* (2005) used glasshouse

effectiveness testing and polymerase chain reaction (PCR) fingerprinting to show that loss of effectiveness in a mucoid-colony isolate of WSM826, the commercial lucerne strain for 1992–2000, was not related to the level of EPS production or genetic drift. Strain WSM826 was replaced by RRI128 in 2000.

Survival of rhizobia on seed after inoculation has emerged in recent years as a particularly important trait in concert with the rapid increase in the use of pre-inoculated seed. There was considerable variation (1-89%) in survival rates on seed of birdsfoot trefoil between strains of *M. loti* following inoculation (Lowther and Patrick, 1995). The strains with the greatest survival rates generally produced the best field nodulation after sowing. Successful nodulation (Figure 8) and, in turn, plant establishment were found to be linear with surviving rhizobial numbers on seed. The authors lamented, however, that “Differences in the ability of strains to survive on seed has been recognised as a possible selection criteria for inoculant rhizobia...but appears to have been given little emphasis...”

This situation is now changing, at least in Australia, where a substantial amount of testing of rhizobial strains for survival on seeds and beads is currently underway and aimed both at understanding the mechanisms of good survival exhibited by *Sinorhizobium* spp. and at identifying better surviving strains within the relevant inoculant groups.

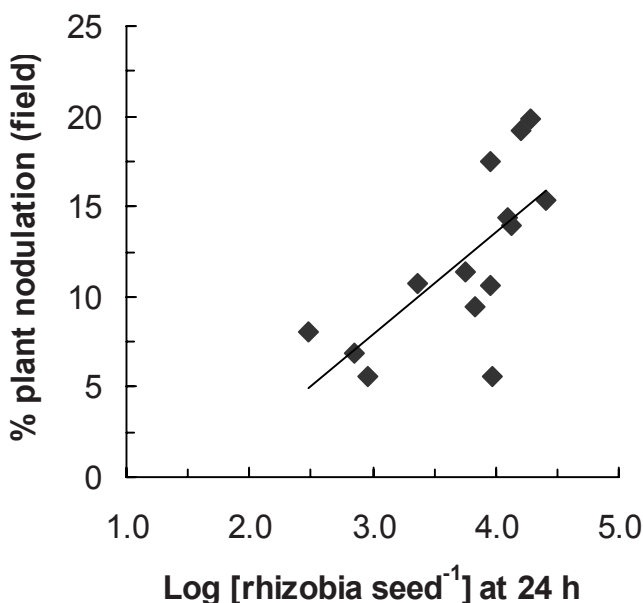

Figure 8. Relationship between numbers of *M. loti* on seed of birdsfoot trefoil 24 h after inoculation and subsequent nodulation of the plants sown into a hostile field environment ($p < 0.01$) (from Lowther and Patrick, 1995).

4. INOCULANTS IN THE MARKET PLACE

4.1. Importance of Rhizobial Numbers in Legume Inoculants

Catroux *et al.* (2001) stated that nodulation and yield are increased when the number of viable rhizobia inoculated per seed increases, as accomplished by having greater numbers of viable rhizobia in the inoculant itself, or by using higher-than-normal rates of inoculation, or by minimising the death of rhizobia after inoculation. All three strategies have merit and are discussed below.

The relationship between rhizobial numbers in the inoculant (quality) and inoculant efficacy was highlighted by Hiltbold *et al.* (1980) with commercial inoculants in Alabama, USA. Nodulation of soybean was directly related to numbers, with no nodulation produced by inoculants supplying $<10^3$ rhizobia seed⁻¹ and abundant nodulation by inoculants providing 10^5 - 10^6 rhizobia seed⁻¹. Grain yield increased linearly with increasing rhizobial numbers on the seed. Hume and Blair (1992) showed similar relationships between quality of commercial soybean inoculants in Canada and both nodulation and yield.

Using an approach of varying the inoculant rate to achieve a range of rhizobial numbers on the seed, Roughley *et al.* (1993) found that increasing the numbers of rhizobia applied to the seed of narrow-leafed lupin from 2×10^4 to 2×10^6 increased nodule number from 8 to 26 plant⁻¹, nodule weight from 65 to 393 mg plant⁻¹, shoot dry matter from 7.8 to 9.0 t ha⁻¹, and grain yield from 1.9 to 2.1 ha⁻¹. The responses to increasing numbers of inoculant rhizobia were almost linear (Figure 9).

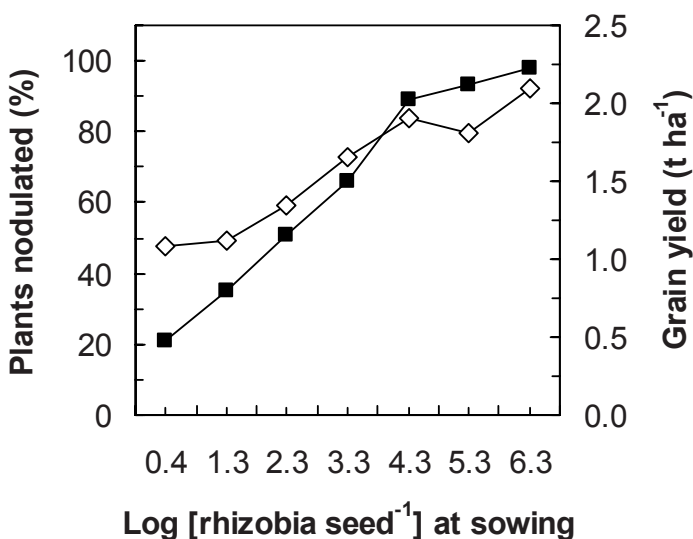

Figure 9. Numbers (\log_{10}) of rhizobia applied to seed of the narrow-leafed lupin at sowing and % plants nodulated (■) and grain yield (◇) (from Roughley *et al.*, 1993).

With soybean, Brockwell *et al.* (1985; 1989) reported linear relationships between rhizosphere populations of rhizobia and nodulation, plant growth, and grain yield, with the highest yields only when rhizosphere populations were $>10^5$ plant⁻¹. Soybean yields on land new to soybean increased an average 24%, when rhizobial numbers applied to seed were raised from 10^5 to 10^6 (Hume and Blair, 1992).

4.2. Inoculant Formulations

Rhizobial inoculants are supplied to farmers: (i) in a finely-milled solid carrier to be applied either to the legume seed prior to sowing or to the seeding row in the soil as a water suspension; (ii) in a solid carrier of larger particle size applied directly to the soil; or (iii) in liquid form applied to either the seed or the soil. In Asia, Africa, Europe and Australia, most inoculants are supplied in solid carriers, most commonly peat, for seed application (Bullard *et al.*, 2005; Catroux *et al.*, 2001; Kannaiyan, 2003; Singleton *et al.*, 1997). In N. and S. America, however, there is increasing interest in clay- and peat-based granular inoculants applied to the soil, and in seed-applied liquid inoculants (Singleton *et al.*, 2002; Walley *et al.*, 2004; Xavier *et al.*, 2004).

Thompson (1984) and Smith (1992) presented imposing lists of solid inoculant carriers grouped as:

- soils – peat, coal, lignite, and inorganic soil ;
- plant material - charcoal alone or with composted straw, composted or non-composted bagasse, coir dust, cellulose, soybean meal, rice husks, farmyard manure, composted corn cobs, and other composted plant materials;
- inert materials – vermiculite, perlite, bentonite, ground rock phosphate, calcium sulphate, talc, polyacrylamide gel, and alginate beads;
- combinations of the above - mixtures of soil and compost, mixtures of soil, peat, composted bark and wheat husks (Swedish mixture), and filter mud.

The drivers for the use of alternative carriers appear often to be supply and cost rather than a need to develop a carrier superior to peat (Smith, 1992).

Before the rhizobia are incorporated into the carrier, large numbers must be grown in pure culture. Procedures for rhizobial growth, including specifications for fermentors and growth media used in both starter cultures and fermentors, are well documented (Date and Roughley, 1977; Roughley, 1970; Somasegaran, 1991; Thompson, 1980; 1984). Fermentors range in size from a few litres to 1,000–2,000 litres, depending on the scale of operation. In less developed countries and less technically-advanced facilities in developed countries, large-scale fermentation may be almost impossible because of financial constraints, limited supply of components, and operational problems. In response, scientists at NifTAL determined that rhizobial cultures could be diluted as much as 1000-fold before addition to sterile peat without compromising quality (Somasegaran, 1985; Somasegaran and Halliday, 1982). Such a procedure has obvious benefits and allows the use of systems in which rhizobia are cultured in small, simple and inexpensive flasks and diluted before addition to peat.

4.2.1. Solid Inoculants Applied to the Seed or Soil as a Water Suspension

Peat is the most commonly-used carrier for rhizobial inoculants either applied to the seed before sowing or directly to the soil at sowing. Seed inoculation methods include dry or moist dusting of the inoculant onto the seed, applying inoculant as a slurry in water (with or without an adhesive and with or without an overlaying pellet of lime or other material), and, finally, vacuum impregnation (Deaker *et al.*, 2004; Gault, 1981; Smith, 1992). With direct soil inoculation (liquid inoculation, spray inoculation, and liquid injection inoculation), the inoculant is suspended in water and applied in the sowing furrows at a rate of about 100 L ha⁻¹ (Brockwell *et al.*, 1988; Gault, 1981; Gault *et al.*, 1982). Other carriers, such as lignite, composted corn cobs, bagasse, and rice husks, can be substituted for peat, depending on availability.

Sterilisation of the carrier results in higher numbers of the rhizobia in the inoculant and improved survival during storage. Roughley (1970) showed clearly the advantage of using peat sterilised by gamma irradiation. Rhizobial counts after just 1 week were 1–2 log units higher than in the non-irradiated peat. Olsen *et al.* (1995), in an evaluation of 40 non-sterile peat inoculants retailing in Canada, reported a relatively constant 10⁹–10¹⁰ contaminants g⁻¹ peat. Rhizobial numbers in the packets ranged from <10⁵ g⁻¹ peat to about 1.6x10⁹ g⁻¹ peat, with almost half containing <3x10⁸ rhizobia g⁻¹ peat. Contaminants, in order of numbers, were bacteria>actinomycetes>fungi, all outnumbering rhizobia in all but one sample. Many of the packets contained large numbers of bacterial contaminants that inhibited growth of clover and medic rhizobia. Olsen *et al.* (1996) further reported that 25% of surveyed inoculants contained opportunistic human pathogens as well as organisms inhibitory to rhizobia. A similar situation was reported for rhizobial inoculants in Argentina (Gomez *et al.* (1997).

Rhizobial inoculants made with sterilised carriers would, therefore, be expected to be superior in quality, but there are disadvantages in using sterilised carriers. These are higher cost, increased labour, the necessity of access to a sterilising unit of sufficient capacity, and the increased complexity of the production chain (Smith, 1992).

In Australia, France and the U.K., inoculants are made with irradiated peats, despite occasional problems with contaminants (Bullard *et al.*, 2005; Day, 1991; Wadoux, 1991). Autoclaving appears to be as effective as irradiation in reducing numbers of contaminants and aiding rhizobial growth and survival (Boonkerd, 1991; Roughley, 1970; Somasegaran, 1985) and is, or has been, used in Rwanda, Burundi, Zimbabwe, Kenya and Myanmar (Marufu *et al.*, 1995; Moudiongui *et al.*, 1991; Scaglia, 1991; Thein and Hein, 1997). In the USA, Canada and Thailand, non-sterilised peats remain the norm (Boonkerd, 1991; Nethery, 1991; Olsen *et al.*, 1995; Somasegaran, 1991), although inoculants in sterile carriers are readily available to North American farmers (Catroux *et al.*, 2001).

Details of the manufacture of peat and other solid inoculants made from plant and soil materials, including preparation and packaging of the carrier, inoculation of the carrier with rhizobia, and curing of the inoculated carrier, are available elsewhere (Date and Roughley, 1977; Smith, 1992; Thompson, 1984).

4.2.2. *Solid Inoculants Applied to the Soil*

Granular inoculants, also called soil or solid inoculants, were developed at least 40 years ago (Brockwell *et al.*, 1980) and widely used in the USA for at least 25 years (Bezdicsek *et al.*, 1978). Essentially, the granules are a peat prill or a solid inert core coated or impregnated with rhizobia. Core materials include bentonite, vermiculite, marble chips, sand, polythene beads, perlite, ground rock phosphate, polyacrylamide gel, and alginate beads (Brockwell *et al.*, 1980; Gault, 1981; Smith, 1992). Rates of application are generally 5–15 kg ha⁻¹, with the inoculant delivered into the seed row from a box (*e.g.*, a pesticide box) on the sowing frame (Catroux and Amarger, 1992; Deaker *et al.*, 2004; Smith, 1992). Major advantages of granular inoculants are ease of storage, handling, and application (Smith, 1992). Inoculation rates can be easily adjusted (Bezdicsek *et al.*, 1978) and placement of the inoculant relative to the seed can be controlled to facilitate lateral-root nodulation (section 4.2.6). Soil inoculation using granules separates the rhizobia from toxic seed-applied chemicals and seed-coat compounds (Brockwell *et al.*, 1980). Disadvantages are the bulk of the granules, the increased transport costs, the high rates of application, and problems if the granules are not free-flowing.

4.2.3. *Liquid Inoculants Applied to the Seed or Soil*

Liquid inoculants (not to be confused with liquid or spray inoculation) have also been used widely in the USA for a number of years (Smith, 1992). Normal application rates are 2–4 mL kg⁻¹ seed, with the inoculant applied to the seed either as a batch or continuously *via* an applicator as the seed is augered into the seed box. Less commonly, liquid inoculants are diluted with water and applied directly into the seeding row. With soil application, the rhizobia are delivered along the row, rather than concentrated around the germinating seed, resulting in slightly different patterns of nodulation (Brockwell *et al.*, 1988).

4.2.4. *Comparison of Inoculant Formulations – Efficacy*

Some generalisations can be made on the relative efficacies of the different inoculant formulations. With seed inoculation, using an adhesive to glue the inoculant onto the seed is better than applying the inoculant as a water slurry, which is, in turn, superior to dry dusting of the inoculant (Brockwell *et al.*, 1988; Deaker *et al.*, 2004). With the first method, adhesion of the rhizobia and carrier to the seed is improved and more inoculant ends up in the soil rather than in the planter. Adhesives also protect the rhizobia from dehydration and from seed-coat or external toxicities (Deaker *et al.*, 2004).

Soil inoculation using granules is generally superior to seed inoculation. In four field studies in N. America, granular inoculants produced an average 20% more grain yield than the seed-applied peat inoculants (Bezdicsek *et al.*, 1978; Clayton *et al.*, 2004b; Muldoon *et al.*, 1980; Rice and Olsen, 1992). Brockwell *et al.* (1980), however, reported equivalent nodulation and yields of legumes inoculated with granular and seed-applied peat inoculants, but when the seed was dressed with fungicides toxic to the rhizobia, soil inoculation with granules or peat suspended in

water (liquid inoculation) produced as much as 7-times the nodulation and 50% more yield than seed inoculation.

Granular and seed-applied peat inoculants are generally superior to seed-applied liquid inoculants (Clayton *et al.*, 2004b; Kutcher *et al.*, 2002; Kyei-Boahen *et al.*, 2002), with granular and peat-slurry inoculation of pea producing 50% and 28% higher yields than liquid inoculant (average of 6 experiments).

Liquid or spray inoculation, whereby peat inoculant is delivered into the seeding row as a suspension in water, is as efficacious as peat slurry inoculation (Brockwell *et al.*, 1980, 1988).

4.2.5. Comparison of Inoculant Formulations – Inoculum Potential and Effective Potential

Much of the difference in performance of the various inoculants and methods of inoculation can be explained by rhizobial numbers both in the inoculant itself and in what is eventually delivered to the soil near the seed. The importance of rhizobial numbers in inoculants was discussed in section 4.1, with the more, the better (Figure 9). Inoculant efficacy is affected also by the inoculation process and the time delay between inoculation and sowing (minutes to days), and conditions during that time. This is because death rates of the inoculant rhizobia during inoculation and pre-sowing differ substantially for the different formulations and methods of application.

During seed inoculation (0–1 h), 90% of lupin rhizobia died and, by the time the inoculated seed had been transported to the seed box and was about to be sown (5 h after inoculation), >99% of the inoculant rhizobia were either dead or had been dislodged from the seed (Roughley *et al.*, 1993). Thus, of the initial 1.5×10^6 rhizobia seed⁻¹ applied as inoculant, only 10^4 seed⁻¹ survived to be sown into the soil. Similar death rates were reported by Brockwell *et al.* (1988) for seed inoculation of soybean.

Roughley *et al.* (1993) concluded there was a need to distinguish between the inoculum potential applied to the seed and the effective potential, *i.e.*, the population of bacteria surviving on seed at sowing. Furthermore, they suggested that the effective potential would be improved more by increasing rhizobial survival *per se* than by providing even higher numbers in commercial peat-based inoculants.

The advantage of applying inoculants directly to the soil, rather than to the seed, is that death of the rhizobia in the time between seed inoculation and sowing is essentially eliminated, making inoculum potential and effective potential the same. Data from a recent soybean experiment (Table 6) highlight the low survival rates of rhizobia during the process of seed inoculation. The results showed that nearly 70-times more rhizobia were delivered to the soil in the granular inoculant than from the best of the seed inoculants. Differences would be further increased if toxic pesticides were also present on the seed (Brockwell *et al.*, 1980).

A reasonable conclusion is that the general superiority of granular over seed-applied inoculants is in part due to a greater effective potential. Placement of the inoculant rhizobia relative to the developing plant rhizosphere, however, may also have an effect.

Table 6. Theoretical and actual counts of soybean rhizobia seed⁻¹ or equivalent following inoculation and the % rhizobia surviving inoculation (from D. F. Herridge, N. Moore, E. Hartley and L. G. Gemell, unpublished data).

Formulation	Applied to:	Log no. rhizobia seed ⁻¹ or equivalent		% rhizobia surviving
		Theoretical	Actual	
Freeze-dried	Seed	5.53	4.62	12
Frozen paste	Seed	6.00	4.93	<1
Liquid	Seed	7.38	5.16	<1
Peat	Seed	6.45	5.37	8
Granular	Soil	7.20	7.20	100

4.2.6. Comparison of Inoculant Formulations – Nodulation Patterns, Implications for Yield and Seed Protein

Brockwell *et al.* (1988) argued that seed and soil (seed-bed) inoculation were fundamentally different, with seed inoculation resulting in rhizobia being concentrated near the seed and seed-bed inoculation distributing them along the seeding row, around and beneath the seed. The different spatial relationships between seed, rhizosphere, and rhizobia then result in different patterns of nodulation, with seed inoculation inducing more abundant nodulation than soil inoculation during early plant growth. The reverse occurs as the plants age and the root systems explore more soil (Figure 10).

Chickpea, which was either seed-inoculated with liquid or peat inoculants or soil-inoculated with granules, showed different nodulation patterns (Kyei-Boahen *et al.*, 2002). Crown nodulation as a percentage of total (crown + lateral) nodulation was 56% for the liquid inoculant and 70% for the peat (slurry) inoculant. Values for soil inoculation, by contrast, were 12% (granules applied below the seed) and 38% (granules applied with the seed) (Figure 11). Lateral root nodulation (30–44% for seed and 62–88% for soil inoculation) by more widely-dispersed inoculant rhizobia would have likely occurred later than crown nodulation.

Different nodulation patterns induced by seed and soil inoculation have implications for N₂ fixation during reproductive growth of the legume (Hardarson *et al.*, 1989; Wadisirisuk *et al.*, 1989) and, therefore, for seed yield and protein. Indeed, soil inoculation did enhance N₂ fixation, fixed-N accumulation during late pod-fill, and total plant fixed-N of pea (Clayton *et al.*, 2004a).

Seed protein levels for soil-inoculated soybean were an average of 12% higher than for seed-inoculated soybean (Muldoon *et al.*, 1980). Similarly, seed proteins and seed yields for soil-inoculated peas were, respectively, 5% and 6% higher than for seed-inoculated peas (Kutcher *et al.*, 2002). Soil-applied granular inoculants induced, on average, 12% higher seed-protein levels of pea than seed-applied peat or liquid inoculants, as well as substantially higher seed yields (Clayton *et al.*, 2004b), but Brockwell *et al.* (1988) and Kyei-Boahen *et al.* (2002) reported very similar yields and seed proteins for the best seed inoculation treatments and soil inoculation.

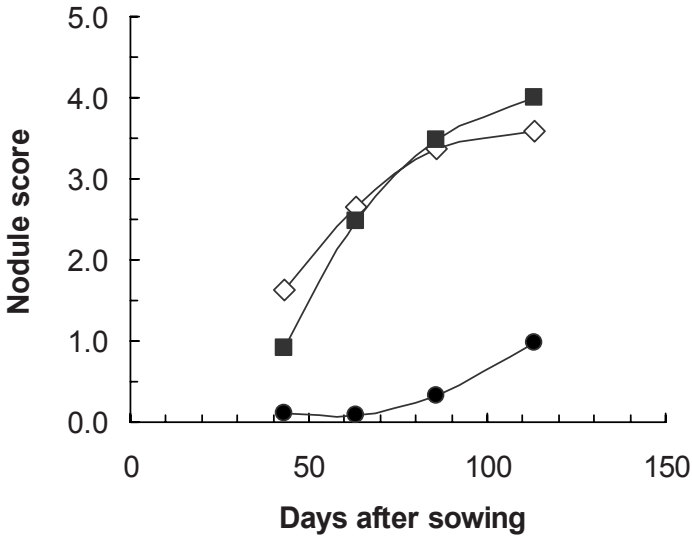

Figure 10. Nodulation patterns of soybean, inoculated with seed-applied (◇) and soil-applied (■), peat-based inoculants or uninoculated (●). Data are the means of two sites (from Brockwell et al., 1988).

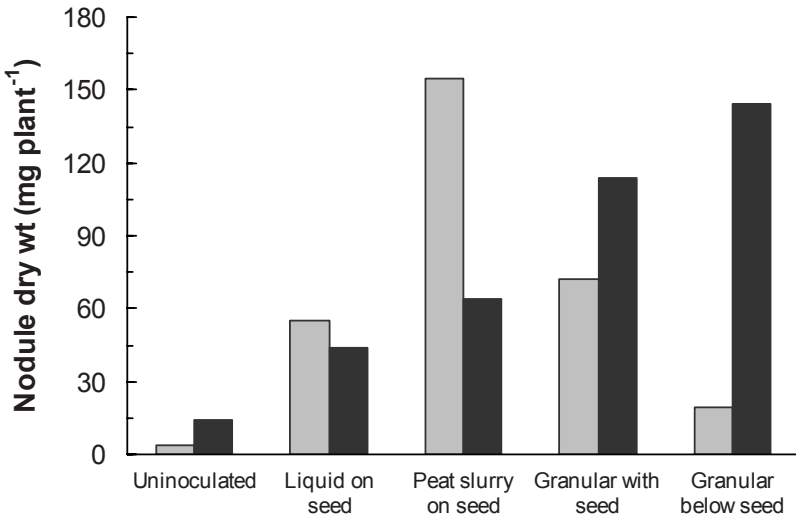

Figure 11. Effects of seed-coat and soil inoculation on the relative abundance of crown (lightly shaded bars) and lateral (solid bars) root nodulation of chickpea. Data are the means for product manufacturers, chickpea types, sites and years (from Kyei-Boahen et al., 2002).

4.3. Storage and Shelf Life

Other important considerations for inoculant efficacy are the age of the inoculant and the conditions of its storage. Most inoculants are not used immediately after manufacture and are likely to be 3–12 months old, or more, when used. Clearly, storage effects are less important if inoculant use is shortly after manufacture.

Unsterilised peat inoculants contain large numbers of contaminants that depress rhizobial numbers with time (Date and Roughley, 1977). After 12 months storage, irradiated peats contained 3-to-5-times the rhizobial numbers of autoclaved peats and 10-to-15-times those in non-sterile peats (Boonkerd, 1991). Even in sterilised carriers, viable rhizobial numbers fall with time, with death rates affected by carrier, strain, and temperature of storage. Boonkerd (2002) found that rhizobial survival was better in peat than in lignite, with numbers, after 2-months storage, 14-times higher (on average) in peat than in lignite. Similarly, rhizobia survived well during 7-month storage in peat, charcoal, or vermiculite, but not in milled peanut hulls or corn cobs (Sparrow and Ham, 1983).

Storage temperature has a large effect on inoculant shelf life. Using commercial inoculants then available in Australia, J. A. Thompson and coworkers (unpublished data) and Roughley (1982) confirmed the general benefits of cold (4°C) storage for soybean rhizobia (*B. japonicum*), medic rhizobia (*S. meliloti*), lupin rhizobia (*Bradyrhizobium* sp. (*Lupinus*)), and clover and pea rhizobia (*R. leguminosarum* spp.), but not the tropical legume rhizobia (*Bradyrhizobium* spp.) (Figure 12). However, there were substantial differences between species in survival at 26°C. The tropical legume and medic rhizobia maintained high numbers ($\sim 10^9$ g⁻¹ peat) after 12 months storage, but lupin, clover, and pea rhizobia declined in number during storage (data not shown) with counts at 12 months $< 10^8$ g⁻¹ peat.

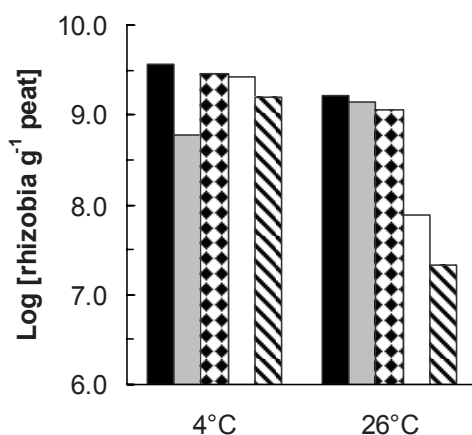

Figure 12. Effects of storage temperature (4°C and 26°C) on numbers of soybean rhizobia (solid bars), tropical legume rhizobia (lightly shaded bars), medic rhizobia (black-white diamond bars), lupin rhizobia (open bars), and clover-pea rhizobia (striped bars) in peat inoculants stored for 12 months (from unpublished data of J.A. Thompson).

Inoculants can encounter temperatures $>26^{\circ}\text{C}$, both in storage and transport. Those despatched from the NifTAL laboratory in Hawaii to various tropical countries were exposed to temperatures of $>40^{\circ}\text{C}$ (Somasegaran *et al.*, 1984), as were Australian inoculants despatched from Gosford to destinations in tropical Australia and in Indonesia (Roughley *et al.*, 1995). The latter study showed that inoculants in sterilised peat containing soybean, lupin, or medic rhizobia could be stored for one month at temperatures of up to 35°C without adversely affecting numbers. With clover inoculants, however, numbers declined when temperature of storage exceeded 25°C . Rhizobial counts fell for all inoculants stored at 40°C . Interestingly, rhizobial numbers depressed after storage at 40°C recovered when the peats were transferred to 25°C , leading to the suggestion that re-incubating the peats at $\sim 25^{\circ}\text{C}$ was a practical way to deal with short-term high-temperature stress.

Other studies had previously shown loss of infectiveness of rhizobia exposed to short-term (7 days) high temperatures ($35\text{--}37^{\circ}\text{C}$) (Morrison *et al.*, 1983; Wilson and Trang, 1980), but Roughley *et al.* (1995) found no diminution of infectivity related to high-temperature exposure.

Other factors affecting survival of rhizobia in solid carriers are packaging material (affecting gas and water exchange), and carrier moisture content (Date and Roughley, 1977). Thus, conditions of storage clearly need to be well managed to maximise shelf life and ensure high quality commercial inoculants are available to farmers. Under optimal conditions, sterilised peat inoculants containing *Bradyrhizobium* spp. and *Sinorhizobium* spp. can maintain high rhizobial counts after 5–6 years (Biederbeck and Geissler, 1993; Revellin *et al.*, 2000). However, numbers of *R. leguminosarum* spp. may decline more rapidly during storage and limit shelf life (E. Hartley, L.G. Gemell and D.F. Herridge, unpublished data).

4.4. Age of Stored Inoculants and Efficacy

With long-term inoculant storage, changes in rhizobial cell characteristics may reduce efficacy. As the age of soybean inoculants increased (1–8 years), the time for colony appearance on a plate and for nodulation in tube culture increased (Revellin *et al.*, 2000). The sensitivity of the rhizobial cells to desiccation increased, decreasing survival on seed, and an increased number of cells had compromised membranes (Catroux *et al.*, 2001), suggesting a decline in the fitness of the survivors.

In a field experiment, nodulation and accumulation of both dry matter and fixed-N in shoots and grain of soybean inoculated with stored inoculants were compared with those given fresh inoculants at different rates. Efficiency ratings calculated for the stored inoculants (Table 7) suggest a rapid decline in inoculant efficiency after manufacture (Revellin *et al.*, 2000), although recalculation of the efficiency factor using criteria other than grain yield, *e.g.*, shoot N, might affect absolute values. What is clear from all facets of the study, however, is that a substantial decline in quality of inoculant would be expected after four years of storage.

Table 7. Effects of time of storage on numbers and 'efficiency' of soybean rhizobia in peat inoculant. Efficiency was determined by comparing the field efficacy of the inoculant with that of a fresh inoculant (from Revellin *et al.*, 2000).

Storage time (years)	Plate count (log rhizobia g ⁻¹ peat)	% efficiency	Actual count (log rhizobia g ⁻¹ peat)
1	9.59	36	9.15
4	9.10	42	8.72
6	8.30	11	7.34
7	7.26	3	6.00
8	7.30	5	6.00

5. PRE-INOCULATED AND CUSTOM-INOCULATED SEED

Pre-inoculation is the application of rhizobia to seed prior to its sale to farmers. Pre-inoculated seed may be stored for as long as 1–2 years before use. Custom inoculation, on the other hand, is done upon request of a farmer, with the seed sown within a few days. In the USA, Canada and Australia, farmers often prefer the convenience of buying pre- or custom-inoculated pasture seed. Pre-inoculation has two main forms. The first type involves rhizobia being applied to the seed as a peat slurry, using a sticker, and the seed then pelleted with a coating of lime, growth factors, mineral additives, and pesticides in various combinations (Brockwell, 1977). In N. America, a second type of pre-inoculation involves dusting rhizobia onto seed in finely-ground clay-based inoculants. The recommended shelf lives of pre-inoculated seed vary from 2–3 months to 12–18 months, according to species and manufacturer (Gemell *et al.*, 2005; Smith, 1991).

Although pre-inoculated seed may be attractive to the farmer, quality (number of rhizobia per seed) is variable. A 1972–74 survey in Australia of commercial pre-inoculated seed of woolly pod vetch, clover and medic species found that, on average, it carried <1% of the rhizobial numbers on freshly-inoculated seed (Brockwell *et al.*, 1975). Only 2% of batches passed the Australian quality standards for pre-inoculated seed (500 rhizobia seed⁻¹ for very small-seeded species, like white clover, and 1,000 rhizobia seed⁻¹ for larger-seeded species, like lucerne).

In a follow-up survey (1999–2003), average rhizobial counts were 8,400 seed⁻¹ for pre-inoculated lucerne, 1,380 seed⁻¹ for subterranean clover, and <100 seed⁻¹ for white and red clovers and for a group of other species (Gemell *et al.*, 2005). The quality standards were met for 73% of samples for lucerne and for 32% of samples for subterranean clover, but fell to 0–4% of samples for white clover, red clover and other species.

In Australia, shelf lives of pre-inoculated seed need to be redefined according to the ability of the rhizobia to survive on seed. Based on the survey results and on survival studies of different rhizobia on seed, Gemell *et al.* (2005) recommended shelf lives of 6 months for pre-inoculated lucerne and annual medics, 6 weeks for subterranean clover, and 2 weeks for white clover, red clover and other species.

The industry also needs to manage stock to prevent expired pre-inoculated seed being sold. The median age of pre-inoculated seed in two years of the survey was 90 days (<3 days for custom-inoculated seed). Some pre-inoculated seed still remained on sale after >2 years! Enhancing survival of clover rhizobia during inoculation, pelleting, and storage remains a high priority for future research.

6. CO-INOCULATION OF LEGUMES WITH RHIZOBIA AND OTHER BENEFICIAL MICROORGANISMS

An array of bacteria and fungi with plant growth-promoting (PGP) effects on legumes could potentially be applied to seed or soil as co-inoculants with rhizobia (Bashan, 1998; Nelson, 2004; Wakelin and Ryder, 2004; Xavier *et al.*, 2004). These microorganisms potentially enhance legume growth through: (a) associative, biological N₂ fixation (*e.g.*, *Azospirillum*); (b) production of hormones that increase root growth, nodulation, and water and nutrient exploitation (*e.g.*, *Azospirillum* and *Bacillus* spp.); (c) mobilising soil phosphorus and iron into plant-available forms (*e.g.*, bacteria like *Pseudomonas* and *Bacillus* spp. and fungi like *Aspergillus* and *Penicillium* spp.); and (d) control of soil-borne disease (*e.g.*, bacteria like *Pseudomonas* spp. and fungi like *Trichoderma* spp) and insects (*e.g.*, *Metarhizium*).

The plant growth-promoting rhizobacteria, PGPR, could be co-cultured with the rhizobia in the same carrier. However, Stephens and Rask (2000) highlighted the problem of maintaining cell numbers when rhizobia and PGPRs are co-cultured. After seven days incubation in peat, five of six combinations of rhizobia and either *Pseudomonas* or *Bacillus* spp. had lower numbers of either the rhizobia or the PGPR or both. They suggested that strains of rhizobia and potential co-inoculants be screened for compatibility, both at the stage of culture and once inoculated into the field. A fungal co-inoculant, on the other hand, would likely be in a separate carrier, although not always. In Canada, Rice *et al.* (1995) successfully co-cultured rhizobia and *Penicillium bilaii* in a sterile peat carrier, leading to the release of TagTeam® by a North American inoculant manufacturer.

Efficacies of the PGP microorganisms in the field are inconsistent, with positive results often outweighed by neutral effects (Bowen and Rovira, 1999; Nelson, 2004; Rice *et al.*, 1995). Chanway *et al.* (1989) reported significant improvements in growth and nodulation of lentil co-inoculated with rhizobia and *Pseudomonas putida*, but not for pea inoculated with the same combinations. Growth responses for lentil reached 16% in the field and 46% in sand columns in a growth chamber. Also in Canada, co-inoculation with rhizobia and *Bacillus cereus* UW85 produced positive grain yield and N responses of soybean, but not common bean (Bullied *et al.*, 2002). The UW85 strain had, in earlier work by Osburn *et al.* (1995), given soybean yield responses of 0–139%, which were influenced by site, growing season, inoculant formulation, and cultivar resistance to the pathogen, *Phytophthora sojae*. Further, although mixtures of *Rhizobium-Azospirillum* inoculants on lucerne and birdsfoot trefoil gave non-significant responses (Dutto *et al.*, 2000), Okon (2000) found that co-inoculation of various legumes with such

mixtures produced promising results, with the *Azospirillum* influencing nodulation patterns through modifications to the roots.

Co-inoculation of legumes with rhizobia and other microorganisms is an appealing technology that is constrained by inconsistent field performance (*e.g.*, Liu and Sinclair, 1990). Arguably, more research is required to better understand how plant growth promotion works for particular plant-microorganism combinations (Nelson, 2004). Improved delivery and establishment of the microorganisms into soil may also be needed. Unlike the specific nature of the legume-rhizobia association that aids rhizosphere colonisation and nodulation by the latter, the apparent lack of specific association between the PGP microorganisms and host plants may well represent a formidable barrier to successful field establishment (Bashan, 1998; Nelson, 2004).

7. QUALITY CONTROL OF LEGUME INOCULANTS

7.1. Standards and Quality Control

Successful production of rhizobial inoculants is often associated with an effective regulatory Quality Control (QC) program, which may be supported by appropriate legislation (as in Canada, Uruguay, and France) or may be voluntary (as in Australia, Thailand, New Zealand, and South Africa). In other countries, like the USA, regulatory control and independent testing are considered unnecessary, with manufacturers conducting their own internal QC. All QC programs monitor the numbers and quality of the strains in the inoculants as well as the numbers of contaminating microorganisms.

The successful use of inoculants depends on quality. If the quality is poor, then benefits from inoculation are highly unlikely. In India, 90% of inoculants sampled had $<10^8$ rhizobia g^{-1} carrier and all samples were contaminated (Thompson, 1992). A NifTAL survey gave similar findings; about half had $<10^8$ rhizobia g^{-1} carrier (Singleton *et al.*, 1997), with rhizobial numbers inversely related to the numbers of microbial contaminants. Such results indicate problems with production and factory-level QC and a clear need for regulation and enforcement of inoculant quality standards. Ideally, inoculants are produced by the private sector with standards enforced by an independent government agency, like the national Department of Agriculture.

Quality standards and their enforcement vary between countries. In theory, rhizobial inoculants should contain sufficient cells of the appropriate strain for optimal nodulation of the target legume under all conditions. In reality, standards are usually a compromise between the requirement of the legume and the ability of the manufacturer to routinely produce such a product. Quality standards, therefore, vary substantially between countries (Date and Roughley, 1977; Smith, 1992).

In Canada, rhizobial inoculants come under the Fertilisers Act (Lupwayi *et al.*, 2000; Rennie, 1991). Companies wanting to sell inoculants in Canada must submit a registration to Agriculture Canada with data showing the product's efficacy. Agriculture Canada inspectors randomly collect and test inoculants each year from

factory and sales outlets. Standards state that the peat inoculant must provide 10^3 – 10^5 rhizobia seed⁻¹ (depending on seed size), but the numbers have been questioned as being too low by a log unit (Hume and Blair, 1992; Olsen *et al.*, 1994). Granular inoculants are required to deliver 10^{11} rhizobia ha⁻¹ which, at a rate of 10 kg ha⁻¹, translates into 10^7 g⁻¹ granules. After more than two decades of testing, the quality of Canadian inoculants has improved substantially. When testing began in the early 1970s, the pass rate was <50%, but it improved to 95% by 1998 (Lupwayi *et al.*, 2000).

French legislation covering inoculants has slightly different standards and procedures (Wadoux, 1991). Inoculants must be registered for sale in France, must be accompanied by proof of efficacy, and must not be harmful to non-target crops, animals, humans, and the environment. All inoculants are produced in sterile carriers. Inoculants must be able to deliver the equivalent of 10^6 rhizobia/soybean seed. They are batch tested by INRA, Dijon, and certified if they pass the standard. They are retested if presented for sale in a second season.

By contrast, Thailand has no legislation for inoculants, but there are national standards and independent testing conducted by the Thai Department of Agriculture (Boonkerd, 1991). Standards mean that a soybean seed should receive 10^5 – 10^6 rhizobia, so requiring freshly-manufactured inoculant to have $>10^8$ g⁻¹ peat. Non-sterile carriers are used in the belief that inoculants will be used shortly after manufacture.

7.2. Public and Private Sector Involvement

The desirability of public (*e.g.*, Departments of Agriculture and universities) and private sector involvement in inoculant R&D, QC, production, and marketing has been recognised for some time. Singleton *et al.* (1997) suggested appropriate roles for both sectors, with the roles being relevant to both developed and developing countries (Table 8).

Table 8. Suggested roles for the public and private sectors in inoculant R&D, QC, production, and marketing (adapted from Singleton *et al.*, 1997).

Public Sector	Private Sector
Rhizobium strain evaluation	Product development
Rhizobium culture maintenance	Rhizobium culture maintenance
Applied Research	Manufacturing
Technical assistance	Market development
Training: extension, industry, farmers	Marketing/distribution
Quality standards	Internal QC
External QC	

In practice, public and private sector roles are often blurred. Many countries, for example, have at least rudimentary inoculant production units in public institutions, often euphemistically called ‘pilot production’. They usually aim to

establish the technical feasibility of production, to demonstrate inoculants and inoculation to farmers, and to raise awareness of the benefits of inoculation among users and policymakers. Few pilot facilities develop into larger private sector operations or significantly increase market penetration perhaps because of the research, rather than commercial, focus of public institutions. The performance indicators of research (new knowledge, scientific publications) are at odds with those of a private-sector company (product development and quality, market acceptance, sales and especially profit). Ideally, public facilities should shift as quickly as possible from manufacturing inoculants to providing R&D support, and perhaps external QC, leaving manufacturing and marketing to the private sector (Singleton *et al.*, 1997).

Proper authentication and maintenance of rhizobial cultures is critical for inoculant quality. Many inoculants that purport to contain particular strains or species of rhizobia do not do so, and may contain no rhizobia at all (Lupwayi *et al.*, 2000; Singleton *et al.*, 1997). The problems arise when elite rhizobial strains are freely exchanged around the world but inadequate resources in the receiving laboratory prevent proper authentication and long-term maintenance. Recommended techniques for the latter are cryopreservation and freeze-drying (Lupwayi *et al.*, 2000). The same need for proper strain authentication and long-term maintenance applies to locally-sourced rhizobia that are used in inoculants.

7.3. *Quality Control - the Australian Experience*

Australian farmers have strongly embraced rhizobial inoculation of legumes. Currently, 35 different rhizobial inoculants for about 100 legume species are produced and sold, with data suggesting that Australian farmers inoculate about 2 million ha of legumes annually, about 50% of the total area sown. With chickpea and soybean, it is likely that close to 100% of the sown area is inoculated.

Legume inoculation using pure agar cultures of rhizobia commenced in Australia in 1914 (Brockwell, 2004). During the 1940s and early 1950s, legume sowings increased substantially, particularly for improved pastures, prompting private-sector involvement in the manufacture and sale of inoculants in 1953 (Vincent, 1954). Widespread nodulation failures of sown legumes quickly followed, prompting three reports on the fledgling industry (Brockwell, 1954; Vincent, 1954; Waters, 1954). The Waters and Brockwell papers highlighted the fact that inoculants produced then were generally unsatisfactory, containing low numbers of effective rhizobia and high numbers of contaminants. Vincent (1954) asserted that poor quality inoculants resulted in legume nodulation failures that cost farmers dearly in lost production and would eventually discredit the practice of rhizobial inoculation. He recommended the following:

- a licensing authority to work with the inoculant manufacturers and to check inoculants for rhizobial numbers and effectiveness;
- clear labelling stating the legume host for which the inoculant should be used;
- the packet should state the shelf life, conditions of storage, and method of application to seed of the inoculant;

- peat inoculants have sufficient rhizobia to provide minimum numbers of cells seed⁻¹, with 1,000 cells seed⁻¹ at manufacture and falling to 100 cells seed⁻¹ by the expiry date of the inoculant, with the numbers of contaminants less than the numbers of rhizobia; and
- withdrawal from the marketplace of particular inoculant batches, if problems of inoculant quality were highlighted by the licencing authority.

Inoculant testing (Brockwell, 1954; Waters, 1954) and the Vincent (1954) recommendations resulted in the first Australian Legume Nodulation conference in 1955 and formation of U-DALS (University - Department of Agriculture Laboratory Service) in 1957. The U-DALS unit, set up as a collaborative venture by the inoculant manufacturers and government and university researchers, had a mandate to provide quality control for and trouble-shoot commercial inoculant production in Australia (Brockwell, 2004). In 1971, U-DALS was disbanded and replaced by the Australian Inoculants Research and Control Service (AIRCS), renamed the Australian Legume Inoculants Research Unit (ALIRU) in 2000.

Throughout an almost 50-year history under the stewardship of seven different officers-in-charge (J.M. Vincent, L. Waters, J.A. Ireland, R.A. Date, R.J. Roughley, J.A. Thompson and D.F. Herridge), the function and *modus operandi* of the independent testing unit has changed little (Bullard *et al.*, 2005). Operational funding has come at various times and in various proportions from manufacturers, government institutions, and primary industry R&D fund providers.

7.3.1. Testing Inoculants

ALIRU tests samples from all batches of commercial inoculants for strain trueness, numbers of rhizobia and contaminants, nodulating capacity, and peat moisture [see Bullard *et al.* (2005) for details]. Five of seven packets are tested initially from each batch, usually within weeks of manufacture. If one of them fails to reach the standard, the final two packets are tested. Once the testing of a batch is complete, the manufacturers receive a certificate stating the outcomes of the tests and whether or not the batch meets Australian standards. It also includes an expiry date for the batch, which is 12 months from the testing date for all inoculant groups except the lupin, chickpea and fababeans/lentil groups, which are given 18 months. Batches nearing their expiry date can be resubmitted and, if standards are met, a further 6 months currency is given.

Failure rates varied considerably during the past 40 years with peaks of 20–25% of the batches tested; failure was usually associated with strain instability and changes in the process of manufacture. In the early 1970's, high salt levels in the peat created considerable problems until a new source of peat was found (Bullard *et al.*, 2005; Steinborn and Roughley, 1974). Current failure rates are about 5%.

7.3.2. Strain Improvement and Mother Culture Maintenance and Supply

ALIRU recommends, through its national steering committee, strains of rhizobia for all inoculants produced and sold in Australia and supplies mother cultures of the

strains to the manufacturers on an annual basis. ALIRU also maintains elite strains for advanced strain evaluation and supplies them to the national R&D program.

General requirements for inoculant strains are broad-range effectiveness within an inoculant group, survival on seed (particularly for pasture species), ability to be cultured, and genetic stability (see section 3.1.). ALIRU protocols for evaluating strains require field testing of elite material for 2–3 years in diverse environments, usually after extensive glasshouse screening (Bullard *et al.*, 2005).

7.3.3. *Pre-inoculated Seed Testing*

Because many Australian farmers prefer the convenience of buying pasture legume seed that has been pre-inoculated or custom inoculated with rhizobia, sales of pre-inoculated seed have grown exponentially in recent years. During 1999–2003, ALIRU tested almost 300 pre-inoculated and custom-inoculated seed samples from commercial retailers. Quality ranged from generally satisfactory for pre-inoculated lucerne to very low for white and red clover and a group of miscellaneous species (see section 5.). The current ALIRU standards for Australian pre-inoculated seed are 500 rhizobia seed⁻¹ for the very small seeded legumes, *e.g.* white clover, and 1000 rhizobia seed⁻¹ for the larger, *e.g.* lucerne, red clover and subterranean clover.

7.3.4. *Inoculant Quality Troubleshooting and Other Activities*

In recent years, troubleshooting has centred on the problems associated with genetic instability of rhizobial strains that cause variations in infectiveness and effectiveness and colony dimorphism. Other activities include maintenance of a collection of about 1700 rhizobial strains, manufacture of special inoculants for sale, and training, promotion, and extension concerning inoculants and inoculation.

8. CONSTRAINTS TO INOCULANT USE AND FUTURE PROSPECTS

The global market for legume inoculants can be divided neatly into two (Phillips, 2004). The relatively sophisticated markets of N. and S. America, Europe, and Australia are dominated by a small number of manufacturers. Inoculant quality is generally good, reflecting the various countries' legislative and non-legislative controls, competitive market forces, and often long histories of R&D of rhizobia and inoculant technology by the manufacturers and by universities and government institutions (Bullard *et al.*, 2005; Catroux *et al.*, 2001; Lupwayi *et al.*, 2000). Farmers, particularly in N. America, also have a large choice of products that can be tailored to their particular needs (Vessey, 2004). In marked contrast, the production of legume inoculants in Asia and Africa is much less sophisticated and much more fragmented, with highly variable inoculant quality (Lupwayi *et al.*, 2000; Singleton *et al.*, 1997).

In the American/European/Australian market, inoculant use tends to be dictated by farmer experience and local agronomists' recommendations. Either over or unnecessary inoculation is probably more common than not using inoculants when needed (Vessey, 2004), which is not to say that the latter does not occur. As stated

earlier, unnecessary inoculation represents a small production cost, whereas uninoculated N-deficient crops can mean substantially lower production and lower income. Improved guidelines for inoculation, based on an ever-expanding knowledge base of rhizobial population dynamics in soil, would be useful (see section 2.).

The challenges for the American/European/Australian market are to develop new inoculant technologies and products and to refine inoculation guidelines for farmers. New improved inoculants may contain rhizobia alone or rhizobia plus PGP organisms (Xavier *et al.*, 2004). New strains of rhizobia and PGP organisms will mostly come from natural populations, but may increasingly be genetically modified to incorporate desirable traits (Nelson, 2004). Irrespective of the microorganisms in the inoculant, improved inoculant formulations and packaging should improve their survival in the carrier (shelf life) and after application onto the seed or into the soil (Catroux *et al.*, 2001; Date, 2001). Xavier *et al.* (2004) argued that the universities and government research institutions are better able to do the formulation research and development because of the lack of industrial funds for such activities.

The challenges for the less sophisticated markets in Asia and Africa are quite different, relating more to supply and quality. For example, Vietnam cultivates about 700,000 ha of legumes annually, virtually none of which is inoculated, and all are fertilised with N at rates of 50-150 kg N ha⁻¹ (Herridge, 2002; Hiep *et al.*, 2002; Hoa *et al.*, 2002). The annual cost to farmers of US\$25–30 million could be reduced to about US\$1 million by replacing fertiliser-N application with inoculation. Myanmar (Burma) cultivates about 3.5 million ha legumes annually, with <5% inoculated (Thein and Hein, 1997). The quality of the 250,000 packets of inoculants produced annually is uncertain because of lack of QA. Unlike Vietnam, legumes in Myanmar are not fertilised with N and yields are, therefore, very low, averaging <1.0 t ha⁻¹. For both Vietnam and Myanmar, production and use of appropriate quantities of high-quality legume inoculants would have substantial economic benefits.

What is required to make that happen? Arguably, the list includes:

- a committed coordinated national legume inoculants/N₂ fixation program with adequate funding, possibly external (IAEA, FAO or World Bank);
- a person or persons to champion the technology - interestingly, many countries that successfully use legume inoculation owe much of their success to individuals, like J.M. Vincent, J. Brockwell, and R.J. Roughley (Australia), J. Döbereiner and J.R. Jardim Freire (Brazil), and J. Burton (USA);
- training in inoculant production techniques and QC programs;
- R&D on rhizobial strains, carriers, methods of production, and application for local conditions;
- well-planned field demonstrations of effects of inoculation on legume yields, which are necessary for both extension efforts and to help to create the demand for inoculants; and

- private-sector inoculant production, which will only occur if the market is sufficiently large and can sustain the viability of private companies and, therefore, should only be expected after a period of market development and growth.

It is ironic that the very substantial benefits of legume inoculation are captured most successfully by the richer developed countries, but it should be noted that inoculant manufacturing has frequently developed in response to the large-scale introduction of exotic legumes with rhizobial specificity. Examples of success stories are soybean in Brazil (Alves *et al.*, 2003), pea and lentil in Canada (Vessey, 2004), and subterranean clover in Australia (Brockwell, 2004; Bullard *et al.*, 2005). Dramatic responses to legume inoculation in these systems facilitated market development. Such new crop introductions tend to respond strongly to inoculation, not only because the specific rhizobia tend to be either low in numbers in the soil or absent, but also because there is usually a simultaneous introduction of other inputs that increase yield and, therefore, N₂-fixation potential. This synergy between inoculant and other management inputs can play a major role in gaining farmer acceptance of inoculation.

9. CONCLUDING STATEMENTS

The legume-inoculant industry has made and continues to make an enormous contribution to the economies of individual countries. However, despite almost 100 years of research and experience, many inoculants produced in the world today are of poor quality. Even good quality inoculants are often not used to best advantage. Brockwell *et al.* (1995) suggested that as much as 90% of all inoculant has no practical impact whatsoever on the productivity of the legumes inoculated. Such a high figure may have been used to make a point rather than to be taken literally, but the authors acknowledge that good inoculants are produced and used effectively in situations where they are needed. In those instances, legume inoculation is arguably one of the most cost-effective of all agricultural practices.

The future of the inoculant industry, and its potential benefits for world agriculture, depends on improving inoculant quality, both numerically and in terms of strain effectiveness. New technologies may lead to improved inoculants in industrialised countries, but the fact remains that, in many countries, the 30- and 40-year old technologies have yet to be fully exploited.

REFERENCES

- Allen, E. K., and Allen, O. N. (1961). The scope of nodulation in the Leguminosae. *Proceedings of the Ninth International Botanical Congress, Vol. 1* (pp. 585-588). Toronto, Canada: University of Toronto Press.
- Alves, B. J. R., Boddey, R. M., and Urquiaga, S. (2003). The success of BNF in soybean in Brazil. *Plant Soil*, 252, 1-9.
- Amarger, N. (1988). The microbial aspects of faba bean culture. In D. P. Beck and L. A. Materon (Eds.), *Nitrogen fixation by legumes in mediterranean agriculture* (pp 173-178). Dordrecht, The Netherlands: Kluwer Academic Publishers.

- Ballard R. A., and Charman, N. (2000). Nodulation and growth of pasture legumes with naturalised soil rhizobia. 1. Annual *Medicago* spp. *Aust. J. Exp. Agric.*, *40*, 939-948.
- Ballard, R. A., Charman, N., McInnes, A., and Davidson, J. A. (2004). Size, symbiotic effectiveness and genetic diversity of field pea rhizobia (*Rhizobium leguminosarum* bv. *viciae*) populations in South Australian soils. *Soil Biol. Biochem.*, *36*, 1347-1355.
- Ballard, R. A., Craig, A. D., and Charman, N. (2002). Nodulation and growth of pasture legumes with naturalised soil rhizobia. 2. Balansa clover (*Trifolium michelianum* Savi). *Aust. J. Exp. Agric.*, *42*, 939-944.
- Ballard, R. A., Shepherd, B. R., and Charman, N. (2003). Nodulation and growth of pasture legumes with naturalised soil rhizobia. 3. Lucerne (*Medicago sativa* L.). *Aust. J. Exp. Agric.*, *43*, 135-140.
- Barclay, R. M., Hebb, D. M., and Brockwell, J. (1994). Differential rhizobial colonisation of the roots of sown and volunteer annual species of *Medicago* in an acid soil. *Aust. J. Exp. Agric.*, *34*, 745-752.
- Bashan, Y. (1998). Inoculants of plant growth-promoting bacteria for use in agriculture. *Biotech. Adv.*, *16*, 729-770.
- Bezdicsek, D. F., Evans, D. W., Abede, B., and Witters, R. E. (1978). Evaluation of peat and granular inoculum for soybean yield and N fixation under irrigation. *Agron. J.*, *70*, 865-868.
- Biederbeck, V. O., and Geissler, H. J. (1993). Effect of storage temperatures on *Rhizobium meliloti* survival in peat- and clay-based inoculants. *Can. J. Plant Sci.*, *73*, 101-110.
- Bonish, P. M. (1979). Clover rhizobia in soils: Assessment of effectiveness using the plant infection count method. *N. Z. J. Agric. Res.*, *22*, 89-93.
- Boonkerd, N. (1991). Inoculant quality control and standards in Thailand. In J. A. Thompson (Ed.), *Report on the expert consultation on legume inoculant production and quality control* (pp. 121-130). Rome, Italy: FAO.
- Boonkerd, N. (2002). Development of inoculant production and utilisation in Thailand. In D. Herridge (Ed.), *Inoculants and nitrogen fixation of legumes in Vietnam* (pp. 95-104). ACIAR Proceedings 109e.
- Bowen, G. D., and Rovira, A. D. (1999). The rhizosphere and its management to improve plant growth. *Adv. Agron.*, *66*, 1-102.
- Bowman, A. M., Hebb, D. M., Munnich, D. J., and Brockwell, J. (1998). *Rhizobium* as a factor in the re-establishment of legume-based pastures on clay soils of the wheat belt of north-western New South Wales. *Aust. J. Exp. Agric.*, *38*, 555-566.
- Brockwell, J. (1954). Non-infective nodule bacteria in peat cultures. *J. Aust. Inst. Agric. Sci.*, *20*, 243-246.
- Brockwell, J. (1977). Application of legume seed inoculants. In R. W. F. Hardy and A. H. Gibson (Eds.) *A treatise on dinitrogen fixation. Section IV. Agronomy and ecology*, (pp. 277-309). Chichester, UK: John Wiley & Sons.
- Brockwell, J. (2001). *Sinorhizobium meliloti* in Australian soil: Population studies of the root-nodule bacteria for species of *Medicago* in soils of the Eyre Peninsula, South Australia. *Aust. J. Exp. Agric.*, *41*, 753-762.
- Brockwell, J. (2004). Abundant, cheap nitrogen for Australian farmers: A history of Australian nodulation and nitrogen fixation conferences. *Soil Biol. Biochem.*, *36*, 1195-1204.
- Brockwell, J., Bottomley, P. J., and Thies, J. E. (1995). Manipulation of rhizobia microflora for improving legume productivity and soil fertility: a critical assessment. *Plant Soil*, *174*, 143-180.
- Brockwell, J., Gault, R. R., Chase, D. L., Hely, F. W., Zorin, M., and Corbin, E. J. (1980). An appraisal of practical alternatives to legume seed inoculation: Field experiments on seed bed inoculation with solid and liquid inoculants. *Aust. J. Agric. Res.*, *31*, 47-60.
- Brockwell, J., Gault, R. R., Chase, D. L., Turner, G. L., and Bergersen, F. J. (1985). Establishment and expression of soybean symbiosis in a soil previously free of *Rhizobium japonicum*. *Aust. J. Agric. Res.*, *36*, 397-409.
- Brockwell, J., Gault, R. R., Herridge, D. F., Morthorpe, L. J., and Roughley, R. J. (1988). Studies on alternative means of legume inoculation: Microbiological and agronomic appraisals of commercial procedures for inoculating soybeans with *Bradyrhizobium japonicum*. *Aust. J. Agric. Res.*, *39*, 965-972.
- Brockwell, J., Gault, R. R., Morthorpe, L. J., Peoples, M. B., Turner, G. L., and Bergersen, F. J. (1989). Effects of soil nitrogen status and rate of inoculation on the establishment of populations of *Bradyrhizobium japonicum* and on the nodulation of soybeans. *Aust. J. Agric. Res.*, *40*, 753-762.
- Brockwell, J., Herridge, D. F., Roughley, R. J., Thompson, J. A., and Gault, R. R. (1975). Studies on seed pelleting as an aid to legume seed inoculation. 4. Examination of preinoculated seed. *Aust. J. Exp. Agric. Anim. Husb.*, *15*, 780-787.

- Brockwell, J., Holliday, R. A., and Pilka, A. (1988). Evaluation of the symbiotic nitrogen-fixing potential of soils by direct microbiological means. *Plant Soil*, 108, 163-170.
- Brockwell, J., Pilka, A., and Holliday, R. A. (1991). Soil pH is a major determinant of the numbers of naturally occurring *Rhizobium meliloti* in non-cultivated soils in central New South Wales. *Aust. J. Exp. Agric.*, 31, 211-219.
- Brockwell, J., and Robinson, A. C. (1970). Observations on the natural distribution of *Rhizobium* spp. relative to physical features of the landscape. In M. J. T. Norman (Ed.), *Proceedings of the XI international grassland conference* (pp. 438-441). Brisbane, Australia: University of Queensland Press.
- Bullard, G. K., Roughley, R. J., and Pulsford, D. J. (2005). The legume inoculant industry and inoculant quality control in Australia: 1953–2003. *Aust. J. Exp. Agric.*, 45, 127-140.
- Bullied, W. J., Buss, T. J., and Vessey, J. K. (2002). *Bacillus cereus* UW85 inoculation effects on growth, nodulation, and N accumulation in grain legumes: Field studies. *Can. J. Plant Sci.*, 82, 291-298.
- Carter, J. M., Tieman, J. S., and Gibson, A. H. (1995). Competitiveness and persistence of strains of rhizobia for faba bean in acid and alkaline soils. *Soil Biol. Biochem.*, 27, 617-623.
- Catroux, G., and Amarger, N. (1992). Rhizobia as soil inoculants in agriculture. In M. J. Day and J. C. Fry (Eds.), *Environmental release of genetically engineered and other micro-organisms* (pp. 1-13). Cambridge, UK: Cambridge University Press.
- Catroux, G., Hartmann, A., and Revellin, C. (2001). Trends in rhizobial inoculant production and use. *Plant Soil*, 230, 21-30.
- Chanway, C. P., Hynes, R. K., and Nelson, L. M. (1989). Plant growth-promoting rhizobacteria: Effects on growth and nitrogen fixation of lentil (*Lens esculenta* Moench) and pea (*Pisum sativum* L.). *Soil Biol. Biochem.*, 21, 511-517.
- Charman, N., and Ballard, R. A. (2004). Burr medic (*Medicago polymorpha* L.) selections for improved N₂ fixation with naturalised soil rhizobia. *Soil Biol. Biochem.*, 36, 1331-1337.
- Chatel, D. L., and Parker, C. A. (1973). Survival of field-grown rhizobia over the dry summer period in Western Australia. *Soil Biol. Biochem.*, 5, 415-423.
- Clayton, G. W., Rice, W. A., Lupwayi, N. Z., Johnston, A. M., Lafond, G. P., Grant, C. A., and Walley, F. (2004a). Inoculant formulation and fertilizer nitrogen effects on field pea: Nodulation, N₂ fixation and nitrogen partitioning. *Can. J. Plant Sci.*, 84, 79-88.
- Clayton, G. W., Rice, W. A., Lupwayi, N. Z., Johnston, A. M., Lafond, G. P., Grant, C. A., and Walley, F. (2004b). Inoculant formulation and fertilizer nitrogen effects on field pea: Crop yield and seed quality. *Can. J. Plant Sci.*, 84, 89-96.
- Coventry, D. R., and Hirth, J. R. (1992). Effects of tillage and lime on *Rhizobium trifolii* populations and survival in wheat-subterranean clover rotation in southeastern Australia. *Soil Tillage Res.*, 25, 67-74.
- Crozat, Y., Cleyet-Marel, J. C., Giraud, J. J., and Obaton, M. (1982). Survival rates of *Rhizobium japonicum* populations introduced into different soils. *Soil Biol. Biochem.*, 14, 401-405.
- Date, R. A. (2001). Advances in inoculant technology: A brief review. *Aust. J. Exp. Agric.*, 41, 321-325.
- Date, R. A., and Roughley, R. J. (1977). Preparation of legume inoculants. In R. W. F. Hardy and A. H. Gibson (Eds.), *A treatise on dinitrogen fixation. Section IV. Agronomy and ecology* (pp. 243-276). Chichester, UK: John Wiley & Sons.
- Day, J. M. (1991). Inoculant production in the UK. In J.A. Thompson (Ed.), *Report on the expert consultation on legume inoculant production and quality control* (pp. 75-86). Rome, Italy: FAO.
- Deaker, R., Roughley, R. J., and Kennedy, I. R. (2004). Legume seed inoculation technology – a review. *Soil Biol. Biochem.*, 36, 1275-1288.
- Denton, M. D., Coventry, D. R., Bellotti, W. D., and Howieson, J. G. (2000). Distribution, abundance and symbiotic effectiveness of *Rhizobium leguminosarum* bv. *trifolii* from alkaline pasture soils in South Australia. *Aust. J. Exp. Agric.*, 40, 25-35.
- Dutto, P., Labandera, C., and Canzini, F. (2000). *Azospirillum* inoculation in crops of commercial interest. In I. R. Kennedy and L. Copeland (Eds.), *8th international symposium on nitrogen fixation with non-legumes* (p. 105). Sydney, Australia: University of Sydney Press.
- Evans, J. (2005). An evaluation of potential *Rhizobium* inoculant strains used for pulse production in acidic soils of south-east Australia. *Aust. J. Exp. Agric.*, 45, 257-268.
- Evans, J., Hochman, Z., O'Connor, G. E., and Osborne, G. J. (1988). Soil acidity and *Rhizobium*: Their effects on nodulation of subterranean clover on the slopes of southern New South Wales. *Aust. J. Agric. Res.*, 39, 605-618.

- Evans, J., Wallace, C., and Dobrowolski, N. (1993a). Interaction of soil type and temperature on the survival of *Rhizobium leguminosarum* bv. *viciae*. *Soil Biol. Biochem.*, *25*, 1153-1160.
- Evans, J., Wallace, C., Dobrowolski, N., Pritchard, I., and Sullivan, B. (1993b). Requirement of field pea for inoculation with *Rhizobium* and lime pelleting in soils of Western Australia. *Aust. J. Exp. Agric.*, *33*, 767-773.
- Fred, E. B., Baldwin, I. L., and McCoy, E. (1932). Root nodule bacteria and leguminous plants. Madison, WI: University of Wisconsin Press, 343 pp.
- Gault, R. R. (1981). The study of developments and trends associated with legume inoculants for use with new legume crops – II. *Rhizobium Newsletter*, *26*, 197-211.
- Gault, R. R., Chase, D. L., and Brockwell, J. (1982). Effects of spray inoculation equipment on the viability of *Rhizobium* spp. in liquid inoculants for legumes. *Aust. J. Exp. Agric. Anim. Husb.*, *22*, 299-309.
- Gemell, L. G., Hartley, E. J., and Herridge, D. F. (2005). Point-of-sale evaluation of preinoculated and custom-inoculated pasture legume seed. *Aust. J. Exp. Agric.*, *45*, 161-169.
- Gomez, M., Silva, N., Hartmann, A., Sagardoy, M., and Catroux, G. (1997). Evaluation of commercial soybean inoculants from Argentina. *World J. Microbiol. Biotech.*, *13*, 167-173.
- Guthrie, F. B. (1896). Inoculation of soil for leguminous crops. *Agric. Gaz. NSW*, *7*, 690-694.
- Hardarson, G., Golbs, M., and Danso, S. K. A. (1989). Nitrogen fixation in soybean (*Glycine max* L. Merrill) as affected by nodulation patterns. *Soil Biol. Biochem.*, *21*, 783-787.
- Herridge, D. (2002). Legume N and inoculants: Global and Vietnamese perspectives. In D. Herridge (Ed.), *Inoculants and nitrogen fixation of legumes in Vietnam* (pp. 7-9). ACIAR Proceeding 109e.
- Hiep, N. H., Diep, C. N., and Herridge, D. F. (2002). Nitrogen fixation of soybean and groundnut in the Mekong Delta, Vietnam. In D. Herridge (Ed.) *Inoculants and nitrogen fixation of legumes in Vietnam* (pp. 10-18). ACIAR Proceeding 109e.
- Hiltbold, A. E., Thurlow, D. L., and Skipper, H. D. (1980). Evaluation of commercial soybean inoculants by various techniques. *Agron. J.*, *72*, 675-681.
- Hoa, N. T. L., Thao, T. Y., Lieu, P., and Herridge, D. (2002). N₂ fixation of groundnut in the eastern region of South Vietnam. In D. Herridge (Ed.) *Inoculants and nitrogen fixation of legumes in Vietnam* (pp.19-28). ACIAR Proceeding 109e.
- Howieson, J., and Ballard, R. (2004). Optimising the legume symbiosis in stressful and competitive environments within Southern Australia – some contemporary thoughts. *Soil Biol. Biochem.*, *36*, 1261-1273.
- Howieson, J., Malden, J., Yates, R. J., and O'Hara, G. W. (2000). Techniques for the selection and development of elite inoculant strains of *Rhizobium leguminosarum* in Southern Australia. *Symbiosis*, *28*, 33-48.
- Hynes, R. K., Craig, K. A., Covert, D., Smith, R. S., and Rennie, R. J. (1995). Liquid rhizobial inoculants for lentil and field pea. *J. Product. Agric.*, *8*, 547-552.
- Hume D. J., and Blair, D. H. (1992). Effect of numbers of *Bradyrhizobium japonicum* applied in commercial inoculants on soybean yield in Ontario. *Can. J. Microbiol.*, *38*, 588-593.
- Ireland, J. A., and Vincent, J. M. (1968). A quantitative study of competition for nodule formation. *Proceedings of the 9th international congress of soil science, Vol. II* (pp. 85-92). Sydney, Australia: Angus and Robertson.
- Kannaiyan, S. (2003). Inoculant production in developing countries – problems, potentials and success. In G. Hardarson and W. J. Broughton (Eds.), *Maximising the use of biological nitrogen fixation in agriculture* (pp. 187-198). Dordrecht, The Netherlands: Kluwer Academic Publishers.
- Keyser, H. H., Somasegaran, P., and Bohlool, B. B. (1992). Rhizobial ecology and technology. In F. B. Metting (Ed.), *Soil microbial ecology. Applications in agricultural and environmental management* (pp. 205-226). New York, NY: Marcel Decker.
- Kucey, R. M. N., and Hynes, M. F. (1989). Populations of *Rhizobium leguminosarum* biovars *phaseoli* and *viciae* in fields after bean or pea in rotation with nonlegumes. *Can. J. Microbiol.*, *35*, 661-667.
- Kutcher, H. R., Lafond, G., Johnston, A. M., Miller, P. R., Gill, K. S., et al. (2002). *Rhizobium* inoculant and seed-applied fungicide effects on field pea production. *Can. J. Plant Sci.*, *82*, 645-651.
- Kyei-Boahen, S., Slinkard, A. E. and Walley, F. L. (2002). Evaluation of rhizobial inoculation methods for chickpea. *Agron. J.*, *94*, 851-859.
- Liu, Z. L., and Sinclair, J. B. (1990). Enhanced soybean plant growth and nodulation by *Bradyrhizobium* in the presence of strains of *Bacillus megaterium*. *Phytopath.*, *80*, 1024.

- Lowther, W. L., and Patrick, H. N. (1995). *Rhizobium* strain requirements for improved nodulation of *Lotus corniculatus*. *Soil Biol. Biochem.*, 27, 721-724.
- Lupwayi, N. Z., Olsen, P. E., Sande, E. S., Keyser, H. H., Collins, M. M., Singleton, P. W., and Rice, W. A. (2000). Inoculant quality and its evaluation. *Field Crops Res.*, 65, 259-270.
- McInnes, A., Holford, P., and Thies, J. E. (2005). Characterisation of dry and mucoid colonies isolated from Australian rhizobial inoculant strains for *Medicago* species. *Aust. J. Exp. Agric.*, 45, 151-159.
- McKenzie, R. H., Middleton, A. B., Solberg, E. D., DeMulder, J., Flore, N., Clayton, G. W., and Bremer, E. (2001). Response of pea to rhizobia inoculation and starter nitrogen in Alberta. *Can. J. Plant Sci.*, 81, 637-643.
- Marufu, L., Karanja, N., and Ryder, M. (1995). Legume inoculant production and use in East and Southern Africa. *Soil Biol. Biochem.*, 27, 735-738.
- Morrison, N. A., Hau, C. Y., Trinick, M. J., Shine, J., and Rolfe, B. G. (1983). Heat curing of a sym plasmid in a fast-growing *Rhizobium* sp. that is able to nodulate legumes and the nonlegume *Parasponia* sp. *J. Bacteriol.*, 153, 527-531.
- Moudiongui, A., Ntihabose, S., and Ruraduma, C. (1991). Legume inoculant production unit (UPIL) in Burundi. *Report on the expert consultation on legume inoculant production and quality control* (pp. 71-74). Rome, Italy: FAO.
- Muldoon, J. F., Hume, D. J., and Beversdorf, W. D. (1980). Effects of seed- and soil-applied *Rhizobium japonicum* inoculants on soybeans in Ontario. *Can. J. Plant Sci.*, 60, 399-409.
- Nelson, L. M. (2004). Plant growth promoting rhizobacteria (PGPR): Prospects for new inoculants. Retrieved 2/2005, from <http://www.plantmanagementnetwork.org/pub/cm/review/2004/inoculant/>.
- Nethery, A. A. (1991). Inoculant production with nonsterile carrier. *Report on the expert consultation on legume inoculant production and quality control* (pp. 43-50). Rome, Italy: FAO.
- O'Hara, G. W., Howieson, J. G., and Graham, P. H. (2003). Nitrogen fixation and agricultural practice. In G. J. Leigh (Ed.), *Nitrogen fixation at the millennium* (pp. 391-410). Amsterdam, The Netherlands: Elsevier.
- O'Hara, G. W., Yates, R., and Howieson, J. (2002). Selection of strains of root nodule bacteria to improve inoculant performance and increase legume productivity in stressful environments. In D. Herridge (Ed.), *Inoculants and nitrogen fixation of legumes in Vietnam* (pp. 75-80). ACIAR Proceeding 109e.
- Okon, Y. (2000). Benefits of inoculation of agronomically important crops with *Azospirillum*. In I. R. Kennedy and L. Copeland (Eds.), *8th international symposium on nitrogen fixation with non-legumes* (pp. 16-17). Sydney, Australia: University of Sydney Press.
- Olsen, P. E., Rice, W. A., Bordeleau, L. M., and Biederbeck, V. O. (1994). Analysis and regulation of legume inoculants in Canada: The need for an increase in standards. *Plant Soil*, 161, 127-134.
- Olsen, P. E., Rice, W. A., Bordeleau, L. M., Demidoff, L. M., and Collins, M. M. (1996). Levels and identities of nonrhizobial microorganisms found in commercial legume inoculant made with nonsterile peat carrier. *Can. J. Microbiol.*, 42, 72-75.
- Olsen, P. E., Rice, W. A., and Collins, M. M. (1995). Biological contaminants in North American legume inoculants. *Soil Biol. Biochem.*, 27, 699-701.
- Osburn, R. M., Milner, J. L., Oplinger, E. S., Smith, R. S., and Handelsman, J. (1995). Effect of *Bacillus cereus* UW85 on the yield of soybean at two field sites in Wisconsin. *Plant Disease*, 79, 551-556.
- Peoples, M. B., Gault, R. R., Lean, B., Sykes, J. D., and Brockwell, J. (1995). Nitrogen fixation by soybean in commercial irrigated crops of central and southern New South Wales. *Soil Biol. Biochem.*, 27, 553-561.
- Perret, X., Staehelin, C., and Broughton, W. J. (2000). Molecular basis of symbiotic promiscuity. *Microbiol. Mol. Biol. Rev.*, 64, 180-201.
- Phillips, P. W. B. (2004). An economic assessment of the global inoculant industry. Retrieved 2/2005, from <http://www.plantmanagementnetwork.org/pub/cm/review/2004/inoculant/>.
- Rennie, R. J. (1991). Canadian legume inoculants. Evolution of an industry. In J. A. Thompson (Ed.), *Report on the expert consultation on legume inoculant production and quality control* (pp. 51-60). Rome, Italy: FAO.
- Revellin, C., Meunier, G., Giraud, J. J., Sommer, G., Wadoux, P., and Catroux G. (2000). Changes in the physiological and agricultural characteristics of peat-based *Bradyrhizobium japonicum* inoculants after long-term storage. *Appl. Microbiol. Biotech.*, 54, 206-221.
- Rice, W. A., and Olsen, P. E. (1992). Effects of inoculation method and size of *Rhizobium meliloti* population in the soil on nodulation of alfalfa. *Can. J. Soil Sci.*, 72, 57-67.

- Rice, W. A., Olsen, P. E., and Leggett, M. E. (1995). Co-culture of *Rhizobium meliloti* and a phosphorus-solubilizing fungus (*Penicillium bilaii*) in sterile peat. *Soil Biol. Biochem.*, 27, 703-705.
- Richardson, A. E., and Simpson, R. J. (1988). Enumeration and distribution of *Rhizobium trifolii* under a subterranean clover-based pasture growing in an acid soil. *Soil Biol. Biochem.*, 20, 431-438.
- Roughley, R. J. (1970). The preparation and use of legume seed inoculants. *Plant Soil*, 32, 675-701.
- Roughley, R. J. (1982). The storage, quality control and use of legume seed inoculants. In P. H. Graham and S. C. Harris (Eds.), *Biological nitrogen fixation technology for tropical agriculture* (pp. 115-126). Cali, Colombia: CIAT.
- Roughley, R. J., Gemell, L. G., Thompson, J. A., and Brockwell J. (1993). The number of *Bradyrhizobium* sp. (*Lupinus*) applied to seed and its effect on rhizosphere colonization, nodulation and yield of lupin. *Soil Biol. Biochem.*, 25, 1453-1458.
- Roughley, R. J., Simanungkalit, R. D. M., Gemell, L. G., Hartley, E. J., and Cain, P. (1995). Growth and survival of root-nodule bacteria in legume inoculants stored at high temperatures. *Soil Biol. Biochem.*, 27, 707-712.
- Rupela, O. P., Toomsan, B., Mittal, S., Dart, P. J., and Thompson, J. A. (1987). Chickpea *Rhizobium* populations: Survey of influence of season, soil depth and cropping pattern. *Soil Biol. Biochem.*, 19, 247-252.
- Scaglia, J. A. (1991). Production and quality control of inoculants in Rwanda. In J. A. Thompson (Ed.), *Report on the expert consultation on legume inoculant production and quality control* (pp. 61-70). Rome, Italy: FAO.
- Singleton, P. W., Bohlool, B. B., and Nakao, P. L. (1992). Legume response to rhizobial inoculation in the tropics: Myths and realities. In R. Lal and P. A. Sanchez (Eds.), *Myths and science of soils of the tropics. Soil Science Society of America and American Society of Agronomy Special Publication, Vol. 29*, 135-155.
- Singleton, P. W., Boonkerd, N., Carr, T. J., and Thompson, J. A. (1997). Technical and market constraints limiting legume inoculant use in Asia. In O. P. Rupela, C. Johansen and D. F. Herridge (Eds.), *Extending nitrogen fixation research to farmers' fields* (pp. 17-38). Patancheru, India: ICRIASAT.
- Singleton, P., Keyser, H., and Sande, E. (2002). Development and evaluation of liquid inoculants. In D. Herridge (Ed.), *Inoculants and nitrogen fixation of legumes in Vietnam* (pp. 52-66). ACIAR Proceeding 109e.
- Slattery, J. F., and Coventry, D. R. (1989). Populations of *Rhizobium lupini* in soils used for cereal-lupin rotations in north-east Victoria. *Soil Biol. Biochem.*, 21, 1009-1010.
- Slattery, J. F., and Coventry, D. R. (1993). Variations in soil populations of *Rhizobium leguminosarum* bv. *trifolii* and the occurrence of inoculant rhizobia in nodules of subterranean clover after pasture renovation in north-eastern Victoria. *Soil Biol. Biochem.*, 25, 1725-1730.
- Slattery, J. F., Pearce, D. J., and Slattery, W. J. (2004). Effects of resident rhizobial communities and soil type on the effective nodulation of pulse legumes. *Soil Biol. Biochem.*, 36, 1339-1346.
- Smith, R. S. (1992). Legume inoculant formulation and application. *Can. J. Microbiol.*, 38, 485-492.
- Somasegaran, P. (1985). Inoculant production with diluted liquid cultures of *Rhizobium* spp. and autoclaved peat: Evaluation of diluents, *Rhizobium* spp., peats, sterility requirements, storage, and plant effectiveness. *Appl. Environ. Microbiol.*, 50, 398-405.
- Somasegaran, P. (1991). Inoculant production with emphasis on choice of carriers, methods of production and reliability testing/quality assurance guidelines. In J. A. Thompson (Ed.), *Report on the expert consultation on legume inoculant production and quality control* (pp. 87-106). Rome, Italy: FAO.
- Somasegaran, P., and Halliday, J. (1982). Dilution of liquid *Rhizobium* cultures to increase production capacity of inoculant plants. *Appl. Environ. Microbiol.*, 44, 330-333.
- Somasegaran, P., Reyes, V. G., and Hoben, H. J. (1984). The influence of high temperatures on the growth and survival of *Rhizobium* spp. in peat inoculants during preparation, and storage, and distribution. *Can. J. Microbiol.*, 30, 23-30.
- Sparrow, S. D., and Ham, G. E. (1983). Survival of *Rhizobium phaseoli* in six carrier materials. *Agron. J.*, 75, 181-184.
- Sprent, J. I. (2001). *Nodulation in legumes*. Kew, UK: Royal Botanic Gardens. 146 pp.
- Steinborn, J., and Roughley, R. J. (1974). Sodium chloride as a cause of low numbers of *Rhizobium* in legume inoculants. *J. Appl. Bacteriol.*, 37, 93-99.

- Stephens, J. H. G., and Rask, H. M. (2000). Inoculant production and formulation. *Field Crops Res.*, 65, 249-258.
- Thein, M. M., and Hein, M. (1997). Rhizobial inoculants production and their on-farm use in Myanmar. In O. P. Rupela, C. Johansen and D. F. Herridge (Eds.), *Extending nitrogen fixation research to farmers' fields* (pp. 227-236). Patancheru, India: ICRISAT.
- Thies, J. E., Singleton, P. W., and Bohlool, B. B. (1991a). Influence of the size of indigenous rhizobial populations on establishment and symbiotic performance of introduced rhizobia on field-grown legumes. *Appl. Environ. Microbiol.*, 57, 19-28.
- Thies, J. E., Singleton, P. W., and Bohlool, B. B. (1991b). Modeling symbiotic performance of introduced rhizobia in the field by use of indices of indigenous population size and nitrogen status of the soil. *Appl. Environ. Microbiol.*, 57, 29-37.
- Thompson, J. A. (1980). Production and quality control of legume inoculants. In F. J. Bergersen (Ed.), *Methods for evaluating biological nitrogen fixation* (pp. 489-533). Chichester, UK: Wiley Publishing.
- Thompson, J. A. (1984). Production and quality control of carrier-based legume inoculants. ICRISAT Information Bulletin No. 17. Patancheru, India: ICRISAT. 37 pp.
- Thompson, J. A. (1992). Consultant Report to UNFAO. IND/86/003. Rome, Italy: FAO. 48 pp.
- Triplett, E. W., Albrecht, K. A., and Oplinger, E. S. (1993). Crop rotation effects on populations of *Bradyrhizobium japonicum* and *Rhizobium meliloti*. *Soil Biol. Biochem.*, 25, 781-784.
- Vessey, J. K. (2004). Benefits of inoculating legume crops with rhizobia in the northern Great Plains. Retrieved 2/2005, from <http://www.plantmanagementnetwork.org/pub/cm/review/2004/inoculant/>.
- Vincent, J. M. (1954). The control of the quality of legume seed inoculants. *J. Aust. Inst. Agric. Sci.*, 20, 247-249.
- Wadisirisuk, P., Danso, S. K. A., Hardarson, G., and Bowen, G. D. (1989). Influence of *Bradyrhizobium japonicum* location and movement on nodulation and nitrogen fixation in soybeans. *Appl. Environ. Microbiol.*, 55, 1711-1716.
- Wadoux, P. (1991). Inoculant production in industry using sterile carriers. In J. A. Thompson (Ed.), *Report on the expert consultation on legume inoculant production and quality control* (pp. 33-42). Rome, Italy: FAO.
- Wakelin, S. A., and Ryder, M. H. (2004). Plant growth-promoting inoculants in Australian agriculture. Retrieved 2/2005, from <http://www.plantmanagementnetwork.org/pub/cm/review/2004/inoculant/>.
- Walley, F., Clayton, G., Gan, Y. and Lafond, G. (2004). Performance of rhizobial inoculant formulations in the field. Retrieved 2/2005, from <http://www.plantmanagementnetwork.org/pub/cm/review/2004/inoculant/>.
- Waters, L. M. (1954). Tests of commercial peat inoculants. *J. Aust. Inst. Agric. Sci.*, 20, 249-251.
- Weaver, R. W., and Frederick, L. R. (1974a). Effect of inoculum rate on competitive nodulation of *Gycine max* L. Merrill. I. Greenhouse studies. *Agron. J.*, 66, 229-232.
- Weaver, R. W. and Frederick, L. R. (1974b). Effect of inoculum rate on competitive nodulation of *Gycine max* L. Merrill. II. Field studies. *Agron. J.*, 66, 233-236.
- Weaver, R. W., Frederick, L. R., and Dumenil, L. C. (1972). Effect of soybean cropping and soil properties on numbers of *Rhizobium japonicum* in Iowa soils. *Soil Sci.*, 114, 137-141.
- Wilson, D. O., and Trang, K. M. (1980). Effects of storage temperature and enumeration method on *Rhizobium* spp. numbers in peat inoculants. *Trop. Agric.*, 57, 233-238.
- Wood, M., and Shepherd, G. (1987). Characterization of *Rhizobium trifolii* isolated from soils of different pH. *Soil Biol. Biochem.*, 19, 317-321.
- Woomer, P., Asano, W., and Bohlool, B. B. (1992). Predicting the persistence of introduced *Bradyrhizobium japonicum* in tropical soils. In K. Mulongoy, M. Gueye and D. S. C. Spencer (Eds.), *Biological nitrogen fixation and sustainability of tropical agriculture* (pp. 235-243). Sayce, IITA: Wiley Publishing.
- Woomer, P., Singleton, P. W., and Bohlool, B. B. (1988). Ecological indicators of native rhizobia in tropical soils. *Appl. Environ. Microbiol.*, 54, 1112-1116.
- Xavier, I. J., Holloway, G., and Leggett, M. (2004). Development of rhizobial inoculant formulations. Retrieved 2/2005, from <http://www.plantmanagementnetwork.org/pub/cm/review/2004/inoculant/>.

Chapter 5

FINE-TUNING OF SYMBIOTIC GENES IN RHIZOBIA: FLAVONOID SIGNAL TRANSDUCTION CASCADE

H. KOBAYASHI AND W. J. BROUGHTON

*Laboratoire de Biologie Moléculaire des Plantes Supérieures (LBMPS),
Université de Genève, Sciences III,
30 quai Ernest-Ansermet, Genève, Switzerland*

1. INTRODUCTION

Legume root-nodule bacteria (many genera of both the α - and β -Proteobacteria collectively called rhizobia) provoke, in conjunction with an appropriate legume partner, N_2 -fixing symbiotic nodules of immense global importance to agriculture, biological productivity, plant successions, and soil fertility (Vance, 1998). Formation of N_2 -fixing nodules is dependent upon the exchange of a series of molecular signals between rhizobia and their host-legumes. Some of these signals are involved in regulation of symbiotic genes, in lipo-chito-oligosaccharic Nod-factor production, and in protein secretion.

Symbioses are initiated when flavonoids that accumulate in the rhizosphere of the host plant trigger the rhizobial signal-transduction cascade by interacting with transcriptional activators of nodulation genes. This flavonoid-modulated signal-transduction cascade regulates expression of genes that function throughout nodule development. Most nodulation genes (*nod*, *noe*, and *nol*) are involved in the synthesis of host-specific lipo-chito-oligosaccharides (LCOs), called Nod-factors, which are essential for the initial infection of root hairs (Downie, 1998; Perret *et al.*, 2000). Nod-factors induce root hair-curling, formation of nodule primordia, expression of early nodulin (*ENOD*) genes in the plant, and allow the bacteria to enter the root-hairs (Broughton *et al.*, 2000; Geurts and Bisseling, 2002; Irving *et al.*, 2000). Rhizobia that are incapable of synthesising Nod-factors are unable to penetrate root-hairs (Relić *et al.*, 1993a; 1994a). Thus, flavonoids and Nod-factors represent the first sets of molecular signals exchanged by the symbiotic partners.

Effective nodulation, in which atmospheric N₂ is reduced to ammonia and made available to the plant, then requires “fine-tuning” of the flavonoid-inducible genes.

Establishment of symbioses between host plants and symbiotic bacteria is a multi-step process consisting of signal perception, signal transduction, and signal responses (Broughton *et al.*, 2000). These processes depend upon the precise spatial and temporal regulation of *nod*- and other symbiotic genes (Schlaman *et al.*, 1998). Co-ordinate expression of symbiotic loci in legumes and their micro-symbionts involves the exchange of a series of molecular signals allowing rhizobia to invade the plant roots. Rhizobia produce various molecular signals that affect the host plants (Nod-factors, polysaccharides, plant hormones and secreted proteins) at various steps along the symbiotic pathway (Broughton *et al.*, 2000; Perret *et al.*, 2000). Phenolic compounds, especially flavonoids, are the only well-documented chemical signals that originate from plants and affect symbiotic bacteria.

2. NODD AND *NOD*-BOXES: CENTRAL ELEMENTS IN TRANSDUCTION OF FLAVONOID SIGNALS

Rhizobia perceive plant-derived flavonoids through NodD, a LysR-type transcriptional regulator (LTTR). NodD proteins possess an N-terminal helix-turn-helix DNA-binding domain (DBD), and a C-terminal regulatory (putative co-inducer recognition/response) domain. In the presence of compatible flavonoids, the NodD protein activates transcription from *cis*-regulatory elements found in the upstream promoter regions of most *nod*-genes (the so called *nod*-boxes; Figure 1A). The *nod*-boxes consist of a 49-bp conserved motif containing two sets of the palindrome ATC-N₉-GAT (+ in Figure 1A; Goethals *et al.*, 1992) as well as the sequence T-N₁₁-A, the LysR motif (* in Figure 1A; Schell 1993). NodD specifically protects the two distinct sites on the same face of the *nod*-box helix from DNase I degradation (- in Figure 1A; Fisher and Long, 1993). The DNase I hyper-sensitive site between two protected regions (footprint) indicates that NodD induces a bend in *nod*-box DNA. Recently, non-denaturing polyacrylamide gel-electrophoresis (PAGE) determination of the molecular mass of NodD-*nod*-box complexes suggested that NodD binds to *nod*-boxes as a tetramer (Feng *et al.*, 2003).

2.1. The *nod*-Box Promoters

The roles of conserved motifs in *nod*-boxes have been examined. A complete LysR motif is necessary for NodD binding in *Azorhizobium caulinodans* (Goethals *et al.*, 1992). However, the gel-retardation patterns of the *nodF* promoter of *Rhizobium leguminosarum* bv. *viciae* containing an altered or defective LysR motif were not changed (Okker *et al.*, 2001). Feng *et al.* (2003) proposed that the 49-bp *nod*-box sequence can be divided into two halves; the distal (D) half and proximal (P) half, each of which contains a symmetrical but incomplete inverted repeat AT-N₁₀-GAT (inverted in the P-half, Figure 1A). Partial deletion of the D-half of the *nod*-box does not alter the binding of tetrameric NodD, but the NodD footprint of the DNase I digest is abolished from the left part of the D-half (Feng *et al.*, 2003).

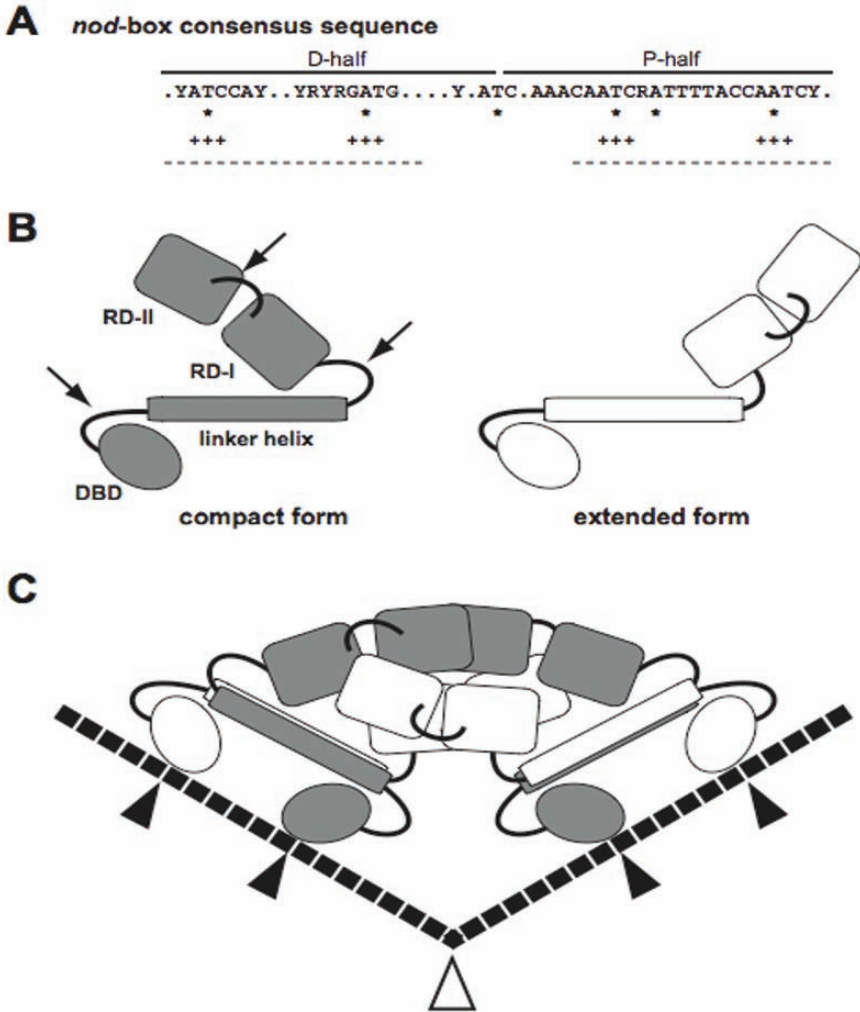

Figure 1. Interaction between LysR type transcriptional regulator (LTTR) and the target promoter.

A. Binding motif of a LysR-type transcriptional regulator NodD: consensus sequence of the NodD-binding motif or *nod*-box (van Rhijin and Vanderleyden, 1995). Location of the P-half and D-half are indicated above (Feng et al., 2003); * indicates the LysR motif. + indicates the inverted repeats required for primary binding of NodD-tetramer. – indicates the protected sequences in DNaseI footprints (Fisher and Long, 1993).

B. Schematic model of the LTTR monomer in two distinct conformations (Muraoka et al., 2003). Arrows indicate location of hinges. In the compact form (shown in grey), the angle between the linker helix and the regulatory domain is approximately 50 degrees, while the corresponding angle is approximately 130 degrees in the extended form (shown in white).

C. Model of the LTTR tetramer complexed to bent DNA. Target DNA is represented as a dotted line. The DNase I hypersensitive site is indicated by an open arrowhead. Closed arrowheads indicate the location of primary binding site of the LTTR tetramer.

Application of the *in vitro* selection technique called SELEX (systematic evolution of ligands by exponential enrichment) to purified NodD under highly restrictive conditions, selected the incomplete inverted repeat AT-N₁₀-GAT, indicating that these nucleotides might be cooperative and more important for NodD binding. In addition to these primary binding sites, other nucleotides of the *nod*-box appear to be required for optimal NodD binding and/or promoter activity, but are not critical to the basal NodD binding. Okker *et al.* (2001) introduced single nucleotide substitutions into the *nodFEL nod*-box of *R. leguminosarum* bv. *viciae*. Most point mutations within the *nod*-box resulted in the complete loss of promoter activity, whereas only diminished NodD binding activity was detected with some of them (Okker *et al.*, 2001). The P-half (from -50 to -25) of other LTTRs is usually superimposed on the -35 RNA polymerase region (Jourlin-Castelli *et al.*, 2000). It is not known which σ -subunit of RNA polymerase is involved in transcription from *nod*-box promoters, but Barnett *et al.* (1996) suggested that SigA (σ^{77}) is capable of directing RNA polymerase to initiate at *nod*-box promoters *in vitro*.

2.2. Flavonoid Perception by NodD

The molecular mechanism of transcriptional activation by flavonoids is not clear. Studies with mutants suggest that the C-terminal part of NodD interacts directly with flavonoids (Burn *et al.*, 1989; Spaink *et al.*, 1987a; 1987b), but direct proof is lacking. NodD can bind to *nod*-boxes even in the absence of inducers, but in the presence of flavonoids, both increased binding to *nod*-boxes (Goethals *et al.*, 1992; Kondorosi *et al.*, 1989) and changes in DNase I footprints (Kondorosi *et al.*, 1989) have been reported. In another report, however, the affinity and/or binding of NodD to *nod*-boxes seemed not to be affected by flavonoids (Fisher and Long, 1993).

In *R. leguminosarum* bv. *viciae*, *R. leguminosarum* bv. *trifolii*, and *R. fredii* HH103, substitution of several amino acids in NodD converted it to a constitutive transcriptional activator, resulting in flavonoid-independent transcriptional activation of *nod*-gene expression (Burn *et al.*, 1989; McIver *et al.*, 1989; Vinardell *et al.*, 2004). Most mutations that yielded flavonoid-independent transcriptional activation were localised in the C-terminal part of NodD, although there were also some at the N-terminus. Interestingly, in *R. leguminosarum* bv. *viciae*, several nucleotide changes or deletions in *nod*-boxes also rendered the promoters independent of flavonoids, although the activities were weaker (Feng *et al.*, 2003; Okker *et al.*, 2001). Mutations in the D-half of the *nodA* promoter inactivated one of the primary NodD-binding motifs (Feng *et al.*, 2003). Circular permutation assays indicated that, in the absence of inducer, the D-half-inactivated *nod*-box allows NodD to cause a sharper DNA bend at the *nod*-box than the wild-type *nod*-box (Feng *et al.*, 2004). With the *nod*-box of *nodF*, the two substitutions were in D- and P-half regions, respectively, and were not related to the binding motif (Okker *et al.*, 2001). It is thus likely that the NodD-*nod*-box complex also cooperatively represses its own activity in the absence of flavonoids. Inducible *nod*-box promoters contain an intrinsic region through which NodD can activate

transcription in an inducer-independent manner. Uninduced tetrameric NodD can also at least partially activate transcription from *nod*-boxes, possibly through recruiting RNA polymerase to the P-half. In the absence of co-inducers, an intact D-half is required for wild-type NodD to intrinsically repress the NodD-mediated partial activation.

2.3. Structure of the *LysR* Type Transcriptional Regulator (LTTR) Tetramer

Typical features of LTTRs found in NodD are a similar size (300-350 amino acids), a well-conserved H-T-H motif at the N-terminus, a requirement for low-molecular-weight ligands, and binding of long stretches to target DNA (50-60 bp) as tetramers. Structures of the regulatory domains of two LTTRs, CysB and OxyR from *Escherichia coli*, have been analysed by X-ray crystallography (Choi *et al.*, 2001; Tyrrell *et al.*, 1997). More importantly, the crystal structure of CbnR, a LTTR of *Ralstonia eutropha*, shows that it can be divided into two domains, the N-terminal DNA-binding domain (DBD), and the C-terminal regulatory domain (Figure 1B), joined by a linker helix (Muraoka *et al.*, 2003). The regulatory domain can be further divided into two sub-domains (RD-I and RD-II). Although direct proof is lacking, mutation analyses of several LTTRs strongly suggest that the inducer-binding site is located between RD-I and RD-II. Interestingly, a hinge is located at crossover regions between RD-I and RD-II and may undergo a conformational change following inducer binding.

Although it remains to be explained how identical subunits can adopt different conformations, the CbnR tetramer can be regarded as a dimer of dimers in which each dimer is composed of two CbnR monomers of different conformation - the compact form and the extended form (Figure 1B). The main body of the tetramer is composed of four regulatory domains arranged in a diamond shape (Figure 1C). Two regulatory domains of compact-form subunits are located at the upper portion of the tetramer, whereas regulatory domains of two extended-form subunits are located at the bottom. All N-terminal DNA-binding domains are located at the bottom of the tetramer and are arranged on the diagonal line of the bottom face. This linear arrangement of four H-T-H domains probably allows LTTR tetramers to interact with their long (50-60 bp) DNA target. Analysis of amino-acid substitutions in CysB indicated that a turn region of the H-T-H domain is the site for the interaction between CysB and the α -subunit of the RNA polymerase (Lochowska *et al.*, 2004).

These marked similarities between Nod D and other LTTRs suggest that the NodD tetramer also functions similarly. Interactions between the DNA-binding domains and their respective binding sites probably bend the target DNA along the V-shaped bottom of the LTTR tetramer. Of note, the tetramer structure contains a large internal cavity connected to the outside of the tetramer through three holes. Two of them are located on either side of the tetramer and are surrounded by three regulatory domains, whereas the third is located at the bottom. This cavity may allow the adjacent subunits to shift position following binding of inducer molecules (flavonoids in the case of NodD), resulting in changes to the quaternary structure of

the tetramer. Because the angle of bending of the bound DNA is probably determined by the arrangement of the DNA-binding domains, the conformational change imposed by the tetramer will be transferred from protein to DNA through bending or twisting the DNA. In the presence of the inducer *cis,cis*-muconate and CbnR, the bending angle of the promoter is relaxed from 78 to 54 degrees (Ogawa *et al.*, 1999).

3. FUNCTIONS OF GENES CONTROLLED BY *NOD*-BOXES

Genome sequencing has shown that rhizobia possess sets of *nod*-boxes, indicating the existence of complex flavonoid-inducible regulatory networks. The 6.7-Mb genome of *R. meliloti* strain 1021, a symbiont of *Medicago* species, the 7.6-Mb genome of *Mesorhizobium loti* strain MAFF303099 from *Lotus japonicus*, and the 9.1-Mb genome of *Bradyrhizobium japonicum* strain USDA110 have seven, nine, and seven *nod*-boxes, respectively (Galibert *et al.*, 2001; Kaneko *et al.*, 2000; 2002; M. Göttfert, personal communication). In addition, the 502-kb mobile symbiotic island of *M. loti* strain R7A and the 536-kb symbiotic plasmid pNGR234a of *Rhizobium* sp. NGR234, carry nine and nineteen *nod*-boxes, respectively (Freiberg *et al.*, 1997; Perret *et al.*, 1999; Sullivan *et al.*, 2002).

Although USDA110 has a relatively broad host-range (Pueppke and Broughton, 1999), Rm1021, MAFF303099 and R7A have much more restricted nodulation capacities. In these restricted host-range symbionts, *nod*-boxes are mostly dedicated to regulation of Nod-factor synthesis. All *nod*-boxes of *R. meliloti* 1021 are located on pSymA, as well as five control operons involved in Nod-factor production; these are n1 for *nodABCIJ*, n2 for *nodFEGPQ*, n3 for *nodH*, n4 for *nodMnolFGnodN*, and n5 for *nodLnoeAB* (Barnett *et al.*, 2001). Two of the seven *nod*-boxes of USDA110 regulate *nodYABCSUIJnolMNOnodZ* as well as *nolYZ* (Göttfert *et al.*, 2001; M. Göttfert, personal communication). All *nod*-boxes of *M. loti* MAFF303099 are located within the 611-kb chromosomal symbiotic island, which shows strong similarity to that of R7A, with the *nod*-genes arranged in seven transcriptional units, namely *noeKJ*, *nodZnoeLnoI*, *nodS*, *nodACIJnoIO*, *nodB*, *nolL* and *nodM*, each of which is preceded by a *nod*-box. In the broad host range NGR234, only five of the nineteen *nod*-boxes (NB1-NB19) of pNGR234a are linked to *nod*-genes. NB2 controls the expression of *nodZnoeLnoI*, NB8 that of *nodABCIJnoI*, NB12 that of *nodSU*, NB4 that of *nolL* and NB7 that of *noeE*.

3.1. *Nod* Factors

3.1.1. *Nod*-factor Synthesis

Glucosamine-6-phosphate is synthesised from fructose-6-phosphate and glutamine (Figure 2). Some rhizobia possess a symbiosis-specific glucosamine synthase (NodM), although the housekeeping glucosamine synthase (GlmS) serves the same function (Marie *et al.*, 1992; 1994). All bacteria forming N₂-fixing nodules on legumes have functional copies of the *nodA*, *nodB* and *nodC* genes. Together, the enzymes encoded by these genes link the individual *N*-acetyl-D-glucosamine units

together, and attach an acyl group to them (Atkinson *et al.*, 1994; Geremia *et al.*, 1994; John *et al.*, 1993; Röhrig *et al.*, 1994; Spaink *et al.*, 1994). NodA and NodC also help determine the type of *N*-linked fatty acid and the length of the chitin backbone (Debellé *et al.*, 1996; Kamst *et al.*, 1997; Ritsema *et al.*, 1996; Roche *et al.*, 1996). Other genes are involved in various modifications to the reducing- and/or non-reducing termini of Nod-factors (Figure 2), each rhizobial type having a set of enzymes capable of modifying Nod-factors. Because both NodS and NodL prefer *N*-deacetylated chito-oligosaccharides (the so-called NodBC metabolite) as substrates (Bloemberg *et al.*, 1995; Jabbouri *et al.*, 1995; Mergaert *et al.*, 1995), both enzymes probably act just after deacetylation of the growing chitin chain by NodB. In support of this argument, Lopez-Lara *et al.* (2001) showed interference between NodS and NodL. NodS cannot use the NodBC metabolite as a substrate after it has been acetylated by NodL, but NodL can acetylate the NodBC metabolite after methylation by NodS. Acylated Nod-factors are the preferred substrate of purified recombinant NodH, indicating that sulfate addition occurs after acylation by NodA (Schultze *et al.*, 1995). Interestingly, none of the rhizobia that harbour *nodS* possesses a functional *nodEF* operon, suggesting interference between NodS and the attachment of the NodEF-dependent polyunsaturated fatty acids.

3.1.2. Are Decorations of Nod-factors Host-range Determinants?

Null-mutations in host-specific *nod*-genes cause commensurate changes in Nod-factor structure (Perret *et al.*, 2000). Thus, *nodH* mutants of *R. meliloti* lack the sulfate group on the reducing terminus of NodRm factors, and lose the capacity to nodulate *Medicago sativa* (yet they acquire the ability to nodulate *Vicia hirsuta*; Faucher *et al.*, 1988; Lerouge *et al.*, 1990; Roche *et al.*, 1991). A *nodZ* mutant of *B. japonicum* was unable to nodulate *Macroptilium atropurpureum*, but still retained the ability to nodulate soybeans (Stacey *et al.*, 1994). Mutation of either *nodZ* or *noeE* of NGR234 blocks nodulation of *Pachyrhizus tuberosus*, but not of other plants (Hanin *et al.*, 1997; Quesada-Vincens *et al.*, 1997). Transfer of *nodZ* of *B. japonicum* into *R. leguminosarum* bv. *viciae* enabled the trans-conjugants to nodulate non-hosts (Lopez-Lara *et al.*, 1996). Transconjugants of *R. fredii* USDA257 containing *nolL* of NGR234 gain the ability to nodulate the non-hosts *Calopogonium caeruleum*, *Leucaena leucocephala*, and *Lotus halophilus* (Berck *et al.*, 1999). Some mutations also result in a delayed nodulation phenotype.

Nevertheless, variation in the structure of Nod-factors has relatively minor effects on early plant responses. Cardenas *et al.* (2003) showed that Nod-factors lacking methyl or carbamoyl substituents on the non-reducing terminus and an acetyl group on the fucosyl residue (purified from *R. etli* strain lacking *nodS*, *nolO* and *nolL*) still induce root-hair deformation and actin cytoskeleton rearrangements on *Phaseolus vulgaris* (albeit to a lesser extent). On the other hand, Nod-factors methylated by NodS, but still lacking *NolO*- and *NolL*-dependent modifications, showed almost the same root-hair deformation and actin cytoskeleton rearrangement activities as wild-type Nod-factors.

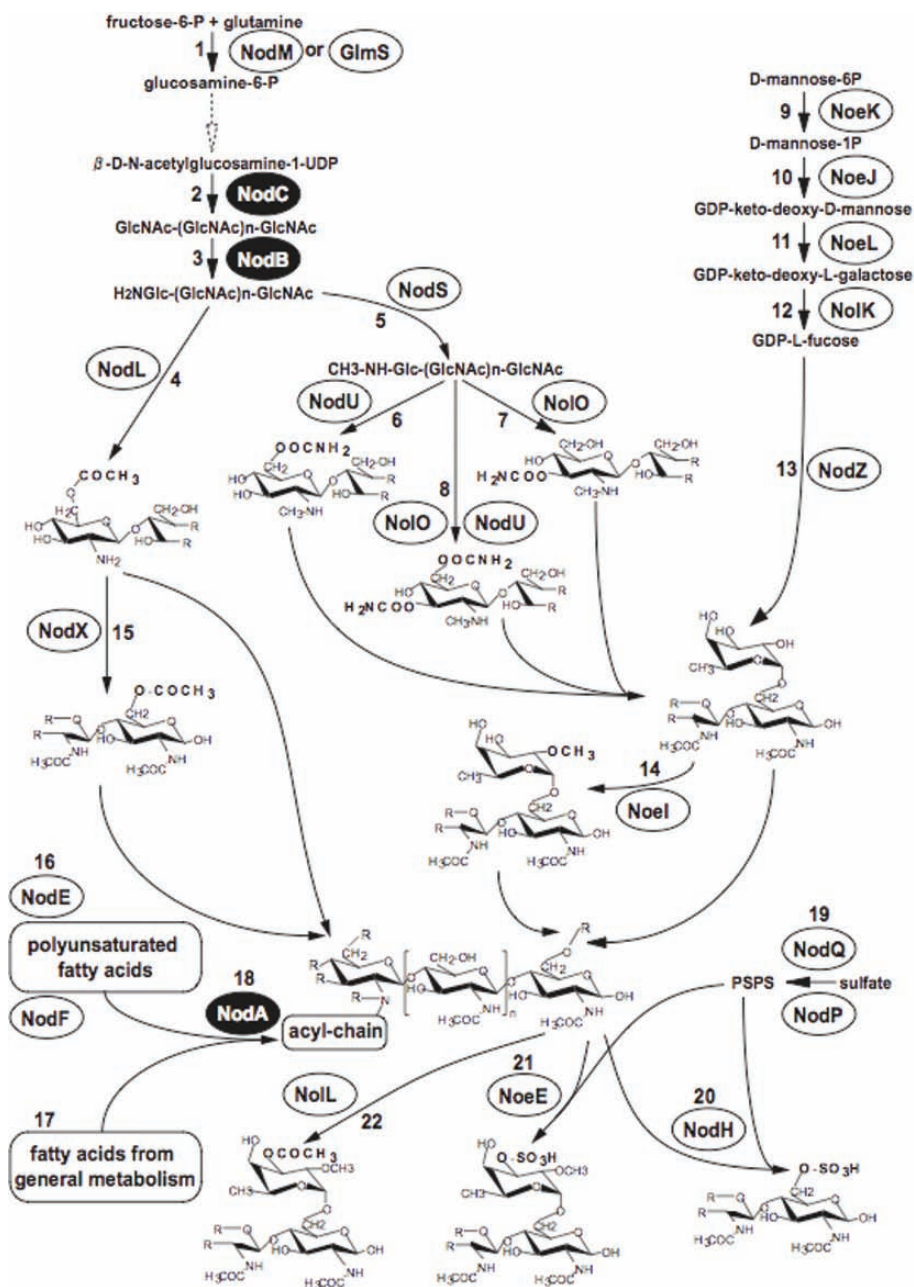

Figure 2. Known functions of nod-gene products in Nod-factor synthesis.

- 1, *NodM* and *GlmS* are glucosamine synthases (Marie *et al.*, 1992; 1994);
 - 2, *NodC* is an *N*-acetylglucosaminyl transferase (Mergaert *et al.*, 1995);
 - 3, *NodB* is a chitooligosaccharide deacetylase (Mergaert *et al.*, 1995);
 - 4, *NolL* is an *O*-acetyl transferase (Bloemberg *et al.*, 1995);
 - 5, *NodS* is an *N*-methyl transferase (Jabbouri *et al.*, 1995);
 - 6, 7, 8, *NodU* is a 6-*O*-carbamoyl transferase. *NolO* is 3- or 4-*O*-carbamoyl transferase (Jabbouri *et al.*, 1995; 1998);
 - 9, *NoeK* is a putative phosphomannomutase (Freiberg *et al.*, 1997);
 - 10, *NoeJ* is a putative mannose-1-phosphate guanyltransferase (Freiberg *et al.*, 1997);
 - 11, *NoeL* is a putative GDP-mannose 4,6-dehydratase (Freiberg *et al.*, 1997);
 - 12, *NolK* is a putative NAD-dependent GDP-fucose synthase (Freiberg *et al.*, 1997);
 - 13, *NodZ* is a 6-*O*-fucosyltransferase (Quesada-Vincens *et al.*, 1997);
 - 14, *NoeI* is a 2-*O*-methyltransferase (Jabbouri *et al.*, 1998);
 - 15, *NodX* is an *O*-acetyl transferase (Firmin *et al.*, 1993);
 - 16, *NodE* is a β -ketoacyl synthase; *NodF* is an acyl carrier protein. Acylated-*NodF* serves as a donor of poly-unsaturated fatty acids for *NodA* (Geiger *et al.*, 1998);
 - 17, *NodA* also uses acyl carrier proteins carrying common fatty acids (Geiger *et al.*, 1998);
 - 18, *NodA* is an *N*-acyl transferase (Mergaert *et al.*, 1995);
 - 19, *NodP* and *NodQ* form a complex with ATP sulfurylase and adenosine-5'-phosphosulfate kinase activities. The resulting PAPS is a sulfate donor for *NodH* and *NoeE* (Schwedock *et al.*, 1994);
 - 20, *NodH* is a 6-*O*-sulfotransferase (Schultze *et al.*, 1995);
 - 21, *NodE* is a 3-*O*-sulfotransferase (Quesada-Vincens *et al.*, 1998); *NolL* is a 3-*O*-acetyl transferase (Berck *et al.*, 1999).
- Abbreviations: P, phosphate; UDP, uridyl diphosphate; GlcNAc, *N*-acetyl glucosamine; H₂NGlc, glucosamine; PAPS, 3'-phosphoadenosine-5'-phosphosulfate.

Non-sulfated Nod-factors from *R. meliloti nodH* mutants induce alkalisation of the cytoplasm in *M. sativa* even more actively than sulfated Nod-factors (Felle *et al.*, 1996). On *Medicago truncatula*, another host of *R. meliloti*, sulfated common Nod-factor structures (metabolites of NodABCHPQ) are necessary to induce calcium spiking in root-hairs, but functional *nodE*, *nodF* and *nodL* genes are not required (Wais *et al.*, 2002). Furthermore, non-sulfated Nod-factors elicit calcium spiking in both *M. sativa* and *M. truncatula*, if presented at sufficiently high concentrations (Oldroyd *et al.*, 2001). These data are corroborated by the observation that a *nodFnodL* double mutant of *R. meliloti* still triggers early morphological responses in root-hairs of *M. truncatula* (Catoira *et al.*, 2001), but cannot form functional infection threads. Moreover, Walker and Downie (2000) showed that a *R. leguminosarum* bv. *viciae nodFEMNTLO* deletion-mutant, which produces Nod-factors without any host-specific decorations, penetrates root hairs but fails to induce functional infection threads.

Cullimore *et al.* (2001) suggested that root-hair receptors are specific either to the backbone of the Nod factors or to the decorations on the Nod factors. With *Pisum sativum* cv. Afghanistan, however, it is unlikely that specific receptor(s) recognise host-specific decorations. The acetyl transferase encoded by *NodX* (15 in Figure 2) is required for the nodulation of cv. Afghanistan peas by *R. leguminosarum* bv. *viciae* strain TOM (Firmin *et al.*, 1993). Genetic analysis of the

host indicated that a single locus, called *sym2*, is responsible for the nodulation specificity (Geurts *et al.*, 1997). Surprisingly, *R. leguminosarum* bv. *viciae* carrying *nodZ*, which produces fucosylated rather than acetylated Nod factors, also acquires the ability to nodulate Afghanistan peas (Ovtsyna *et al.*, 1998).

Another possibility is that host-specific decorations contribute to Nod-factor stability in the rhizosphere. Early in the legume-*Rhizobium* interaction, enzymes that can degrade Nod factors are induced in plants. In soybean roots, *B. japonicum* Nod factors induce chitinase CH1 activity (Xie *et al.*, 1999). *Srchi13*, an early nodulin of *Sesbania rostrata* related to the acidic class III chitinases, is transiently induced following inoculation with *A. caulinodans* (Goormachtig *et al.*, 1998). Sulfation of *R. meliloti* Nod factors by NodH confers higher resistance to degradation by plant chitinases (Staehelin *et al.*, 1994; 1995). These protective roles of host-specific decorations against degradation of Nod factors may be important because the actual concentration of Nod factors at the root-surface depends on their stability.

A significance of Nod-factor stability for nodulation implies that the quantity of Nod factors plays an important role. High concentrations of *R. meliloti* Nod factors enabled a *nodABC* deletion mutant of NGR234 to nodulate *Vigna unguiculata* (Relić *et al.*, 1994b). *R. meliloti* carrying *nodD1* of NGR234 on a multi-copy plasmid produces more Nod factors and permits *R. meliloti* to nodulate the non-host *V. unguiculata* (although the nodules are ineffective). In other words, plants respond differently to elevated Nod-factor levels. Introducing extra *nodABC* genes on a multi-copy plasmid into *R. leguminosarum* bv. *viciae* inhibited nodulation in *Vicia sativa* (Knight *et al.*, 1986). Nodulation of Afghanistan peas by *R. leguminosarum* bv. *viciae* strain TOM is inhibited by increased levels of Nod factors resulting from the introduction of *nodD* or Nod-factor synthesis genes on multi-copy plasmids (Hogg *et al.*, 2002). Mutations in host-specific *nod* genes also affect the amount of Nod factors produced. Inactivation of NodS drastically reduces NGR Nod factor production, and the mutant fails to nodulate *L. leucocephala* (Jabbouri *et al.*, 1995). Conversely, introduction of extra copies of *nodSU* of NGR234 into *R. fredii* USDA257 (unable to infect *L. leucocephala* but possessing endogenous *nodSU*) vastly increases Nod-factor production (Perret *et al.*, 2000) and extends the host range of the trans-conjugant to include *L. leucocephala*.

Thus, the role of Nod factors in determining host specificity is complex. In some cases and with some plants, the so-called “host-specific” modifications to the basic Nod-factor structure are indeed crucial for nodulation. Yet examples that support the “host-specific Nod factor” concept are much more the exception than the rule. Nod-factor levels also help determine whether a bacterium will nodulate a plant. Nodulating bacteria must present an optimum concentration of Nod factors to the infection sites on roots and root-hairs. Too much or too little Nod factor decreases the efficiency of nodulation. The relationship between nodulation and Nod-factor concentration follows a “bell-curve” in which the peak varies with the plant. In hindsight, this situation was to be expected because the optimum number of rhizobia in an inoculum also follows a Gaussian distribution.

3.1.3. *nod* Boxes Modulate the Quantity and Quality of Nod Factors

In general, the transcriptional activity of genes involved in Nod-factor synthesis is regulated through *nod*-boxes. In *R. meliloti*, Nod factors are synthesised through steps 1, 2, 3, 4, 16, 18, 19 and 20 (Figure 2), all of which are under the direct control of *nod* boxes (Demont *et al.*, 1993; Schultze *et al.*, 1992). In *B. japonicum* USDA110, Nod factors are thought to be synthesised through steps 1, 2, 3, (5, 6, 7, 8), 9, 10, 11, 12, 13, 14, 17 and 18. Of these, steps 2, 3, (5, 6, 7, 8), 13 and 18 are controlled by single *nod* box. Although the *nod* cluster of *B. japonicum* also contains *nodSU* and *nolO* (corresponding to steps 5, 6, 7, 8), neither *N*-linked methyl nor *O*-linked carbamoyl groups have been detected at the non-reducing terminus of *B. japonicum* Nod factors (Carlson *et al.*, 1993; Sanjuan *et al.*, 1992). *M. loti* strains MAFF303099 and R7A contain the same sets of *nod* genes and may produce Nod factors through steps 1, 2, 3, 5, 6, 7, 8, 9, 10, 11, 12, 13, 17, 18 and 22 (Niwa *et al.*, 2001). All of these genes are downstream of *nod*-boxes. NGR234 produces a large family of Nod factors through steps 1, 2, 3, 5, 6, 7, 8, 9, 10, 11, 12, 13, 14, 17, 18, 19, 20 and 22 (Broughton *et al.*, 2000). Steps 2, 3, 5, 6, 7, 8, 11, 12, 13, 14, 18, 21 and 22 are controlled by *nod*-boxes.

Given that most *nod* genes are preceded by apparently functional *nod*-box promoters, it is obvious that the activity of the enzymes involved in Nod-factor synthesis is controlled at the transcriptional level, generally in a flavonoid-dependent manner. Moreover, genes involved in Nod-factor secretion are also under the control of *nod* boxes. In all cases studied, *nodI* and *nodJ* are part of the *nodABC* operon. *NodI* and *NodJ* are thought to form an ABC transporter for Nod-factor secretion (Cardenas *et al.*, 1996; Spaink *et al.*, 1995). Other *nod*-box regulated genes, including *nodT* and *nolGF*, may also play roles in the export of Nod factors.

This tight control of synthesis of Nod-factor enzymes *via nod* boxes and NodD proteins obviously means that the amount of Nod factors produced is related to the levels of transcription of the relevant genes (Saier *et al.*, 1994; Rivilla *et al.*, 1995). As mentioned above, rhizobia produce several to many Nod factors with varying structures. By modulating the expression of *nod* genes, *nod* boxes help control the kinetics of synthesis of each individual Nod factor. For example, in NGR234, *nod* box NB4, which regulates the *O*-acetyltransferase encoded by *nolL* (22 in Figure 2) is more active than *nod* box NB7 that is upstream of the sulfuryltransferase encoded by *noeE* (21 in Figure 2). These data are consistent with observations that NGR234 produces more acetylated than sulfated Nod factors and suggests that *nod* boxes are instrumental in helping define the quantity and spectrum of Nod factors secreted.

3.2. Regulation of Specialised Protein-secretion Systems

Clusters of genes that encode bacterial type III (TTSS) or type IV (TFSS) protein-secretion systems have been found in all rhizobia so far. These specialized mechanisms for secreting proteins play crucial roles in the interaction of both animal and plant pathogens with their eukaryotic hosts.

3.2.1. TTSS in *Rhizobia*

About twenty proteins are involved in the formation of the membrane-spanning TTSS secretion apparatus. TTSS machines are associated with an extra-cellular filamentous (pilus) structure (Hueck, 1998) thought to function like a syringe through which the effector proteins are injected into the host cytoplasm. In pathogenic interactions between bacteria and mammalian hosts, the effector proteins mostly interfere with host signal-transduction cascades to arrest defence reactions. TTSS clusters have been found in NGR234, *R. fredii* USDA257, *M. loti* MAFF303099, and *B. japonicum*. Classical “gene-knockout” experiments confirm that TTSSs are functional in NGR234, *R. fredii* USDA257, and *B. japonicum*.

The gene, *ttsI*, encodes a homolog of a two-component response regulator, which activates transcription of genes involved in TTSS synthesis from a conserved 5'-tcGTCAGcTTNTCGaaAGcT-3' promoter motif called the *tts*-box (Krause *et al.*, 2002; Marie *et al.*, 2001; 2004; Viprey *et al.*, 1998). A *nod* box has been identified in the promoter region of all *ttsI* genes examined so far (Krause *et al.*, 2002; Marie *et al.*, 2001; 2003; Viprey *et al.*, 1998) and this explains why rhizobia secrete proteins (called nodulation outer proteins, Nops) in response to inducing flavonoids. Perhaps surprisingly, various hosts of NGR234 respond differently to defects in TTSS secretion. Inactivation of the ATPase (*RhcN*), which provides the energy needed for protein secretion, yields mutants that are blocked in the secretion of all Nops (Viprey *et al.*, 1998). When used to inoculate various NGR234 hosts, this mutant stimulates nodulation of *P. tuberosus*, has no effect on the symbiosis with *L. japonicus*, but causes a drastic reduction in nodulation of *Tephrosia vogelii*. Similarly, TTSS (*rhcC*, *rhcN*, *rhcJ* and *ttsI*) mutants of *R. fredii* USDA257 have a cultivar-specific phenotype on *G. max*; knock-out mutants of *rhcC*, *rhcN* or *rhcJ* nodulate *G. max* cv. McCall that the wild-type fails to infect (Krishnan *et al.*, 2003), but, perhaps most surprisingly, the *ttsI* mutant did not nodulate cv. McCall. TTSS mutants of *B. japonicum* show delayed nodulation on *G. max*, and reduced nodulation on *M. atropurpureum* (Krause *et al.* 2002). Although TTSS-dependent protein secretion has not been reported in *M. loti* MAFF303099, an *rhcJ* mutant is able to nodulate the non-host *L. leucocephala* (Hubber *et al.*, 2004).

Obviously, these varying phenotypes depend on how a particular plant responds to the effector protein(s) injected via the TTSS. Several Nops have been identified in NGR234, including NopA, NopB, NopC, NopL, NopM, NopP and NopX (Ausmees *et al.*, 2004; Deakin *et al.*, 2005; Marie *et al.*, 2003; Saad *et al.*, 2005; Viprey *et al.*, 1998; K. Kambara and W.J. Deakin, personal communication). Mutation of certain *nop*-genes (*e.g.*, *nopA* and *nopB*) blocks the secretion of all Nops, indicating that these are outer membrane components of the secretion machinery (Deakin *et al.*, 2005; Marie *et al.*, 2003; Saad *et al.*, 2004). On the other hand, mutation of *nopL*, *nopP* and *nopX* has no effect on the secretion of other Nops.

The function of NopL has been extensively studied both *in vitro* and *in planta* (Bartsev *et al.*, 2003; 2004) by transformation of tobacco and *L. japonicus* with *nopL*. Expression of *nopL* inhibited the ability of both plants to accumulate pathogenesis-related (PR) proteins. Experiments in which purified recombinant NopL was incubated with extracts from *Lotus* and tobacco lent support to the idea

that it can serve as a substrate for plant protein kinases (Bartsev *et al.*, 2003). Phosphorylation of NopL by plant proteins is specifically inhibited by the Ser/Threonine kinase inhibitor K252a as well as by PD98059, a mitogen-activated protein kinase (MEK) inhibitor, confirming that NopL is a substrate for protein kinases. It has, therefore, been suggested that NopL suppresses plant defence responses by modulating MAP kinase pathways. A *nopP* mutant showed slightly altered symbiotic properties on *Pachyrhizus tuberosus* and *Flemingia congesta* (Ausmees *et al.*, 2004).

Genes homologous to *nopP* have only been found in rhizobia. ORF3 of *R. etli* strain CNPAF512 (previously *R. leguminosarum* bv. *phaseoli*) has extensive homology to *nopP* and was shown to be important for nodulation competitiveness (Michiels *et al.*, 1995). *B. japonicum* USDA110 possesses five ORFs (id80, blr1752, id185, id186, and id322) that are homologous to *nopP*, but only id186 possesses a *tts*-box-like sequence in its promoter region. NopX shares extensive homology with HrpF of *Xanthomonas* species, which probably form pore-like structures in plant-cell membranes through which effectors are delivered into the host cytoplasm. NopX is associated with pilus-like surface appendages in *R. fredii* USDA257 (Krishnan *et al.*, 2003) and is found in the infection threads of *V. unguiculata* and *G. max*, but not in nodule calls containing bacteroids (Krishnan, 2002), indicating that it may have a role early in infection.

3.2.2. TFSS in Rhizobia

Some rhizobia, *e.g.*, *R. meliloti* 1021 and *M. loti* R7A, possess putative TFSS. TFSS mediate secretion or direct cell-to-cell transfer of virulence factors (proteins or protein-DNA complexes) from Gram-negative pathogens into eukaryotic cells. Homologs of the two-component regulator VirA (a transmembrane histidine kinase) and VirG (a response regulator) likely regulate TFSSs in rhizobia. In *M. loti* R7A, *virA* is located downstream of a *nod* box, but not in *R. meliloti* 1021. Transcriptional analyses of *R. meliloti* 1021 revealed that some components of TFSS are preferentially transcribed during infection (Ampe *et al.*, 2003). Deletion of the *R. meliloti* TFSS cluster had no effect on nodulation and N₂ fixation (Barnett *et al.*, 2001). Perhaps the TFSS homologs of *R. meliloti* are orthologs of the *Agrobacterium avhB* genes, which are involved in conjugal plasmid transfer rather than virulence or infection. Hubber *et al.* (2004) showed that TFSS of *M. loti* R7A plays a host-specific role in symbiotic interactions. Mutations in the TFSS cluster enabled *M. loti* R7A to nodulate *L. leucocephala*, which the wild-type bacterium cannot. Furthermore, TFSS mutants showed delayed nodulation and reduced competition phenotypes on the host plant (*Lotus corniculatus*). Among genes of the TFSS cluster, *msi059* and *msi061* most probably encode putative effector proteins. Mutation of both genes has positive effects on nodulation on *L. leucocephala*. The C-terminal ends of proteins encoded by *msi059* and *msi061* resemble each other and contain RxR motifs similar to the RPR motifs found in C-termini of *A. tumefaciens* effector proteins. Moreover, the Cre-recombinase reporter assay for protein translocation demonstrated that the proteins Msi059 and Msi061 can be transported into both *Arabidopsis thaliana* and yeast cells by TFSS of

A. tumefaciens. Msi059 is a member of the C48 family of cysteine proteases, some of which act to de-conjugate ubiquitin or SUMO (small ubiquitin-like modifier) from ubiquitin-conjugated proteins. Proteins encoded by *msi061* share striking similarity to VirF of *A. tumefaciens* strain 15955. VirF is an F-box protein that is translocated by TFSS and plays a role in the host range of *Agrobacterium*. F-box proteins act as receptors that attract specific proteins to SCF (Skp1-Cdc53-F-box protein) complexes for ubiquitination and subsequent proteolysis.

3.3. Genes of Diverse or Unknown Function

Other loci linked to *nod*-boxes include the *nolYZ* operon, *dctA*, id329id330 of USDA110, mlr6144mlr6145 of *M. loti* MAFF303099, and mis373 of *M. loti* R7A. Deletion of *nolY* produced slight defects in nodulation of *G. max*, *M. atropurpureum*, *V. unguiculata*, and *V. radiata* (Dockendorff *et al.*, 1994). Interestingly, *dctA* (id13) of *B. japonicum* USDA110 possesses both a *nod* box and a NifA- σ^{54} -dependent promoter, a type which activates down-stream genes under N₂-fixing conditions. DctA is a single-protein permease embedded in inner-membranes where it is involved in the uptake of C₄-dicarboxylic acids (Engelke *et al.*, 1989; Jording and Pühler, 1993). In NGR234, however, *nod* boxes modulate various functions including regulation, adaptation, and nitrogen fixation (see section 4.6). The *nod* boxes NB3 and NB13 of NGR234 and *nod* box n6 of *R. meliloti* 1021 lack downstream ORFs in the correct orientation.

4. FINE-TUNING EXPRESSION OF SYMBIOTIC GENES IN RESTRICTED-HOST RANGE RHIZOBIA

Nodule formation is a multi-stage process that is quantitatively, spatially, and temporally regulated, with symbiotic genes of assorted functions up-regulated *via* the NodD-*nod* box system in response to the flavonoid inducers. In the rhizosphere, however, the recognition of host-derived flavonoids by rhizobia is a complex process. Diverse classes of flavonoids up-regulate *nod*-gene expression including anthocyanidins, chalcones, coumestans, flavanones, flavones, flavonols, and isoflavonoids, and are derived from phenylpropanoids that enter the flavonoid pathway through chalcone synthase (Broughton *et al.*, 2003; Cooper, 2004). Flavonoids in plants occur both as glycosides with one or more sugars attached and as the non-conjugated aglycones. Usually, both glycoside and aglycone forms are active as *nod*-gene inducers, but luteolin-7-*O*-glucoside cannot induce *nod* genes in *R. meliloti* (Hartwig and Phillips, 1991; Smit *et al.*, 1992). Rhizobia in compatible rhizospheres elicit quantitative increases and qualitative changes in flavonoid exudation (Dakora *et al.*, 1993a ; 1993b; Recourt *et al.*, 1989; Schmidt *et al.*, 1994). Exactly which of the flavonoid(s) is responsible for the up-regulation of *nod*-gene expression in the rhizosphere is difficult to determine because plants secrete mixtures. The spectrum of flavonoids exuded by a legume is probably one determinant of host specificity.

Generally, NodDs of broad host-range rhizobia respond to a wider range of flavonoids than the NodDs of other strains. Thus, NodD1 of NGR234 responds positively to a wide range of inducers, including phenolic substances that are inhibitors in other rhizobia (Le Strange *et al.*, 1990); its transfer to restricted host-range rhizobia extends the spectrum of plants that the transconjugants can nodulate (Bender *et al.*, 1988). Conversely, NodD proteins from restricted host-range rhizobia have more specific requirements for flavonoids (Hartwig *et al.*, 1989). Usually, rhizobia possess one to five *nodD* alleles; *R. leguminosarum* bv. *viciae*, for example, has one copy of *nodD*, *B. japonicum* USDA110 and NGR234 have two functionally different *nodDs* (*nodD1* and *nodD2*), whereas *R. meliloti* has three (*nodD1*, *nodD2* and *nodD3*) (Fellay *et al.*, 1998; Garcia *et al.*, 1996; Göttfert *et al.*, 1992; Honma *et al.*, 1990). In *R. meliloti*, NodD1 induces transcription in concert with luteolin and methoxychalcone, NodD2 interacts with betain compounds (and methoxychalcone), whereas NodD3 can activate transcription in the absence of an inducer (Kondorosi *et al.*, 1991a; Maillet *et al.*, 1990; Mulligan and Long, 1989). Mutation of two of the three NodDs severely affects nodulation of *M. truncatula* (Smith and Long, 1998). In *B. japonicum* USDA110 as well as NGR234, NodD1 activates transcription in concert with flavonoids, whereas NodD2 represses expression of *nod* genes (Fellay *et al.*, 1998; Garcia *et al.*, 1996; Göttfert *et al.*, 1992). Multiple *nodDs* form a complex regulatory circuit that probably helps restricted host-range rhizobia recognise a wider spectrum of flavonoids.

4.1. Temporal and Spatial Regulation of *nod* box-associated Genes

As different sets of *nod* box-associated genes influence various steps in nodule development (Perret *et al.*, 2000), the flavonoid/NodD/*nod* box system must also be subject to temporal regulation. Because Nod factors are necessary for the entry of rhizobia into root hairs, *nod* genes must be expressed while the bacteria are still in the rhizosphere. Expression of *nod* genes is attenuated once the bacteria enter the root-hair. Then, another set of flavonoid/NodD/*nod* box controlled functions (including TTSSs) are up-regulated, when contact between bacteria and their host is more intimate. Transcripts from the TTSS cluster appear later than those involved in Nod-factor synthesis (Perret *et al.*, 1999). Delayed induction of the TTSS cluster can be explained by its multi-step regulation, which relies first on activation of *ttsI* transcription from a *nod*-box via flavonoids and NodD1. In turn, TtsI activates TTSS genes from their *tts*-box promoters. Obviously, it takes longer for TtsI to accumulate than NodD1, and partly explains why *nod* genes are expressed before those involved in TTSS. Interestingly, some TTSS components (e.g., *nopB*, *nopL*) continue to be expressed in nodules, whereas transcription of others is arrested (e.g., *ttsI*, *nopX*).

4.2. Auto-repression of NodD via a *nod*-box Superimposed on the *nodD* Promoter

R. leguminosarum bv. *viciae* possesses a single *nodD* gene, which is located upstream of *nodA* (but in the opposite orientation), and is auto-repressed by its own

product. The *nodD* promoter is super-imposed on the *nodA nod* box. Using purified NodD, *in vitro* studies showed that binding of NodD to the *nod* box blocks the access of RNA polymerase to the *nodD* promoter (Hu *et al.*, 2000). As this arrangement (an inversely oriented *nod*-box upstream of *nodD* gene) has been found in many rhizobia (Schlaman *et al.*, 1998), it is possible that similar auto-repression occurs generally. In contrast, *nodD1* of *B. japonicum* USDA110 has a flavonoid-inducible *nod* box-like sequence as its own promoter (Wang and Stacey, 1991).

4.3. *NolR*, a Repressor of the *ArsR* Family

The *nolR* gene of *R. meliloti* strain AK631 was discovered by its ability to repress *nod*-gene expression. *NolR* is a repressor of the *ArsR* family (Kondorosi *et al.*, 1991b) that contains a helix-turn-helix DNA-binding domain and binds to conserved 5'-(A/T)TTAG-N₉-A(T/A)-3' motifs as a dimer. In *R. meliloti*, the *NolR* target sequences are located 2-12 bp downstream of *nod* boxes n1, n4, and n6 and in the *nolR* promoter (Cren *et al.*, 1995). *NolR* can, therefore, suppress the synthesis of the Nod-factor backbone by inhibiting transcription of *nodABCIJ* (from *nod* box n1) and *nodMnolFGnodN* (from *nod* box n4), suggesting that *NolR* modulates expression of genes involved in the synthesis of the Nod-factor backbone and, thus, allows proper decoration. Because *nod*-boxes n1 and n6 are superimposed within the promoters of *nodD1* and *nodD2*, respectively, *NolR* also negatively regulates expression of *nodD1* and *nodD2*. *NolR* mediates auto-repression by binding to its own promoter. Mutation of *nolR* in *R. meliloti* causes a delay in nodulation, suggesting that fine-tuning by *NolR* is necessary for optimal nodulation. DNA hybridisations indicate that *nolR* homologs are widespread throughout the *Rhizobiaceae*, but not in *Agrobacterium*, *Azorhizobium*, *Bradyrhizobium*, and *Mesorhizobium* (Kiss *et al.*, 1998). Although *nolR* is highly expressed both in the free-living and symbiotic states, it does not appear to be responsible for suppression of *nod* genes in bacteroids.

A comparison of proteins extracted from both *R. meliloti* AK631 (*nolR*⁺) and EK698 (containing a Tn5-induced mutation in *nolR* of strain AK631) by 2D-PAGE (Chen *et al.*, 2000a) showed changed levels of 189 proteins (101 were increased and 88 decreased by the mutation). Among those affected were homologs of enzymes involved in the tricarboxylic-acid cycle, stress responses, protein synthesis, cell growth and maintenance as well as a translation elongation factor. Thus, it seems that *NolR* is integrated into the global regulatory system, which regulates cellular metabolism in response to environmental stimuli.

4.4. *SyrM* Modulates the Expression of *nod*- and *nif*-Genes

The *nod*-box n7 of *R. meliloti* regulates expression of *SyrM*, which is another LysR-type regulator closely related to NodD (Figure 3A; Barnett *et al.*, 1996). NodD3 of *R. meliloti* modulates transcription of *syrM* (Maillet *et al.*, 1990). In turn, *SyrM* activates transcription of *nodD3* from the *SyrM*-binding motif contained in the *nodD3* promoter (Figure 3B; Xiao *et al.*, 1998). Because NodD3 modulates

expression of *nod* genes in an inducer-independent manner, SyrM and NodD3 form a self-amplifying regulatory circuit to regulate expression of *nod* genes that are independent of flavonoids (Swanson *et al.*, 1993).

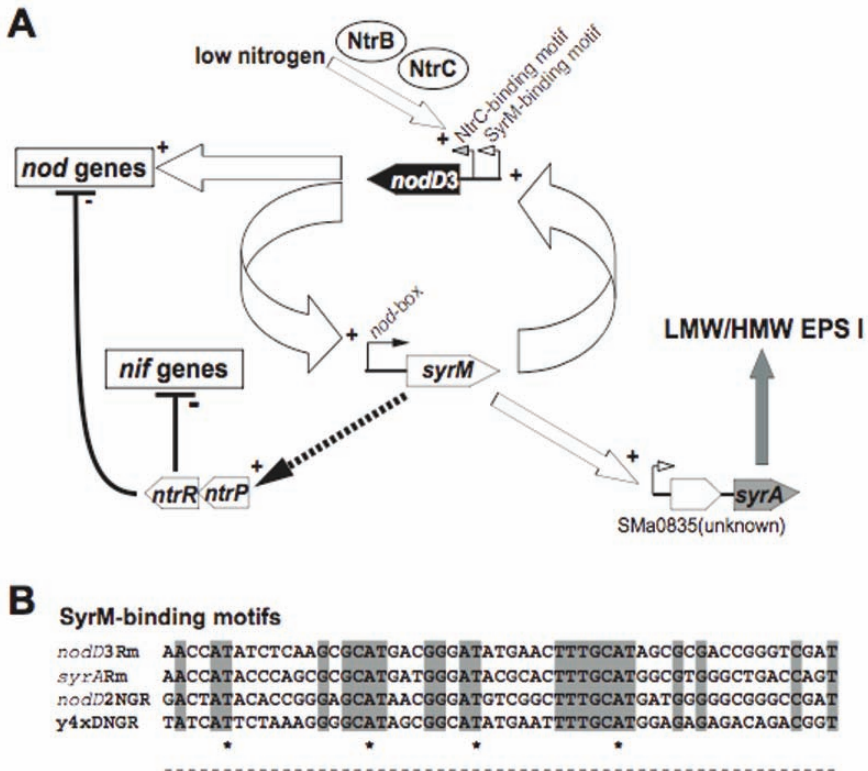

Figure 3. Model of the SyrM-NodD3-mediated regulatory circuit in *R. meliloti*.
 A. NodD3 up-regulates transcription of *syrM* from *nod*-box *n7* without flavonoid inducers. SyrM activates expression of *nodD3* and *syrA* from its binding motif. Under nitrogen-limiting conditions, NtrC phosphorylated by NtrB induces transcription of *nodD3* from NtrC-binding motifs. SyrM stimulates the expression of *ntrR*, which represses *nod*-genes and nitrogenase expression. SyrM also affects both the amount and the ratio of the low molecular weight (LMW) to high molecular weight (HMW) EPSI (Dusha *et al.*, 1999b), most likely by regulating expression of *syrA*.
 B. Binding motifs of a LysR-type transcriptional regulator SyrM identified in *R. meliloti* and NGR234 (Barnett *et al.*, 1998; Kobayashi *et al.*, 2004; Xiao *et al.*, 1998). Nucleotides conserved in all four motifs are shaded. * indicates the LysR motif and – indicates the protected sequences in DNaseI footprints (Xiao *et al.*, 1998).

DNaseI foot-printing experiments showed that binding of SyrM to its binding motif spans the region from –28 to –83, on both the coding- and non-coding strands (Xiao *et al.*, 1998), but failed to reveal a hypersensitive site. In addition to a LysR

motif, this region also contains inverted repeats (Figure 3B). Binding assays, using synthetic oligo-nucleotides, indicate that at least three inverted repeats are necessary for binding, suggesting that SyrM may attach to its binding motif as a dimer or tetramer. Expression of *syrM* is negatively affected by *syrB*, which encodes a 16.5-kDa protein of unknown function (Barnett and Long, 1997).

This putative SyrM-binding motif is also found in the promoter region of *syrA*, which encodes a 9-kD hydrophobic protein (Figure 3B; Barnett *et al.*, 1998). Introduction of *syrA* on a multi-copy plasmid into *R. meliloti* 1021 rendered the colonies mucoid, suggesting that SyrA is involved in modification or synthesis of exopolysaccharides (EPS). SyrA also helps to repress *agpA*, a putative periplasmic-binding protein required for the utilisation of melibiose and raffinose (Gage and Long, 1998). Mutation in *syrM* affects both the amount (64% of wild-type) and the ratio of the low molecular weight (LMW) to high molecular weight (HMW) EPSI (Dusha *et al.*, 1999b). It is likely that these effects are due to the absence of a *syrA* product. Higher levels of expression of *exoK* were also observed in the *syrM* mutant. Because the promoter of *exoK* lacks the conserved SyrM-binding motif, this effect may be indirect. Thus, SyrM acts *in trans* to regulate *nod*-gene expression via *nodD3* and to regulate EPS production via *syrA*.

This NodD3-SyrM regulatory circuit also modulates *nod*-gene expression in response to changing nitrogen levels (Dusha, 2002). The *nodD3*-promoter region contains binding motifs (Dusha *et al.*, 1999a) for NtrC, a response regulator that is phosphorylated by a histidine kinase (encoded by *ntrB*) under nitrogen-limiting conditions (Merrick and Edwards, 1995). Phosphorylated NtrC induces transcription of *nodD3*, resulting in enhanced expression of both *nod* genes and *syrM*. In turn, SyrM stimulates expression of the *ntrPR* operon (Olah *et al.*, 2001). NtrR, a member of the Vap family, represses expression of *nodABC*, *nodD3*, *nifA* and *nifH*, as well as its own expression, by an unidentified mechanism (Dusha *et al.*, 1989). Because the *ntrPR* operon lacks the conserved SyrM-binding motif, up-regulation of *ntrPR* by SyrM is probably indirect. Under conditions of nitrogen starvation, *nodD3* is, thus, activated by NtrC. The increased levels of NodD3 transiently enhance *syrM* and *nod*-gene expression, which in turn decreases transcription of *nod* genes by activating *ntrR*. The advantage of this up- then down-regulation of *nod* genes by nitrogen limitation is unclear because mutation of *ntrR* increases the symbiotic efficiency of *R. meliloti*.

Mutation of regulatory genes can have different effects on plants belonging to the same genus. Nodulation of *M. sativa* is only delayed by a *syrM*⁻ mutant that produces Fix⁻ nodules on *M. truncatula* (Kondorosi *et al.*, 1991a; Smith and Long, 1998), suggesting that *syrM* is important in sustaining nodulation, but not in its initiation. Indeed, *syrM*-GUS fusions are expressed in the N₂-fixing zone of nodules (Swanson *et al.*, 1993). The stringent requirement of *M. truncatula* for a functional *syrM* is not due to its regulatory roles on *nodD3*, *syrA* or *ntrR*, however, because mutation of *nodD3* or *syrA* has only minor effects on nodulation with *M. truncatula* (Barnett *et al.*, 1998; Smith and Long, 1998). Perhaps SyrM regulates other genes important for nodule development on *M. truncatula*. In addition, *nodD3* and *syrM* are required for N-acetylation of NodRm factors by (omega-1)-hydroxylated fatty acids (Demont *et al.*, 1994). Recently, transcriptomic analyses

suggested that the SyrM-NodD3 regulatory circuit modulates expression of approximately 200 genes (Barnett *et al.*, 2004; see section 5).

4.5. *NodD2* is a Repressor of *nod*-Gene Transcription in *B. japonicum* USDA110

In *B. japonicum* USDA110, NodD2 represses *nod*-gene expression (Figure 4). Ectopic expression of *nodD2* from a constitutive promoter significantly reduces the activity of a *nodC-lacZ* fusion (Garcia *et al.*, 1996). One explanation is that NodD2 binds to *nod* boxes, but fails to initiate transcription. NodD2 would then inhibit transcription from *nod* boxes by competing with NodD1. Deletion of *nodD2* significantly delays nodulation of *G. max*, indicating that down-regulation of *nod* genes by NodD2 is required for optimal nodulation (Göttfert *et al.*, 1992).

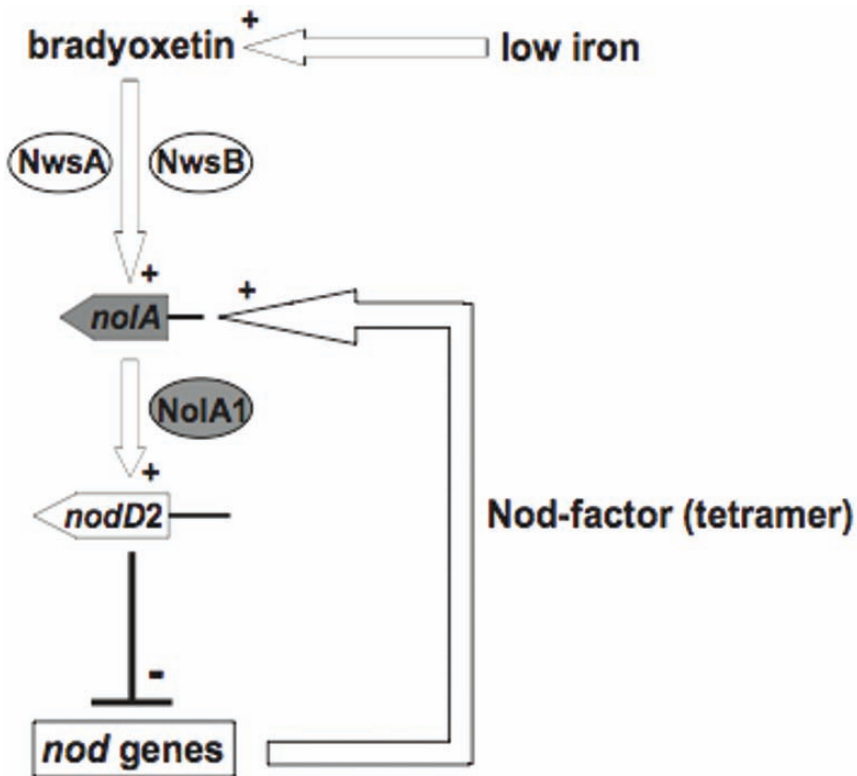

Figure 4. Model of *nod*-gene repression by *NodD2* in *B. japonicum*. Under iron-limited conditions, the cell-density factor bradyoxetin is produced and up-regulates expression of *nolA* via *NwsAB*. One of three *nolA* products, *NoIA* up-regulates *NodD2*, which in turn represses expression of *nod* genes. *NodD1* and *NodVW* also activate *nod* genes, resulting in *Nod*-factor synthesis. Tetrameric *Nod* factors activate expression of *nolA*, resulting in feed-back regulation of *nod* genes.

In *B. japonicum*, regulation of *nodD2* is complex (Loh and Stacey, 2003). It is activated by NolaA, a MerA-type regulator (Garcia *et al.*, 1996). *nolA* possesses three in-frame start codons, which result in three functionally different proteins, NolaA₁, NolaA₂ and NolaA₃ (Loh *et al.*, 1999). Translation of NolaA₁ is initiated from the first ATG, NolaA₂ from the second, NolaA₃ from the third. Only NolaA₁ has a helix-turn-helix DNA-binding domain and it activates the transcription of *nodD2*. *nolA* is transcribed from a promoter (P1) located 87 bp upstream of the first ATG of *nolA*. Then, NolaA₁ up-regulates transcription of *nolA*₂ and *nolA*₃ from another promoter (P2), which is located downstream of P1. A putative NolaA₁-binding site, similar to those found in MerA-type promoters, occurs both in the P2 promoter and in the promoter region of *nodD2*. Thus, NolaA₁ is a positive regulator of *nolA*₂, *nolA*₃, and *nodD2* expression. Like most *nodD2* mutants, *nolA* mutants also exhibit a delayed nodulation phenotype on some soybean cultivars, but a functional *nolA* is necessary for nodulation of *V. unguiculata* (Garcia *et al.*, 1996). Further, NolaA₃ is also required for nodulation of *G. max* PI 377578 (Loh *et al.*, 1999).

Surprisingly, Nod factors and bradyoxetin (see below) activate transcription from the *nolA* P1 promoter, resulting in up-regulated expression of *nolA*₁, and consequently also of *nodD2*. *B. japonicum* Nod factors are either tetrameric or pentameric. Expression of *nolA*₁ is specifically induced by pentameric Nod factors (Loh and Stacey, 2001), resulting in negative feed-back regulation of Nod-factor production. A cell-density factor called bradyoxetin, 2-(4-{[4-(3-aminoxetan-2-yl)phenyl](imino)methyl}phenyl)oxetan-3-ylamine, also induces *nolA*₁ expression (Loh *et al.*, 2001; 2002b). Because bradyoxetin production is negatively regulated by iron, it is secreted into the environment under iron-depleted conditions. When its concentration reaches a certain threshold, phosphorylation of the two-component-response regulator NwsB by NwsA is provoked and the phosphorylated-NwsB induces *nolA*₁ expression (Loh *et al.*, 2002a). Bradyoxetin thus mediates repression of *nod* genes in a quorum-sensing manner. *nolA::GUS* fusions have shown that *nolA* is highly expressed in nodules (Garcia *et al.*, 1996). It is likely that bradyoxetin produced by bacteroids (so up-regulating *nolA*) silences *nod* genes. Because iron is a component of nitrogenase, its rapid sequestration for nitrogenase synthesis may result in low free-iron levels in N₂-fixing bacteroids and trigger bradyoxetin production. How bradyoxetin is synthesised is not yet known.

B. japonicum has an additional flavonoid recognition system, NodVW, which is a two-component sensor-regulator (Göttfert *et al.*, 1990; Loh *et al.*, 1997). In the presence of isoflavones, the sensor kinase NodV phosphorylates the response regulator NodW, which then activates transcription of *nodD1* and *nodYABCSUIJ* by unknown mechanism(s). Functional *nodVW* genes are required for nodulation of *M. atropurpureum* and *V. unguiculata*, but not for *G. max*. Expression of TTSS in *B. japonicum* requires a functional *nodVW* (Krause *et al.*, 2002).

4.6. Flavonoid-inducible Regulon in the Broad-host-range NGR234

Rhizobium sp. NGR234 is the most promiscuous rhizobial symbiont known. It fixes N₂ in association with plants that form both determinate and indeterminate

nodules (Pueppke and Broughton, 1999; Trinick, 1980). One molecular determinant of symbiotic promiscuity is NodD1, which is able to positively respond to a wide range of inducers (Le Strange *et al.*, 1990). In the mutant strain NGR Ω *nodD1*, nodulation is abolished on all host-plants tested (Relić *et al.*, 1993b).

4.6.1. Flavonoid Signal-transduction Cascade of NGR234

To respond to flavonoids released by potential host plants, NGR234 has evolved a complex regulatory cascade that includes in sequence NodD1, TtsI, SyrM2 and NodD2 (Figure 5). The symbiotic plasmid pNGR234*a* possesses nineteen *nod*-boxes, only five of which (NB2, NB4, NB7, NB8 and NB12) control Nod-factor synthesis. As all *nod*-boxes (with the exception of NB3) are active (Kobayashi *et al.*, 2004), the flavonoid/NodD1/*nod* box regulatory cascade must quantitatively and temporally modulate expression of many other genes. Rapid induction [1 hour post induction (hpi) with the flavonoid daidzein] was observed with five *nod* boxes (NB2, NB4, NB5, NB8 and NB10). In contrast, four *nod* boxes (NB6, NB15, NB16 and NB17) were strongly induced but only 24 hpi and, surprisingly, their activities were highly dependent on NodD2. In a previous study (Fellay *et al.*, 1998), NodD2 of NGR234 was shown to be a repressor of Nod-factor production, like NodD2 of *B. japonicum*. Thus, NodD2 of NGR234 helps to repress some *nod* boxes, such as NB8, while activating others (NB6, NB15, NB16 and NB17).

Temporal induction of different *nod* boxes reflects the kinetics of expression of the two *nodD* homologs. In NGR234, regulation of *nodD1* and *nodD2* expression is also subject to a flavonoid-inducible regulatory cascade. As with NodD3 and SyrM of *R. meliloti*, SyrM2, which is one of two *syrM* homologs controlled by NB19 in pNGR234*a*, is necessary for activation of transcription of *nodD2*. What is different, however, is that *syrM2* is mainly under the control of NodD1, making it unlikely that NodD2 and SyrM2 form a positive regulatory loop. Rather, upon flavonoid perception, NodD1 activates expression of *syrM2* via NB19, followed by SyrM2 then inducing transcription of *nodD2* from its binding motif in the *nodD2* promoter (Figure 3B). This indirect system, which involves *de novo* synthesis of two regulators, means that induction of *nodD2* and, thus, accumulation of NodD2 begins about 6 hpi and results in delayed induction of NodD2-dependent *nod* boxes. On the other hand, expression of *nodD1* seems to be negatively regulated by flavonoids. Because NB3 is superimposed on the *nodD1* promoter, binding of NodD1 to NB3 may inhibit access of RNA polymerase to the *nodD1* promoter (Hu *et al.*, 2000). Introduction of *nodD2* on a multi-copy plasmid completely suppressed transcription of *nodD1*, confirming that increased levels of NodD2 contribute to the repression of *nodD1* (Theunis *et al.*, 2004). Conversely, introduction of the multi-copy *nodD2* plasmid into wild-type NGR234 rendered expression of NB15-*lacZ* constitutive, suggesting that NodD2 proteins activate transcription from these *nod* boxes independently of flavonoids (Theunis *et al.*, 2004).

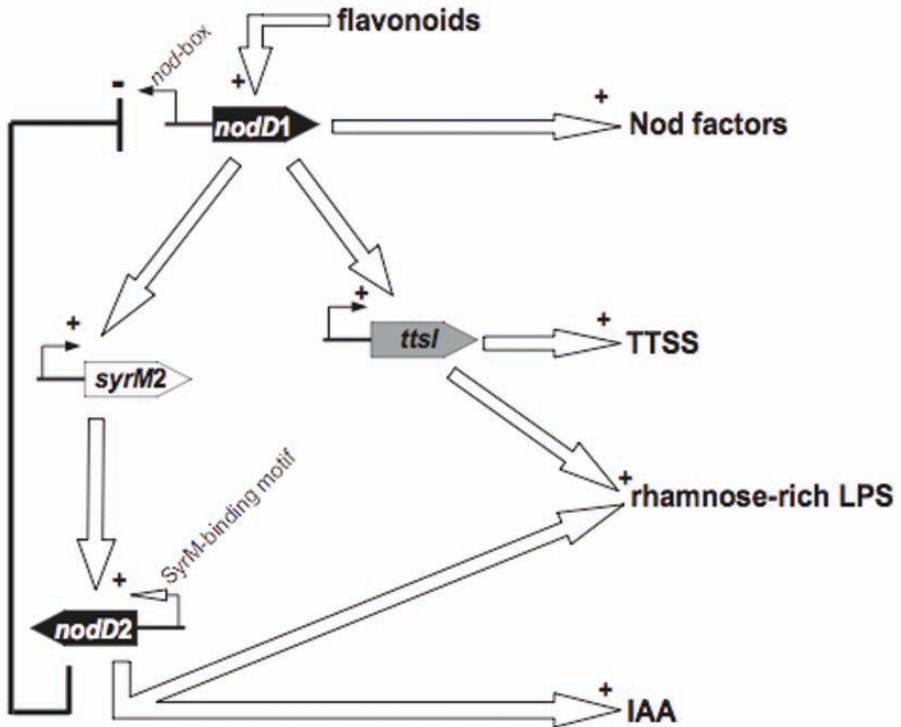

Figure 5. Model of the flavonoid signal transduction cascade in *NGR234*. Compatible flavonoids trigger a complex regulatory cascade that includes *NodD1*, *NodD2*, and *SyrM2*, as well as *TtsI*. The *NodD*-flavonoid complex sequentially activates at least 75 loci on *pNGR234a*. Upon flavonoid addition, *NodD1* rapidly activates transcription of operons responsible for the synthesis of Nod factors. Nod factors trigger the nodulation process in plants. *NodD1* also activates synthesis of *TtsI* and *SyrM2*. Together, they trigger additional functions (e.g. *TTSS* and synthesis of rhamnose-rich LPS) that are probably required when more intimate contact between the bacteria and their hosts has been established. In turn, *SyrM2* activates transcription of *nodD2*. At this third regulatory level, *NodD2* triggers late flavonoid-inducible loci such as *y4wEF*, which is involved in the synthesis of indole-3-acetic acid (*IAA*). Concomitantly, *NodD2* represses expression of *nodD1*. In this way, a simple flavonoid, such as daidzein, not only induces the synthesis and secretion of Nod factors, but also sequentially triggers other functions that are required after the initial infection of root-hairs (e.g., during the development of infection threads or prior to the release of rhizobia into nodule cells).

4.6.2. Functions of Genes Directly Controlled by *nod* Boxes in *NGR234*

In addition to the five *nod* boxes linked to *nod* genes, *nod* boxes modulate various functions in *NGR234*. *NB1* precedes a putative operon that encodes squalene synthases (*y4aC* and *y4aD*), a squalene dehydrogenase (*y4aB*), and a squalene-hopene cyclase (*y4aA*). All are needed for the synthesis of hopanoids, a class of

pentacyclic triterpenoid lipids, from farnesyl diphosphate. Hopanoids and the genes involved in their synthesis have been found in *B. japonicum* (Kannenberg *et al.*, 1995; Perzl *et al.*, 1997; 1998). The gene, *y4hM*, which is downstream of the NB9-NifA- σ^{54} combined promoter, is predicted to encode an enzyme of the Gfo/Idh/MocA oxidoreductase family. Rhizobial *myo*-inositol dehydrogenases, which are involved in rhizopine catabolism, belong to this family (Galbraith *et al.*, 1998; Jiang *et al.*, 2001; Rossbach *et al.*, 1994). The NB14-NifA- σ^{54} combined promoter controls *y4vC*, which is a member of the HesB/Yadr/YfhF family of genes that are involved in iron-cluster formation of nitrogenase (Dombrecht *et al.*, 2002). NB10 is highly inducible and up-regulates transcription of *y4iR*, a homolog of *psiB*. In *R. leguminosarum* bv. *phaseoli*, PsiB is an inner-membrane protein of unknown function that is co-transcribed with the exo-polysaccharide production inhibitor, PsiA (Borthakur and Johnston, 1987; Mimmack *et al.*, 1994). Close homologs of an unknown protein encoded by *y4mC* (preceded by NB11) are only found on the Ti plasmids of *Agrobacterium tumefaciens* (AAK91122, BAA87763) and a Ri plasmid of *A. rhizogenes* (BAB16266). The functions of these genes have not been clearly elucidated.

4.6.3. Genes Regulated by NodD2-dependent nod Boxes

Functions controlled by NodD2-dependent *nod* boxes (NB6, NB15, NB16 and NB17) probably operate later in the symbiosis. NB6 controls the expression of *fixF*, which encodes a homolog of the capsule-export protein KpsS of *Escherichia coli*. Mutational analysis showed that the protein encoded by *fixF* is involved in the synthesis of smooth lipo-polysaccharides (S-LPS) (Jabbouri *et al.*, 1996). Fraysse *et al.* (2002) then showed that, in the presence of an inducing flavonoid, NGR234 synthesises S-LPS, which differs from the LPS produced by uninduced cultures. The S-LPS contains a modified core oligosaccharide that is linked to an O-antigen of poly-L-rhamnose (also called rhamnose-rich LPS) (Reuhs *et al.*, 2005). Although the *fixF*-defective mutant nodulated *M. atropurpureum*, *T. vogelii*, and *V. unguiculata*, it failed to fix N₂, suggesting that the new flavonoid-inducible LPS plays a critical role in later stages of the symbiosis (Broughton *et al.*, 2006).

Mutation of genes controlled by NB15 and NB16 caused no obvious phenotypes on the hosts *T. vogelii* and *V. unguiculata* (Theunis *et al.*, 2004; H. Kobayashi, unpublished data). NB15 controls the operon *y4wEFG* that is involved in synthesis of indole-3-acetic acid (IAA) via the indole-3-pyruvic acid pathway (Theunis *et al.*, 2004). The genes, *y4wE* and *y4wF*, probably encode a tryptophan transferase and an indole acetaldehyde oxidase, respectively; *y4wG* is most likely cryptic. Knocking out *y4wE* abolished flavonoid-inducible IAA synthesis and significantly decreased the levels of IAA and IAA-conjugants in nodules. NB16 regulates *y4wH*, which is homologous to *virK* of *A. tumefaciens* (AAA82504, AAC71789), *Ralstonia solanacearum* (CAD15992), *Xanthomonas axonopodis* pv. *citri* (AAM35326, AAM39736), and *Xylella fastidiosa* (AAF84747). The VirK homologs possess putative N-terminal signal peptides and cleavage sites, suggesting that the VirK protein is translocated either to the periplasm or to the extra-cellular space. In *A. tumefaciens* harbouring octopine- or nopaline-type Ti plasmids,

expression of *virK* is strongly induced by acetosyringone. Disruption of *virK* does not affect tumorigenesis on leaves of *Kalanchoe diagramontiana* or carrot disks, suggesting that its role in virulence is non-essential (Kalogeraki and Winans, 1998). NB17 controls *y4wM*, which encodes a member of the same bacterial extra-cellular solute-binding protein family five that usually forms part of an ABC transporter, but the function of *y4wM* in NGR234 has not been established.

4.6.4. Functions Regulated by *SyrM2* and *TtsI*

Transcription of *syrM2* and *ttsI* is controlled by NB18 and NB19, respectively. Conserved binding motifs for SyrM and TtsI have been identified in pNGR234a (Kobayashi *et al.*, 2004; Marie *et al.*, 2004). In addition to one in the *nodD2* promoter, another putative SyrM-binding motif was identified upstream of *y4xD* (Figure 3B). Because flavonoid-inducible transcripts of *y4xD* have been observed (Perret *et al.*, 1999), this promoter is probably also under the control of SyrM2. Five ORFs, *y4xDEFQG*, are located downstream of this motif, including *y4xQ*, which encodes a protein markedly similar to SyrA.

Computational analyses of pNGR234a revealed eleven *tts*-box-like elements (TB1-TB11) (Marie *et al.*, 2004). All *tts*-box::*lacZ* fusions were inducible in a daidzein- and *ttsI*-dependent manner (H. Kobayashi and K. Kambara, unpublished data). Six are located in the TTSS cluster and they control transcription of components of the TTSS-secretion machine or *nop* genes. Three other functional *tts* boxes are located upstream of *y4IO* and *y4zC*, which are ORFs that encode proteins showing extensive homology to virulence factors secreted by TTSSs of plant and animal pathogens. Nevertheless, several functions unrelated to TTSS are also regulated by *tts* boxes. For example, *tts* box TB2 controls transcription of the *rmlBDAwbgA* region (Marie *et al.*, 2004). Proteins encoded by *rmlB*, *rmlD* and *rmlA* are homologs of enzymes involved in the synthesis of dTDP-rhamnose from glucose-1-phosphate. *WbgA* is a homolog of a protein of an unknown function that is required for O-antigen biosynthesis in *Myxococcus xanthus*. Deletion of *rmlBDAwbgA* abolishes synthesis of rhamnose-rich LPS, indicating that these genes are involved in synthesis of symbiotic O-antigens (Broughton *et al.*, 2006). In this way, TB2-*rmlBDAwbgA* and NB6-*fixF*, TtsI, and NodD2 cooperatively regulate the synthesis of flavonoid-inducible rhamnose-rich LPSs.

5. POST-GENOMIC STUDIES: DO FLAVONOIDS REGULATE OTHER GENES?

“Reverse Northern” analyses of pNGR234a show that daidzein enhances the transcription of approximately 147 ORFs that are “silent” under free-living conditions (Perret *et al.*, 1999). Most, but not all, of these strongly induced genes are associated with *nod* boxes or *tts* boxes. Some, including the putative transcriptional regulators *y4aM*, *mucR*, *y4cH*, *traR*, *traM*, *y4dJ*, *y4dL*, and *y4fQ*, were not associated with known flavonoid-inducible promoters. Ampe *et al.* (2003) monitored the expression of 214 *R. meliloti* genes under ten environmental conditions, including culture in the presence of luteolin. In addition to *nod* genes,

luteolin induced the expression of *traA1*, *traA2*, *sma2339*, *sitA*, *smc01516*, and *ialA*. Surprisingly, however, induction of these same genes by luteolin was not confirmed by a later study (Barnett *et al.*, 2004), using Affymetrix™ GeneChips that covered the whole *R. meliloti* genome. Luteolin induced large changes in expression of genes downstream of the known *nod* boxes (*nodA*, *B*, *C*, *E*, *F*, *G*, *H*, *I*, *J*, *L*, *nolF*, *noeA*, SMa0850, and SMa0851). Although another 13 ORFs were up-regulated, further analyses, including transcriptional *uidA*-fusions, showed that their expression varied from culture to culture rather than being dependent on flavonoids.

Over-expression of *nodD1* or *nodD3* (under the control of the constitutive *trp* promoter) was also analysed in a strain of *R. meliloti* with all three *nodD* genes knocked out. Luteolin increased activity of *nod*-box-controlled *nod* genes in a strain that over-expressed *nodD1*. In the strain that over-expressed *nodD3*, expression of *syrM* and *syrA* was enhanced along with the inducible *nod* genes. Over-expression of *nodD3* also resulted in enhanced expression of more than 90 other genes and decreased expression of a further 95 genes. Genes whose expression was enhanced included: (i) most of the *exo* genes that are involved in succinoglycan biosynthesis; (ii) clusters of genes possibly involved in cell surface polysaccharide synthesis (SMb21188, 21189, 21190, 21291); (iii) those of a putative C₄-dicarboxylate transport system (SMb21436, 21437, 21438); (iv) those of a putative iron ABC-transporter (SMb21540, 21541); and (v) *sinI* which encodes an autoinducer synthase. Half of the genes repressed in the elevated *nodD3* background were involved in motility and chemotaxis (*che*, *fla*, *flb*, *flg*, *flh*, *fli* and *mot* genes). Expression of both succinoglycan and flagellar synthesis was affected by ExoR and the ExoS/ChvI two-component regulatory system (Yao *et al.*, 2004), suggesting that EPS production and motility share common regulatory pathway(s). Because SyrM regulates EPS production, most of the effects of *nodD3* on over-expression are probably due to the indirect effect of *syrM* over-expression. Surprisingly, transcription of *nodL* in bacteroids was increased by up to 50-fold (compared to non-induced cultures), but most *nod* genes were not expressed.

Proteomic methods revealed that global expression of *R. leguminosarum* bv. *trifolii* ANU843 proteins is largely unaltered by 7,4'-dihydroxy-flavone (Guerreiro *et al.*, 1997); only four proteins, NodB, NodE, and two other proteins without database matches, are induced. In *R. meliloti*, no differences were seen in the presence of luteolin (Guerreiro *et al.*, 1999). In later studies (Chen *et al.*, 2000a) to identify *nolR*-regulated proteins, 11 proteins that were induced by luteolin in *R. meliloti* AK631 (*nolR*⁺) were not induced in *R. meliloti* EK698 (*nolR*⁻). PMF and N-terminal sequence analyses revealed that one of these proteins has homology to an elongation factor. In contrast, three proteins were induced by luteolin and another four suppressed in the *nolR*⁻ background. Contrasting expression profiles involving 60 proteins were observed for *R. meliloti* strain 2011 and a pSymA-cured derivative (Chen *et al.*, 2000b). The majority of these differences were due to regulatory changes, such as up- and down-regulation, suggesting that pSymA helps regulate gene expression on other replicons (chromosome and pSymB). Because luteolin induced the expression of at least four proteins in the absence of pSymA,

flavonoid-perception systems that do not involve NodD may exist in the chromosome and/or in pSymB.

6. CONCLUSION AND PERSPECTIVES: ROLES OF FLAVONOID-INDUCIBLE REGULONS IN SYMBIOSIS, SIGNALING AND ADAPTATION

Flavonoids are but one of the well-documented signal molecules that emanate from host legumes. The functions of genes activated by flavonoids can be divided into two categories, either signaling or physiological. Well-documented examples of signaling functions include Nod factors that are required for invasion of root hairs, but Nod factors are only one of the many signals that emanate from rhizobia. *R. etli* and the *Lotus* symbiont, *M. loti*, produce identical Nod factors but *R. etli* forms nodules that senesce early on *L. japonicus*, suggesting that additional signal(s) are required for successful symbiosis (Banba *et al.*, 2001). In *R. meliloti*, such additional signals may include succinoglycans that are necessary for initiating and extending the growth of infection threads (Pellock *et al.*, 2000). *R. meliloti* produces two EPSs, succinoglycan and EPS II (Becker and Pühler, 1998). EPS-defective mutants of *R. meliloti* fail to invade nodules because of a block in infection-thread development. Purified low-molecular-weight succinoglycan and EPS II can rescue the nodule invasion defect at picomolar concentrations, pointing to the existence of a specific recognition system for EPSs by plants (Niehaus *et al.*, 1993; Parniske *et al.*, 1994). Production of succinoglycans is modulated by SyrM. All rhizobia so far sequenced possess either TTSS or TFSS, which probably provide other signal molecules (Nops) required for optimal nodulation (Broughton *et al.*, 2000). *In vitro* and *in planta* studies of NopL strongly suggest that Nops can interfere with the host's signal-transduction system. Most probably, production of these signals is temporally and spatially modulated *via* flavonoid-inducible regulatory networks.

In NGR234, some flavonoid-inducible genes are required for adaptation to environmental changes during the trip from the rhizosphere to nodule tissue. Here, *fixF* is of particular interest because of the serious defects in bacteroid development provoked by its absence (Broughton *et al.*, 2006). Similarly, LPS mutants of *R. leguminosarum* bv. *viciae* induce ineffective nodules on *P. sativum* (Perotto *et al.*, 1994). *R. meliloti* *lpsB*⁻ and *bacA*⁻ mutants, which have an altered LPS-core structure and distribution of LPS lipid A fatty acids, respectively, display developmental abnormalities when the bacteria invade the nodule cytosol (Campbell *et al.*, 2002; Ferguson *et al.*, 2002). These observations indicate that the correct LPS structure is required for bacteroid development. Kannenberg and Carlson (2001) showed that LPS becomes increasingly hydrophobic during bacteroid development. A hydrophobic bacteroidal surface may facilitate endocytotic invasion and/or protect the bacteria against toxic compounds (Kannenberg and Carlson, 2001). Both *R. meliloti* *lpsB*⁻ and *bacA*⁻ mutants are more sensitive to cationic peptides (Campbell *et al.*, 2002; Ferguson *et al.*, 2002). Although reduced O₂ levels and acidic conditions induce production of hydrophobic LPS in *R. leguminosarum* bv. *viciae* (Kannenberg and Brewin, 1989), *R. fredii*

produces hydrophobic LPSs in the presence of host-root extract (Reuhs *et al.*, 1994). By activating the transcription of *fixF* from a *nod* box and *rmlBDAwbgA* from a *tts* box, flavonoids probably trigger changes in NGR234 that lead to a more hydrophobic bacteroid envelope.

It is also possible that rhizobial LPSs are the signals that trigger changes in plant membranes from degradative vacuoles to symbiotic peribacteroid compartments. Treatment of *R. meliloti* with purified LPS suppressed the yeast elicitor-induced alkalinisation and oxidative-burst reaction in *M. sativa* cell cultures (Albus *et al.*, 2001). In tobacco (non-host) cells, LPS causes alkalinisation and an oxidative burst. Taken together, these data suggest that LPSs released from the bacterial surface of *R. meliloti* might serve as specific rhizobia-to-legume signals. Bacterial LPSs are recognised by the Toll-like receptor kinase 4 in the innate immune system of insects and mammals (Takeda *et al.*, 2003). The innate immune response against bacterial flagellin is mediated by Toll-like receptor kinase 5 (Hayashi *et al.*, 2001). Similar mechanisms of flagellin recognition are also found in plants (Gómez-Gómez and Boller, 2002). Thus, it is possible that rhizobial LPSs (and other polysaccharides) are recognised by Toll-like receptor kinases of host legumes. There are more than 100 genes that encode Toll-related proteins in plants (Jebanathirajah *et al.*, 2002) and some of these proteins are implicated in the resistance to pathogens. Application of combined biochemical and genetic approaches to both symbiotic partners will help elucidate additional roles of signal exchange in nodulation.

REFERENCES

- Albus, U., Baier, R., Holst, O., Pühler, A., and Niehaus, K. (2001). Suppression of an elicitor-induced oxidative burst reaction in *Medicago sativa* cell cultures by *Sinorhizobium meliloti* lipopolysaccharides. *New Phytol.*, 151, 597-606.
- Ampe, F., Kiss, E., Sabourdy, F., and Batut, J. (2003). Transcriptome analysis of *Sinorhizobium meliloti* during symbiosis. *Genome Biol.*, 4, R15.
- Atkinson, E. M., Palcic, M. M., Hindsgaul, O., and Long, S. R. (1994). Biosynthesis of *Rhizobium meliloti* lipooligosaccharide Nod Factors - NodA is required for an N-acyltransferase activity. *Proc. Natl. Acad. Sci. USA*, 91, 8418-8422.
- Ausmees, N., Kobayashi, H., Deakin, W. J., Marie, C., Krishnan, H. B., Broughton, W. J., *et al.* (2004). Characterization of NopP, a type III secreted effector of *Rhizobium* sp. strain NGR234. *J. Bacteriol.*, 186, 4774-4780.
- Banba, M., Siddique, A. B. M., Kouchi, H., Izui, K., and Hata, S. (2001). *Lotus japonicus* forms early senescent root nodules with *Rhizobium etli*. *Mol. Plant-Microbe Interact.*, 14, 173-180.
- Barnett, M. J., Rushing, B. G., Fisher, R. F., and Long, S. R. (1996). Transcription start sites for *syrM* and *nodD3* flank an insertion sequence relic in *Rhizobium meliloti*. *J. Bacteriol.*, 178, 1782-1787.
- Barnett, M. J., and Long, S. R. (1997). Identification and characterization of a gene on *Rhizobium meliloti* pSymA, *syrB* that negatively affects *syrM* expression. *Mol. Plant-Microbe Interact.*, 10, 550-559.
- Barnett, M. J., Swanson, J. A., and Long, S. R. (1998). Multiple genetic controls on *Rhizobium meliloti* *syrA*, a regulator of exopolysaccharide abundance. *Genetics*, 148, 19-32.
- Barnett, M. J., Fisher, R. F., Jones, T., Komp, C., Abola, A. P., Barloy-Hubler, F., *et al.* (2001). Nucleotide sequence and predicted functions of the entire *Sinorhizobium meliloti* pSymA megaplasmid. *Proc. Natl. Acad. Sci. USA*, 98, 9883-9888.

- Barnett, M. J., Toman, C. J., Fisher, R. F., and Long, S. R. (2004). A dual-genome Symbiosis Chip for coordinate study of signal exchange and development in a prokaryote-host interaction. *Proc. Natl. Acad. Sci. USA*, *101*, 16636-16641.
- Bartsev, A. V., Boukli, N. M., Deakin, W. J., Staehelin, C., and Broughton, W. J. (2003). Purification and phosphorylation of the effector protein NopL from *Rhizobium* sp. NGR234. *FEBS Lett.*, *554*, 271-274.
- Bartsev, A. V., Deakin, W. J., Boukli, N. M., McAlvin, C. B., Stacey, G., Malnoë, P., *et al.* (2004). NopL, an effector protein of *Rhizobium* sp. NGR234, thwarts activation of plant defence reactions. *Plant Physiol.*, *134*, 871-879.
- Becker, A., and Pühler, A. (1998). Production of exopolysaccharides. In H. P. Spaink, A. Kondorosi, and P. J. J. Hooykaas (Eds.), *The Rhizobiaceae* (pp. 97-118). Dordrecht, The Netherlands: Kluwer Academic Publishers.
- Bender, G. L., Nayudu, M., Le Strange, K. K., and Rolfe, B. G. (1988). The *nodD1* gene of *Rhizobium* strain NGR234 is a key determinant in the extension of host range to the nonlegume *Parasponia*. *Mol. Plant-Microbe Interact.*, *1*, 259-266.
- Berck, S., Perret, X., Quesada-Vincens, D., Promé, J., Broughton, W. J., and Jabbouri, S. (1999). NoIL of *Rhizobium* sp. strain NGR234 is required for O-acetyltransferase activity. *J. Bacteriol.*, *181*, 957-964.
- Bloemberg, G. V., Lagas, R. M., van Leeuwen, S., Van der Marel, G. A., Van Boom, J. H., Lugtenberg, B. J. J., *et al.* (1995). Substrate-specificity and kinetic-studies of nodulation protein NodL of *Rhizobium leguminosarum*. *Biochemistry*, *34*, 12712-12720.
- Borthakur, D., and Johnston, A. W. B. (1987). Sequence of *psi*, a gene on the symbiotic plasmid of *Rhizobium phaseoli* which inhibits exopolysaccharide synthesis and nodulation and demonstration that its transcription is inhibited by *psr*, another gene on the symbiotic plasmid. *Mol. Gen. Genet.*, *207*, 149-154.
- Broughton, W. J., Jabbouri, S., and Perret, X. (2000). Keys to symbiotic harmony. *J. Bacteriol.*, *182*, 5641-5652.
- Broughton, W. J., Zhang, F., Perret, X., and Staehelin, C. (2003). Signals exchanged between legumes and *Rhizobium*: Agricultural uses and perspectives. *Plant Soil*, *252*, 129-137.
- Broughton, W. J., Hanin, M., Relić, B., Kopcińska, J., Golinowski, W., Şimşek, Ş., *et al.* (2006). Flavonoid-inducible modifications to rhamnan O-antigens are necessary for *Rhizobium* sp. NGR234-legume symbioses. *J. Bacteriol.*, *188*, 3654-3663.
- Burn, J. E., Hamilton, W. D., Wootton, J. C., and Johnston, A. W. B. (1989). Single and multiple mutations affecting properties of the regulatory gene *nodD* of *Rhizobium*. *Mol. Microbiol.*, *3*, 1567-1577.
- Campbell, G. R. O., Reuhs, B. L., and Walker, G. C. (2002). Chronic intracellular infection of alfalfa nodules by *Sinorhizobium meliloti* requires correct lipopolysaccharide core. *Proc. Natl. Acad. Sci. USA*, *99*, 3938-3943.
- Cárdenas, L., Dominguez, J., Santana, O., and Quinto, C. (1996). The role of the *nodI* and *nodJ* genes in the transport of Nod metabolites in *Rhizobium etli*. *Gene*, *173*, 183-187.
- Cárdenas, L., Thomas-Oates, J. E., Nava, N., López-Lara, I. M., Hepler, P. K., and Quinto, C. (2003). The role of Nod factor substituents in actin cytoskeleton rearrangements in *Phaseolus vulgaris*. *Mol. Plant-Microbe Interact.*, *16*, 326-334.
- Carlson, R. W., Sanjuan, J., Bhat, U. R., Glushka, J., Spaink, H. P., Wijffes, A. H., *et al.* (1993). The structures and biological activities of the lipo-oligosaccharide nodulation signals produced by type I and II strains of *Bradyrhizobium japonicum*. *J. Biol. Chem.*, *268*, 18372-18381.
- Catoira, R., Timmers, A. C., Maillet, F., Galera, C., Penmetsa, R. V., Cook, D., *et al.* (2001). The HCL gene of *Medicago truncatula* controls *Rhizobium*-induced root hair curling. *Development*, *128*, 1507-1518.
- Chen, H., Higgins, J., Kondorosi, E., Kondorosi, A., Djordjevic, M. A., Weinman, J. J., *et al.* (2000a). Identification of *noIR*-regulated proteins in *Sinorhizobium meliloti* using proteome analysis. *Electrophoresis*, *21*, 3823-3832.
- Chen, H., Higgins, J., Oresnik, I. J., Hynes, M. F., Natera, S., Djordjevic, M. A., *et al.* (2000b). Proteome analysis demonstrates complex replicon and luteolin interactions in pSymA-cured derivatives of *Sinorhizobium meliloti* strain 2011. *Electrophoresis*, *21*, 3833-3842.
- Choi, H., Kim, S., Mukhopadhyay, P., Cho, S., Woo, J., Storz, G., *et al.* (2001). Structural basis of the redox switch in the OxyR transcription factor. *Cell*, *105*, 103-113.
- Cooper, J. E. (2004). Multiple responses of rhizobia to flavonoids during legume root infection. In J. A. Callow (Ed.), *Advances in botanical research*, Vol. 41 (pp. 1-62). Oxford, UK: Elsevier.

- Cren, M., Kondorosi, A., and Kondorosi, E. (1995). NodR controls expression of the *Rhizobium meliloti* nodulation genes involved in the core Nod factor synthesis. *Mol. Microbiol.*, *15*, 733-747.
- Cullimore, J. V., Ranjeva, R., and Bono, J. J. (2001). Perception of lipo-chitoooligosaccharidic Nod factors in legumes. *Trends Plant Sci.*, *6*, 24-30.
- Dakora, F. D., Joseph, C. M., and Phillips, D. A. (1993a). Common bean root exudates contain elevated levels of daidzein and coumestrol in response to *Rhizobium* inoculation. *Mol. Plant-Microbe Interact.*, *6*, 665-668.
- Dakora, F. D., Joseph, C. M., and Phillips, D. A. (1993b). Alfalfa (*Medicago sativa* L) root exudates contain isoflavonoids in the presence of *Rhizobium meliloti*. *Plant Physiol.*, *101*, 819-824.
- Deakin, W. J., Marie, C., Saad, M. M., Krishnan, H. B., and Broughton, W. J. (2005). NopA is associated with cell surface appendages produced by the type III secretion system of *Rhizobium* sp. strain NGR234. *Mol. Plant-Microbe Interact.*, *18*, 499-507.
- Debellé, F., Plaz Janet, C., Roche, P., Pujol, C., Savagnac, A., Rosenberg, C., et al. (1996). The NodA proteins of *Rhizobium meliloti* and *Rhizobium tropici* specify the N-acylation of Nod factors by different fatty acids. *Mol. Microbiol.*, *22*, 303-314.
- Demont, N., Debellé, F., Aurelle, H., Dénarié, J., and Promé, J. C. (1993). Role of the *Rhizobium meliloti* *nodF* and *nodE* genes in the biosynthesis of lipo-oligosaccharidic nodulation factors. *J. Biol. Chem.*, *268*, 20134-20142.
- Demont, N., Ardourel, M., Maillet, F., Promé, D., Ferro, M., Promé, J.-C., et al. (1994). The *Rhizobium meliloti* regulatory *nodD3* and *syrM* genes control the synthesis of a particular class of nodulation factors N-acylated by (omega-1)-hydroxylated fatty acids. *EMBO J.*, *13*, 2139-2149.
- Dockendorff, T. C., Sharma, A. J., and Stacey, G. (1994). Identification and characterization of the *nolYZ* genes of *Bradyrhizobium japonicum*. *Mol. Plant-Microbe Interact.*, *7*, 173-180.
- Dombrecht, B., Tesfay, M. Z., Verreth, C., Heusdens, C., Nápoles, M. C., Vanderleyden, J., et al. (2002). The *Rhizobium etli* gene *iscN* is highly expressed in bacteroids and required for nitrogen fixation. *Mol. Genet. Genom.*, *267*, 820-828.
- Downie, J. A. (1998). Functions of rhizobial nodulation genes. In H. P. Spaink, A. Kondorosi, and P. J. J. Hooykaas (Eds.), *The Rhizobiaceae* (pp. 387-402). Dordrecht, The Netherlands: Kluwer Academic Publishers.
- Dusha, I. (2002). Nitrogen control of bacterial signal production in *Rhizobium meliloti*-alfalfa symbiosis. *Indian J. Exp. Biol.*, *40*, 981-988.
- Dusha, I., Bakos, A., Kondorosi, A., Debruijn, F. J., and Schell, J. (1989). The *Rhizobium meliloti* early nodulation genes (*nodABC*) are nitrogen regulated - isolation of a mutant strain with efficient nodulation capacity on alfalfa in the presence of ammonium. *Mol. Genet. Genom.*, *219*, 89-96.
- Dusha, I., Austin, S., and Dixon, R. (1999a). The upstream region of the *nodD3* gene of *Sinorhizobium meliloti* carries enhancer sequences for the transcriptional activator NtrC. *FEMS Microbiol. Lett.*, *179*, 491-499.
- Dusha, I., Oláh, B., Szegletes, Z., Erdei, L., and Kondorosi, A. (1999b). *syrM* is involved in the determination of the amount and ratio of the two forms of the acidic exopolysaccharide EPSI in *Rhizobium meliloti*. *Mol. Plant-Microbe Interact.*, *12*, 755-765.
- Engelke, T., Jording, D., Kapp, D., and Pühler, A. (1989). Identification and sequence analysis of the *Rhizobium meliloti* *dctA* gene encoding the C4-dicarboxylate carrier. *J. Bacteriol.*, *171*, 5551-5560.
- Faucher, C., Maillet, F., Vasse, J., Rosenberg, C., van Brussel, A. A., Truchet, G., et al. (1988). *Rhizobium meliloti* host range *nodH* gene determines production of an alfalfa-specific extracellular signal. *J. Bacteriol.*, *170*, 5489-5499.
- Fellay, R., Hanin, M., Montorzi, G., Frey, J., Freiberg, C., Golinowski, W., et al. (1998). *nodD2* of *Rhizobium* sp. NGR234 is involved in the repression of the *nodABC* operon. *Mol. Microbiol.*, *27*, 1039-1050.
- Felle, H. H., Kondorosi, E., Kondorosi, A., and Schultze, M. (1996). Rapid alkalization in alfalfa root hairs in response to rhizobial lipochitoooligosaccharide signals. *Plant J.*, *10*, 295-301.
- Feng, J., Li, Q., Hu, H. L., Chen, X. C., and Hong, G. F. (2003). Inactivation of the *nod* box distal half-site allows tetrameric NodD to activate *nodA* transcription in an inducer-independent manner. *Nucleic Acids Res.*, *31*, 3143-3156.
- Ferguson, G. P., Roop, R. M., and Walker, G. C. (2002). Deficiency of a *Sinorhizobium meliloti* *bacA* mutant in alfalfa symbiosis correlates with alteration of cell envelope. *J. Bacteriol.*, *184*, 5625-5632.

- Firmin, J. L., Wilson, K. E., Carlson, R. W., Davies, A. E., and Downie, J. A. (1993). Resistance to nodulation of cv. Afghanistan peas is overcome by *nodX*, which mediates an *O*-acetylation of the *Rhizobium leguminosarum* lipo-oligosaccharide nodulation factor. *Mol. Microbiol.*, *10*, 351-360.
- Fisher, R. F., and Long, S. R. (1993). Interactions of NodD at the *nod* box: NodD binds to two distinct sites on the same face of the helix and induces a bend in the DNA. *J. Mol. Biol.*, *233*, 336-348.
- Frayse, N., Jabbouri, S., Treilhou, M., Couderc, F., and Poinso, V. (2002). Symbiotic conditions induce structural modifications of *Sinorhizobium* sp. NGR234 surface polysaccharides. *Glycobiology*, *12*, 741-748.
- Freiberg, C., Fellay, R., Bairoch, A., Broughton, W. J., Rosenthal, A., and Perret, X. (1997). Molecular basis of symbiosis between *Rhizobium* and legumes. *Nature*, *387*, 394-401.
- Gage, D. J., and Long, S. R. (1998). α -Galactoside uptake in *Rhizobium meliloti*: Isolation and characterization of *aggA*, a gene encoding a periplasmic binding protein required for melibiose and raffinose utilization. *J. Bacteriol.*, *180*, 5739-5748.
- Galbraith, M. P., Feng, S. F., Borneman, J., Triplett, E. W., de Bruijn, F. J., and Rossbach, S. (1998). A functional *myo*-inositol catabolism pathway is essential for rhizopine utilization by *Sinorhizobium meliloti*. *Microbiology*, *144*, 2915-2924.
- Galibert, F., Finan, T. M., Long, S. R., Pühler, A., Abola, P., Ampe, F., et al. (2001). The composite genome of the legume symbiont *Sinorhizobium meliloti*. *Science*, *293*, 668-672.
- Garcia, M., Dunlap, J., Loh, J., and Stacey, G. (1996). Phenotypic characterization and regulation of the *nolA* gene of *Bradyrhizobium japonicum*. *Mol. Plant-Microbe Interact.*, *9*, 625-635.
- Geiger, O., Glushka, J., Lugtenberg, B. J. J., Spaink, H. P., and Thomas-Oates, J. E. (1998). NodFE-dependent fatty acids that lack an alpha-beta unsaturation are subject to differential transfer, leading to novel phospholipids. *Mol. Plant-Microbe Interact.*, *11*, 33-44.
- Geremia, R. A., Mergaert, P., Geelen, D., Van Montagu, M., and Holsters, M. (1994). The NodC protein of *Azorhizobium caulinodans* is an N-acetylglucosaminyltransferase. *Proc. Natl. Acad. Sci. USA*, *91*, 2669-2673.
- Geurts, R., Heidstra, R., Hadri, A. E., Downie, J. A., Franssen, H., Van Kammen, A., et al. (1997). Sym2 of pea is involved in a nodulation factor-perception mechanism that controls the infection process in the epidermis. *Plant Physiol.*, *115*, 351-359.
- Geurts, R., and Bisseling, T. (2002). Rhizobium Nod factor perception and signalling. *Plant Cell*, *14*, Suppl: S239-249.
- Goethals, K., Van Montagu, M., and Holsters, M. (1992). Conserved motifs in a divergent *nod* box of *Azorhizobium caulinodans* ORS571 reveal a common structure in promoters regulated by LysR-type proteins. *Proc. Natl. Acad. Sci. USA*, *89*, 1646-1650.
- Gómez-Gómez, L., and Boller, T. (2002). Flagellin perception: A paradigm for innate immunity. *Trends Plant Sci.*, *7*, 251-256.
- Goormachtig, S., Lievens, S., Van de Velde, W., Van Montagu, M., and Holsters, M. (1998). Srchi13, a novel early nodulin from *Sesbania rostrata*, is related to acidic class III chitinases. *Plant Cell*, *10*, 905-916.
- Göttfert, M., Gross, P., and Hennecke, H. (1990). Proposed regulatory pathway encoded by the *nodV* and *nodW* genes, determinants of host specificity in *Bradyrhizobium japonicum*. *Proc. Natl. Acad. Sci. USA*, *87*, 2680-2684.
- Göttfert, M., Holzhauser, D., Bani, D., and Hennecke, H. (1992). Structural and functional analysis of two different *nodD* genes in *Bradyrhizobium japonicum* USDA110. *Mol. Plant-Microbe Interact.*, *5*, 257-265.
- Göttfert, M., Röthlisberger, S., Kündig, C., Beck, C., Marty, R., and Hennecke, H. (2001). Potential symbiosis-specific genes uncovered by sequencing a 410-kilobase DNA region of the *Bradyrhizobium japonicum* chromosome. *J. Bacteriol.*, *183*, 1405-1412.
- Guerreiro, N., Redmond, J. W., Rolfe, B. G., and Djordjevic, M. A. (1997). New *Rhizobium leguminosarum* flavonoid-induced proteins revealed by proteome analysis of differentially displayed proteins. *Mol. Plant-Microbe Interact.*, *10*, 506-516.
- Guerreiro, N., Djordjevic, M. A., and Rolfe, B. G. (1999). Proteome analysis of the model microsymbiont *Sinorhizobium meliloti*: Isolation and characterisation of novel proteins. *Electrophoresis*, *20*, 818-825.
- Hanin, M., Jabbouri, S., Quesada-Vincens, D., Freiberg, C., Perret, X., Promé, J.-C., et al. (1997). Sulphation of *Rhizobium* sp. NGR234 Nod factors is dependent on *noeE*, a new host-specificity gene. *Mol. Microbiol.*, *24*, 1119-1129.

- Hartwig, U. A., Maxwell, C. A., Joseph, C. M., and Phillips, D. A. (1989). Interactions among flavonoid *nod* gene inducers released from alfalfa seeds and roots. *Plant Physiol.*, *91*, 1138-1142.
- Hartwig, U. A., and Phillips, D. A. (1991). Release and modification of *nod*-gene-inducing flavonoids from alfalfa seeds. *Plant Physiol.*, *95*, 804-807.
- Hayashi, F., Smith, K. D., Ozinsky, A., Hawn, T. R., Yi, E. C., Goodlett, D. R., *et al.* (2001). The innate immune response to bacterial flagellin is mediated by Toll-like receptor 5. *Nature*, *410*, 1099-1103.
- Hogg, B., Davies, A. E., Wilson, K. E., Bisseling, T., and Downie, J. A. (2002). Competitive nodulation blocking of cv. Afghanistan pea is related to high levels of nodulation factors made by some strains of *Rhizobium leguminosarum* bv. *viciae*. *Mol. Plant-Microbe Interact.*, *15*, 60-68.
- Honma, M. A., Asomaning, M., and Ausubel, F. M. (1990). *Rhizobium meliloti nodD* genes mediate host-specific activation of *nodABC*. *J. Bacteriol.*, *172*, 901-911.
- Hu, H., Liu, S., Yang, Y., Chang, W., and Hong, G. (2000). In *Rhizobium leguminosarum*, NodD represses its own transcription by competing with RNA polymerase for binding sites. *Nucleic Acids Res.*, *28*, 2784-2793.
- Hubber, A., Vergunst, A. C., Sullivan, J. T., Hooykaas, P. J. J., and Ronson, C. W. (2004). Symbiotic phenotypes and translocated effector proteins of the *Mesorhizobium loti* strain R7A VirB/D4 type IV secretion system. *Mol. Microbiol.*, *54*, 561-574.
- Hueck, C. J. (1998). Type III protein secretion systems in bacterial pathogens of animals and plants. *Microbiol. Mol. Biol. Rev.*, *62*, 379-433.
- Irving, H. I., Boukli, N. M., Kelly, M. N., and Broughton, W. J. (2000). Nod-factors in symbiotic development of root-hairs. In R.W. Ridge and A. M. Emons (Eds.) *Root hairs: Cell and molecular biology* (pp. 241-265). Tokyo, Japan: Springer-Verlag.
- Jabbouri, S., Fellay, R., Talmont, F., Kamalaprija, P., Burger, U., Relić, B., *et al.* (1995). Involvement of *nodS* in N-methylation and *nodU* in 6-O-carbamoylation of *Rhizobium* sp. NGR234 Nod factors. *J. Biol. Chem.*, *270*, 22968-22973.
- Jabbouri, S., Hanin, M., Fellay, R., Quesada-Vincens, D., Reuhs, B., Carlson, R. W., *et al.* (1996). *Rhizobium* species NGR234 host-specificity of nodulation locus III contains *nod* and *fix* genes. In G. Stacey, B. Mullin and P. M. Gresshoff (Eds.) *Biology of plant-microbe interactions, Vol. 1* (pp. 319-324). St Paul, MN: Society for Molecular Plant-Microbe Interactions.
- Jabbouri, S., Relić, B., Hanin, M., Kamalaprija, P., Burger, U., Promé, D., *et al.* (1998). *nolO* and *noel* (HsnIII) of *Rhizobium* sp. NGR234 are involved in 3-O-carbamoylation and 2-O-methylation of Nod factors. *J. Biol. Chem.*, *273*, 12047-12055.
- Jebanathirajah, J. A., Peri, S., and Pandey, A. (2002). Toll and interleukin-1 receptor (TIR) domain-containing proteins in plants: A genomic perspective. *Trends Plant Sci.*, *7*, 388-391.
- Jiang, G., Krishnan, A. H., Kim, Y. W., Wacek, T. J., and Krishnan, H. B. (2001). A functional myo-inositol dehydrogenase gene is required for efficient nitrogen fixation and competitiveness of *Sinorhizobium fredii* USDA191 to nodulate soybean (*Glycine max* [L.] Merr.). *J. Bacteriol.*, *183*, 2595-2604.
- John, M., Röhrig, H., Schmidt, J., Wieneke, U., and Schell, J. (1993). *Rhizobium* NodB protein involved in nodulation signal synthesis is a chitooligosaccharide deacetylase. *Proc. Natl. Acad. Sci. USA*, *90*, 625-629.
- Jording, D., and Pühler, A. (1993). The membrane topology of the *Rhizobium meliloti* C₄-dicarboxylate permease (DctA) as derived from protein fusions with *Escherichia coli* K12 alkaline phosphatase (PhoA) and β-galactosidase (LacZ). *Mol. Gen. Genet.*, *241*, 106-114.
- Jourlin-Castelli, C., Mani, N., Nakano, M. M., and Sonenshein, A. L. (2000). CcpC, a novel regulator of the LysR family required for glucose repression of the *citB* gene in *Bacillus subtilis*. *J. Mol. Biol.*, *295*, 865-878.
- Kalogeraki, V. S., and Winans, S. C. (1998). Wound-released chemical signals may elicit multiple responses from an *Agrobacterium tumefaciens* strain containing an octopine-type Ti plasmid. *J. Bacteriol.*, *180*, 5660-5667.
- Kamst, E., Pilling, J., Raamsdonk, L. M., Lugtenberg, B. J., and Spalink, H. P. (1997). *Rhizobium* nodulation protein NodC is an important determinant of chitin oligosaccharide chain length in Nod factor biosynthesis. *J. Bacteriol.*, *179*, 2103-2108.
- Kaneko, T., Nakamura, Y., Sato, S., Asamizu, E., Kato, T., Sasamoto, S., *et al.* (2000). Complete genome structure of the nitrogen-fixing symbiotic bacterium *Mesorhizobium loti*. *DNA Res.*, *7*, 331-338.

- Kaneko, T., Nakamura, Y., Sato, S., Minamisawa, K., Uchiumi, T., Sasamoto, S., *et al.* (2002). Complete genomic sequence of nitrogen-fixing symbiotic bacterium *Bradyrhizobium japonicum* USDA110. *DNA Res.*, *9*, 189-197.
- Kannenberg, E. L., and Brewin, N. J. (1989). Expression of a cell surface antigen from *Rhizobium leguminosarum* 3841 is regulated by oxygen and pH. *J. Bacteriol.*, *171*, 4543-4548.
- Kannenberg, E. L., Perzl, M., and Hartner, T. (1995). The occurrence of hopanoid lipids in *Bradyrhizobium* bacteria. *FEMS Microbiol. Lett.*, *127*, 255-261.
- Kannenberg, E. L., and Carlson, R. W. (2001). Lipid A and O-chain modifications cause *Rhizobium* lipopolysaccharides to become hydrophobic during bacteroid development. *Mol. Microbiol.*, *39*, 379-391.
- Kiss, E., Mergaert, P., Oláh, B., Kereszt, A., Staehelin, C., Davies, A. E., *et al.* (1998). Conservation of *nolR* in the *Sinorhizobium* and *Rhizobium* genera of the *Rhizobiaceae* family. *Mol. Plant-Microbe Interact.*, *11*, 1186-1195.
- Knight, C. D., Rossen, L., Robertson, J. G., Wells, B., and Downie, J. A. (1986). Nodulation inhibition by *Rhizobium leguminosarum* multicopy *nodABC* genes and analysis of early stages of plant infection. *J. Bacteriol.*, *166*, 552-558.
- Kobayashi, H., Naciri-Graven, Y., Broughton, W. J., and Perret, X. (2004). Flavonoids induce temporal shifts in gene-expression of *nod*-box controlled loci in *Rhizobium* sp. NGR234. *Mol. Microbiol.*, *51*, 335-347.
- Kondorosi, E., Gyuris, J., Schmidt, J., John, M., Duda, E., Hoffmann, B., *et al.* (1989). Positive and negative control of *nod* gene expression in *Rhizobium meliloti* is required for optimal nodulation. *EMBO J.*, *8*, 1331-1340.
- Kondorosi, E., Buire, M., Cren, M., Iyer, N., Hoffmann, B., and Kondorosi, A. (1991a). Involvement of the *sydM* and *nodD3* genes of *Rhizobium meliloti* in *nod* gene activation and in optimal nodulation of the plant host. *Mol. Microbiol.*, *5*, 3035-3048.
- Kondorosi, E., Pierre, M., Cren, M., Haumann, U., Buire, M., Hoffmann, B., *et al.* (1991b). Identification of *NolR*, a negative *trans*-acting factor controlling the *nod* regulon in *Rhizobium meliloti*. *J. Mol. Biol.*, *222*, 885-896.
- Krause, A., Doerfel, A., and Göttfert, M. (2002). Mutational and transcriptional analysis of the type III secretion system of *Bradyrhizobium japonicum*. *Mol. Plant-Microbe Interact.*, *15*, 1228-1235.
- Krishnan, H. B. (2002). *NolX* of *Sinorhizobium fredii* USDA257, a type III-secreted protein involved in host range determination, is localized in the infection threads of cowpea (*Vigna unguiculata* L. Walp) and soybean (*Glycine max* L. Merr.) nodules. *J. Bacteriol.*, *184*, 831-839.
- Krishnan, H. B., Lorio, J., Kim, W. S., Jiang, G. Q., Kim, K. Y., DeBoer, M., and Pueppke, S. G. (2003). Extracellular proteins involved in soybean cultivar specific nodulation are associated with pilus-like surface appendages and exported by a type III protein secretion system in *Sinorhizobium fredii* USDA257. *Mol. Plant-Microbe Interact.*, *16*, 617-625.
- Lerouge, P., Roche, P., Faucher, C., Maillet, F., Truchet, G., Promé, J.-C., *et al.* (1990). Symbiotic host-specificity of *Rhizobium meliloti* is determined by a sulphated and acylated glucosamine oligosaccharide signal. *Nature*, *344*, 781-784.
- Le Strange, K. K., Bender, G. L., Djordjevic, M. A., Rolfe, B. G., and Redmond, J. W. (1990). The *Rhizobium* strain NGR234 *nodD1* gene-product responds to activation by the simple phenolic-compounds vanillin and isovanillin present in wheat seedling extracts. *Mol. Plant-Microbe Interact.*, *3*, 214-220.
- Lochowska, A., Iwanicka-Nowicka, R., Zaim, J., Witkowska-Zimny, M., Bolewska, K., and Hryniewicz, M. M. (2004). Identification of activating region (AR) of *Escherichia coli* LysR-type transcriptional factor CysB and CysB contact site on RNA polymerase alpha subunit at the *cysP* promoter. *Mol. Microbiol.*, *53*, 791-806.
- Loh, J., Garcia, M., and Stacey, G. (1997). *NodV* and *NodW*, a second flavonoid recognition system regulating *nod* gene expression in *Bradyrhizobium japonicum*. *J. Bacteriol.*, *179*, 3013-3020.
- Loh, J., Stacey, M. G., Sadowsky, M. J., and Stacey, G. (1999). The *Bradyrhizobium japonicum nolA* gene encodes three functionally distinct proteins. *J. Bacteriol.*, *181*, 1544-1554.
- Loh, J. T., and Stacey, G. (2001). Feedback regulation of the *Bradyrhizobium japonicum* nodulation genes. *Mol. Microbiol.*, *41*, 1357-1364.
- Loh, J., and Stacey, G. (2003). Nodulation gene regulation in *Bradyrhizobium japonicum*: A unique integration of global regulatory circuits. *Appl. Environ. Microbiol.*, *69*, 10-17.

- Loh, J. T., Yuen-Tsai, J. P., Stacey, M. G., Lohar, D., Welborn, A., and Stacey, G. (2001). Population density-dependent regulation of the *Bradyrhizobium japonicum* nodulation genes. *Mol. Microbiol.*, *42*, 37-46.
- Loh, J., Lohar, D. P., Andersen, B., and Stacey, G. (2002a). A two-component regulator mediates population-density-dependent expression of the *Bradyrhizobium japonicum* nodulation genes. *J. Bacteriol.*, *184*, 1759-1766.
- Loh, J., Carlson, R. W., York, W. S., and Stacey, G. (2002b). Bradyoxetin, a unique chemical signal involved in symbiotic gene regulation. *Proc. Natl. Acad. Sci. USA*, *99*, 14446-14451.
- López-Lara, I. M., Blok-Tip, L., Quinto, C., Garcia, M. L., Stacey, G., Bloemberg, G. V., et al. (1996). NodZ of *Bradyrhizobium* extends the nodulation host range of *Rhizobium* by adding a fucosyl residue to nodulation signals. *Mol. Microbiol.*, *21*, 397-408.
- López-Lara, I. M., Kafetzopoulos, D., Spaink, H. P., and Thomas-Oates, J. E. (2001). Rhizobial NodL O-acetyl transferase and NodS N-methyl transferase functionally interfere in production of modified Nod factors. *J. Bacteriol.*, *183*, 3408-3416.
- Maillet, F., Debelle, F., and Dénarié, J. (1990). Role of the *nodD* and *syrM* genes in the activation of the regulatory gene *nodD3*, and of the common and host-specific nod genes of *Rhizobium meliloti*. *Mol. Microbiol.*, *4*, 1975-1984.
- Marie, C., Barny, M. A., and Downie, J. A. (1992). *Rhizobium leguminosarum* has two glucosamine synthases, GImS and NodM, required for nodulation and development of nitrogen-fixing nodules. *Mol. Microbiol.*, *6*, 843-851.
- Marie, C., Plaskitt, K. A., and Downie, J. A. (1994). Abnormal bacteroid development in nodules induced by a glucosamine synthase mutant of *Rhizobium leguminosarum*. *Mol. Plant-Microbe Interact.*, *7*, 482-487.
- Marie, C., Broughton, W. J., and Deakin, W. J. (2001). *Rhizobium* type III secretion systems: Legume charmers or alarmers? *Curr. Opin. Plant Biol.*, *4*, 336-342.
- Marie, C., Deakin, W. J., Viprey, V., Kopcinska, J., Golinowski, W., Krishnan, H. B., et al. (2003). Characterization of Nops, nodulation outer proteins, secreted via the type III secretion system of NGR234. *Mol. Plant-Microbe Interact.*, *16*, 743-751.
- Marie, C., Deakin, W. J., Ojanen-Reuhs, T., Diallo, E., Reuhs, B., Broughton, W. J., et al. (2004). TtsI, a key regulator of *Rhizobium* species NGR234 is required for type III-dependent protein secretion and synthesis of rhamnose-rich polysaccharides. *Mol. Plant-Microbe Interact.*, *17*, 958-966.
- McIver, J., Djordjevic, M. A., Weinman, J. J., Bender, G. L., and Rolfe, B. G. (1989). Extension of host range of *Rhizobium leguminosarum* bv. *trifolii* caused by point mutations in *nodD* that result in alterations in regulatory function and recognition of inducer molecules. *Mol. Plant-Microbe Interact.*, *2*, 97-106.
- Mergaert, P., D'Haese, W., Geelen, D., Promé, D., Van Montagu, M., Geremia, R., et al. (1995). Biosynthesis of *Azorhizobium caulinodans* Nod Factors - study of the activity of the *NodABC*S proteins by expression of the genes in *Escherichia coli*. *J. Biol. Chem.*, *270*, 29217-29223.
- Merrick, M. J., and Edwards R. A. (1995) Nitrogen control in bacteria. *Microbiol. Rev.*, *59*, 604-622.
- Michiels, J., Pelemans, H., Vlassak, K., Verreth, C., and Vanderleyden, J. (1995). Identification and characterization of a *Rhizobium leguminosarum* *phaseoli* gene that is important for nodulation competitiveness and shows structural homology to a *Rhizobium fredii* host-inducible gene. *Mol. Plant-Microbe Interact.*, *8*, 468-472.
- Mimmack, M. L., Borthakur, D., Jones, M. A., Downie, J. A., and Johnston, A. W. (1994). The *psi* operon of *Rhizobium leguminosarum* biovar *phaseoli*: Identification of two genes whose products are located at the bacterial cell surface. *Microbiology*, *140*, 1223-1229.
- Mulligan, J. T., and Long, S. R. (1989). A family of activator genes regulates expression of *Rhizobium meliloti* nodulation genes. *Genetics*, *122*, 7-18.
- Muraoka, S., Okumura, R., Ogawa, N., Nonaka, T., Miyashita, K., and Senda, T. (2003). Crystal structure of a full-length LysR-type transcriptional regulator, CbnR: Unusual combination of two subunit forms and molecular bases for causing and changing DNA bend. *J. Mol. Biol.*, *328*, 555-566.
- Niehaus, K., Kapp, D., and Pühler, A. (1993). Plant defense and delayed infection of alfalfa pseudonodules induced by an exopolysaccharide (EPS-I) deficient *Rhizobium meliloti* mutant. *Planta*, *190*, 415-425.
- Niwa, S., Kawaguchi, M., Imaizumi-Anraku, H., Chechetka, S. A., Ishizaka, M., Ikuta, A., et al. (2001). Responses of a model legume *Lotus japonicus* to lipochitin oligosaccharide nodulation factors purified from *Mesorhizobium loti* JRL501. *Mol. Plant-Microbe Interact.*, *14*, 848-856.

- Ogawa, N., McFall, S. M., Klem, T. J., Miyashita, K., and Chakrabarty, A. M. (1999). Transcriptional activation of the chlorocatechol degradative genes of *Ralstonia eutropha* NH9. *J. Bacteriol.*, *181*, 6697-6705.
- Okker, R. J., Spaink, H. P., Lugtenberg, B. J., and Schlaman, H. R. (2001). Mutants in the *nodFEL* promoter of *Rhizobium leguminosarum* bv. *viciae* reveal a role of individual nucleotides in transcriptional activation and protein binding. *Arch. Microbiol.*, *175*, 152-160.
- Oláh, B., Kiss, E., Györgypál, Z., Borzi, J., Cinege, G., Csanádi, G., et al. (2001). Mutation in the *ntrR* gene, a member of the *vap* gene family, increases the symbiotic efficiency of *Sinorhizobium meliloti*. *Mol. Plant-Microbe Interact.*, *14*, 887-894.
- Oldroyd, G. E. D., Mitra, R. M., Wais, R. J., and Long, S. R. (2001). Evidence for structurally specific negative feedback in the Nod factor signal transduction pathway. *Plant J.*, *28*, 191-199.
- Ovtsyna, A. O., Geurts, R., Bisseling, T., Lugtenberg, B. J. J., Tikhonovich, I. A., and Spaink, H. P. (1998). Restriction of host range by the *sym2* allele of Afghan pea is nonspecific for the type of modification at the reducing terminus of nodulation signals. *Mol. Plant-Microbe Interact.*, *11*, 418-422.
- Parniske, M., Schmidt, P. E., Kosch, K., and Müller, P. (1994). Plant defense responses of host plants with determinate nodules induced by EPS-defective *exoB* mutants of *Bradyrhizobium japonicum*. *Mol. Plant-Microbe Interact.*, *7*, 631-638.
- Pellock, B. J., Cheng, H. P., and Walker, G. C. (2000). Alfalfa root nodule invasion efficiency is dependent on *Sinorhizobium meliloti* polysaccharides. *J. Bacteriol.*, *182*, 4310-4318.
- Perotto, S., Brewin, N. J., and Kannenberg, E. L. (1994). Cytological evidence for a host-defense response that reduces cell and tissue invasion in pea nodules by lipopolysaccharide-defective mutants of *Rhizobium leguminosarum* strain 3841. *Mol. Plant-Microbe Interact.*, *7*, 99-112.
- Perret, X., Freiberg, C., Rosenthal, A., Broughton, W. J., and Fellay, R. (1999). High-resolution transcriptional analysis of the symbiotic plasmid of *Rhizobium* sp. NGR234. *Mol. Microbiol.*, *32*, 415-425.
- Perret, X., Staehelin, C., and Broughton, W. J. (2000). Molecular basis of symbiotic promiscuity. *Microbiol. Mol. Biol. Rev.*, *64*, 180-201.
- Perzl, M., Muller, P., Poralla, K., and Kannenberg, E. L. (1997). Squalene-hopene cyclase from *Bradyrhizobium japonicum*: Cloning, expression, sequence analysis and comparison to other triterpenoid cyclases. *Microbiology*, *143*, 1235-1242.
- Perzl, M., Reipen, I. G., Schmitz, S., Poralla, K., Sahm, H., Sprenger, G. A., et al. (1998). Cloning of conserved genes from *Zymomonas mobilis* and *Bradyrhizobium japonicum* that function in the biosynthesis of hopanoid lipids. *Biochim. Biophys. Acta*, *1393*, 108-118.
- Pueppke, S. G., and Broughton, W. J. (1999). *Rhizobium* sp. strain NGR234 and *R. fredii* USDA257 share exceptionally broad, nested host ranges. *Mol. Plant-Microbe Interact.*, *12*, 293-318.
- Quesada-Vincens, D., Fellay, R., Nasim, T., Viprey, V., Burger, U., Promé, J.-C., et al. (1997). *Rhizobium* sp. strain NGR234 NodZ protein is a fucosyltransferase. *J. Bacteriol.*, *179*, 5087-5093.
- Quesada-Vincens, D., Hanin, M., Broughton, W. J., and Jabbouri, S. (1998). *In vitro* sulfotransferase activity of NoeE, a nodulation protein of *Rhizobium* sp. NGR234. *Mol. Plant-Microbe Interact.*, *11*, 592-600.
- Recourt, K., van Brussel, A. A., Driessen, A. J., and Lugtenberg, B. J. (1989). Accumulation of a *nod* gene inducer, the flavonoid naringenin, in the cytoplasmic membrane of *Rhizobium leguminosarum* biovar *viciae* is caused by the pH-dependent hydrophobicity of naringenin. *J. Bacteriol.*, *171*, 4370-4377.
- Relić, B., Talmont, F., Kopcinska, J., Golinowski, W., Promé, J.-C., and Broughton, W. J. (1993a). Biological-activity of *Rhizobium* sp NGR234 Nod-factors on *Macroptilium atropurpureum*. *Mol. Plant-Microbe Interact.*, *6*, 764-774.
- Relić, B., Fellay, R., Lewin, A., Perret, X., Price, N. P. J., Rochepeau, P., and Broughton, W. J. (1993b). *Nod* genes and Nod factors of *Rhizobium* species NGR234. In R. Palacios, J. Mora and W. E. Newton (Eds.) *New horizons in nitrogen fixation* (pp. 183-189). Dordrecht, The Netherlands: Kluwer Academic Publishers.
- Relić, B., Perret, X., Estrada-Garcia, M. T., Kopcinska, J., Golinowski, W., Krishnan, H. B., et al. (1994a). Nod factors of *Rhizobium* are a key to the legume door. *Mol. Microbiol.*, *13*, 171-178.
- Relić, B., Staehelin, C., Fellay, R., Jabbouri, S., Boller, T., and Broughton, W. J. 1994. Do Nod-factor levels play a role in host-specificity? In G. B. Kiss and G. Endre (Eds.) *Proceedings of the first European nitrogen fixation conference* (pp. 69 -75). Szeged, Hungary: Officina Press.

- Reuhs, B. L., Kim, J. S., Badgett, A., and Carlson, R. W. (1994). Production of cell-associated polysaccharides of *Rhizobium fredii* USDA205 is modulated by apigenin and host root extract. *Mol. Plant-Microbe Interact.*, *7*, 240-247.
- Reuhs, B. L., Relić, B., Forsberg, L. S., Marie, C., Ojanen-Reuhs, T., Stephens, S. B., *et al.* (2005). Structural characterization of flavonoid-inducible *Pseudomonas aeruginosa* A-band-like O antigen of *Rhizobium* sp. strain NGR234, required for the formation of nitrogen-fixing nodules. *J. Bacteriol.*, *187*, 6479-6487.
- Ritsema, T., Wijffjes, A. H. M., Lugtenberg, B. J. J., and Spaink, H. P. (1996). *Rhizobium* nodulation protein NodA is a host-specific determinant of the transfer of fatty acids in Nod factor biosynthesis. *Mol. Gen. Genet.*, *251*, 44-51.
- Rivilla, R., Sutton, J. M., and Downie, J. A. (1995). *Rhizobium leguminosarum* NodT is related to a family of outer-membrane transport proteins that includes TolC, PrtF, CyaE and AprF. *Gene*, *161*, 27-31.
- Roche, P., Debelle, F., Maillet, F., Lerouge, P., Faucher, C., Truchet, G., *et al.* (1991). Molecular basis of symbiotic host specificity in *Rhizobium meliloti*: *nodH* and *nodPQ* genes encode the sulfation of lipo-oligosaccharide signals. *Cell*, *67*, 1131-1143.
- Roche, P., Maillet, F., Plaz Janet, C., Debelle, F., Ferro, M., Truchet, G., *et al.* (1996). The common *nodABC* genes of *Rhizobium meliloti* are host-range determinants. *Proc. Natl. Acad. Sci USA*, *93*, 15305-15310.
- Röhrig, H., Schmidt, J., Wieneke, U., Kondorosi, E., Barlier, I., Schell, J., *et al.* (1994). Biosynthesis of lipooligosaccharide nodulation factors: *Rhizobium* NodA protein is involved in N-acylation of the chitoooligosaccharide backbone. *Proc. Natl. Acad. Sci. USA*, *91*, 3122-3126.
- Rossbach, S., Kulpa, D. A., Rossbach, U., and de Bruijn, F. J. (1994). Molecular and genetic characterization of the rhizopine catabolism (*mocABRC*) genes of *Rhizobium meliloti* L5-30. *Mol. Gen. Genet.*, *245*, 11-24.
- Saad, M. M., Kobayashi, H., Marie, C., Brown, I. R., Mansfield, J. W., Broughton, W. J., *et al.* (2005). NopB, a Type III secreted protein of *Rhizobium* sp. NGR234 is associated with pilus-like surface appendages. *J. Bacteriol.*, *187*, 1173-1181.
- Saier, Jr., M. H., Tam, R., Reizer, A., and Reizer, J. (1994). Two novel families of bacterial membrane proteins concerned with nodulation, cell division and transport. *Mol. Microbiol.*, *11*, 841-847.
- Sanjuan, J., Carlson, R. W., Spaink, H. P., Bhat, U. R., Barbour, W. M., Glushka, J., *et al.* (1992). A 2-O-methylfucose moiety is present in the lipo-oligosaccharide nodulation signal of *Bradyrhizobium japonicum*. *Proc. Natl. Acad. Sci. USA*, *89*, 8789-8793.
- Schell, M. A. (1993). Molecular biology of the LysR family of transcriptional regulators. *Annu. Rev. Microbiol.*, *47*, 597-626.
- Schlaman, H. R. M., Phillips, D. A., and Kondorosi, E. (1998). Genetic organization and transcriptional regulation of rhizobial nodulation genes. In H. P. Spaink, A. Kondorosi, and P. J. J. Hooykaas (Eds.) *The Rhizobiaceae* (pp. 361-386). Dordrecht, The Netherlands: Kluwer Academic Publishers.
- Schmidt, P. E., Broughton, W. J., and Werner, D. (1994). Nod factors of *Bradyrhizobium japonicum* and *Rhizobium* sp NGR234 induce flavonoid accumulation in soybean root exudate. *Mol. Plant-Microbe Interact.*, *7*, 384-390.
- Schultze, M., Quiclet-Sire, B., Kondorosi, E., Virelizier, H., Glushka, J. N., Endre, G., *et al.* (1992). *Rhizobium meliloti* produces a family of sulfated lipooligosaccharides exhibiting different degrees of plant host specificity. *Proc. Natl. Acad. Sci. USA*, *89*, 192-196.
- Schultze, M., Staehelin, C., Röhrig, H., John, M., Schmidt, J., Kondorosi, E., *et al.* (1995). *In vitro* sulfotransferase activity of *Rhizobium meliloti* NodH protein: Lipochitoooligosaccharide nodulation signals are sulfated after synthesis of the core structure. *Proc. Natl. Acad. Sci. USA*, *92*, 2706-2709.
- Schwedock, J. S., Liu, C., Leyh, T. S., and Long, S. R. (1994). *Rhizobium meliloti* NodP and NodQ form multifunctional sulfate-activating complex requiring GTP for activity. *J. Bacteriol.*, *176*, 7055-7064.
- Smit, G., Puvanesarajah, V., Carlson, R. W., Barbour, W. M., and Stacey, G. (1992). *Bradyrhizobium japonicum nodD1* can be specifically induced by soybean flavonoids that do not induce the *nodYABCULJ* operon. *J. Biol. Chem.*, *267*, 310-318.
- Smith, L. S., and Long, S. R. (1998). Requirements for *syrM* and *nodD* genes in the nodulation of *Medicago truncatula* by *Rhizobium meliloti* 1021. *Mol. Plant-Microbe Interact.*, *11*, 937-940.
- Spaink, H. P., Okker, R. J. H., Wijffelman, C. A., Pees, E., and Lugtenberg, B. J. J. (1987a). Promoters in the nodulation region of the *Rhizobium leguminosarum* Sym plasmid pRL1J1. *Plant Mol. Biol.*, *9*, 27-39.

- Spaink, H. P., Wijffelman, C. A., Pees, E., Okker, R. J. H., and Lugtenberg, B. J. J. (1987b). *Rhizobium* nodulation gene *nodD* as a determinant of host specificity. *Nature*, *328*, 337-340.
- Spaink, H. P., Wijffjes, A. H., van der Drift, K. M., Haverkamp, J., Thomas-Oates, J. E., and Lugtenberg, B. J. (1994). Structural identification of metabolites produced by the NodB and NodC proteins of *Rhizobium leguminosarum*. *Mol. Microbiol.*, *13*, 821-831.
- Spaink, H. P., Wijffjes, A. H., and Lugtenberg, B. J. (1995). *Rhizobium* NodI and NodJ proteins play a role in the efficiency of secretion of lipochitin oligosaccharides. *J. Bacteriol.*, *177*, 6276-6281.
- Stacey, G., Luka, S., Sanjuan, J., Banfalvi, Z., Nieuwkoop, A. J., Chun, J. Y., et al. (1994). *nodZ*, a unique host-specific nodulation gene, is involved in the fucosylation of the lipooligosaccharide nodulation signal of *Bradyrhizobium japonicum*. *J. Bacteriol.*, *176*, 620-633.
- Staehelin, C., Schultze, M., Kondorosi, E., Mellor, R. B., Boller, T., and Kondorosi, A. (1994). Structural modifications in *Rhizobium meliloti* Nod factors influence their stability against hydrolysis by root chitinases. *Plant J.*, *5*, 319-330.
- Staehelin, C., Schultze, M., Kondorosi, E., and Kondorosi, A. (1995). Lipo-chitooligosaccharide nodulation signals from *Rhizobium meliloti* induce their rapid degradation by the host plant alfalfa. *Plant Physiol.*, *108*, 1607-1614.
- Sullivan, J. T., Trzebiatowski, J. R., Cruickshank, R. W., Gouzy, J., Brown, S. D., Elliot, R. M., et al. (2002). Comparative sequence analysis of the symbiosis island of *Mesorhizobium loti* strain R7A. *J. Bacteriol.*, *184*, 3086-3095.
- Swanson, J. A., Mulligan, J. T., and Long, S. R. (1993). Regulation of *syrM* and *nodD3* in *Rhizobium meliloti*. *Genetics*, *134*, 435-444.
- Takeda, K., Kaisho, T., and Akira, S. (2003). Toll-like receptors. *Ann. Rev. Immunol.*, *21*, 335-376.
- Theunis, M., Kobayashi, H., Broughton, W. J., and Prinsen, E. (2004). Flavonoids, NodD1, NodD2 and *nod*-box NB15 modulate expression of the *y4wEFG* locus that is required for indole-3-acetic acid synthesis in *Rhizobium* sp. NGR234. *Mol. Plant-Microbe Interact.*, *17*, 1153-1161.
- Trinick, M. J. (1980). Relationships amongst the fast-growing rhizobia of *Lablab purpureus*, *Leucaena leucocephala*, *Mimosa* spp, *Acacia farnesiana* and *Sesbania grandiflora* and their affinities with other rhizobial groups. *J. Appl. Bacteriol.*, *49*, 39-53.
- Tyrrell, R., Verschuere, K. H. G., Dodson, E. J., Murshudov, G. N., Addy, C., and Wilkinson, A. J. (1997). The structure of the cofactor-binding fragment of the LysR family member, CysB: A familiar fold with a surprising subunit arrangement. *Structure*, *5*, 1017-1032.
- Vance, C. P. (1998). Legume symbiotic nitrogen fixation: Agronomic aspects. In H. P. Spaink, A. Kondorosi, and P. J. J. Hooykaas (Eds.), *The Rhizobiaceae* (pp. 509-530). Dordrecht, The Netherlands: Kluwer Academic Publishers.
- Van Rhijn, P., and Vanderleyden, J. (1995). The *Rhizobium*-plant symbiosis. *Microbiol. Rev.*, *59*, 124-142.
- Vinardell, J. M., Lopez-Baena, F. J., Hidalgo, A., Ollero, F. J., Bellogin, R., del Rosario Espuny, M., et al. (2004). The effect of FITA mutations on the symbiotic properties of *Sinorhizobium fredii* varies in a chromosomal-background-dependent manner. *Arch. Microbiol.*, *181*, 144-154.
- Viprey, V., Del Greco, A., Golinowski, W., Broughton, W. J., and Perret, X. (1998). Symbiotic implications of type III protein secretion machinery in *Rhizobium*. *Mol. Microbiol.*, *28*, 1381-1389.
- Wais, R. J., Keating, D. H., and Long, S. R. (2002). Structure-function analysis of Nod factor-induced root hair calcium spiking in *Rhizobium*-legume symbiosis. *Plant Physiol.*, *129*, 211-224.
- Walker, S. A., and Downie, J. A. (2000). Entry of *Rhizobium leguminosarum* bv. *viciae* into root hairs requires minimal Nod factor specificity, but subsequent infection thread growth requires *nodO* or *nodE*. *Mol. Plant-Microbe Interact.*, *13*, 754-762.
- Wang, S. P., and Stacey, G. (1991). Studies of the *Bradyrhizobium japonicum* *nodD1* promoter: A repeated structure for the *nod* box. *J. Bacteriol.*, *173*, 3356-3365.
- Xiao, H., Shen, S. J., and Zhu, J. B. (1998). Binding of activator SyrM to the site of *nodD3* P1 region of *Rhizobium meliloti*. *Sci. China (Series C)*, *41*, 157-162.
- Xie, Z. P., Staehelin, C., Wiemken, A., Broughton, W. J., Müller, J., and Boller, T. (1999). Symbiosis-stimulated chitinase isoenzymes of soybean (*Glycine max* (L.) Merr.). *J. Exp. Bot.*, *50*, 327-333.
- Yao, S. Y., Luo, L., Har, K. J., Becker, A., Rüberg, S., Yu, G. Q., Zhu, J. B., and Cheng, H. P. (2004). *Sinorhizobium meliloti* ExoR and ExoS proteins regulate both succinoglycan and flagellum production. *J. Bacteriol.*, *186*, 6042-6049.

Chapter 6

CELL BIOLOGY OF NODULE INFECTION AND DEVELOPMENT

N. MAUNOURY, A. KONDOROSI, E. KONDOROSI,
AND P. MERGAERT

*Institut des Sciences du Végétal,
Centre National de la Recherche Scientifique
91198 Gif-sur-Yvette, France*

1. INTRODUCTION

The symbiosis between legumes and nodule-forming soil bacteria is fascinating for ecological, agricultural, evolutionary, physiological, and developmental reasons. The symbiosis culminates in the formation of a highly organized plant organ, the root nodule, with plant cells invaded by bacteria. The N₂-fixing root nodule is thereby a paradigm for plant developmental processes and plant-microbe interactions. The nodule creates a micro-aerobic niche for N₂ fixation, protecting the bacterial nitrogenase from inactivation by O₂. Under favorable conditions and with limited soil nitrogen, the root system may carry hundreds of nodules with infected cells packed with thousands of N₂-fixing bacteria. Although N₂ fixation benefits the host plant, it is very unusual that an organism can tolerate the constant presence of microbes and at such a high concentration. This review focuses on two aspects of the symbiosis, namely, organ formation and plant cell infection.

1.1. Model Legumes

In the past, the symbiosis with rhizobia has been analysed in many different papilionoid legumes, such as *Pisum sativum* (pea), *Vicia sativa* (vetch), *Medicago*

sativa (alfalfa), *Medicago truncatula*, *Glycine max* (soybean), *Phaseolus vulgaris* (bean), *Sesbania rostrata*, and *Lotus japonicus*. However, the advent of the genomic and post-genomic eras in legume research has forced the scientific community to choose two preferred symbiotic models (*M. truncatula-Sinorhizobium meliloti* and *L. japonicus-Mesorhizobium loti*) as reference systems for the two major nodule types (indeterminate and determinate) (Vandenbosch and Stacey, 2003). The symbiotic functions of the two bacteria are well characterized and genomic sequences available for both (Kaneko *et al.*, 2000; Galibert *et al.*, 2001). Here, we discuss predominantly the formation of indeterminate nodules, but refer also to determinate nodules, when it is appropriate. During nodule formation in both *Medicago* and *Lotus*, the bacteria penetrate *via* root hairs, but infection in other plants involves other strategies (see Chapter 1 of this volume).

1.2. Nodule Development in Brief: Major Distinctions between Indeterminate and Determinate Nodule Types

The establishment of the N₂-fixing symbiosis is the result of three major events: (i) intracellular infection of the host cells by the microsymbiont; (ii) nodule organogenesis; and (iii) the N₂-fixation process. The first two occur simultaneously, whereas N₂ fixation occurs after nodule organogenesis is complete and only if bacterial infection is successful.

A molecular dialogue between the symbiotic partners initiates the symbiosis. Specific flavonoids, exuded by the legume roots, are perceived by rhizobia in the rhizosphere *via* their putative receptors, the NodD proteins, which are the transcriptional activators of the nodulation operons (*nod*, *nol*, or *noe* genes). The nodulation genes code for enzymes involved in the synthesis of bacterial lipo-chitooligosaccharide signal molecules, named Nod factors. Each rhizobial species possesses its own set of the nodulation genes, five of which (*nodABCIIJ*) are common for all. NodABC synthesize the lipo-chitooligosaccharide backbone, whereas NodIJ are involved in their secretion. This backbone is further decorated by strain-specific chemical modifications of the host-specific nodulation gene products. Host plants have specific receptors for the Nod factors of their compatible symbiotic partners, a molecular key-lock system fundamental to the host-specificity of the legume-*Rhizobium* symbiosis (for reviews, see Broughton *et al.*, 2000; Dénarié *et al.*, 1996; Downie, 1998; Long, 1996; Mergaert *et al.*, 1997; Schultze and Kondorosi, 1995; Spaink, 1994; and Chapter 5 of this volume).

The recognition of Nod factors by plant receptors opens the door for infection. This involves the formation of tubular infection threads, which guide the rhizobia inside the plant tissues. At the same time, Nod factors activate the cortical cells opposite the site of infection, leading to their dedifferentiation and division, and the formation of the nodule primordium. Depending upon the host plant, the primordium originates either in the inner cortex (for indeterminate nodules) or outer/middle cortex (for determinate nodules). When the growing infection threads reach the primordium cells, bacteria are released into their cytoplasm. These

intracellular bacteria are referred to as “bacteroids”. The infected plant cells stop dividing but instead start to differentiate, in conjunction with their microsymbiont, into N₂-fixing symbiotic cells.

In indeterminate nodules, the cell division activity is maintained in the distal region of the primordium, which generates an apical meristem active throughout the lifetime of the nodule and of constant size. Production of new meristematic cells is compensated by exit of the same number of cells from the cell-division cycle. As the infection threads proliferate below the meristem and enter these post-mitotic cells, the infection process and differentiation of symbiotic cells occur permanently in the apical nodule region. To maintain the indeterminacy, a strict balance is, therefore, required between the division rate in the meristem and the infection rate in the post-mitotic cells. The differentiation of the infected cells leads to a continuous renewal of the pool of N₂-fixing cells. At the same time, older fixing cells lose activity and senesce. The growth of the indeterminate nodule results from the constant increase in cell number and to the enlargement of infected cells. The indeterminate nodules are elongated and contain different central tissues (zones) (Figure 1). These are: (i) a distal, apical meristem (zone I); (ii) a zone of infection and differentiation (zone II); (iii) a region of plant cells filled with N₂-fixing bacteroids (zone III); and (iv) in older nodules, a senescence zone (zone IV), proximal to the root, where host organelles and bacteroids are degraded. The central tissues are surrounded by a cortex, which contains the nodule vasculature connected to the root stele.

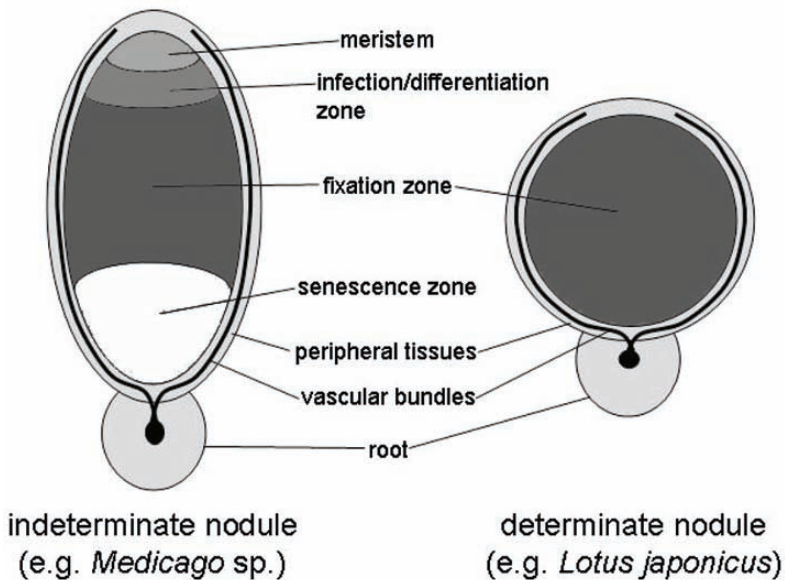

Figure 1. Architecture of indeterminate and determinate nodules.

The scenario for determinate nodules is quite different. In the nodule primordium, all cell division ceases rapidly and no meristem is formed; the cell number in young and old nodules is unchanged. In the infected cells, bacteria divide repeatedly and host cells enlarge to host them. N_2 fixation begins synchronously in all infected cells, before cell enlargement is complete. Growth of determinate nodules is mainly dependent on the enlargement of the infected cells. When nodule differentiation is terminated, growth ceases, leading to spherical nodules containing a single, homogeneous central N_2 -fixation zone (Figure 1). As there is no renewal of N_2 -fixing cells, N_2 fixation is transient; the life of the nodule ending with senescence radiating outwards from the centre of the nodule. Plant cells disintegrate, but bacteroids largely survive the process.

2. NOD FACTOR SIGNALLING

2.1. *Nod Factors Hijack the Root Hair Tip-growth Mechanisms*

The presence of compatible rhizobia on the root hair provokes various host plant responses, most of which can also be elicited by purified Nod factors from the microsymbiont.

Root hairs along the axis of the root can be divided into three categories with distinct growth and cyto-architectural features (Miller *et al.*, 1997). The hairs closest to the meristem are growing cells (Figure 2A). Growth of root hairs takes place exclusively at the tip, and is known as “tip” or “polar” growth, a particular growth style shared with pollen tubes and trichomes. Growth is achieved by highly polarized exocytosis of Golgi-vesicles. Guiding of Golgi-vesicles tip-wards from the Golgi bodies results from cytoplasmic streaming and requires longitudinal actin filaments. Insertion of the vesicle membrane into the plasma membrane is Ca^{2+} -dependent and a tip-localized Ca^{2+} gradient promotes tip growth. The vesicle content is incorporated into the existing cell wall. Cell enlargement is concomitant with newly inserted cell-wall material and increased turgor pressure. Further from the meristem, growth of root-hair cells is declining, in conjunction with the disappearance of the Ca^{2+} gradient at the tip (Figure 2B). Above this zone, the root carries fully-grown root hairs.

Only growth-terminating root hairs respond to rhizobia or Nod factors by curling or deformation (Esseling *et al.*, 2004; Heidstra *et al.*, 1997). Attachment of rhizobia close to the tip provokes a change in the direction of root-hair growth, so that the root hair curls around the rhizobia to form a closed pocket, the so-called “shepherd’s crook”, which entraps the rhizobial microcolony. An infection thread filled with rhizobia originates from this pocket and grows toward the shank of the root hair. Arriving at the base of the root hair, the infection threads ramify and pass into the underlying cortical cells, thus transporting the rhizobia to the root cortex. Infection-thread passage from one cell to another involves local cell-wall degradation, fusion of the thread with the cell wall and initiation of a new invagination, and thread growth in the adjacent cell (van Spronsen *et al.*, 1994).

Adaptation of the tip-growth mechanism appears to be the most straightforward model for *Rhizobium*-induced root-hair curling and infection-thread growth.

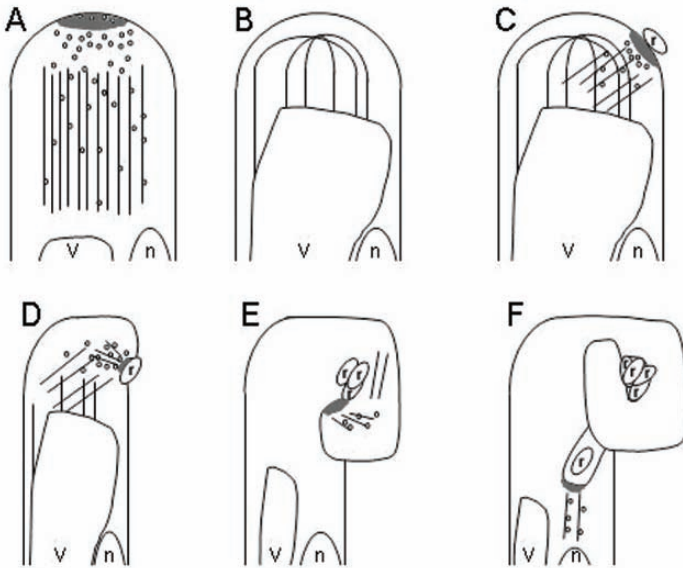

Figure 2. Hijacking of root hair growth by infecting rhizobia.

Only the apical part of root hairs is shown.

A. Growing root hair with a strong apical Ca^{2+} -gradient.

B. Root hair that has finished growth, has a dissipated Ca^{2+} -gradient, and is susceptible to infection by rhizobia.

C-F. Different stages of root hair curling and infection thread formation, induced by rhizobia that create a new Ca^{2+} -gradient in their vicinity.

Rhizobia are ovals labelled by "r"; vacuoles and nuclei are marked by "V" and "n", respectively; Golgi vesicles (small circles) travel on actin cables (lines) towards the Ca^{2+} -gradient (grey shading) either at the tip of the growing cell (A) or induced by rhizobia (C-F).

The Nod factors are locally immobilized in the cell wall (Goedhart *et al.*, 2000). Recognition of Nod factors depends on LysM-type receptor-like kinases (Limpens *et al.*, 2003; Madsen *et al.*, 2003; Radutoiu *et al.*, 2003; see Chapter 6 of this volume) and results in activation of plasma membrane-localized Ca^{2+} -channels, thereby increasing the cytosolic Ca^{2+} concentration at the plasma membrane in the vicinity of the bacterial microcolony (Cárdenas *et al.*, 1999; de Ruijter *et al.*, 1998; Felle *et al.*, 1998; 1999; Shaw and Long, 2003). The cytoskeleton is induced as well, with the appearance of new actin cables (de Ruijter *et al.*, 1999; Miller *et al.*, 1999) and the restoration of a microtubular network between the nucleus and the site of increased Ca^{2+} concentration (Timmers *et al.*, 1999). This creates a new

centre of tip growth, whose axis deviates from the original straight root hair-growth axis toward the site of the microcolony (Figure 2C). Hair curling around the Nod factor-producing microcolony continues until the colony is entirely enveloped (Figure 2C-F). This effect of Nod factors could thus be paraphrased as stimulating local exocytosis.

Growing root hairs may not respond under most experimental conditions because they may have a Ca^{2+} gradient stronger than the relatively weak Ca^{2+} -influx provoked by the Nod factor-producing rhizobia. The rhizobia trapped in the curl probably continue to multiply while producing Nod factors and thus promoting exocytosis. The growing microcolony exerts a pressure which, at some stage, exceeds the cell turgor. The plasma membrane, expanding by exocytosis, will be pushed inward into the root hair and the infection thread initiated. Also important for the creation of this “push” mechanism are bacterial exopolysaccharides (Pellock *et al.*, 2000) and the secretion by the root hair of a matrix of glycoproteins that become cross-linked and insolubilized (Brewin, 2004). Infection-thread formation may, therefore, be a “simple” continuation of the Nod factor-induced tip growth that has reversed its growth direction because of the pressure exerted by the caged rhizobia.

Several observations suggest that infection-thread growth is indeed related to root-hair, trichome, or pollen-tube growth (see below), but careful analysis of certain mutants indicates that this view may be simplistic. A *nodFnodL* double mutant of *S. meliloti* produces altered Nod factors lacking an acetyl modification on the non-reducing end of the molecule and with the typical poly-unsaturated fatty acid replaced by a household fatty acid. Although this mutant induces true shepherd’s crooks entrapping rhizobia, the formation of infection threads from the rhizobial microcolony is markedly affected (Ardourel *et al.*, 1994; Catoira *et al.*, 2001), showing that root-hair curling can be uncoupled from infection-thread initiation. This may be explained in either of two ways. The first is that two distinct Nod factor-recognition systems exist for the two responses; the system for curling being less specific for the Nod-factor structure than a highly stringent recognition system for infection-thread initiation (Ardourel *et al.*, 1994; Catoira *et al.*, 2001). The LysM-type receptor-like kinases are encoded by a small gene family (Limpens *et al.*, 2003; Madsen *et al.*, 2003; Radutoiu *et al.*, 2003) and the members may be modular, forming heterodimers. Such heterodimers with different Nod-factor specificities may act at different stages of root-hair curling, infection-thread initiation, and infection-thread growth. In the second scenario, both responses rely on the same recognition system, but the required strength of the response is greater for infection-thread initiation than for root-hair curling. Wild-type and mutant Nod factors may bind with different affinities, which could affect the strength of the response they induce.

Rhizobial microcolonies attach at multiple sites along the shank of the root hair, but only microcolonies positioned at the dome, just below the tip of the hair, can dictate the position of the future curl. This indicates that a recognition complex (sometimes referred as an “infection organizer” or “proper infection site”) exists to

translate these positional cues (Catoira *et al.*, 2001; Esseling *et al.*, 2003; van Batenburg *et al.*, 1986). This recognition complex picks up signals of both the microcolonies and plant. Nod factors induce root-hair deformations but no true curls, suggesting that bacterial factors other than the Nod factors are also involved in the infection (Catoira *et al.*, 2001). However, the finding that spot application of Nod factors at the side of the apical dome of a root hair was sufficient to form a partial shepherd's crook suggests that nothing other than Nod factors and positional information are needed for the infection (Esseling *et al.*, 2003). A mutant of *M. truncatula* defective in the *hcl* gene was unable to form infection threads and nodules, but displayed an increased root-hair response to rhizobia or Nod factors, with multiple deformations and continuous curling but no entrapment of rhizobia. Consequently, it was proposed that this mutant was impaired in the putative "infection organizer" (Catoira *et al.*, 2001).

Because Nod factors induce new tip growth in root hairs, they and the recognition complex must recruit the molecular machinery that coordinates tip growth. Central in the machinery for tip growth in plants are small G-proteins belonging to the ROP family (Yang, 2002). ROPs promote the tip-localized Ca^{2+} gradient *via* a phospholipase C and a NADPH oxidase/ H_2O_2 -dependent pathway (Foreman *et al.*, 2003; Kost *et al.*, 1999). Experimental evidence indeed suggests the involvement of phospholipase C and H_2O_2 in Nod-factor signalling (den Hartog *et al.*, 2001; Ramu *et al.*, 2002). ROPs also regulate actin cytoskeleton dynamics and microtubular organisation (Chen *et al.*, 2003; Fu *et al.*, 2005), which are also affected by Nod factors in root hairs (de Ruijter *et al.*, 1999; Miller *et al.*, 1999; Timmers *et al.*, 1999). ROPs are known to be effectors of receptor-like kinases (Berken *et al.*, 2005). Therefore, it is likely that the Nod factor-receptor complex (the LysM receptor-like kinases) contains ROP proteins that relay the Nod-factor signal to the actin cytoskeleton and to Ca^{2+} -channels.

2.2. The "DMI" Nod-factor Signal-transduction Pathway

The Nod-factor signal-transduction pathway, downstream of the LysM-receptor complex, splits into two branches; one leading to modified root hair-tip growth (see above) and the other to gene expression and cell division (Esseling *et al.*, 2004; Shaw and Long, 2003). Coordination of these pathways permits the infection process and nodule-primordium initiation. Genetic, pharmacological, and physiological studies have identified several players acting on the second pathway. DMI2, identified as NORK or SYMRK, is another receptor-like kinase, which functions downstream of the Nod factor-receptor complex. The ligand for this receptor is unknown. Activation of both the Nod-factor receptor and the NORK receptor leads to the activation of putative ion channels (known as DMI1, POLLUX and CASTOR), which are needed for the release of Ca^{2+} -ions from internal stores. The Ca^{2+} -fluxes take the form of spikes (alternating peaks and valleys of Ca^{2+} -concentrations) in the perinucleus and the nucleus. Ca^{2+} -spiking is then interpreted by a Calcium/Calmodulin-dependent protein kinase (CCaMK) in the nucleus

(known as DMI3). Activated CCaMK stimulates transcription factors of the GRAS family of plant-specific transcription factors (known as NSP1 and NSP2), leading to gene transcription. For more details on this “DMI” pathway, see Chapter 7 of this volume.

3. CORTICAL CELL ACTIVATION LEADING TO PRIMORDIUM FORMATION AND INFECTION

3.1. From Cell-cycle Activation to Nodule Primordium

Nod factors activate, *via* the DMI-pathway, the cells in the pericycle and cortex opposite the site of infection and in front of protoxylem poles (Timmers *et al.*, 1999; Truchet *et al.*, 1990; Van Brussel *et al.*, 1992; Yang *et al.*, 1994). The response starts in the pericycle and then expands outward into cortical cells (Timmers *et al.*, 1999). In the activated cells, the nucleus moves to the centre by rearrangement of the microtubular cytoskeleton in arrays radiating around the nucleus, resulting in apparently isodiametric cells (Timmers *et al.*, 1999). A Nod factor-induced annexin, *MtAnn1*, may be a component or regulator of this rearranged cytoskeleton (de Carvalho-Niebel *et al.*, 2002).

These activated cells re-enter the cell cycle. The mitotic cycle in eukaryotes consists of four phases, G1, S, G2, and M (Figure 3). During S phase, the genome is replicated, the M phase leads to mitosis and cytokinesis, whereas the gap phases, G1 and G2, prepare the cells for the G1/S and G2/M transitions, respectively. Non-dividing plant cells can be in a resting phase G0, either in G1 or in G2. Cell-cycle progression is coordinated by the ordered action of cyclin-dependent kinases (CDKs), whose regulatory subunits are phase-specific cyclins that regulate the activity and substrate specificity of the CDKs.

The Nod factor-activated cortical-root cells are in the G0 phase (Savouré *et al.*, 1994; Yang *et al.*, 1994). To study cell-cycle activation, the expression of cyclin genes was followed during nodule initiation in *Medicago* (Foucher and Kondorosi, 2000). The *cycA2* cyclin gene is the first known cell-cycle gene that is activated by Nod factors and implicated in cell-cycle reactivation and formation of organ meristems (Roudier *et al.*, 2003). A-type cyclins are generally involved in M-phase entry, but this cyclin also functions in late G1 and is likely required for G0/G1-S entry (Roudier *et al.*, 2000). In the Nod factor-sensitive root zone, the *cycA2* gene is weakly expressed in phloem cells, but in response to auxin or Nod factors its expression shifts from the phloem to cells located in front of the protoxylem poles (Roudier *et al.*, 2003). In line with this response, the *cycA2* promoter contains auxin-responsive elements, which in response to auxin activate transcription of *cycA2* (Roudier *et al.*, 2003). This suggests that an auxin maximum and expression of *cycA2* are required in front of the protoxylem poles for initiation of nodule and lateral root organogenesis. The CycA2 activities are, however, insufficient to drive the M-phase, additional B-type cyclins being required for mitosis and cytokinesis. In roots inoculated with rhizobia, the B-type cyclins are activated in the inner

cortical cells (Yang *et al.*, 1994); the cell cycle can only be completed in the inner root cortex in front of the protoxylem poles (Figure 3). Cell proliferation originating from these cells leads to formation of the nodule primordium in *Medicago*.

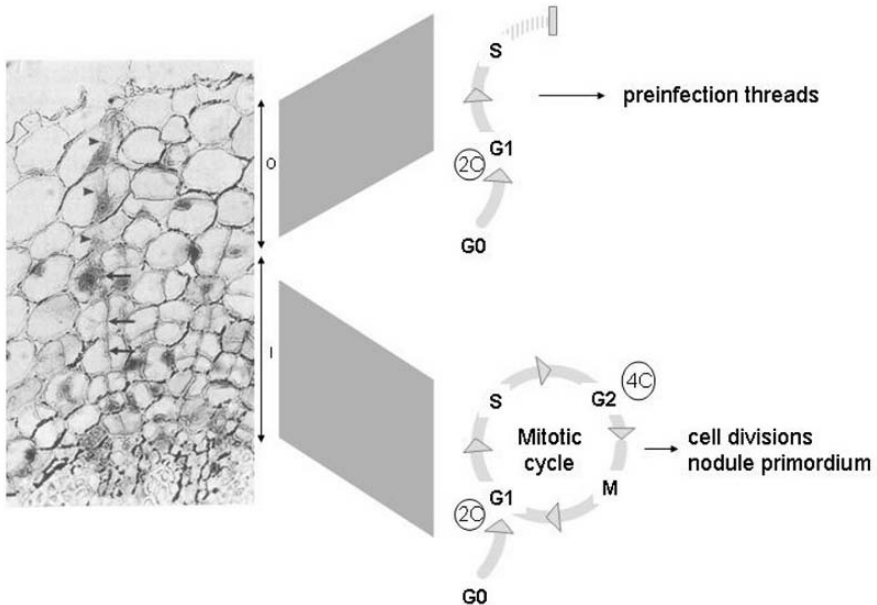

Figure 3. Nod factor-induced cell activation in the root cortex.

Inner cortical cells (I, arrows) execute complete mitotic cycles and divide. Outer cortical cells (O, arrowheads) enter the cell cycle but do not complete it and, therefore, do not divide but instead form preinfection threads. Micrograph from Van Brussel *et al.* (1992).

3.2. Preinfection Thread Structures are Derived from the Cell Cycle

In response to Nod factors, the cell cycle is also activated in the outer cortical cells, which express cell-cycle genes, such as *CDK* or histone *H4*, which is an S-phase marker (Yang *et al.*, 1994). The activated outer cortical cells form the so-called “preinfection threads” preceding the passage of the infection threads (Timmers *et al.*, 1999; Van Brussel *et al.*, 1992; see Figure 3). A preinfection thread consists of an anticlinal-oriented cytoplasmic bridge joining the outer and the inner sides of the cell, and containing parallel arrays of microtubules, similar to the phragmosome formed during cell division. This differentiation process, together with the activation of the histone *H4* and *CDK* cell-cycle genes, indicates that the infection and cell-division processes are related (Timmers *et al.*, 1999; Van Brussel *et al.*, 1992; Yang *et al.*, 1994).

3.3. Infection-thread Growth

When an infection thread passes through the preinfection thread, the microtubules connect the tip of the infection thread to the nucleus. The role of the microtubular cytoskeleton in the infection process thus seems analogous to its function in other tip-growth processes in root hairs or pollen tubes (Timmers *et al.*, 1999). Moreover, in the absence of rhizobia, cells carrying preinfection threads induced by pure Nod factors develop quickly into “cortical” root hairs (Van Brussel *et al.*, 1992). The *crinkle* mutant in *L. japonicus* is affected in infection-thread growth as well as the development of root hairs, trichomes, and pollen tubes (Tansengco *et al.*, 2003, 2004). Symbiosis-specific polygalacturonase and pectin methylesterase genes involved in infection-thread formation seem to have evolved from pollen-specific genes involved in polar tip growth in pollen tubes (Rodriguez-Llorente *et al.*, 2004). Infection-thread growth, therefore, seems based on the same molecular mechanisms as those acting in polar cells. How far can this correlation be drawn? Both systems could share the tip-localized Ca^{2+} -gradient, similar actin cytoskeleton, ROS production, and regulation by ROPs, but there are basic differences. Infection-thread growth is inverted (against cell turgor pressure) and the cell machinery for growth (Golgi apparatus, cytoskeleton, *etc.*) is outside the growing infection thread but inside in root hairs, pollen tubes or trichomes.

The infection thread has a topology analogous to an incipient cell plate. Plasma membrane is external, with the pectin and cellulose cell wall juxtaposed. The interior is an extracellular matrix of different, plant-derived, (hydroxy)proline-rich glycoproteins (HRGPs) in which the rhizobia, sheathed by exopolysaccharides (EPS), are embedded (Brewin, 2004). These HRGPs include the nodulins (proteins whose synthesis is specifically upregulated during nodule organogenesis) ENOD11, ENOD12, ENOD16, ENOD20, and ENOD5. It is remarkable that many of the known nodulins are HRGPs, illustrating their importance (Brewin, 2004).

For *S. meliloti*, different kinds of EPS - succinoglycan (EPS I), EPS II, and K-antigen (KPS) - are important for sustained infection-thread extension. These display redundancy in their function but differ in efficiency (Pellock *et al.*, 2000). Infection threads grow at a rate of *ca.* 10 $\mu\text{m}\cdot\text{h}^{-1}$ (Gage, 2002). Matrix glycoprotein in the older parts of infection threads hardens by peroxide-induced cross-linking, but remains fluid in the tip (about 60 μm) of the threads (Brewin, 2004). Rhizobia are entrapped in the solid matrix, but divide actively in the fluid matrix at the tip that contains about 100-200 bacterial cells (Gage, 2002).

The preinfection threads are aligned in the different cell layers of the outer cortex, connecting the infection site and the incipient primordium. The path for the infection threads is, thus, charted across the root cortex through the aligned preinfection threads. Infection-thread growth stops at a primordium cell, which has isodiametric cytology and has not developed a preinfection thread. This may be the signal for the endocytotic release of the bacteria from the infection threads into the cytoplasm of the cell and the start of bacterial and plant cell differentiation to N_2 -fixing status (see below).

4. SECONDARY SIGNALS FOR NOD FACTOR-INDUCED CELL ACTIVATION

Nod factors also have an effect at a distance in the root pericycle and cortex, where cell divisions and expression of specific genes are induced. A Nod-factor signal must, therefore, be transmitted from the epidermis to the inner-root cell layers early in the interaction. This signal is unlikely to be the Nod factor itself, but rather a mobile secondary signal because Nod factors are rapidly immobilized in the cell wall (Goedhart *et al.*, 2000).

Auxins and cytokinins are the major mitogenic signals that control the cell cycle and cell proliferation in plant development (Stals and Inzé, 2001). Cytokinins and auxins activate *CDK* genes, both transcriptionally and post-transcriptionally (Zhang *et al.*, 1996). Transcriptional analysis of particular cell-cycle genes and global-transcriptome profiling reveal that cytokinins and auxins activate the transcription of several other key cell-cycle regulators (Himanen *et al.*, 2004; Rashotte *et al.*, 2003; Roudier *et al.*, 2003; Soni *et al.*, 1995). Plant hormones are, thus, good candidates for secondary signaling in nodule formation.

4.1. Auxin and Flavonoids: *Arabidopsis* as a Paradigm

Most of the signal-transduction pathways linking auxin with cellular responses have been established in *Arabidopsis*. The ARF and Aux/IAA protein families are the major transcriptional regulators in auxin-modulated gene expression. The auxin signal is perceived by the ubiquitin ligase SCF^{TIR1} and transduced to the transcriptional regulators *via* the SCF ubiquitin proteolytic pathway that controls the stability of the regulators according to auxin levels (Dharmasiri and Estelle, 2004; Dharmasiri *et al.*, 2005; Kepinski and Leyser, 2002; 2005). How the appropriate responses are activated by the auxin maxima in the diverse developmental programs remains unclear.

In *Arabidopsis*, auxin accumulation is intimately associated with the spatial organisation of different cell types in embryogenesis and in the development of all post-embryonic organs (Friml, 2003; Swarup and Bennett, 2003). Asymmetric distribution of auxin has been observed at the onset of organogenesis in all developmental processes studied, with high concentrations in certain cell types and lower concentrations in neighbouring cells. Disturbing the auxin maxima or gradients by pharmacological or genetic means leads to disturbance of normal development. Auxin is synthesized in young apical tissues and is distributed through the plant by both a non-polar transport system in phloem and an active cell-to-cell directional or polar transport. Polar auxin transport depends on specific auxin influx (AUX/LAX) and efflux (PINs) carriers, which have a polarized cellular localization on opposing sites of the cell. Upon perception of developmental stimuli, the subcellular position of the auxin influx and efflux carriers is modified so that they form a network in the incipient organ, so directing the auxin flux towards a maximum (Bhalerao and Bennett, 2003; Friml, 2003; Swarup and Bennett, 2003).

Flavonoids may also regulate auxin flux; they can inhibit binding of synthetic auxin-transport inhibitors (Jacobs and Rubery, 1988) and can mimic *in vivo* the growth effects induced by synthetic auxin-transport inhibitors. Mutations in a gene encoding chalcone synthase (the first enzyme in flavonoid biosynthesis) in *Arabidopsis* cause an increased polar auxin transport and developmental defects consistent with an altered auxin distribution (Brown *et al.*, 2001; Buer and Muday, 2004).

4.2. Auxin and Flavonoids in Nodule Development

The general rule that auxin maxima control plant organogenesis holds also for nodule development. After Nod-factor perception during rhizobial infection at the root hair, auxin is redistributed very rapidly in the cortex opposite the site of infection (Boot *et al.*, 1999; Mathesius *et al.*, 1998a; Pacios-Bras *et al.*, 2003). At the site of inoculation in white clover (which forms indeterminate nodules), auxin accumulates first in all cortical and vascular cells but, between the inoculation site and the root tip, auxin accumulation is reduced whereas it is increased basipetally from the inoculation site (Mathesius *et al.*, 1998a). This pattern indicates the induction of root acropetal auxin-transport inhibition by the Nod factors. Then, auxin accumulates in the inner cortex and pericycle opposite the infection site and protoxylem poles, where cells divide. Thus, the first events involve a non-specific retention of auxin, which is then redirected and concentrated in the nodule progenitor cells. Later, when differentiation starts in the primordium, auxin accumulates at the flanks of the meristem but is absent in the centre of the primordium. This bifurcated pattern is maintained in the growing nodule (Mathesius *et al.*, 1998a).

During initiation of determinate nodules, the auxin maximum occurs in the middle cortex (Pacios-Bras *et al.*, 2003). The location of the auxin maximum, thus, coincides with the division centres at the origin of the nodule primordia in the different nodule types and may be the determinant for the first divisions. In addition, a gradient with declining auxin concentrations in the cells next to the maximum may be important for specification of the other cell types in a nodule primordium (*e.g.*, preinfection thread-forming cells and vascular cells).

The auxin redistribution induced by rhizobia at the infection site may be mediated by flavonoids (Mathesius *et al.*, 1998a; 1998b), whose synthesis is induced after infection (indicated by chalcone-synthase expression and detection of flavonoids in the inner and outer cortical cells) (Mathesius *et al.*, 1998b; 2000). A synthetic auxin-transport inhibitor, Nod factors, and flavonoids all induce a similar acropetal inhibition of auxin transport in white clover roots (Mathesius *et al.*, 1998a).

The contribution of a network of PIN and AUX/LAX auxin carriers to the creation of an auxin maximum during nodule initiation remains less clear. Nevertheless, the *M. truncatula* orthologs of the *LAX* genes are expressed in nodule primordia and, later on, in the developing vasculature (de Billy *et al.*, 2001). The

M. truncatula PIN genes have been isolated recently, enabling study of their role during nodulation (Schnabel and Frugoli, 2004). Finally, identification of the auxin signal-transduction factors, such as the ARF and Aux/IAA transcriptional regulators operating in the nodule primordium, may lead to a better understanding of the role of auxin in nodule development.

4.3. Cytokinins

Indirect evidence exists for an important role for cytokinins in nodule initiation. Application of cytokinins to legume roots induces expression of early nodulin genes and cortical-cell divisions in a way similar to addition of pure Nod factors (Bauer *et al.*, 1996; Dehio and de Bruijn, 1992; Fang and Hirsch, 1998; Mathesius *et al.*, 2000). Cytokinin production by expression of the *Agrobacterium* isopentenyl-transferase (*ipt*) gene in a Nod⁻ *Rhizobium* mutant deficient in Nod-factor synthesis induced nodule-like structures on alfalfa (Cooper and Long, 1994). Transgenic *L. japonicus* plants, expressing a *GUS* marker under the control of a cytokinin-responsive promoter, rapidly accumulate cytokinins after rhizobial infection in curling root hairs and later, in dividing cortical cells and the nodule primordium (Lohar *et al.*, 2004). Finally, decreased cytokinin levels in transgenic *L. japonicus* plants expressing a cytokinin-oxidase gene significantly reduced the number of nodules formed (Lohar *et al.*, 2004).

The cytokinin signal is transduced in plants *via* a eukaryotic version of the bacterial two-component signal-transduction paradigm. Cytokinin receptors are histidine kinases and the hormone signal is transduced *via* a phospho-transfer mechanism, which involves phosphor-relay proteins named AHPs, to response regulators (ARRs) that transcriptionally control the expression of cytokinin-responsive genes (Kakimoto, 2003). Cytokinin signal-transduction proteins may also operate during nodule formation and exert essential functions for proper organ formation.

4.4. Ethylene

Depending on nodule type and infection mode, ethylene affects nodulation in dissimilar ways, either as a negative regulator, having no influence, or being essential. For indeterminate nodules, ethylene is generally a negative regulator (Heidstra *et al.*, 1997; Penmetsa and Cook, 1997; Peters and Crist-Estes, 1989; Zaat *et al.*, 1989). Sensitivity to ethylene in determinate nodule formation is variable. Nodulation of soybean and bean is indifferent to ethylene, whereas nodulation of *L. japonicus* is inhibited as in the case of indeterminate nodule formation (Nukui *et al.*, 2004; Schmidt *et al.*, 1999; Suganuma *et al.*, 1995; van Spronsen *et al.*, 2001). Rhizobial infection and nodulation of the subtropical aquatic legume *Sesbania rostrata* requires ethylene (D'haeze *et al.*, 2003). The role of ethylene in nodulation has been reviewed (Guinel and Geil, 2002).

The number of nodules formed by a legume is tightly regulated in response to the existing nodule number and ongoing infections, and to its nitrate status. Ethylene participates in controlling nodule number. Inoculation with rhizobia or Nod factors induces ethylene production by the root (D'Haeze *et al.*, 2003; Sugauma *et al.*, 1995; van Spronsen *et al.*, 1995). Ethylene inhibits Nod factor-signal transduction and the continuation of ongoing infections and is also involved in nitrate regulation of nodulation (Lee and LaRue, 1992; Ligerio *et al.*, 1991; Oldroyd *et al.*, 2001; Penmetsa and Cook, 1997; Penmetsa *et al.*, 2003; van Spronsen *et al.*, 1995). In *M. truncatula*, ethylene inhibits the DMI/Nod-factor signal-transduction pathway somewhere between signal perception and Ca^{2+} -spiking (Oldroyd *et al.*, 2001), but does not block Nod factor-induced root hair deformation (Heidstra *et al.*, 1997).

Excessive ethylene production also blocks preinfection thread formation (van Spronsen *et al.*, 1995), possibly explaining the difference in ethylene sensitivity of nodulation between *L. japonicus* and soybean or bean. Nodules on *L. japonicus* initiate from cell divisions in the middle cortex, infection necessitating passage of infection threads through the outer cortex and preinfection thread formation. In contrast, the initial cell division in soybean or bean roots occurs in the outer root cortex, juxtaposed to the infected root hair, and no preinfection threads are needed (van Spronsen *et al.*, 2001).

Although ethylene may inhibit different steps of nodule formation, local controlled production of ethylene induced by Nod factors may also have a positive role in the formation of preinfection threads by reorienting microtubules and by provoking degradation of the cell wall, so contributing to tip growth and infection-thread passage (van Spronsen *et al.*, 1994; 1995).

Besides acting as a secondary signal induced by the Nod-factor signal, ethylene produced by developmental or physiological cues also influences nodulation. Local production of ethylene also contributes to spatial control of nodule initiation (Heidstra *et al.*, 1997). Nodules are generally formed opposite the protoxylem poles and ACC oxidase (the last enzymatic step in ethylene synthesis) is expressed opposite the phloem poles in uninoculated roots. When nodules are formed in the presence of blockers of ethylene synthesis and perception, a high fraction of the nodules develop at the phloem poles, demonstrating that ethylene production at the phloem poles helps to prevent cell division and nodule initiation at these locations.

Flooding leads to accumulation of ethylene because of reduced diffusion of the gas. Aquatic plants have evolved strategies to cope with flooding and use the high ethylene concentrations to induce appropriate developmental responses. Aquatic legumes use ethylene in a positive fashion for nodulation under flooded conditions (D'Haeze *et al.*, 2003; Fernández-López *et al.*, 1998; Goormachtig *et al.*, 2004). Legumes, such as *S. rostrata* or *Neptunia plena*, are able to switch between two infection modes, depending on the flooding conditions. Under non-flooded conditions, rhizobial infection proceeds *via* normal root-hair curling. Under flooded conditions, however, the infection involves colonization of spaces between cortical cells which result from fissures in the root epidermis, with infection threads

growing out of these “infection pockets”, an infection strategy called “crack entry”. Ethylene is the signal that controls the choice of the infection mode (Goormachtig *et al.*, 2004) and it is a secondary signal from the Nod factors essential for the crack entry (D’Haeze *et al.*, 2003). Moreover, *S. rostrata* is versatile not only in its infection mode but also in forming determinate or indeterminate nodules, a switch also controlled by ethylene induced by flooding (Fernández-López *et al.*, 1998).

4.5. *ENOD40: An Early Nodulin Gene Required for Division of Cortical Cells*

One of the most intriguing early nodulin genes is *enod40*, which has been cloned from many different legumes, and shows a basal expression in the root vascular bundle in the absence of rhizobia. Very soon after Nod-factor perception, its expression is induced in the pericycle and cortical nodule initials, even before cell division. It is expressed throughout the nodule primordium and, during nodule differentiation, in the meristem, the infection zone, and the nodule vascular bundles (Corich *et al.*, 1998; Crespi *et al.*, 1994; Fang and Hirsch, 1998; Kouchi and Hata, 1993; Mathesius *et al.*, 2000; Varkonyi-Gasic and White, 2002; Yang *et al.*, 1993). *ENOD40* expression is abolished in mutants of the Nod-factor signal-transduction pathway that lack cortical-cell divisions (Catoira *et al.*, 2000). However, other plant or bacterial mutants, which are defective in nodulation but able to induce cortical-cell divisions, also induce *enod40* expression (Imaizumi-Anraku *et al.*, 2000; Jiménez-Zurdo *et al.*, 2000; Yang *et al.*, 1993; N. Maunoury *et al.*, unpublished data). Thus, *ENOD40* expression is correlated with the activation of cell division and primordium formation during initial nodule development and with the meristematic activity in mature nodules.

Expression of *ENOD40* is not restricted to nodules, but occurs in meristems and the developing vasculature of lateral organs (Asad *et al.*, 1994; Corich *et al.*, 1998; Fang and Hirsch, 1998; Flemetakis *et al.*, 2000; Papadopoulou *et al.*, 1996). *ENOD40* homologs also occur in non-legumes, with expression patterns similar to that of non-symbiotic *ENOD40* in legumes (Kouchi *et al.*, 1999; van de Sande *et al.*, 1996). The *ENOD40* gene is also induced in other biotic interactions, such as mycorrhizal and nematode infection (Favery *et al.*, 2002; Koltai *et al.*, 2001; Van Rhijn *et al.*, 1997). Overexpression of the gene stimulates both types of interaction (Favery *et al.*, 2002; Staehelin *et al.*, 2001). Thus, the symbiotic and non-symbiotic expression of *ENOD40* seems to involve the formation of new carbon sinks (*e.g.*, lateral organs, nematode-feeding sites, or mycorrhizal roots) and helps carbon unloading from the vascular tissue.

Two lines of evidence indicate that *ENOD40* expression is essential for the initiation of cell divisions in the nodule progenitor cortical cells. Transgenic plants over-expressing *ENOD40* exhibit extensive cell divisions in their root cortex, even in the absence of rhizobia, and accelerated nodulation (Charon *et al.*, 1997; 1999), whereas decreased *ENOD40* expression is detrimental to nodulation (Charon *et al.*, 1999). Introducing the gene into cortical cells by microtargeting leads to cortical-cell

divisions accompanied by expression of another early nodulin gene, *enod12* (Charon *et al.*, 1997; Sousa *et al.* 2001).

An intriguing feature of *ENOD40* is its structure. The mRNA, about 700 bases long, contains no typical (long) ORF, but only a short putative ORF (sORF) that encodes small putative peptides 10, 12, or 13 amino acids long. *ENOD40* could, therefore, act as an RNA molecule or as a gene that codes for small peptide signals. Conservation (both nucleotide and amino-acid sequences) of this sORF across both legumes and non-legumes strongly indicates its functionality. Sequence comparison of *ENOD40* genes reveals two especially well-conserved boxes; box I, which corresponds to the sORF, and box II, which lacks a conserved ORF (van de Sande *et al.*, 1996). Structure predictions, confirmed by chemical and enzymatic probing, show that the *ENOD40* RNA is highly organised, folding into a conserved secondary structure (Crespi *et al.*, 1994; Girard *et al.*, 2003). Ballistic microtargeting of both wild-type and mutated *enod40*, followed by counting the number of cell-division foci in the root cortex (Crespi *et al.*, 1994; van de Sande *et al.*, 1996) demonstrated the biological activity of both the peptide and the highly structured *ENOD40* RNA (Charon *et al.*, 1997; Sousa *et al.*, 2001).

The *ENOD40*-encoded peptides bind a sucrose-synthase subunit (Röhrig *et al.*, 2002), supporting the “peptide” hypothesis and the proposal for a role of *enod40* in carbon unloading during the formation of a new sink organ. The “RNA” hypothesis, on the other hand, finds support in an RNA-binding protein, MtRBP1, whose cellular localization is determined by the *ENOD40* RNA (Campalans *et al.*, 2004). MtRBP1 was isolated as a protein interacting with the *ENOD40* RNA in a yeast three-hybrid screen. It is ubiquitously expressed and localized in the nucleus, but exported into the cytoplasm during nodule development in an *ENOD40* RNA-dependent manner. Thus, MtRBP1 and *ENOD40* RNA form a ribonucleoprotein particle (RNP), potentially including other proteins. The function of this RNP is still unknown but, by analogy with characterized RNPs, it may be involved in controlling translation of a set of target RNAs, in silencing mechanisms, or in production of the *ENOD40* peptides.

Despite many attempts to understand *ENOD40*, the gene remains enigmatic and the future will no doubt produce new surprises about this intriguing gene.

4.6. Carbon Unloading and Symplasmic Communication in Primordium Cells

Cell-to-cell communication during nodule initiation involves the generation of a symplasmic field in *Medicago* (Complainville *et al.*, 2003). Root cortical cells are symplasmically isolated from the phloem, but rhizobial infection creates a symplasmic connection first between the phloem and the nodule initials in the pericycle and then, when the primordium grows, between the phloem and the dividing cortical cells. The result is a symplasmic field isolated from other cortical cells not engaged in the primordium. The symplasmic field was attributed to both the creation of new plasmodesmata and an increased permeability of existing ones (Complainville *et al.*, 2003). In contrast, another study concluded that no

symplasmic unloading is involved in the generation of the nodule primordia (Santi *et al.*, 2003), but these conclusions were drawn from limited observations and in the absence of rhizobia. The creation of a symplasmic field is in general associated with the creation of carbon-sink organs. The nodule is a new carbon sink and the creation of the symplasmic field may be essential for facilitating the import of the sugars required for organ creation. The role of this symplasmic field during nodule formation may even be broader, possibly to allow the free movement of regulatory molecules, such as phytohormones, or other molecules, like proteins or RNAs. The importance of a symplasmic field for nodule initiation is nicely illustrated by the enhanced nodulation of transgenic plants expressing a viral movement protein known to increase permeability of plasmodesmata (Complainville *et al.*, 2003).

4.7. Other Signaling Candidates

Flavonoids, cytokinins, and ethylene are potential mobile signals that relay the Nod-factor signal from its perception in the epidermis to the pericycle and cortex, whereas auxins are imported from the stele. Could H_2O_2 be an additional mobile secondary signal? H_2O_2 and other ROS are likely produced in the course of Nod factor-induced root-hair growth modifications (Ramu *et al.*, 2002). ROS also play a positive role during the crack-entry infection of aquatic legumes (D'Haeze *et al.*, 2003). Despite the short lifetime of H_2O_2 (due to its chemical and metabolic reactivity), it nevertheless could potentially diffuse and act as a local or even long-range intercellular signal in plants (Alvarez *et al.*, 1998; Levine *et al.*, 1994). However, H_2O_2 has negative effects on the cell cycle (Reicheld *et al.*, 1999), making its implication in Nod factor-induced cell divisions unlikely. H_2O_2 induced by Nod factors in the root hairs could, however, diffuse into the outer cortical cells and prevent their division, meanwhile promoting their polarization and the formation of the preinfection threads.

A potential involvement of nitric-oxide signaling in nodulation has also been suggested and is surely a track worthwhile exploring (Hérouart *et al.*, 2002; Shimoda *et al.*, 2005). Finally, recent evidence also hints at roles for the gibberellin and brassinosteroid phytohormones in nodulation (Ferguson *et al.*, 2005; Lievens *et al.*, 2005). A variety of secondary signals orchestrates plant responses to the rhizobial Nod-factor signal, but their action, their interplay, and their integration into a signaling network for nodule organogenesis remain to be untangled.

5. DIFFERENTIATION OF N_2 -FIXING CELLS: THE ROLE OF ENDOREDUPPLICATION

5.1. Plant-cell Differentiation Frequently Involves Endoreduplication

Differentiation of any cell necessitates exit from the mitotic cycle. Exit is complete in certain cell types whereas, in others, partial cell cycle activities are maintained that are, however, insufficient for cell division. Commonly in plants, such partial

activity drives the endoreduplication cycles. Endoreduplication involves one or several DNA replication rounds without mitosis, resulting in polyploid cells with an increased chromosome copy number. Endoreduplication is widespread in plants and occurs in many tissue or cell types (Joubès and Chevalier, 2000). The pattern of ploidy is characteristic for each species and is inherited, indicating that it is part of the genetic and developmental program. In some plants, like *Arabidopsis*, endoreduplication is systemic with polyploid cells in all organs, whereas in others, it occurs in specific organs. Environmental and hormonal factors also influence ploidy patterns.

The polyploid state is generally associated with large cells, high metabolic activity, and/or a large organelle (mitochondria and plastids) content (Joubès and Chevalier, 2000; Kondorosi *et al.*, 2000; Larkins *et al.*, 2001; Sugimoto-Shirasu and Roberts, 2003). Endoreduplication is also intimately linked to development, differentiation, and cell specification (Kondorosi and Kondorosi, 2004). *Arabidopsis* trichomes (leaf hairs) are single cells that have undergone three-to-four rounds of endoreduplication and have a very particular branched shape. Disturbing endoreduplication by ectopic expression of cell-cycle genes results in distorted hairs; conversely, mutants affected in trichome differentiation are often also affected in endoreduplication (Hülkamp, 2004). Other notable examples of developmental programs involving endoreduplication are fruit and seed growth (Joubès and Chevalier, 2000; Larkins *et al.*, 2001).

5.2. Nodules are Polyploid Organs

In legumes, the highest nuclear DNA content occurs in nodule cells (Cebolla *et al.*, 1999; González-Sama *et al.*, 2005; Truchet, 1978), reaching 64C in *M. truncatula* (see Figure 4) and 128C in the tetraploid *M. sativa*. Infection zone II of indeterminate nodules, which displays a gradient in cell differentiation (Figure 4), is the site of endoreduplication. In the distal, sub-meristematic region of zone II, certain post-mitotic cells completely lose cell-cycle activity and will not be infected, whereas the others preserve the cell-cycle machinery for DNA replication. Only these endoreduplication-competent cells become infected by rhizobia in the sub-meristematic cell layer where rhizobia are released by endocytosis into the host-cell cytoplasm (Truchet, 1978). Three-to-four successive rounds of endoreduplication occur in infected cells, their ploidy level then increasing with increasing distance from the meristem (Figure 4). The higher nuclear DNA content is associated with an increase in nuclear volume and cell size, the enormous dimensions of the most polyploid 32C and 64C cells allowing them to host 30-50,000 rhizobia per cell (Cebolla *et al.*, 1999; Kondorosi and Kondorosi, 2004).

Infected cells in nodules of the determinate type (*e.g.*, *L. japonicus*) or lupinoid type (*e.g.*, *Lupinus albus*) also undergo endoreduplication (González-Sama *et al.*, 2005). After cell-division activity ceases in the young primordium of determinate nodules, cells maintain their capacity for endoreduplication. Lupinoid nodules share characteristics of both determinate and indeterminate nodules. Because their

meristem is transiently active, it may generate endoreduplication-competent cells as for indeterminate nodules. However, one cannot exclude the possibility that, after meristematic activity ceases, cells may endoreduplicate as for determinate nodules.

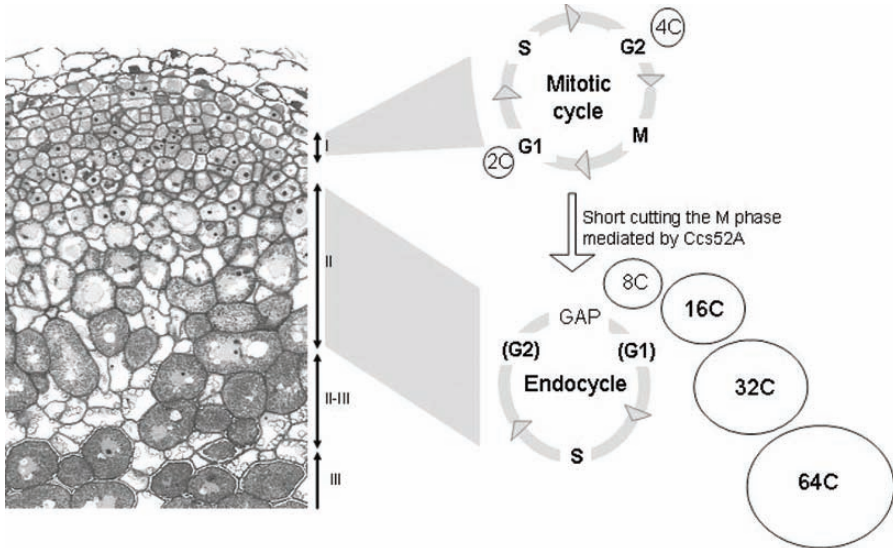

Figure 4. Differentiation of symbiotic cells is driven by endoreduplication. A transverse section through an indeterminate nodule of *M. truncatula* is shown. Cells in the meristem (zone I) are in a mitotic cycle, which is converted by activation of *CCS52A* to an endocycle in the infection/differentiation zone (zone II), leading to endoreduplication and differentiation of the symbiotic cells. The endoreduplication results in extreme enlargement of the cells. The N_2 -fixing cells have a ploidy level up to 64C in *M. truncatula*.

5.3. The Molecular Mechanism Controlling Endoreduplication

Endoreduplication can be viewed as a version of the mitotic cell cycle lacking the M-phase. In repeated endocycles, the S-phase alternates with a G-phase. Progression through S-phase relies largely on the same regulators in both the mitotic and endoreduplication cycles (Kondorosi and Kondorosi, 2004), but differences also exist between the S-phase entry in endocycles and mitotic cycles. In *Medicago* species, cyclin A2 (encoded by *CYCA2*) is required in mitotic cycles both for S-phase progression and G2/M transition (Roudier *et al.*, 2000), but is not needed for endocycles (Roudier *et al.*, 2003). In nodules, the *CYCA2* gene is expressed in the meristem but not in the infection zone. Repression of the gene may, therefore, eventually be needed for the transition from mitotic cycles to endocycles in the nodule cells leaving the meristem.

During endocycles, the mitotic activity of the cyclin-CDK complex is inhibited. Theoretically, this could be achieved by inactivation of CDKs with CDK-inhibitor

proteins, by repression of cyclin-gene expression, or by provoking cyclin-protein degradation with the ubiquitin-proteasome pathway. Recent work confirms the third possibility (Kondorosi and Kondorosi, 2004; Kondorosi *et al.*, 2005). The ubiquitin-proteasome pathway ensures the controlled irreversible inactivation of proteins by degradation. It involves polyubiquitylation of target proteins by different E3-ubiquitin ligases and their subsequent degradation by the 26S proteasome. Mitotic cyclins are targeted for degradation by the anaphase-promoting complex (APC) E3 enzyme. The APC is a conserved multisubunit enzyme complex in eukaryotes composed of at least 13 core subunits and activated by WD40 repeat proteins, which also determine the substrate specificity of the APC (Harper *et al.*, 2002).

Endoreduplication of nodule cells is elicited by expression of the *CCS52A* gene encoding a substrate-specific activator of the APC (Cebolla *et al.*, 1999; see Figure 4). It is induced in nodule primordia before cell differentiation starts and, in mature nodules, it is expressed in the infection/differentiation zone II, where mitotic B-type cyclins are also expressed (Cebolla *et al.*, 1999; Vinardell *et al.*, 2003). As *CCS52A* provokes degradation of mitotic cyclins at the instant of their production, the mitotic CDKs are inactive and the cells cannot enter and complete mitosis but can restart DNA replication (Cebolla *et al.*, 1999; Fülöp *et al.*, 2005; Tarayre *et al.*, 2004). Transcript levels of *CCS52A* show a direct correlation with the degree of ploidy. When *CCS52A* was downregulated in transgenic *M. truncatula*, the ploidy level decreased in different organs, including the nodules (Vinardell *et al.*, 2003).

5.4. The Role of Endoreduplication in the Differentiation of Symbiotic Nodule Cells

The nodules formed on transgenic plants with reduced *CCS52A* expression and the resultant reduced ploidy levels were non-functional and never fixed N₂ (Vinardell *et al.*, 2003). Cells in the infection zone were inefficiently infected by rhizobia, did not differentiate properly, and underwent a very early senescence. Endoreduplication is, therefore, an integral part of the differentiation of the symbiotic cells.

Despite being widespread in plants, the physiological reason for endoreduplication is only partially understood, the most frequently cited role being to allow cells to grow very large due to a higher global transcription and metabolic activity. In other words, endoreduplication is a cellular strategy to grow without cell division. Thus, endoreduplication in nodule cells accounts for the enormous size increase of the infected cells during differentiation and for the major part of the nodule organ size. But why is this strategy chosen rather than more cell divisions and higher cell numbers? Perhaps infection of cells is incompatible with division because the required architecture of the cytoskeleton for the two processes may be different. In addition, choosing less, but larger, cells may be more economic for growth than more and smaller cells. Furthermore, in an infected cell, a host cell-derived symbiosome membrane surrounds one or more bacteroids. As there are thousands of bacteroids in each cell, forming and maintaining the symbiosomes is a

heavy burden in membrane synthesis. Decreasing normal membrane synthesis by disturbing the expression of genes encoding Ras-type small G-proteins, which are involved in vesicle transport, has major consequences for the differentiation of infected cells and bacteroids (Cheon *et al.*, 1993). One large cell has a smaller surface area than many smaller cells of the same total volume, so that using large cells may economize on membrane synthesis.

Endoreduplication may have an even more specific role in differentiation of plant cells in general and of N₂-fixing cells in particular - the control of developmentally-regulated gene expression. Transcriptome analysis has revealed the activation of several hundred plant genes during nodule organogenesis (Colebatch *et al.*, 2004; Fedorova *et al.*, 2002; El Yahyaoui *et al.*, 2004). Analysis of the expression of these genes in a wide range of plant and bacterial nodulation mutants, which were affected in different stages of organogenesis, revealed a developmental point that leads to a massive induction of specific gene expression. Severely affected nodulation mutants cannot pass this point, only mutants affected at later stages in nodule development can. In this mutant collection, there was a striking positive correlation between massive gene expression and endoreduplication (N. Maunoury *et al.*, unpublished data). Thus, endoreduplication could be involved in nodule-specific gene activation, for example by changing epigenetic chromatin marks from a silent to an actively transcribed chromatin state. During DNA replication in the mitotic cell cycle, epigenetic marks are faithfully reproduced on the daughter strands, but may be lost or changed during successive cycles of DNA replication in endocycles.

6. BACTEROID DIFFERENTIATION

6.1. Endocytosis of Rhizobia

Rhizobia are released into host cells from growing infection threads by a two-step process. Infection droplets are intracellular structures that bud off the infection threads in the target cells. They have no cell wall and rhizobia are in direct contact with the droplet membrane. The direct contact results in endocytotic uptake of the rhizobia into a cytoplasmic compartment, the symbiosome, where a plasmalemma-derived membrane encloses one or several rhizobia in indeterminate and determinate nodules, respectively. Rhizobia inside the symbiosomes are called bacteroids; though located in the cytosol, their location is equivalent to the extracellular space.

What provokes infection threads to form infection droplets is unknown, but recent work offers some new and exciting insights. Endocytosis of rhizobia into either primordium cells or post-mitotic cells of a mature nodule was shown to rely on the DMI-pathway. Knockout mutants in this pathway are blocked early, in the root hairs (see above), but the use of knock-down mutants of *dmi2* in *M. truncatula* or *S. rostrata* allowed analysis of its role in later steps of nodule development (Capoen *et al.*, 2005; Limpens *et al.*, 2005). Nodules formed by the knock-down

mutants contained extensive infection threads, but were blocked in the endocytotic release of rhizobia from them. *In situ* hybridizations and promoter-GUS fusions showed that the genes of the DMI-pathway are indeed expressed in the infection zone of nodules (Bersoult *et al.*, 2005; Capoen *et al.*, 2005; Limpens *et al.*, 2005). These findings pave the way to understanding the molecular details of endocytosis.

6.2. Bacteroids are Highly Differentiated in Nodules of Vicioid Legumes

In indeterminate nodules of the vicioid clade of legumes (*Medicago* sp., *Pisum* sp., *Vicia* sp., *etc.*, sometimes also designated the galeoid clade), the bacteroids differentiate gradually and simultaneously with the host cells (Beijerinck, 1888; Vasse *et al.*, 1990; see Figure 5A). The rod-shaped bacteria released from the infection threads resemble free-living bacteria and continue dividing in the submeristematic cell layers (the distal part of the infection zone). In the older growing and endoreduplicating cells of the infection zone, the bacteria do not divide further, but they increase dramatically in size by elongation (from 1–2 μm to 5–10 μm), sometimes branching. The differentiation is also accompanied by the formation of sharply separated and alternating zones rich in DNA fibrils or ribosomes. Vasse *et al.* (1990) distinguished distinct steps in bacteroid differentiation, each being restricted to a histological region of the nodule. The differentiation of N_2 -fixing bacteroids is completed in the distal cells of the N_2 -fixation zone (Figure 5A).

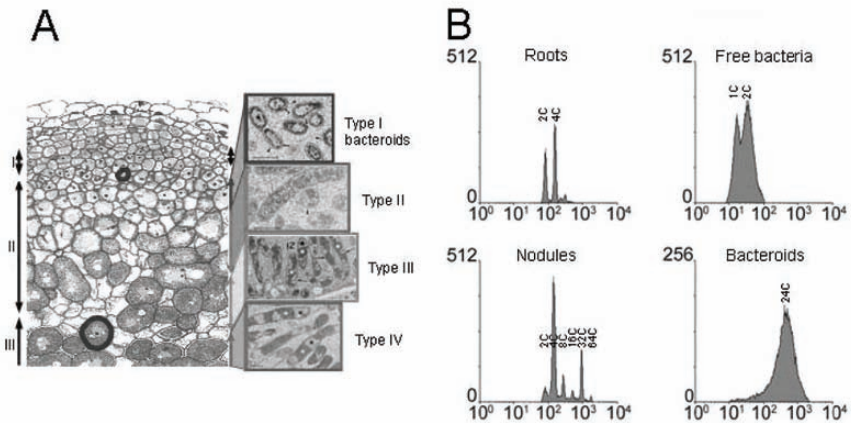

Figure 5. Analogous differentiation paths for host symbiotic cells and bacteroids in the *M. truncatula*-*S. meliloti* symbiosis.

- A. Cytological observation of differentiation in plant cells (left; I is meristem; II is the infection/differentiation zone; III is the fixation zone) and bacteroids (right). The small encircled cell is a submeristematic cell; the large cell is a young N_2 -fixing cell. The different stages of bacteroid differentiation are taken from Vasse *et al.* (1990).
- B. Flow cytometric analysis of the DNA content in roots, nodules, cultured bacteria, and bacteroids (Mergaert *et al.*, 2006). 1C is the DNA content of a haploid genome.

The bacteroid differentiation in vicoid legumes also involves massive DNA amplification. In *S. meliloti* bacteroids in *M. truncatula*, there is a 24-fold increase relative to the free-living state (Figure 5B). The DNA amplification involves the whole genome rather than an amplification of particular regions and is, thus, the result of endoreduplication (Mergaert *et al.*, 2006). Thus, this prokaryote uses the same strategy as eukaryotes for increasing cell size by endoreduplication. It is noteworthy that the differentiation processes in plant-host cell and bacteroid display surprising parallels (Figure 5) with both cell types increasing enormously in size as a result of genome multiplication caused by an uncoupling between DNA replication and cell division.

The differentiation of the microsymbiont is also accompanied by important global changes in gene and protein expression, reflecting a general slow down of the housekeeping metabolism and cell division and activation of metabolic pathways needed for the N₂-fixation process (Ampe *et al.*, 2003; Becker *et al.*, 2004; Djordjevic *et al.*, 2003; Natera *et al.*, 2000). This bacteroid differentiation is irreversible because differentiated bacteroids are unable to resume growth when released from a nodule (McRae *et al.*, 1989; Mergaert *et al.*, 2006; Sutton and Paterson, 1983).

6.3. *Distinct Developmental Fates of Bacteroids in Vicoid and Non-vicoid Legumes*

The dramatic differentiation of bacteroids is typical for legumes belonging to the vicoid clade, but is not a general developmental path for all rhizobia. In legumes such as beans and *Lotus*, the N₂-fixing bacteroids are strikingly similar to free-living bacteria. The bacteroids are able to divide inside the symbiosome membrane (Cermola *et al.*, 2000; Szczyglowski *et al.*, 1998); they show little or no genome amplification (Bisseling *et al.*, 1977; Mergaert *et al.*, 2006), maintain their original size and shape, and do not lose their viability (Mergaert *et al.*, 2006; Müller *et al.*, 2001; Sutton and Paterson, 1983).

With recombinant *Rhizobium* strains nodulating both legume types, it was shown that the host plant controls bacteroid differentiation (Mergaert *et al.*, 2006). Bacteroid differentiation in vicoid legumes is, therefore, an active mechanism imposed by host-plant factors that block bacterial cell division and trigger endoreduplication, thereby forcing the endosymbionts towards terminal differentiation. In vicoid legumes, the plant apparently limits the bacterial reproductive capacity. The purpose could be better N₂ fixation, improved control over the rhizobial population either *in planta* or in the rhizosphere, or recovery of nutrients from rhizobia when the nodule senesces.

This mechanism poses an evolutionary problem: how can an interaction be selected in which rhizobia apparently enter a trap from which they cannot escape? Indeed, though a dead-end for N₂-fixing bacteroids, a small population of non-differentiated and proliferating bacteria exists in the infection threads. Rhizobia liberated from the infection threads can multiply in senesced nodule cells and

recolonize the rhizosphere when released from a senescing nodule (Sprent *et al.*, 1987; Timmers *et al.*, 2000). Moreover, the plant will penalize non-cooperative rhizobia (non-fixing or fixing with low efficiency) by markedly lowering their reproductive success in the nodule, so that “altruistic” N₂ fixation is obligatory to increase the soil population after nodule breakdown (Kiers *et al.*, 2003). Finally, the N₂-fixing nodule will increase the fitness of the plant and, thus, provoke an increased root exudation of carbon compounds supporting rhizobial metabolism in the rhizosphere. Some rhizobia have even evolved a sophisticated strategy to divert plant-provided carbon into specific molecules, produced by the bacteroids and metabolized exclusively by their kin in the rhizosphere. This mechanism is analogous to the “opine-concept” in *Agrobacterium* and the specific compounds are termed rhizopines (Dessaux *et al.*, 1998). It is noteworthy that rhizopines have only been found in rhizobia from vicoid legumes (Wexler *et al.*, 1995). Perhaps this group of rhizobia have found a means of improving kin-selection in the rhizosphere to compensate for their decreased survival from the nodule. Kin selection towards non-differentiated nodule residents or to rhizobia in the rhizosphere may be the evolutionary force maintaining the symbionts of vicoid legumes. One can also ask why terminal bacteroid differentiation does not exist in determinate nodules. Because of their nodule architecture (see Figure 1), determinate nodules have a homogeneous bacteroid population. Terminal differentiation of bacteroids would fail to replenish the rhizosphere with rhizobia from a senescing nodule.

Although legumes form a large family with hundreds of genera whose nodule types vary greatly, only a few have been studied in detail. One further example of host influence on bacteroid morphology and viability is valuable. Peanut nodules are of the aescynomenoid type, which are distinct from both determinate and indeterminate nodules. In these nodules, the bacteroids are enlarged and spherical (Sen *et al.*, 1986) and have lost their ability to resume growth (Sutton and Paterson, 1983). These bacteroid features are controlled by the host plant because the same rhizobial strain produces determinate nodules on cowpea with morphologically unaltered bacteroids typical of such nodules (Sen *et al.*, 1986).

6.4. Are Plant Signals Involved in Bacteroid Differentiation?

What signals could vicoid legumes produce to inhibit bacterial cytokinesis and induce bacteroid development? To help answer this question, an interesting parallel can be drawn between intracellular bacteroids and intracellular animal pathogens.

Cationic antimicrobial peptides (defensins) are part of the cell's innate immune system that are activated in response to pathogens. The assault on intracellular *Salmonella* with defensins results in inhibition of cell division and formation of elongated cells (Rosenberger *et al.*, 2004). The lipopolysaccharides (LPS) of the pathogens are virulence factors important in overcoming innate host defences. LPS mutants of *Salmonella*, *Pseudomonas* or *Brucella* show increased sensitivity to defensins, resulting in a loss of intracellular survival and, thus, markedly reduced virulence (Ernst *et al.*, 1999; LeVier *et al.*, 2000; Rosenberger *et al.*, 2004).

Intracellular colonization by pathogens involves structural LPS modifications that make the pathogen more resistant to host antimicrobial peptides (Ernst *et al.*, 1999; Rosenberger *et al.*, 2004).

Interestingly, the rhizobial LPS also affects bacteroid differentiation in vicoid legumes. Bacteroids of LPS mutants have abnormal shapes even if they remain partially functional or they differentiate incompletely and senesce prematurely (Campbell *et al.*, 2002; Ferguson *et al.*, 2004; Glazebrook *et al.*, 1993; Niehaus *et al.*, 1998; Vedam *et al.*, 2004). The *lpsB* mutant of *S. meliloti* is more sensitive to antimicrobial peptides (Campbell *et al.*, 2002). Further, wild-type rhizobia modify their LPS during bacteroid differentiation in pea or medic nodules (Ferguson *et al.*, 2005; Kannenberg and Carlson, 2001). These modifications result in a more hydrophobic LPS and bacterial cell surface, which is thought to facilitate non-specific contact of the bacterial membrane with plant membranes *via* hydrophobic interactions, thereby allowing symbiotic exchanges between the symbionts (Kannenberg and Carlson, 2001). However, in view of a potential role for LPS in protection against antimicrobial peptides in both animal pathogens and rhizobia, the LPS changes in bacteroids may be an attempt to counteract plant defensin-like peptides that force the bacteroids into a terminally differentiated state.

The BacA protein of *S. meliloti* affects LPS structure as found with LPS mutants, but *bacA* mutants show much more damage to their symbiotic phenotype, indicating that BacA has an additional function (Ferguson *et al.*, 2005). Because the BacA protein resembles peptide transporters (Glazebrook *et al.*, 1993), BacA could, therefore, mediate transport of plant peptides that affect bacteroid differentiation. The plant factors involved in terminal bacteroid differentiation in vicoid legumes could, therefore, be defensin-like peptides. Recently, a novel extremely large nodule-specific gene family (more than 300 genes) was identified by transcriptome analysis in *M. truncatula* and named the *NCR* (nodule-specific cysteine-rich) family (Fedorova *et al.*, 2002; Mergaert *et al.*, 2003). The *NCR* genes code for polypeptides resembling defensins. The *NCR* genes are induced at different stages of symbiotic cell differentiation, their joined expression patterns overlapping with the regions of bacteroid differentiation (Mergaert *et al.*, 2003). *NCR* peptides go into the secretory pathway, the most likely road taken by symbiosome proteins (Catalano *et al.*, 2004; Verma and Hong, 1996; Whitehead and Day, 1997), and could be targeted to the symbiosomes (Mergaert *et al.*, 2003). The *NCR* genes are typical of vicoid legumes but absent from *L. japonicus* or *G. max*. The *NCR* peptides are, therefore, possible candidates for being specific plant signals that trigger and coordinate bacteroid differentiation.

7. NITROGEN FIXATION

Differentiation of host cells and microsymbionts culminates in the onset of N₂ fixation in the distal cell layer of the N₂-fixation zone of indeterminate nodules. In both symbionts, this requires a battery of specific proteins that are absent from the non-symbiotic cells. The interzone II-III is an important zone for gene activation in

both the plant cell (de Billy *et al.*, 1991) and the microsymbiont (Soupène *et al.*, 1995). It consists of a few cell layers where transcription of several plant and bacterial genes involved in the fixation process is activated.

The regulatory mechanisms activating genes in host cells are largely unknown. As discussed above, control by epigenetic mechanisms may be one level of control and certainly deserves future exploration. Some transcription factors either specifically active or with enhanced activity in nodules have been detected or isolated by reverse genetics and biochemical methods (Cvitanich *et al.*, 2000; Forde *et al.*, 1990; Frugier *et al.*, 2000; Grønlund *et al.*, 2003; Heard and Dunn, 1995; Jacobsen *et al.*, 1990; Jensen *et al.*, 1988). However, what they do and the genes they control remain largely unknown. Likewise, some promoters of nodule-specific genes have been characterized, allowing potential nodule-specific *cis*-acting promoter elements to be defined (*e.g.*, Frühling *et al.*, 2000; Gallusci *et al.*, 1991; Jensen *et al.*, 1988; Metz *et al.*, 1988; Sandal *et al.*, 1987; Stougaard *et al.*, 1987, 1990; Szabados *et al.*, 1990; Trepp *et al.*, 1999). Again, these data are fragmentary and the transcription factors that bind these elements are unknown. Thus, our current knowledge of the transcriptional networks controlling nodule development and function is very limited. Transcriptomics will certainly change this situation in the near future and will provide whole (and eventually complete) lists of genes expressed in nodules. The first such efforts have been reported already (Colebatch *et al.*, 2004; El Yahyaoui *et al.*, 2004; Fedorova *et al.*, 2002). Transcriptomics may also be used to cluster these genes, based on their expression profiles, in groups of constitutive genes, early- or late-induced genes, and genes affected in specific nodulation mutants. Bioinformatic promoter analysis of such groups of co-regulated genes may identify the *cis*- and *trans*-regulatory factors that control nodule-specific gene expression.

In contrast to gene regulation in the plant cell, the regulation of bacterial genes in nodules is extremely well studied, involving well-characterized transcription factors and physiological signals. Kaminski *et al.* (1998) provide such a detailed description of gene regulation in bacteroids.

The nitrogen and carbon metabolism of the N₂-fixing cells is known in great detail and is reviewed in Chapter 8 of this volume and elsewhere (*e.g.*, Kahn *et al.*, 1998; Udvardi and Day, 1997). Approaches, such as transcriptome, proteome and metabolome analysis in both symbionts, promise to reveal much more detail about the metabolic flows in the N₂-fixing nodule or even to expose novel unknown aspects (Ampe *et al.*, 2003; Becker *et al.*, 2004; Catalano *et al.*, 2004; Colebatch *et al.*, 2004; Djordjevic *et al.*, 2003; Fedorova *et al.*, 2002; Mergaert *et al.*, 2003; Natera *et al.*, 2000; Panter *et al.*, 2000; Wienkoop and Saalbach, 2003).

8. SENESCENCE OF NODULES

Symbiotic cells are short-lived and senesce after a brief period of N₂ fixation. In indeterminate nodules, this process occurs in a histologically distinct senescence zone (zone IV) adjacent to the N₂-fixing zone and proximal to the root (Vasse *et al.*,

1990). In a zone proximal to the senescence zone of older indeterminate nodules, infection threads continue proliferating and rhizobia are re-released into the senesced plant cells. However, they do not differentiate into bacteroids and are saprophytic (Timmers *et al.*, 2000). Senescence of symbiotic cells is an integral part of nodule life but can be prematurely activated by whole plant physiological or developmental conditions that either cause a drop in carbon available to the nodule (*e.g.*, the creation of a new carbon sink, defoliation, or dark) or by an increase in available fixed N. Early senescence is also induced when N₂ fixation is inefficient because the rhizobial strain is sub-optimal.

The senescence process leads to rupture of the symbiosome membrane, bacteroid breakdown, and autolysis of the plant-cell cytosol. However, the degree of bacteroid digestion appears to differ in indeterminate and determinate nodules. In the former, the entire bacteroid population is fully degraded and no bacteroids survive (Van de Velde *et al.*, 2006; Vasse *et al.*, 1990) whereas, in the latter, at least part of the bacteroid population can resume growth when released from the senescing nodule (Cermola *et al.*, 2000; Müller *et al.*, 2001; Puppo *et al.*, 2005). The mechanisms involved in the senescence of symbiotic cells are well studied and an extensive literature describes the process (Puppo *et al.*, 2005). Proteolysis lowers the enzymatic antioxidant defence and releases catalytic metal ions from metalloproteins (*e.g.*, leghemoglobin) abundant in symbiotic cells (Escuredo *et al.*, 1996; Evans *et al.*, 1999; Gogorcena *et al.*, 1997; Matamoros *et al.*, 1999; Naito *et al.*, 2000; Pladys and Vance, 1993; Vance *et al.*, 1979). The resulting free radical generation imposes an oxidative stress that provokes cell death (Becana and Klucas, 1992).

The signal(s) that induce(s) senescence and the signal-transduction pathways involved are less well known than the mechanism of cell breakdown (Puppo *et al.*, 2005). This situation may soon be changed by genetic and genomic approaches. A recent transcriptome analysis of nodule senescence on *M. truncatula* revealed many novel details of the process (Van de Velde *et al.*, 2006). Sampling different stages and zones of senescing nodules showed that the process could be separated into three consecutive phases of gene transcription. Phase 1 begins in healthy nodule tissues and involves regulatory genes that could be part of pathways triggering senescence. Stages 2 and 3 likely engage genes involved respectively in early stages of senescence (bacteroid degradation) and in late stages of senescence (host-cell degradation). Stage-2 and -3 genes encode proteinases, catabolic enzymes for nucleic acid, lipid and sugar degradation, and transporters for nutrient remobilization and recycling. The study also revealed a positive role for the phytohormones, ethylene and jasmonic acid, and a negative role for gibberellic acid. Finally, although there was a striking overlap between nodule and leaf senescence, a large number of unique genes was identified arguing for the existence of mechanisms and pathways specific to nodule senescence.

REFERENCES

- Alvarez, M. E., Pennell, R. I., Meijer, P. J., Ishikawa, A., Dixon, R. A., and Lamb, C. (1998). Reactive oxygen intermediates mediate a systemic signal network in the establishment of plant immunity. *Cell*, *92*, 773-784.
- Ampe, F., Kiss, E., Sabourdy, F., and Batut, J. (2003). Transcriptome analysis of *Sinorhizobium meliloti* during symbiosis. *Genome Biol.*, *4*, R15.
- Ardourel, M., Demont, N., Debéllé, F., Maillat, F., de Billy, F., Promé, J. C., et al. (1994). *Rhizobium meliloti* lipooligosaccharide nodulation factors: Different structural requirements for bacterial entry into target root hair cells and induction of plant symbiotic developmental responses. *Plant Cell*, *6*, 1357-1374.
- Asad, S., Fang, Y. W., Wycoff, K. L., and Hirsch, A. M. (1994). Isolation and characterization of cDNA and genomic clones of *MsENOD40*: Transcripts are detected in meristematic cells of alfalfa. *Protoplasma*, *183*, 10-23.
- Bauer, P., Ratet, P., Crespi, M., Schultze, M., and Kondorosi, A. (1996). Nod factors and cytokinins induce similar cortical cell division, amyloplast deposition and *MsEnod12A* expression patterns in alfalfa roots. *Plant J.*, *10*, 91-105.
- Becana, M., and Klucas, R. V. (1992). Transition metals in legume root nodules: Iron-dependent free radical production increases during nodule senescence. *Proc. Natl. Acad. Sci. USA*, *89*, 8958-8962.
- Becker, A., Bergès, H., Krol, E., Bruand, C., Rüberg, S., Capela, D., et al. (2004). Global changes in gene expression in *Sinorhizobium meliloti* 1021 under microoxic and symbiotic conditions. *Mol. Plant-Microbe Interact.*, *17*, 292-303.
- Beijerinck, M. W. (1888). Die Bakterien der Papilionaceenknöllchen. *Bot. Zeit.*, *46*, 725-804.
- Berken, A., Thomas, C., and Wittinghofer, A. (2005). A new family of RhoGEFs activates the Rop molecular switch in plants. *Nature*, *436*, 1176-1180.
- Bersoult, A., Camut, S., Perhald, A., Kereszt, A., Kiss, G. B., and Cullimore, J. V. (2005). Expression of the *Medicago truncatula* *DMI2* gene suggests roles of the symbiotic nodulation receptor kinase in nodules and during early nodule development. *Mol. Plant-Microbe Interact.*, *18*, 869-876.
- Bhalerao, R. P., and Bennett, M. J. (2003). The case for morphogens in plants. *Nature Cell Biol.*, *5*, 939-943.
- Bisseling, T., Vandenbos, R. C., Van Kammen, A., Vanderploeg, M., Vanduijn, P., and Houwers, A. (1977). Cytofluorometrical determination of DNA contents of bacteroids and corresponding broth-cultured *Rhizobium* bacteria. *J. Gen. Microbiol.*, *101*, 79-84.
- Boot, K., van Brussel, A., Tak, T., Spaink, H., and Kijne, J. W. (1999). Lipochitin oligosaccharides from *Rhizobium leguminosarum* bv. *viciae* reduce auxin transport capacity in *Vicia sativa* subsp. *nigra* roots. *Mol. Plant-Microbe Interact.*, *12*, 839-844.
- Brewin, N. J. (2004). Plant cell wall remodelling in the *Rhizobium*-legume symbiosis. *Crit. Rev. Plant Sci.*, *23*, 293-316.
- Broughton, W. J., Jabbouri, S., and Perret, X. (2000). Keys to symbiotic harmony. *J. Bacteriol.*, *182*, 5641-5652.
- Brown, D. E., Rashotte, A. M., Murphy, A. S., Normanly, J., Tague, B. W., Peer, W. A., et al. (2001). Flavonoids act as negative regulators of auxin transport in vivo in Arabidopsis. *Plant Physiol.*, *126*, 524-535.
- Buer, C. S., and Muday, G. K. (2004). The *transparent testa4* mutation prevents flavonoid synthesis and alters auxin transport and the response of Arabidopsis roots to gravity and light. *Plant Cell*, *16*, 1191-1205.
- Campalans, A., Kondorosi, A., and Crespi, M. (2004). *Enod40*, a short open reading frame-containing mRNA, induces cytoplasmic localization of a nuclear RNA binding protein in *Medicago truncatula*. *Plant Cell*, *16*, 1047-1059.
- Campbell, G. R. O., Reuhs, B. L., and Walker, G. C. (2002). Chronic intracellular infection of alfalfa nodules by *Sinorhizobium meliloti* requires correct lipopolysaccharide core. *Proc. Natl. Acad. Sci. USA*, *99*, 3938-3943.
- Capoen, W., Goormachtig, S., De Rycke, R., Schroyers, K., and Holsters, M. (2005). SrSymRK, a plant receptor essential for symbiosome formation. *Proc. Natl. Acad. Sci. USA*, *102*, 10369-10374.

- Cárdenas, L., Feijo, J. A., Kunkel, J. G., Sanchez, F., Holdaway-Clarke, T., Hepler, P. K., *et al.* (1999). *Rhizobium* Nod factors induce increases in intracellular free calcium and extracellular calcium influxes in bean root hairs. *Plant J.*, *19*, 347-352.
- Catalano, C. M., Lane, W. S., and Sherrier, D. J. (2004). Biochemical characterization of symbiosome membrane proteins from *Medicago truncatula* root nodules. *Electrophoresis*, *25*, 519-531.
- Catoira, R., Galera, C., de Billy, F., Penmetsa, R. V., Journet, E. P., Mailliet, F., *et al.* (2000). Four genes of *Medicago truncatula* controlling components of a Nod factor transduction pathway. *Plant Cell*, *12*, 1647-1666.
- Catoira, R., Timmers, A. C., Mailliet, F., Galera, C., Penmetsa, R. V., Cook, D., *et al.* (2001). The *HCL* gene of *Medicago truncatula* controls *Rhizobium*-induced root hair curling. *Development*, *128*, 1507-1518.
- Cebolla, A., Vinardell, J. M., Kiss, E., Oláh, B., Roudier, F., Kondorosi, A., *et al.* (1999). The mitotic inhibitor *ccs52* is required for endoreduplication and ploidy-dependent cell enlargement in plants. *EMBO J.*, *18*, 4476-4484.
- Cermola, M., Fedorova, E., Taté, R., Riccio, A., Favre, R., and Patriarca, E. J. (2000). Nodule invasion and symbiosome differentiation during *Rhizobium etli-Phaseolus vulgaris* symbiosis. *Mol. Plant-Microbe Interact.*, *13*, 733-741.
- Charon, C., Johansson, C., Kondorosi, E., Kondorosi, A., and Crespi, M. (1997). *Enod40* induces dedifferentiation and division of root cortical cells in legumes. *Proc. Natl. Acad. Sci. USA*, *94*, 8901-8906.
- Charon, C., Sousa, C., Crespi, M., and Kondorosi, A. (1999). Alteration of *enod40* expression modifies *Medicago truncatula* root nodule development induced by *Sinorhizobium meliloti*. *Plant Cell*, *11*, 1953-1966.
- Chen, C. Y.-H., Cheung, A. Y., and Wu, H.-M. (2003). Actin-depolymerizing factor mediates Rac/Rop GTPase-regulated pollen tube growth. *Plant Cell*, *15*, 237-249.
- Cheon, C. I., Lee, N. G., Siddique, A. B., Bal, A. K., and Verma, D. P. (1993). Roles of plant homologs of Rab1p and Rab7p in the biogenesis of the peribacteroid membrane, a subcellular compartment formed de novo during root nodule symbiosis. *EMBO J.*, *12*, 4125-4135.
- Colebatch, G., Desbrosses, G., Ott, T., Krusell, L., Montanari, O., Kloska, S., *et al.* (2004). Global changes in transcription orchestrate metabolic differentiation during symbiotic nitrogen fixation in *Lotus japonicus*. *Plant J.*, *39*, 487-512.
- Complainville, A., Brocard, L., Roberts, L., Dax, E., Sever, N., Sauer, N., *et al.* (2003). Nodule initiation involves the creation of a new symplasmic field in specific root cells of *Medicago* species. *Plant Cell*, *15*, 2778-2791.
- Cooper, J. B., and Long, S. R. (1994). Morphogenetic rescue of *Rhizobium meliloti* nodulation mutants by trans-zeatin secretion. *Plant Cell*, *6*, 215-225.
- Corich, V., Goormachtig, S., Lievens, S., Van Montagu, M., and Holsters, M. (1998). Patterns of *ENOD40* gene expression in stem-borne nodules of *Sesbania rostrata*. *Plant Mol. Biol.*, *37*, 67-76.
- Crespi, M. D., Jurkevitch, E., Poirer, M., d'Aubenton-Carafa, Y., Petrovics, G., Kondorosi, E., *et al.* (1994). *Enod40*, a gene expressed during nodule organogenesis, codes for a non-translatable RNA involved in plant growth. *EMBO J.*, *13*, 5099-5112.
- Cvitanich, C., Pallisgaard, N., Nielsen, K. A., Hansen, A. C., Larsen, K., Pihakaski-Maunsbach, K., *et al.* (2000). CPP1, a DNA-binding protein involved in the expression of a soybean *leghemoglobin c3* gene. *Proc. Natl. Acad. Sci. USA*, *97*, 8163-8168.
- de Billy, F., Barker, D. G., Gallusci, P., and Truchet, G. (1991). Leghaemoglobin gene transcription is triggered in a single cell layer in the indeterminate nitrogen-fixing root nodule of alfalfa. *Plant J.*, *1*, 27-35.
- de Billy, F., Grosjean, C., May, S., Bennett, M., and Cullimore, J. V. (2001). Expression studies on *AUX1*-like genes in *Medicago truncatula* suggest that auxin is required at two steps in early nodule development. *Mol. Plant-Microbe Interact.*, *14*, 267-277.
- de Carvalho-Niebel, F., Timmers, A. C., Chabaud, M., Defaux-Petras, A., and Barker, D. G. (2002). The Nod factor-elicited annexin MtAnn1 is preferentially localised at the nuclear periphery in symbiotically activated root tissues of *Medicago truncatula*. *Plant J.*, *32*, 343-352.
- de Ruijter, N. C. A., Rook, M. B., Bisseling, T., and Emons, A. M. C. (1998). Lipochito-oligosaccharides re-initiate root hair tip growth in *Vicia sativa* with high calcium and spectrin-like antigen at the tip. *Plant J.*, *13*, 341-350.

- de Ruijter, N. C. A., Bisseling, T., and Emons, A. M. C. (1999). *Rhizobium* Nod factors induce an increase in subapical fine bundles of actin filaments in *Vicia sativa* root hairs within minutes. *Mol. Plant-Microbe Interact.*, *12*, 829-832.
- Dehio, C., and de Bruijn, F. J. (1992). The early nodulin gene *SrEnod2* from *Sesbania rostrata* is inducible by cytokinin. *Plant J.*, *2*, 117-128.
- den Hartog, M., Musgrave, A., and Munnik, T. (2001). Nod factor-induced phosphatidic acid and diacylglycerol pyrophosphate formation: a role for phospholipase C and D in root hair deformation. *Plant J.*, *25*, 55-65.
- Dénarié, J., Debelle, F., and Promé, J.-C. (1996). *Rhizobium* lipo-chitooligosaccharide nodulation factors: Signaling molecules mediating recognition and morphogenesis. *Annu. Rev. Biochem.*, *65*, 503-35.
- Dessaux, Y., Petit, A., Farrand, S. K., and Murphy, P. M. (1998). Opines and opine-like molecules in plant-*Rhizobiaceae* interaction. In H. P. Spaink, A. Kondorosi and P. J. J. Hooykaas (Eds.), *The Rhizobiaceae* (pp. 173-197). Dordrecht, The Netherlands: Kluwer Academic Publishers.
- D'Haese, W., De Rycke, R., Mathis, R., Goormachtig, S., Pagnotta, S., Verplancke, C., *et al.* (2003). Reactive oxygen species and ethylene play a positive role in lateral root base nodulation of a semiaquatic legume. *Proc. Natl. Acad. Sci. USA*, *100*, 11789-11794.
- Dharmasiri, N., and Estelle, M. (2004). Auxin signaling and regulated protein degradation. *Trends Plant Sci.*, *9*, 302-308.
- Dharmasiri, N., Dharmasiri, S., and Estelle, M. (2005). The F-box protein TIR1 is an auxin receptor. *Nature*, *435*, 441-445.
- Djordjevic, M. A., Chen, H. C., Natera, S., Van Noorden, G., Menzel, C., Taylor, S., *et al.* (2003). A global analysis of protein expression profiles in *Sinorhizobium meliloti*: Discovery of new genes for nodule occupancy and stress adaptation. *Mol. Plant-Microbe Interact.*, *16*, 508-524.
- Downie, J. A. (1998). Functions of rhizobial nodulation genes. In H. P. Spaink, A. Kondorosi and P. J. J. Hooykaas (Eds.), *The Rhizobiaceae* (pp. 387-402). Dordrecht, The Netherlands: Kluwer Academic Publishers.
- El Yahyaoui, F., Küster, H., Ben Amor, B., Hohnjec, N., Pühler, A., Becker, A., *et al.* (2004). Expression profiling in *Medicago truncatula* identifies more than 750 genes differentially expressed during nodulation, including many potential regulators of the symbiotic program. *Plant Physiol.*, *136*, 3159-3176.
- Ernst, R. K., Yi, E. C., Guo, L., Lim, K. B., Burns, J. L., Hackett, M., and Miller, S. I. (1999). Specific *Pseudomonas aeruginosa* lipopolysaccharide found in cystic fibrosis airway. *Science*, *286*, 1561-1565.
- Escuredo, P. R., Minchin, F. R., Gogorcena, Y., Iturbe-Ormaetxe, I., Klucas, R. V., and Becana, M. (1996). Involvement of activated oxygen in nitrate-induced senescence of pea root nodules. *Plant Physiol.*, *110*, 1187-1195.
- Esseling, J. J., Lhuissier, F. G. P., and Emons, A. M. C. (2003). Nod factor-induced root hair curling: Continuous polar growth towards the point of Nod factor application. *Plant Physiol.*, *132*, 1982-1988.
- Esseling, J. J., Lhuissier, F. G. P., and Emons, A. M. C. (2004). A nonsymbiotic root hair tip growth phenotype in *NORK*-mutated legumes: Implications for nodulation factor-induced signaling and formation of a multifaceted root hair pocket for bacteria. *Plant Cell*, *16*, 933-944.
- Evans, P. J., Gallesi, D., Mathieu, C., Hernandez, M. J., de Felipe, M., Halliwell, B., *et al.* (1999). Oxidative stress occurs during soybean nodule senescence. *Planta*, *208*, 73-79.
- Fang, Y., and Hirsch, A. M. (1998). Studying early nodulin gene *ENOD40* expression and induction by nodulation factor and cytokinin in transgenic alfalfa. *Plant Physiol.*, *116*, 53-68.
- Favery, B., Complainville, A., Vinardell, J. M., Lecomte, P., Vaubert, D., Mergaert, P., *et al.* (2002). The endosymbiosis-induced genes *ENOD40* and *CCS52a* are involved in endoparasitic-nematode interactions in *Medicago truncatula*. *Mol. Plant-Microbe Interact.*, *15*, 1008-1013.
- Fedorova, M., van de Mortel, J., Matsumoto, P. A., Cho, J., Town, C. D., VandenBosch, K. A., *et al.* (2002). Genome-wide identification of nodule-specific transcripts in the model legume *Medicago truncatula*. *Plant Physiol.*, *130*, 519-537.
- Felle, H. H., Kondorosi, E., Kondorosi, A., and Schultze, M. (1998). The role of ion fluxes in Nod factor signalling in *Medicago sativa*. *Plant J.*, *13*, 455-464.
- Felle, H. H., Kondorosi, E., Kondorosi, A., and Schultze, M. (1999). Elevation of the cytosolic free $[Ca^{2+}]$ is indispensable for the transduction of the Nod factor signal in alfalfa. *Plant Physiol.*, *121*, 273-280.

- Ferguson, G. P., Datta, A., Baumgartner, J., Roop, II, R. M., Carlson, R. W., and Walker, G. C. (2004). Similarity to peroxisomal-membrane protein family reveals that *Sinorhizobium* and *Brucella* BacA affect lipid-A fatty acids. *Proc. Natl. Acad. Sci. USA*, *101*, 5012-5017.
- Ferguson, G. P., Datta, A., Carlson, R. W., and Walker, G. C. (2005). Importance of unusually modified lipid A in *Sinorhizobium* stress resistance and legume symbiosis. *Mol. Microbiol.*, *56*, 68-80.
- Ferguson, B. J., Ross, J. J., and Reid, J. B. (2005). Nodulation phenotypes of gibberellin and brassinosteroid mutants of pea. *Plant Physiol.*, *138*, 2396-2405.
- Fernández-López, M., Goormachtig, S., Gao, M., D'Haese, W., Van Montagu, M., and Holsters, M. (1998). Ethylene-mediated phenotypic plasticity in root nodule development on *Sesbania rostrata*. *Proc. Natl. Acad. Sci. USA*, *95*, 12724-12728.
- Flemetakis, E., Kavroulakis, N., Quaedvlieg, N. E. M., Spaink, H. P., Dimou, M., Roussis, A., *et al.* (2000). *Lotus japonicus* contains two distinct ENOD40 genes that are expressed in symbiotic, nonsymbiotic, and embryonic tissues. *Mol. Plant-Microbe Interact.*, *13*, 987-994.
- Forde, B. G., Freeman, J., Oliver, J. E., and Pineda, M. (1990). Nuclear factors interact with conserved A/T-rich elements upstream of a nodule-enhanced glutamine synthetase gene from French bean. *Plant Cell*, *2*, 925-939.
- Foreman, J., Demidchik, V., Bothwell, J. H. F., Mylona, P., Miedema, H., Torres, M. A., *et al.* (2003). Reactive oxygen species produced by NADPH oxidase regulate plant cell growth. *Nature*, *422*, 442-446.
- Foucher, F., and Kondorosi, E. (2000). Cell cycle regulation in the course of nodule organogenesis in *Medicago*. *Plant Mol. Biol.*, *43*, 773-786.
- Friml, J. (2003). Auxin transport - shaping the plant. *Curr. Opin. Plant Biol.*, *6*, 7-12.
- Frugier, F., Poirier, S., Satiat-Jeunemaitre, B., Kondorosi, A., and Crespi, M. (2000). A Krüppel-like zinc finger protein is involved in nitrogen-fixing root nodule organogenesis. *Genes Dev.*, *14*, 475-482.
- Frühling, M., Schroder, G., Hohnjec, N., Pühler, A., Perlick, A. M., and Kuster, H. (2000). The promoter of the *Vicia faba* L. Gene *VjEnod12* encoding an early nodulin is active in cortical cells and nodule primordia of transgenic hairy roots of *Vicia hirsuta* as well as in the prefixing zone II of mature transgenic *V. hirsuta* root nodules. *Plant Sci.*, *160*, 67-75.
- Fu, Y., Gu, Y., Zheng, Z., Wasteneys, G., and Yang, Z. (2005). *Arabidopsis* interdigitating cell growth requires two antagonistic pathways with opposing action on cell morphogenesis. *Cell*, *120*, 687-700.
- Fülöp, K., Tarayre, S., Kelemen, Z., Horváth, G., Kevei, Z., Nikovics, K., *et al.* (2005). *Arabidopsis* Anaphase-Promoting Complexes: Multiple activators and wide range of substrates might keep APC perpetually busy. *Cell Cycle*, *4*, 1084-1092.
- Gage, D. J. (2002). Analysis of infection thread development using Gfp- and DsRed-expressing *Sinorhizobium meliloti*. *J. Bacteriol.*, *184*, 7042-7046.
- Galibert, F., Finan, T. M., Long, S. R., Pühler, A., Abola, P., Ampe, F., *et al.* (2001). The composite genome of the legume symbiont *Sinorhizobium meliloti*. *Science*, *293*, 668-672.
- Gallucci, P., Dedieu, A., Journet, E. P., Huguet, T., and Barker, D. G. (1991). Synchronous expression of leghaemoglobin genes in *Medicago truncatula* during nitrogen-fixing root nodule development and response to exogenously supplied nitrate. *Plant Mol. Biol.*, *17*, 335-349.
- Girard, G., Roussis, A., Gulyaev, A. P., Pleij, C. W. A., and Spaink, H. P. (2003). Structural motifs in the RNA encoded by the early nodulation gene *enod40* of soybean. *Nucleic Acids Res.*, *31*, 5003-5015.
- Glazebrook, J., Ichige, A., and Walker, G. C. (1993). A *Rhizobium meliloti* homolog of the *Escherichia coli* peptide-antibiotic transport protein SbmA is essential for bacteroid development. *Genes Dev.*, *7*, 1485-1497.
- Goedhart, J., Hink, M. A., Visser, A. J. W. G., Bisseling, T., and Gadella, Jr., T. W. J. (2000). *In vivo* fluorescence correlation microscopy (FCM) reveals accumulation and immobilization of Nod factors in root hair cell walls. *Plant J.*, *21*, 109-119.
- Gogorcena, Y., Gordon, A. J., Escuredo, P. R., Minchin, F. R., Witty, J. F., Moran, J. F., *et al.* (1997). N₂ fixation, carbon metabolism, and oxidative damage in nodules of dark-stressed common bean plants. *Plant Physiol.*, *113*, 1193-1201.
- González-Sama, A., Coba de la Peña, T., Kevei, Z., Mergaert, P., Mercedes Lucas, M., de Felipe, M. R., *et al.* (2005). Nuclear DNA endoreduplication and expression of the mitotic inhibitor Ccs52 associated to determinate and lupinoid nodule organogenesis. *Mol. Plant-Microbe Interact.*, *19*, 173-180.

- Goormachtig, S., Capoen, W., James, E. K., and Holsters, M. (2004). Switch from intracellular to intercellular invasion during water stress-tolerant legume nodulation. *Proc. Natl. Acad. Sci. USA*, *101*, 6303-6308.
- Gronlund, M., Gustafsen, C., Roussis, A., Jensen, D., Nielsen, L. P., Marcker, K. A., et al. (2003). The *Lotus japonicus ndx* gene family is involved in nodule function and maintenance. *Plant Mol. Biol.*, *52*, 303-316.
- Guinel, F. C., and Geil, R. D. (2002). A model for the development of the rhizobial and arbuscular symbioses in legumes and its use to understand the roles of ethylene in the establishment of these two symbioses. *Can. J. Bot.*, *80*, 695-720.
- Harper, J. W., Burton, J. L., and Solomon, M. J. (2002). The anaphase-promoting complex: It's not just for mitosis any more. *Genes Dev.*, *16*, 2179-2206.
- Heard, J., and Dunn, K. (1995). Symbiotic induction of a MADS-box gene during development of alfalfa root nodules. *Proc. Natl. Acad. Sci. USA*, *92*, 5273-5277.
- Heidstra, R., Yang, W. C., Yalcin, Y., Peck, S., Emons, A. M., van Kammen, A., et al. (1997). Ethylene provides positional information on cortical cell division but is not involved in Nod factor-induced root hair tip growth in *Rhizobium*-legume interaction. *Development*, *124*, 1781-1787.
- H rouart, D., Baudouin, E., Frendo, P., Harrison, J., Santos, R., Jamet, A., et al. (2002). Reactive oxygen species, nitric oxide and glutathione: A key role in the establishment of the legume-*Rhizobium* symbiosis. *Plant Physiol. Biochem.*, *40*, 619-624.
- Himanen, K., Vuylsteke, M., Vanneste, S., Vercruyse, S., Boucheron, E., Alard, P., et al. (2004). Transcript profiling of early lateral root initiation. *Proc. Natl. Acad. Sci. USA*, *101*, 5146-5151.
- H lskamp, M. (2004). Plant trichomes: A model for cell differentiation. *Nature Rev. Mol. Cell Biol.*, *5*, 471-480.
- Imaizumi-Anraku, H., Kouchi, H., Syono, K., Akao, S., and Kawaguchi, M. (2000). Analysis of *ENOD40* expression in *abl1*, a symbiotic mutant of *Lotus japonicus* that forms empty nodules with incompletely developed nodule vascular bundles. *Mol. Gen. Genet.*, *264*, 402-410.
- Jacobs, M., and Rubery, P. H. (1988). Naturally occurring auxin transport regulators. *Science*, *241*, 346-349.
- Jacobsen, K., Laursen, N. B., Jensen, E.  ., Marcker, A., Poulsen, C., and Marcker, K. A. (1990). HMG I-like proteins from leaf and nodule nuclei interact with different AT motifs in soybean nodulin promoters. *Plant Cell*, *2*, 85-94.
- Jensen, E.  ., Marcker, K. A., Schell, J., and de Bruijn, F. J. (1988). Interaction of a nodule specific, *trans*-acting factor with distinct DNA elements in the soybean leghaemoglobin *lbc₃* 5' upstream region. *EMBO J.*, *7*, 1265-1271.
- Jim nez-Zurdo, J. I., Frugier, F., Crespi, M. D., and Kondorosi, A. (2000). Expression profiles of 22 novel molecular markers for organogenetic pathways acting in alfalfa nodule development. *Mol. Plant-Microbe Interact.*, *13*, 96-106.
- Joub s, J., and Chevalier, C. (2000). Endoreduplication in higher plants. *Plant Mol. Biol.*, *43*, 735-745.
- Kahn, M. L., McDermott, T. R., and Udvardi, M. K. (1998). Carbon and nitrogen metabolism in the Rhizobiaceae. In H. P. Spaink, A. Kondorosi and P. J. J. Hooykaas (Eds.), *The Rhizobiaceae* (pp. 461-465). Dordrecht, The Netherlands: Kluwer Academic Publishers.
- Kakimoto, T. (2003). Perception and signal transduction of cytokinins. *Annu. Rev. Plant Biol.*, *54*, 605-627.
- Kaminski, P. A., Batut, J., and Boistard, P. (1998). A survey of symbiotic nitrogen fixation by rhizobia. In H. P. Spaink, A. Kondorosi and P. J. J. Hooykaas (Eds.), *The Rhizobiaceae* (pp. 431-460). Dordrecht, The Netherlands: Kluwer Academic Publishers.
- Kaneko, T., Nakamura, Y., Sato, S., Asamizu, E., Kato, T., Sasamoto, S., et al. (2000). Complete genome structure of the nitrogen-fixing symbiotic bacterium *Mesorhizobium loti*. *DNA Res.*, *7*, 331-338.
- Kannenbergh, E. L., and Carlson, R. W. (2001). Lipid A and O-chain modifications cause *Rhizobium* lipopolysaccharides to become hydrophobic during bacteroid development. *Mol. Microbiol.*, *39*, 379-391.
- Kepinski, S., and Leyser, O. (2002). Ubiquitination and auxin signaling: A degrading story. *Plant Cell*, *14 Suppl*, S81-S95.
- Kepinski, S., and Leyser, O. (2005). The *Arabidopsis* F-box protein TIR1 is an auxin receptor. *Nature*, *435*, 446-451.
- Kiers, E. T., Rousseau, R. A., West, S. A., and Denison, R. F. (2003). Host sanctions and the legume-*Rhizobium* mutualism. *Nature*, *425*, 78-81.

- Koltai, H., Dhandaydham, M., Opperman, C., Thomas, J., and Bird, D. (2001). Overlapping plant signal transduction pathways induced by a parasitic nematode and a rhizobial endosymbiont. *Mol. Plant-Microbe Interact.*, *14*, 1168-1177.
- Kondorosi, E., and Kondorosi, A. (2004). Endoreduplication and activation of the anaphase-promoting complex during symbiotic cell development. *FEBS Lett.*, *567*, 152-157.
- Kondorosi, E., Redondo-Nieto, M., and Kondorosi, A. (2005) Ubiquitin-mediated proteolysis: To be in the right place at the right moment during nodule development. *Plant Physiol.*, *137*, 1197-1204.
- Kondorosi, E., Roudier, F., and Gendreau, E. (2000). Plant cell-size control: Growing by ploidy? *Curr. Opin. Plant Biol.*, *3*, 488-492.
- Kost, B., Lemichez, E., Spielhofer, P., Hong, Y., Tolias, K., Carpenter, C., and Chua, N. H. (1999). Rac homologues and compartmentalized phosphatidylinositol 4,5-bisphosphate act in a common pathway to regulate polar pollen tube growth. *J. Cell Biol.*, *145*, 317-330.
- Kouchi, H., and Hata, S. (1993). Isolation and characterization of novel nodulin cDNAs representing genes expressed at early stages of soybean nodule development. *Mol. Gen. Genet.*, *238*, 106-119.
- Kouchi, H., Takane, K., So, R. B., Ladha, J. K., and Reddy, P. M. (1999). Rice *ENOD40*: Isolation and expression analysis in rice and transgenic soybean root nodules. *Plant J.*, *18*, 121-129.
- Larkins, B. A., Dilkes, B. P., Dante, R. A., Coelho, C. M., Woo, Y. M., and Liu, Y. (2001). Investigating the hows and whys of DNA endoreduplication. *J. Exp. Bot.*, *52*, 183-192.
- Lee, K. H., and LaRue, T. A. (1992). Exogenous ethylene inhibits nodulation of *Pisum sativum* L. cv Sparkle. *Plant Physiol.*, *100*, 1759-1763.
- LeVier, K., Phillips, R. W., Grippe, V. K., Roop, II, R. M., and Walker, G. C. (2000). Similar requirements of a plant symbiont and a mammalian pathogen for prolonged intracellular survival. *Science*, *287*, 2492-2493.
- Levine, A., Tenhaken, R., Dixon, R., and Lamb, C. (1994). H₂O₂ from the oxidative burst orchestrates the plant hypersensitive disease resistance response. *Cell*, *79*, 583-593.
- Lievens, S., Goormachtig, S., Den Herder, J., Capoen, W., Mathis, R., Hedden, P., et al. (2005). Gibberellins are involved in nodulation of *Sesbania rostrata*. *Plant Physiol.*, *139*, 1366-1379.
- Liger, F., Caba, J. M., Lluch, C., and Olivares, J. (1991). Nitrate inhibition of nodulation can be overcome by the ethylene inhibitor aminoethoxyvinylglycine. *Plant Physiol.*, *97*, 1221-1225.
- Limpens, E., Franken, C., Smit, P., Willemsse, J., Bisseling, T., and Geurts, R. (2003). LysM domain receptor kinases regulating rhizobial Nod factor-induced infection. *Science*, *302*, 630-633.
- Limpens, E., Mirabella, R., Fedorova, E., Franken, C., Franssen, H., Bisseling, T., and Geurts, R. (2005). Formation of organelle-like N₂-fixing symbiosomes in legume root nodules is controlled by *DMI2*. *Proc. Natl. Acad. Sci. USA*, *102*, 10375-10380.
- Lohar, D. P., Schaff, J. E., Laskey, J. G., Kieber, J. J., Bilyeu, K. D., and Bird, D. M. (2004). Cytokinins play opposite roles in lateral root formation, and nematode and rhizobial symbioses. *Plant J.*, *38*, 203-214.
- Long, S. R. (1996). *Rhizobium* symbiosis: Nod factors in perspective. *Plant Cell*, *8*, 1885-1898.
- Madsen, E. B., Madsen, L. H., Radutoiu, S., Olbryt, M., Rakwalska, M., Szczygłowski, K., et al. (2003). A receptor kinase gene of the LysM type is involved in legume perception of rhizobial signals. *Nature*, *425*, 637-640.
- Matamoros, M. A., Baird, L. M., Escuredo, P. R., Dalton, D. A., Minchin, F. R., Iturbe-Ormaetxe, I., et al. (1999). Stress-induced legume root nodule senescence. Physiological, biochemical, and structural alterations. *Plant Physiol.*, *121*, 97-112.
- Mathesius, U., Schlaman, H. R. M., Spaink, H. P., Sautter, C., Rolfe, B. G., and Djordjevic, M. A. (1998a). Auxin transport inhibition precedes root nodule formation in white clover roots and is regulated by flavonoids and derivatives of chitin oligosaccharides. *Plant J.*, *14*, 23-34.
- Mathesius, U., Bayliss, C., Weinman, J. J., Schlaman, H. R. M., Spaink, H. P., Rolfe, B. G., et al. (1998b). Flavonoids synthesized in cortical cells during nodulation initiation are early developmental markers in white clover. *Mol. Plant-Microbe Interact.*, *11*, 1223-1232.
- Mathesius, U., Charon, C., Rolfe, B. G., Kondorosi, A., and Crespi, M. (2000). Temporal and spatial order of events during the induction of cortical cell divisions in white clover by *Rhizobium leguminosarum* bv. *trifolii* inoculation or localized cytokinin addition. *Mol. Plant-Microbe Interact.*, *13*, 617-628.
- McRae, D. G., Miller, R. W., and Berndt, W. B. (1989). Viability of alfalfa nodule bacteroids isolated by density gradient centrifugation. *Symbiosis*, *7*, 67-80.

- Mergaert, P., Van Montagu, M., and Holsters, M. (1997). Molecular mechanisms of Nod factor diversity. *Mol. Microbiol.*, *25*, 811-817.
- Mergaert, P., Nikovics, K., Kelemen, Z., Maunoury, N., Vaubert, D., Kondorosi, A., *et al.* (2003). A novel family in *Medicago truncatula* consisting of more than 300 nodule-specific genes coding for small, secreted polypeptides with conserved cysteine motifs. *Plant Physiol.*, *132*, 161-173.
- Mergaert, P., Uchiyumi, T., Alunni, B., Evanno, G., Cheron, A., Catrice, O., *et al.* (2006). Eukaryotic control on bacterial cell cycle and differentiation in *Rhizobium*-legume symbiosis. *Proc. Natl. Acad. Sci. USA*, *103*, 5230-5235.
- Metz, B. A., Welters, P., Hoffmann, H. J., Jensen, E. Ø., Schell, J., and de Bruijn, F. J. (1988). Primary structure and promoter analysis of leghemoglobin genes of the stem-nodulated tropical legume *Sesbania rostrata*: Conserved coding sequences, cis-elements and trans-acting factors. *Mol. Gen. Genet.*, *214*, 181-191.
- Miller, D. D., de Ruijter, N. C. A., and Emons, A. M. C. (1997). From signal to form: Aspects of the cytoskeleton-plasma membrane-cell wall continuum in root hair tips. *J. Exp. Bot.*, *48*, 1881-1896.
- Miller, D. D., de Ruijter, N. C. A., Bisseling, T., and Emons, A. M. C. (1999). The role of actin in root hair morphogenesis: Studies with lipochito-oligosaccharide as a growth stimulator and cytochalasin as an actin perturbing drug. *Plant J.*, *17*, 141-154.
- Müller, J., Wiemken, A., and Boller, T. (2001). Redifferentiation of bacteria isolated from *Lotus japonicus* root nodules colonized by *Rhizobium* sp. NGR234. *J. Exp. Bot.*, *52*, 2181-2186.
- Naito, Y., Fujie, M., Usami, S., Murooka, Y., and Yamada, T. (2000). The involvement of a cysteine proteinase in the nodule development in Chinese milk vetch infected with *Mesorhizobium huakuii* subsp. *rengelii*. *Plant Physiol.*, *124*, 1087-1096.
- Natera, S. H. A., Guerreiro, N., and Djordjevic, M. A. (2000). Proteome analysis of differentially displayed proteins as a tool for the investigation of symbiosis. *Mol. Plant-Microbe Interact.*, *13*, 995-1009.
- Niehaus, K., Lagares, A., and Pühler, A. (1998). A *Sinorhizobium meliloti* lipopolysaccharide mutant induces effective nodules on the host plant *Medicago sativa* (alfalfa) but fails to establish a symbiosis with *Medicago truncatula*. *Mol. Plant-Microbe Interact.*, *11*, 906-914.
- Nukui, N., Ezura, H., and Minamisawa, K. (2004). Transgenic *Lotus japonicus* with an ethylene receptor gene *Cm-ERS1/H70A* enhances formation of infection threads and nodule primordia. *Plant Cell Physiol.*, *45*, 427-435.
- Oldroyd, G. E., Engstrom, E. M., and Long, S. R. (2001). Ethylene inhibits the Nod factor signal transduction pathway of *Medicago truncatula*. *Plant Cell*, *13*, 1835-1849.
- Pacios-Bras, C., Schlaman, H. R., Boot, K., Admiraal, P., Langerak, J. M., Stougaard, J., *et al.* (2003). Auxin distribution in *Lotus japonicus* during root nodule development. *Plant Mol. Biol.*, *52*, 1169-1180.
- Panter, S., Thomson, R., de Bruxelles, G., Laver, D., Trevaskis, B., and Udvardi, M. (2000). Identification with proteomics of novel proteins associated with the peribacteroid membrane of soybean root nodules. *Mol. Plant-Microbe Interact.*, *13*, 325-333.
- Papadopoulou, K., Roussis, A., and Katinakis, P. (1996). *Phaseolus* ENOD40 is involved in symbiotic and non-symbiotic organogenetic processes: Expression during nodule and lateral root development. *Plant Mol. Biol.*, *30*, 403-417.
- Pellock, B. J., Cheng, H.-P., and Walker, G. C. (2000). Alfalfa root nodule invasion efficiency is dependent on *Sinorhizobium meliloti* polysaccharides. *J. Bacteriol.*, *182*, 4310-4318.
- Penmetsa, R. V., and Cook, D. R. (1997). A legume ethylene-insensitive mutant hyperinfected by its rhizobial symbiont. *Science*, *275*, 527-530.
- Penmetsa, R. V., Frugoli, J. A., Smith, L. S., Long, S. R., and Cook, D. R. (2003). Dual genetic pathways controlling nodule number in *Medicago truncatula*. *Plant Physiol.*, *131*, 998-1008.
- Peters, N. K., and Crist-Estes, D. K. (1989). Nodule formation is stimulated by the ethylene inhibitor aminoethoxyvinylglycine. *Plant Physiol.*, *91*, 690-693.
- Pladys, D., and Vance, C. P. (1993). Proteolysis during development and senescence of effective and plant gene-controlled ineffective alfalfa nodules. *Plant Physiol.*, *103*, 379-384.
- Puppo, A., Groten, K., Bastian, F., Carzaniga, R., Soussi, M., Lucas, M. M., *et al.* (2005). Legume nodule senescence: Roles for redox and hormone signalling in the orchestration of the natural aging process. *New Phytol.*, *165*, 683-701.

- Radutoiu, S., Madsen, L. H., Madsen, E. B., Felle, H. H., Umehara, Y., Grönlund, M., *et al.* (2003). Plant recognition of symbiotic bacteria requires two LysM receptor-like kinases. *Nature*, *425*, 585-592.
- Ramu, S. K., Peng, H. M., and Cook, D. R. (2002). Nod factor induction of reactive oxygen species production is correlated with expression of the early nodulin gene *rip1* in *Medicago truncatula*. *Mol. Plant-Microbe Interact.*, *15*, 522-528.
- Rashotte, A. M., Carson, S. D. B., To, J. P. C., and Kieber, J. J. (2003). Expression profiling of cytokinin action in *Arabidopsis*. *Plant Physiol.*, *132*, 1998-2011.
- Reichheld, J.-P., Vernoux, T., Lardon, F., Van Montagu, M., and Inzé, D. (1999). Specific checkpoints regulate plant cell cycle progression in response to oxidative stress. *Plant J.*, *17*, 647-656.
- Rodríguez-Llorente, I. D., Pérez-Hormaeche, J., El Mounadi, K., Dary, M., Caviedes, M. A., Cosson, V., *et al.* (2004). From pollen tubes to infection threads: Recruitment of *Medicago* floral pectic genes for symbiosis. *Plant J.*, *39*, 587-598.
- Röhrig, H., Schmidt, J., Miklashevichs, E., Schell, J., and John, M. (2002). Soybean *ENOD40* encodes two peptides that bind to sucrose synthase. *Proc. Natl. Acad. Sci. USA*, *99*, 1915-1920.
- Rosenberger, C. M., Gallo, R. L., and Finlay, B. B. (2004). Interplay between antibacterial effectors: A macrophage antimicrobial peptide impairs intracellular *Salmonella* replication. *Proc. Natl. Acad. Sci. USA*, *101*, 2422-2427.
- Roudier, F., Fedorova, E., Györgyey, J., Feher, A., Brown, S., Kondorosi, A., *et al.* (2000). Cell cycle function of a *Medicago sativa* A2-type cyclin interacting with a PSTAIRE-type cyclin-dependent kinase and a retinoblastoma protein. *Plant J.*, *23*, 73-83.
- Roudier, F., Fedorova, E., Lebris, M., Lecomte, P., Györgyey, J., Vaubert, D., *et al.* (2003). The *Medicago* species A2-type cyclin is auxin regulated and involved in meristem formation but dispensable for endoreduplication-associated developmental programs. *Plant Physiol.*, *131*, 1091-1103.
- Sandal, N. N., Bojsen, K., and Marcker, K. A. (1987). A small family of nodule specific genes from soybean. *Nucleic Acids Res.*, *15*, 1507-1519.
- Santi, C., von Groll, U., Ribeiro, A., Chiurazzi, M., Auguy, F., Bogusz, D., *et al.* (2003). Comparison of nodule induction in legume and actinorhizal symbioses: the induction of actinorhizal nodules does not involve *ENOD40*. *Mol. Plant-Microbe Interact.*, *16*, 808-816.
- Savouré, A., Magyar, Z., Pierre, M., Brown, S., Schultze, M., Dudits, D., *et al.* (1994). Activation of the cell cycle machinery and the isoflavonoid biosynthesis pathway by active *Rhizobium meliloti* Nod signal molecules in *Medicago microcallus* suspensions. *EMBO J.*, *13*, 1093-1102.
- Schmidt, J. S., Harper, J. E., Hoffman, T. K., and Bent, A. F. (1999). Regulation of soybean nodulation independent of ethylene signaling. *Plant Physiol.*, *119*, 951-960.
- Schnabel, E. L., and Frugoli, J. (2004). The *PIN* and *LAX* families of auxin transport genes in *Medicago truncatula*. *Mol. Gen. Genomics*, *272*, 420-432.
- Schultze, M., and Kondorosi, A. (1995). What makes nodulation signals host-plant specific? *Trends Microbiol.* *3*, 370-372.
- Sen, D., Weaver, R. W., and Bal, A. K. (1986). Structure and organization of effective peanut and cowpea root nodules induced by rhizobial strain 32H1. *J. Exp. Bot.*, *37*, 356-363.
- Shaw, S. L., and Long, S. R. (2003). Nod factor elicits two separable calcium responses in *Medicago truncatula* root hair cells. *Plant Physiol.*, *131*, 976-984.
- Shimoda, Y., Nagata, M., Suzuki, A., Abe, M., Sato, S., Kato, T., *et al.* (2005). Symbiotic *Rhizobium* and nitric oxide induce gene expression of non-symbiotic hemoglobin in *Lotus japonicus*. *Plant Cell Physiol.*, *46*, 99-107.
- Soni, R., Carmichael, J. P., Shah, Z. H., and Murray, J. A. H. (1995). A family of cyclin D homologs from plants differentially controlled by growth regulators and containing the conserved retinoblastoma protein interaction motif. *Plant Cell*, *7*, 85-103.
- Soupène, E., Foussard, M., Boistard, P., Truchet, G., and Batut, J. (1995). Oxygen as a key developmental regulator of *Rhizobium meliloti* N₂-fixation gene expression within the alfalfa root nodule. *Proc. Natl. Acad. Sci. USA*, *92*, 3759-3763.
- Sousa, C., Johansson, C., Charon, C., Manyani, H., Sautter, C., Kondorosi, A., *et al.* (2001). Translational and structural requirements of the early nodulin gene *enod40*, a short-open reading frame-containing RNA, for elicitation of a cell-specific growth response in the alfalfa root cortex. *Mol. Cell Biol.*, *21*, 354-366.
- Spaink, H. P. (1994). The molecular basis of the host specificity of the *Rhizobium* bacteria. *Antonie Van Leeuwenhoek*, *65*, 81-98.

- Sprent, J. I., Sutherland, J. M., and de Faria, S. M. (1987). Some aspects of the biology of nitrogen-fixing organisms. *Phil. Trans. Roy. Soc. Lond. B*, 317, 111-129.
- Stachelin, C., Charon, C., Boller, T., Crespi, M., and Kondorosi, A. (2001). *Medicago truncatula* plants overexpressing the early nodulin gene *enod40* exhibit accelerated mycorrhizal colonization and enhanced formation of arbuscules. *Proc. Natl. Acad. Sci. USA*, 98, 15366-15371.
- Stals, H., and Inzé, D. (2001). When plant cells decide to divide. *Trends Plant Sci.*, 6, 359-364.
- Stougaard, J., Sandal, N. N., Grøn, A., Kühle, A., and Marcker, K. A. (1987). 5'-Analysis of the soybean leghemoglobin *lbc₃* gene: Regulatory elements required for promoter activity and organ specificity. *EMBO J.*, 6, 3565-3569.
- Stougaard, J., Jørgensen, J.-E., Christensen, T., Kühle, A., and Marcker, K. A. (1990). Interdependence and nodule specificity of *cis*-acting regulatory elements in the soybean leghemoglobin *lbc₃* and N23 gene promoters. *Mol. Gen. Genet.*, 220, 353-360.
- Suganuma, N., Tamaoki, M., and Kouchi, H. (1995). Expression of nodulin genes in plant-determined ineffective nodules of pea. *Plant Mol. Biol.*, 28, 1027-1038.
- Sugimoto-Shirasu, K., and Roberts, K. (2003). "Big it up": Endoreduplication and cell-size control in plants. *Curr. Opin. Plant Biol.*, 6, 544-553.
- Sutton, W. D., and Paterson, A. D. (1983). Further evidence for a host plant effect on *Rhizobium* bacteroid viability. *Plant Sci. Lett.*, 30, 33-41.
- Swarup, R., and Bennett, M. (2003). Auxin transport: The fountain of life in plants? *Dev. Cell*, 5, 824-826.
- Szabados, L., Ratet, P., Grunenberg, B., and de Bruijn, F. J. (1990). Functional analysis of the *Sesbania rostrata* leghemoglobin *glb3* gene 5'-upstream region in transgenic *Lotus corniculatus* and *Nicotiana tabacum* plants. *Plant Cell*, 2, 973-986.
- Szczygłowski, K., Shaw, R. S., Wopereis, J., Copeland, S., Hamburger, D., Kasiborski, B., et al. (1998). Nodule organogenesis and symbiotic mutants of the model legume *Lotus japonicus*. *Mol. Plant-Microbe Interact.*, 11, 684-697.
- Tansengco, M. L., Hayashi, M., Kawaguchi, M., Imaizumi-Anraku, H., and Murooka, Y. (2003). *Crinkle*, a novel symbiotic mutant that affects the infection thread growth and alters the root hair, trichome, and seed development in *Lotus japonicus*. *Plant Physiol.*, 131, 1054-1063.
- Tansengco, M. L., Imaizumi-Anraku, H., Yoshikawa, M., Takagi, S., Kawaguchi, M., Hayashi, M., et al. (2004). Pollen development and tube growth are affected in the symbiotic mutant of *Lotus japonicus*, *crinkle*. *Plant Cell Physiol.*, 45, 511-520.
- Tarayre, S., Vinardell, J. M., Cebolla, A., Kondorosi, A., and Kondorosi, E. (2004). Two classes of the Cdh1-type activators of the anaphase-promoting complex in plants: Novel functional domains and distinct regulation. *Plant Cell*, 16, 422-434.
- Timmers, A. C. J., Auriac, M. C., and Truchet, G. (1999). Refined analysis of early symbiotic steps of the *Rhizobium-Medicago* interaction in relationship with microtubular cytoskeleton rearrangements. *Development*, 126, 3617-3628.
- Timmers, A. C. J., Soupène, E., Auriac, M. C., de Billy, F., Vasse, J., Boistard, P., et al. (2000). Saprophytic intracellular rhizobia in alfalfa nodules. *Mol. Plant-Microbe Interact.*, 13, 1204-1213.
- Trepp, G. B., van de Mortel, M., Yoshioka, H., Miller, S. S., Samac, D. A., Gantt, J. S., et al. (1999). NADH-glutamate synthase in alfalfa root nodules. Genetic regulation and cellular expression. *Plant Physiol.*, 119, 817-828.
- Truchet, G. (1978). Sur l'état diploïde des cellules du méristème des nodules radiculaires des légumineuses. *Ann. Sci. Nat., Bot., Paris*, 19, 3-38.
- Truchet, G., Roche, P., Lerouge, P., Vasse, J., Camut, S., de Billy, F., et al. (1990). Sulphated lipooligosaccharide signals of *Rhizobium meliloti* elicit root nodule organogenesis in alfalfa. *Nature*, 351, 670-673.
- Udvardi, M. K., and Day, D. A. (1997). Metabolite transport across symbiotic membranes of legume nodules. *Annu. Rev. Plant Physiol. Plant Mol. Biol.*, 48, 493-523.
- van Batenburg, F. H. D., Jonker, R., and Kijne, J. W. (1986). *Rhizobium* induces marked root hair curling by redirection of tip growth: a computer simulation. *Physiol. Plant.*, 66, 476-480.
- van Brussel, A. A. N., Bakhuizen, R., van Spronsen, P. C., Spaik, H. P., Tak, T., Lugtenberg, B. J. J., et al. (1992). Induction of pre-infection thread structures in the leguminous host plant by mitogenic lipo-oligosaccharides of *Rhizobium*. *Science*, 257, 70-72.

- van de Sande, K., Pawlowski, K., Czaja, I., Wieneke, U., Schell, J., Schmidt, J., *et al.* (1996). Modification of phytohormone response by a peptide encoded by *ENOD40* of legumes and a nonlegume. *Science*, *273*, 370-373.
- Van de Velde, W., Pérez Guerra, J.C., De Keyser, A., De Rycke, R., Maunoury, N., Mergaert, P., *et al.* (2006). Aging in legume symbiosis: a molecular view on nodule senescence in *Medicago truncatula*. *Plant Physiol.*, *141*, 711-720.
- van Rhijn, P., Fang, Y., Galili, S., Shaul, O., Atzmon, N., Wininger, S., *et al.* (1997). Expression of early nodulin genes in alfalfa mycorrhizae indicates that signal transduction pathways used in forming arbuscular mycorrhizae and *Rhizobium*-induced nodules may be conserved. *Proc. Natl. Acad. Sci. USA*, *94*, 5467-5472.
- van Spronsen, P. C., Bakhuizen, R., van Brussel, A. A., and Kijne, J. W. (1994). Cell wall degradation during infection thread formation by the root nodule bacterium *Rhizobium leguminosarum* is a two-step process. *Eur. J. Cell Biol.*, *64*, 88-94.
- van Spronsen, P. C., van Brussel, A. A., and Kijne, J. W. (1995). Nod factors produced by *Rhizobium leguminosarum* biovar *viciae* induce ethylene-related changes in root cortical cells of *Vicia sativa* ssp. *nigra*. *Eur. J. Cell Biol.*, *68*, 463-469.
- van Spronsen, P. C., Grønlund, M., Pacios Bras, C., Spaink, H. P., and Kijne, J. W. (2001). Cell biological changes of outer cortical root cells in early determinate nodulation. *Mol. Plant-Microbe Interact.*, *14*, 839-847.
- Vance, C. P., Heichel, G. H., Barnes, D. K., Bryan, J. W., and Johnson, L. E. (1979). Nitrogen fixation, nodule development, and vegetative regrowth of alfalfa (*Medicago sativa* L.) following harvest. *Plant Physiol.*, *64*, 1-8.
- VandenBosch, K. A., and Stacey G. (2003). Summaries of legume genomics projects from around the globe. Community resources for crops and models. *Plant Physiol.*, *131*, 840-865.
- Varkonyi-Gasic, E., and White, D. W. R. (2002). The white clover *enod40* gene family. Expression patterns of two types of genes indicate a role in vascular function. *Plant Physiol.*, *129*, 1107-1118.
- Vasse, J., de Billy, F., Camut, S., and Truchet, G. (1990). Correlation between ultrastructural differentiation of bacteroids and nitrogen fixation in alfalfa nodules. *J. Bacteriol.*, *172*, 4295-4306.
- Vedam, V., Haynes, J. G., Kannenberg, E. L., Carlson, R. W., and Sherrier, D. J. (2004). A *Rhizobium leguminosarum* lipopolysaccharide lipid-A mutant induces nitrogen-fixing nodules with delayed and defective bacteroid formation. *Mol. Plant-Microbe Interact.*, *17*, 283-291.
- Verma, D. P., and Hong, Z. (1996). Biogenesis of the peribacteroid membrane in root nodules. *Trends Microbiol.*, *4*, 364-368.
- Vinardell, J. M., Fedorova, E., Cebolla, A., Kevei, Z., Horvath, G., Kelemen, Z., *et al.* (2003). Endoreduplication mediated by the anaphase-promoting complex activator CCS52A is required for symbiotic cell differentiation in *Medicago truncatula* nodules. *Plant Cell*, *15*, 2093-2105.
- Wexler, M., Gordon, D., and Murphy, P. J. (1995). The distribution of inositol rhizopine genes in *Rhizobium* populations. *Soil Biol. Biochem.*, *27*, 531-537.
- Whitehead, L. F., and Day, D. A. (1997). The peribacteroid membrane. *Physiol. Plant.*, *100*, 30-44.
- Wienkoop, S., and Saalbach, G. (2003). Proteome analysis. Novel proteins identified at the peribacteroid membrane from *Lotus japonicus* root nodules. *Plant Physiol.*, *131*, 1080-1090.
- Yang, W. C., Katinakis, P., Hendriks, P., Smolders, A., de Vries, F., Spee, J., *et al.* (1993). Characterization of *GmENOD40*, a gene showing novel patterns of cell-specific expression during soybean nodule development. *Plant J.*, *3*, 573-585.
- Yang, W. C., de Blank, C., Meskiene, I., Hirt, H., Bakker, J., van Kammen, A., *et al.* (1994). *Rhizobium* Nod factors reactivate the cell cycle during infection and nodule primordium formation, but the cycle is only completed in primordium formation. *Plant Cell*, *6*, 1415-1426.
- Yang, Z. (2002). Small GTPases: Versatile signaling switches in plants. *Plant Cell*, *14*, S375-S388.
- Zaat, S. A. J., Van Brussel, A. A. N., Tak, T., Lugtenberg, B. J. J. and Kijne, J. W. (1989). The ethylene-inhibitor aminoethoxyvinylglycine restores normal nodulation by *Rhizobium leguminosarum* biovar *viciae* on *Vicia sativa* subsp. *nigra* by suppressing the 'thick and short roots' phenotype. *Planta*, *177*, 141-150.
- Zhang, K., Letham, D. S., and John, P. C. (1996). Cytokinin controls the cell cycle at mitosis by stimulating the tyrosine dephosphorylation and activation of p34 cdc2-like H1 histone kinase. *Planta*, *200*, 2-12.

Chapter 7

GENETICS: A WAY TO UNRAVEL MOLECULAR MECHANISMS CONTROLLING THE RHIZOBIAL-LEGUME SYMBIOSIS

P. SMIT AND T. BISSELING

*Wageningen University and Research Center,
Department of Plant Sciences, Laboratory of Molecular Biology,
6703HA Wageningen, The Netherlands*

1. INTRODUCTION

The interaction of *Rhizobium* bacteria and legumes results in the formation of N₂-fixing root nodules, a process requiring the bacteria to be allowed to enter (infect) the root in a manner that is strictly controlled by the host. Further, already differentiated cortical cells have to be reactivated and enter the cell cycle from their arrested state, so that a nodule primordium is formed. Release of the bacteria into cells of the primordium results in its differentiation into a nodule (Gage, 2004; Oldroyd and Downie, 2004).

The infection process as well as the induction of cortical cell divisions is caused by Nod factors that are secreted by rhizobia when they colonize the roots of their host. Nod factors of all studied rhizobia are composed of a β -1,4-linked N-acetyl-D-glucosamine backbone of 3-6 subunits. The non-reducing terminal sugar moiety is substituted with a fatty acid, the structure of which varies between different rhizobial species. Further, various substitutions can be present on the terminal sugar residues, both on the reducing as well as the non-reducing end of the backbone. These substitutions determine the biological activity of a Nod factor, *i.e.*, which responses can be induced in the host as well as host specificity (D'Haeze and Holsters, 2002; Gage, 2004; Oldroyd and Downie, 2004; Perret *et al.*, 2000).

In legumes, like pea, *Medicago truncatula* (*Medicago*) and *Lotus japonicus* (*Lotus*), the infection process starts in epidermal root-hair cells (Brewin, 2004).

Nod factor-secreting rhizobia induce deformations in most of the root hairs in a region of the root that is susceptible to the interaction (Heidstra *et al.*, 1994), although only a few root hairs form a tight curl in which rhizobia become entrapped. This curling is most likely the result of a continuous redirection of the growth direction towards a bacterium that is attached to the root hair (Esseling *et al.*, 2003; Van Batenburg *et al.*, 1986). In this way, the bacterium becomes entrapped within a three-dimensional cavity formed by the curl and a small colony of rhizobia is formed. Subsequently, these rhizobia induce local weakening of the cell wall and, by invagination of the plasma membrane of the root hair, a tube-like structure is formed. This is the so-called infection thread that allows the rhizobia to penetrate the root-hair cell. Each root (cortical) cell that has to be traversed makes an infection thread and ultimately the rhizobia reach the nodule primordium (Brewin, 2004). Here, they are taken up in the nodule primordium cells in an endocytosis-like manner forming organelle-like structures (symbiosomes) that contain one or more bacteria, which upon differentiation start to fix nitrogen (Brewin, 2004).

The host tightly controls the various steps of infection and nodule-primordium formation that lead to a N₂-fixing root nodule. Certain plant genes must, therefore, have an important role in the regulation of these steps. This is underlined by the identification of legume mutants that become arrested at a specific stage of the interaction (Tsyganov *et al.*, 2002). Although several such mutants were made in the 1970s in, for example, pea, clover, and soybean, the mutated genes could not be cloned due to the lack of efficient molecular-genetic approaches. During the 1980s and 1990s, most of the research on plant genes involved in this symbiosis focused on genes expressed at markedly elevated levels during some step(s) of this interaction. These were named nodulin genes (Van Kammen, 1984). However, none of the identified nodulin genes turned out to be key regulators identified by the genetic approaches. In the last couple of years, several of the genetically identified symbiotic genes have been cloned (Geurts *et al.*, 2005; Oldroyd and Downie, 2004), facilitated by the development of model systems (*Medicago* and *Lotus*) for which efficient molecular-genetic tools became available. Several genes have now been cloned from these two model systems, which has also facilitated the cloning of orthologous genes from important crops, like pea and soybean (Ané *et al.*, 2004; Borisov *et al.*, 2003; Kalo *et al.*, 2005; Krusell *et al.*, 2002; Levy *et al.*, 2004; Limpens *et al.*, 2003; Madsen *et al.*, 2003; Mitra *et al.*, 2004a; Searle *et al.*, 2003; Stracke *et al.*, 2002). Most of the genes that have been cloned during the last few years are involved in epidermal Nod factor-signal transduction or autoregulation of nodule number. Therefore, we will focus on these two processes in this chapter, after the model legumes have been introduced.

2. MODEL LEGUMES

To facilitate molecular-genetic studies in legumes, two model systems have been developed, namely *Medicago* and *Lotus* (Oldroyd and Geurts, 2001; Udvardi *et al.*, 2005). Both species have all the characteristics essential for model plant species,

including a relative short generation time, a small diploid genome, self-pollination, sufficient polymorphism within different accessions, and efficient transformation. Both species belong to the Papilionoideae sub-family and are relatively closely related, but are different in their symbiotic properties. *Medicago* nodules have a persistent meristem that supports an indeterminate growth, whereas *Lotus* makes determinate nodules in which the meristematic activity ceases at an early stage of development. *Medicago* belongs to the vicioid clade, which contains important crop legumes, like alfalfa, lentil, pea, faba bean, and clover. In contrast, *Lotus* is in the tribe *Loteae*, clade Robineae, which is phylogenetically distinct from two major clades, the vicioid and phaseoloid clades. These last two clades contain most of the major legume crops with the notable exceptions of *Arachis* and *Lupinus*, which belong to the dalbergioid and genistoid clades, respectively (Lewis *et al.*, 2005). Both *Arachis* and *Lupinus* have infection and nodule-development processes quite different from those discussed here (see Chapter 1 of this volume for more details).

2.1. Genome Sequencing

The *Lotus* and *Medicago* genomes are both about 500 Mbp divided over six (*Lotus*) and eight (*Medicago*) chromosomes. Their genomes are about four-times larger than that of *Arabidopsis* and similar in size to that of rice (*Oryza sativa*). Both legume genomes are organized similarly to that of *Arabidopsis*. More is known about the *Medicago* genome, in which seven chromosomes contain heterochromatin blocks only around the centromere (the so-called pericentromeric regions), whereas the distal parts of the arms are euchromatic. Only *Medicago* chromosome six displays a more complex organization with several heterochromatic regions along both chromosome arms (Kulikova *et al.*, 2001; 2004).

The size of the gene-rich part of the *Medicago* genome (the euchromatic chromosome arms) has been estimated to be 230-270 Mbp. Because *Medicago* should function as a reference for related crop species, a solid BAC-by-BAC approach has been chosen to sequence these gene-rich areas. It is anticipated that this project will be completed by the end of 2007 and should allow an integration of the *Medicago* genome sequence with the genetic and cytogenetic maps of *Medicago* and related crop legumes (Young *et al.*, 2005). A similar strategy is being followed to determine the *Lotus* genome sequence (Young *et al.*, 2005). Because the genomes of these two model legumes are syntenic to those of crop legumes (Choi *et al.*, 2004), their genome sequences will also facilitate the cloning of genes of crop legumes.

2.2. Functional Genomics

Functional genomics initiatives have resulted in the generation of >110,000 (*Lotus*) and >225,000 (*Medicago*) expressed sequence tags (ESTs) originating from many different libraries. In the case of *Medicago*, these ESTs have been assembled into 18,600 tentative consensus sequences (TCs) of more than one EST and 18,200 singleton sequences (Journet *et al.*, 2002; Lamblin *et al.*, 2003; Quackenbush *et al.*,

2001). Assuming that *Medicago* has a similar number of genes to *Arabidopsis*, the vast majority of these should be represented by at least one EST. These data sets, in combination with the available genome sequence, have been used to construct cDNA- and oligonucleotide-based micro arrays (Barnett *et al.*, 2004, Kuster *et al.*, 2004). Because the genome of *Medicago*'s symbiotic partner, *Sinorhizobium meliloti*, is also fully sequenced, even dual genome chips have been constructed, which enable simultaneous profiling of the transcriptome of both symbiotic partners (Barnett *et al.*, 2004).

2.3. Reverse-genetics Tools

In this chapter, we will describe several genes that have been cloned from legumes by a forward-genetics screen. Currently, several reverse-genetics tools have been developed which will either facilitate the functional analysis of genes identified by transcriptome analysis or provide the possibility of generating an allelic series of a gene of interest.

Genome-wide transposon tagging has been initiated in *Medicago*. The tobacco *Tnt1* transposon has been shown to be active in *Medicago* during tissue culture and to insert preferentially into gene-rich regions (d'Erfurth *et al.*, 2003). An international consortium of European and US groups will make a collection of lines (about 8000) that harbour about 150,000 insertions. In most cases, these insertion mutants will have a knockout phenotype.

TILLING facilities (Targeted Induced Local Lesions In Genomes) have been created (Perry *et al.*, 2003). TILLING allows, for example, the identification of all alleles of a gene of interest within an EMS population (McCallum *et al.*, 2000). Alleles with a weak or wild type-like phenotype can, therefore, be identified. Such an allelic series is important, in addition to the knockout phenotype, in order to obtain insight into the function of a gene of interest.

3. GENETIC DISSECTION OF THE NOD FACTOR-SIGNALING PATHWAY

Nod-factor signaling probably occurs at various steps of nodulation, but the primary signaling events take place in the epidermis, when bacteria colonize the root. We will, therefore, focus first on Nod-factor signalling in root hairs within the first hours after Nod factors are perceived. The Nod-factor responses that are especially useful in positioning genes in a pathway are: (i) morphological changes induced in root hairs, *i.e.*, root-hair deformation and reorientation of root-hair growth; (ii) electrophysiological changes, like Ca^{2+} spiking and Ca^{2+} influx, induced in the epidermis; and (iii) the induction of expression of nodulin genes. First, the characteristics of these "dissecting tools" are described.

3.1. Morphological Responses of Root Hairs to Nod Factors

One of the earliest morphological responses to Nod factors is deformation of root-hair tips within one hour. The swelling of root-hair tips is the result of isotropic

growth and occurs primarily in root-hair cells that are terminating growth (Heidstra *et al.*, 1994). Subsequently, tip growth is re-established with a new root-hair tip emerging from the swelling. Because its growth direction differs from the original, the root hair shows a “deformed” morphology (root-hair deformation). Alternatively, root hair-tip growth can be reinitiated along the shaft of the root hair causing a branched appearance. Although branched root hairs are morphologically distinct, they can be considered the result of the same process - termination of polar growth at the apex and re-initiation of root hair-tip growth.

In contrast to bulk application of Nod factor, a morphological response can also be induced in growing root hairs by localized Nod-factor application. This results in redirection of growth towards the site of application (Esseling *et al.*, 2003).

3.2. Electrophysiological Responses to Nod Factor

In addition to the morphological responses, some electrophysiological responses and induction of gene expression have been used to genetically dissect the Nod factor-signaling pathway.

Ca²⁺ influx is one of the earliest responses to Nod factor application (Felle *et al.*, 1998). Ten seconds after addition of Nod factor, an increase of cytoplasmic Ca²⁺ concentration can be observed in the root hair tip, mainly at the periphery of the cell (Shaw and Long, 2003). This primary rise in peripheral cytoplasmic Ca²⁺ concentration is followed by a global one, which expands towards the nucleus. This process is referred to as the secondary calcium flux and appears to originate from sources around the nucleus.

Calcium spiking is another electrophysiological response and starts 5-30 minutes after application of Nod factors (Ehrhardt *et al.*, 1996). Calcium spikes are transient elevations of Ca²⁺ concentration that appear to originate from sources around the nucleus. Spiking can be sustained for a couple of hours after the initial Nod-factor application.

3.3. Transcriptional Responses to Nod Factor

Purified Nod factors are sufficient to activate the expression of several so-called early nodulin genes (*ENOD*) of which *ENOD11* and *ENOD12* are most frequently used to characterize mutants (Horvath *et al.*, 1993; Journet *et al.*, 2001; Pichon *et al.*, 1992; Pingret *et al.*, 1998). Induction of these genes can be detected 1-3 hours after Nod-factor application. Especially useful molecular markers for Nod factor-induced transcription were *GUS* genes driven by the *ENOD11* or *ENOD12* promoter (Journet *et al.*, 2001; Pingret *et al.*, 1998). In lines with such a reporter construct, Nod factors induce *GUS* expression in the epidermis within 1-3 hours.

3.4. Genetic Dissection of the Nod Factor-signaling Pathway

Mutants that are blocked at a very early stage of Nod-factor signalling have lost at least some epidermal responses. Such mutants have been made in, for example, pea

and the model legumes, *Medicago* and *Lotus*. Cloning of these genes showed that, in most cases, orthologous genes have been mutated in all three species (Table 1). Because the mutant phenotypes have been studied in most detail in *Medicago*, we will start with a description of the genetic dissection of Nod-factor signaling in this species. In Table 1, we indicate which *Lotus* and pea genes are orthologous to the genes described in *Medicago*.

Table 1. Cloned genes involved in *Rhizobium*-legume symbiosis

<i>Medicago</i>	Pea	<i>Lotus</i>	(Putative) function of gene products
<i>NFP</i>	<i>SYM10</i>	<i>NFR5</i>	Nod factor signaling receptor
— ^a	—	<i>NFR1</i>	Nod factor signaling receptor
<i>DMI2</i>	<i>SYM19</i>	<i>SYMRK</i>	Leucine rich-repeat receptor kinase
<i>DMI1</i>	<i>SYM8</i>	<i>CASTOR</i>	Cation channel
—	—	<i>POLLUX</i>	Cation channel (duplication of Castor)
<i>DMI3</i>	<i>SYM9</i>	<i>SYM15</i>	Ca ²⁺ /calmodulin-dependent protein kinase
<i>NSP1</i>	—	—	GRAS type-like transcription factor
<i>NSP2</i>	<i>SYM7</i>	—	GRAS type-like transcription factor
—	<i>SYM35</i>	<i>NIN</i>	RWP-RK transcription factor
<i>LYK3/4</i>	<i>SYM2</i>	—	Nod factor entry receptor
<i>SUNN</i>	<i>SYM29</i>	<i>HAR1</i>	CLV1-like receptor kinase(autoregulation)

^a “—” indicates that the orthologous gene in this species is not (yet) described.

Six *Medicago* mutants that cannot be infected by rhizobia were analysed using the aforementioned Nod factor-induced responses. These mutant types are *Nod Factor Perception* (*nfp*), *Doesn't Make Infections* (*dmi1*, *dmi2*, and *dmi3*) and *Nod-factor Signaling Pathway* (*nsp1* and *nsp2*) (Amor *et al.*, 2003; Catoira *et al.*, 2000; Oldroyd and Long, 2003). A mutation in the furthest upstream active gene(s), the putative Nod factor-receptor gene(s), should eliminate all responses including calcium influx, which is the earliest known response. Only in *nfp* mutants has this turned out to be the case (Amor *et al.*, 2003). This positions NFP at the upstream end of the signaling cascade, leading to the postulate that NFP is involved in Nod-factor perception (Amor *et al.*, 2003). In *Medicago* and pea, only one putative Nod factor-receptor gene was identified by forward genetics (Amor *et al.*, 2003; Duc and Messager, 1989; Duc *et al.*, 1989; Sagan *et al.*, 1994; Walker *et al.*, 2000). However, in *Lotus*, two loci have been identified that are essential for all Nod-factor responses (Madsen *et al.*, 2003; Radutoiu *et al.*, 2003; Schauser *et al.*, 1998; Szczyglowski *et al.*, 1998). These are *NFR1* and *NFR5*, of which the latter is orthologous to *NFP* (see below). Whether *Medicago* and pea have an *NFR1* ortholog is not known.

Of the other 5 mutants, *dmi1* and *dmi2* are the most disturbed. The primary Ca²⁺ influx can be induced in these mutants and their root hairs can also reorient their growth in response to Nod factor (Esseling *et al.*, 2003; Shaw and Long, 2003), but the secondary calcium increase around the nucleus as well as the Ca²⁺ spiking response are lost (Shaw and Long, 2003; Wais *et al.*, 2000). In contrast, Ca²⁺ spiking can still be induced in *dmi3*, *nsp1*, and *nsp2* mutants (Shaw and Long, 2003;

Wais, 2000). This positions the action of DMI1 and DMI2 downstream of NFP, but upstream of Ca^{2+} spiking, but places DMI3, NSP1, and NSP2 downstream of Ca^{2+} spiking (Figure 1).

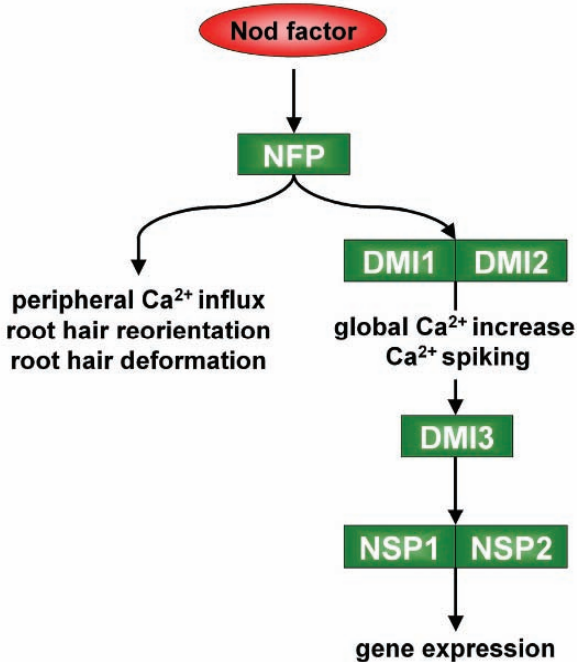

Figure 1. A model for the Medicago epidermal Nod factor-signaling pathway. Nod factors activate the LysM-type receptor kinase (NFP). NFP is the only genetically isolated gene essential for peripheral calcium influx, root-hair reorientation, and root-hair deformation. Nod factor-induced changes in gene expression require all genes, whereas global calcium increase and calcium spiking require only NFP, DMI1, and DMI2.

In addition to Ca^{2+} influx, the first step of root-hair deformation (root-hair swelling) can also be induced in *dmi1* and *dmi2* mutants, whereas this is not the case for *nfp* (Amor *et al.*, 2003; Catoira *et al.*, 2000). The *dmi3* mutants have a similar root-hair-deformation phenotype as the *dmi1* and *dmi2* mutants, whereas the two *NSP* genes are not required for either step of root-hair deformation (Catoira *et al.*, 2000; Oldroyd and Long, 2003). DMI3 must, therefore, be positioned upstream of both NSP1 and NSP2.

Expression analyses of the *ENOD11/12*-reporter genes showed that mutations in all genes positioned upstream of NSP1 and NSP2 completely eliminated induction of *ENOD* expression by Nod factors (Catoira *et al.*, 2000; Mitra and Long, 2004b). Although *nsp2* mutants show no induction of reporter genes, *ENOD* genes can be induced in *nsp1* mutants, albeit at a markedly reduced level (Catoira *et al.*, 2000;

Oldroyd and Long, 2003). Despite this slight difference, we place NSP1 and NSP2 in a similar position downstream of DMI3 (Figure 1).

Nod factors are unable to induce the second step of root-hair deformation in *dmi2* mutants under conditions used in most laboratories (Catoira *et al.*, 2000; Heidstra *et al.*, 1994). Isotropic growth thus occurs after Nod-factor application, but new polar outgrowth from these swellings cannot be initiated. However, when mechanical stimuli are minimized (*e.g.*, during replacement of medium), root hairs of *dmi2* mutants deform like those of wild-type plants (Esseling *et al.*, 2004). This indicates that the touch response of *dmi2* mutants is markedly altered. Although they are hypersensitive to touch – root-hair growth is terminated by very mild mechanical stimuli and their ability to restart growth is markedly reduced (Esseling *et al.*, 2004). Furthermore, root hairs of *dmi1*, *dmi2*, and *dmi3* mutants can respond to localized Nod-factor application by reorienting their growth direction, just like wild-type root hairs do (Esseling *et al.*, 2004). This suggests that NFP, by a signal-transduction pathway independent of *DMI* genes, induces deformation and root-hair reorientation. Parallel to this pathway, the *DMI* pathway, including the *NSP* genes, induces early nodulin-gene expression (Figure 1).

3.5. The *DMI* Genes are Essential for Arbuscular Mycorrhizal Symbiosis

The three *DMI* genes that are essential for rhizobial Nod factor-signal transduction are also required for the symbiosis with arbuscular endomycorrhizal fungi (AM) (Catoira *et al.*, 2000; Duc *et al.*, 1989). The AM fungi do form papillae/appressoria on the *dmi* mutants, but they cannot enter the epidermis. In contrast, the *nfp* and *nsp* mutants can be infected by AM fungi (Amor *et al.*, 2003; Catoira *et al.*, 2000; Oldroyd and Long, 2003). The AM symbiosis is widespread in the plant kingdom and is a very ancient (450 million years old) plant-microbe interaction (Remy *et al.*, 1994). It is, therefore, probable that the *DMI* module essential for rhizobial Nod-factor signaling has been recruited from this ancient symbiosis.

Because the putative Nod-factor receptor (NFP) is not required for the AM symbiosis, it is probable that AM fungi produce signals (Myc factors), which differ from rhizobial Nod factors, recognized by a Myc factor-specific receptor (Kosuta *et al.*, 2003). Further, the response that is induced after *DMI* activation is different in the two symbioses (Kosuta *et al.*, 2003). For example, the genes activated by Nod-factor signaling only partly overlap with those induced during early stages of the AM symbiosis (El Yahyaoui *et al.*, 2004). So, *DMI3* appears to be essential for all induced changes in gene expression during both symbiotic interactions, but the sets of genes that are activated are different. To explain this paradox, we propose that the parallel deformation pathway in cooperation with the *DMI* pathway induces the genes activated by Nod factors.

Further, to explain the specificity of the AM symbiosis, it seems probable that a Myc signal activates another parallel pathway that, in cooperation with the *DMI* pathway, induces the AM-gene set. This could explain why *DMI3* is essential for both symbiotic interactions, even though the responses that are induced downstream of *DMI3* are different (Figure 2).

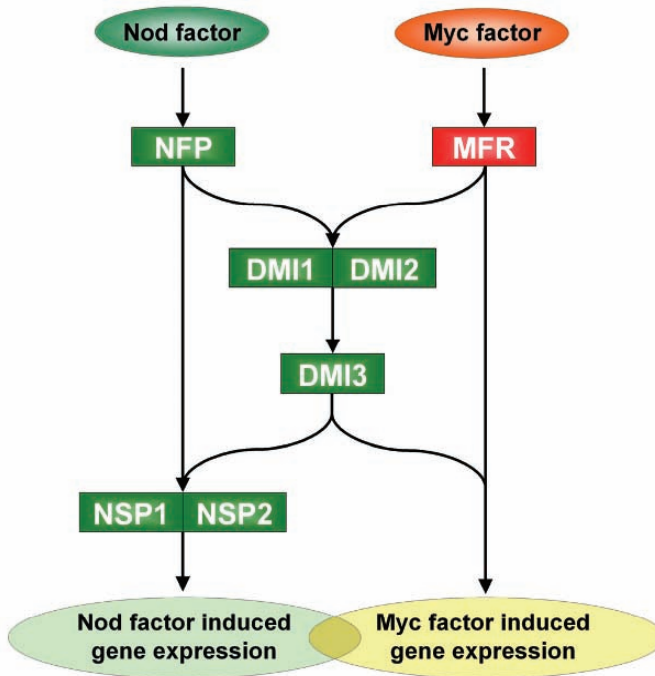

Figure 2. A model for the functioning of shared signaling genes in rhizobial and AM symbioses.

Nod factor is perceived by the LysM-type Nod-factor receptors (NFP), the signal is further transduced via the DMI proteins, and NSP's are activated in turn to regulate transcription of primary targets.

In order to specifically induce the set of genes activated by Nod factors, it is likely that the Nod factor-receptor complex activates the combined activity of the two pathways, thus creating the difference between Nod factor- and Myc factor-induced gene expression.

Myc factors are likely perceived by Myc-factor receptors (MFR) and regulate in a similar fashion Myc factor-regulated genes.

Only a small number of genes are induced by both Nod and Myc factors.

4. NATURE OF THE NOD FACTOR RECEPTORS

Studies with rhizobial mutants, which secrete Nod factors with different structures, have revealed that the structural demands for different Nod-factor responses varies (Ardourel *et al.*, 1994; Debelle *et al.*, 1986; Demont-Caulet *et al.*, 1999; Firmin *et al.*, 1993; Journet *et al.*, 1994; Shaw and Long, 2003; Surin and Downie, 1988; Wais *et al.*, 2002). The start of infection has more stringent demands with respect to Nod-factor structure than do root-hair deformation, calcium flux, calcium spiking, and induction of early nodulin-gene expression. These studies led to the hypothesis that responses, like root-hair deformation and cortical-cell division, are induced by a Nod factor-signaling receptor, whereas the start of infection-thread

formation requires a second Nod-factor receptor that was named entry receptor (Ardourel *et al.*, 1994). The legume mutants described above, which are completely unable to respond to Nod factors, have been used to identify putative Nod factor-signaling receptors. Knockout mutants in a putative entry receptor have not been identified, but a good candidate was located in pea accessions from the Middle East. These contain a locus (*sym2*) that can cause a specific block of infection in a Nod factor structure-dependent manner (Geurts *et al.*, 1997).

Unlike the pea *SYM2* gene, the *Lotus* genes, *LjNFR5* and *LjNFR1*, are essential for all Nod-factor responses. Therefore, like the *Medicago NFP*, they most likely encode Nod factor-signaling receptors (Table 1). *LjNFR5* is a LysM domain-containing receptor kinase (Madsen *et al.*, 2003). It is probably a plasma-membrane protein because it contains an N-terminal signal sequence as well as a putative transmembrane domain. The extra-cellular region contains three LysM domains; such domains also occur in a chitinase of *Volvox carteri* and in proteins binding peptidoglycans, such as *Lactococcus lactis* autolysin (Amon *et al.*, 1998; Bateman and Bycroft, 2000; Steen *et al.*, 2003). These LysM domains, therefore, seem perfectly suited to binding Nod factors with their N-acetylglucosamine oligomer backbone, although physical interaction of Nod factors and the LysM domains remains to be demonstrated. This extra-cellular region is connected to the intra-cellular serine/threonine kinase domain by a single transmembrane domain. Surprisingly, this kinase is missing the activation loop that is normally present in kinases and exerts an inhibitory effect on the activity. Phosphorylation of such an activation loop generally results in "opening" of the ATP-binding pocket and subsequent activation of the protein (Xu *et al.*, 1999). Absence of the activation loop suggests that Nod-factor binding directly activates *LjNFR5*. The *Medicago MtNFP* and pea *PsSYM10* genes are orthologs of *LjNFR5* (Table 1) because their functions are similar, their sequences are conserved, and the chromosome regions where these genes are located are syntenic (Amor *et al.*, 2003; Madsen *et al.*, 2003; Schneider *et al.*, 2002).

LjNFR1 is also a LysM domain-containing receptor kinase (Radutoiu *et al.*, 2003) but, in contrast to *LjNFR5*, *LjNFR1* contains only two predicted LysM domains and the kinase contains an activation loop. Loci with a similar function to *LjNFR1* have not yet been identified in either pea or *Medicago*.

The cloning of a putative Nod factor-entry receptor made use of natural variation in different *Pisum sativum* accessions. The Afghanistan accession can only be nodulated by specific *Rhizobium leguminosarum* bv. *viciae* strains (Lie, 1984). These strains contain an additional *nod* gene, encoding NodX, which acetylates the reducing end of the Nod factor (Firmin *et al.*, 1993). Strains of *R. leguminosarum* bv. *viciae* that lack *nodX*, and therefore the acetyl modification at the reducing end of Nod factors, fail to nodulate peas containing the *SYM2* locus of Afghanistan pea. In such an incompatible interaction, the infection process is specifically blocked; markedly fewer infection threads are formed and these threads are then arrested in the epidermis (Geurts *et al.*, 1997).

Positional cloning in pea is rather difficult due to the complexity of the genome and a 300-kb *SYM2*-orthologous region of *Medicago* was, therefore, cloned (Gualtieri *et al.*, 2002; Limpens *et al.*, 2003). By using RNA interference, it was

shown that two LysM domain-receptor kinases (encoded by *LYK3* and *LYK4*) located within this region are essential for infection-thread initiation and growth, whereas root-hair deformation and cortical-cell division are not affected (Limpens *et al.*, 2003; E. Limpens, personal communication). This supports the idea that *LYK3/4* has a similar function to the product of the pea *SYM2* gene and is an entry receptor, but these studies do not exclude the possibility that another *LYK* gene also encodes an entry receptor. However, because *Medicago lyk3* null mutants have a clear infection phenotype, it seems probable that only *LYK3* is an entry receptor (P. Smit, unpublished data).

LYK3 (and 4) are homologous to *LjNFR1* and the *Medicago* and *Lotus* chromosome regions, where their genes are located, are also syntenic (Limpens, 2004), suggesting that these genes could be orthologous. However, this is not supported by their difference in function; *NFR1* functions as a signaling receptor, whereas *LYK3/4* function as entry receptors (Figure 3).

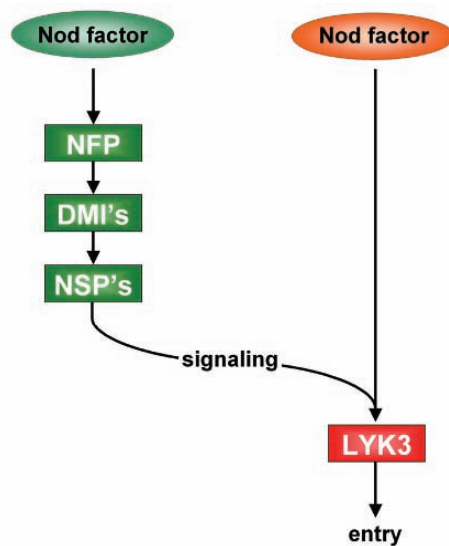

Figure 3. The two-receptor model for Nod-factor signaling.

The signaling cascade can be activated by many Nod factor-like structures (Nod factor above the left branch). Once the cascade is triggered, signaling will activate *LYK3*, which allows rhizobia that produce properly decorated Nod factor to enter (Nod factor above the right branch).

5. THE DMI PROTEINS

Genetic analyses show that the products of the *DMI* genes have a pivotal role in rhizobial and mycorrhizal symbioses. *DMI1* is an 882 amino-acid protein that shows a low but global similarity to potassium transporters (Ané *et al.*, 2004). The N-terminal part contains five predicted trans-membrane domains (PSORT,

<http://psort.nibb.ac.jp/>), suggesting that it is an integral membrane protein. This is supported by studies with the two *DMI1*-like genes, *CASTOR* and *POLLUX*, from *Lotus* (Imaizumi-Anraku *et al.*, 2005). GFP fusions of these proteins were located in the membrane of plastids. However, it is not clear whether these fusions were still biologically active and further localization studies were only reported for heterologous systems. The domain in the middle of *DMI1* has homology to the TrkA protein in *Escherichia coli*, where it is associated with a constitutive potassium-uptake complex (Bossemeyer *et al.*, 1989). Taken together, these data suggest that *DMI1* functions as a cation channel. As in *Medicago*, the rice and *Arabidopsis* genomes contain a single *dmi1*-like gene, suggesting an ancient origin for this plant-specific gene.

DMI2 is a 925 amino-acid receptor kinase (Endre *et al.*, 2002). The N-terminal extracellular domain of 595 amino acids contains a signal peptide, which is consistent with its reported location in plasmamembrane and infection-thread membrane (Limpens *et al.*, 2005). Further, the N-terminal domain contains a large part without any recognisable motifs, as well as three LRR domains near the transmembrane domain that precedes the intracellular C-terminal tyrosine protein-kinase domain. Both the ligand and the target(s) of *DMI2* remain unknown. *DMI2*-like proteins (NSLs) have been identified in all plant species so far sequenced. These proteins are plant-specific and, in *Arabidopsis*, the family consists of approximately 50 genes with unknown functions (Schauser *et al.*, 2005).

DMI3 is a 523 amino-acid calcium- and calmodulin-dependent protein kinase (CCaMK) (Lévy *et al.*, 2004; Mitra *et al.*, 2004a). The N-terminal part contains a conserved serine/threonine protein kinase domain in which a putative nuclear-localization signal is present. This domain is flanked by a calmodulin-binding domain that putatively binds calcium-calmodulin complexes and three EF hands reside in the C-terminal part of the protein. *DMI3* is homologous to a biochemically well-characterized lily CCaMK, and, to a lesser extent, to plant CDPKs and CAMKIV of vertebrates. *DMI3* is nuclear located, where it most likely functions as an integrator of calcium signals (spiking) (Kalo *et al.*, 2005; Smit *et al.*, 2005). The nuclear location of *DMI3* suggests that further downstream signaling, which leads to gene expression, takes place in the nucleus and involves *DMI3*-activated transcription factors.

6. NSPs ARE NOD FACTOR-RESPONSE FACTORS

NSP1 and NSP2 have homology to transcriptional regulators of the GRAS-type protein family and both are essential for all reported Nod factor-induced transcriptional changes (Catoira *et al.*, 2000; Kalo *et al.*, 2005; Mitra *et al.*, 2004a; Oldroyd and Long, 2003; Smit *et al.*, 2005). NSP1 and NSP2 are 554 and 508 amino acids long, respectively, and both contain all five motifs present in GRAS-type proteins. NSP1 is constitutively present in the nucleus, making it likely that it is activated by *DMI3* upon Nod-factor signaling, either directly or indirectly. NSP2 is located in the ER surrounding the nucleus and, upon Nod-factor signaling, it accumulates in the nucleus. Because both *NSP* genes are constitutively expressed, their products have been named Nod-factor response factors (Smit *et al.*, 2005).

Both *NSP* genes occur as single copy genes that have putative orthologs in rice, poplar, and *Arabidopsis*, suggesting that NSPs have a non-symbiotic function. However, uninoculated *nsp1* and *nsp2* mutants do not have a phenotype when grown under laboratory conditions.

7. NIN IS A NOD FACTOR-RESPONSIVE FACTOR

The *Lotus NIN* gene is essential for infection as well as cortical-cell divisions but, in a knock-out mutant, root-hair deformations are induced. The zone normally susceptible to Nod factor is enlarged in a *nin* mutant, excessive root-hair deformations are formed and root-hair curls do not entrap rhizobia (Schäuser *et al.*, 1998). A *Medicago* knock-out mutant has so far not been reported, but a pea ortholog has been identified. Because the expression of the *NIN* gene is induced by Nod factor, we did not include it within the Nod factor-signaling network depicted in Figure 1.

The *NIN* gene encodes a 878 amino-acid putative transcription factor that does not belong to any previously characterized transcription factor family (Schäuser *et al.*, 2005). Its C-terminal half combines characteristics of the bZIP and bHLH/Z transcription factors and also contains basic DNA-binding domains. Two additional features of the *NIN* protein are the RWP-RK motif (within the basic region) and the PB1 domain at the C-terminus. The RWP-RK motif of the *Chlamydomonas reinhardtii MID* gene mediates regulation of mating-type genes. The PB1 domain mediates interactions between cell polarity-determining proteins in yeast (Ito *et al.*, 2001; Terasawa *et al.*, 2001). The pea *SYM35* is orthologous to *NIN* and a knock-out mutation shows a similar phenotype (Borisov *et al.*, 2003). As in the case of the Nod factor signaling genes, *NIN*-like genes occur in all plant species for which the genome has been sequenced (Schäuser *et al.*, 2005).

The *NIN* gene is expressed at a basal level and, five hours after inoculation, its expression level is five-fold induced (Schäuser *et al.*, 1999), suggesting that *NIN* is one of the genes regulated by the Nod factor-signaling pathway as depicted in Figure 1. The *NIN* gene seems to be a “primary” target for Nod factors and is itself required for certain Nod-factor responses. *NIN* could, therefore, be named a Nod factor-responsive factor, analogous to ethylene-responsive factors (ERFs) (Hao *et al.*, 1998).

Homologs of all known Nod factor-signaling genes, as well as *NIN*, have been identified in non-leguminous plants (see above). It is, therefore, likely that during evolution, these genes have been recruited into the Nod factor-signaling cascade. The *DMI* genes were most likely recruited from the AM symbiosis, whereas the function of the ancestors of other Nod factor-signaling genes is not clear.

Some of the Nod factor-signaling genes are expressed in root nodules (Capoen *et al.*, 2005; Limpens *et al.*, 2005; Smit *et al.*, 2005). The best studied example in this respect is *DMI2*, a gene active in *Medicago* nodules in a few cell layers directly adjacent to the apical meristem. In these cell layers, infection threads invade newly formed cells and rhizobia are released from them by an endocytosis-like process. In this way, organelle-like structures (symbiosomes) are formed that harbor the

rhizobia; they subsequently divide and fill most of the cytoplasm of the host cell. Knock down of *DMI2* expression in nodules of *Medicago* and *Sesbania* causes extensive infection-thread growth, but release of the rhizobia from the threads is blocked (Capoen *et al.*, 2005; Limpens *et al.*, 2005). A similar phenotype is seen in *Medicago nip* mutants (Veereshlingam *et al.*, 2004), but the *NIP* gene has not yet been cloned.

The involvement of *DMI2* in bacterial release suggests that this step also is controlled by Nod-factor signaling. However, it should be kept in mind that mutations in *DMI2* also cause an altered touch response (Esseling *et al.*, 2004). The block of bacterial release may, therefore, be caused by such an altered touch response.

8. AUTOREGULATION OF NODULE NUMBER

Root nodules are in general formed in the susceptible zone of the root (Bhuvanewari *et al.*, 1983). This zone extends from the area above the root apical meristem, where root hairs emerge, to the region where root hairs have just matured. Within this susceptible zone, Nod factors can induce responses that lead to nodule formation (Heidstra *et al.*, 1997). However, when legumes have formed sufficient nodules to sustain their growth, the ability to form nodules in the newly formed zones above the meristems is switched off (Kosslak and Bohlool, 1984; Pierce and Bauer, 1983). This autoregulation of nodule number is important to maintain a good balance between costs and benefits, which is essential in symbiosis. Mutants in pea and soybean that have lost this autoregulation were identified a few decades ago (Carroll *et al.*, 1985; Jacobsen and Feenstra, 1984; Sagan and Duc, 1996). These mutants can have massively nodulated root systems but the plants grow sub-optimally due to the large numbers of resource-consuming rhizobia.

Studies with autoregulatory mutants have shown that autoregulation involves a long-distance communication between shoot and root. Grafting studies, involving autoregulatory mutants and wild-type plants, were especially important in showing that signals from the shoot are important for control of nodule number in the root (Cho and Harper, 1991; Nishimura *et al.*, 2002; Penmetsa *et al.*, 2003; Postma *et al.*, 1988). The *HARI* (Hypernodulation Aberrant Root) gene is involved in this shoot-root communication. It has been cloned from *Lotus* and its orthologs cloned from soybean (*GmNARK*), pea (*SYM29*), and *Medicago* (*SUNN*) (Krusell *et al.*, 2002; Nishimura *et al.*, 2002; Schnabel, 2005; Searle *et al.*, 2003). This autoregulatory gene encodes a receptor-like kinase containing an extracellular LRR and an intracellular serine/threonine kinase. The molecular mechanism, the signal it perceives, and how it controls nodule number or senses a fixed-nitrogen source remain to be elucidated.

The ability to form nodules in the susceptible zone of legumes can also be suppressed by a fixed-nitrogen source, like ammonia or nitrate (Carroll *et al.*, 1985; Postma *et al.*, 1988). The effect of fixed-nitrogen on Nod-factor responses has been studied in some legumes; it was found that fixed-nitrogen completely blocks the ability to deform root hairs, to induce cortical-cell divisions, and *ENOD12*

expression (Heidstra *et al.*, 1997). This inability to respond to Nod factors suggests that Nod-factor signaling is disturbed and that the Nod factor-signaling genes/proteins, which are described above, are good candidates to be down-regulated by fixed-nitrogen. Interestingly, the pea and soybean autoregulatory mutants are markedly less sensitive to a fixed-nitrogen source, indicating that autoregulation and suppression of nodulation by fixed-nitrogen are controlled by a similar mechanism.

9. CONCLUDING REMARKS

The recent cloning of the key regulators of Nod-factor signaling only became possible through genetic approaches in legume species for which efficient molecular-genetic tools were developed. None of these key regulators had been identified by transcriptome analysis and this situation underlines the importance of genetics in unraveling molecular mechanisms that control nodule formation.

In the last couple of years, the cloning of symbiotic genes has focused on Nod factor-signaling genes. Although the formation of nodules is set in motion by Nod-factor signaling, the ultimate formation of an N₂-fixing root nodule requires several steps that have to be strictly controlled in both time and space. Some mutants blocked in such steps have already been identified, *e.g.*, mutants in which maintenance of infection-thread growth, formation of symbiosomes, maintenance of symbiosomes, or the N₂-fixation process is disturbed (Bénaben *et al.*, 1995; Bright *et al.*, 2005; Kuppusamy *et al.*, 2004; Mitra and Long, 2004b; Veereshlingam *et al.*, 2004). It seems very likely that mutagenesis in relation to such steps is still far from saturation and, therefore, it is of great importance that genetic screens for such defects are continued. The possibilities of screening for such mutants will increase as, in addition to the EMS-mutagenised populations that have been used to identify *Medicago* and *Lotus* mutants, a γ -irradiated *Medicago* population has been created in which large deletions have been induced (Oldroyd and Long, 2003). It has been demonstrated that transcriptome analysis of such deletion mutants is an efficient approach to cloning the mutated genes (Mitra and Long, 2004b). Further, a large transposon-tagged *Medicago* population is currently being made using the tobacco transposon *Tnt1* (Ratet *et al.*, 2005). A collaborative effort of several European and USA laboratories (<http://www.eugrainlegumes.org/>; d'Ehrfurth *et al.*, 2003) aims to create a collection of 8,000–30,000 tagged lines, in which about 4–40 *Tnt1* insertions are present in each line.

The cloning of the Nod factor-signaling genes has provided the means to demonstrate that Nod-factor signaling not only plays a role at the onset of nodule formation but also at the start of infection and, even in nodules, to induce symbiosome formation. This information provides new possibilities for studying the molecular mechanisms controlling these various steps. For example, identifying targets of Nod factor-signaling proteins (*e.g.*, genes activated by NSP1 and NSP2) at these different steps will provide insight into the underlying mechanisms.

The cloned Nod factor-signaling genes also provide the possibility of addressing long-standing questions, such as the molecular basis of host specificity

or how Nod-factor responses in epidermis and cortex are coordinated. Further, they can be used in comparative biology studies and might provide insight into how a unique trait, the rhizobial nodule symbiosis, has evolved in the legume family.

REFERENCES

- Amon, P., Haas, E., and Sumper, M. (1998). The sex-inducing pheromone and wounding trigger the same set of genes in the multicellular green alga *Volvox*. *Plant Cell*, *10*, 781-790.
- Amor, B. B., Shaw, S. L., Oldroyd, G. E. D., Mailliet, F., Penmetsa, R. V., Cook, D., *et al.* (2003). The NFP locus of *Medicago truncatula* controls an early step of Nod factor signal transduction upstream of a rapid calcium flux and root hair deformation. *Plant J.*, *34*, 495-506.
- Ané, J. M., Kiss, G. B., Riely, B. K., Penmetsa, R. V., Oldroyd, G. E. D., Ayax, C., *et al.* (2004). *Medicago truncatula dmi1* required for bacterial and fungal symbioses in legumes. *Science*, *303*, 1364-1367.
- Ardourel, M., Demont, N., Debellef, F., Mailliet, F., de Billy, F., Promé, J.C., *et al.* (1994). *Rhizobium meliloti* lipooligosaccharide nodulation factors: Different structural requirements for bacterial entry into target root hair cells and induction of plant symbiotic developmental responses. *Plant Cell*, *6*, 1357-1374.
- Barnett, M. J., Toman, C. J., Fisher, R. F., and Long, S. R. (2004). A dual-genome Symbiosis Chip for coordinate study of signal exchange and development in a prokaryote-host interaction. *Proc. Natl. Acad. Sci. USA*, *101*, 16636-16641.
- Bateman, A., and Bycroft, M. (2000). The structure of a LysM domain from *E. coli* membrane-bound lytic murein transglycosylase D (MltD). *J. Mol. Biol.*, *299*, 1113-1119.
- Bhuvaneswari, T. V., Mills, K. K., Crist, D. K., Evans, W. R., and Bauer, W. D. (1983). Effects of culture age on symbiotic infectivity of *Rhizobium japonicum*. *J. Bacteriol.*, *153*, 443-451.
- Borisov, A. Y., Madsen, L. H., Tsyganov, V. E., Umehara, Y., Voroshilova, V. A., Batagov, A. O., *et al.* (2003). The *sym35* gene required for root nodule development in pea is an ortholog of *nin* from *Lotus japonicus*. *Plant Physiol.*, *131*, 1009-1017.
- Bossemeyer, D., Borchard, A., Dosch, D. C., Helmer, G. C., Epstein, W., Booth, I. R., *et al.* (1989). K⁺-transport protein TrkA of *Escherichia coli* is a peripheral membrane protein that requires other *trk* gene products for attachment to the cytoplasmic membrane. *J. Biol. Chem.*, *264*, 16403-16410.
- Brewin, N. J. (2004). Plant cell wall remodelling in the rhizobium-legume symbiosis. *Crit. Rev. Plant Sci.* *23*, 293-316.
- Bright, L. J., Liang, Y., Mitchell, D. M., and Harris, J. M. (2005). The *LATD* gene of *Medicago truncatula* is required for both nodule and root development. *Mol. Plant-Microbe Interact.*, *18*, 521-532.
- Capoen, W., Goormachtig, S., De Rycke, R., Schroeyers, K., and Holsters, M. (2005). SrSymRK, a plant receptor essential for symbiosome formation. *Proc. Natl. Acad. Sci. USA*, *102*, 10369-10374.
- Carroll, B. J., McNeil, D. L., and Gresshoff, P. M. (1985). A supernodulation and nitrate tolerant symbiotic (*nts*) soybean mutant. *Plant Physiol.*, *78*, 34-40.
- Catoira, R., Galera, C., de Billy, F., Penmetsa, R. V., Journet, E. P., Mailliet, F., *et al.* (2000). Four genes of *Medicago truncatula* controlling components of a nod factor transduction pathway. *Plant Cell*, *12*, 1647-1666.
- Cho, M. J., and Harper, J. E. (1991). Root isoflavonoid response to grafting between wild-type and nodulation-mutant soybean plants. *Plant Physiol.*, *96*, 1277-1282.
- Choi, H.-K., Mun, J.-H., Kim, D.-J., Zhu, H., Baek, J.-M., Mudge, J., *et al.* (2004). Estimating genome conservation between crop and model legume species. *Proc. Natl. Acad. Sci. USA*, *101*, 15289-15294.
- Debellef, F., Rosenberg, C., Vasse, J., Mailliet, F., Martinez, E., Dénarié, J., *et al.* (1986). Assignment of symbiotic developmental phenotypes to common and specific nodulation (*nod*) genetic loci of *Rhizobium meliloti*. *J. Bacteriol.*, *168*, 1075-1086.
- Demont-Caulet, N., Mailliet, F., Tailler, D., Jacquinet, J. C., Promé, J. C., Nicolaou, K. C., *et al.* (1999). Nodule-inducing activity of synthetic *Sinorhizobium meliloti* nodulation factors and related lipochitooligosaccharides on alfalfa. Importance of the acyl chain structure. *Plant Physiol.*, *120*, 83-92.
- D'Erfurth, I., Cosson, V., Eschstruth, A., Lucas, H., Kondorosi, A., and Ratet, P. (2003). Efficient transposition of the *Tnt1* tobacco retrotransposon in the model legume *Medicago truncatula*. *Plant J.*, *34*, 95-106.

- D'Haese, W., and Holsters, M. (2002). Nod factor structures, responses, and perception during initiation of nodule development. *Glycobiol.*, *12*, 79R-105R.
- Doyle, J. J., and Luckow, M. A. (2003). The rest of the iceberg. Legume diversity and evolution in a phylogenetic context. *Plant Physiol.*, *131*, 900-910.
- Duc, G., and Messager, A. (1989). Mutagenesis of pea (*Pisum sativum* L.) and the isolation of mutants for nodulation and nitrogen fixation. *Plant Sci.*, *60*, 207-213.
- Duc, G., Trouvelot, A., Gianinazzi-Pearson, V., and Gianinazzi, S. (1989). First report of non-mycorrhizal plant mutants (Myc⁻) obtained in pea (*Pisum sativum* L.) and fababean (*Vicia faba* L.). *Plant Sci.*, *60*, 215-222.
- Ehrhardt, D. W., Wais, R., and Long, S. R. (1996). Calcium spiking in plant root hairs responding to *Rhizobium* nodulation signals. *Cell*, *85*, 673-681.
- El Yahyaoui, F., Küster, H., Amor, B. B., Hohnjec, N., Pühler, A., Becker, A., *et al.* (2004). Expression profiling in *Medicago truncatula* identifies more than 750 genes differentially expressed during nodulation, including many potential regulators of the symbiotic program. *Plant Physiol.*, *136*, 3159-3176.
- Endre, G., Kereszt, A., Kevei, Z., Mihacea, S., Kaló, P., and Kiss, G. B. (2002). A receptor kinase gene regulating symbiotic nodule development. *Nature*, *417*, 962-966.
- Esseling, J. J., Lhuissier, F. G. P., and Emons, A. M. C. (2003). Nod factor-induced root hair curling: Continuous polar growth towards the point of Nod factor application. *Plant Physiol.*, *132*, 1982-1988.
- Esseling, J. J., Lhuissier, F. G. P., and Emons, A. M. C. (2004). A nonsymbiotic root hair tip growth phenotype in *NORK*-mutated legumes: Implications for nodulation factor-induced signalling and formation of a multifaceted root hair pocket for bacteria. *Plant Cell*, *16*, 933-944.
- Felle, H. H., Kondorosi, E., Kondorosi, A., and Schultze, M. (1998). The role of ion fluxes in Nod factor signalling in *Medicago sativa*. *Plant J.*, *13*, 455-463.
- Firmin, J. L., Wilson, K. E., Carlson, R. W., Davies, A. E., and Downie, J. A. (1993). Resistance to nodulation of cv. Afghanistan peas is overcome by *nodX*, which mediates an O-acetylation of the *Rhizobium leguminosarum* lipo-oligosaccharide nodulation factor. *Mol. Microbiol.*, *10*, 351-360.
- Gage, D. J. (2004). Infection and invasion of roots by symbiotic, nitrogen-fixing rhizobia during nodulation of temperate legumes. *Microbiol. Mol. Biol. Rev.*, *68*, 280-300.
- Geurts, R., Fedorova, E., and Bisseling, T. (2005). Nod factor signalling genes and their function in the early stages of *Rhizobium* infection. *Curr. Opin. Plant Biol.*, *8*, 346-352.
- Geurts, R., Heidstra, R., Hadri, A. E., Downie, J. A., Franssen, H., Van Kammen, A., *et al.* (1997). Sym2 of pea is involved in a nodulation factor perception mechanism that controls the infection process in the epidermis. *Plant Physiol.*, *115*, 351-359.
- Gualtieri, G., Kulikova, O., Limpens, E., Kim, D. J., Cook, D. R., Bisseling, T., *et al.* (2002). Microsynteny between pea and *Medicago truncatula* in the SYM2 region. *Plant Mol. Biol.*, *50*, 225-235.
- Hao, D., Ohme-Takagi, M., and Sarai, A. (1998). Unique mode of GCC box recognition by the DNA-binding domain of ethylene-responsive element-binding factor (ERF) in plants. *J. Biol. Chem.*, *273*, 26857-26861.
- Heidstra, R., Geurts, R., Franssen, H., Spaink, H. P., van Kammen, A., and Bisseling, T. (1994). Root hair deformation activity of nodulation factors and their fate on *Vicia sativa*. *Plant Physiol.*, *105*, 787-797.
- Horvath, B., Heidstra, R., Miklos, L., Moerman, M., Spaink, H. P., Promé, J.-C., *et al.* (1993). Lipooligosaccharides of *Rhizobium* induce infection related early nodulin gene expression in pea root hairs. *Plant J.*, *4*, 727-733.
- Imaizumi-Anraku, H., Takeda, N., Charpentier, M., Perry, J., Miwa, H., Umehara, Y., *et al.* (2005). Plastid proteins crucial for symbiotic fungal and bacterial entry into plant roots. *Nature*, *433*, 527-531.
- Ito, T., Matsui, Y., Ago, T., Ota, K., and Sumimoto, H. (2001). Novel modular domain PB1 recognizes PC motif to mediate functional protein-protein interactions. *EMBO J.*, *20*, 3938-3946.
- Jacobsen, E., and Feenstra, W. J. (1984). A new pea mutant with efficient nodulation in the presence of nitrate. *Plant Sci. Lett.*, *33*, 337-344.
- Journet, E. P., Pichon, M., Dedieu, A., de Billy, F., Truchet, G., and Barker, D. G. (1994). *Rhizobium meliloti* Nod factors elicit cell-specific transcription of the ENOD12 gene in transgenic alfalfa. *Plant J.*, *6*, 241-249.
- Journet, E. P., El-Gachtouli, N., Vernoud, V., de Billy, F., Pichon, M., Dedieu, A., *et al.* (2001). *Medicago truncatula* ENOD11: A novel RPRP-encoding early nodulin gene expressed during mycorrhization in arbuscule-containing cells. *Mol. Plant-Microbe Interact.*, *14*, 737-748.

- Journet, E. P., Van Tuinen, D., Gouzy, J., Crespeau, H., Carreau, V., Farmer, M. J., *et al.* (2002). Exploring root symbiotic programs in the model legume *Medicago truncatula* using EST analysis. *Nucleic Acids Res.*, *30*, 5579-5592.
- Kaló, P., Gleason, C., Edwards, A., Marsh, J., Mitra, R. M., Hirsch, S., *et al.* (2005). Nodulation signaling in legumes requires NSP2, a member of the GRAS family of transcriptional regulators. *Science*, *308*, 1786-1789.
- Kosslak, R. M., and Bohlool, B. B. (1984). Suppression of nodule development of one side of a split-root system of soybeans caused by prior inoculation of the other side. *Plant Physiol.*, *75*, 125-130.
- Kosuta, S., Chabaud M., Lougnon, G., Gough, C., Dénarié, J., Barker, D. G., *et al.* (2003). A diffusible factor from arbuscular mycorrhizal fungi induces symbiosis-specific *MtENOD11* expression in roots of *Medicago truncatula*. *Plant Physiol.*, *131*, 952-962.
- Krusell, L., Madsen L. H., Sato S., Aubert G., Genua A., Szczyglowski, K., *et al.* (2002). Shoot control of root development and nodulation is mediated by a receptor-like kinase. *Nature*, *420*, 422-426.
- Kulikova, O., Geurts, R., Lamine, M., Kim, D. J., Cook, D. R., Leunissen, J., *et al.* (2004). Satellite repeats in the functional centromere and pericentromeric heterochromatin of *Medicago truncatula*. *Chromosoma*, *113*, 276-283.
- Kulikova, O., Gualtieri, G., Geurts, R., Kim, D. J., Cook, D., Huguet, T., *et al.* (2001). Integration of the FISH pachytene and genetic maps of *Medicago truncatula*. *Plant J.*, *27*, 49-58.
- Kuppusamy, K. T., Endre, G., Prabhu, R., Penmetsa, R. V., Veerschlingam, H., Cook, D. R., *et al.* (2004). *LIN*, a *Medicago truncatula* gene required for nodule differentiation and persistence of rhizobial infections. *Plant Physiol.*, *136*, 3682-3691.
- Kuster, H., Hohnjec, N., Krajinski, F., El Yahyaoui, F., Manthey, K., Gouzy, J., *et al.* (2004). Construction and validation of cDNA-based Mt6k-RIT macro- and microarrays to explore root endosymbioses in the model legume *Medicago truncatula*. *J. Biotechnol.*, *108*, 95-113.
- Lamblin, A.-F. J., Crow, J. A., Johnson, J. E., Silverstein, K. A. T., Kunau, T. M., *et al.* (2003). MtDB: A database for personalized data mining of the model legume *Medicago truncatula* transcriptome. *Nucleic Acids Res.*, *31*, 196-201.
- Lévy, J., Bres, C., Geurts, R., Chalhoub, B., Kulikova, O., Duc, G., *et al.* (2004). A putative Ca²⁺ and calmodulin-dependent protein kinase required for bacterial and fungal symbioses. *Science*, *303*, 1361-1364.
- Lewis, G., Schrire, B., Mackinder, B., and Lock, M. (2005). *Legumes of the World*. Kew, UK: Royal Botanic Gardens.
- Lie, T. A. (1984). Host genes in *Pisum sativum* L. conferring resistance to European *Rhizobium leguminosarum* strains. *Plant Soil*, *82*, 415-425.
- Limpens, E., Franken, C., Smit, P., Willemsse, J., Bisseling, T., and Geurts, R. (2003). LysM domain receptor kinases regulating rhizobial Nod factor-induced infection. *Science*, *302*, 630-633.
- Limpens, E., Mirabella, R., Fedorova, E., Franken, C., Franssen, H., Bisseling, T., *et al.* (2005). Formation of organelle-like N₂-fixing symbiosomes in legume root nodules is controlled by *DMI2*. *Proc. Natl. Acad. Sci. USA*, *102*, 10375-10380.
- Madsen, E. B., Madsen, L. H., Radutoiu, S., Olbryt, M., Rakwalska, M., *et al.* (2003). A receptor kinase gene of the LysM type is involved in legume perception of rhizobial signals. *Nature*, *425*, 637-640.
- McCallum, C. M., Comai, L., Greene, E. A., and Henikoff, S. (2000). Targeted screening for induced mutations. *Nature Biotechnol.*, *18*, 455-457.
- Mitra, R. M., Gleason, C. A., Edwards, A., Hadfield, J., Downie, J. A., Oldroyd, G. E. D., *et al.* (2004a). A Ca²⁺/calmodulin-dependent protein kinase required for symbiotic nodule development: Gene identification by transcript-based cloning. *Proc. Natl. Acad. Sci. USA*, *101*, 4701-4705.
- Mitra, R. M., and Long, S. R. (2004b). Plant and bacterial symbiotic mutants define three transcriptionally distinct stages in the development of the *Medicago truncatula*/*Sinorhizobium meliloti* symbiosis. *Plant Physiol.*, *134*, 595-604.
- Nishimura, R., Hayashi, M., Wu, G. J., Kouchi, H., Imaizumi-Anraku, H., Murakami, Y., *et al.* (2002). HAR1 mediates systemic regulation of symbiotic organ development. *Nature*, *420*, 426-429.
- Oldroyd, G. E. D., and Downie, J. A. (2004). Calcium, kinases and nodulation signalling in legumes. *Nature Rev. Mol. Cell Biol.*, *5*, 566-576.
- Oldroyd, G. E., and Geurts, R. (2001). *Medicago truncatula*, going where no plant has gone before. *Trends Plant Sci.*, *6*, 552-554.

- Oldroyd, G. E. D., and Long, S. R. (2003). Identification and characterization of *nodulation-signalling pathway 2*, a gene of *Medicago truncatula* involved in Nod factor signalling. *Plant Physiol.*, *131*, 1027-1032.
- Penmetsa, R. V., Frugoli, J. A., Smith, L. S., Long, S. R., and Cook, D. R. (2003). Dual genetic pathways controlling nodule number in *Medicago truncatula*. *Plant Physiol.*, *131*, 998-1008.
- Perret, X., Staehelin, C., and Broughton, W. J. (2000). Molecular basis of symbiotic promiscuity. *Microbiol. Mol. Biol. Rev.*, *64*, 180-201.
- Perry, J. A., Wang, T. L., Welham, T. J., Gardner, S., Pike, J. M., Yoshida, S., *et al.* (2003). A TILLING reverse genetics tool and a web-accessible collection of mutants of the legume *Lotus japonicus*. *Plant Physiol.*, *131*, 866-871.
- Pichon, M., Journet, E. P., Dedieu, A., de Billy, F., Truchet, G., and Barker, D. G. (1992). *Rhizobium meliloti* elicits transient expression of the early nodulin gene *ENOD12* in the differentiating root epidermis of transgenic alfalfa. *Plant Cell*, *4*, 1199-1211.
- Pierce, M., and Bauer, W. D. (1983). A rapid regulatory response governing nodulation in soybean. *Plant Physiol.*, *73*, 286-290.
- Pingret, J. L., Journet, E. P., and Barker, D. G. (1998). *Rhizobium* Nod factor signaling: Evidence for a G protein-mediated transduction mechanism. *Plant Cell*, *10*, 659-672.
- Postma, J. G., Jacobsen, E., and Feenstra, W. J. (1988). Three pea mutants with an altered nodulation studied by genetic analysis and grafting. *J. Plant Physiol.*, *132*, 424-430.
- Quackenbush, J., Cho, J., Lee, D., Liang, F., Holt, I., Karamycheva, S., *et al.* (2001). The TIGR gene indices: Analysis of gene transcript sequences in highly sampled eukaryotic species. *Nucleic Acids Res.*, *29*, 159-164.
- Radutoiu, S., Madsen, L. H., Madsen, E. B., Felle, H. H., Umehara, Y., Grønland, M., *et al.* (2003). Plant recognition of symbiotic bacteria requires two LysM receptor-like kinases. *Nature*, *425*, 585-592.
- Ratet, P., Brocard, L., D'Ehrfurth, I., Mondy, S., Cosson, V., Durand, P., *et al.* (2005). Gene tagging in *Medicago truncatula*. *Model legume congress abstracts book*, Pacific Grove, CA, USA, p. 67.
- Remy, W., Taylor, T. N., Hass, H., and Kerp, H. (1994). Four hundred-million-year-old vesicular arbuscular mycorrhizae. *Proc. Natl. Acad. Sci. USA*, *91*, 11841-11843.
- Sagan, M., Huguet, T., and Duc, G. (1994). Phenotypic characterization and classification of nodulation mutants of pea (*Pisum sativum* L.). *Plant. Sci.*, *100*, 59-70.
- Sagan, M., and Duc, G. (1996). *Sym28* and *sym29*, two new genes involved in regulation of nodulation in pea (*Pisum sativum* L.). *Symbiosis*, *20*, 229-245.
- Schauser, L., Handberg, K., Sandal, N., Stiller, J., Thykjær, T., Pajuelo, E., *et al.* (1998). Symbiotic mutants deficient in nodule establishment identified after T-DNA transformation of *Lotus japonicus*. *Mol. Gen. Genet.*, *259*, 414-423.
- Schauser, L., Roussis, A., Stiller, J., and Stougaard, J. (1999). A plant regulator controlling the development of symbiotic root nodules. *Nature*, *401*, 191-195.
- Schauser, L., Wieloch, W., and Stougaard, J. (2005). Evolution of NIN-like proteins in *Arabidopsis*, rice and *Lotus japonicus*. *J. Mol. Evol.*, *20*, 229-237.
- Schnabel, E., Journet, E. P., de Carvalho-Niebel, F., Duc, G., and Frugoli, J. (2005). The *Medicago truncatula* *SUNN* gene encodes a CLV1-like leucine-rich repeat receptor kinase that regulates nodule number and root length. *Plant Mol. Biol.*, *58*, 809-822.
- Schneider, A., Walker, S. A., Sagan, M., Duc, G., Ellis, T. H. N., and Downie, J. A. (2002). Mapping of the nodulation loci *sym9* and *sym10* of pea (*Pisum sativum* L.). *Theoret. Appl. Genet.*, *104*, 1312-1316.
- Searle, I. R., Men, A. E., Laniya, T. S., Buzas, D. M., Iturbe-Ormaetxa, I., Carroll, B. J., *et al.* (2003). Long-distance signalling in nodulation directed by a CLAVAT1-like receptor kinase. *Science*, *299*, 109-112.
- Shaw, S. L., and Long, S. R. (2003). Nod factor elicits two separable calcium responses in *Medicago truncatula* root hair cells. *Plant Physiol.*, *131*, 976-984.
- Smit, P., Raedts, J., Portyanko, V., Debelle, F., Gough, T., Bisseling, T., *et al.* (2005). NSP1 of the GRAS protein family is essential for rhizobial Nod factor-induced transcription. *Science*, *308*, 1789-1791.
- Steen, A., Buist, G., Leenhouts, K. J., El Khattabi, M., Grijpstra, F., Zomer, A. L., *et al.* (2003). Cell wall attachment of a widely distributed peptidoglycan binding domain is hindered by cell wall constituents. *J. Biol. Chem.*, *278*, 23874-23881.
- Stracke, S., Kistner, C., Yoshida, S., Mulder, L., Sato, S., Kaneko, T., *et al.* (2002). A plant receptor-like kinase required for both bacterial and fungal symbiosis. *Nature*, *417*, 959-962.

- Surin, B. P., and Downie, J. A. (1988). Characterization of the *Rhizobium leguminosarum* genes *nodLMN* involved in efficient host-specific nodulation. *Mol. Microbiol.*, *2*, 173-183.
- Szczygłowski, K., Shaw, R. S., Wopereis, J., Copeland, S., Hamburger, D., Kasiborski, B., *et al.* (1998). Nodule organogenesis and symbiotic mutants of the model legume *Lotus japonicus*. *Mol. Plant-Microbe Interact.*, *11*, 684-697.
- Terasawa, H., Noda, Y., Ito, T., Hatanaka, H., Ichikawa, S., Ogura, K., *et al.* (2001). Structure and ligand recognition of the PBI domain: A novel protein module binding to the PC motif. *EMBO J.*, *20*, 3947-3956.
- Tsyganov, V. E., Voroshilova, V. A., Priefer, U. B., Borisov, A. Y., and Tikhonovich, I. A. (2002). Genetic dissection of the initiation of the infection process and nodule tissue development in the *Rhizobium-pea* (*Pisum sativum* L.) symbiosis. *Ann. Bot.*, *89*, 357-366.
- Udvardi, M. K., Tabata, S., Parniske, M., and Stougaard, J. (2005). *Lotus japonicus*: Legume research in the fast lane. *Trends Plant Sci.*, *10*, 222-228.
- Van Batenburg, F. H. D., Jonker, R., and Kijne, J. W. (1986). *Rhizobium* induces marked root hair curling by redirection of tip growth: A computer simulation. *Physiol. Plant.*, *66*, 476-480.
- Van Kammen, A. (1984). Suggested nomenclature for plant genes involved in nodulation and symbiosis. *Plant Mol. Biol. Rep.*, *2*, 43-45.
- Veereshlingam, H., Haynes, J. G., Penmetza, R. V., Cook, D. R., Sherrier, D. J., and Dickstein, R. (2004). *nip*, a symbiotic *Medicago truncatula* mutant that forms root nodules with aberrant infection threads and plant defense-like response. *Plant Physiol.*, *136*, 3692-3702.
- Wais, R. J., Galera, C., Oldroyd, G., Catoira, R., Penmetza, R. V., Cook, D., *et al.* (2000). Genetic analysis of calcium spiking responses in nodulation mutants of *Medicago truncatula*. *Proc. Natl. Acad. Sci. USA*, *97*, 13407-13412.
- Wais, R. J., Keating, D. H., and Long, S. R. (2002). Structure-function analysis of Nod factor-induced root hair calcium spiking in rhizobium-legume symbiosis. *Plant Physiol.*, *129*, 211-224.
- Walker, S. A., Viprey, V., and Downie, J. A. (2000). Dissection of nodulation signalling using pea mutants defective for calcium spiking induced by Nod factors and chitin oligomers. *Proc. Natl. Acad. Sci. USA*, *97*, 13413-13418.
- Xu, W., Doshi, A., Lei, M., Eck, M. J., and Harrison, S. C. (1999). Crystal structures of c-Src reveal features of its autoinhibitory mechanism. *Mol. Cell*, *3*, 629-638.
- Young, N. D., Cannon, S. B., Sato, S., Kim, D., Cook, D. R., Town, C. D., *et al.* (2005). Sequencing the genespaces of *Medicago truncatula* and *Lotus japonicus*. *Plant Physiol.*, *137*, 1174-1181.

Chapter 8

LEGUME GENOMICS RELEVANT TO N₂ FIXATION

L. SCHAUSER¹, M. UDVARDI², S. TABATA³,
AND J. STOUGAARD⁴

¹*Bioinformatics Research Center, Høegh-Guldbergs Gade 10,
Building 1090, DK-8000 Aarhus C, Denmark.*

²*Molecular Plant Nutrition Group, Max Planck Institute of
Molecular Plant Physiology, Am Mühlenberg 1, D-14476 Golm, Germany.*

³*Kazusa DNA Research Institute, 1532-3 Yana, Kisarazu, Chiba 292, Japan.*

⁴*Department of Molecular Biology, University of Aarhus,
Gustav Wieds Vej 10, DK-8000 Aarhus C, Denmark.*

1. INTRODUCTION

Following the adoption of two model legumes, *Lotus japonicus* and *Medicago truncatula*, legume genomics has advanced rapidly. Both model genomes are currently being sequenced and large collections of EST sequences that correspond to transcribed genes have been established. This resource is currently used for high-throughput micro-array analysis of global gene-expression patterns. Combined with quantitative RT-PCR, this will take transcriptome analysis to a new level. Proteomics is another high-throughput technology used to investigate the structural components and biochemical pathways involved in symbiotic nitrogen fixation. Determination of low molecular-weight molecules and metabolites, using metabolomics technology, is beginning to have an impact on the understanding of metabolic reactions and pool sizes. Identification of mutants by forward and reverse genetics is adding a complementary resource for functional analysis. The integration of genomics and genetics is a powerful approach for functional description of symbiotic nitrogen fixation and plant-microbe interactions.

Model legume genomics and the continued effort on cultivated grain and pasture legumes open unique possibilities for family-based comparative genomics in the Leguminosae. With the on-going genome sequencing of the two model legumes and growing EST collections from soybean, beans, and other crop legumes, the legume community has an exceptional genomic platform at hand.

Here, we review the genomics resources available to the legume community and describe the first sets of experiments conducted with them.

2. GENOMES

The family Leguminosae consists of three major subfamilies: Caesalpinioideae, Mimosoideae, and Papilionoideae. Together, these three subfamilies comprise more than 18,000 species, rendering the family the third largest amongst all plants. Their lifestyles range from giant rainforest trees to tiny annual herbs, a diversity which is mirrored in the size and complexity of legume genomes.

2.1. Genome Sizes in Cultivated and Model Legumes

Known legume genome sizes (1c) range from 299 Mbp for *Leucaena macrophylla* to 26,852 Mbp for faba-bean (*Vicia faba*; Bennett and Leitch, 2004). Most cultivated legumes have an 'obese' genome, most likely reflecting a combination of large-scale duplication events and accumulation of repetitive elements. For example, the genome size of pea (*Pisum sativum*) is 4,778 Mbp, peanut (*Arachis hypogaea*) 2,813 Mbp, alfalfa (*Medicago sativa*) 1,715 Mbp, soybean (*Glycine max*) 1,103 Mbp and that of common bean (*Phaseolus vulgaris*) 588 Mbp. The legume genetic models *Medicago truncatula* and *Lotus japonicus*, which were selected for their model characteristics, including small genome size, both have a genome size of *ca.* 450 Mbp.

2.2. Genome Structure and Complexity in Crops and Models

Like genome size, genome structure and complexity is variable in the legumes. Chromosome numbers per haploid genome vary from 20 for soybean to 6 for *Lotus*. Most legumes, including the models *Lotus* and *Medicago*, are diploid, although many crops, *e.g.*, alfalfa, white clover, and peanut, are tetraploid.

A major force behind speciation is whole-genome duplication, a result of polyploidization-diploidization cycles (Lynch, 2002). Such events provide the template for rapid evolution of one of the sets of duplicated genes. Also, divergent silencing of duplicated gene copies at many loci may be involved in establishing reproductive barriers. Together, these consequences of whole-genome duplication result in accelerated speciation processes and can lead to 'radiation' patterns of speciation, which are also apparent in legumes.

The statistical analysis of sequence data has enabled researchers to infer ancestral polyploid states in relation to taxon divergence. Old events, which affect large groups of plants, are termed paleopolyploidization, whereas younger events,

which are species specific, are referred to as neopolyploidization. It is now widely agreed that at least one paleopolyploidization event occurred prior to the split between legumes and other dicots and is, thus, common to most dicots (β -duplication; Blanc and Wolfe, 2004; Bowers *et al.*, 2003). This duplication has an inferred age of 170 - 235 Myr, and postdates the divergence from monocots. Bowers *et al.* (2003) also identified evidence of a whole-genome duplication in the common ancestor to mono- and eudi-cotyledons (γ -duplication >235 Myr ago). At least one paleopolyploidization occurred specifically in the legume lineage, just prior to the legume radiation 58 million years ago (termed 'b' in Figure 1; Mudge *et al.*, 2005; Pfeil *et al.*, 2005; Schlueter *et al.*, 2004; see also Blanc and Wolfe, 2004). There is some debate about whether a *Medicago*-specific large-scale duplication event ('a' in Figure 1) took place 8-10 Mya as suggested by Blanc and Wolfe (2004). However, the observation leading to this suggestion can also be explained by a common duplication event prior to divergence between *Medicago* and soybean with differential rates of evolution acting on their genomes since divergence (Pfeil *et al.*, 2005). Soybean has a neopolyploid past, having only recently (3-5 Mya) undergone diploidization ('c' in Figure 1). Homologous chromosomes are still readily identified. These observations have important consequences for the design of comparative studies (see below).

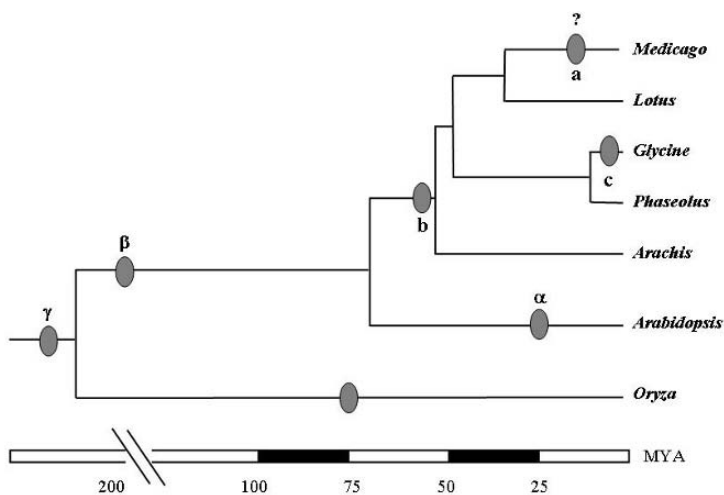

Figure 1. Inferred history of whole genome duplications superimposed on the phylogeny of selected land-plants.

Whole genome duplication events are indicated by ovals. The indicated α , β and γ duplication events have been inferred and named by Bowers *et al.* (2003), whereas the a, b and c events discussed in the text are indicated below the oval.

2.3. Status of Genome Sequencing in Models

Complete sequences of the chloroplast genomes of *Lotus*, *Medicago*, and soybean have been published (Kato *et al.*, 2000; Saski *et al.*, 2005). Within these species, the chloroplast-genome organization is nearly identical and contains 111 genes.

The nuclear genomes of both *Lotus* and *Medicago* are currently being sequenced. The Kazusa DNA Research Institute in Japan has been committed to sequencing most of the euchromatin of *Lotus* since 2000, whereas joint American-European efforts initiated in 2002 are focused on sequencing the *Medicago* genome. These initiatives will provide a great opportunity for comparative analyses and lead to valuable new insights. As of September 2005, *ca.* 164 Mbp of the *Medicago* genome sequence and *ca.* 165 Mbp of the *Lotus* genome sequence were publicly available (Young *et al.*, 2005). Both collections have been assembled using a clone-by-clone strategy with preferential sequencing of gene-rich Bacterial Artificial Chromosomes (BAC) clones. With this bias of clone selection in mind, the current estimates of gene density roughly equal 1 gene per 8 kb in both genomes.

For *Lotus*, a complementary whole genome shotgun (WGS) approach has been applied. 1.6 million reads were accumulated in this effort, giving *ca.* a 2.4-fold genome coverage. The combined non-redundant *Lotus* sequence has a total of 304 Mbp, with an N50 (largest contig length E at which half of the total sum of sequence is contained in entities larger than E) of 4,057 bp. Due to the low coverage of the WGS approach, it is still fragmented. Annotation of the *Lotus* sequence has allowed its gene-potential to be estimated. BAC-clone sequencing has uncovered 18,741 genes, of which 7,494 are derived from retro-elements. The WGS approach has led to the identification of 28,563 genes, but most (22,716) are either only partial genes or genes encoding retro-element-derived proteins.

How complete is our current knowledge about the *Lotus* genome sequence? Given the total length of 450 Mbp and an assembled sequence length of 305 Mbp, the simple answer is 67%. However, the current sequence is strongly biased towards gene-rich regions of the genome and, hence, we may have a more complete picture of the gene content than the simple figures suggest. Several approaches can be used to estimate the amount of biologically relevant information that is currently available, including decoding capacity, miRNAs, and EST coverage.

2.3.1. Decoding capacity

Among the non-coding RNA genes more than 800 tRNA genes were identified. Allowing for codon-wobble, the capacity to translate all codons is provided by this set. Both the decoding potential and the total number of tRNAs is slightly larger than that of *Arabidopsis* (Lowe, 2005), which has 630 tRNAs and no anticodons for Thr (GGT) and Val (GAC). The authenticity and function of a predicted *Lotus* suppressor tRNA (CTA), not present in *Arabidopsis*, remains to be established.

2.3.2. miRNAs

miRNA precursor sequences were identified by first finding genomic regions of homology to experimentally determined short RNAs (20-24 nt) from other

organisms, then extending these hits by 200 bp in the 3' and 5' directions, and finally assessing the folding potential of these regions. In this way, 82 miRNA precursors were identified compared to 117 annotated miRNA genes in *Arabidopsis* (miRNA registry).

2.3.3. EST coverage

88% of the known *Lotus* transcripts, as represented in the non-redundant set of 28,000 TIGR gene indices, match the genome sequence.

Together, these findings point to a rather complete representation of the *Lotus* gene content.

2.4. Genome Conservation and Microsynteny in Models and Crops

Synteny, the retention of gene content and order, is often remarkably conserved during plant evolution, but syntenic relationships are complicated by micro- and macro-rearrangements as well as duplications (Salse *et al.*, 2004). The complete genome sequences of rice and *Arabidopsis*, representing the two major clades of flowering plants, allows comparisons across a great evolutionary distance. In spite of 200 Myr of divergence between rice and *Arabidopsis*, 60 conserved syntenic blocks have been retained, including one region spanning 119 *Arabidopsis* genes (Goff *et al.*, 2002; Salse *et al.*, 2002).

Arabidopsis also shows colinearity to some legume chromosomal regions (Lee *et al.*, 2001). Microsynteny between *Arabidopsis* and *Lotus* was instrumental in the mapping of the *HARI* locus (Krusell *et al.*, 2002). The regions around the *Lotus*, *Medicago*, and soybean *HARI* genes have four paralogous microsyntenic regions in *Arabidopsis*, although none of these carry a *HARI* ortholog (Figure 2; Schnabel *et al.*, 2005). The one-to-four relationship between syntenic legumes and *Arabidopsis* regions observed in several studies (see Mudge *et al.*, 2005; Kevei *et al.*, 2005) reflects the duplication history of the *Arabidopsis* genome. Whether this ratio really reflects a two-to-four relationship awaits a complete legume-genome sequence.

Because no two legume genomes are finished, synteny estimates for this family are uncertain, but a growing number of studies have nevertheless revealed extensive synteny. Based on restriction fragment length polymorphisms (RFLPs), genome conservation extending over entire chromosomes was discovered between mungbean (*Vigna radiata*) and cowpea (*V. unguiculata*; Menancio-Hautea *et al.*, 1993). Similar levels of synteny were also demonstrated between mungbean and common bean (*Phaseolus vulgaris*; Boutin *et al.*, 1995). More limited syntenic regions, of the order of 10–20 cM, were observed between mungbean and the more distantly related soybean (*Glycine max*). Later, Lee *et al.* (2001) observed higher levels of conservation between bean, mungbean, and soybean. Near-complete colinearity of the maps of *Medicago* and pea has been established using 111 gene-based markers (Kaló *et al.*, 2004). This study also identified the chromosomal rearrangement that led to the difference in chromosome number between *Medicago* (8 chromosomes) and pea (7 chromosomes).

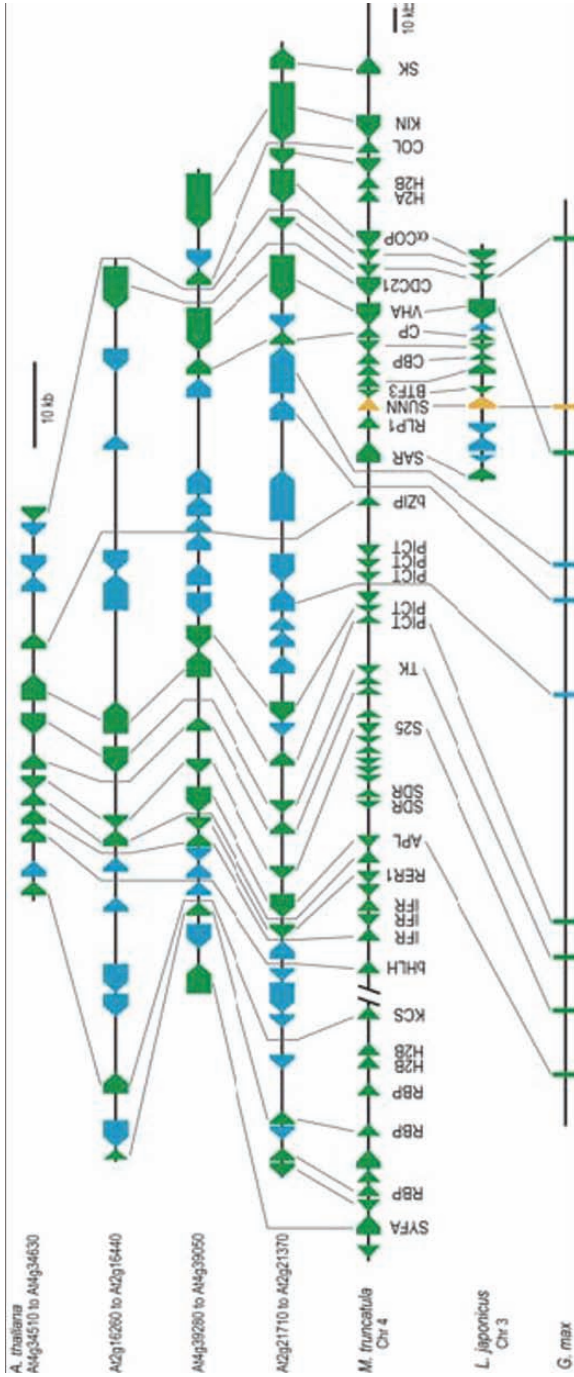

Figure 2: Synteny between the SUNN region of Medicago chromosome 4 (line 5) and duplicated regions of Arabidopsis chromosomes 2 and 4 (lines 1-4), the LjHAR1 region of Lotus chromosome 3 (line6), and the GmNARK region of G. max (line 7).
 From Schnabel et al.(2005) and reproduced with permission.

Abundant synteny was also detected between *Medicago* and soybean when Yan *et al.* (2004) compared homologous genomic regions from these two species; six of eight genome regions exhibited synteny. In a larger study, more than half of the 50 genome regions analyzed exhibited synteny with *Medicago* (Yan *et al.*, 2003). One recent study, which focused on two soybean genomic regions containing cyst nematode-resistance genes, highlights the challenges of comparative genetics. These two large soybean regions exhibit synteny with *Medicago* and also show syntenic relations to several regions in *Arabidopsis* (Mudge *et al.*, 2005). One of these soybean regions is also syntenic to two paralogous regions in *Medicago* on different chromosomes. This observation indicates that the duplication history of angiosperms (see Figure 1) is in fact reflected in many syntenic relationships.

Medicago and *L. japonicus* genome sequences allow direct comparisons at both the macro- and micro-syntenic level. Analysis of ten sequenced BAC/TAC clone pairs showed that 80% of genes were conserved and collinear (Choi *et al.*, 2004). When this analysis was extended by comparing 111 Mb of sequence of these two genomes, more than 75% of both genomes was estimated to reside in conserved syntenic segments (Young *et al.*, 2005).

Two attempts at integrating legume (and other plant species) sequence information have recently been launched; these are the Legume Information System (LIS; Gonzales *et al.*, 2005) and the Plant Genome Resource at the Munich Information Center for Protein Sequences (MIPS). MIPS makes use of the synteny browser SynBrowse (Pan *et al.*, 2005) that allows the flexible display of pre-computed sequence-based alignments. In the MIPS implementation, the user can explore macro- as well as micro-synteny of annotated sequences of *Lotus* and *Medicago* (Figure 3).

Legume genetic maps can be viewed and compared at LIS. The map-comparison browser underlying LIS is built on CMap, which was developed as part of the GMOD (Generic Genome Browser; Stein *et al.*, 2002) project. LIS allows users to view comparisons of genetic and physical map data of soybean (*Glycine max*), barrel medic (*Medicago truncatula*), alfalfa (*Medicago sativa*), common bean (*P. vulgaris*), and peanut (*Arachis hypogaea*). Currently, this viewer allows only the comparison of genetic and physical maps of the same species.

In the absence of genomic sequence information for most of the legumes, a powerful way of information transfer through comparative mapping is based on Comparative Anchor Tagged Sequences (CATS; Lyons *et al.*, 1997), which aim at linking genetic maps of major crops among the 18,000 legume species to the reference genome sequences of *Lotus* and *Medicago*. The main idea behind CATS is that the PCR amplification of polymorphic introns in mapping parents is enabled by using primers which are designed on exon sequences conserved across several legumes. These primers are designed by computational comparison of legume EST collections to the genome sequences of *Medicago* and *Lotus*. There are several current attempts to develop hundreds of such PCR-based markers for the legume community (Choi *et al.*, 2004; Kaló *et al.*, 2004; Kevei *et al.*, 2005; Schauser *et al.*, 2005) plus a web-based tool for the automated mining of CATS using EST collections (<http://cgi-www.daimi.au.dk/cgi-chili/GeneticMarkers/main>; Fredslund

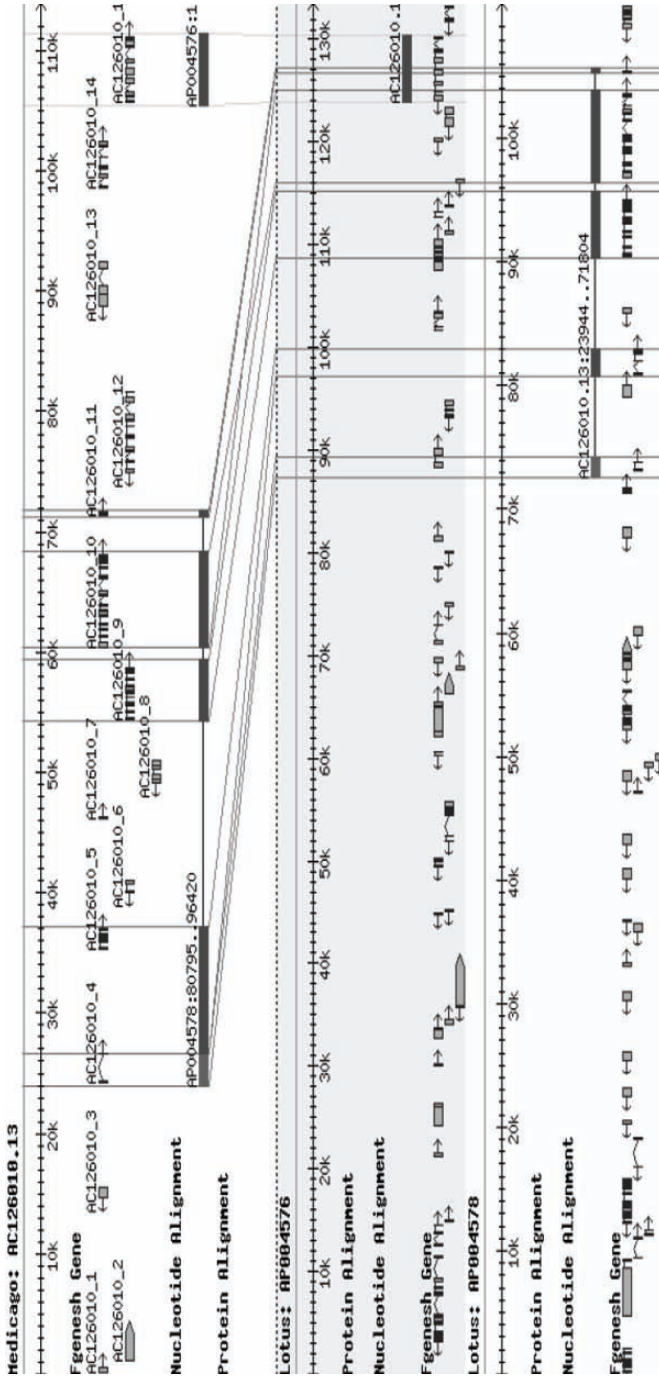

Figure 3. Screenshot from SynBrowse, displaying an alignment of a Medicago BAC to two matching Lotus BACs

et al., unpublished data). This resource, coupled to a comparative map browser such as CMap, should enable maximal use of syntenic relationships in legumes.

Care has to be taken when comparing genetic maps of different legumes, especially with large evolutionary distances between them. This is because the most recent common ancestor to the legume family had undergone a whole-genome duplication, and differential gene loss of paralogous copies in the duplicated regions between the species will confuse the picture.

3. TRANSCRIPTOME ANALYSIS

3.1. EST Collections and Clusters

Three legumes species have large collections of expressed sequence tag (EST) sequence information; these are the two models, *Lotus* and *Medicago*, as well as the economically very important soybean. Several approaches to cluster these highly redundant EST collections have been undertaken (summarized in Table 1). These include PlantGDB-assembled Unique Transcripts (PUT, Dong *et al.*, 2004), NCBI's UniGene (Pontius *et al.*, 2003), TIGRs TCGI (Quackenbush *et al.*, 2001), and LISs XGIs (the Legume Information System, 2004).

Table 1. Transcript sequence information for legumes.

Collection	EST #	PUT	TCGI	TGI	UniGenes
<i>Lotus japonicus</i>	118,000	33,000 clusters	12,500 TCs	21,000	8,200 clusters
			16,000 singletons (Release 3)	contigs 36,000 singletons	representing 60,000 ESTs (Build 3)
<i>Medicago trunculata</i>	217,000	46,000 clusters	18,600 TCs	50,000	5,400 clusters
			18,200 singletons (Release 8)	contigs 132,000 singletons	representing 102,000 ESTs (Build 22)
<i>Glycine max</i>	357,000	87,000 clusters	32,000 Tcs	101,000	15,000 clusters
			31,600 singletons (Release 12)	contigs 233,000 singletons	representing 252,000 ESTs (Build 22)

Because all clustering attempts are based on the same short cDNA reads, their differences relate to the choices of algorithms and stringencies used during assembly. The general procedure for clustering ESTs involves trimming and masking of low-quality vector and low-complexity sequences, followed by clustering and construction of consensus sequences. PUTs and TCGI clusters are constructed using the CAP3 algorithm. The XGI collection is assembled using Phrap/Phred, and Unigenes are based on Megablast comparisons. Aggressive clustering, as performed by TIGR, will give a comprehensive overview of the ESTs at the cost of not resolving paralogous sequences and alternative splice products

very well, whereas 'under'-clustering will result in redundancy in the final collection. All collections have their advantages but, thus far, the TIGR clusters have been most widely used for legume research.

These sequences have been mined by comparing them to sequences from non-legumes in order to identify legume-specific transcripts. When using BLAST, many legume sequences had no significant similarity to non-legume sequences (Fedorova *et al.*, 2002; Graham *et al.*, 2004). However, when analysed with more sensitive Hidden Markov Model (HMM) methods, most of these sequences share motifs with non-legume proteins. Especially notable are the defensin-like cysteine cluster proteins (CCPs) and F-box related proteins, both of which play roles in 'arms races' with microbes. Such sequences are under positive selection and, hence, diversify rapidly. Also, proline-rich cell-wall proteins, which have little sequence constraints apart from matrix-forming cross-linking abilities through proline residues, are of low sequence complexity and, hence, share little sequence similarity.

3.2. Transcriptome Studies of Symbiosis

Genes exclusively expressed or strongly up-regulated in nodules have been termed 'nodulins'. To reflect the timing of their expression, these have been subdivided into 'early' and 'late' nodulins, with the former involved in signal transduction and nodule development and the latter induced at the time when N₂ fixation commences and the mature nodule is established (van Kammen, 1984). Identifying nodulins and characterizing their spatio-temporal expression patterns and function has been, and continues to be, a major focus of the molecular biology of legume symbiosis.

The collections of ESTs are now being used to identify nodulins on a large scale. If sampled from non-normalized libraries, the number of observed ESTs originating from a given gene (cluster) is sometimes taken as an estimate of its expression level. This data-mining approach, termed 'Electronic Northern', has been employed on *Medicago* (Fedorova *et al.*, 2002; Journet *et al.*, 2002; Manthey *et al.*, 2004) to identify more than 350 nodule-specific transcripts. A large fraction (114) of these transcripts encoded small CCPs with a cleavable transit peptide (Fedorova *et al.*, 2002) and homology to defensins. These might be involved in fighting pathogens when the "normal" defence responses are suppressed during symbiosis (Graham *et al.*, 2004).

Large scale expression studies of symbiosis can provide valuable information on the developmental regulation of nodulation and the physiological conditions experienced by the symbionts. Using the EST resources described above, several array-based attempts to map gene-expression changes associated with rhizobial symbiosis have been undertaken. DNA arrays for *Lotus* transcriptome analysis have been produced using PCR-amplified cDNA from 2,300 clones from root nodules (Colebatch *et al.*, 2002), 5,000 partially-redundant clones from root nodules (Colebatch *et al.*, 2004) and, most recently, 18,000 non-redundant clones derived from a variety of organs (Kouchi *et al.*, 2004). Using these arrays, expression

studies of the development and differentiation of root nodules indicated that more than 1,000 identified *Lotus* genes were induced during nodule development.

More recently, Serial Analysis of Gene Expression (SAGE) has been used to investigate expressed nodule-related genes (Asamizu *et al.*, 2005). SAGE is a technology, which uses short transcript-sequence tags of 14 nucleotides in length and relies heavily on sequence data, such as genome or ESTs, for the interpretation of the results. For most tags, the 14-nucleotide information is sufficient to uniquely identify the sequence (EST or genome) of origin. A major advantage over array technology is the ability to discern between paralogous-gene copies. By comparing SAGE tags derived from uninfected roots with tags from nodulating roots, Asamizu *et al.* (2005) were able to identify and distinguish two differentially-expressed symbiotic leghemoglobins, which would not have been resolved by hybridization analysis. A large portion of tags (25-30%) did not match any EST. For some of these, their transcript origin was proven, revealing that the EST collections do not have in-depth cover. These tags will prove particularly useful in future genome-annotation attempts.

Based on the *Medicago* EST information, both macro- and Affymetrix-type microarrays have been manufactured and used for detailed studies of gene expression during nodule development. Cluster-representative ESTs (6,000) that originated from uninoculated roots, root nodules induced by *S. meliloti*, and arbuscular-mycorrhizal roots colonized by *Glomus intrradices*, were PCR amplified and spotted onto arrays (Kuster *et al.*, 2004). These arrays were used to monitor expression changes induced by symbiotic interactions (Kuster *et al.*, 2004; Manthey *et al.*, 2004). Apart from several hundred differentially-expressed genes in nodule/root comparisons, genes specifically induced in one or the other symbiotic relationship were identified. Using the same arrays, El Yahyaoui *et al.* (2004) monitored expression changes during nodule development as a function of time as well as of the *Medicago* and *Sinorhizobium* genetic backgrounds, and identified 750 differentially-regulated genes. Using glass-slide arrays with 6,000 spotted cDNAs, Lohar *et al.* (2006) monitored the transcriptional events of the first 72 hours after *S. meliloti* infection, again identifying hundreds of regulated genes.

A powerful two-genome Affymetrix microarray has recently been designed. It contains probe sets for 10,000 *Medicago* EST clusters as well as the complete *S. meliloti* genome and so allows for the simultaneous transcriptional profiling of both symbiotic partners (Barnett *et al.*, 2004; Mitra *et al.*, 2004a). This chip was used to investigate the very early changes in gene expression (within 24 h) in root tissues upon inoculation with *S. meliloti* (Mitra *et al.*, 2004a) and identified 46 differentially-expressed sequences. Eight of these genes encode nucleolar proteins, whereas others are involved in ribosomal biogenesis, transcription factors, signalling components, defence-response proteins, and stress-response proteins. These genes were also regulated by inoculation with the invasion-defective *S. meliloti* *exoA* mutant and purified Nod factor, but not by *S. meliloti* mutants defective in Nod-factor production. Also, with six *Medicago* non-nodulating mutants (*nfp*, *dmi1*, *dmi2*, *dmi3*, *nsp1* and *nsp2*), inoculation with wildtype *S. meliloti* did not induce any transcriptional responses. The non-nodulating mutant

hcl, however, exhibited a reduced transcriptional response to inoculation with *S. meliloti*.

The same dual-genome chip was used to simultaneously compare bacterial and plant-gene expression during symbiosis, *i.e.*, in nodules, with that of the isolated partners (roots and cultured bacteria, respectively; Barnett *et al.*, 2004). Apart from the known nodulins, 400 new nodule-enhanced transcripts were identified. The genes induced by nodulation with a non-fixing *fixJ* mutant were also induced in wild-type nodules, indicating that many of the nodule-induced genes are involved in nodule morphogenesis and bacterial occupancy rather than influenced by the N₂-fixing status of the nodule. In contrast, most of the 1,300 bacterial genes with differential expression in symbiosis were dependent on the N₂-fixing status of the nodule. Interestingly, 50% of the bacterial genes with differential expression in symbiosis were clustered on the pSymA and pSymB plasmids, indicating replicon specialization.

Most recently, this chip has been used to monitor gene-expression changes in non-fixing *Medicago* mutants by comparison with the wild type 7 days after inoculation (Starker *et al.*, 2006).

A similar Affymetrix symbiosis chip has recently been designed for *Lotus* and *Mesorhizobium loti*. It contains 61,000 features; 52,256 of these correspond to *Lotus* predicted genes and ESTs and 8,572 derive from microsymbiont sequences.

3.3. Clusters and Pathways

Careful comparisons of the *Lotus* root- and nodule-transcriptome datasets generated by Colebatch *et al.* (2002; 2004) identified the coordinated transcriptional regulation of several metabolic pathways that are known to be important in nodule development and function. These include sucrose breakdown, glycolysis, CO₂ fixation, amino-acid biosynthesis, and purine, heme, and redox metabolism. Genes involved in membrane transport, hormone metabolism, cell-wall and protein synthesis, signal transduction, and transcriptional regulation were also up-regulated. Changes of gene expression from specific sets of induced genes served as tell-tale signs of the physiological conditions, such as hypoxia, P-limitation, and osmotic stress, that prevail within nodules.

Suganuma *et al.* (2004) used the 18K spotted arrays to analyze the effect of the early nodule-senescence mutation *sen1* on nodule development and to identify plant genes involved in N₂ fixation. Among the 18 genes with enhanced expression in this mutant were hydrolases, such as cysteine proteases and asparaginase, which might be involved in the early senescence of *sen1* nodules. Nodulins, carbon- and nitrogen-metabolism enzymes, membrane transporters, and enzymes involved in phytohormone and secondary metabolism were among the 30 repressed genes.

In nodules, dicarboxylic acids, like succinate and malate, are the main source of energy for the N₂-fixing bacteroids (McDermott *et al.*, 1989). Using the 'symbiosis' dual-genome chip with probes for both *Medicago* and *S. meliloti* genes showed that bacterial genes expressed at high levels in free-living succinate-grown *S. meliloti*

are not similarly expressed in nodules (Barnett *et al.*, 2004). More specifically, *pckA*, which encodes phosphoenolpyruvate carboxykinase, was 6.5-fold downregulated in this comparison, a finding that is complemented by biochemical and genetic studies (Osteras *et al.*, 1997) as well as proteomics studies (Djordjevic, 2004). In fact, recent studies using knockout mutations show that a complete bacterial citric-acid cycle is not required for N₂ fixation in the *Bradyrhizobium japonicum*-soybean symbiosis (Green and Emerich, 1997; Thöny-Meyer and Kunzler, 1996), raising the question of how the bacteria catabolize dicarboxylic acids. A possible candidate is the malic enzyme, DME, linking the TCA cycle to gluconeogenesis. This enzyme is required for symbiotic N₂ fixation as part of a pathway for the utilization of dicarboxylic acids (Driscoll and Finan, 1997).

4. PROTEOMICS

The large-scale identification of proteins and their complexes is facilitated by mass-spectrometry, a technology that allows the precise identification of peptide masses and, by extension, their amino-acid sequences. Such data, coupled to genome- and EST-sequence information, can be used to identify proteins and to monitor changes in protein expression as a function of developmental stages. Recently, legume-nodule development has been subjected to proteomic studies.

4.1. Early Events

Nodule organogenesis begins by an exchange of signals between plant and bacteria, resulting in the curling and colonization of root hairs by rhizobia. Plant-derived membranes then form a tubular structure, called the 'infection thread', which guides bacteria to the site of meristematic activity in the root cortex and acts as an effective barrier to confine the bacteria. To analyse the first of this series of events at the protein level, Wan *et al.* (2005) employed two-dimensional gel electrophoresis (2-DGE) to separate proteins isolated at different time points from infected soybean-root hairs. Analysis of 133 spots revealed the differential expression of plant proteins associated with important events, such as cytoskeleton reorganization, lipid signalling, regulation of host-sugar availability, and sugar binding.

In a time-course study with clover over the first 48 hours and using 2-DGE monitoring, 16 of over 1500 spots were differentially expressed (Morris and Djordjevic, 2001). Sequencing revealed their identities as proteins also involved in cytoskeleton reorganization, host-sugar availability, and protein folding, suggesting that these processes are conserved in nodulation across species.

4.2. Symbiosome Membrane Proteins

Once the bacteria enter the site of meristematic activity in the root cortex, they are released from the infection thread into these cells and compartmentalized in a new

structure (the symbiosome), where they undergo morphogenic and biochemical metamorphosis into 'bacteroids', which are capable of N₂ fixation. Of special interest is the symbiosome (peribacteroid) membrane, which surrounds rhizobia in infected-nodule cells and mediates the exchange between plant and bacteria of signals and nutrients, including organic acids and nitrogenous compounds. Proteins involved in protein translocation, folding, maturation, and degradation were identified when symbiosome membrane proteins from soybean were investigated by 2-DGE and N-terminal amino-acid sequencing (Panter *et al.*, 2000). There was a bias towards peripheral membrane-associated proteins. Not surprisingly, no integral membrane proteins were detected, probably because hydrophobic proteins, unlike soluble proteins, often precipitate during iso-electric focussing and then do not enter the second-dimension slab gel during SDS-PAGE.

Catalano *et al.* (2004) used 2-DGE and tandem mass spectrometry to investigate the proteome from *Medicago* symbiosome membranes and identified 51 proteins involved in protein destination and storage as well as early nodulins, ATPases, and aquaporin. Because 2-DGE is not well-suited for separation of membrane proteins, Wienkoop and Saalbach (2003) used nano-scale liquid chromatography to separate proteins and peptides obtained from enzymatic protein digestion and coupled this to tandem mass spectrometry. This approach was used to identify 94 proteins associated with the symbiosome membranes in *Lotus*. In addition to transporters that might be involved in nutrient exchange between plant and bacteria, signalling proteins and proteins potentially involved in symbiosome biogenesis were identified.

4.3. Root Nodule-expressed Proteins

The bulk of proteins in the mature root nodule derive from the bacterial partner (Djordjevic, 2004). Following colonisation of developing nodules, the bacteria stop dividing and differentiate into N₂-fixing bacteroids. The proteome of *S. meliloti* bacteroids was compared to that of *S. meliloti* grown in laboratory culture by 2-DGE and peptide mass fingerprinting (Djordjevic, 2004). Reflecting the specialised nature of bacteroids, the overall number of proteins expressed was far lower for bacteroids than for their free-living counterpart (358 vs. 700 spots detectable for isoelectric focussing in the pH range 4-7). Many (165) proteins were uniquely expressed in bacteroids, whereas 507 of those expressed in free-living bacteria were not detectable in bacteroids.

N₂ fixation is a highly energy-demanding process and requires an extremely low O₂ concentration because of the O₂ sensitivity of nitrogenase. Ammonia produced by this process is not utilised by the bacteria, but instead much of it is incorporated into glutamine by the plant. Bacterial nitrogen metabolism relies in large-part on amino acids supplied by the plant (Lodwig *et al.*, 2003). Likewise, other macro- and micro-nutrients are provided by the plant, all of which requires a sophisticated transport system across the symbiosome and bacteroid membranes (Figure 4).

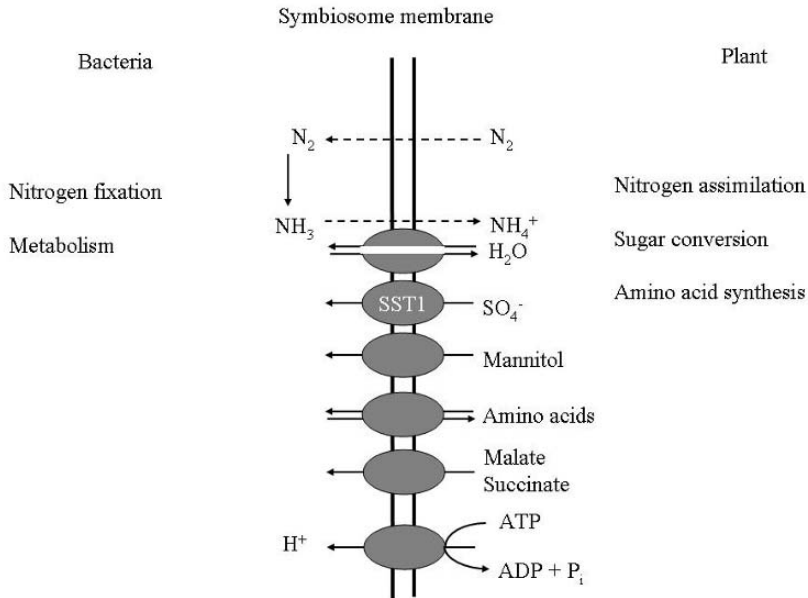

Figure 4. The symbiosome membrane compartmentalizes N₂-fixing bacteroids from assimilating host-plant tissue.

The transport of vital metabolites, amino acids, and nutrients is indicated, together with the type of transport mechanism that applies for the indicated compounds.

N₂ diffuses across the membrane into the bacteroid compartment, whereas ammonium follows the reverse gradient in exchange for protons; aquaporins regulate water transport across the membrane; and the dicarboxylic acids malate and succinate are transported from the plant to the bacteroids by a biochemically defined transporter. The sulfate transporter SST1 is genetically defined (Krusell et al., 2005), whereas the mannitol transporter has been identified by proteomic means (Wienkoop and Saalbach, 2003).

N₂ fixation is conducted by the bacteroid enzymes. Prominent spots on 2-DGE gels are FixB (electron-transfer flavonoid alpha chain), FixC (oxidoreductase protein) and the nitrogenase proteins NifH, NifD, and NifJ. Not detectable in bacteroids are GlnA (glutamine synthetase), nitrogen-metabolism regulatory proteins (NtrC, GlnK and GlnB), and urease. These results support the conclusion that ammonia assimilation is repressed in bacteroids and takes place in the plant compartment instead. A number of amino-acid specific ABC-type transporters uniquely identified in bacteroids are candidates for mediating the plant-to-bacteria transport across the bacteroid membranes.

The host provides the bacteroids with dicarboxylic acids, such as malate and succinate, as the major source of carbon to fuel N₂ fixation. Tricarboxylic acid cycle (TCA) enzymes are present in the bacteroids, although genetic studies indicate

that this cycle is, in part, dispensable for symbiosis. In many species, as well as in cultured *S. meliloti*, the first step in gluconeogenesis is catalysed by phosphoenolpyruvate carboxykinase (PckA). In bacteroids, however, this protein is not detectable (Barnett *et al.*, 2004; Djordjevic, 2004) and the gene is dispensable for the symbiotic interaction (Osteras *et al.*, 1997). A possible link between the TCA cycle and gluconeogenesis could be the malic enzyme DME as mentioned above (Driscoll and Finan, 1997).

Bacteroids synthesize thiamine, vitamin B6, and heme and the required biosynthetic enzymes are found in their proteomes. The presence of stress-related chaperones and heat-shock proteins, as well as stress-related regulators, suggest that bacteroids have to cope with several stresses (Djordjevic, 2004), a finding that complements the analysis of gene expression (Colebatch *et al.*, 2004; see above).

5. METABOLOMICS

5.1. Root-nodule Metabolomics: Metabolic Pathways and Novel Metabolites

Gas chromatography coupled to mass spectrometry (GC-MS) is the method of choice for metabolite profiling in plants (Fiehn *et al.*, 2000) and is currently the major platform for metabolomics in *Lotus* (Colebatch *et al.*, 2004; Desbrosses *et al.*, 2005). To identify metabolites from GC-MS data, a reference library of metabolite mass-spectral tags (MSTs), which are analogous to ESTs for gene transcripts, has been compiled for *Lotus* and other species (Colebatch *et al.*, 2004; Wagner *et al.*, 2003). Metabolomics data, which were obtained by comparing metabolite levels in different biological samples using the MST reference library, were recently combined with parallel transcriptomics data to yield further insight into metabolic differentiation during nodule development (Colebatch *et al.*, 2004). For example, steady-state levels of hexoses and hexose-phosphates in nodules and roots supported conclusions from gene-expression data that significant up-regulation of glycolysis occurs during nodule development (Colebatch *et al.*, 2004). Metabolomic approaches were also used to investigate the biosynthetic pathways for the cyanogenic glucosides, linamarin and lotaustralin, and terpenoids in *Lotus* (Arimura *et al.*, 2004; Forslund *et al.*, 2004); these compounds are thought to play a role in plant–herbivore or plant–insect interactions. The integration of ‘omics’ data from different levels, such as metabolomics with transcriptomics (Colebatch *et al.*, 2004), is helping us to better understand the biochemical processes underlying N₂ fixation in legume nodules.

Principal Component Analysis (PCA) of GC-MS data revealed that many compounds were enriched in nodules compared to other plant organs, including asparagine, glutamate, glutamine, homoserine, cysteine, putrescine, mannitol, threonic acid, gluconic acid, glyceric acid-3-P, glycerol-3-P, and octadecanoic acid (Desbrosses *et al.*, 2005). Some of these results confirm what is known about nodule metabolism. For instance, the ammonium fixed by the bacteria is incorporated by the plant into the amino acids, asparagine and glutamine, prior to

export as amino acids or ureides from nodules to the rest of the plant (Lodwig *et al.*, 2003; Vance, 2000; see Chapters 9 and 10 of this volume). Also, it is known that glycolysis is enhanced in nodules compared to roots, as reflected by the ratio of hexoses-to-hexose phosphates in these organs.

Increased levels of compounds indicative of osmotic stress - the polyols (ononitol, mannitol, and sorbitol), the amino acid proline, and the polyamine putrescine - were found in nodules compared to other organs of *Lotus* (Colebatch *et al.*, 2004; Desbrosses *et al.*, 2005). One explanation for this observation might be hypoxia, which causes osmotic stress in plant cells *via* effects on water uptake and loss (Nuccio *et al.*, 1999). These metabolomic observations complement transcriptome and proteome studies on nodules. Genes encoding putative mannitol transporters are among those induced during nodule development (Colebatch *et al.*, 2004; Fedorova *et al.*, 2002), and these may be involved in importing polyols that are derived from photosynthesis in the shoot (Noiraud *et al.*, 2001). Further, the proteomic study on *Lotus* symbiosome membranes (Wienkoop and Saalbach, 2003) identified a putative mannitol transporter, indicating that polyols may be transported between the plant and bacteroids. Genes involved in proline and polyamine biosynthesis are also induced during nodule development in *Lotus*, possibly accounting for their accumulation (Colebatch *et al.*, 2004; Fletmetakis *et al.*, 2004).

Unusual for plant tissues, high levels of cysteine were found in *Lotus* nodules, which is, however, consistent with the elevated expression in nodules of two genes that encode cysteine synthases (Colebatch *et al.*, 2004). Several genes for sulfate transporters, which might deliver substrate for sulfur metabolism, are also highly induced during *Lotus* nodule development (Colebatch *et al.*, 2002; 2004).

Although bacteroid and plant contributions to the metabolite pool cannot be distinguished, some of the unusual and unidentified compounds accumulated in nodules may be exclusively bacterial products (Desbrosses *et al.*, 2005). Identification of these compounds and their biosynthetic origin may lead to a better understanding of nodule metabolism and the metabolic interactions between legumes and rhizobia.

5.2. Metabolite Transport in Nodules

Transporters are crucial to nodule function, *e.g.*, for importing and distributing sugars to nodule cells and for removing the products of N₂ fixation (including amino acids) for use in the rest of the plant (Udvardi and Day, 1997). Despite their importance in nodules, few transporters have been characterised in detail. Of particular interest from the point of view of plant-microbe interactions are transporters of the symbiosome membrane, which mediate nutrient exchange between plant-cell cytoplasm and the bacteroids. High-throughput methods for proteomics (Panter *et al.*, 2000; Wienkoop and Saalbach, 2003) and transcriptomics (Colebatch *et al.*, 2004; El Yahyaoui *et al.*, 2004; Kouchi *et al.*, 2004) are making in-roads into this area of research and are particularly powerful when combined with genetics and genomics. A good example is the map-based cloning of *LjSst1*,

which encodes a sulfate transporter required for nodule function (Krusell *et al.*, 2005). Map-based cloning of two mutant alleles, *sst1-1* and *sst1-2*, using markers developed from genome-sequence information, led to the identification of a few 'candidate' genes on a sequenced TAC clone, one known to be expressed in a nodule-specific manner from transcriptome analysis (Colebatch *et al.*, 2002). Published proteomic data indicated that the SST1 protein is located in the strategically-important symbiosome membrane (Wienkoop and Saalbach, 2003). Taken together, the data pointed to the *LjSst1* gene being important for nodule function, and subsequent sequencing of the *LjSst1* gene from the two mutants confirmed the presence of mutations in both alleles (Krusell *et al.*, 2005). Yeast complementation analysis showed that SST1 transports sulphate. Our current working model is that SST1 transports this essential nutrient to the bacteroids, where it is presumably important for iron-sulfur protein and co-factor biosynthesis.

A similar story is emerging for the gene defective in two other *sym* mutants, *sym11* and *sym75*, which encode another nodule-specific transporter essential for nodule function (N. Sukanuma, personal communication). Given the powerful tools for reverse genetics and the identification of numerous nodule-induced transporter genes by transcriptomics, we should shortly have a much better understanding of the roles of many more nodule transporters.

6. GENETIC ANALYSIS USING GENOMICS

6.1. Genetic Resources

Genetic analysis and application of genetic approaches in *Lotus* and *Medicago* have advanced rapidly since the proposal of their properties as genetic models (Barker *et al.* 1990; Handberg and Stougaard, 1992).

Mutational saturation is important for comprehensive genetic dissection of symbiosis. In pea, mutagenesis programs, followed by complementation analysis, have revealed at least 40 symbiotic loci (Morzhina *et al.*, 2000; and references therein). Given that not all loci have been found yet and that some genetic redundancy exists, the number of loci for symbiosis is likely to be somewhat higher.

In *Lotus*, seven independent mutant populations have so far been generated by chemical (EMS) mutagenesis (Kawaguchi *et al.*, 2002; Márquez *et al.*, 2005; Perry *et al.*, 2003; Szczyglowski *et al.*, 1998; Webb *et al.*, 2005). Another four populations were obtained after either T-DNA- or transposon-insertion mutagenesis (Buzas *et al.*, 2005; Schauser *et al.*, 1999; Thykjær *et al.*, 1995; Webb *et al.*, 2000) and two more populations made by either fast neutrons (P. M. Gresshoff, unpublished data) or tissue culture (Y. Umehara and H. Kouchi, unpublished data). A promising endogenous retrotransposon-tagging system, based on the LORE1 retrotransposon (Madsen *et al.*, 2005), is currently being developed. LORE1 has already been found in mutant alleles of *nin*, *symRK* and *nup133*. To date, more than 400 *Lotus* mutant lines have been identified in genetic screens for defects in symbiosis.

Several *Medicago* mutagenesis programs have also been conducted. These include γ -ray (Sagan *et al.*, 1995; 1998), EMS (Catoira *et al.*, 2000; Penmetsa and Cook, 1997), and fast-neutron mutagenesis (Oldroyd and Long, 2003). Recently, a retrotransposon-based gene-tagging tool, which makes use of the heterologous tobacco *Tnt1* retrotransposon, has been developed for *Medicago* (d'Erfurth *et al.*, 2003).

Two high-density genetic-linkage maps are now available that enable rapid positional cloning in *Lotus*. One map is based on the inter-specific cross of *L. japonicus* x *L. filicaulis* (Sandal *et al.*, 2002) and contains 735 molecular markers. The second map is based on the intra-specific cross *L. japonicus* ecotype Gifu x ecotype Miyakojima (MG-20) and contains 1250 micro-satellite markers (Hayashi *et al.*, 2001). Recently, these two maps have been aligned. Combining this mapping effort with the genome sequencing at the Kazusa DNA Research Institute, a total of 1250 BACs are now anchored to the genetic-linkage map through molecular markers. A third genetic map was recently established from a cross between *L. japonicus* Gifu and *L. burttii* (Kawaguchi *et al.*, 2005; Sandal *et al.*, 2006) to obtain better genetic resolution in regions showing either suppression of recombination or distorted segregation in one or both of the above mentioned maps. Thus, three different *Lotus* species, *L. japonicus*, *L. filicaulis*, and *L. burttii* form a genetic-mapping triangle. Using these resources, 35 symbiotic loci have been genetically mapped in *Lotus* to date (Figure 5; reviewed in Sandal *et al.*, 2006).

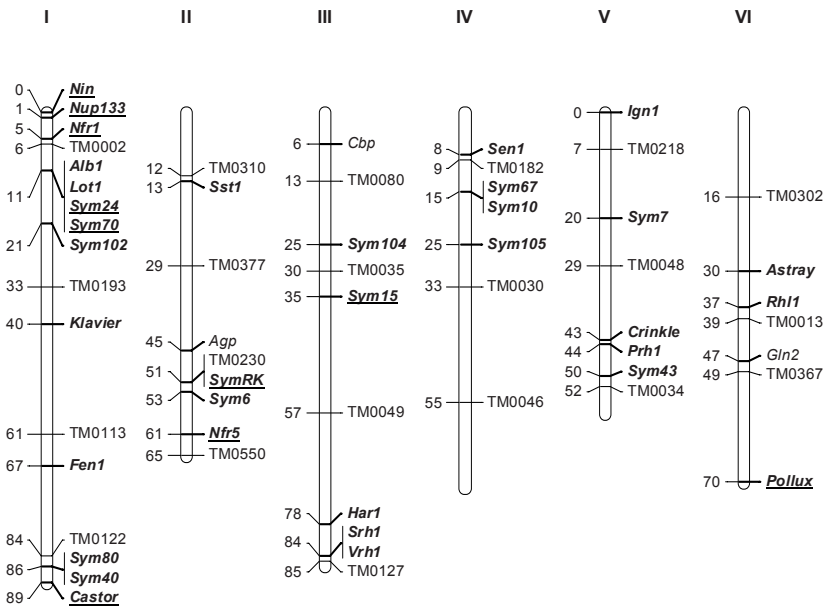

Figure 5. Symbiotic loci of *Lotus* assigned to 6 linkage groups (from Sandal *et al.*, 2006).

In *Medicago*, two genetic maps have been constructed. The map by Thoquet *et al.* (2002) spans 1225 cM and comprises 289 markers, including RAPD, AFLP, known genes, and isoenzymes arranged in 8 linkage groups ($2n = 16$) from a cross between the cultivar Jemalong and the Algerian natural variety (DZA315). A second map has been generated (Choi *et al.*, 2004), which spans 513 cM and comprising 288 genetic markers, from a cross between Jemalong *A17* (the primary experimental genotype) and *A20*. The current map used for the ordered BAC-sequencing program contains more than 600 markers with exact map positions and a further 500 markers with linkage-group assignment (*M. truncatula* sequencing resources, September 2005).

6.2. Recombinant Inbred Lines

Recombinant inbred lines (RILs) are stabilised mapping populations, important for high density map construction and the mapping of Quantitative Trait Loci (QTLs). The main advantage of a RIL population is that recombination events are genetically fixed by the selfing of F₂ individuals through several generations. In later generations, almost all loci are homozygous and the expected number of recombination events represented is twice that of the F₂ generation, giving a more cost-effective mapping population. Progeny of RILs will have an identical genotype and, hence, the recombination events are immortalized. The RILs have been developed from two *Lotus* F₂ mapping populations and bred to the S8 generation (reviewed in Sandal *et al.*, 2006). Presently, 79 RILs have been developed for the *L. filicaulis/L. japonicus* var. Gifu population. In addition, 149 RILs are available from *L. japonicus* Gifu/*L. japonicus* MG-20 population.

7. COMPARATIVE GENOMICS

7.1. Examples of Comparative Studies

An early example of the value of comparative physiology built upon the phenotypic similarity between the pea *sym35* and *Lotus nin* mutants, both of which are defective in nodule initiation and display an excessive root hair-curling phenotype on inoculation by rhizobia. Recognition of this similarity enabled rapid isolation of the *Sym35* gene from pea (Borisov *et al.*, 2003), following cloning of its *Lotus* orthologue (Schauser *et al.*, 1999). Another example is the cloning of the pea ortholog of *MtDMI3* (Lévy *et al.*, 2004; Mitra *et al.*, 2004b). The phenotype of the pea *sym9* mutant resembled that of the *Medicago dmi3* mutant (aberrant root-hair responses but normal Ca²⁺-spiking responses upon inoculation with rhizobia, plus defective mycorrhizal symbiosis) and the sequence of the *Medicago* Ca²⁺-dependent protein kinase was used to isolate the pea ortholog. Many other examples of cross-species orthology exist (see Table 2) and many more will follow. However, in cases where real differences occur, the true value of two model systems for legume genetics will be highlighted. As an example of differences, Nod-factor receptor

mutants, which carry mutations in genes corresponding to the *Lotus LjNFR1* gene, have so far not been found in *Medicago*. Further, *nup133* and *sym24* are *Lotus*-specific mutations. Different levels of gene redundancy affect the efficiency of genetic approaches and influence the type of mutants that can be identified. In the case of *LjNFR1*, redundancy is a possible explanation for the difference between *Lotus* and *Medicago*. In other cases, genuine biological differences may be involved.

Table 2. Comparison of legume genetic loci involved in N₂-fixing symbiosis.

Process	<i>Lotus</i>	<i>Medicago</i>	Pea	Other
Nod-factor recognition		<i>MtHCL</i>		
	<i>LjNFR1</i>	<i>MtLYK3/4</i>	<i>PsSYM2A</i>	
	<i>LjNFR5</i>	<i>MtNFP</i>		
Common symbiosis pathway	<i>LjSYMRK</i>	<i>MtDMI2</i>	<i>PsSYM19</i>	<i>MsNOR</i> <i>SrSYMRK</i>
	<i>CASTOR</i>	<i>MtDMI1</i>		
	<i>POLLUX</i>			
	<i>NUP133</i>			
	<i>LjCCaMK</i>	<i>MtDMI3</i>	<i>PsSYM9</i>	
	<i>LjCYCLOPS</i>			
	<i>LjSYM24</i>			
	<u>Bacterial symbiosis-specific defects</u>			
Root-hair entry		<i>MtNSP1</i>		
	<i>TINOD</i>	<i>MtNSP2</i>	<i>PsSYM7</i>	
	<i>LjNIN</i>		<i>PsSYM35</i>	
Root-nodule function	<i>LjSST1</i>			
	<i>LjLB</i>			
			<i>PsRUG4</i>	
	<i>LjSENI</i>			
Root-nodule autoregulation	<i>LjHARI</i>	<i>MtSUNN</i>	<i>PsSYM29</i>	<i>GmNARK</i>
		<i>MtRLP1</i>		
		<i>MtSICKLE</i>		
	<i>LjKLV</i>			
Enhanced and early nodulation	<i>LjASTRAY</i>			

Nod factor-insensitive legume mutants were identified in pea, *L. japonicus*, and *M. trunculata*. In *L. japonicus*, two loci (*LjNFR1* and *LjNFR5*) were identified, but only a single locus in pea (*PsSYM10*) and *M. trunculata* (*MtNFP*) (Madsen *et al.*, 2003; Radutoiu *et al.*, 2003). Other non-nodulating mutants retain at least some

Nod-factor responsiveness, which is visible as root-hair deformation. The *LjNFR5*, *PsSYM10* and *MtNFP* genes encode LysM-receptor kinases (LysM-RKs) probably located in the plasma membrane (Madsen *et al.*, 2003; Radutoiu *et al.*, 2003). *LjNFR1* also encodes a LysM-RK (Radutoiu *et al.*, 2003), which is a candidate for a Nod-factor receptor acting in a complex with *LjNFR5*.

In pea, a Nod-factor decoration-dependent conditional non-nodulating locus (*PsSYM2*) has been identified (Geurts *et al.*, 1997) and subsequently mapped. Making use of synteny to *PsSYM2*, the orthologous region in *M. trunculata* was isolated. Interestingly, this region contains a cluster of LysM-RK-encoding genes (Limpens *et al.*, 2003). Two of these (*MtLYK3* and *MtLYK4*) showed a phenotype when knocked down by an RNA-interference approach. In the resulting lines, root-hair curling was induced but the formation of infection threads was markedly decreased (Limpens *et al.*, 2003). Because of similarity in sequence, and a similar genomic environment, this gene is likely to be the *Medicago* ortholog of the *Lotus NFR1* (Parniske and Downie, 2003).

Several other components essential for most of the early steps in Nod-factor signalling have been identified; these are active directly downstream of the Nod-factor receptors. In *M. trunculata*, these genes are named *DOESN'T MAKE INFECTIONS1* (*MtDMI1*), *MtDMI2*, and *MtDMI3*, and *NODULATION SIGNALING PATHWAY1* (*MtNSP1*) and *MtNSP2* (Catoira *et al.*, 2000; Oldroyd and Long, 2003). *MtDMI1* encodes a ligand-gated cation channel (Ané *et al.*, 2004), whereas *MtDMI2* encodes a leucine-rich repeat receptor kinase (*MtNORK*; Endre *et al.*, 2002). The *MtDMI3* gene has recently been cloned using a transcript-based approach and through map-base cloning (Levy *et al.*, 2004; Mitra *et al.*, 2004b). The encoded protein is a Ca^{2+} -dependent protein kinase (CCaMK), which may serve to decode the Ca^{2+} -spiking signal. The pea ortholog is encoded at the *PsSYM9* locus (Levy *et al.*, 2004). The *Lotus* ortholog *LjCCaMK* (*SYM15*, *SYM72*) has recently been identified (L. Tirichine and J. Stougaard, unpublished data). *MtNSP1* and *MtNSP2* have been shown to encode *GRAS* genes, which are putative transcriptional regulators (Kaló *et al.*, 2005; Smit *et al.*, 2005) that act downstream of Ca^{2+} -spiking. Their *Lotus* ortholog *LjTINOD* has recently been cloned (Murakami *et al.*, 2006).

In *Lotus*, seven loci involved in the common pathway required for both rhizobial and mycorrhizal symbioses have been identified; these are *LjSYMRK*, *LjNUP133*, *LjCASTOR*, *LjPOLLUX*, *LjCYCLOPS*, *LjCCaMK*, and *LjSYM24* (Kistner *et al.*, 2005). Map-based cloning led to the molecular characterisation of the receptor kinase, *LjSYMRK* and *MtNORK*, and the plastid-localized transmembrane calcium-gated potassium-channel proteins, *LjCASTOR* and *LjPOLLUX*, which are involved in Nod-factor signal transduction (Imaizumi-Anraku *et al.*, 2005; Stracke *et al.*, 2002) as well as the establishment of mycorrhizal symbiosis. A *SYMRK* ortholog from *Sesbania rostrata* has been isolated (Capoen *et al.*, 2005). *LjNUP133* is a nucleoporin required for the induction of Ca^{2+} -spiking (Kanamori *et al.*, 2006).

The developmental regulator *LjNIN* encodes a putative transcription factor (Schauser *et al.*, 1999). Its ortholog in pea has also been isolated (Borisov *et al.*, 2003). Like *LjNIN*, the *MtHCL* gene of *Medicago* controls root-hair curling, with

mutant plants displaying exaggerated root-hair deformations (Catoira *et al.*, 2001). However, in contrast to *LjNIN*, *MtHCL* mutants do initiate nodule primordia.

The locus underlying the enhanced and early nodulating mutation *LjASTRAY* has been isolated and encodes a basic leucine-zipper protein (Nishimura *et al.*, 2002a).

The gene (*LjHARI*) whose mutant form confers hypernodulation has been isolated and encodes a CLAVATA1-type receptor kinase (Krusell *et al.*, 2002; Nishimura *et al.*, 2002b). *LjHARI* orthologs from *Medicago*, pea, and soybean have been isolated (*MtSUNN*, Schnabel *et al.*, 2005; *PsSYM29*, Krusell *et al.*, 2002; *GmNARK*, Searle *et al.*, 2003). In *Lotus*, a second locus (*LjKLV*) has been described (Oka-Kira *et al.*, 2005). An ethylene-insensitive mutant (*Mtsickle*) is also hypernodulating (Penmetsa and Cook, 1997). A pea mutant for sucrose synthase (*Psrug4*) is defective in nodule function, although nodule formation is unimpaired (Gordon *et al.*, 1999). RNAi of symbiotic leghemoglobins *LjLBx* in *Lotus* has a similar effect (Ott *et al.*, 2005), whereas the *Ljst1* mutation of the sulfate transporter SST1 confers non-fixing and slow-nodulating phenotypes (Krusell *et al.*, 2005). A number of other non-fixing mutations have been described for *Lotus*, *Medicago* and pea, but the underlying genes have not yet been identified.

8. CONCLUSIONS

With the advanced legume genomics and genetic resources at hand, the symbiotic N₂-fixation field is entering a phase in which the integration of knowledge gained at multiple layers will advance insights into the system to new levels. The parallel development of two models, *Lotus* and *Medicago*, provides a unique opportunity due to the exceptional power of comparative approaches.

Already, we are witnessing successful cycles of hypothesis generation through genome analysis and bioinformatics, followed by testing in laboratory experiments. As the speed of these cycles increases and new technologies emerge, a systems biology view on symbiotic nitrogen fixation will emerge, enabling us to understand, model, and ultimately engineer the system.

REFERENCES

- Ané, J. M., Kiss, G. B., Riely, B. K., Penmetsa, R. V., Oldroyd, G. E. D., Ayax, C., *et al.* (2004). *Medicago truncatula* DM11 required for bacterial and fungal symbioses in legumes. *Science*, 303, 1364-1367.
- Arimura, G., Ozawa, R., Kugimiya, S., Takabayashi, J., and Bohlmann, J. (2004). Herbivore-induced defense response in a model legume. Two-spotted spider mites induce emission of (E)- β -ocimene and transcript accumulation of (E)- β -ocimene synthase in *Lotus japonicus*. *Plant Physiol.*, 135, 1976-1983.
- Asamizu, E., Nakamura, Y., Sato, S., and Tabata, S. (2005). Comparison of the transcript profiles from the root and the nodulating root of the model legume *Lotus japonicus* by serial analysis of gene expression. *Mol. Plant-Microbe Interact.*, 18, 487-498.

- Barker, D. G., Bianchi, S., Blondon, F., Dattée, Y., Duc, G., Essad, S., *et al.* (1990). *Medicago truncatula*, a model plant for studying the molecular genetics of the rhizobium-legume symbiosis. *Plant Mol. Biol. Rep.*, *8*, 40–49.
- Barnett, M. J., Toman, C. J., Fisher, R. F., and Long, S. R. (2004). A dual-genome Symbiosis Chip for coordinate study of signal exchange and development in a prokaryote-host interaction. *Proc. Natl. Acad. Sci. USA*, *101*, 16636-16641.
- Bennett, M. D., and Leitch, I. J. (2004). Plant DNA C-values database (release 3.0, Dec. 2004) <http://www.rbgekew.org.uk/cval/homepage.html>.
- Blanc, G., and Wolfe, K. H. (2004). Widespread paleoploidy in model plant species inferred from age distributions of duplicate genes. *Plant Cell* *16*, 1667-1678.
- Borisov, A. Y., Madsen, L. H., Tsyganov, V. E., Umehara, Y., Voroshilova, V. A., Batagov, A. O., *et al.* (2003). The sym35 gene required for root nodule development in pea is an ortholog of *nin* from *Lotus japonicus*. *Plant Physiol.*, *131*, 1009–1017.
- Boutin, S. R., Young, N. D., Olson, T. C., Yu, Z. H., Shoemaker, R. C., and Vallejos, C. E. (1995). Genome conservation among three legume genera detected with DNA markers. *Genome*, *38*, 928-937.
- Bowers, J. E., Chapman, B. A., Rong, J., and Paterson, A. H. (2003). Unravelling angiosperm genome evolution by phylogenetic analysis of chromosomal duplication events. *Nature*, *422*, 433-438.
- Buzac, D. M., Lohar, D., Sato, S., Nakamura, Y., Tabata, S., Vickers, C. E., *et al.* (2005). Promoter trapping in *Lotus japonicus* reveals novel root and nodule GUS expression domains. *Plant Cell Physiol.*, *46*, 1202-1212.
- Capoen, W., Goormachtig, S., De Rycke, R., Schroevers, K., and Holsters, M. (2005). SrSymRK, a plant receptor essential for symbiosome formation. *Proc. Natl. Acad. Sci. USA*, *102*, 10369-10374.
- Catalano, C. M., Lane, W. S., and Sherrier, D. J. (2004). Biochemical characterization of symbiosome membrane proteins from *Medicago truncatula* root nodules. *Electrophoresis*, *25*, 519-531.
- Catoira, R., Galera, C., de Billy, F., Penmetsa, R. V., Journet, E. P., Maillet, F., *et al.* (2000). Four genes of *Medicago truncatula* controlling components of a nod factor transduction pathway. *Plant Cell*, *12*, 1647–1666.
- Catoira, R., Timmers, A. C., Maillet, F., Galera, C., Penmetsa, R. V., Cook, D., *et al.* (2001). The HCL gene of *Medicago truncatula* controls *Rhizobium*-induced root hair curling. *Development*, *128*, 1507–1518.
- Choi, H. K., Mun, J. H., Kim, D. J., Zhu, H., Baek, J. M., Mudge, J., *et al.* (2004). Estimating genome conservation between crop and model legume species. *Proc. Natl. Acad. Sci. USA*, *101*, 15289–15294.
- Colebatch, G., Kloska, S., Trevasik, B., Freund, S., Altmann, T., and Udvardi, M. K. (2002). Novel aspects of symbiotic nitrogen fixation uncovered by transcript profiling with cDNA arrays. *Mol. Plant-Microbe Interact.*, *15*, 411–420.
- Colebatch, G., Desbrosses, G., Ott, T., Krusell, L., Montanari, O., Kloska, S., *et al.* (2004). Global changes in transcription orchestrate metabolic differentiation during symbiotic nitrogen fixation in *Lotus japonicus*. *Plant J.*, *39*, 487–512.
- d'Erfurth, I., Cosson, V., Eschstruth, A., Lucas, H., Kondorosi, A., and Ratet, P. (2003). Efficient transposition of the *Tnt1* tobacco retrotransposon in the model legume *Medicago truncatula*. *Plant J.*, *34*, 95-106.
- Desbrosses, G. G., Kopka, J., and Udvardi, M. K. (2005). *Lotus japonicus* metabolic profiling: Development of gas chromatography-mass spectrometry resources for the study of plant-microbe interactions. *Plant Physiol.*, *137*, 1302-1318.
- Djordjevic, M. A. (2004). *Sinorhizobium meliloti* metabolism in the root nodule: A proteomic perspective. *Proteomics*, *4*, 1859-1872.
- Dong, Q., Schlueter, S. D., and Brendel, V. (2004). PlantGDB, plant genome database and analysis tools. *Nucleic Acids Res.*, *32*, D354-D359.
- Driscoll, B. T., and Finan, T. M. (1997). Properties of NAD(+) and NADP(+)-dependent malic enzymes of *Rhizobium (Sinorhizobium) meliloti* and differential expression of their genes in nitrogen-fixing bacteroids. *Microbiology*, *143*, 489-498.
- El Yahyaoui, F., Küster, H., Ben Amor, B., Hohnjec, N., Pühler, A., Becker, A., *et al.* (2004). Expression profiling in *Medicago truncatula* identifies more than 750 genes differentially expressed during nodulation, including many potential regulators of the symbiotic program. *Plant Physiol.*, *136*, 3159-3176.

- Endre, G., Kereszt, A., Kevei, Z., Mihacea, S., Kalo, P., and Kiss, G. B. (2002). A receptor kinase gene regulating symbiotic nodule development. *Nature*, *417*, 962-966.
- Fedorova, M., van de Mortel, J., Matsumoto, P. A., Cho, J., Town, C. D., VandenBosch, K. A., *et al.* (2002). Genome-wide identification of nodule-specific transcripts in the model legume *Medicago truncatula*. *Plant Physiol.*, *130*, 519-537.
- Fiehn, O., Kopka, J., Dormann, P., Altmann, T., Trethewey, R. N., and Willmitzer, L. (2000). Metabolite profiling for plant functional genomics. *Nature Biotechnol.*, *18*, 1157-1161.
- Flemetakis, E., Efroze, R. C., Desbrosses, G., Dimou, M., Delis, C., Aivalakis, G. *et al.*, (2004). Induction and spatial organization of polyamine biosynthesis during nodule development in *Lotus japonicus*. *Mol. Plant-Microbe Interact.*, *17*, 1283-1293.
- Forslund, K., Morant, M., Jørgensen, B., Olsen, C. E., Asamizu, E., Sato, S., *et al.* (2004). Biosynthesis of the nitrile glucosides rhodiocyanoside A and D and the cyanogenic glucosides lotaustralin and linamarin in *Lotus japonicus*. *Plant Physiol.*, *135*, 71-84.
- Geurts, R., Heidstra, R., Hadri, A. E., Downie, J. A., Franssen, H., Van Kammen, A., *et al.* (1997). Sym2 of pea is involved in a nodulation factor-perception mechanism that controls the infection process in the epidermis. *Plant Physiol.*, *115*, 351-359.
- Goff, S. A., Ricke, D., Lan, T. H., Presting, G., Wang, R., Dunn, M., *et al.* (2002). A draft sequence of the rice genome (*Oryza sativa* L. ssp. *japonica*). *Science*, *296*, 92-100.
- Gonzales, M. D., Archuleta, E., Farmer, A., Gajendran, K., Grant, D., Shoemaker, R., *et al.* (2005). The Legume Information Service (LIS): An integrated information resource for comparative legume biology. *Nucleic Acids Res.*, *33*, D660-D665.
- Gordon, A. J., Minchin, F. R., James, C. L., and Komina, O. (1999). Sucrose synthase in legume nodules is essential for nitrogen fixation. *Plant Physiol.*, *120*, 867-878.
- Graham, M. A., Silverstein, K. A. T., Cannon, S. B., and VandenBosch, K. A. (2004). Computational identification and characterization of novel genes from legumes. *Plant Physiol.*, *135*, 1179-1197.
- Green, L. S., and Emerich, D. W. (1997). The formation of nitrogen-fixing bacteroids is delayed but not abolished in soybean infected by an [alpha]-ketoglutarate dehydrogenase-deficient mutant of *Bradyrhizobium japonicum*. *Plant Physiol.*, *114*, 1359-1368.
- Handberg, K., and Stougaard, J. (1992). *Lotus japonicus*, an autogamous, diploid legume species for classical and molecular-genetics. *Plant J.*, *2*, 487-496.
- Hayashi, M., Miyahara, A., Sato, S., Kato, T., Yoshikawa, M., Taketa, M., *et al.* (2001). Construction of a genetic linkage map of the model legume *Lotus japonicus* using an intraspecific F2 population. *DNA Res.*, *8*, 301-310.
- Imaizumi-Anraku, H., Takeda, N., Charpentier, M., Perry, J., Miwa, H., Umehara, Y., *et al.* (2005). Plastid proteins crucial for symbiotic fungal and bacterial entry into plant roots. *Nature*, *433*, 527-531.
- Journet, E. P., van Tuinen, D., Gouzy, J., Crespeau, H., Carreau, V., Farmer, M. J., *et al.* (2002). Exploring root symbiotic programs in the model legume *Medicago truncatula* using EST analysis. *Nucleic Acids Res.*, *30*, 5579-5592.
- Kaló, P., Seres, A., Taylor, S. A., Jakab, J., Kevei, Z., Kereszt, A., *et al.* (2004). Comparative mapping between *Medicago sativa* and *Pisum sativum*. *Mol. Genet. Genomics*, *272*, 235-246.
- Kanamori, N., Madsen, L. H., Radutoiu, S., Frantescu, M., Quistgaard, E. M. H., Miwa, H., *et al.* (2006). A nucleoporin is required for induction of Ca²⁺ spiking in legume nodule development and essential for rhizobial and fungal symbiosis. *Proc. Natl. Acad. Sci. USA*, *103*, 359-364.
- Kato, T., Kaneko, T., Sato, S., Nakamura, Y., and Tabata, S. (2000). Complete structure of the chloroplast genome of a legume, *Lotus japonicus*. *DNA Res.*, *7*, 323-330.
- Kawaguchi, M., Imaizumi-Anraku, H., Koiva, H., Niwa, S., Ikuta, A., Syono, K., and Akao, S. (2002). Root, root hair, and symbiotic mutants of the model legume *Lotus japonicus*. *Mol. Plant-Microbe Interact.*, *15*, 17-26.
- Kawaguchi, K., Pedrosa-Harand, A., Yano, K., Hayashi, M., Murooka, Y., Saito, K., *et al.* (2005). *Lotus burttii* takes a position of the third corner in the *Lotus* molecular genetics triangle. *DNA Res.*, *12*, 69-77.
- Kevei, Z., Seres, A., Kereszt, A., Kalo, P., Kiss, P., Toth, G., *et al.* (2005). Significant microsynteny with new evolutionary highlights is detected between *Arabidopsis* and legume model plants despite the lack of macrosynteny. *Mol. Genet. Genomics*, *274*, 644 - 657.

- Kistner, C., Winzer, T., Pitzschke, A., Mulder, L., Sato, S., Kaneko, T., *et al.* (2005). Seven *Lotus japonicus* genes required for transcriptional reprogramming of the root during fungal and bacterial symbiosis. *Plant Cell*, *17*, 2217-2229.
- Kouchi, H., Shimomura, K., Hata, S., Hirota, A., Wu, G. J., Kumagai, H., *et al.*, (2004). Large-scale analysis of gene expression profiles during early stages of root nodule formation in a model legume, *Lotus japonicus*. *DNA Res.*, *11*, 263-274.
- Krusell, L., Madsen, L. H., Sato, S., Aubert, G., Genua, A., Szczygłowski, K., *et al.* (2002). Shoot control of root development and nodulation is mediated by a receptor-like kinase. *Nature*, *420*, 422-426.
- Krusell, L., Krause, K., Ott, T., Desbrosses, G., Krämer, U., Sato, S., *et al.* (2005). The sulfate transporter SST1 is crucial for symbiotic nitrogen fixation in *Lotus japonicus* root nodules. *Plant Cell*, *17*, 1625-1636.
- Kuster, H., Hohnjec, N., Krajinski, F., El Yahyaoui, F., Manthey, K., Gouzy, J., *et al.* (2004). Construction and validation of cDNA-based Mt6k-RIT macro- and microarrays to explore root endosymbioses in the model legume *Medicago truncatula*. *J. Biotechnol.*, *108*, 95-113.
- Lee, J. M., Grant, D., Vallejos, C. E., and Shoemaker, R. C. (2001). Genome organization in dicots. II *Arabidopsis* as a 'bridging species' to resolve genome evolution events among legumes. *Theoret. Appl. Genet.*, *103*, 765-773.
- Lévy, J., Bres, C., Geurts, R., Chalhoub, B., Kulikova, O., Duc, G., *et al.* (2004). A putative Ca²⁺ and calmodulin-dependent protein kinase required for bacterial and fungal symbioses. *Science*, *303*, 1361-1364.
- Limpens, E., Franken, C., Smit, P., Willemse, J., Bisseling, T., and Geurts, R. (2003). LysM domain receptor kinases regulating rhizobial Nod factor-induced infection. *Science*, *302*, 630-633.
- Lodwig, E. M., Hosie, A. H. F., Bourdès, A., Findlay, K., Allaway, D., Karunakaran, R., *et al.* (2003). Amino-acid cycling drives nitrogen fixation in the legume-*Rhizobium* symbiosis. *Nature*, *422*, 722-726.
- Lohar, D. P., Sharopova, N., Endre, G., Peñuela, S., Samac, D., Town, C., *et al.* (2006). Transcript analysis of early nodulation events in *Medicago truncatula*. *Plant Physiol.*, *140*, 221-234.
- Lowe, T. (2005). <http://lowelab.ucsc.edu/GtRNAdb/Athal/>
- Lynch, M. (2002). Genomics. Gene duplication and evolution. *Science*, *297*, 945-947.
- Lyons, L. A., Laughlin, T. F., Copeland, N. G., Jenkins, N. A., Womack, J. E., and O'Brien, S. J. (1997). Comparative anchor tagged sequences (CATS) for integrative mapping of mammalian genomes. *Nature Genetics*, *15*, 47-56.
- Madsen, E. B., Madsen, L. H., Radutoiu, S., Olbryt, M., Rakwalska, M., Szczygłowski, K., *et al.* (2003). A receptor kinase gene of the LysM type is involved in legume perception of rhizobial signals. *Nature*, *425*, 637-640.
- Madsen, L. H., Fukai, E., Radutoiu, S., Yost, C. K., Sandal, N., Schauser, L., *et al.* (2005). LORE1, an active low copy number TY3-gypsy retrotransposon family in the model legume *Lotus japonicus*. *Plant J.*, *44*, 372-381.
- Manthey, K., Krajinski, F., Hohnjec, N., Firnhaber, C., Pühler, A., Perlick, A. M., *et al.* (2004). Transcriptome profiling in root nodules and arbuscular mycorrhiza identifies a collection of novel genes induced during *Medicago truncatula* root endosymbioses. *Mol. Plant-Microbe Interact.*, *17*, 1063-1077.
- Márquez, A. J., Betty, M., García-Calderón, M., Pal'ove-Balang, P., Díaz, P., and Monza, J. (2005). Nitrate assimilation in *Lotus japonicus*. *J. Exp. Bot.*, *56*, 1741-1749.
- McDermott, T. R., Griffith, S. M., Vance, C. P., and Graham, P. H. (1989). Carbon metabolism in *Bradyrhizobium japonicum* bacteroids. *FEMS Microbiol. Rev.*, *63*, 327-340.
- Medicago truncatula* sequencing resources (2005) <http://www.medicago.org>.
- Menancio-Hautea, D., Fatokun, C. A., Kumar, L., Danesh, D., and Young, N. D. (1993). Comparative genome analysis of mungbean (*Vigna radiata* L. Wilczek) and cowpea (*Vigna unguiculata* L. Walpers) using RFLP mapping data. *Theoret. Appl. Genet.*, *86*, 797-810.
- Mitra, R. M., Gleason, C. A., Edwards, A., Hadfield, J., Downie, J. A., Oldroyd, G. E., *et al.* (2004a). A Ca²⁺/calmodulin-dependent protein kinase required for symbiotic nodule development: Gene identification by transcript-based cloning. *Proc. Natl. Acad. Sci. USA*, *101*, 4701-4705.

- Mitra, R. M., Shaw, S. L., and Long, S. R. (2004b). Six nonnodulating plant mutants defective for Nod factor-induced transcriptional changes associated with the legume-rhizobia symbiosis. *Proc. Natl. Acad. Sci. USA*, *101*, 10217-10222.
- Morris, A. C., and Djordjevic, M. A. (2001). Proteome analysis of cultivar-specific interactions between *Rhizobium leguminosarum* biovar *trifolii* and subterranean clover cultivar Woogenellup. *Electrophoresis*, *22*, 586-598.
- Morzina, E. V., Tsyganov, V. E., Borisov, A. Y., Lebsky, V. K., and Tikhonovich, I. A. (2000). Four developmental stages identified by genetic dissection of pea (*Pisum sativum* L.) root nodule morphogenesis. *Plant Sci.*, *155*, 75-83.
- Mudge, J., Cannon, S. B., Kalo, P., Oldroyd, G. E. D., Roe, B. A., Town, C. D., and Young, N. D. (2005). Highly syntenic regions in the genomes of soybean, *Medicago truncatula*, and *Arabidopsis thaliana*. *BMC Plant Biol.*, *5*, 15.
- Murakami, Y., Miwa, H., Imaizumi-Anraku, H., Kouchi, H., Downie, A. J., Kawaguchi, M., *et al.* (2006). TlNod (transcription initiator for nodulation) induces nodulation via an SH2-like domain in a manner analogous to STAT proteins of animals. *NCBI Nucleotide Entrez* (accession AB241457).
- Nishimura, R., Ohmori, M., Fujita, H., and Kawaguchi, M. (2002a). A *Lotus* basic leucine zipper protein with a RING-finger motif negatively regulates the developmental program of nodulation. *Proc. Natl. Acad. Sci. USA*, *99*, 15206-15210.
- Nishimura, R., Hayashi M., Wu, G. J., Kouchi, H., Imaizumi-Anraku, H., Murakami, Y., *et al.* (2002b). HAR1 mediates systemic regulation of symbiotic organ development. *Nature*, *420*, 426-429.
- Noiraud, N., Mauroussat, L., and Lemoine, R. (2001). Identification of a mannitol transporter, AgMaT1, in celery phloem. *Plant Cell*, *13*, 695-705.
- Nuccio, M. L., and Thomas, T. L. (1999). ATS1 and ATS3: Two novel embryo-specific genes in *Arabidopsis thaliana*. *Plant Mol. Biol.*, *39*, 1153-1163.
- Oka-Kira, E., Tateno, K., Miura, K., Haga, T., Hayashi, M., Harada, K., *et al.* (2005). *klavier* (*klv*), a novel hypernodulation mutant of *Lotus japonicus* affected in vascular tissue organization and floral induction. *Plant J.*, *44*, 505-515.
- Oldroyd, G. E. D., and Long, S. R. (2003). Identification and characterization of *nodulation-signaling pathway 2*, a gene of *Medicago truncatula* involved in Nod factor signaling. *Plant Physiol.*, *131*, 1027-1032.
- Osteras, M., O'Brien, S. A. P., and Finan, T. M. (1997). Genetic analysis of mutations affecting *pckA* regulation in *Rhizobium* (*Sinorhizobium*) *meliloti*. *Genetics*, *147*, 1521-1531.
- Ott, T., van Dongen, J. T., Gunther, C., Krusell, L., Desbrosses, G., Vigeolas, H., *et al.* (2005). Symbiotic leghemoglobins are crucial for nitrogen fixation in legume root nodules but not for general plant growth and development. *Curr. Biol.*, *15*, 531-535.
- Pan, X., Stein, L., and Brendel, V. (2005). SynBrowse: A synteny browser for comparative sequence analysis. *Bioinformatics*, *21*, 3461-3468.
- Panter, S., Thomson, R., de Bruxelles, G., Laver, D., Trevaskis, B., and Udvardi, M. (2000). Identification with proteomics of novel proteins associated with the peribacteroid membrane of soybean root nodules. *Mol. Plant-Microbe Interact.*, *13*, 325-333.
- Parniske, M., and Downie, J. A. (2003). Plant biology: Locks, keys and symbioses. *Nature*, *425*, 569-570.
- Penmetsa, R. V., and Cook, D. R. (1997). A legume ethylene-insensitive mutant hyperinfected by its rhizobial symbiont. *Science*, *275*, 527-530.
- Perry, J. A., Wang, T. L., Welham, T. J., Gardner, S., Pike, J. M., Yoshida, S., *et al.* (2003). A TILLING reverse genetics tool and a web-accessible collection of mutants of the legume *Lotus japonicus*. *Plant Physiol.*, *131*, 866-871.
- Pfeil, B. E., Schlueter, J. A., Shoemaker, R. C., and Doyle, J. J. (2005). Placing paleopolyploidy in relation to taxon divergence: A phylogenetic analysis in legumes using 39 gene families. *Syst. Biol.*, *54*, 441-454.
- Pontius, J. U., Wagner, L., and Schuler, G. D. (2003). UniGene: A unified view of the transcriptome. In: *The NCBI Handbook*. Bethesda, MD: National Center for Biotechnology Information. <http://www.ncbi.nih.gov/books/bookres.fcgi/handbook/ch21d1.pdf>. pp. 21-1 - 21-12.
- Quackenbush, J., Cho, J., Lee, D., Liang, F., Holt, I., Karamycheva, S., *et al.* (2001). The TIGR Gene Indices: Analysis of gene transcript sequences in highly sampled eukaryotic species. *Nucleic Acids Res.*, *29*, 159-164.

- Radutoiu, S., Madsen, L. H., Madsen, E. B., Felle, H. H., Umehara, Y., Grønlund, M., *et al.* (2003). Plant recognition of symbiotic bacteria requires two LysM receptor-like kinases. *Nature*, *425*, 585–592.
- Sagan, M., Morandi, D., Tarengi, E., and Duc, G. (1995). Selection of nodulation and mycorrhizal mutants in the model plant *Medicago truncatula* (Gaertn) after γ -ray mutagenesis. *Plant Sci.*, *111*, 63–71
- Sagan, M., de Laremburgue, H., and Morandi, D. (1998). Genetic analysis of symbiosis mutants in *Medicago truncatula*. In C. Elmerich, A. Kondorosi, and W. E. Newton (Eds.), *Biological nitrogen fixation for the 21st century*. (pp. 317–318). Dordrecht, The Netherlands: Kluwer Academic Publishers.
- Salse, J., Piégu, B., Cooke, R., and Delseny, M. (2002). Synteny between *Arabidopsis thaliana* and rice at the genome level: A tool to identify conservation in the ongoing rice genome sequencing project. *Nucleic Acids Res.*, *30*, 2316–2328.
- Salse, J., Piégu, B., Cooke, R., and Delseny, M. (2004). New *in silico* insight into the synteny between rice (*Oryza sativa* L.) and maize (*Zea mays* L.) highlights reshuffling and identifies new duplications in the rice genome. *Plant J.*, *38*, 396–409.
- Sandal, N., Krusell, L., Radutoiu, S., Olbryt, M., Pedrosa, A., Stracke, S., *et al.* (2002). A genetic linkage map of the model legume *Lotus japonicus* and strategies for fast mapping of new loci. *Genetics*, *161*, 1673–1683.
- Sandal, N., Petersen, T. R., Murray, J., Umehara, Y., Karas, B., Yano, K., *et al.* (2006). Genetics of symbiosis in *Lotus japonicus*: Recombinant inbred lines, comparative genetic maps, and map position of 35 symbiotic loci. *Mol. Plant-Microbe Interact.*, *19*, 80–91.
- Saski, C., Lee, S. B., Daniell, H., Wood, T. C., Tomkins, J., Kim, H. G., *et al.* (2005). Complete chloroplast genome sequence of *Glycine max* and comparative analyses with other legume genomes. *Plant Mol. Biol.*, *59*, 309–322.
- Schauser, L., Roussis, A., Stiller, J., and Stougaard, J. (1999). A plant regulator controlling development of symbiotic root nodules. *Nature*, *402*, 191–195.
- Schauser, L., Fredslund, J., Madsen, L. H., Sandal, N., and Stougaard, J. (2005). A computational pipeline towards the development of comparative anchor tagged sequence (CATS) markers. In M. O. Humphrey (Ed.), *Molecular breeding for the improvement of forage crop and turf*. (pp. 73–81). Wageningen, The Netherlands: Wageningen Academic Publishers.
- Schnabel, E., Journet, E. P., de Carvalho-Niebel, F., Duc, G., and Frugoli, J. (2005). The *Medicago truncatula* *SUNN* gene encodes a *CLV1*-like leucine-rich repeat receptor kinase that regulates nodule number and root length. *Plant Mol. Biol.*, *58*, 809–822.
- Schlueter, J. A., Dixon, P., Granger, C., Grant, D., Clark, L., Doyle, J. J. and Shoemaker, R. C. (2004). Mining EST databases to resolve evolutionary events in major crop species. *Genome*, *47*, 868–876.
- Searle, I. R., Men, A. E., Laniya, T. S., Buzas, D. M., Iturbe-Ormaetxe, I., Carroll, B. J., *et al.* (2003). Long-distance signaling in nodulation directed by a CLAVATA1-like receptor kinase. *Science*, *299*, 109–112.
- Smit, P., Raedts, J., Portyanko, V., Debellé, F., Gough, C., Bisseling, T., *et al.* (2005). NSP1 of the GRAS protein family is essential for rhizobial Nod factor-induced transcription. *Science*, *308*, 1789–1791.
- Starker, C. G., Parra-Colmenares, A. L., Smith, L., Mitra, R. M., and Long, S. R. (2006). Nitrogen fixation mutants of *Medicago truncatula* fail to support plant and bacterial symbiotic gene expression. *Plant Physiol.*, *141*, 671–680.
- Stein, L. D., Mungall, C., Shu, S., Caudy, M., Mangone, M., Day, A., *et al.* (2002). The generic genome browser: A building block for a model organism system database. *Genome Res.*, *12*, 1599–1610.
- Stracke, S., Kistner, C., Yoshida, S., Mulder, L., Sato, S., Kaneko, T., *et al.* (2002). A plant receptor-like kinase required for both bacterial and fungal symbiosis. *Nature*, *417*, 959–962.
- Suganuma, N., Yamamoto, A., Itou, A., Hakoyama, T., Banba, M., Hata, S., *et al.* (2004). cDNA macroarray analysis of gene expression in ineffective nodules induced on the *Lotus japonicus* *sen1* mutant. *Mol. Plant-Microbe Interact.*, *17*, 1223–1233.
- Szczyglowski, K., Shaw, R. S., Wopereis, J., Copeland, S., Hamburger, D., Kasiborski, B., *et al.* (1998). Nodule organogenesis and symbiotic mutants of the model legume *Lotus japonicus*. *Mol. Plant-Microbe Interact.*, *11*, 684–697.

- Thöny-Meyer, L., and Kunzler, P. (1996). The *Bradyrhizobium japonicum* aconitase gene (*acnA*) is important for free-living growth but not for an effective root nodule symbiosis. *J. Bacteriol.*, *178*, 6166-6172.
- Thoquet, P., Ghérandi, M., Journet, E. P., Kereszt, A., Ané, J. M., Prosperi, J. M., *et al.* (2002). The molecular genetic linkage map of the model legume *Medicago truncatula*: An essential tool for comparative legume genomics and the isolation of agronomically important genes. *BMC Plant Biol.*, *2*, 1.
- ThykJaer, T., Stiller, J., Handberg, K., Jones, J., and Stougaard, J. (1995). The maize transposable element *Ac* is mobile in the legume *Lotus japonicus*. *Plant Mol. Biol.*, *27*, 981-993.
- Uchiumi, T., Ohwada, T., Itakura, M., Mitsui, H., Nukui, N., Dawadi, P., *et al.* (2004). Expression islands clustered on the symbiosis island of the *Mesorhizobium loti* genome. *J. Bacteriol.*, *186*, 2439-2448.
- Udvardi, M. K., and Day, D. A. (1997). Metabolite transport across symbiotic membranes of legume nodules. *Annu. Rev. Plant Physiol. Plant Mol. Biol.*, *48*, 493-523.
- Vance, C. P. (2000). Amide biosynthesis in root nodules of temperate legumes. In E. Triplett (Ed.), *Prokaryotic nitrogen fixation: A model system for the analysis of a biological process*. (pp. 589-607). Wymondham, UK: Horizon Scientific Press.
- van Kammen, A. (1984). Suggested nomenclature for plant genes involved in nodulation and symbiosis. *Plant Mol. Biol. Rep.*, *2*, 43-45.
- Wagner, C., Sefkow, M., and Kopka, J. (2003). Construction and application of a mass spectral and retention time index database generated from plant GC/EI-TOF-MS metabolite profiles. *Phytochemistry*, *62*, 887-900.
- Wan, J., Torres, M., Ganapathy, A., Thelen, J., DaGue, B. B., Mooney, B., *et al.* (2005). Proteomic analysis of soybean root hairs after infection by *Bradyrhizobium japonicum*. *Mol. Plant-Microbe Interact.*, *18*, 458-467.
- Webb, K. J., Robbins, M., Wang, T. L., Parniske, M., and Márquez, A. J. (2005). Mutagenesis. In A. J. Márquez (Ed.), *Lotus japonicus handbook*. (pp. 177-186). Dordrecht, The Netherlands: Springer.
- Webb, K. J., Skot, L., Nicholson, M. N., Jorgensen, B., and Mizen, S. (2000). *Mesorhizobium loti* increases root-specific expression of a calcium-binding protein homologue identified by promoter tagging in *Lotus japonicus*. *Mol. Plant-Microbe Interact.*, *13*, 606-616.
- Wienkoop, S., and Saalbach, G. (2003). Proteome analysis. Novel proteins identified at the peribacteroid membrane from *Lotus japonicus* root nodules. *Plant Physiol.*, *131*, 1080-1090.
- Yan, H. H., Mudge, J., Kim, D. J., Shoemaker, R. C., Cook, D. R., and Young, N. D. (2004). Comparative physical mapping reveals features of microsynteny between *Glycine max*, *Medicago truncatula*, and *Arabidopsis thaliana*. *Genome*, *47*, 141-155.
- Young, N. D., Cannon, S. B., Sato, S., Kim, D., Cook, D. R., Town, C. D., *et al.* (2005). Sequencing the genespaces of *Medicago truncatula* and *Lotus japonicus*. *Plant Physiol.*, *137*, 1174-1181.

Chapter 9

PHYSIOLOGY OF ROOT-NODULE BACTERIA

P. S. POOLE¹, M. F. HYNES², A. W. B. JOHNSTON³,
R. P. TIWARI⁴, W. G. REEVE⁴, AND J. A. DOWNIE⁵

¹*School of Biological Sciences, University of Reading, Reading RG6 6AJ, UK.*

²*Biological Sciences, University of Calgary,
Calgary T2N 1N4, Canada.*

³*School of Biological Sciences, University of East Anglia,
Norwich NR4 7TJ, UK.*

⁴*School of Biological Sciences and Biotechnology,
Murdoch University, Murdoch, Western Australia 6150.*

⁵*John Innes Centre, Colney Lane, Norwich NR4 7UH, UK.*

1. INTRODUCTION

In this chapter, we review the general physiology of root-nodule bacteria, which we refer to collectively as rhizobia. This is a very broad subject, so we limit ourselves to rhizobia in their free-living (or cultured) state and in the transition to their differentiated bacteroid forms in root nodules. We focus on the essentials of metabolism, growth, response to the environment, and adaptation to stress, and aim to complement other more specialised chapters on the response of rhizobia to oxygen and oxidants (see Chapter 11 of this volume) and legume signals (see Chapter 5 of this volume).

The physiology of rhizobia should be considered in the context of their contrasting life styles. They must survive for extended periods in soils, often under salt or pH stress, be able to adapt to the nutrient rich but highly competitive rhizosphere, and finally be able to enter into an exquisitely specific symbiosis with cognate legume hosts. This variety of lifestyles is probably reflected in their large complex genomes, which can encode the wide spectrum of metabolic diversity.

2. INTRODUCTION TO CENTRAL METABOLISM

The rhizobia have large complex genomes, ranging in size from 6.5 Mb (*Sinorhizobium*) to 9.0 Mb (*Bradyrhizobium*) (Kaneko *et al.*, 2000; 2002; Galibert *et al.*, 2001a). Other genome sequences have been completed for *Rhizobium etli* and *Rhizobium leguminosarum* (Wellcome Trust Sanger Institute; http://www.sanger.ac.uk/Projects/R_leguminosarum/). The assignment of rhizobia to particular genera and species is considered in Chapter 2. Many genes in the large rhizobial genomes are devoted to transport and to catabolic systems (Boussau *et al.*, 2004). For example, rhizobia have approximately 170 ABC-transport systems compared to the 47 in *Escherichia coli*, all of which afford the former access to a far greater range of nutrients present at low concentrations in the soil and rhizosphere.

Intriguingly, rhizobial species differ greatly from each other in their “accessory” genes, those not essential for either growth or symbiotic N₂ fixation. For example, 35% of all the predicted *Mesorhizobium loti* genes have no ortholog in *Sinorhizobium meliloti*. The different species of rhizobia may, therefore, use very varied metabolic and life-style strategies to adapt to multiple environments in the soil and on plant roots. In the first section of this chapter, we will summarise central carbon and nitrogen metabolism before considering other metabolic pathways that may be important in the soil, rhizosphere, and possibly in the early stages of nodule formation.

A key feature of the central metabolism of most rhizobia is that they are obligate micro-aerophiles, but it should be noted that some rhizobia, such as *Bradyrhizobium*, can use alternative electron acceptors, such as nitrate and nitrite, to grow anaerobically (Polcyn *et al.*, 2003). There is also another fascinating subgroup of photosynthetic bacteria (Giraud *et al.*, 2000; Giraud and Fleischman, 2004) in which photosynthetic electron transport makes a substantial contribution to N₂ fixation *in planta*. These examples demonstrate that any statement about the general features of rhizobial metabolism must be made cautiously.

2.1. Central Carbon Metabolism: Sugar and Polyol Catabolism

Free-living rhizobia use the Entner-Doudoroff and pentose-phosphate pathways to catabolise sugars, the Emden-Meyerhof pathway being absent (see review by Lodwig and Poole, 2003). The dependence on the Entner-Doudoroff pathway for sugar catabolism and the pentose-phosphate pathway for biosynthesis has recently been confirmed for *S. meliloti* by metabolic-flux ratio (METAFoR) analysis (Fuhrer *et al.*, 2005). This technique relies on the incorporation of ¹³C-labelled glucose into proteinogenic amino acids and their detection by gas chromatography-mass spectroscopy (GC-MS). Although sugar metabolism may be important for growth of rhizobia in the rhizosphere, both pea and clover bacteroids, which are defective for either glucokinase or fructokinase, are unaltered in N₂ fixation (Glenn *et al.*,

1984; Ronson and Primrose, 1979). Gfp fusions in genes, such as that for α -galactosidase, have shown that *S. meliloti* is exposed to α -galactosides in the rhizosphere (Bringhurst *et al.*, 2001). This approach of tagging with Gfp the genes that are induced by specific compounds holds great promise for assaying gene expression in the rhizosphere and during rhizobial growth in the infection thread.

It has long been known that fast-growing *R. leguminosarum* and *S. meliloti*, but not the slow-growing *B. japonicum*, grow on disaccharides, such as sucrose (Glenn and Dilworth, 1981; Marsudi *et al.*, 1999; Wagner *et al.*, 1995). Genes for several sugar ABC transporters have been characterised, including *aglEFGAK* for α -glucosides (trehalose, sucrose, and fructose) (Willis and Walker, 1999), *agpABCD* for α -glucosides (*e.g.*, melibiose and raffinose) (Bringhurst *et al.*, 2001; Gage and Long, 1998), *thuEFGK* (trehalose, sucrose and maltose) (Jensen *et al.*, 2002), and *frcBCAK* (fructose) (Lambert *et al.*, 2001). Some have genes for a catabolic enzyme associated with them, such as the α -glucosidase, *aglA*, in the *agl* transport operon and α -galactosidase, *mela* (also called *agal*), upstream of *agpABCD*.

Polyols are metabolised at high rates by rhizobia. Mannitol, in particular, is often used as a primary carbon substrate for growth (Primrose and Ronson, 1980). The cyclic polyol, *myo*-inositol, is also an excellent carbon source and important for nodulation competitiveness in *R. leguminosarum* and for bacteroid development and N₂ fixation in *S. fredii* (Fry *et al.*, 2001; Galbraith *et al.*, 1998; Jiang *et al.*, 2001). The importance of *myo*-inositol utilisation can be seen with catabolic mutants of both *R. leguminosarum* and *S. fredii* that are profoundly affected in competition with the wild type for nodulation and, in the case of *S. fredii*, the bacteroids do not fix nitrogen (Fry *et al.*, 2001; Jiang *et al.*, 2001). These results suggest that *myo*-inositol catabolism is required during early steps in bacteroid development or perhaps growth in the infection thread.

2.2. Gluconeogenesis

The rhizobia carry out gluconeogenesis *via* the classical gluconeogenic pathway, using phosphoenolpyruvate carboxykinase and fructose *bis*-phosphate aldolase (see review by Ludwig and Poole, 2003). In *R. leguminosarum*, these two enzymes are repressed (by 80%) by low levels of sugar (0.1 mM sucrose) (McKay *et al.*, 1985). By contrast, phosphoenolpyruvate carboxykinase (*pckA*) in *S. meliloti* is induced by the presence of dicarboxylates, but is not strongly repressed by either glucose or sucrose (Osteras *et al.*, 1995). Primer-extension analysis of *pckA* revealed a σ^{70} -like promoter and a *pckA::lacZ* fusion showed induction both by succinate or arabinose and by growth into stationary phase in complex medium (Osteras *et al.*, 1995).

Pea bacteroids have derepressed activities of gluconeogenic enzymes, consistent with only limited amounts of sugars reaching the bacteroid (McKay *et al.*, 1985). However, gluconeogenic mutants of *R. leguminosarum* bv. *viciae* are Fix⁺, *i.e.*, fix N₂ at the same rate as wild type, suggesting that sufficient sugar is able to reach the bacteroid for biosynthetic purposes, presumably by diffusion.

Gluconeogenic mutants can have complex phenotypes, with phosphoenolpyruvate carboxykinase mutants (*pckA*) of *Rhizobium* NGR234 being Fix-reduced, *i.e.*, fix N₂ at rates significantly less than wild type, on *Leucaena leucocephala* and *Macroptilium atropurpureum*, but Fix⁻, *i.e.*, cannot fix any N₂, on *Vigna unguiculata* (Osteras *et al.*, 1991). *PckA* mutants of *S. meliloti* are also Fix-reduced, whereas mutants defective in enolase, glyceraldehyde-3-phosphate dehydrogenase or 3-phosphoglycerate kinase are Fix⁻ on alfalfa. It is possible that the last three mutations affect sugar metabolism very broadly because they are not specific for gluconeogenesis, which would explain why their Fix phenotype is more severe than that of *pckA* mutants. *R. etli pckA* mutants are also Fix⁻ on bean (Tate *et al.*, 2004), so it seems that many rhizobia, but not all, are unable to obtain sufficient quantities of sugar from the plant during symbiosis.

2.3. Organic acid Metabolism and Regulation of the TCA Cycle

This general area has been reviewed extensively (Dunn, 1998; Lodwig and Poole, 2003; Poole and Allaway, 2000). The key feature of most rhizobia is that they are obligate micro-aerophiles that use the TCA cycle for oxidation of organic acids and all of the TCA-cycle enzymes have been detected in cultured bacteria and in legume bacteroids (McKay *et al.*, 1989).

2.4. Regulation of the 2-Oxoglutarate Complex by O₂

The TCA cycle may be inhibited by the low O₂ tension in the nodule, particularly at the step of the 2-oxoglutarate dehydrogenase complex (Salminen and Streeter, 1987; Streeter, 1990) that leads to glutamate synthesis. The genes encoding the 2-oxoglutarate dehydrogenase complex have been cloned and mutated in *R. leguminosarum* and *B. japonicum* (Green and Emerich, 1997a; Walshaw *et al.*, 1997c). The genes for the 2-oxoglutarate complex in *R. leguminosarum* are part of an operon, *mdh-sucCDAB*, which includes malate dehydrogenase and succinyl-CoA synthetase (Walshaw *et al.*, 1997c). The *mdh* gene codes for malate dehydrogenase and *sucCD* code, respectively, for the β- and α-subunits of succinyl-CoA synthetase, whereas *sucAB* code for the 2-oxoglutarate dehydrogenase component (E1) and the dihydroliipoamide succinyltransferase component (E2) of the 2-oxoglutarate dehydrogenase complex.

In *R. leguminosarum*, the genes of the *mdh-suc* operon appear to be transcriptionally coupled. Mutations in any upstream gene prevent expression of the products of downstream genes; conversely, mutation of a downstream gene increases the activity of the enzymic products of upstream genes (Poole *et al.*, 1999; Walshaw *et al.*, 1997c). Furthermore, the *mdh* promoter is the principal one for the whole operon. In *B. japonicum*, *mdh* is monocistronic and *sucA* has a separate promoter that extends down to *sucB*, *scdA* and *lpdA* (Green *et al.*, 2003).

Malate dehydrogenase mutants could not be isolated in *R. leguminosarum*, perhaps consistent with an essential role for this enzyme in an obligate microaerophile (Poole *et al.*, 1999). However, mutants could be isolated in the *mdh* gene of *S. meliloti* when a transposon with an outwardly directed promoter was used (Dymov *et al.*, 2004), indicating that insertions in *mdh* are lethal because they are polar on the *suc* genes.

2.5. A Full TCA Cycle May Not Be Needed in Some Bacteroids

2-Ketoglutarate dehydrogenase mutants of *R. leguminosarum* and *S. meliloti* form Fix^- nodules on peas and alfalfa, respectively (Duncan and Fraenkel, 1979; Walshaw *et al.*, 1997c). However, soybeans inoculated with a *sucA* mutant are delayed in nodulation and show reduced bacteroid proliferation but still produce low rates of acetylene reduction (Green and Emerich, 1997a; Green and Emerich, 1999). When the rate is expressed on a bacteroid basis, it is equivalent to the wild type, a result confirmed with studies on isolated bacteroids incubated in flow chambers (Green *et al.*, 2000). These results suggest that, although full expression of the TCA cycle in *B. japonicum* is important for growth and infection, preventing steps of the TCA cycle subsequent to the 2-oxoglutarate dehydrogenase complex does not adversely affect N_2 fixation. Mutation of the aconitase gene (*acnA*) of *B. japonicum* produces a metabolically crippled strain that grows very poorly on all tested growth media but forms effective N_2 -fixing nodules (Thony-Meyer and Kunzler, 1996). Because bacteroids were not assayed for aconitase activity, it is not possible to say whether a second aconitase activity is present in the bacteroids, but the recent genome sequence of *B. japonicum* USDA110 contains only one aconitase gene (*acnA*) and no other genes with marked homology to it. At the very least, the results with 2-oxoglutarate dehydrogenase and aconitase suggest that a fully functioning TCA cycle may not be needed in *B. japonicum* bacteroids, where a non-cyclic pathway or a bypass may be used. For example, it has been shown that *B. japonicum* has a 2-ketoglutarate decarboxylase enzyme, which can bypass the 2-ketoglutarate dehydrogenase step (Green *et al.*, 2000). This alone would not explain the apparent ability to dispense with aconitase activity, but there are alternatives - the storage of carbon as PHB or the use of an amino acid-cycling pathway where there is no net transfer of carbon to the bacteroid (Lodwig *et al.*, 2003).

S. meliloti isocitrate dehydrogenase mutants (*icd*) are able to nodulate but are Fix^- (McDermott and Kahn, 1992). As expected, these mutants are glutamate auxotrophs because they cannot make 2-oxoglutarate from isocitrate. *R. tropici* has two citrate synthases, one of which is on the symbiotic plasmid and the other is chromosomal (Hernandezlucas *et al.*, 1995; Pardo *et al.*, 1994). Mutation of either gene alone does not prevent N_2 fixation but mutation of both does. Interestingly, mutation of the plasmid copy of citrate synthase (*pcsA*) reduced nodule number by 30-50%. As discussed above, 2-ketoglutarate dehydrogenase mutants of *R. leguminosarum* and *S. meliloti* are Fix^- .

2.6. Malic Enzyme

Malic enzyme appears to be important for growth on dicarboxylates as a carbon source because it produces the pyruvate needed for subsequent acetyl-CoA synthesis. A number of groups have measured malic enzyme in *S. meliloti*, *R. leguminosarum* and *B. japonicum* and, in all cases, found there are two malic enzymes, one of which is NAD⁺-specific and another which is NADP⁺-specific (Chen *et al.*, 1997; 1998; Copeland *et al.*, 1989; Driscoll and Finan, 1993; 1996; 1997; Kimura and Tajima, 1989; Mitsch *et al.*, 1998; Tomaszewska and Werner, 1995). Both the NAD⁺ and NADP⁺ malic enzyme have been cloned and mutated in *S. meliloti* and the NAD⁺, but not NADP⁺ malic enzyme, found to be essential for N₂ fixation (Driscoll and Finan, 1993).

2.7. Accessory Pathways to the TCA Cycle

It has been proposed that carbon metabolism may be regulated by a glutamine cycle (Duran and Calderon, 1995; Duran *et al.*, 1995; Encarnacion *et al.*, 1998). Likewise, the GABA shunt has received attention but a lack of detectable glutamate decarboxylase and the absence of this gene from recent genome sequences suggests the pathway is not active (Fitzmaurice and O'Gara, 1991; 1993; Jin *et al.*, 1990; Kouchi *et al.*, 1991; Miller *et al.*, 1991; Salminen and Streeter, 1990). However, although glutamate catabolism *via* the GABA shunt may not be important, GABA itself may be metabolised, as evidenced by the induction of the GABA-transaminase gene in pea bacteroids (Prell *et al.*, 2002).

Malonate is present at very high concentrations in some legume nodules, such as clover and soybean, and is catabolised *via* activation to malonyl-CoA and decarboxylation to acetyl-CoA. Mutants in *matB* (malonyl-CoA synthetase) are unable to fix nitrogen on clover (An *et al.*, 2002; Kim, 2002). Malonate is a competitive inhibitor of succinate dehydrogenase, so that the catabolism of malonate may be important to protect succinate dehydrogenase from inactivation. It would be interesting to know whether malonate-transport mutants, *matC*, are also Fix⁻ because this would prevent the entry of malonate into the bacteroid. Malonate-transport mutants would help address the question of whether malonate is an important carbon source or simply must be detoxified.

2.8. Dicarboxylate Transport

R. leguminosarum and *S. meliloti* transport the dicarboxylates, L-malate, fumarate, and succinate with high affinity ($K_m < 10 \mu\text{M}$) and aspartate with a low affinity *via* the C₄-dicarboxylic-transport system using a proton-symport mechanism (Lodwig and Poole, 2003). Aspartate and orotate are also transported by the Dct system (Reid *et al.*, 1996; Watson *et al.*, 1993; Yurgel *et al.*, 2000). However, the main high affinity-transport system for aspartate in *R. leguminosarum* is the Aap

(Walshaw and Poole, 1996). The Dct system consists of three genes: *dctA*, which codes for the putative transport protein; and the divergently transcribed two-component sensor and regulator genes, *dctB* and *dctD*, which activate transcription of *dctA* in response to the presence of dicarboxylates (Lodwig and Poole, 2003). DctA has 12 membrane-spanning helices, typical of membrane-transport proteins, with the N-terminus and C-terminus located in the cytoplasm (Jording and Pühler, 1993). In free-living cultures, mutations in any of the three *dct* genes results in the loss of the ability to transport and grow on C₄-dicarboxylates (Lodwig and Poole, 2003). Strains mutated in *dctA* are Fix⁻ on plants and isolated bacteroids do not transport C₄-dicarboxylates.

2.9. Carbon Storage Compounds

2.9.1. Polyhydroxybutyrate

Poly-3-hydroxybutyrate (PHB) is a carbon storage compound that is synthesised by a wide range of rhizobia under appropriate conditions in free-living culture. Species such as *B. japonicum*, *Rhizobium* sp. NGR234, *R. leguminosarum* bv. *phaseoli* and *R. etli* accumulate large pools of PHB in bacteroids, whereas others such as *S. meliloti* and *R. leguminosarum* accumulate very little (Bergersen and Turner, 1993; Bergersen *et al.*, 1991; Cevallos *et al.*, 1996; Herrada *et al.*, 1989; Povoletto *et al.*, 1994; Tombolini and Nuti, 1989; Walshaw *et al.*, 1997c). *B. japonicum* bacteroids accumulate up to 50-70% of their dry weight as PHB (Bergersen and Turner, 1990). By contrast, free-living cultures of *S. meliloti* and *R. leguminosarum* can, respectively, accumulate PHB amounting to 50% and up to 46% of dry weight, but produce very little in bacteroids. Overall, bacteroids of indeterminate nodules do not accumulate large electron-transparent granules of PHB, whereas bacteroids from determinate nodules do. The most dramatic effect of preventing PHB biosynthesis occurs in *Azorhizobium caulinodans*, where it abolishes nitrogenase activity *ex planta* and induces Fix⁻ nodules from which bacteria could not be recovered (Mandon *et al.*, 1998).

The degradation of PHB has only been studied in detail in *S. meliloti*, which has several transcriptional units involved on both the chromosome and the megaplasmid, pRmeSU47b (Aneja and Charles, 1999; Charles *et al.*, 1997). The gene for the first step in PHB degradation, 3-hydroxybutyrate dehydrogenase (*bdhA*), has been characterised (Aneja and Charles, 1999). It is not known why methylmalonyl-CoA mutase is also required (Charles and Aneja, 1999).

2.9.2. Glycogen Biosynthesis

The pathway for glycogen metabolism in bacteria begins with the isomerisation of glucose-6-phosphate to glucose-1-phosphate by phosphoglucomutase (Pgm). This is converted to ADP-glucose by ADP-glucose phosphorylase (GlgC), and polymerised by glycogen synthase (GlgA) to form α -1,4 linkages. Subsequently, branching enzyme (GlgB) forms α -1,6-glycosidic linkages. Glycogen is degraded

by removal of the α -1,6-glycosidic linkages by the debranching enzyme (GlgX), followed by removal of the α -1,4 linkages by glycogen phosphorylase (GlgP) to give glucose-1-phosphate. The genetic organisation of glycogen-synthesis genes has been studied in *Agrobacterium tumefaciens* and *R. tropici*, where the *glg* genes form an operon (Marroqui *et al.*, 2001; Ugalde *et al.*, 1998; Uttaro and Ugalde, 1994; Uttaro *et al.*, 1998). Little is known about the factors that lead to the accumulation of glycogen either in free-living cells or in bacteroids. As with PHB synthesis in free-living rhizobial cells, glycogen accumulates under growth-limiting conditions, such as nitrogen limitation. *B. japonicum*, *R. leguminosarum*, and *S. meliloti* produce glycogen at the same time as PHB (Povolo and Casella, 2000; Povolo *et al.*, 1994; Tsien and Schmidt, 1977; Zevenhuizen, 1981). This suggests that glycogen metabolism may fulfil a similar role to that of PHB metabolism and that the flux of carbon between the two compounds is relatively plastic. Moreover, the prevention of PHB synthesis by mutation of *phaC* (PHB synthase) results in a greater accumulation of glycogen (50-fold), when the TCA cycle is impaired by serial sub-culture on media without vitamins (Cevallos *et al.*, 1996).

The role of glycogen metabolism during symbiosis has only been studied in *R. tropici*. A *glgA* mutant resulted in increased symbiotic efficiency of bean plants (a 38% increase in dry weight). The mutant also showed increased nodulation and so the increase in dry weight probably resulted from a net increase in symbiotic capacity rather than an enhancement of N₂ fixation per bacteroid (Marroqui *et al.*, 2001). However, mutation of *glgA* in *R. leguminosarum* by *viciae* did not alter the growth of peas (Lodwig *et al.*, 2005), but resulted in the deposition of large amounts of starch throughout the nodule. This suggests that pea bacteroids may store large quantities of glycogen, which would normally deplete plant starch reserves.

2.10. Nitrogen Metabolism

2.10.1. Primary Pathway of Ammonium Assimilation

Mutational and enzyme analyses of *R. leguminosarum*, *S. meliloti*, *B. japonicum*, and *R. etli* indicate that ammonium assimilation proceeds via the glutamine synthetase-GOGAT pathway and not via glutamate dehydrogenase (Bravo and Mora, 1988; Carlson *et al.*, 1987; Castillo *et al.*, 2000; Ferraioli *et al.*, 2002; O'Gara *et al.*, 1984). GOGAT mutants are glutamate auxotrophs, consistent with this being the pathway for glutamate synthesis.

2.10.2. Alanine Synthesis and Catabolism

Alanine can be synthesised directly by alanine dehydrogenase (AldA), which is normally only detectable in organic acid- or alanine-grown cultures of *R. leguminosarum* (Lodwig *et al.*, 2004). It is also present at moderate-high activity in soybean, alfalfa, pea, and lupin bacteroids (Allaway *et al.*, 2000; Dunn and Klucas, 1973; Kazakova *et al.*, 1988; Miller *et al.*, 1991; Smith and Emerich, 1993a;

1993b). The apparent K_m of AldA for NH_4^+ is 8.9 and 5.1 mM for *B. japonicum* and *R. leguminosarum*, respectively (Allaway *et al.*, 2000; Smith and Emerich, 1993b). *R. leguminosarum* mutated in *aldA* grew normally on alanine as sole carbon source (Allaway *et al.*, 2000), showing that its normal role is alanine synthesis. AldA-catalysed alanine synthesis is unlikely to be the primary pathway of ammonium assimilation in free-living cells, which requires the GS/GOGAT pathway. However, synthesis of alanine by AldA may be important in bacteroids (Allaway *et al.*, 2000; McRae *et al.*, 1989; Miller *et al.*, 1991; Smith and Emerich, 1993a; 1993b; Stripf and Werner, 1978). Pea bacteroids mutated in *aldA* no longer secreted alanine and plant dry weight was 20% lower (Allaway *et al.*, 2000).

2.10.3. Amino-acid Transport

R. leguminosarum has been studied as a model system for amino-acid uptake because it has two novel general amino acid-uptake systems (Aap and Bra), which are able to transport a broad range of L-amino acids (Hosie *et al.*, 2001; Poole *et al.*, 1985; Walshaw *et al.*, 1997a). ABC (ATP Binding Cassette) transporters hydrolyse ATP to drive the active uptake of solutes. They achieve extremely high concentration gradients, leading to the belief that they are unidirectional active-import or active-export systems, but that they will not allow solute movement in both directions. However, transport by the Aap and Bra, as well as other ABC systems, such as the His permease from *S. typhimurium*, has been shown to be bi-directional (Hosie *et al.*, 2001; Walshaw *et al.*, 1997a). Although uptake *via* these systems is active, amino acids are able to efflux passively.

Uptake can be post-transcriptionally inhibited in the Aap system, particularly under conditions where amino acids are excreted from the cell (Reid *et al.*, 1996; Walshaw and Poole, 1996; Walshaw *et al.*, 1997b; 1997c), as when amino acids are synthesised intracellularly and accumulate to high levels. Post-transcriptional inhibition of uptake rather than repression makes sense because Aap appears to play a role in secretion when uptake is inhibited.

The Aap and Bra systems are essential for effective N_2 fixation and assimilation in pea nodules. *R. leguminosarum* bacteroids mutated in both the Aap and Bra nodulated peas and fixed N_2 at approximately one-third of the wild-type rate, but the plants were almost completely nitrogen starved (Lodwig *et al.*, 2003). Because it was also shown that aspartate aminotransferase is essential for N_2 fixation, it was proposed that an amino acid, such as glutamate or possibly a derivative of it, enters the bacteroid and that this amino acid is used to transaminate oxaloacetate and/or pyruvate to produce aspartate and alanine. These two amino acids are known to be secreted by isolated pea bacteroids (Appels and Haaker, 1991; Rosendahl *et al.*, 1992) and their secretion by bacteroids may be needed to maintain asparagine biosynthesis by the plant for export to the shoot. At one extreme, aspartate secreted by the bacteroid could provide the backbone for asparagine biosynthesis by the plant. A key question still to be answered is whether the Aap and Bra systems are needed for amino-acid uptake, secretion, or both.

After the *aap* and *bra* genes were mutated, a third alanine-uptake system was identified (Hosie *et al.*, 2002). This system is a monocarboxylate-transport system with high affinity for lactate and pyruvate, but that also transports alanine with low affinity. An unusual ABC-uptake system for histidine (*hut*) has been identified in *S. meliloti*, which also transports glycine betaine (Boncompagni *et al.*, 2000).

2.10.4. Ammonium Movement

Ammonium is able to rapidly cross the cytoplasmic membrane of rhizobia apparently by passive diffusion (reviewed by Lodwig and Poole, 2003; Patriarca *et al.*, 2002). Under N starvation, rhizobia induce an ammonium-uptake system but, in all cases studied, the carrier is inoperative in the symbiotic state (Patriarca *et al.*, 2002). An ammonium transporter (AmtB) in *R. etli* is repressed during bacteroid differentiation, presumably by the high concentration of ammonium in the nodule (Tate *et al.*, 1998). Ectopic expression of the Amt system in *R. etli* bacteroids disrupts host-cell invasion and peribacteroid unit differentiation (Tate *et al.*, 1999).

2.10.5. Linking Carbon and Nitrogen Metabolism: The Transaminases

The central transaminase in most organisms is aspartate aminotransferase (glutamate:oxaloacetate transaminase). Mutants with a Tn5 insertion in an aspartate amino-transferase gene (*aatA*) of *S. meliloti* are unable to grow on aspartate as a sole carbon source (Rastogi and Watson, 1991). Mutants in *aatA* were Fix⁻ on alfalfa, suggesting an important role for this enzyme in bacteroids. Other genes, which code for enzymes with aspartate aminotransferase activity, include *aatB*, *tatA* (an aromatic aminotransferase), and *batA* (a branched chain aminotransferase) (Alfano and Kahn, 1993). The phenotype of the original *aatA* strain was also suppressed by the aromatic amino-acid transaminase (*tatA*) in multiple copy on a plasmid (Rastogi and Watson, 1991). Mutants of *aatB* and *tatA* are Fix⁺ on alfalfa, suggesting either a special role for AatA or that it is the most active aspartate aminotransferase (Alfano and Kahn, 1993). An *aatA* mutant of *R. leguminosarum* was also Fix⁻ (Lodwig *et al.*, 2003). A chemical mutant of *B. japonicum* that lacked aspartate aminotransferase was assigned a Fix⁻ phenotype (Zlotnikov *et al.*, 1984), but in a subsequent study, an initial yellowing of soybean by this strain was overcome and the plants were Fix⁺ (Streeter and Salminen, 1990).

Moderate aspartate-ammonia lyase (aspartase) activity has been detected in soybean bacteroids, allowing either the breakdown of aspartate to fumarate and ammonium or aspartate synthesis (Kouchi *et al.*, 1991). It has been detected in one strain of *R. leguminosarum*, where the activity was not normally present but was acquired by mutation of another enzyme activity (Poole *et al.*, 1984). Other strains of *R. leguminosarum* never show aspartase activity and there is no obvious aspartase gene in either the *S. meliloti* or *R. leguminosarum* genomes. Aspartase activity is probably not universally present in rhizobia, but may have a specific role in some strains and species.

2.10.6. Catabolite Control and Oligotrophy

Overall, rhizobia do not appear to demonstrate the very tight catabolite repression observed in enteric organisms. Instead, they appear to adopt an oligotrophic existence with most compounds being consumed to some extent, a probably advantageous strategy in nutrient-limited environments, such as the soil. However, this does not mean that there is no preference for carbon sources. The dicarboxylates are particularly favored as carbon sources and their inclusion in growth media substantially decreases the levels of catabolic enzymes for sugars and polyols (Bringhurst and Gage, 2002; Jelesko and Leigh, 1994; Poole *et al.*, 1994; Ucker and Signer, 1978). Mutants that lack the dicarboxylate-transport system fail to repress either lactose or inositol utilisation in *S. meliloti* or *R. leguminosarum*, respectively (Jelesko and Leigh, 1994; Poole *et al.*, 1994). Succinate also represses α -galactoside utilisation and this effect is overcome by mutations which elevate the transport rate of α -galactosides (Bringhurst and Gage, 2002). The conclusion that catabolite repression by dicarboxylates is mediated by inducer exclusion begs the question of whether inducer exclusion is actually mediated by the Dct-transport system or whether it is the result of catabolism of the dicarboxylates inside the cell.

2.11. Central Metabolism: Conclusions

1. Sugars are metabolised by the Entner-Doudoroff and pentose-phosphate pathways.
2. The TCA cycle is fully operative in laboratory cultures of rhizobia.
3. The primary route for ammonium assimilation is the GS/GOGAT pathway.
4. Bacteroids may have the TCA cycle limited by inhibition of 2-ketoglutarate dehydrogenase and, in some cases (*B. japonicum*), may only use part of the TCA cycle (as a split-cycle).
5. Laboratory cultures of rhizobia synthesise PHB and glycogen when grown under carbon-excess conditions, but only bacteroids from determinate nodules, e.g., bean, soybean, make significant quantities of PHB.
6. Dicarboxylates are essential for N₂ fixation by bacteroids, but amino-acid cycling is required for productive N₂ fixation.
7. Rhizobia tend to be oligotrophic, utilising many different carbon sources with less stringent catabolite control than that seen in enteric bacteria.

3. METABOLISM AND THE ENVIRONMENT

3.1. Catabolism of Rhizosphere-associated Carbon Sources and Role of Plasmids

Rhizobia can grow on many different carbon sources, including many sugars, amino acids, and phenolics (Stowers, 1985). A large fraction of rhizobial genomes comprise genes putatively involved in the transport and catabolism of organic compounds. In *S. meliloti* and *R. leguminosarum*, transport and catabolic genes are particularly prevalent on their large plasmids. The identity of the substrates

transported by the majority of the transporters in the rhizobia remains unknown, but it can be assumed that the nutritional diversity and variety of transport systems could have evolved due to the nutritional complexity of the rhizosphere environment which rhizobia inhabit.

Plants secrete an enormous variety of different chemical compounds, including secondary metabolites, into the rhizosphere. Legumes are particularly rich in unusual carbon sources, including non-protein amino acids, flavonoids, and phenolic compounds, some of which are toxic to humans and animals (Bell, 2003; Lambein *et al.*, 1993). A variety of different sugars is also present in both exudates and in root mucilage from legumes (Knee *et al.*, 2001). It was suggested many years ago that specific compounds in the roots of different species or cultivars of legumes might affect the growth of specific strains of rhizobia on the roots of that type of plant. Van Egeraat (1975a) noted that the non-protein amino acid homoserine might specifically mediate growth of some strains of *R. leguminosarum* in the pea rhizosphere. *R. leguminosarum* strains found commonly in pea nodules could catabolise homoserine, whereas strains from lentils or faba beans often could not (Hynes and O'Connell, 1990). The diverse catabolic capacity of different strains and species of rhizobia may, therefore, be important in their adaptation to survival in the rhizospheres of different groups of host and non-host plants. Various plant-produced metabolites could even play the role of more or less specific "nutritional mediators", so manipulating the microflora in the rhizosphere in favor of rhizobial strains likely to be most beneficial to the plant.

A very specific nutritional interaction is illustrated by the rhizopines, which are methyl-*scyllo*-inosamine compounds, whose synthesis and catabolism is specified by plasmid-borne genes in certain strains of *S. meliloti* and *R. leguminosarum* (Bahar *et al.*, 1998; Murphy *et al.*, 1988; 1995; Wexler *et al.*, 1996). The biosynthetic genes are under the control of NifA-dependent promoters, so the compounds are produced by cells that have already infected a legume host. The ability to catabolise rhizopines confers a distinct competitive advantage on strains which possess rhizopine-catabolism genes (Gordon *et al.*, 1996; Heinrich *et al.*, 1999), perhaps because production of rhizopine by rhizobia that have already infected plants starts very early (Heinrich *et al.*, 2001).

Another example of a specific nutritional interaction is the catabolism of mimosine, a toxic compound produced by *Leucaena leucocephala*, a tree legume. Some strains of *Rhizobium* spp. that nodulate *Leucaena*, such as TAL1145, can grow on mimosine as sole carbon source (Borthakur *et al.*, 2003) and this confers a competitive advantage (Soedarjo and Borthakur, 1996; 1998). Other toxic legume products, such as canavanine or ricin, could, therefore, provide selective growth advantages to some rhizobial strains, although this idea is as yet untested. There are also probably many unidentified compounds secreted by legume roots, *e.g.*, the (as yet uncharacterised) compound from beans that can induce expression of a transport system and which was removed by catabolism from bean exudates by strains of *R. tropici* (Rosenblueth *et al.*, 1998).

Some rhizobia can grow in the rhizosphere of non-legume plants and catabolise unusual compounds, known as calystegines, from plants, such as *Calystegia sepium* and *Convolvulus arvensis* (both in the Convolvulaceae), and *Atropa belladonna* (Tepfer *et al.*, 1988). In strain Rm41 of *S. meliloti*, the ability to catabolise calystegines is carried on plasmid pRme41a, the presence of which conferred a distinct competitive advantage in the rhizosphere of calystegine-producing plants (Guntli *et al.*, 1999).

In many other instances, the ability to use chemical compounds produced by legumes seems very widespread among rhizobial strains rather than being restricted to selected strains as in the examples above. The ability to use these compounds nonetheless confers a competitive nodulation advantage when isogenic strains with and without the catabolic ability are compared. Such compounds include rhamnose (Oresnik *et al.*, 1998; Richardson *et al.*, 2004), inositol (Fry *et al.*, 2001), and erythritol (C. Yost and M. Hynes, unpublished data) for *R. leguminosarum* and trigonelline, betaines, and stachydrine for *S. meliloti* (Burnet *et al.*, 2000; Boivin *et al.*, 1990; 1991; Goldmann *et al.*, 1991; Phillips *et al.*, 1998). Interestingly, trigonelline and stachydrine also function as *nod*-gene inducers. Rhizobia are also known to metabolise flavonoid inducers of *nod* genes (Rao and Cooper, 1994; 1995; Rao *et al.*, 1996; Steele *et al.*, 1999). In addition, the capacity for proline catabolism has been shown to influence nodule occupancy in *S. meliloti* (Jiménez-Zurdo *et al.*, 1995; 1997).

In many of the above cases, the catabolic genes are on plasmids, elements which can make up as much as 40% of the genome in the fast-growing rhizobia, and, as pointed out above, carry many genes for the transport and catabolism of small metabolites. It is, therefore, likely that there are many more unusual sugars, amino acids, and other compounds, whose degradation and use is encoded by genes on plasmids. Strains cured of individual plasmids, either singly or in combinations (Brom *et al.*, 1992; 2000; Hynes and McGregor, 1990; Moëgne-Loccoz *et al.*, 1995; Oresnik *et al.*, 2000), could be very useful in combination with rapid screening methods, such as BioLog plates (Oresnik *et al.*, 2000), in the identification of genes involved in other analogous examples. Microarrays could also be used to identify genes induced by root and seed exudates and, later, by specific compounds in those exudates.

3.2. Metabolism in the Environment: Conclusions

1. Rhizobia are able to catabolise a wide array of carbon compounds, including very unusual compounds produced by particular plants.
2. In several instances the ability to catabolise unusual plant carbon sources confers on rhizobial strains a competitive advantage for nodulation.
3. A significant portion of the catabolic capacity in fast-growing rhizobia is encoded by genes on plasmids.

4. MICRONUTRITION, METALS, AND VITAMINS

4.1 *Metals and the Rhizobia: Requirements, Uptake and Responses*

4.1.1. *Background*

The root nodule is a veritable treasure trove of metals. In addition to the requirements for Fe and Mo in the nitrogenase complex itself, other proteins needed for symbiotic N₂ fixation are metalloproteins, like the nodule-specific cytochromes and other iron-containing electron-transfer proteins. Some rhizobial strains possess the Ni-containing uptake hydrogenase, which oxidises some of the H₂ that is liberated by nitrogenase. The plant itself has a very heavy demand for iron for synthesis of the abundant hemoprotein, leghemoglobin. Moreover, free-living rhizobia must compete with all the other biota to acquire essential metals in the soil and rhizosphere.

Until quite recently, relatively little has been done to determine the ways in which rhizobia obtain, use, and respond to metals, either in the free-living or the symbiotic states. Despite a comprehensive review (Johnston *et al.*, 2001) of what is known of how rhizobia obtain biologically significant metals (Co, Cu, Mg, Ca, Ni, Zn, Mo, Mn, and Fe), there was remarkably little information for any of them except Fe and Ni; for most of these, not much has happened since. More recently, Johnston (2004) has reviewed recent work on iron, its uptake, its utilisation, and its mode of action as a regulator. Here, we highlight the most important aspects of the metallo-biology of the rhizobia, focusing on developments relevant to Fe, Mn, and Ni.

4.1.2. *Iron*

Because of its redox properties and its abundance, iron is the most widely used metal in metalloenzymes. However, its extreme insolubility in its oxidised form, plus its potential to elicit damaging free radicals, mean that organisms expend much effort to acquire it and exercise great care in controlling its intracellular levels (see review by Andrews *et al.*, 2003).

Despite an increasing interest in the “iron biology” of the rhizobia, we still have not identified the source(s) of Fe in the nodule. *B. japonicum* bacteroids in soybean nodules can import the soluble Fe²⁺, which may be generated by a nodule-specific ferri-reductase. Moreover, *B. japonicum* has a protein similar to the Feo transporter, which in other bacteria is used for Fe(II) import (Kaiser *et al.*, 2003), but, to date, no *feo* mutants have been isolated. However, the deduced proteomes of *Rhizobium*, *Sinorhizobium*, and *Mesorhizobium* have no Feo-like proteins, so the role of Fe²⁺ as the Fe source for these genera is even more questionable.

In *Bradyrhizobium*, a defect in *fegA*, which likely encodes a cell-surface receptor for a siderophore (a small molecule that chelates Fe³⁺ and is imported by a specialised transporter), results in Fix⁻ nodules devoid of bacteroids (LeVier and Guerinot, 1996). This is somewhat surprising because these bacteria are not known to make siderophores and analogous mutants, in other rhizobia, have no obvious symbiotic defect (see below). Further, a highly unusual allele of the *fur*-like gene (see below) of

Bradyrhizobium, when cloned, exerted a dominant-negative effect on N₂ fixation by bacteroids in the nodules of several legumes (Benson *et al.*, 2004). As described below, this is not the only unusual feature of *fur*-like genes in the rhizobia.

Iron metabolism in free-living rhizobia differs significantly from that in “model” bacteria, revealing some intriguing features that are highlighted here. Firstly, rhizobia have much greater flexibility in their Fe sources than many other bacterial groups. Not only do most rhizobia make and import their own siderophores, but genomic analyses reveal systems for the import of siderophores made by other bacteria. Such “molecular piracy” for siderophore uptake is widespread in bacteria. Like many other bacteria, rhizobia can use ferric citrate, but the mechanism is unknown; there are no close homologs of the Fec system that imports Fe³⁺ citrate in *E. coli*. Unusually, rhizobia can use heme as a source of Fe, usually a characteristic of pathogenic bacteria. Another trait that is associated with pathogens is the presence of Fbp-type ABC transporters, which directly import Fe³⁺. Different rhizobia have several such systems, the particular portfolio differing among *Sinorhizobium*, *Mesorhizobium*, and *Rhizobium*. Further, the sequences of the various Fbp-type gene products are very similar (as much as 70% identical) to those in distantly related pathogens, *e.g.*, *Salmonella* or *Actinobacillus*, all of which suggests a recent independent acquisition by different rhizobia by lateral gene transfer.

In *Sinorhizobium* and/or *Rhizobium*, mutations that abolish the synthesis or the uptake of siderophores, or which block the import of heme, have no symbiotic phenotype. Indeed, the genes involved in siderophore uptake are not even expressed in N₂-fixing bacteroids in, at least, some rhizobia (Johnston, 2004). Thus, none of these “free-living” import systems is important for Fe nutrition in nodules

4.1.3. Iron-responsive Gene Regulation

Rhizobia not only differ from *E. coli* in their range of Fe sources but also in their Fe-responsive gene regulation. In proteobacteria, it is widely thought that the “global” Fe-responsive gene regulator is the DNA-binding protein Fur (ferric uptake regulator). This is certainly true in *E. coli* and *Pseudomonas*, where Fur, when charged with Fe²⁺, represses many operons by binding to conserved *cis*-acting *fur* boxes near its target promoters in Fe-replete conditions (Andrews *et al.*, 2003).

The genes involved in the synthesis and the uptake of siderophores (and of heme) have been identified in *Rhizobium* and *Sinorhizobium* (see Johnston, 2004). Not surprisingly, their expression is enhanced in free-living cells in media depleted of Fe. Excepting *M. loti*, those rhizobia whose genomes have been sequenced have at least one gene whose product has a similar sequence to Fur of other bacteria. Mutations in this gene, however, do not affect the expression of Fe-responsive genes. In at least some rhizobia, Fur has a far more limited repertoire of action, responding to a different metal, namely manganese (see below).

Instead of Fur, *Rhizobium* has a wholly different regulatory protein, RirA, which has a pivotal Fe-responsive regulatory role. RirA⁻ mutants exhibit constitutive expression of all known genes that are normally repressed in Fe-replete media (Todd *et al.*, 2002). Proteomic and microarray experiments in *Rhizobium* and

Sinorhizobium, respectively, show that the range (in terms of numbers and functions) of RirA-regulated genes approaches that of Fur in *E. coli* and *Pseudomonas* (Todd *et al.*, 2005; S. Weidner, personal communication). RirA has no sequence similarity to Fur, but there are close homologs in near relatives, including *Agrobacterium* and *Brucella*. RirA has no close homolog in the more distantly-related *B. japonicum*, where the overall mechanisms of Fe-responsive gene control are unknown.

RirA is a member of a large Rrf2 super-family of proteins, only one other of member of which, IscR of *E. coli*, has been studied in detail (Schwartz *et al.*, 2001). IscR is a verified DNA-binding protein that represses the *isc* genes for [FeS]-cluster synthesis and itself contains a [FeS] cofactor. It is likely that RirA also binds to operators of at least some of the genes that it regulates and its amino-acid sequence suggests that it too contains an [FeS]-cofactor (J. D. Todd, personal communication).

We have no explanation for why some rhizobia have “adopted” RirA as their central Fe-responsive regulator. The phylogeny of RirA suggests that it was acquired by the progenitor of the *Brucella-Agrobacterium-Mesorhizobium-Rhizobium-Sinorhizobium* genera, perhaps by duplication and subsequent modification of one of the pre-existing versions of the *rrf2* family. Despite the wide-ranging regulatory effects of RirA⁻ mutants, their symbiotic phenotypes are normal, suggesting that the iron economy of the nodule is rather different from that of the free-living rhizobia.

The elegant work from M. O’Brian’s laboratory on Fe-responsive gene regulation in *B. japonicum* has shown one feature common with that in the fast-growing rhizobia - that Fur does not have a role as the global Fe-responsive regulator. However, we do not know which regulatory protein(s) occupies this role; but it is certainly not RirA, because these rhizobia lack a RirA homolog in their deduced proteome. *B. japonicum* does have a *fur*-like gene and, in the strain studied by O’Brian, mutations in it cause somewhat compromised growth in Fe-depleted media (Hamza *et al.*, 1999). However, such mutants are unaffected in Fe-responsive regulation of the *hmu* genes, which are involved in the uptake of heme and whose expression is repressed in Fe-replete conditions (Nienaber *et al.*, 2001). *B. japonicum* must, therefore, have another, as yet unknown, Fe-responsive repressor.

The Fur-like protein (Fur_{Bj}) is certainly not without interest. It represses transcription of another gene, *irr*, which is itself another member of the *fur* super-family and is described below. Fur_{Bj} does so by binding to motifs in the *irr* promoter region under Fe-replete conditions as demonstrated *in vitro* (Friedman and O’Brian, 2003; 2004). Importantly, the *cis*-acting “*irr* box” has no sequence similarity to that of the canonical *fur* box, yet Fur_{Bj} binds very effectively *in vitro* to an *E. coli fur* box. This is reminiscent of the *R. leguminosarum* Mur, which resembles Fur in its sequence and which can bind to classical *fur* boxes – yet its role in *Rhizobium* itself is as a manganese-responsive regulator through its ability to bind to a DNA sequence with no similarity either to *fur* boxes or to the *irr* boxes in *B. japonicum* (see below). Thus, intriguingly and very unusually, the Fur/Mur proteins of at least two rhizobia can both recognise very different regulatory motifs. The biochemical basis of this phenomenon is worthy of future investigation.

4.1.4. Manganese

No special role for Mn in nodules has been reported, although it may be needed for rhizobia to adhere properly to root hairs in the very early steps of infection. However, expression of the *Sinorhizobium sitABCD* operon, which specifies a high-affinity Mn^{2+} transporter, is markedly enhanced in bacteroids, compared to free-living cells grown on at least some media (Ampe *et al.*, 2003a). Mutations in *sitABCD* have, at most, a minor effect on symbiotic N_2 fixation, implying the presence of another Mn transporter in bacteroids. Genomic analyses suggest that the rhizobia may indeed have a second transporter, whose role is unknown (Diaz-Mireles *et al.*, 2004).

Of more interest is that *sitABCD* is regulated in a rather novel way. Its expression in free-living *Sinorhizobium* and *Rhizobium* is repressed by Mn^{2+} (but not Fe^{2+}) in the medium. Although unsurprising, this regulation is mediated by the Fur-like protein thought likely to be involved in Fe-responsive gene regulation (Chao *et al.*, 2004; Diaz-Mireles *et al.*, 2004; Platero *et al.*, 2004). Indeed, Diaz-Mireles *et al.* (2004) suggested that this regulator be renamed “Mur”. Although Mur can bind near the promoter of the *sitABCD* operon, this DNA has no sequence similarity to classical *fur* boxes, even though Mur of *R. leguminosarum* can bind to artificially provided canonical sequences. Subtle protein-DNA interactions must allow recognition of particular sequences to be modulated by the specific metal ligand (Diaz-Mireles *et al.*, 2004).

M. loti, which has no *fur*-like gene, also lacks the *sitABCD* genes. It will be of interest to see how these bacteria acquire Mn in (and out of) the nodule and to establish how the corresponding genes are regulated.

4.1.5. Nickel

Many *Bradyrhizobium* and several *Rhizobium* strains possess uptake hydrogenase (Baginsky *et al.*, 2002), which is expressed at high levels in differentiated N_2 -fixing bacteroids. One feature of their nickel biology is worth stressing, even though it was recognised some time ago. Apparently paradoxically, Ni^{2+} -uptake ability is not expressed in bacteroids, where demand might be thought to be greatest. Instead, the undifferentiated non-fixing bacteria in the nodule make an unusual protein, nickelin, which contains no less than 24 histidine residues that bind to Ni^{2+} . These act as a molecular nickel store, which is then released to the Hup^+ bacteroids on demand (Olson and Maier, 2000). Nature thus anticipated the use of “his-tags” by some considerable time!

4.1.6. Future Work on Metals

The last few years have revealed intriguing information on how the rhizobia obtain and respond to metals, with genomics likely to open up many new and fruitful avenues of research. Among the pressing questions are those that relate to the identification of the Fe source(s) in bacteroids. Also, although we know something of how Ni and Mn are imported, there is virtually nothing known of the transporters

for many other trace elements, even Mo, a metal that lies at the heart of nitrogenase. It will be of interest to see whether any other mantras, established rather parochially for *E. coli*, also have only marginal relevance to the rhizobia.

4.2. Vitamins

For growth, many rhizobia require vitamins, such as biotin, thiamine, riboflavin, and nicotinic acid, and many rhizobial-growth media contain them; the precise vitamin requirements differ for various strains and species. For example, *R. etli* does not require thiamine but *R. leguminosarum* and *S. meliloti* do (Allaway *et al.*, 2001; Miranda-Rios *et al.*, 1997; Streit *et al.*, 1996). In *R. leguminosarum*, the *thiMED* genes code for a putative salvage pathway for thiamine biosynthesis, which is highly expressed in the pea rhizosphere (Allaway *et al.*, 2001). However, this organism lacks a full thiamine-biosynthesis pathway and it must be added to laboratory growth media. In *R. etli*, the *thiCOG* operon, whose expression allows growth in the absence of added thiamine, is regulated by a thiamine riboswitch, rather than a protein regulator (Miranda-Rios *et al.*, 2001). The leader region of the mRNA folds into a riboswitch that can presumably bind thiamine or a derivative of it and prevent translation. A complete pathway for biotin biosynthesis is absent in *S. meliloti* (Entcheva *et al.*, 2002), but slow growth can apparently occur in its absence (Streit *et al.*, 1996).

An intriguing example of the role of vitamins is found in *Mesorhizobium* sp strain R7A, in which the symbiotic genes are on a chromosomal (symbiosis) island that contains genes for biotin, thiamine, and nicotinate biosynthesis. Non-symbiotic soil strains lack these genes and are auxotrophic for all three vitamins (in some cases, just thiamine and biotin), but transfer of the symbiotic island restores prototrophy (Sullivan *et al.*, 2001). Overall, it appears to be common for the growth of rhizobia in soil to be limited by the rate at which vitamins, such as biotin and thiamine, can be synthesised; their growth may be arrested until the vitamins are available, perhaps from the rhizosphere.

4.3. Micronutrition, Metals and Vitamins: Conclusions

Iron

1. Rhizobia have a very much wider range of Fe sources than other bacterial lineages.
2. Fe-responsive gene regulation is very different to the “textbook” mechanisms for *E. coli*, in which Fur is the global Fe-responsive regulator.
3. In *R. leguminosarum* and *S. meliloti*, the role of Fur is undertaken by RirA, a likely [FeS] protein in the Rrf2 family and which only occurs in some very close relatives of these two rhizobia.
4. We know little or nothing of how bacteroids acquire Fe, though iron (II) may be important, at least in soybeans.

Manganese

1. In *S. meliloti*, the SitABCD transporter is important for Mn uptake in free-living bacteria.
2. In *R. leguminosarum* and *S. meliloti*, the *sitABCD* operon is repressed in Mn-replete conditions by a Fur-like protein called Mur, which appears to have no role in Fe-responsive gene regulation.

Other metals

1. Nickel, a cofactor in hydrogenase, has been studied in some detail in *B. japonicum* and *R. leguminosarum*.
2. We know remarkably little about the uptake, fate, and regulatory effects of other metals, such as Ca, Co, Cu, Mg, or Mo.

Vitamins

1. Growth of rhizobia is often limited by the absence of added vitamins, such as thiamine, biotin and nicotinate.
2. The ability to grow rapidly in the absence of added vitamins is encoded by genes in the symbiosis island of *M. loti*.

5. ENVIRONMENTAL RESPONSES OF RHIZOBIA

5.1. Chemotaxis and Motility in the Rhizobia

Like most motile bacteria, rhizobia possess flagella and most strains are motile. In Bergey's Manual of Systematic Bacteriology, Jordan (1984) defines them as normally being peritrichously flagellated, except for *Bradyrhizobium japonicum*, which is described as polarly flagellated. The processes of motility and chemotaxis have been most studied in enteric bacteria, like *E. coli* and *S. typhimurium*. Although many of the elements contributing to those behaviors are conserved in rhizobia, there are also major differences, many of which have been reviewed recently (Armitage and Schmitt, 1997; Scharf and Schmitt, 2002; Schmitt, 2002; Yost and Hynes, 2000) and will not be discussed in detail here. This section covers some novel features of rhizobial motility and chemotaxis uncovered by recent experimental work and by analysis of the available rhizobial-genome sequences.

5.1.1. The Escherichia coli Model

A brief description of the components functioning in motility in the most studied system (*E. coli*) is warranted; more information on the *E. coli* model is available in recent reviews (e.g., McNab, 2003). *E. coli* is peritrichously flagellated, like most rhizobia, and can swim because its rotating flagella form a flagellar bundle which acts to propel the cell with all the flagella rotating in concert. The main part of the *E. coli* flagellum is composed of repeating units of a single flagellin protein, and the flagella are capable of rotating either counter-clockwise (CCW, the default setting) or clockwise (CW). Reorientation of swimming direction occurs when the direction

of rotation of one or more flagella changes from CCW to CW, resulting in the disruption of the flagellar bundle and causing the cell to “tumble” rather than swim in a straight line. After a period of tumbling, the cell begins swimming again, usually in a new direction. In the absence of any chemical attractants or repellents, the cell spends about 90% of its time swimming and 10% tumbling. In the presence of a gradient of attractant or repellent, the cell alters this ratio and regulates its net movement towards increasing concentrations of attractant and away from increasing concentrations of repellents; this is the process of chemotaxis. *E. coli* has three major chemotactic mechanisms: (i) methyl-accepting chemotaxis protein (MCP)-mediated chemotaxis; (ii) phosphotransferase (PTS) chemotaxis; and (iii) energy taxis.

In all of these processes, a series of cytoplasmic proteins, called Che (for chemotaxis), plays a central role by regulating the amount of phosphorylated CheY protein in the cell. CheY, when phosphorylated, interacts with the flagellar motor and causes it to reverse direction to CW rotation, which results in tumbling. CheY is phosphorylated by CheA, a cytoplasmic sensor kinase, which can also autophosphorylate. The state of CheA phosphorylation depends on interaction with either membrane chemoreceptors, like MCPs, or the energy-sensing transducer Aer, or the PTS system. In the presence of attractants, CheA normally has a low phosphorylation state, whereas either in the presence of repellents or when attractant concentrations are declining, CheA becomes phosphorylated. Other important Che proteins in *E. coli* are: CheW, which enhances CheA interactions with MCPs; CheZ which dephosphorylates CheY; and CheR and CheB, which are involved in methylation and demethylation of the MCPs. The methylation state of these chemoreceptors influences their ability to stimulate autophosphorylation of CheA. The MCP proteins are present in large arrays at the poles of *E. coli* cells and interaction between clusters of MCPs is a necessary part of the chemotactic-signalling response (Bren and Eisenbach, 2000; Sourjik and Berg, 2004).

5.1.2. Flagella and Motility in Rhizobia

The structure of the flagellar filament in the rhizobia differs significantly from that in *E. coli*. All of the rhizobia studied so far have more than one flagellin protein. *S. meliloti* has four flagellin genes (*flaA*, *flaB*, *flaC*, and *flaD*) (Scharf *et al.*, 2001) as does *Agrobacterium* (Deakin *et al.*, 1999). In both bacteria, FlaA is the major flagellin, but all four are found within the flagellar filament. A strain of *Rhizobium lupini* has three flagellins (Scharf *et al.*, 2001), and the genome sequences of *B. japonicum* (Kaneko *et al.*, 2002) and *M. loti* (Kaneko *et al.*, 2000) reveal three and two flagellin genes, respectively. The genomic sequence of *Rhizobium leguminosarum* strain 3841 contains five *fla* genes, one of which is plasmid-encoded (on pRL1JI). The predicted proteins are more related to each other than to those of either *Agrobacterium* or *Sinorhizobium*. *S. meliloti* and *R. lupini* flagella have been described as “complex flagella” (Gotz *et al.*, 1982; Gotz and Schmitt, 1987; Scharf *et al.*, 2001; Schmitt, 2002; Trachtenberg *et al.*, 1987) with a structure

that involves a ridge of flagellins wound in helical fashion around a central core, in three helices, giving the flagella a grainy texture in electron micrographs. Despite the presence of multiple flagellins (or at least *fla* genes) in *Agrobacterium* and *R. leguminosarum*, the flagellar appearance does not conform to the “complex” type described for *S. meliloti* (Deakin *et al.*, 1999; Del Bel, 2004).

Analysis of the complete DNA sequence of the entire cluster of genes involved in chemotaxis and motility in both *S. meliloti* (Sourjik *et al.*, 1998) and *Agrobacterium* shows that genes are present for encoding nearly all of the proteins for the various ring, rod, hook, and motor structures found in *E. coli* flagella. In addition, three new motility genes, *motC*, *motD* and *motE*, were found in *S. meliloti*. These appear to code for proteins that are required in addition to MotA and MotB (which together form the “stator” of the *E. coli* flagellum) for correct flagellar rotation (Eggenhofer *et al.*, 2004; Schmitt, 2002). They may be necessary because the flagellum functions at variable speeds rather than reversing direction. The genomes of *A. tumefaciens* and *R. leguminosarum* also contain all of *motCDE*.

One major difference between the function of the flagella of *S. meliloti* and the enteric bacteria is that the *S. meliloti* flagellum appears unable to reverse and always rotates clockwise (Schmitt, 2002; Sourjik and Schmitt, 1996), a property attributed to its rigid and complex structure. Changes in the speed of rotation of the flagella perturb the flagellar bundle and result in reorientation of swimming direction (Scharf, 2002).

5.1.3. Chemotaxis in the Rhizobia

Various rhizobia respond chemotactically to a large number of compounds as well as to plant exudates (Bowra and Dilworth, 1981; Dharmatilake and Bauer, 1992; Parke *et al.*, 1985; Yost and Hynes, 2000). The exact nature of receptors involved in sensing these various chemicals has not been determined in any case, but the major elements of the chemotactic pathway in *E. coli* are present in the genomes of the rhizobia that have been sequenced. *S. meliloti* has been studied the most, and has a Che operon that consists of the *cheY1*, *cheA*, *cheW*, *cheB*, *cheR*, *cheD*, and *cheY2* genes, preceded by a gene coding for a protein (annotated as McpE), which has MCP-signalling domains, but neither methylation nor transmembrane domains (Sourjik *et al.*, 1998). CheY2 is the major regulator of chemotaxis and it slows flagellar rotation when phosphorylated (Schmitt, 2002; Sourjik and Schmitt, 1996), whereas CheY1 acts as a phosphate sink. One major difference from *E. coli* is the absence from *S. meliloti* (and indeed in many α -proteobacteria) of a CheZ homolog. A Che operon highly similar to the above is conserved in *Agrobacterium* (Wright *et al.*, 1998) and in *R. leguminosarum*, corresponding to the group one α -proteobacterial Che operon described by Hauwaerts *et al.* (2002).

Both *S. meliloti* and *R. leguminosarum*, like several other α -proteobacteria (Hauwaerts *et al.*, 2002), appear to contain other sets of *che* genes. In *R. leguminosarum*, this consists of a complete operon corresponding to a group 3 Che operon, and preliminary results (L.D. Miller, C.K. Yost, M.F. Hynes and G. Alexandre, unpublished data) show that this operon does play a role in regulating

motility. *S. meliloti* carries an incomplete Che operon on pSymA, adjacent to a cluster of genes involved in Type-IV pilus biosynthesis, suggesting a role in twitching motility (Scharf and Schmitt, 2002), especially because the proteins encoded by the *che* genes at this locus more closely resemble those of the Frz system of *Myxococcus xanthus* than those from conventional *che* genes. *B. japonicum* has two Che operons corresponding to groups 2 and 3 of Hauwaerts *et al.* (2002), whereas *M. loti* appears to have an incomplete set of *che* genes.

S. meliloti 1021 only has 9 *mcp* homologs in its genome, one of which is associated with the second Che operon, and is only weakly similar to canonical MCPs. The exact function of these receptor genes is not yet known. Other rhizobia, however, have larger *mcp*-gene families - 20 in *Agrobacterium* and 26 in *R. leguminosarum* 3841, which corresponds well with the prediction of over 17 in *R. leguminosarum* VF39 (Yost *et al.*, 1998). The *mcpB* gene in *R. leguminosarum* VF39 seems to play a central role in chemotaxis because mutants defective in this gene have a generalised lack of chemotactic ability. *B. japonicum* USDA 110 has as many as 36 potential *mcp* genes, but *M. loti* seems to have only one plasmid-encoded *mcp* gene homolog. Elucidating the functions of the chemoreceptors in the rhizobia promises to be difficult because their ligands may, in some cases, be unknown rhizosphere or soil chemicals which are not readily available.

5.1.4. Regulation of Chemotaxis and Motility in Rhizobia

Two major regulators (VisR and VisN) of genes involved in chemotaxis and motility have been identified in *S. meliloti*. They are encoded within the chemotaxis and motility-gene cluster (Sourjik *et al.*, 2000) and belong to the LuxR family of gene regulators. Strains carrying mutations in *visR* or *visN* are non-motile and do not produce flagella. It is suspected that they probably bind some unidentified effector molecule and that they function as a heterodimer. *visN* and *visR* homologs occur in the genomes of *R. leguminosarum*, *Agrobacterium*, and *M. loti*, but apparently not in *B. japonicum*. The predicted protein sequences, however, are poorly conserved compared to other *che*, *fla*, and *mot* genes. The gene SMC03046 is also located within the chemotaxis and motility-gene cluster of *S. meliloti* 1021, and appears to encode a regulatory protein, which is also conserved in *R. leguminosarum*, *M. loti*, *B. japonicum*, and *Agrobacterium*.

Chemotaxis and motility are presumably irrelevant for rhizobia once they have invaded a legume plant and begun to differentiate into bacteroids. Experiments with anti-flagellin antibodies confirm the expectation that they lose their flagella during this process (Del Bel, 2004; Roest *et al.*, 1995). Use of gene fusions and anti-MCP antibodies has also shown that the *mcp* genes of *R. leguminosarum* are down-regulated in bacteroids (Yost *et al.*, 2004). The signals and mechanisms for this down-regulation are not understood, but O₂ appears not to be the major signal, and known symbiotic regulators, such as *rpoN*, *fixL*, *fixK*, and *fnrN*, are not involved (Becker *et al.*, 2004). Recent microarray studies confirm that most elements in the chemotactic pathway are down-regulated in bacteroids of *S. meliloti* (Becker *et al.*,

2004) and *M. loti* (Uchiumi *et al.*, 2004). The involvement of VisR and VisN in this down-regulation is of obvious interest. Lack of expression of chemotaxis and motility genes could be due to the absence (or presence), under symbiotic conditions, of an effector molecule that interacts with VisNR. Also of particular interest are regulatory effects on motility induced by starvation (Wei and Bauer, 1998) and the genetic basis of hypermotile (and also highly competitive) mutants of *S. meliloti* (Wei and Bauer, 1999).

5.1.5. Ecological Role of Chemotaxis and Motility

Rhizobia that carry mutations in genes required for (or involved in) either motility or chemotaxis are still able to nodulate their legume hosts, but are usually less competitive than wild-type strains (Ames and Bergman, 1981; Caetano-Anolles *et al.*, 1988; Van de Broek and Vanderleyden, 1995; Yost *et al.*, 1998). This implies that chemotaxis towards specific chemicals produced by plants may be an important part of the early stages of plant-rhizobial interaction. Because strains with mutations in individual MCPs have altered competitiveness (Yost *et al.*, 1998; 2003), these chemicals may well be quite specific. There is preliminary evidence (C.K. Yost and M.F. Hynes, unpublished data) that different MCPs might play more or less important roles in competitiveness with different legumes. Rhizobia are chemotactic to *nod*-gene inducing flavonoids (Aguilar *et al.*, 1988; Armitage *et al.*, 1988; Dharmatilake and Bauer, 1992), but the precise mechanism and receptors are unknown. The attraction of rhizobia to particular sites on legume roots (Gulash *et al.*, 1984) is particularly interesting because this would require very precise recognition of a mix of specific signal molecules. Several MCPs might be involved in such a process, whereas chemotaxis to most carbon sources by rhizobia may be like that in *Azospirillum*, and predominantly involve an energy-sensing mechanism (Alexandre and Zhulin, 2001; Alexandre *et al.*, 2004).

5.2. Quorum Sensing

Population density-dependent regulation of gene expression *via* quorum sensing is now a well-established phenomenon in a wide range of bacteria and clearly plays a critical role in plant-microbe interactions (Newton and Fray, 2004). The first identified quorum sensing-regulated genes in the rhizobia were the *R. leguminosarum* bv. *viciae* rhizosphere-expressed (*rhi*) genes, which have a role in interactions with plants because, in some genetic backgrounds, mutations in the genes significantly reduce nodulation. The *rhi* genes are located between the nitrogenase genes and the host-specific nodulation genes on the symbiosis plasmid and appear to be unique to strains of *R. leguminosarum* bv. *viciae* (Cubo *et al.*, 1992). These genes are induced by RhiR in response to C6-, C7- and C8-, *N*-acyl homoserine lactones (AHLs) produced by the product of *rhiI*, which is auto-induced, *i.e.*, induced by RhiR in response to the AHLs produced by RhiI. However, the biochemical functions of the *rhiA*, *rhiB*, and *rhiC* gene products and their role in symbiosis remain obscure (Rodelas *et al.*, 1999).

There are multiple and different quorum-sensing regulatory systems in rhizobia that affect plasmid transfer, growth inhibition, stationary-phase adaptation, exopolysaccharide biosynthesis, and biofilm formation; they can also influence N₂ fixation (Gonzalez and Marketon, 2003; Wisniewski-Dyé and Downie, 2002). *R. leguminosarum* (Lithgow *et al.*, 2000), *R. etli* (Daniels *et al.*, 2002), and *S. meliloti* (Marketon and Gonzalez, 2002; Marketon *et al.*, 2002) all produce AHLs with relatively long acyl chains. For example, (3-hydroxy-7-*cis*-tetradecanoyl)-L-homoserine lactone, (3-OH-C_{14:1}-HSL) is produced by CinI in the *Rhizobium* strains and C₁₄-C₁₈-HSLs are produced by SinI in *S. meliloti*. Mutation of the *cinI* gene causes delayed growth and a decrease in symbiotic N₂ fixation in *R. etli* (Daniels *et al.*, 2002), but not with *cinI* mutants of *R. leguminosarum* (Lithgow *et al.*, 2000). Mutation of *sinI* in *S. meliloti* results in a delay and a decrease in nodulation and symbiotic N₂ fixation (Marketon and Gonzalez, 2002; Marketon *et al.*, 2002). An explanation for these different phenotypes may be that long-chain AHLs seem to affect the regulation of other quorum-sensing regulatory systems (Hoang *et al.*, 2004; Lithgow *et al.*, 2000), which may be present in some rhizobia but absent or duplicated in others. Thus, it is possible that genes required for some aspect of symbiotic development may be regulated by quorum sensing in both *R. etli* and *S. meliloti* but not in *R. leguminosarum*.

The quorum-sensing signal, 3-OH-C_{14:1}-HSL, made by CinI can be bacteriostatic to particular strains of *R. leguminosarum* bv *viciae* (Gray *et al.*, 1996; Hirsch, 1979; Schripsema *et al.*, 1996; Wilkinson *et al.*, 2002). Originally, 3-OH-C_{14:1}-HSL was known as 'small bacteriocin' due to the bacteriocin-like halos of growth inhibition induced on sensitive strains (Hirsch, 1979). The physiological reason for the bacteriostasis is not known, but the growth inhibition in the sensitive cells is associated with high levels of expression of the AHL synthase encoded by the *traI* gene that is involved in plasmid transfer (Danino *et al.*, 2003). Analysis of proteins that are enhanced in sensitive strains exposed to 3-OH-C_{14:1}-HSL suggested that the translation factor EF-Ts was present at high levels, hinting that the growth inhibition might be due to some effect on protein translation.

In some strains of *R. leguminosarum*, the production of 3-OH-C_{14:1}-HSL causes a novel mechanism of recipient-induced transfer of the conjugal plasmid pRL1JI, which carries the nodulation and N₂-fixation genes. The pRL1JI donor cells recognise 3-OH-C_{14:1}-HSL produced by potential recipients. In order for this to function, there is a gene encoding a quorum-sensing bifunctional signalling Regulator (*bisR*) on pRL1JI (Wilkinson *et al.*, 2002). BisR induces *traR*, which encodes the regulator of plasmid-transfer genes, and this occurs only in response to CinI-made 3-OH-C_{14:1}-HSL. The production of this AHL by the donor cells (carrying pRL1JI) is blocked because BisR represses expression of the *cinI* gene on the chromosome. Therefore, such pRL1JI-containing cells expressing BisR cannot induce *traR* (because 3-OH-C_{14:1}-HSL is not present), but such cells are poised to respond to 3-OH-C_{14:1}-HSL coming from potential recipients. These recipients must lack BisR, the repressor of 3-OH-C_{14:1}-HSL production, and so strains lacking pRL1JI (and hence lacking *bisR*) and, therefore, expressing *cinI* at high levels (*i.e.*,

3-OH-C_{14:1}-HSL producers) are ideal recipients. The resulting 3-OH-C_{14:1}-HSL-induced production of TraR in the donor cells then allows the induction of the *traI-trb* plasmid-transfer operon in response to the AHLs *N*-(3-oxo-octanoyl)-L-homoserine lactone (3-O-C₈-HSL) and *N*-(octanoyl)-L-homoserine lactone (C₈-HSL) made by TraI (Danino *et al.*, 2003). This second level of induction occurs in a population density-dependent manner mediated *via* the quorum-sensing autoinduction of the *traI* gene. Therefore, plasmid transfer is controlled at two levels; the first in response to potential recipients and, if such recipients are present, the second requires an appropriate population density of the donor cells.

In *R. etli*, transfer of the self conjugative plasmid (p42a), which is required for mobilization of the symbiotic plasmid, is also under the control of CinI, TraI, and TraR (Tun-Garrido *et al.*, 2003). In *Rhizobium* sp. NGR234, transfer of the *sym* plasmid (pNGR234a) is also controlled in a cell density-dependent fashion by TraR and TraI (He *et al.*, 2003). Premature induction of plasmid-transfer genes of both pNGR234a and pRL1JI, due to autoinduction caused by low level expression of *traR*, is prevented by the action of an additional regulator TraM (Danino *et al.*, 2003). It appears that TraM binds to TraR thereby mopping up low levels of this regulator and preventing early autoinduction. In one strain of *S. meliloti*, the transfer of plasmid pRme41a is also under the control of a *traR/traI/traM* regulatory system, but the frequency of transfer of this plasmid, like pNGR234, is much lower than that of pRL1JI and p42a. In the sequenced strain of *S. meliloti*, there is no such quorum-sensing regulation of plasmid transfer (Galibert *et al.*, 2001a; Gonzalez and Marketon, 2003).

In *S. meliloti*, the quorum-sensing regulator ExpR regulates synthesis of EPSII (Pellock *et al.*, 2002) and it seems likely that ExpR regulates *exp* genes in response to AHLs produced by SinI/SinR (Marketon *et al.*, 2003). Mutation of the *sin* system causes delays in nodulation and a reduction in the number of effective nodules (Marketon and Gonzalez, 2002; Marketon *et al.*, 2002), possibly because of reduced levels of EPSII, which plays a role in infection. However, it is now evident from microarray analysis (Hoang *et al.*, 2004) of gene expression in *sinI*, *sinR*, and *expR* mutants (including double mutants) that there are many genes whose expression is affected by these quorum-sensing regulators. Overall, it appears that many of the genes affected by mutation of either *sinI* or *sinR* are associated with surface effects (surface polysaccharides, flagella, fimbria, membrane transporters) and adaptive physiology. Such adaptive physiology seems to be a hallmark of quorum sensing-regulated genes and it appears that quorum-sensing regulons present in some strains are absent from others. Thus, the *rail-raiR* (*Rhizobium* autoinducer) genes identified in specific strains of *R. etli* (Rosemeyer *et al.*, 1998) and *R. leguminosarum* (Wisniewski-Dyé and Downie, 2002a) are absent from a closely related strain of *R. leguminosarum*. It is, therefore, not altogether surprising that identifying phenotypic changes induced by mutations in such genes is not always simple, because it may be critical to grow the strains under specific conditions in order to detect effects of the mutations. For example, it appears that *R. etli cinI/R* mutants are defective for swarming when assayed under appropriate conditions (Daniels *et al.*, 2004).

It appears that most genera of rhizobia make AHLs, although not all genes have been characterised. The genome annotation of *M. loti* (Kaneko *et al.*, 2000) indicates that there are multiple putative AHL synthases and the genome sequence of *B. japonicum* (Kaneko *et al.*, 2002) also indicates that there is an AHL synthase. In *B. japonicum*, an unusual molecule, bradyoxetin, has been proposed as a quorum-sensing signal that couples population density to the regulation of nodulation genes and bradyoxetin production is induced under iron-limiting conditions (Loh *et al.*, 2002). Clearly, there is a great deal of work to be done to fully understand the integration of the various different quorum sensing-regulatory systems in relation to the various steps of interactions between rhizobia and their host plants.

5.3. Environmental Responses of Rhizobia: Conclusions

1. Both the composition of flagella and the regulation of motility in rhizobia are more complex than in well-studied enteric bacteria.
2. Chemotaxis and motility play a role in competitive nodulation.
3. Chemotaxis and motility genes are down-regulated during the nodulation process, though the mechanism is not understood.
4. Quorum sensing regulates many aspects of rhizobial growth and metabolism, including plasmid transfer, EPS synthesis, nodulation, and N₂ fixation.

6. CHANGES IN GENE EXPRESSION IN BACTERIODS

6.1. Changes in Gene Expression

So far, we have primarily considered the growth and metabolism of rhizobia in their free-living form. However, the growth of rhizobia in the infection threads and their subsequent engulfment by plant cells to form symbiosomes are crucial steps in the formation of an effective N₂-fixing symbiosis. Many aspects of these steps are dealt with in detail elsewhere in this volume, so we will not consider them here and an excellent overview has been published recently (Batut *et al.*, 2004). However, it is relevant to ask about the physiology of these developmental steps and their regulation. A systematic approach to studying growth and survival in these environments is difficult because large numbers of bacteria from each stage of development cannot be easily obtained. What we know about the physiology of growth in the infection thread tends to be based on microscopy, which reveals little about the biochemical and genetic changes taking place (Gage, 2002; 2004; Gage and Margolin, 2000; Gage *et al.*, 1996). Many mutants have been isolated that are arrested in development either in the infection thread, in bacteroid formation, or in N₂ fixation. These studies show that intact cell surface LPS and EPS layers are crucial to enable bacteria to progress past the infection thread and form differentiated bacteroids (Brewin, 1991; Leigh and Walker, 1994; Ferguson *et al.*, 2004); these matters are discussed in detail in chapters 5, 6 and 7 of this volume.

Our focus is on the general physiological and genetic changes that occur in cells in the infection threads and in developing bacteroids. One strategy to examine gene expression in infection threads is the promoter-trapping strategy, *in vivo* expression technology (IVET). In one such study, a *bacA* mutant of *S. meliloti*, which either cannot form developed bacteroids and tends to arrest in the infection thread or has very early release and development of bacteroids, was used as the marker strain for IVET (Oke and Long, 1999). This strategy allows the identification of genes, which are expressed in the infection thread and hence rescue nodule formation, but which are not expressed in free-living culture. Of 230 fusions that rescued growth, 23 were further studied by sequencing, three were already known from other work, six were homologous to proteins not previously associated with symbiosis, and 14 had no similarity to proteins of known function. Five mutants were analysed and one, *nex18*, induced a mixture of Fix⁺ and Fix⁻ nodules. The availability of genome sequences, IVET, and other post-genomic analyses (microarrays and signature-tagged mutagenesis) should prove to be a powerful way forward to addressing this technically very demanding problem.

Microarrays and proteomics have been used to look at the physiological state of mature alfalfa bacteroids compared to free-living cultures (Barnett *et al.*, 2004; Becker *et al.*, 2004; Djordjevic *et al.*, 2003b). Microarray analysis showed that, in bacteroids, transcription of 342 genes was up-regulated and that of 640 genes down-regulated. Many of the down-regulated genes are involved in central metabolism, which is not surprising in a non-growing cell (Becker *et al.*, 2004); they include genes essential for purine biosynthesis and DNA metabolism and the two main sigma factors in the cell, *rpoE1* and *sigA*. O₂ limitation of cultured bacteria was found to mimic some of the changes seen in bacteroids but the overlap was only partial. Limited O₂ is, therefore, one key signal in bacteroid metabolism but there must be many others. Proteomic analysis reveals that alfalfa bacteroids appear to be under reactive O₂ and osmotic stress (Djordjevic *et al.*, 2003b).

6.2. Bacteroid Gene Expression: Conclusions

1. Changes in rhizobial gene expression and physiology in the infection thread and during bacteroid development have been difficult to determine.
2. Strategies, such as IVET and microarray analysis, are beginning to tell us which genes are switched on during bacteroid formation.
3. Bacteroids are non-growing cells that have many genes of central metabolism transcriptionally down-regulated.

7. STRESS RESPONSES IN RHIZOBIA

7.1. Introduction

The capacity of rhizobia to respond and adapt to a shift in the soil-stress profile is an important physiological process that determines survival and even growth in the

encountered conditions. The ability to persist in the soil ensures nodulation of a legume host and enables N₂ fixation to occur. Some strains of *Rhizobium* display a better capacity to withstand stress than others. In fact, optimal nitrogen-fixing strains that are unable to adapt to the soil environment are quite often out-competed by other resident adapted strains, which often display inferior N₂-fixing phenotypes with a selected legume host. Genetic evidence supports the suggestion that environmental challenge occurs not only in the soil environment but also when rhizobia are released into plant cells following infection.

A variety of stresses (Table 1) may induce a shock-response (or stress response) in a cell providing the agent is not lethal. Such a response may be triggered by a general or specific stress signal and may occur at the transcriptional, translational, or proteolytic level. It is the intention of this review to focus on osmotic, pH, and starvation/stringent responses of the rhizobia.

Table 1. Cell stressors relevant to root-nodule bacteria.

Type	Description
Biological	Host reaction against an invading microbe or phage
Chemical	Insecticides Fungicides Heavy metals Osmotic (hyper- or hypo-osmotic conditions) Oxygen radical toxicity and anaerobiosis pH (acid or alkaline or pH shift) Starvation (carbon, nitrogen and phosphate limitation)
Physical	Ultraviolet light Desiccation Thermal (high or low temperature)

7.2. Osmotic Stress

High soil salinity causes poor crop productivity in one-third of the world's arable land. High salt concentrations inhibit growth of microbes through mechanisms that involve both osmotic stress and direct ion toxicity. For rhizobia, high salt concentrations in soil not only affect survival under free-living conditions but such concentrations have a detrimental affect on the symbiosis (Zahrán, 1999). In the rhizosphere, the osmolality of soil water is generally thought to be high in contrast to the osmolality of highly hydrated bulk soil (Miller and Wood, 1996). The ability to adapt to the osmolality of the soil environment will determine successful colonization by rhizosphere bacteria. Exposure of bacteria to a condition of either high or low osmolality leads to a hyper- or hypo-osmotic response, respectively.

Following hyper-osmotic exposure, bacteria accumulate osmoprotective solutes within the cytoplasm either by *de novo* synthesis or from an exogenous supply. The osmolarity of the accumulated metabolites within the cell is often greater than that of the environment and so provides the cell with sufficient turgor pressure to prevent cell lysis (Csonka, 1989). The spectrum of solutes accumulated by bacteria is highly diverse (Roessler and Müller, 2001). Rhizobia accumulate potassium and glutamate ions, N-acetylglutaminyglutamine amide (NAGGN), glycine betaine, proline, and betaine (Smith *et al.*, 1988; Smith and Smith, 1989). Accumulation of trehalose has been suggested as a protective measure used by hyperosmotic-stressed rhizobia (Breedveld *et al.*, 1990; Dardanelli *et al.*, 2000; Gouffi *et al.*, 1998; Hoelzle and Streeter, 1989; Pfeffer *et al.*, 1994).

Ectoine plays a major role in osmoprotection for rhizobia without being accumulated (Gouffi *et al.*, 1999). It is osmoprotective towards *Sinorhizobium* and other strains, including *R. leguminosarum*, *B. japonicum*, and *Rhizobium* sp. that are normally insensitive to other osmoprotectants (Talibart *et al.*, 1994). Ectoine appears not to be directly osmoprotective but rather to act as a mediator triggering the accumulation of other metabolites, such as glutamate and N-acetylglutaminyglutamine amide, required to restore osmotic balance. A number of sugars, including trehalose, maltose, cellobiose, gentiobiose, turanose, and palatinose, seem to act similarly (Gouffi *et al.*, 1999).

Hyper-osmotic response is a complex phenomenon involving regulation of genes involved in a broad range of physiological functions. Analysis of Tn5-induced salt-sensitive mutants of *R. tropici* showed that insertional inactivation of *ntrY*, *noeJ*, *kup*, *alaS*, *nifS*, *dnaJ*, or *greA* not only caused decreased salt tolerance but also compromised symbiotic ability (Nogales *et al.*, 2002). Microarray analysis has revealed osmstress-dependent gene expression in *S. meliloti* 1021, with changes in the expression of genes required for chemotaxis, motility, surface structure, iron uptake, transport of small molecules, and amino-acid biosynthesis. This whole genome transcriptomics study revealed the induction of 52 genes and the repression of 85 by high salt in the media (Ruberg *et al.*, 2003). Other salt-induced responses in rhizobia include changes in cell morphology and size, as well as modification of symbiotically important polysaccharides (EPS and LPS) (Lloret *et al.*, 1998; Soussi *et al.*, 2001; Ruberg *et al.*, 2003).

In hypo-osmotic conditions, cyclic β -glucans, related to membrane-derived oligosaccharides (MDO's) of *E. coli* (Kennedy, 1996), function as important periplasmic solutes (Breedveld and Miller, 1994; Miller *et al.*, 1986). Accumulation of these molecules in the periplasmic space protects cells in hypo-osmotic environments by reducing the turgor pressure across the cytoplasmic membrane. Production of cyclic glucans is strongly repressed in high osmotic strength media. In a wide variety of *Bradyrhizobium*, *Rhizobium*, and *Sinorhizobium* strains, maximum levels of cyclic β -glucans occur when cells are grown in low osmolarity media. Mutants defective for cyclic β -glucan biosynthesis or transport are impaired not only for growth in hypo-osmotic media but also for host-plant infection (Breedveld and Miller, 1994).

Cyclic glucans produced by different rhizobia differ in size (number of glucose residues per molecule) and the type of glycosidic bonds. In *S. meliloti*, there may be as many as 40 glucose molecules, whereas in *R. leguminosarum*, there are 14-25 glucose units joined by β -(1,2) glycosidic bonds. *B. japonicum* produces smaller molecules with only 10-13 glucose units that are joined through β -(1,3) and β -(1,6) linkages. In *S. meliloti*, the *ndvB* gene (ortholog of *A. tumefaciens chvB*) encodes a biosynthetic enzyme required to form the cyclic β -(1,2)-glucan backbone from UDP-glucose (Ielpi *et al.*, 1990; Zorreguieta *et al.*, 1988). Another gene, *ndvA* (ortholog of *A. tumefaciens chvA*) is required for transport of the cyclic β -glucans to the periplasm and extracellular medium (Stanfield *et al.*, 1988). Orthologs of *ndvA* and *ndvB* have also been found in *R. leguminosarum*.

During plant infection and hypo-osmotic adaption, the cyclic β -glucans of rhizobia become highly decorated with phosphoglycerol and succinyl substituents. In *S. meliloti*, a *cgmB* (cyclic glucan modification) mutant that was specifically impaired in its ability to transfer phosphoglycerol substituents to the cyclic β -glucan backbone retains its ability to nodulate and adapt to hypo-osmotic conditions. The overall negative charge on the cyclic glucans produced by these mutants was compensated by increased succinylation. Apparently, the anionic nature of cyclic β -glucans is the determining factor for hypo-osmotic adaption (Wang *et al.*, 1999).

There are few examples of proteins whose expression leads directly to a high level of salt tolerance in a strain. An intriguing example is the recently-identified Pha2 system, thought to code for a Na^+/H^+ exchange system in *S. fredii* (Jiang *et al.*, 2004); mutants in this system in strain RT19 lose their very high salt resistance. It would be intriguing to see if expression of this system in other strains and species of rhizobia can confer increased salt resistance. The multi-component Pha2 exchange transporter has considerable similarity to the Pha1 system, which is considered to be a K^+/H^+ exchanger essential for growth of *S. meliloti* under alkaline conditions (Putnoky *et al.*, 1998).

7.3. Acidity

Soil pH not only influences biological activity but also the availability of different nutrients. The limitation to legume productivity in acidic soils largely resides in the inability of the prokaryotic microsymbiont to survive and persist in such a hostile environment (del Papa *et al.*, 1999; Howieson and Ewing, 1986; Robson and Loneragan, 1970). The sensitivity of rhizobia to low pH varies markedly; strains of *M. loti*, *R. tropici*, and *Bradyrhizobium* spp are more tolerant to acidity (Ballen *et al.*, 1998; Dilworth *et al.*, 2000; Graham *et al.*, 1994; Howieson and Ewing, 1986; Munns, 1986) than strains from the genus *Sinorhizobium*, some of which are particularly sensitive to acidity and fail to survive below pH 5.5 (Graham and Parker, 1964; Howieson *et al.*, 1992; Reeve *et al.*, 1993). The selection of more acid-tolerant inoculants of *Sinorhizobium* from the genetic pool (Howieson *et al.*, 1988) and identifying the genetic basis for this superiority (Dilworth *et al.*, 2000) have been major research directions.

Rhizobia exposed to mild acid trigger an inducible system, termed the “Acid-Tolerance Response” (ATR), that enables cells to cope more effectively with a subsequent potentially lethal acid shock (O’Hara and Glenn, 1994), but the pH-regulated proteins required for an effective ATR have not been identified. Approaches that include random- and targeted-gene inactivation, transcription analysis (Priefer *et al.*, 2001; Tiwari *et al.*, 2004; Vinuesa *et al.*, 2003) and more recently global cell changes detected by proteomic (Djordjevic *et al.*, 2003a; Reeve *et al.*, 2004) and microarray analyses (Ampe *et al.*, 2003b), have identified pH-regulated genes and proteins, but the overlap with ATR-response proteins has not yet been established. Some of these acid-inducible proteins, such as *phrR* (Reeve *et al.*, 1998), do not appear to be essential for viability in acid conditions, whereas the significance of others remains to be determined.

In contrast, other genes are essential for cell survival in acid conditions and expression of some of these is not acid-activated. Some of the genes essential for growth or even viability in acidic conditions appear to be involved in the modification of the cell envelope. Such genes include *actA* (lipopolysaccharide biosynthesis), an *epsD* ortholog and *exoH* (exopolysaccharide biosynthesis) of *S. medicae* (Dilworth *et al.*, 2000; Glenn *et al.*, 1999; Tiwari *et al.*, 1992; 1996a), *bacA* (bacteroid differentiation), and *lpsB* and *typA* (lipopolysaccharide biosynthesis) of *S. meliloti* (Ferguson *et al.*, 2002; Kiss *et al.*, 2004). Other essential acid-tolerance genes found in other genera include: *sdhA* (sugar catabolism), *ubiH* (ubiquinone biosynthesis), and genes related to cobalamin biosynthesis in *Phaseolus* symbionts (Priefer *et al.*, 2001); and *acvB* (ortholog of the *A. tumefaciens* virulence gene) (Vinuesa *et al.*, 2003) and *gshB* (detoxification) (Ricciolo *et al.*, 2000) in *R. tropici*. Many acid-sensitive mutants display typical pleiotropic defects that one would expect from cell-envelope disruption. The acid-sensitive *S. medicae* mutants show additional sensitivity to one or more other stresses, such as Zn, Cd, Cu, or azide. The *bacA* and *lpsB* mutants of *S. meliloti* are also sensitive to Zn ions, whereas the *bacA* mutant is also sensitive to detergents. The significant reduction in the amount of the LPS fatty acid, 27-OH-C28:0, in the *bacA* mutant of *S. meliloti* has been suggested as the cause of the phenotypic defects in the *bacA* mutants (Ferguson *et al.*, 2002). A change in the C16:C18 ratio and the percentage of 19:0 cyclopropane acids in membrane fatty acids has also been reported in *R. tropici* following low pH culture (Ballen *et al.*, 1998).

Defects in the membrane may be overcome by increasing calcium (and sometimes magnesium) levels in the medium, an effect observed for many of the acid-sensitive mutants. Elevated levels of divalent cations can stabilize membrane structure and may explain two other phenomena; high calcium concentrations in the growth media increase the growth rate of *S. medicae* at low pH and also allow cell growth at progressively more acidic pH values (Howieson *et al.*, 1992; Reeve *et al.*, 1993; Watkin, 1997). Changes in the outer membrane-protein profile in response to pH and calcium have been reported in *R. tropici* (Ballen *et al.*, 1998).

In *S. medicae*, expression of the LpiA membrane protein is strongly (20-fold) induced by low pH (Reeve *et al.*, 1999) and varies as a function of the pH and calcium concentration. This gene is also induced by acid in both *R. tropici* (Vinuesa

et al., 2003) and in *A. tumefaciens* (E. Nester, personal communication). The function of this acid-responsive gene has not been defined, but it may have a role in lipid metabolism.

Other putative membrane-bound proteins also appear to be induced in acidic conditions; some of them have no established role but, on the basis of homology, could be involved in solute transport (Reeve *et al.*, 2004). Others have more definitive roles in ion transport. ActP, in both *S. medicae* and *R. leguminosarum*, is a copper-ion transporter required for a copper-efflux detoxification program preventing Cu toxicity (Reeve *et al.*, 2002). At low pH, copper-ion toxicity increases and an effective efflux of copper occurs as the result of the induction of *actP*. Other ion transporters are also induced by acidic conditions. In *S. medicae*, the *kdp* operon (involved in potassium import) is up-regulated by low pH (Tiwari *et al.*, 2004). Potassium-ion cycling is an essential component of pH homeostasis in other organisms (Asha and Gowrishankar, 1993; Booth, 1985) and counteracts the increase in the membrane potential generated at low pH. In contrast, the *pha* gene cluster, which encodes a potassium-efflux transporter, is essential for the growth of *S. meliloti* in alkaline conditions (Putnoky *et al.*, 1998).

Apart from regulating ion homeostasis, acid-stressed cells may also need to alter proton-pumping rates and detoxify oxygen radicals. The use of an alternative electron acceptor by enteric bacteria may minimize proton extrusion preventing further external acidification (Slonczewski and Foster, 1996). In *E. coli*, the high O₂-affinity cytochrome oxidase is induced in acidic conditions. Insertional inactivation of a high O₂-affinity cytochrome oxidase in *Brucella* is lethal to cells in acidic conditions but not if multiple copies of SOD are present (Endley *et al.*, 2001), which suggests that O₂ toxicity is the driving limitation in such conditions.

The expression of *S. medicae fixN2* (encoding a component of the high oxygen-affinity *cbh3* cytochrome oxidase) is up-regulated in acidic conditions (Tiwari *et al.*, 2004). Expression of *fixN2* is regulated in *S. medicae* by the signal-transduction system, ActRS, through a microaerobic and low pH signal (Fenner *et al.*, 2004; Tiwari *et al.*, 1996b). Both ActR (the response regulator) and ActS (its cognate sensor histidine kinase) are essential for growth at low pH in *S. medicae*. This two-component system is also required for growth of *R. leguminosarum* in acidic conditions, although mutations in ActSR also affect the growth rate at neutral pH (Priefer *et al.*, 2001). In *S. medicae*, this two-component system regulates diverse processes, such as nitrate assimilation, hydantoin metabolism, signal transduction, and detoxification (Fenner *et al.*, 2004).

It has been suggested that the nodule environment is acidic (Day *et al.*, 2001), but there are varying reports as to whether acid tolerance is required for a successful symbiosis. Low pH sensitivity does not seem to affect nodulation and N₂ fixation of *S. medicae* mutants (Dilworth *et al.*, 2000). In contrast, *bacA* or *lpsB* mutants of *S. meliloti* and *gshB* mutants of *R. tropici* are acid-sensitive and fail to establish an effective symbiotic relationship with their host legumes (Vinuesa *et al.*, 2003). In these cases, however, the observed symbiotic failure could be attributed to factors other than acid sensitivity *per se*.

In *S. medicae*, acid shock induces the synthesis of at least 50 pH-regulated proteins (Reeve *et al.*, 2004). The cellular pathways affected are varied and a conservative estimate of the number of genes affected (at least in *Sinorhizobium*) would be around 100. Proteins required for pH adaptation and survival processes appear to be quite different from the enteric bacteria in many cases. For example, the sigma factor RpoS required for the induction of acid-shock proteins in the enterics is absent from the genome sequence for *S. meliloti* 1021 (Galibert *et al.*, 2001b). Furthermore, several genes (such as *lpiA*) required for pH response and survival in rhizobia are not found in enteric bacteria. The pH response of *S. medicae* is regulated through a number of different regulatory proteins that control signal transduction (*via* ActRS; Tiwari *et al.*, 1996b), general stress (*via* PhrR; Reeve *et al.*, 1998), acid-activation (*via* FsrR), ion-cycling (Reeve *et al.*, 2002; Tiwari *et al.*, 2004), protein degradation and chaperone pathways (Reeve *et al.*, 2004). Other pathways are also affected (Reeve *et al.*, 2004; Tiwari *et al.*, 2004), although the functions of these proteins, and the extent of the overlap with existing systems, are not yet known.

7.4. Oxidative Stress

Bacteria must deal with reactive oxygen species (ROS) generated through a number of pathways, including the electron-transport chain. If not detoxified, ROS damage cellular macromolecules, including lipids, proteins, and DNA. A number of superoxide dismutases (SOD) and catalases are employed for the detoxification process. Different SODs and catalases are present in different free-living rhizobia and also in symbiosis (see Becana *et al.*, 2000; Dombrecht *et al.*, 2005; and chapter 11 of this volume). Two genes encoding Mn-SOD and CuZn-SOD are present in *S. meliloti* (Galibert *et al.*, 2001a; Santos *et al.*, 2001) and another *S. meliloti* protein with 62% identity to *B. japonicum* SodM is found in from the genome sequence.

Each of the three catalase-encoding genes, *smc00819* (KatA), *sma2379* (KatB) and *smb20007* (KatC), of *S. meliloti* can be assigned to a different replicon. KatA and KatC are monofunctional catalases whereas KatB is a bifunctional enzyme with catalase-peroxidase activities (Jamet *et al.*, 2003). KatB is produced constitutively at a low level, whereas KatA is regulated by OxyR in *S. meliloti*, both in the free-living and symbiotic condition (Jamet *et al.*, 2005). KatC is induced by osmotic and thermal stresses. Three catalase isoforms have been identified in other rhizobia as well, namely, *R. leguminosarum* bv *phaseoli*, *R. leguminosarum* bv *trifolii*, *B. japonicum*, and *S. fredii* (Ohwada *et al.*, 1999). In contrast, *R. etli* CFN42 contains a single bifunctional enzyme, KatG (Vargas *et al.*, 2003).

Recently, microarray analysis has identified another gene in *S. meliloti* (*smc01944*) that is induced five-fold more strongly by hydrogen peroxide than *kata*. *Smc01944* encodes a chloroperoxidase that may constitute the first line of defence to ROS in *S. meliloti* because it has the capacity to simultaneously detoxify the cytoplasm, the periplasm, and the external medium (Barloy-Hubler *et al.*, 2004).

7.5. Starvation and the Stringent Response and Heat Shock

Free-living rhizobia have to survive long periods of carbon, nitrogen, and/or phosphate starvation in the soil prior to being able to form a symbiotic relationship. Indeed, rhizosphere-colonising bacteria live in a “feast-or-famine” existence, particularly in association with annual plants (Thorne and Williams, 1997). Some strains, such as *R. leguminosarum*, can survive at least 2 months’ starvation with little loss in viability (Thorne and Williams, 1997) and nutrient limitation has been shown to promote root attachment (Smit *et al.*, 1992). Extended nutrient deprivation may result in a reduction in cell division and in protein, DNA, and RNA synthesis. In *S. meliloti*, noticeable effects of starvation include the loss of flagella and flagella integrity, and flagellar motor inactivation (Wei and Bauer, 1998). Metabolically less active cells may acquire the potential for long-term survival and are cross-protected against heat, pH, osmotic and oxidative shock. Upon the acquisition of nutrients, the cells rapidly re-enter exponential growth.

Tnlux fusions have been used to isolate genes induced under carbon, nitrogen or O₂ starvation in *S. meliloti* (Milcamps *et al.*, 1998; Trzebiatowski *et al.*, 2001). One of the genes induced by carbon and nitrogen starvation (*hmgA*) codes for homogenisate dioxygenase, and is required for degradation of tyrosine (Milcamps and de Bruijn, 1999). NitR (ArsR regulator family) regulates *hmgA* under conditions of nitrogen deprivation, independently of the well-characterized Ntr system (Milcamps *et al.*, 2001). Two other nutrient deficiency induced genes (*ndiAB*), which are induced by carbon and nitrogen deprivation, osmotic stress, and O₂-limitation and during entry into stationary phase, are regulated by TspO and partially by FixL under O₂ limitation (Davey and de Bruijn, 2000). Of eleven genes regulated by O₂ deprivation, seven were independent of regulation by FixL and FixJ (Trzebiatowski *et al.*, 2001), suggesting that response to nutrient starvation is at least partly under the control of different regulators from those involved in central metabolism and N₂ fixation.

In harsh environments (such as saline or acidic soils), rhizobia may experience nutrient deficiency, even in the presence of nutrients. Under severe stress, the requirement for certain essential elements, such as calcium (Reeve *et al.*, 1993) and phosphorus (Zahran, 1999), increases and elevated levels of these elements enhance nodulation and N₂ fixation.

Rhizobia have developed different mechanisms to survive phosphate limitation. A high-affinity phosphate-uptake system, encoded by *phoCDET* genes (Voegelé *et al.*, 1997), enables transport and assimilation of phosphate or phosphorus-containing compounds by *S. meliloti* cultured in phosphate-limiting conditions. Cells may cope in phosphate-limiting conditions by substituting the membrane phospholipids with lipids that do not contain phosphorus. Such substitutions include sulfolipids, ornithine lipids, and the *de novo* synthesis of diacylglyceryl-trimethylhomoserine (DGTS) lipids (Geiger *et al.*, 1999).

Adverse nutrient conditions, such as amino acid (or other carbon) starvation, triggers an array of changes in bacterial cells designated the stringent response and

is initiated when uncharged tRNA is bound to ribosomes (Cashel *et al.*, 1996). The stringent response is characterised by a reduction in the synthesis of stable RNA and a reduction in the amount of ribosomal-protein mRNA. The signal for the stringent response is mediated through the accumulation of the 'magic spot' guanosine tetra-(ppGpp) and penta-phosphate (pppGpp) molecules (Cashel *et al.*, 1996). Interaction of (p)ppGpp with subunits of RNA polymerase decreases the half-life of the open complex during initiation of transcription. It particularly affects genes that transcribe stable RNA by further decreasing the half-life of already short-lived open complexes. It also lowers the affinity of sigma-70 for the core enzyme, which frees up RNA polymerase to bind with alternative sigma factors. The result is an altered gene-expression profile required for cells to survive in the new environment (Barker *et al.*, 2001a; 2001b).

Several research groups have reported the accumulation of ppGpp in symbiotic and free-living N₂-fixing bacteria (Belitsky and Kari, 1982; Howorth and England, 1999; Kleiner and Phillips, 1981). Many Gram-negative bacteria (such as *E. coli*) contain the two distinct genes, *relA* and *spoT*, for synthesis and hydrolysis of ppGpp, respectively. In contrast, members of the Rhizobiaceae have a dual function gene (*relA/spoT* homolog) similar to many Gram-positive bacteria (Galibert *et al.*, 2001b; Primm *et al.*, 2000; Wells and Long, 2002; 2003). The *relA* mutant of *S. meliloti* does not produce ppGpp, is auxotrophic, over-produces succinoglycan, and fails to form nodules on alfalfa (Wells and Long, 2002), suggesting a role for the stringent response in symbiosis.

With respect to the classical heat-shock response of bacteria, the rhizobia possess between three and five copies of the *cpn60* (GroEL) and *cpn10* (GroES) genes (Fischer *et al.*, 1993; Rusanganwa and Gupta, 1993; Wallington and Lund, 1994). It is particularly important that they appear to be differentially regulated. The *groESL3* genes from *B. japonicum* are co-regulated with symbiotic N₂-fixation genes (Fischer *et al.*, 1993), activated by NifA under low O₂, and transcribed from a -24/-12 promoter by the sigma-54 RNA polymerase.

7.6. Stress Responses in Rhizobia: Conclusions

1. In hyper-osmotic conditions, rhizobia accumulate osmoprotective solutes, like potassium and glutamate ions, NAGGN, proline, betaine, ectoine, and a number of sugars. In hypo-osmotic conditions, cyclic β -glucans accumulate in the periplasmic space.
2. The pH response of *S. medicae* is regulated through a number of different regulatory proteins that control the pathways of signal transduction, general stress, acid activation, ion cycling, protein degradation, and chaperone action.
3. Many acid-sensitive mutants display pleiotropic phenotypes, including sensitivity to heavy metals (such as Zn, Cu, Cd) and azide.
4. Proteins required for pH adaptation and survival processes in rhizobia appear not to be regulated in the same way as in the enterics.

5. Under phosphate limitation, substitution of membrane phospholipids with sulpholipids, ornithine lipids, and DGTS lipids occurs.
6. Major detoxifying enzymes, such as SOD and various catalases, are used to detoxify ROS in rhizobia. A unique chloroperoxidase has been suggested as a first line of defence against ROS in *S. meliloti*.
7. In the stringent response, the concentration of the magic spot '(p)ppGpp' is regulated through a dual function RelA/SpoT homolog, which is similar to the enzyme in various Gram-positive bacteria.

REFERENCES

- Aguilar, J. M. M., Ashby, A. M., Richards, A. J. M., Loake, G. J., Watson, M. D., and Shaw, C. H. (1988). Chemotaxis of *Rhizobium leguminosarum* biovar *phaseoli* towards flavonoid inducers of the symbiotic nodulation genes. *J. Gen. Microbiol.*, *134*, 2741-2746.
- Alexandre, G., and Zhulin, I. B. (2001). More than one way to sense chemicals. *J. Bacteriol.*, *183*, 4681-4686.
- Alexandre, G., Greer-Phillips, S., and Zhulin, I. B. (2004). Ecological role of energy taxis in microorganisms. *FEMS Microbiol. Rev.*, *28*, 113-126.
- Alfano, J. R., and Kahn, M. L. (1993). Isolation and characterization of a gene coding for a novel aspartate aminotransferase from *Rhizobium meliloti*. *J. Bacteriol.*, *175*, 4186-4196.
- Allaway, D., Lodwig, E., Crompton, L. A., Wood, M., Parsons, R., et al. (2000). Identification of alanine dehydrogenase and its role in mixed secretion of ammonium and alanine by pea bacteroids. *Mol. Microbiol.*, *36*, 508-515.
- Allaway, D., Schofield, N. A., Leonard, M. E., Gilardoni, L., Finan, T. M., and Poole, P. S. (2001). Use of differential fluorescence induction and optical trapping to isolate environmentally induced genes. *Environ. Microbiol.*, *3*, 397-406.
- Ames, P., and Bergman, K. (1981). Competitive advantage provided by bacterial motility in the formation of nodules by *Rhizobium meliloti*. *J. Bacteriol.*, *148*, 728-729.
- Ampe, F., Kiss, E., Sabourdy, F., and Batut, J. (2003a). Transcriptome analysis of *Sinorhizobium meliloti* during symbiosis. *Genome Biol.*, *4*, R15.
- An, J. H., Lee, H. Y., Ko, K. N., Kim, E. S., and Kim, Y. S. (2002). Symbiotic effects of Delta matB *Rhizobium leguminosarum* bv. *trifolii* mutant on clovers. *Mol. Cells*, *14*, 261-266.
- Andrews, S. C., Robinson, A. K., and Rodriguez-Quinones, F. (2003). Bacterial iron homeostasis. *FEMS Microbiol. Rev.*, *27*, 215-237.
- Aneja, P., and Charles, T. C. (1999). Poly-3-hydroxybutyrate degradation in *Rhizobium* (*Sinorhizobium*) *meliloti*: Isolation and characterization of a gene encoding 3-hydroxybutyrate dehydrogenase. *J. Bacteriol.*, *181*, 849-857.
- Appels, M. A., and Haaker, H. (1991). Glutamate oxaloacetate transaminase in pea root nodules - participation in a malate/aspartate shuttle between plant and bacteroid. *Plant Physiol.*, *95*, 740-747.
- Armitage, J. P., Gallagher, A., and Johnston, A. W. B. (1988). Comparison of the chemotactic behavior of *Rhizobium leguminosarum* with and without the nodulation plasmid. *Mol. Microbiol.*, *2*, 743-748.
- Armitage, J. P., and Schmitt, R. (1997). Bacterial chemotaxis: *Rhodobacter sphaeroides* and *Sinorhizobium meliloti* - variations on a theme? *Microbiology*, *143*, 3671-3682.
- Asha, H., and Gowrishankar, J. (1993). Regulation of *kdp* operon expression in *Escherichia coli*: evidence against turgor as signal for transcriptional control. *J. Bacteriol.*, *175*, 4528-4537.
- Baginsky, C., Brito, B., Imperial, J., Palacios, J. M., and Ruiz-Argüeso, T. (2002). Diversity and evolution of hydrogenase systems in rhizobia. *Appl. Environ. Microbiol.*, *68*, 4915-4924.
- Bahar, M., de Majnik, J., Wexler, M., Fry, J., Poole, P. S., and Murphy, P. J. (1998). A model for the catabolism of rhizopine in *Rhizobium leguminosarum* involves a ferredoxin oxygenase complex and the inositol degradative pathway. *Mol. Plant-Microbe Interact.*, *11*, 1057-1068.

- Ballen, K. G., Graham, P. H., Jones, R. K., and Bowers, J. H. (1998). Acidity and calcium interaction affecting cell envelope stability in *Rhizobium*. *Can. J. Microbiol.*, *44*, 582-587.
- Barker, M. M., Gaal, T., and Gourse, R. L. (2001a). Mechanism of regulation of transcription initiation by ppGpp. II. Models for positive control based on properties of RNAP mutants and competition for RNAP. *J. Mol. Biol.*, *305*, 689-702.
- Barker, M. M., Gaal, T., Josaitis, C. A., and Gourse, R. L. (2001b). Mechanism of regulation of transcription initiation by ppGpp. I. Effects of ppGpp on transcription initiation *in vivo* and *in vitro*. *J. Mol. Biol.*, *305*, 673-688.
- Barloy-Hubler, F., Chéron, A., Hellégouarch, A., and Galibert, F. (2004). Smc01944, a secreted peroxidase induced by oxidative stresses in *Sinorhizobium meliloti* 1021. *Microbiology*, *150*, 657-664.
- Barnett, M. J., Tolman, C. J., Fisher, R. F., and Long, S. R. (2004). A dual-genome symbiosis chip for coordinate study of signal exchange and development in a prokaryote-host interaction. *Proc. Natl. Acad. Sci. USA*, *101*, 16636-16641.
- Batut, J., Andersson, S. G. E., and O'Callaghan, D. (2004). The evolution of chronic infection strategies in the α -proteobacteria. *Nature Revs. Microbiol.*, *2*, 933-945.
- Becana, M., Dalton, D. A., Moran, J. F., Iturbe-Ormaetxe, I., Matamoros, M. A., and Rubio, M. C. (2000). Reactive oxygen species and antioxidants in legume nodules. *Physiol. Plant.*, *109*, 372-381.
- Becker, A., Bergès, H., Krol, E., Bruand, C., Rüberg, S., Capela, D., *et al.* (2004). Global changes in gene expression in *Sinorhizobium meliloti* 1021 under microoxic and symbiotic conditions. *Mol. Plant-Microbe Interact.*, *17*, 292-303.
- Belitsky, B., and Kari, C. (1982). Absence of accumulation of ppGpp and RNA during amino acid starvation in *Rhizobium meliloti*. *J. Biol. Chem.*, *257*, 4677-4679.
- Bell, E. A. (2003). Nonprotein amino acids of plants: Significance in medicine, nutrition, and agriculture. *J. Agric. Food Chem.*, *51*, 2854-2865.
- Benson, H. P., LeVier, K., and Guerinot, M. L. (2004). A dominant-negative *fur* mutation in *Bradyrhizobium japonicum*. *J. Bacteriol.*, *186*, 1409-1414.
- Bergersen, F. J., and Turner, G. L. (1990). Bacteroids from soybean root nodules: Accumulation of poly- β -hydroxybutyrate during supply of malate and succinate in relation to N_2 fixation in flow-chamber reactions. *Proc. Roy. Soc. London, B*, *240*, 39-59.
- Bergersen, F. J., Peoples, M. B., and Turner, G. L. (1991). A role for poly- β -hydroxybutyrate in bacteroids of soybean root nodules. *Proc. Roy. Soc. London, B*, *245*, 59-64.
- Bergersen, F. J., and Turner, G. L. (1993). Effects of concentrations of substrates supplied to N_2 -fixing soybean bacteroids in flow chamber reactions. *Proc. Roy. Soc. London, B*, *251*, 95-102.
- Boivin, C., Camut, S., Malpica, C. A., Truchet, G., and Rosenberg, C. (1990). *Rhizobium meliloti* genes encoding catabolism of trigonelline are induced under symbiotic conditions. *Plant Cell*, *2*, 1157-1170.
- Boivin, C., Barran, L. R., Malpica, C. A., and Rosenberg, C. (1991). Genetic analysis of a region of the *Rhizobium meliloti* pSymb plasmid specifying catabolism of trigonelline, a secondary metabolite present in legumes. *J. Bacteriol.*, *173*, 2809-2817.
- Boncompagni, E., Dupont, L., Mignot, T., Østerås, M., Lambert, A., Poggi, M. C., and Le Rudulier, D. (2000). Characterization of a *Sinorhizobium meliloti* ATP-binding cassette histidine transporter also involved in betaine and proline uptake. *J. Bacteriol.*, *182*, 3717-3725.
- Booth, I. R. (1985). Regulation of cytoplasmic pH in bacteria. *Microbiol. Revs.*, *49*, 359-378.
- Borthakur, D., Soedarjo, M., Fox, P. M., and Webb, D. T. (2003). The *mid* genes of *Rhizobium* sp strain TAL1145 are required for degradation of mimosine into 3-hydroxy-4-pyridone and are inducible by mimosine. *Microbiology*, *149*, 537-546.
- Boussau, B., Karlberg, E. O., Frank, A. C., Legault, B.-A., and Anderson, S. G. E. (2004). Computational inferences of scenarios for α -proteobacterial genome evolution. *Proc. Natl. Acad. Sci. USA*, *101*, 9722-9727.
- Bowra, B. J., and Dilworth, M. J. (1981). Motility and chemotaxis towards sugars in *Rhizobium leguminosarum*. *J. Gen. Microbiol.*, *126*, 231-235.
- Bravo, A., and Mora, J. (1988). Ammonium assimilation in *Rhizobium phaseoli* by the glutamine synthetase-glutamate synthase pathway. *J. Bacteriol.*, *170*, 980-984.
- Breedveld, M. W., Zevenhuizen, L. P., and Zehnder, A. J. (1990). Excessive excretion of cyclic beta-(1,2)-glucan by *Rhizobium trifolii* TA-1. *Appl. Environ. Microbiol.*, *56*, 2080-2086.

- Breedveld, M. W., and Miller, K. J. (1994). Cyclic beta-glucans of members of the family Rhizobiaceae. *Microbiol. Rev.*, *58*, 145-161.
- Bren, A., and Eisenbach, M. (2000). How signals are heard during bacterial chemotaxis: Protein-protein interactions in sensory signal propagation. *J. Bacteriol.*, *182*, 6865-6873.
- Brewin, N. J. (1991). Development of the legume root nodule. *Annu. Rev. Cell Biol.*, *7*, 191-226.
- Bringhurst, R. M., Cardon, Z. G., and Gage, D. J. (2001). Galactosides in the rhizosphere: Utilization by *Sinorhizobium meliloti* and development of a biosensor. *Proc. Natl. Acad. Sci. USA*, *98*, 4540-4545.
- Bringhurst, R. M., and Gage, D. J. (2002). Control of inducer accumulation plays a key role in succinate-mediated catabolite repression in *Sinorhizobium meliloti*. *J. Bacteriol.*, *184*, 5385-5392.
- Brom, S., Garcia-de los Santos, A., Stepkowsky, T., Flores, M., Davila, G., Romero, D., and Palacios, R. (1992). Different plasmids of *Rhizobium leguminosarum* bv *phaseoli* are required for optimal symbiotic performance. *J. Bacteriol.*, *174*, 5183-5189.
- Brom, S., Garcia-de los Santos, A., Cervantes, L., Palacios, R., and Romero, D. (2000). In *Rhizobium etli*, symbiotic plasmid transfer, nodulation competitiveness and cellular growth require interaction among different replicons. *Plasmid*, *44*, 34-43.
- Burnet, M. W., Goldmann, A., Message, B., Drong, R., El Amrani, A., et al. (2000). The stachydrine catabolism region in *Sinorhizobium meliloti* encodes a multi-enzyme complex similar to the xenobiotic degrading systems in other bacteria. *Gene*, *244*, 151-161.
- Caetano-Anolles, G., Wall, L. G., De-Micheli, A. T., Macchi, E. M., Bauer, W. D., and Favelukes, G. (1988). Role of motility and chemotaxis in efficiency of nodulation by *Rhizobium meliloti*. *Plant Physiol.*, *86*, 1228-1235.
- Carlson, T. A., Martin, G. B., and Chelm, B. K. (1987). Differential transcription of the two glutamine synthetase genes of *Bradyrhizobium japonicum*. *J. Bacteriol.*, *169*, 5861-5866.
- Cashel, M., Gentry, D. R., Hernandez, V. J., and Vinella, D. (1996). The stringent response. In F. C. C. E. Neidhardt (Ed.), *Escherichia coli and Salmonella cellular and molecular biology*. (pp. 1458-1496). Washington, D.C.: ASM Press.
- Castillo, A., Taboada, H., Mendoza, A., Valderrama, B., Encarnación, S., and Mora, J. (2000). Role of GOGAT in carbon and nitrogen partitioning in *Rhizobium etli*. *Microbiology*, *146*, 1627-1637.
- Cevallos, M. A., Encarnación, S., Leija, A., Mora, Y., and Mora, J. (1996). Genetic and physiological characterization of a *Rhizobium etli* mutant strain unable to synthesize poly-beta-hydroxybutyrate. *J. Bacteriol.*, *178*, 1646-1654.
- Chao, T. C., Becker, A., Buhrmester, J., Pühler, A., and Weidner, S. (2004). The *Sinorhizobium meliloti fur* gene regulates, with dependence on Mn(II), transcription of the *sitABCD* operon, encoding a metal-type transporter. *J. Bacteriol.*, *186*, 3609-3620.
- Charles, T. C., Cai, G. Q., and Aneja, P. (1997). Megaplasmid and chromosomal loci for the PHB degradation pathway in *Rhizobium (Sinorhizobium) meliloti*. *Genetics*, *146*, 1211-1220.
- Charles, T. C., and Aneja, P. (1999). Methylmalonyl-CoA mutase encoding gene of *Sinorhizobium meliloti*. *Gene*, *226*, 121-127.
- Chen, F., Okabe, Y., Osano, K., and Tajima, S. (1997). Purification and characterization of the NADP-malic enzyme from *Bradyrhizobium japonicum* A1017. *Biosci. Biotech. Biochem.*, *61*, 384-386.
- Chen, F., Okabe, Y., Osano, K., and Tajima, S. (1998). Purification and characterization of an NAD-malic enzyme from *Bradyrhizobium japonicum* A1017. *Appl. Environ. Microbiol.*, *64*, 4073-4075.
- Copeland, L., Quinnell, R. G., and Day, D. A. (1989). Malic enzyme activity in bacteroids from soybean nodules. *J. Gen. Microbiol.*, *135*, 2005-2011.
- Csonka, L. N. (1989). Physiological and genetic responses of bacteria to osmotic stress. *Microbiol. Rev.*, *53*, 121-147.
- Cubo, T., Economou, A., Murphy, G., Johnston, A. W. B., and Downie, J. A. (1992). Molecular characterisation and regulation of the rhizosphere-expressed genes *rhiABCR* that can influence nodulation by *Rhizobium leguminosarum* bv *viciae*. *J. Bacteriol.*, *174*, 4026-4035.
- Daniels, R., De Vos, D. E., Desair, J., Raedschelders, G., Luyten, E., Rosemeyer, V., et al. (2002). The *cin* quorum sensing locus of *Rhizobium etli* CNPAF512 affects growth and symbiotic nitrogen fixation. *J. Biol. Chem.*, *277*, 462-468.
- Daniels, R., Vanderleyden, J., and Michiels, J. (2004). Quorum sensing and swarming migration in bacteria. *FEMS Microbiol. Rev.*, *28*, 261-289.

- Danino, V. E., Wilkinson, A., Edwards, A., and Downie, J. A. (2003). Recipient-induced transfer of the symbiotic plasmid pRL1J1 in *Rhizobium leguminosarum* bv. *viciae* is regulated by a quorum-sensing relay. *Mol. Microbiol.*, *50*, 511-525.
- Dardanelli, M. S., González, P. S., Bueno, M. A., and Ghittoni, N. E. (2000). Synthesis, accumulation and hydrolysis of trehalose during growth of peanut rhizobia in hyperosmotic media. *J. Basic Microbiol.*, *40*, 149-156.
- Davey, M. E., and de Bruijn, F. J. (2000). A homologue of the tryptophan-rich sensory protein TspO and FixL regulate a novel nutrient deprivation-induced *Sinorhizobium meliloti* locus. *Appl. Environ. Microbiol.*, *66*, 5353-5359.
- Day, D. A., Kaiser, B. N., Thomson, R., Udvardi, M. K., Moreau, S., and Puppo, A. (2001). Nutrient transport across symbiotic membranes from legume nodules. *Aust. J. Plant Physiol.*, *28*, 667-674.
- Deakin, W. J., Parker, V. E., Wright, E. L., Ashcroft, K. J., Loake, G. J., and Shaw, C. H. (1999). *Agrobacterium tumefaciens* possesses a fourth flagellin gene located in a large gene cluster concerned with flagellar structure, assembly and motility. *Microbiology*, *145*, 1397-1407.
- Del Bel, K. L. (2004). Genetic regulation of chemotaxis and motility in *Rhizobium leguminosarum*. Ph.D. thesis, University of Calgary, Canada.
- del Papa, M. F., Balagué, L. J., Sowinski, S. C., Wegener, C., Segundo, E., Abarca, F. M., *et al.* (1999). Isolation and characterization of alfalfa-nodulating rhizobia present in acidic soils of central Argentina and Uruguay. *Appl. Environ. Microbiol.*, *65*, 1420-1427.
- Dharmatilake, A. J., and Bauer, W. D. (1992). Chemotaxis of *Rhizobium meliloti* towards nodulation gene-inducing compounds from alfalfa roots. *Appl. Environ. Microbiol.*, *58*, 1153-1158.
- Díaz-Mireles, E., Wexler, M., Sawers, G., Bellini, D., Todd, J. D., and Johnston, A. W. B. (2004). The Fur-like protein Mur of *Rhizobium leguminosarum* is a Mn²⁺-responsive transcriptional regulator. *Microbiology*, *150*, 1447-1456.
- Dilworth, M. J., Tiwari, R. P., Reeve, W. G., and Glenn, A. R. (2000). Legume root nodule bacteria and acid pH. *Sci. Prog.*, *83*, 357-389.
- Djordjevic, M. A., Chen, H. C., Natera, S., Van Noorden, G., Menzel, C., Taylor, S., *et al.* (2003). A global analysis of protein expression profiles in *Sinorhizobium meliloti*: Discovery of new genes for nodule occupancy and stress adaptation. *Mol. Plant-Microbe Interact.*, *16*, 508-524.
- Dombrecht, B., Heusdens, C., Beullens, S., Verreth, C., Mulkers, E., Proost, P., *et al.* (2005). Defence of *Rhizobium etli* bacteroids against oxidative stress involves a complexly regulated atypical 2-Cys peroxiredoxin. *Mol. Microbiol.*, *55*, 1207-1221.
- Driscoll, B. T., and Finan, T. M. (1993). NAD⁺-dependent malic enzyme of *Rhizobium meliloti* is required for symbiotic nitrogen fixation. *Mol. Microbiol.*, *7*, 865-873.
- Driscoll, B. T., and Finan, T. M. (1996). NADP⁺-dependent malic enzyme of *Rhizobium meliloti*. *J. Bacteriol.*, *178*, 2224-2231.
- Driscoll, B. T., and Finan, T. M. (1997). Properties of NAD⁺- and NADP⁺-dependent malic enzymes of *Rhizobium (Sinorhizobium) meliloti* and differential expression of their genes in nitrogen-fixing bacteroids. *Microbiology*, *143*, 489-498.
- Duncan, M. J., and Fraenkel, D. G. (1979). α -Ketoglutarate dehydrogenase mutant of *Rhizobium meliloti*. *J. Bacteriol.*, *137*, 415-419.
- Dunn, M. F. (1998). Tricarboxylic acid cycle and anaplerotic enzymes in rhizobia. *FEMS Microbiol. Rev.*, *22*, 105-123.
- Dunn, S. D., and Klucas, R. V. (1973). Studies on possible routes of ammonium assimilation in soybean root nodule bacteroids. *Can. J. Microbiol.*, *19*, 1493-1499.
- Duran, S., and Calderon, J. (1995). Role of the glutamine transaminase- ω -amidase pathway and glutaminase in glutamine degradation in *Rhizobium etli*. *Microbiology*, *141*, 589-595.
- Duran, S., Du Pont, G., Huerta-Zepeda, A., and Calderon, J. (1995). The role of glutaminase in *Rhizobium etli*: Studies with a new mutant. *Microbiology*, *141*, 2883-2889.
- Dymov, S. I., Meek, D. J. J., Steven, B., and Driscoll, B. T. (2004). Insertion of transposon Tn5tac1 in the *Sinorhizobium meliloti* malate dehydrogenase (*mdh*) gene results in conditional polar effects on downstream TCA cycle genes. *Mol. Plant-Microbe Interact.*, *17*, 1318-1327.
- Eggenhofer, E., Haslbeck, M., and Scharf, B. (2004). MotE serves as a new chaperone specific for the periplasmic motility protein, MotC, in *Sinorhizobium meliloti*. *Mol. Microbiol.*, *52*, 701-712.

- Encarnacion, S., Calderon, J., Gelbard, A. S., Cooper, A. J. L., and Mora, J. (1998). Glutamine biosynthesis and the utilization of succinate and glutamine by *Rhizobium etli* and *Sinorhizobium meliloti*. *Microbiology*, *144*, 2629-2638.
- Endley, S., McMurray, D., and Ficht, T. A. (2001). Interruption of the *cydB* locus in *Brucella abortus* attenuates intracellular survival and virulence in the mouse model of infection. *J. Bacteriol.*, *183*, 2454-2462.
- Entcheva, P., Phillips, D. A., and Streit, W. R. (2002). Functional analysis of *Sinorhizobium meliloti* genes involved in biotin synthesis and transport. *Appl. Environ. Microbiol.*, *68*, 2843-2848.
- Fenner, B. J., Tiwari, R. P., Reeve, W. G., Dilworth, M. J., and Glenn, A. R. (2004). *Sinorhizobium medicae* genes whose regulation involves the ActS and/or ActR signal transduction proteins. *FEMS Microbiol. Lett.*, *236*, 21-31.
- Ferguson, G. P., Roop, 2nd, R. M., and Walker, G. C. (2002). Deficiency of a *Sinorhizobium meliloti bacA* mutant in alfalfa symbiosis correlates with alteration of the cell envelope. *J. Bacteriol.*, *184*, 5625-5632.
- Ferguson, G. P., Datta, A., Baumgartner, J., Roop, R. M., Carlson, R. W., and Walker, G. C. (2004). Similarity to peroxisomal-membrane protein family reveals that *Sinorhizobium* and *Brucella* BacA affect lipid-A fatty acids. *Proc. Natl. Acad. Sci. USA*, *101*, 5012-5017.
- Ferraioli, S., Taté, R., Cermola, M., Favre, R., Iaccarino, M., and Patriarca, E. J. (2002). Auxotrophic mutant strains of *Rhizobium etli* reveal new nodule development phenotypes. *Mol. Plant-Microbe Interact.*, *15*, 501-510.
- Fischer, H. M., Babst, M., Kaspar, T., Acuna, G., Arigoni, F., and Hennecke, H. (1993). One member of a *groESL*-like chaperonin multigene family in *Bradyrhizobium japonicum* is co-regulated with symbiotic nitrogen fixation genes. *EMBO J.*, *12*, 2901-2912.
- Fitzmaurice, A. M., and O'Gara, F. (1991). Glutamate catabolism in *Rhizobium meliloti*. *Arch. Microbiol.*, *155*, 422-427.
- Fitzmaurice, A. M., and O'Gara, F. (1993). A *Rhizobium meliloti* mutant, lacking a functional γ -aminobutyrate (GABA) bypass, is defective in glutamate catabolism and symbiotic nitrogen fixation. *FEMS Microbiol. Lett.*, *109*, 195-202.
- Friedman, Y. E., and O'Brian, M. R. (2003). A novel DNA-binding site for the ferric uptake regulator (Fur) protein from *Bradyrhizobium japonicum*. *J. Biol. Chem.*, *278*, 38395-38401.
- Friedman, Y. E., and O'Brian, M. R. (2004). The ferric uptake regulator (Fur) protein from *Bradyrhizobium japonicum* is an iron-responsive transcriptional repressor *in vitro*. *J. Biol. Chem.*, *279*, 32100-32105.
- Fry, J., Wood, M., and Poole, P. S. (2001). Investigation of *myo*-inositol catabolism in *Rhizobium leguminosarum* bv. *viciae* and its effect on nodulation competitiveness. *Mol. Plant-Microbe Interact.*, *14*, 1016-1025.
- Fuhrer, T., Fischer, E., and Sauer, U. (2005). Experimental identification and quantification of glucose metabolism in seven bacterial species. *J. Bacteriol.*, *187*, 1581-1590.
- Gage, D. J. (2002). Analysis of infection thread development using Gfp- and DsRed-expressing *Sinorhizobium meliloti*. *J. Bacteriol.*, *184*, 7042-7046.
- Gage, D. J. (2004). Infection and invasion of roots by symbiotic, nitrogen-fixing rhizobia during nodulation of temperate legumes. *Microbiol. Mol. Biol. Rev.*, *68*, 280-300.
- Gage, D. J., Bobo, T., and Long, S. R. (1996). Use of green fluorescent protein to visualize the early events of symbiosis between *Rhizobium meliloti* and alfalfa (*Medicago sativa*). *J. Bacteriol.*, *178*, 7159-7166.
- Gage, D. J., and Long, S. R. (1998). α -Galactoside uptake in *Rhizobium meliloti*: Isolation and characterization of *agpA*, a gene encoding a periplasmic binding protein required for melibiose and raffinose utilization. *J. Bacteriol.*, *180*, 5739-5748.
- Gage, D. J., and Margolin, W. (2000). Hanging by a thread: Invasion of legume plants by rhizobia. *Curr. Opin. Microbiol.*, *3*, 613-617.
- Galbraith, M. P., Feng, S. F., Borneman, J., Triplett, E. W., de Bruijn, F. J., and Rossbach, S. (1998). A functional *myo*-inositol catabolism pathway is essential for rhizopine utilization by *Sinorhizobium meliloti*. *Microbiology*, *144*, 2915-2924.
- Galibert, F., Finan, T. M., Long, S. R., Pühler, A., Abola, P., Ampe, F., et al. (2001). The composite genome of the legume symbiont *Sinorhizobium meliloti*. *Science*, *293*, 668-672.

- Geiger, O., Röhrs, V., Weissenmayer, B., Finan, T. M., and Thomas-Oates, J. E. (1999). The regulator gene *phoB* mediates phosphate stress-controlled synthesis of the membrane lipid diacylglyceryl-*N,N,N*-trimethylhomoserine in *Rhizobium* (*Sinorhizobium*) *meliloti*. *Mol. Microbiol.*, *32*, 63-73.
- Giraud, E., Hannibal, L., Fardoux, J., Verméglio, A., and Dreyfus, B. (2000). Effect of *Bradyrhizobium* photosynthesis on stem nodulation of *Aeschynomene sensitiva*. *Proc. Natl. Acad. Sci. USA*, *97*, 14795-14800.
- Giraud, E., and Fleischman, D. (2004). Nitrogen-fixing symbiosis between photosynthetic bacteria and legumes. *Photosynth. Res.*, *82*, 115-130.
- Glenn, A. R., and Dilworth, M. J. (1981). The uptake and hydrolysis of disaccharides by fast- and slow-growing species of *Rhizobium*. *Arch. Microbiol.*, *129*, 233-239.
- Glenn, A. R., McKay, I. A., Arwas, R., and Dilworth, M. J. (1984). Sugar metabolism and the symbiotic properties of carbohydrate mutants of *Rhizobium leguminosarum*. *J. Gen. Microbiol.*, *130*, 239-245.
- Glenn, A. R., Reeve, W. G., Tiwari, R. P., and Dilworth, M. J. (1999). Acid tolerance in root nodule bacteria. *Novartis Found. Symp.*, *221*, 112-126.
- Goldmann, A., Boivin, C., Fleury, V., Message, B., Lecoœur, L., Maille, M., and Tepfer, D. (1991). Betaine use by rhizosphere bacteria - genes essential for trigonelline, stachydrine, and carnitine catabolism in *Rhizobium meliloti* are located on pSym in the symbiotic region. *Mol. Plant-Microbe Interact.*, *4*, 571-578.
- González, J. E., and Marketon, M. M. (2003). Quorum sensing in nitrogen-fixing rhizobia. *Microbiol. Mol. Biol. Rev.*, *67*, 574-592.
- Gordon, D. M., Ryder, M. H., Heinrich, K., and Murphy, P. J. (1996). An experimental test of the rhizopine concept in *Rhizobium meliloti*. *Appl. Environ. Microbiol.*, *62*, 3991-3996.
- Gotz, R., Limmer, N., Ober, K., and Schmitt, R. (1982). Motility and chemotaxis in 2 strains of *Rhizobium* with complex flagella. *J. Gen. Microbiol.*, *128*, 789-798.
- Gotz, R., and Schmitt, R. (1987). *Rhizobium meliloti* swims by unidirectional, intermittent rotation of right-handed flagellar helices. *J. Bacteriol.*, *169*, 3146-3150.
- Gouffi, K., Pichereau, V., Rolland, J. P., Thomas, D., Bernard, T., and Blanco, C. (1998). Sucrose is a nonaccumulated osmoprotectant in *Sinorhizobium meliloti*. *J. Bacteriol.*, *180*, 5044-5051.
- Gouffi, K., Pica, N., Pichereau, V., and Blanco, C. (1999). Disaccharides as a new class of nonaccumulated osmoprotectants for *Sinorhizobium meliloti*. *Appl. Environ. Microbiol.*, *65*, 1491-1500.
- Graham, P. H., and Parker, C. A. (1964). Diagnostic features in the characterisation of the root-nodule bacteria of legumes. *Plant Soil*, *20*, 383-396.
- Graham, P. H., Draeger, K. J., Ferrey, M. L., Conroy, M. J., Hammer, B. E., et al. (1994). Acid pH tolerance in strains of *Rhizobium* and *Bradyrhizobium*, and initial studies on the basis for acid tolerance of *Rhizobium tropici* UMR1899. *Can. J. Microbiol.*, *40*, 198-207.
- Gray, K. M., Pearson, J. P., Downie, J. A., Boboye, B. E., and Greenberg, E. P. (1996). Cell-to-cell signaling in the symbiotic nitrogen-fixing bacterium *Rhizobium leguminosarum* - autoinduction of a stationary-phase and rhizosphere-expressed genes. *J. Bacteriol.*, *178*, 372-376.
- Green, L. S., and Emerich, D. W. (1997a). The formation of nitrogen-fixing bacteroids is delayed but not abolished in soybean infected by an alpha-ketoglutarate dehydrogenase-deficient mutant of *Bradyrhizobium japonicum*. *Plant Physiol.*, *114*, 1359-1368.
- Green, L. S., and Emerich, D. W. (1997b). *Bradyrhizobium japonicum* does not require alpha-ketoglutarate dehydrogenase for growth on succinate or malate. *J. Bacteriol.*, *179*, 194-201.
- Green, L. S., and Emerich, D. W. (1999). Light microscopy of early stages in the symbiosis of soybean with a delayed-nodulation mutant of *Bradyrhizobium japonicum*. *J. Exp. Bot.*, *50*, 1577-1585.
- Green, L. S., Li, Y. Z., Emerich, D. W., Bergersen, F. J., and Day, D. A. (2000). Catabolism of α -ketoglutarate by a *sucA* mutant of *Bradyrhizobium japonicum*: Evidence for an alternative tricarboxylic acid cycle. *J. Bacteriol.*, *182*, 2838-2844.
- Green, L. S., Waters, J. K., Ko, S., and Emerich, D. W. (2003). Comparative analysis of the *Bradyrhizobium japonicum sucA* region. *Can. J. Microbiol.*, *49*, 237-243.
- Gulash, M., Ames, P., Larosiliere, R. C., and Bergman, K. (1984). Rhizobia are attracted to localized sites on legume roots. *Appl. Environ. Microbiol.*, *48*, 149-152.
- Guntli, D., Heeb, M., Moëgne-Loccoz, Y., and Défago, G. (1999). Contribution of calystegine catabolic plasmid to competitive colonization of the rhizosphere of calystegine-producing plants by *Sinorhizobium meliloti* Rm41. *Mol. Ecol.*, *8*, 855-863.

- Hamza, I., Chauhan, S., Hassett, R., and O'Brian, M. R. (1998). The bacterial Irr protein is required for coordination of heme biosynthesis with iron availability. *J. Biol. Chem.*, *273*, 21669-21674.
- Hamza, I., Hassett, R., and O'Brian, M. R. (1999). Identification of a functional *fur* gene in *Bradyrhizobium japonicum*. *J. Bacteriol.*, *181*, 5843-5846.
- Hamza, I., Qi, Z. H., King, N. D., and O'Brian, M. R. (2000). Fur-independent regulation of iron metabolism by Irr in *Bradyrhizobium japonicum*. *Microbiology*, *146*, 669-676.
- Hauwaerts, D., Alexandre, G., Das, S. K., Vanderleyden, J., and Zhulin, I. B. (2002). A major chemotaxis gene cluster in *Azospirillum brasilense* and relationships between chemotaxis operons in alpha-proteobacteria. *FEMS Microbiol. Lett.*, *208*, 61-67.
- He, X. S., Chang, W., Pierce, D. L., Seib, L. O., Wagner, J., and Fuqua, C. (2003). Quorum sensing in *Rhizobium* sp strain NGR234 regulates conjugal transfer (*tra*) gene expression and influences growth rate. *J. Bacteriol.*, *185*, 809-822.
- Heinrich, K., Gordon, D. M., Ryder, M. H., and Murphy, P. J. (1999). A rhizopine strain of *Sinorhizobium meliloti* remains at a competitive nodulation advantage after an extended period in the soil. *Soil Biol. Biochem.*, *31*, 1063-1065.
- Heinrich, K., Ryder, M. H., and Murphy, P. J. (2001). Early production of rhizopine in nodules induced by *Sinorhizobium meliloti* strain L5-30. *Can. J. Microbiol.*, *47*, 165-171.
- Hernandez-Lucas, I., Pardo, M. A., Segovia, L., Miranda, J., and Martinez-Romero, E. (1995). *Rhizobium tropici* chromosomal citrate synthase gene. *Appl. Environ. Microbiol.*, *61*, 3992-3997.
- Herrada, G., Puppo, A., and Rigaud, J. (1989). Uptake of metabolites by bacteroid-containing vesicles and by free bacteroids from french bean nodules. *J. Gen. Microbiol.*, *135*, 3165-3177.
- Hirsch, P. R. (1979). Plasmid-determined bacteriocin production by *Rhizobium leguminosarum*. *J. Gen. Microbiol.*, *113*, 219-228.
- Hoang, H. H., Becker, A., and Gonzalez, J. E. (2004). The LuxR homolog ExpR, in combination with the *sin* quorum sensing system, plays a central role in *Sinorhizobium meliloti* gene expression. *J. Bacteriol.*, *186*, 5460-5472.
- Hoelzle, I., and Streeter, J. G. (1989). Higher trehalose accumulation in rhizobia under salt stress. *Plant Physiol.*, *89*, 118.
- Hosie, A. H. F., Allaway, D., Jones, M. A., Walshaw, D. L., Johnston, A.W. B., and Poole, P. S. (2001). Solute-binding protein-dependent ABC transporters are responsible for solute efflux in addition to solute uptake. *Mol. Microbiol.*, *40*, 1449-1459.
- Hosie, A. H. F., Allaway, D., and Poole, P. S. (2002). A monocarboxylate permease of *Rhizobium leguminosarum* is the first member of a new subfamily of transporters. *J. Bacteriol.*, *184*, 5436-5448.
- Howieson, J. G., and Ewing, M. A. (1986). Acid-tolerance in the *Rhizobium meliloti*-*Medicago* symbiosis. *Aust. J. Agric. Res.*, *37*, 55-64.
- Howieson, J. G., Ewing, M. A., and D'Antuono, M. F. (1988). Selection for acid-tolerance in *Rhizobium meliloti*. *Plant Soil*, *105*, 179-188.
- Howieson, J. G., Robson, A. D., and Abbott, L. K. (1992). Calcium modifies pH effects on the growth of acid-tolerant and acid-sensitive *Rhizobium meliloti*. *Aust. J. Agric. Res.*, *43*, 765-772.
- Howorth, S. M., and England, R. R. (1999). Accumulation of ppGpp in symbiotic and free-living nitrogen-fixing bacteria following amino acid starvation. *Arch. Microbiol.*, *171*, 131-134.
- Hynes, M. F., and McGregor, N. F. (1990). Two plasmids other than the nodulation plasmid are necessary for formation of nitrogen-fixing nodules by *Rhizobium leguminosarum*. *Mol. Microbiol.*, *4*, 567-574.
- Hynes, M. F., and O'Connell, M. P. (1990). Host plant effect on competition among strains of *Rhizobium leguminosarum*. *Can. J. Microbiol.*, *36*, 864-869.
- Ielpi, L., Dylan, T., Ditta, G. S., Helinski, D. R., and Stanfield, S. W. (1990). The *ndvB* locus of *Rhizobium meliloti* encodes a 319-kDa protein involved in the production of beta-(1,2)-glucan. *J. Biol. Chem.*, *265*, 2843-2851.
- Jamet, A., Sigaud, S., Van de Sype, G., Puppo, A., and Hérouart, D. (2003). Expression of the bacterial catalase genes during *Sinorhizobium meliloti*-*Medicago sativa* symbiosis and their crucial role during the infection process. *Mol. Plant-Microbe Interact.*, *16*, 217-225.
- Jamet, A., Kiss, E., Batut, J., Puppo, A., and Hérouart, D. (2005). The *katA* catalase gene is regulated by OxyR in both free-living and symbiotic *Sinorhizobium meliloti*. *J. Bacteriol.*, *187*, 376-381.

- Jelesko, J. G., and Leigh, J. A. (1994). Genetic characterisation of a *Rhizobium meliloti* lactose utilization locus. *Mol. Microbiol.*, *11*, 165-173.
- Jensen, J. B., Peters, N. K., and Bhuvanewari, T. V. (2002). Redundancy in periplasmic binding protein-dependent transport systems for trehalose, sucrose, and maltose in *Sinorhizobium meliloti*. *J. Bacteriol.*, *184*, 2978-2986.
- Jiang, G. Q., Krishnan, A. H., Kim, Y. W., Wacek, T. J., and Krishnan, H. B. (2001). A functional myo-inositol dehydrogenase gene is required for efficient nitrogen fixation and competitiveness of *Sinorhizobium fredii* USDA191 to nodulate soybean (*Glycine max* [L.] Merr.). *J. Bacteriol.*, *183*, 2595-2604.
- Jiang, J. Q., Wei, W., Du, B. H., Li, X. H., Wang, L., and Yang, S. S. (2004). Salt-tolerance genes involved in cation efflux and osmoregulation of *Sinorhizobium fredii* RT19 detected by isolation and characterization of Tn5 mutants. *FEMS Microbiol. Lett.*, *239*, 139-146.
- Jiménez-Zurdo, J. I., Van Dillewijn, P., Soto, M. J., de Felipe, M. R., Olivares, J., and Toro, N. (1995). Characterization of a *Rhizobium meliloti* proline dehydrogenase mutant altered in nodulation efficiency and competitiveness on alfalfa roots. *Mol. Plant-Microbe Interact.*, *8*, 492-498.
- Jiménez-Zurdo, J. I., Garcia-Rodríguez, F. M., and Toro, N. (1997). The *Rhizobium meliloti* *putA* gene: Its role in the establishment of the symbiotic interaction with alfalfa. *Mol. Microbiol.*, *23*, 85-93.
- Jin, H. N., Dilworth, M. J., and Glenn, A. R. (1990). 4-Aminobutyrate is not available to bacteroids of cowpea *Rhizobium* MNF2030 in snake bean nodules. *Arch. Microbiol.*, *153*, 455-462.
- Johnston, A. W. B., Yeoman, K. H., and Wexler, M. (2001). Metals and the rhizobial-legume symbiosis - Uptake, utilization and signalling. *Adv. Microb. Physiol.*, *45*, 113-156.
- Johnston, A. W. B. (2004). Mechanisms and regulation of iron uptake in the rhizobia. In J. H. Crossa, A. R. Mey, and S. M. Payne (Eds.), *Iron transport in bacteria: Molecular genetics, biochemistry, microbial pathogenesis and ecology*. (pp. 469-488). Washington, D.C.: ASM Press.
- Jordan, D. C. (1984). Family III *Rhizobiaceae*. In N. R. Kreig and J. G. Holt (Eds.), *Bergey's manual of systematic bacteriology*. (pp. 234-244). Baltimore, MD: Williams and Wilkins.
- Jording, D., and Pühler, A. (1993). The membrane topology of the *Rhizobium meliloti* C₄-dicarboxylate permease (DctA) as derived from protein fusions with *Escherichia coli* K12 alkaline-phosphatase (PhoA) and beta-galactosidase (LacZ). *Mol. Gen. Genet.*, *241*, 106-114.
- Kaiser, B. N., Moreau, S., Castelli, J., Thomson, R., Lambert, A., Bogliolo, S., et al. (2003). The soybean NRAMP homologue, GmDMT1, is a symbiotic divalent metal transporter capable of ferrous iron transport. *Plant J.*, *35*, 295-304.
- Kaneko, T., Nakamura, Y., Sato, S., Asamizu, E., Kato, T., Sasamoto, S., et al. (2000). Complete genome structure of the nitrogen-fixing symbiotic bacterium *Mesorhizobium loti*. *DNA Res.*, *7*, 331-338.
- Kaneko, T., Nakamura, Y., Sato, S., Minimisawa, K., Uchiyama, T., Sasamoto, S., et al. (2002). Complete genomic sequence of nitrogen-fixing symbiotic bacterium *Bradyrhizobium japonicum* USDA110. *DNA Res.*, *9*, 189-197.
- Kazakova, O. V., Tsuprun, V. L., Ivanushkin, A. G., Kaftanova, A. S., Pushkin, A. V., and Kretovich, V. L. (1988). Quaternary structure and kinetic characteristics of alanine dehydrogenase from *Rhizobium lupini* bacteroids. *Dokl. Akad. Nauk SSSR* (English translation), *300*, 131-134.
- Kennedy, E. P. (1996). Membrane-derived oligosaccharides (periplasmic beta-D-glucans) of *Escherichia coli*. In F. C. Neidhardt (Ed.), *Escherichia coli and Salmonella cellular and molecular biology*. (pp. 1064-1071). Washington, D.C.: American Society for Microbiology Press.
- Kim, Y. S. (2002). Malonate metabolism: Biochemistry, molecular biology, physiology, and industrial application. *J. Biochem. Mol. Biol.*, *35*, 443-451.
- Kimura, I., and Tajima, S. (1989). Presence and characteristics of NADP-malic enzyme in soybean nodule bacteroids. *Soil Sci. Plant Nutr.*, *35*, 271-280.
- Kiss, E., Hugué, T., Poinso, V., and Batut, J. (2004). The *typA* gene is required for stress adaptation as well as for symbiosis of *Sinorhizobium meliloti* 1021 with certain *Medicago truncatula* lines. *Mol. Plant-Microbe Interact.*, *17*, 235-244.
- Kleiner, D., and Phillips, S. (1981). Relative levels of guanosine 5'-diphosphate 3'-diphosphate (ppGpp) in some N₂ fixing bacteria during derepression and repression of nitrogenase. *Arch. Microbiol.*, *128*, 341-342.
- Knee, E. M., Gong, F. C., Gao, M. S., Teplitski, M., Jones, A. R., et al. (2001). Root mucilage from pea and its utilization by rhizosphere bacteria as a sole carbon source. *Mol. Plant-Microbe Interact.*, *14*, 775-784.

- Kouchi, H., Fukai, K., and Kihara, A. (1991). Metabolism of glutamate and aspartate in bacteroids isolated from soybean root nodules. *J. Gen. Microbiol.*, *137*, 2901-2910.
- Lambein, F., Khan, J. K., Kuo, Y. H., Campbell, C. G., and Briggs, C. J. (1993). Toxins in the seedlings of some varieties of grass pea. *Nat. Toxins*, *1*, 246-249.
- Lambert, A., Østerås, M., Mandon, K., Poggi, M. C., and Le Rudulier, D. (2001). Fructose uptake in *Sinorhizobium meliloti* is mediated by a high-affinity ATP-binding cassette transport system. *J. Bacteriol.*, *183*, 4709-4717.
- Latch, J. N., and Margolin, W. (1997). Generation of buds, swellings, and branches instead of filaments after blocking the cell cycle of *Rhizobium meliloti*. *J. Bacteriol.*, *179*, 2373-2381.
- Leigh, J. A., and Walker, G. C. (1994). Exopolysaccharides of *Rhizobium* - synthesis, regulation and symbiotic function. *Trends Genet.*, *10*, 63-67.
- LeVier, K., and Guerinot, M. L. (1996). The *Bradyrhizobium japonicum fegA* gene encodes an iron-regulated outer-membrane protein with similarity to hydroxamate-type siderophore receptors. *J. Bacteriol.*, *178*, 7265-7275.
- Lithgow, J. K., Wilkinson, A., Hardman, A., Rodelas, B., Wisniewski-Dyé, F., et al. (2000). The regulatory locus *cinRI* in *Rhizobium leguminosarum* controls a network of quorum-sensing loci. *Mol. Microbiol.*, *37*, 81-97.
- Lloret, J., Wulff, B. B. H., Rubio, J. M., Downie, J. A., Bonilla, I., and Rivilla, R. (1998). Exopolysaccharide II production is regulated by salt in the halotolerant strain *Rhizobium meliloti* EFB1. *Appl. Environ. Microbiol.*, *64*, 1024-1028.
- Lodwig, E., and Poole, P. S. (2003). Metabolism of *Rhizobium* bacteroids. *Crit. Rev. Plant Sci.*, *22*, 37-78.
- Lodwig, E., Kumar, S., Allaway, D., Bourdès, A., Prell, J., et al. (2004). Regulation of L-alanine dehydrogenase in *Rhizobium leguminosarum* bv. *viciae* and its role in pea nodules. *J. Bacteriol.*, *186*, 842-849.
- Lodwig, E. M., Hosie, A. H. F., Bourdès, A., Findlay, K., Allaway, D., et al. (2003). Amino-acid cycling drives nitrogen fixation in the legume-*Rhizobium* symbiosis. *Nature*, *422*, 722-726.
- Lodwig, E. M., Leonard, M., Marroquí, S., Wheeler, T. R., Findlay, K., et al. (2005). Role of polyhydroxybutyrate and glycogen as carbon storage compounds in pea and bean bacteroids. *Mol. Plant-Microbe Interact.*, *18*, 67-74.
- Loh, J., Carlson, R. W., York, W. S., and Stacey, G. (2002). Bradyoxetin, a unique chemical signal involved in symbiotic gene regulation. *Proc. Natl. Acad. Sci. USA*, *99*, 14446-14451.
- Mandon, K., Michel-Reydellet, N., Encarnación, S., Kaminski, P. A., Leija, A., et al. (1998). Poly- β -hydroxybutyrate turnover in *Azorhizobium caulinodans* is required for growth and affects *nifA* expression. *J. Bacteriol.*, *180*, 5070-5076.
- Marketon, M. M., and Gonzalez, J. E. (2002). Identification of two quorum-sensing systems in *Sinorhizobium meliloti*. *J. Bacteriol.*, *184*, 3466-3475.
- Marketon, M. M., Gronquist, M. R., Eberhard, A., and González, J. E. (2002). Characterization of the *Sinorhizobium meliloti sinR/sinI* locus and the production of novel N-acyl homoserine lactones. *J. Bacteriol.*, *184*, 5686-5695.
- Marketon, M. M., Glenn, S. A., Eberhard, A., and González, J. E. (2003). Quorum sensing controls exopolysaccharide production in *Sinorhizobium meliloti*. *J. Bacteriol.*, *185*, 325-331.
- Marroquí, S., Zorreguieta, A., Santamaría, C., Temprano, F., Soberón, M., et al. (2001). Enhanced symbiotic performance by *Rhizobium tropici* glycogen synthase mutants. *J. Bacteriol.*, *183*, 854-864.
- Marsudi, N. D. S., Glenn, A. R., and Dilworth, M. J. (1999). Identification and characterization of fast- and slow-growing root nodule bacteria from South-Western Australian soils able to nodulate *Acacia saligna*. *Soil Biol. Biochem.*, *31*, 1229-1238.
- McDermott, T. R., and Kahn, M. L. (1992). Cloning and mutagenesis of the *Rhizobium meliloti* isocitrate dehydrogenase gene. *J. Bacteriol.*, *174*, 4790-4797.
- McKay, I. A., Glenn, A. R., and Dilworth, M. J. (1985). Gluconeogenesis in *Rhizobium leguminosarum* MNF3841. *J. Gen. Microbiol.*, *131*, 2067-2073.
- McKay, I. A., Dilworth, M. J., and Glenn, A. R. (1989). Carbon catabolism in continuous cultures and bacteroids of *Rhizobium leguminosarum* MNF3841. *Arch. Microbiol.*, *152*, 606-610.
- McNab, R. (2003). How bacteria assemble flagella. *Annu. Rev. Microbiol.*, *57*, 77-100.

- McRae, D. G., Miller, R. W., and Berndt, W. B. (1989). Viability of alfalfa nodule bacteroids isolated by density gradient centrifugation. *Symbiosis* 7, 67-80.
- Milcamps, A., Ragatz, D. M., Lim, P., Berger, K. A., and de Bruijn, F. J. (1998). Isolation of carbon- and nitrogen-deprivation-induced loci of *Sinorhizobium meliloti* 1021 by Tn5-*luxAB* mutagenesis. *Microbiology*, 144, 3205-3218.
- Milcamps, A., and de Bruijn, F. J. (1999). Identification of a novel nutrient-deprivation-induced *Sinorhizobium meliloti* gene (*hmgA*) involved in the degradation of tyrosine. *Microbiology*, 145, 935-947.
- Milcamps, A., Struffi, P., and de Bruijn, F. J. (2001). The *Sinorhizobium meliloti* nutrient-deprivation-induced tyrosine degradation gene *hmgA* is controlled by a novel member of the *arsR* family of regulatory genes. *Appl. Environ. Microbiol.*, 67, 2641-2648.
- Miller, K. J., Kennedy, E. P., and Reinhold, V. N. (1986). Osmotic adaptation by gram-negative bacteria: possible role for periplasmic oligosaccharides. *Science*, 231, 48-51.
- Miller, K. J., and Wood, J. M. (1996). Osmoadaptation by rhizosphere bacteria. *Annu. Rev. Microbiol.*, 50, 101-136.
- Miller, R. W., McRae, D. G., and Joy, K. (1991). Glutamate and gamma-aminobutyrate metabolism in isolated *Rhizobium meliloti* bacteroids. *Mol. Plant-Microbe Interact.*, 4, 37-45.
- Miranda-Rios, J., Morera, C., Taboada, H., Dávalos, A., Encarnación, S., et al. (1997). Expression of thiamin biosynthetic genes (*thiCOGE*) and production of symbiotic terminal oxidase *cbb3* in *Rhizobium etli*. *J. Bacteriol.*, 179, 6887-6893.
- Miranda-Rios, J., Navarro, M., and Soberón, M. (2001). A conserved RNA structure (*thi* box) is involved in regulation of thiamin biosynthetic gene expression in bacteria. *Proc. Natl. Acad. Sci. USA*, 98, 9736-9741.
- Mitsch, M. J., Voegelé, R. T., Cowie, A., Osteras, M., and Finan, T. M. (1998). Chimeric structure of the NAD(P)⁺- and NADP⁺-dependent malic enzymes of *Rhizobium (Sinorhizobium) meliloti*. *J. Biol. Chem.*, 273, 9330-9336.
- Moënné-Loccoz, Y., Baldani, J. I., and Weaver, R. W. (1995). Sequential heat-curing of Tn5-*mob-sac* labeled plasmids from *Rhizobium* to obtain derivatives with various combinations of plasmids and no plasmid. *Lett. Appl. Microbiol.*, 20, 175-179.
- Munns, D. N. (1986). Acid soil tolerance in legumes and rhizobia. In B. Tinker and A. Lauchli (Eds.), *Advances in plant nutrition*. (pp. 63-91). New York, NY: Praeger Scientific.
- Murphy, P. J., Heyck, N., Trenz, S. P., Ratet, P., de Bruijn, F., and Schell, J. (1988). Synthesis of an opine-like compound, a rhizopine, in alfalfa nodules is symbiotically regulated. *Proc. Natl. Acad. Sci. USA*, 85, 9133-9137.
- Murphy, P. J., Wexler, W., Grzemski, W., Rao, J. P., and Gordon, D. (1995). Rhizopines - their role in symbiosis and competition. *Soil Biol. Biochem.*, 27, 525-529.
- Newton, J. A., and Fray, R. G. (2004). Integration of environmental and host-derived signals with quorum sensing during plant-microbe interactions. *Cell Microbiol.*, 6, 213-224.
- Nienaber, A., Hennecke, H., and Fischer, H. M. (2001). Discovery of a haem uptake system in the soil bacterium *Bradyrhizobium japonicum*. *Mol. Microbiol.*, 41, 787-800.
- Nogales, J., Campos, R., Ben Abdelkhalek, H., Olivares, J., Lluch, C., and Sanjuan, J. (2002). *Rhizobium tropici* genes involved in free-living salt tolerance are required for the establishment of efficient nitrogen-fixing symbiosis with *Phaseolus vulgaris*. *Mol. Plant-Microbe Interact.*, 15, 225-232.
- O'Gara, F., Manian, S., and Meade, J. (1984). Isolation of an Asm⁻ mutant of *Rhizobium japonicum* defective in N₂ fixation. *FEMS Microbiol. Lett.*, 24, 241-245.
- O'Hara, G. W., and Glenn, A. R. (1994). The adaptive acid tolerance response in root-nodule bacteria and *Escherichia coli*. *Arch. Microbiol.*, 161, 286-292.
- Ohwada, T., Shirakawa, Y., Kusumoto, M., Masuda, H., and Sato, T. (1999). Susceptibility to hydrogen peroxide and catalase activity of root nodule bacteria. *Biosci. Biotechnol. Biochem.*, 63, 457-462.
- Oke, V., and Long, S. R. (1999). Bacterial genes induced within the nodule during the *Rhizobium*-legume symbiosis. *Mol. Microbiol.*, 32, 837-849.
- Olson, J. W., and Maier, R. J. (2000). Dual roles of *Bradyrhizobium japonicum* nickel protein in nickel storage and GTP-dependent Ni mobilization. *J. Bacteriol.*, 182, 1702-1705.
- Oresnik, I. J., Pacarynuk, L. A., O'Brien, S. A. P., Yost, C. K., and Hynes, M. F. (1998). Plasmid-encoded catabolic genes in *Rhizobium leguminosarum* bv. *trifolii*: Evidence for a plant-inducible rhamnose locus involved in competition for nodulation. *Mol. Plant-Microbe Interact.*, 11, 1175-1185.

- Oresnik, I. J., Liu, S. L., Yost, C. K., and Hynes, M. F. (2000). Megaplasmid pRme2011a of *Sinorhizobium meliloti* is not required for viability. *J. Bacteriol.*, *182*, 3582-3586.
- Osteras, M., Finan, T. M., and Stanley, J. (1991). Site-directed mutagenesis and DNA sequence of *pckA* of *Rhizobium* NGR234, encoding phosphoenolpyruvate carboxykinase - gluconeogenesis and host-dependent symbiotic phenotype. *Mol. Gen. Genet.*, *230*, 257-269.
- Osteras, M., Driscoll, B. T., and Finan, T. M. (1995). Molecular and expression analysis of the *Rhizobium meliloti* phosphoenolpyruvate carboxykinase (*pckA*) gene. *J. Bacteriol.*, *177*, 1452-1460.
- Pardo, M. A., Lagunez, J., Miranda, J., and Martinez, E. (1994). Nodulating ability of *Rhizobium tropici* is conditioned by a plasmid-encoded citrate synthase. *Mol. Microbiol.*, *11*, 315-321.
- Parke, D., Rivelli, M., and Ornston, L. N. (1985). Chemotaxis to aromatic and hydroaromatic acids - comparison of *Bradyrhizobium japonicum* and *Rhizobium trifolii*. *J. Bacteriol.*, *163*, 417-422.
- Patriarca, E. J., Tate, R., and Iaccarino, M. (2002). Key role of bacterial NH₄⁺ metabolism in *Rhizobium*-plant symbiosis. *Microbiol. Mol. Biol. Rev.*, *66*, 203-222.
- Pellock, B. J., Teplitski, M., Boinay, R. P., Bauer, W. D., and Walker, G. C. (2002). A LuxR homolog controls production of symbiotically active extracellular polysaccharide II by *Sinorhizobium meliloti*. *J. Bacteriol.*, *184*, 5067-5076.
- Pfeffer, P. E., Becard, G., Rolin, D. B., Uknalis, J., Cooke, P., and Tu, S. (1994). In vivo nuclear magnetic resonance study of the osmoregulation of phosphocholine-substituted beta-1,3;1,6 cyclic glucan and its associated carbon metabolism in *Bradyrhizobium japonicum* USDA 110. *Appl. Environ. Microbiol.*, *60*, 2137-2146.
- Phillips, D. A., Sande, E. S., Vriezen, J. A. C., de Bruijn, F. J., Le Rudulier, D., and Joseph, C. M. (1998). A new genetic locus in *Sinorhizobium meliloti* is involved in stachydrine utilization. *Appl. Environ. Microbiol.*, *64*, 3954-3960.
- Platero, R., Peixoto, L., O'Brian, M. R., and Fabiano, E. (2004). Fur is involved in manganese-dependent regulation of *mntA* (*sitA*) expression in *Sinorhizobium meliloti*. *Appl. Environ. Microbiol.*, *70*, 4349-4355.
- Polcyn, W., Lucinski, R., Tom-Petersen, A., Leser, T. D., Marsh, T. L., and Nybroe, O. (2003). Aerobic and anaerobic nitrate and nitrite reduction in free-living cells of *Bradyrhizobium* sp. (*Lupinus*). *FEMS Microbiol. Evol.*, *46*, 53-62.
- Poole, P. S., Dilworth, M. J., and Glenn, A. R. (1984). Acquisition of aspartase activity in *Rhizobium leguminosarum* WU235. *J. Gen. Microbiol.*, *130*, 881-886.
- Poole, P. S., Franklin, M., Glenn, A. R., and Dilworth, M. J. (1985). The transport of L-glutamate by *Rhizobium leguminosarum* involves a common amino acid carrier. *J. Gen. Microbiol.*, *131*, 1441-1448.
- Poole, P. S., Blyth, A., Reid, C. J., and Walters, K. (1994). *myo*-Inositol catabolism and catabolite regulation in *Rhizobium leguminosarum* bv *viciae*. *Microbiology*, *140*, 2787-2795.
- Poole, P. S., Reid, C., East, A. K., Allaway, D., Day, M., and Leonard, M. (1999). Regulation of the *mdh-sucCDAB* operon in *Rhizobium leguminosarum*. *FEMS Microbiol. Lett.*, *176*, 247-255.
- Poole, P. S., and Allaway, D. A. (2000). Carbon and nitrogen metabolism in *Rhizobium*. *Adv. Microb. Physiol.*, *43*, 117-163.
- Povolo, S., Tombolini, R., Morea, A., Anderson, A. J., Casella, S., and Nuti, M. P. (1994). Isolation and characterization of mutants of *Rhizobium meliloti* unable to synthesize poly-β-hydroxybutyrate. *Can. J. Microbiol.*, *40*, 823-829.
- Povolo, S., and Casella, S. (2000). A critical role for *aniA* in energy-carbon flux and symbiotic nitrogen fixation in *Sinorhizobium meliloti*. *Arch. Microbiol.*, *174*, 42-49.
- Prell, J., Boesten, B., Poole, P. S., and Priefer, U. B. (2002). The *Rhizobium leguminosarum* bv. *viciae* VF39 γ-aminobutyrate (GABA) aminotransferase gene (*gabT*) is induced by GABA and highly expressed in bacteroids. *Microbiology*, *148*, 615-623.
- Priefer, U. B., Aurag, J., Boesten, B., Bouhmouch, I., Defez, R., Filali-Maltouf, A., et al. (2001). Characterisation of *Phaseolus* symbionts isolated from Mediterranean soils and analysis of genetic factors related to pH tolerance. *J. Biotechnol.*, *91*, 223-236.
- Primm, T. P., Andersen, S. J., Mizrahi, V., Avarbock, D., Rubin, H., and Barry, III, C. E. (2000). The stringent response of *Mycobacterium tuberculosis* is required for long-term survival. *J. Bacteriol.*, *182*, 4889-4898.
- Primrose, S. B., and Ronson, C. W. (1980). Polyol metabolism by *Rhizobium trifolii*. *J. Bacteriol.*, *141*, 1109-1114.

- Putnoky, P., Kereszt, A., Nakamura, T., Endre, G., Grosskopf, E., *et al.* (1998). The *pha* gene cluster of *Rhizobium meliloti* involved in pH adaptation and symbiosis encodes a novel type of K⁺ efflux system. *Mol. Microbiol.*, *28*, 1091-1101.
- Qi, Z. H., and O'Brian, M. R. (2002). Interaction between the bacterial iron response regulator and ferrochelatase mediates genetic control of heme biosynthesis. *Mol. Cell*, *9*, 155-162.
- Rao, J. R., and Cooper, J. E. (1994). Rhizobia catabolize *nod* gene-inducing flavonoids via C-ring fission mechanisms. *J. Bacteriol.*, *176*, 5409-5413.
- Rao, J. R., and Cooper, J. E. (1995). Soybean nodulating rhizobia modify *nod* gene inducers daidzein and genistein to yield aromatic products that can influence gene-inducing activity. *Mol. Plant-Microbe Interact.*, *8*, 855-862.
- Rao, J. R., Cooper, J. E., Everaert, E. S. W., and DeCooman, L. (1996). Assimilation of *nod* gene inducer C-14-naringenin and the incorporation of labelled carbon atoms into the acyl side chain of a host-specific nod factor produced by *Rhizobium leguminosarum* bv *viciae*. *Plant Soil*, *186*, 63-67.
- Rastogi, V. K., and Watson, R. J. (1991). Aspartate aminotransferase activity is required for aspartate catabolism and symbiotic nitrogen fixation in *Rhizobium meliloti*. *J. Bacteriol.*, *173*, 2879-2887.
- Reeve, W. G., Tiwari, R. P., Dilworth, M. J., and Glenn, A. R. (1993). Calcium affects the growth and survival of *Rhizobium meliloti*. *Soil Biol. Biochem.*, *25*, 581-586.
- Reeve, W. G., Dilworth, M. J., Tiwari, R. P., and Glenn, A. R. (1997). Regulation of exopolysaccharide production in *Rhizobium leguminosarum* biovar *viciae* WSM710 involves *exoR*. *Microbiology*, *143*, 1951-1958.
- Reeve, W. G., Tiwari, R. P., Wong, C. M., Dilworth, M. J., and Glenn, A. R. (1998). The transcriptional regulator gene *phrR* in *Sinorhizobium meliloti* WSM419 is regulated by low pH and other stresses. *Microbiology*, *144*, 3335-3342.
- Reeve, W. G., Tiwari, R. P., Worsley, P. S., Dilworth, M. J., Glenn, A. R., and Howieson, J. G. (1999). Constructs for insertional mutagenesis, transcriptional signal localization and gene regulation studies in root nodule and other bacteria. *Microbiology*, *145*, 1307-1316.
- Reeve, W. G., Tiwari, R. P., Kale, N. B., Dilworth, M. J., and Glenn, A. R. (2002). ActP controls copper homeostasis in *Rhizobium leguminosarum* bv. *viciae* and *Sinorhizobium meliloti* preventing low pH-induced copper toxicity. *Mol. Microbiol.*, *43*, 981-991.
- Reeve, W. G., Tiwari, R. P., Guerreiro, N., Stubbs, J., Dilworth, M. J., *et al.* (2004). Probing for pH-regulated proteins in *Sinorhizobium medicae* using proteomic analysis. *J. Mol. Microbiol. Biotechnol.*, *7*, 140-147.
- Reid, C. J., Walshaw, D. L., and Poole, P. S. (1996). Aspartate transport by the Dct system in *Rhizobium leguminosarum* negatively affects nitrogen-regulated operons. *Microbiology*, *142*, 2603-2612.
- Riccillo, P. M., Muglia, C. I., de Bruijn, F. J., Roe, A. J., Booth, I. R., and Aguilar, O. M. (2000). Glutathione is involved in environmental stress responses in *Rhizobium tropici*, including acid tolerance. *J. Bacteriol.*, *182*, 1748-1753.
- Richardson, J. S., Hynes, M. F., and Oresnik, I. J. (2004). A genetic locus necessary for rhamnose uptake and catabolism in *Rhizobium leguminosarum* bv. *trifolii*. *J. Bacteriol.*, *186*, 8433-8442.
- Robson, A. D., and Loneragan, J. (1970). Nodulation and growth of *Medicago truncatula* on acid soils. II Colonization of acid soils by *Rhizobium meliloti*. *Aust. J. Agric. Res.*, *21*, 435-445.
- Rodelas, B., Lithgow, J. K., Wisniewski-Dyé, F., Hardman, A., Wilkinson, A., *et al.* (1999). Analysis of quorum-sensing-dependent control of rhizosphere-expressed (*rhi*) genes in *Rhizobium leguminosarum* bv. *viciae*. *J. Bacteriol.*, *181*, 3816-3823.
- Roessler, M., and Müller, V. (2001). Osmoadaptation in bacteria and archaea: Common principles and differences. *Environ. Microbiol.*, *3*, 743-754.
- Roest, H. P., Goosen-de Roo, L., Wijffelman, C. A., De Maagd, R. A., and Lugtenberg, B. J. J. (1995). Outer-membrane protein changes during bacteroid development are independent of nitrogen-fixation and differ between indeterminate and determinate nodulating host plants of *Rhizobium leguminosarum*. *Mol. Plant-Microbe Interact.*, *8*, 14-22.
- Ronson, C. W., and Primrose, S. B. (1979). Carbohydrate metabolism in *Rhizobium trifolii*: Identification and symbiotic properties of mutants. *J. Gen. Microbiol.*, *112*, 77-88.
- Rosemeyer, V., Michiels, J., Verreth, C., and Vanderleyden, J. (1998). *luxI*- and *luxR*-homologous genes of *Rhizobium etli* CNPAF512 contribute to synthesis of autoinducer molecules and nodulation of *Phaseolus vulgaris*. *J. Bacteriol.*, *180*, 815-821.

- Rosenblueth, M., Hynes, M. F., and Martínez-Romero, E. (1998). *Rhizobium tropici* *teu* genes involved in specific uptake of *Phaseolus vulgaris* bean exudate compounds. *Mol. Gen. Genet.*, *258*, 587-598.
- Rosendahl, L., Dilworth, M. J., and Glenn, A. R. (1992). Exchange of metabolites across the peribacteroid membrane in pea root nodules. *J. Plant Physiol.*, *139*, 635-638.
- Ruberg, S., Tian, Z. X., Krol, E., Linke, B., Meyer, F., et al. (2003). Construction and validation of a *Sinorhizobium meliloti* whole genome DNA microarray: Genome-wide profiling of osmoadaptive gene expression. *J. Biotechnol.*, *106*, 255-268.
- Rusanganwa, E., and Gupta, R. S. (1993). Cloning and characterization of multiple *groEL* chaperonin-encoding genes in *Rhizobium meliloti*. *Gene*, *126*, 67-75.
- Salminen, S. O., and Streeter, J. G. (1987). Involvement of glutamate in the respiratory metabolism of *Bradyrhizobium japonicum* bacteroids. *J. Bacteriol.*, *169*, 495-499.
- Salminen, S. O., and Streeter, J. G. (1990). Factors contributing to the accumulation of glutamate in *Bradyrhizobium japonicum* bacteroids under microaerobic conditions. *J. Gen. Microbiol.*, *136*, 2119-2126.
- Santos, R., Hérouart, D., Sigaud, S., Touati, D., and Puppo, A. (2001). Oxidative burst in alfalfa-*Sinorhizobium meliloti* symbiotic interaction. *Mol. Plant-Microbe Interact.*, *14*, 86-89.
- Scharf, B., Schuster-Wolff-Bühning, H., Rachel, R., and Schmitt, R. (2001). Mutational analysis of the *Rhizobium lupini* H13-3 and *Sinorhizobium meliloti* flagellin genes: Importance of flagellin A for flagellar filament structure and transcriptional regulation. *J. Bacteriol.*, *183*, 5334-5342.
- Scharf, B. (2002). Real-time imaging of fluorescent flagellar filaments of *Rhizobium lupini* H13-3: flagellar rotation and pH-induced polymorphic transitions. *J. Bacteriol.*, *184*, 5979-5986.
- Scharf, B., and Schmitt, R. (2002). Sensory transduction to the flagellar motor of *Sinorhizobium meliloti*. *J. Mol. Microbiol. Biotechnol.*, *4*, 183-186.
- Schmitt, R. (2002). Sinorhizobial chemotaxis: A departure from the enterobacterial paradigm. *Microbiology*, *148*, 627-631.
- Schripsema, J., de Rudder, K. E. E., van Vliet, T. B., Lankhorst, P. P., de Vroom, E., et al. (1996). Bacteriocin small of *Rhizobium leguminosarum* belongs to the class of N-acyl-L-homoserine lactone molecules, known as autoinducers and as quorum sensing co-transcription factors. *J. Bacteriol.*, *178*, 366-371.
- Schwartz, C. J., Giel, J. L., Patschkowski, T., Luther, C., Ruzicka, F. J., et al. (2001). IscR, an Fe-S cluster-containing transcription factor, represses expression of *Escherichia coli* genes encoding Fe-S cluster assembly proteins. *Proc. Natl. Acad. Sci. USA.*, *98*, 14895-14900.
- Slonczewski, J. L., and Foster, J. W. (1996). pH-regulated genes and survival at extreme pH. In F. C. C. E. Neidhardt (Ed.), *Escherichia coli and Salmonella cellular and molecular biology*. (pp. 283-306). Washington, D.C.: American Society for Microbiology Press.
- Smit, G., Swart, S., Lugtenberg, B. J., and Kijne, J. W. (1992). Molecular mechanisms of attachment of *Rhizobium* bacteria to plant roots. *Mol. Microbiol.*, *6*, 2897-2903.
- Smith, L. T., Pocard, J. A., Bernard, T., and Le Rudulier, D. (1988). Osmotic control of glycine betaine biosynthesis and degradation in *Rhizobium meliloti*. *J. Bacteriol.*, *170*, 3142-3149.
- Smith, L. T., and Smith, G. M. (1989). An osmoregulated dipeptide in stressed *Rhizobium meliloti*. *J. Bacteriol.*, *171*, 4714-4717.
- Smith, M. T., and Emerich, D. W. (1993a). Alanine dehydrogenase from soybean nodule bacteroids: purification and properties. *Arch. Biochem. Biophys.*, *304*, 379-385.
- Smith, M. T., and Emerich, D. W. (1993b). Alanine dehydrogenase from soybean nodule bacteroids - kinetic mechanism and pH studies. *J. Biol. Chem.*, *268*, 10746-10753.
- Soedarjo, M., and Borthakur, D. (1996). Mimosine produced by the tree-legume *Leucaena* provides growth advantages to some *Rhizobium* strains that utilize it as a source of carbon and nitrogen. *Plant Soil*, *186*, 87-92.
- Soedarjo, M., and Borthakur, D. (1998). Mimosine, a toxin produced by the tree-legume *Leucaena* provides a nodulation competition advantage to mimosine-degrading *Rhizobium* strains. *Soil Biol. Biochem.*, *30*, 1605-1613.
- Sourjik, V., and Schmitt, R. (1996). Different roles of CheY1 and CheY2 in the chemotaxis of *Rhizobium meliloti*. *Mol. Microbiol.*, *22*, 427-436.

- Sourjik, V., Sterr, W., Platzer, J., Bos, I., Haslbeck, M., and Schmitt, R. (1998). Mapping of 41 chemotaxis, flagellar and motility genes to a single region of the *Sinorhizobium meliloti* chromosome. *Gene*, *223*, 283-290.
- Sourjik, V., Muschler, P., Scharf, B., and Schmitt, R. (2000). VisN and VisR are global regulators of chemotaxis, flagellar, and motility genes in *Sinorhizobium (Rhizobium) meliloti*. *J. Bacteriol.*, *182*, 782-788.
- Sourjik, V., and Berg, H. C. (2004). Functional interactions between receptors in bacterial chemotaxis. *Nature*, *428*, 437-441.
- Soussi, M., Santamaria, M., Ocana, A., and Lluch, C. (2001). Effects of salinity on protein and lipopolysaccharide pattern in a salt-tolerant strain of *Mesorhizobium ciceri*. *J. Appl. Microbiol.*, *90*, 476-481.
- Stanfield, S. W., Ielpi, L., O'Brochta, D., Helinski, D. R., and Ditta, G. S. (1988). The *ndvA* gene product of *Rhizobium meliloti* is required for beta-(1,2)glucan production and has homology to the ATP-binding export protein HlyB. *J. Bacteriol.*, *170*, 3523-3530.
- Steele, H. L., Werner, D., and Cooper, J. E. (1999). Flavonoids in seed and root exudates of *Lotus pedunculatus* and their biotransformation by *Mesorhizobium loti*. *Physiol. Plant.*, *107*, 251-258.
- Stowers, M. D. (1985). Carbon metabolism in *Rhizobium* species. *Annu. Rev. Microbiol.*, *39*, 89-108.
- Streeter, J. G., and Salminen, S. O. (1990). Periplasmic metabolism of glutamate and aspartate by intact *Bradyrhizobium japonicum* bacteroids. *Biochim. Biophys. Acta*, *1035*, 257-265.
- Streit, W. R., Joseph, C. M., and Phillips, D. A. (1996). Biotin and other water-soluble vitamins are key growth-factors for alfalfa root colonization by *Rhizobium meliloti* 1021. *Mol. Plant-Microbe Interact.*, *9*, 330-338.
- Stripf, R., and Werner, D. (1978). Differentiation of *Rhizobium japonicum*, II. Enzymatic activities in bacteroids and plant cytoplasm during the development of nodules of *Glycine max*. *Z. Naturforsch.*, *33c*, 373-381.
- Sullivan, J. T., Brown, S. D., Yocum, R. R., and Ronson, C. W. (2001). The bio operon on the acquired symbiosis island of *Mesorhizobium* sp strain R7A includes a novel gene involved in pimeloyl-CoA synthesis. *Microbiology*, *147*, 1315-1322.
- Talibart, R., Jebbar, M., Gouesbet, G., Himdi-Kabbab, S., Wroblewski, H., et al. (1994). Osmoadaptation in rhizobia: ectoine-induced salt tolerance. *J. Bacteriol.*, *176*, 5210-5217.
- Taté, R., Riccio, A., Merrick, M., and Patriarca, E. J. (1998). The *Rhizobium etli amtB* gene coding for an NH₄⁺ transporter is down-regulated early during bacteroid differentiation. *Mol. Plant-Microbe Interact.*, *11*, 188-198.
- Taté, R., Cermola, M., Riccio, A., Iaccarino, M., Merrick, M., Favre, R., and Patriarca, E. J. (1999). Ectopic expression of the *Rhizobium etli amtB* gene affects the symbiosome differentiation process and nodule development. *Mol. Plant-Microbe Interact.*, *12*, 515-525.
- Taté, R., Ferraioli, S., Filosa, S., Cermola, M., Riccio, A., et al. (2004). Glutamine utilization by *Rhizobium etli*. *Mol. Plant-Microbe Interact.*, *17*, 720-728.
- Tepfer, D., Goldmann, A., Pamboukdjian, N., Maille, M., Lepingle, A., et al. (1988). A plasmid of *Rhizobium meliloti* 41 encodes catabolism of two compounds from root exudate of *Calystegium sepium*. *J. Bacteriol.*, *170*, 1153-1161.
- Thony-Meyer, L., and Kunzler, P. (1996). The *Bradyrhizobium japonicum* aconitase gene (*acnA*) is important for free-living growth but not for an effective root-nodule symbiosis. *J. Bacteriol.*, *178*, 6166-6172.
- Thorne, S. H., and Williams, H. D. (1997). Adaptation to nutrient starvation in *Rhizobium leguminosarum* bv. *phaseoli*: Analysis of survival, stress resistance, and changes in macromolecular synthesis during entry to and exit from stationary phase. *J. Bacteriol.*, *179*, 6894-6901.
- Tiwari, R. P., Reeve, W. G., and Glenn, A. R. (1992). Mutations conferring acid-sensitivity in the acid-tolerant strains of *Rhizobium meliloti* WSM419 and *Rhizobium leguminosarum* biovar *viciae* WSM710. *FEMS Microbiol. Lett.*, *100*, 107-112.
- Tiwari, R. P., Reeve, W. G., Dilworth, M. J., and Glenn, A. R. (1996a). An essential role for *actA* in acid tolerance of *Rhizobium meliloti*. *Microbiology*, *142*, 601-610.
- Tiwari, R. P., Reeve, W. G., Dilworth, M. J., and Glenn, A. R. (1996b). Acid tolerance in *Rhizobium meliloti* strain WSM419 involves a two-component sensor-regulator system. *Microbiology*, *142*, 1693-1704.

- Tiwari, R. P., Reeve, W. G., Fenner, B. J., Dilworth, M. J., Glenn, A. R., and Howieson, J. G. (2004). Probing for pH-regulated genes in *Sinorhizobium medicae* using transcriptional analysis. *J. Mol. Microbiol. Biotechnol.*, *7*, 133-139.
- Todd, J. D., Wexler, M., Sawers, G., Yeoman, K. H., Poole, P. S., and Johnston, A. W. B. (2002). RirA, an iron-responsive regulator in the symbiotic bacterium *Rhizobium leguminosarum*. *Microbiology*, *148*, 4059-4071.
- Todd, J. D., Sawers, G., and Johnston, A. W. B. (2005). Proteomic analysis reveals the wide-ranging effects of the novel, iron-responsive regulator RirA in *Rhizobium leguminosarum*. *Mol. Gen. Genom.*, *273*, 197-206.
- Tomaszewska, B., and Werner, D. (1995). Purification and properties of NAD-dependent and NADP-dependent malic enzymes from *Bradyrhizobium japonicum* bacteroids. *J. Plant Physiol.*, *146*, 591-595.
- Tombolini, R., and Nuti, M. P. (1989). Poly(β -hydroxyalkanoate) biosynthesis and accumulation by different *Rhizobium* species. *FEMS Microbiol. Lett.*, *60*, 299-304.
- Trachtenberg, S., DeRosier, D. J., and Macnab, R. M. (1987). 3-Dimensional structure of the complex flagellar filament of *Rhizobium lupini* and its relation to the structure of the plain filament. *J. Mol. Biol.*, *195*, 603-620.
- Trzebiatowski, J. R., Ragatz, D. M., and de Bruijn, F. J. (2001). Isolation and regulation of *Sinorhizobium meliloti* 1021 loci induced by oxygen limitation. *Appl. Environ. Microbiol.*, *67*, 3728-3731.
- Tsien, H. C., and Schmidt, E. L. (1977). Polarity in the exponential phase *Rhizobium japonicum* cell. *Can. J. Microbiol.*, *23*, 1274-1284.
- Tun-Garrido, C., Bustos, P., González, V., and Brom, S. (2003). Conjugative transfer of p42a from *Rhizobium etli* CFN42, which is required for mobilization of the symbiotic plasmid, is regulated by quorum sensing. *J. Bacteriol.*, *185*, 1681-1692.
- Uchiumi, T., Ohwada, T., Itakura, M., Mitsui, H., Nukui, N., et al. (2004). Expression islands clustered on the symbiosis island of the *Mesorhizobium loti* genome. *J. Bacteriol.*, *186*, 2439-2448.
- Ucker, D. S., and Signer, E. R. (1978). Catabolite-repression-like phenomenon in *Rhizobium meliloti*. *J. Bacteriol.*, *136*, 1197-1200.
- Ugalde, J. E., Lepek, V., Uttaro, A., Estrella, J., Iglesias, A., and Ugalde, R. A. (1998). Gene organization and transcription analysis of the *Agrobacterium tumefaciens* glycogen (glg) operon: Two transcripts for the single phosphoglucomutase gene. *J. Bacteriol.*, *180*, 6557-6564.
- Urban, J. E., and Dazzo, F. B. (1982). Succinate-induced morphology of *Rhizobium trifolii* 0403 resembles that of bacteroids in clover nodules. *Appl. Environ. Microbiol.*, *44*, 219-226.
- Uttaro, A. D., and Ugalde, R. A. (1994). A chromosomal cluster of genes encoding ADP-glucose synthetase, glycogen-synthase and phosphoglucomutase in *Agrobacterium tumefaciens*. *Gene*, *150*, 117-122.
- Uttaro, A. D., Ugalde, R. A., Preiss, J., and Iglesias, A. A. (1998). Cloning and expression of the *glgC* gene from *Agrobacterium tumefaciens*: Purification and characterization of the ADPglucose synthetase. *Arch. Biochem. Biophys.*, *357*, 13-21.
- Van Egeraat, A. W. S. M. (1975a). The possible role of homoserine in the development of *Rhizobium leguminosarum* in the rhizosphere of pea seedlings. *Plant Soil*, *42*, 380-387.
- Van Egeraat, A. W. S. M. (1975b). The growth of *Rhizobium leguminosarum* on the root surface and in the rhizosphere of pea seedlings in relation to root exudates. *Plant Soil*, *42*, 367-379.
- Van de Broek, A., and Vanderleyden, J. (1995). The role of bacterial motility, chemotaxis, and attachment in bacteria plant interactions. *Mol. Plant-Microbe Interact.*, *8*, 800-810.
- Vargas, M. C., Encarnación, S., Dávalos, A., Reyes-Pérez, A., Mora, Y., et al. (2003). Only one catalase, *katG*, is detectable in *Rhizobium etli*, and is encoded along with the regulator OxyR on a plasmid replicon. *Microbiology*, *149*, 1165-1176.
- Vincent, J. M. (1962). Influence of calcium and magnesium on the growth of *Rhizobium*. *J. Gen. Microbiol.*, *28*, 658-663.
- Vinuesa, P., Neumann-Silkow, F., Pacios-Bras, C., Spaik, H. P., Martínez-Romero, E., and Werner, D. (2003). Genetic analysis of a pH-regulated operon from *Rhizobium tropici* CIAT899 involved in acid tolerance and nodulation competitiveness. *Mol. Plant-Microbe Interact.*, *16*, 159-168.

- Voegele, R. T., Bardin, S., and Finan, T. M. (1997). Characterization of the *Rhizobium* (*Sinorhizobium*) *meliloti* high- and low-affinity phosphate uptake systems. *J. Bacteriol.*, *179*, 7226-7232.
- Wagner, S. C., Skipper, H. D., and Hartel, P. G. (1995). Medium to study carbon utilization by bradyrhizobium strains. *Can. J. Microbiol.*, *41*, 633-636.
- Wallington, E. J., and Lund, P. A. (1994). *Rhizobium leguminosarum* contains multiple chaperonin (*cpn60*) genes. *Microbiology*, *140*, 113-122.
- Walshaw, D. L., and Poole, P. S. (1996). The general L-amino acid permease of *Rhizobium leguminosarum* is an ABC uptake system that also influences efflux of solutes. *Mol. Microbiol.*, *21*, 1239-1252.
- Walshaw, D. L., Lowthorpe, S., East, A., and Poole, P. S. (1997a). Distribution of a sub-class of bacterial ABC polar amino acid transporter and identification of an N-terminal region involved in solute specificity. *FEBS Lett.*, *414*, 397-401.
- Walshaw, D. L., Reid, C. J., and Poole, P. S. (1997b). The general amino acid permease of *Rhizobium leguminosarum* strain 3841 is negatively regulated by the Ntr system. *FEMS Microbiol. Lett.*, *152*, 57-64.
- Walshaw, D. L., Wilkinson, A., Mundy, M., Smith, M., and Poole, P. S. (1997c). Regulation of the TCA cycle and the general amino acid permease by overflow metabolism in *Rhizobium leguminosarum*. *Microbiology*, *143*, 2209-2221.
- Wang, P., Ingram-Smith, C., Hadley, J. A., and Miller, K. J. (1999). Cloning, sequencing, and characterization of the *cgmB* gene of *Sinorhizobium meliloti* involved in cyclic β -glucan biosynthesis. *J. Bacteriol.*, *181*, 4576-4583.
- Watkin, D. (1997). So you want to train in general surgery? *Brit. J. Hosp. Med.*, *57*, 569-570.
- Watson, R. J., Rastogi, V. K., and Chan, Y. K. (1993). Aspartate transport in *Rhizobium meliloti*. *J. Gen. Microbiol.*, *139*, 1315-1323.
- Wei, X., and Bauer, W. D. (1998). Starvation-induced changes in motility, chemotaxis, and flagellation of *Rhizobium meliloti*. *Appl. Environ. Microbiol.*, *64*, 1708-1714.
- Wei, X. M., and Bauer, W. D. (1999). Tn5-induced and spontaneous switching of *Sinorhizobium meliloti* to faster-swarming behavior. *Appl. Environ. Microbiol.*, *65*, 1228-1235.
- Wells, D. H., and Long, S. R. (2002). The *Sinorhizobium meliloti* stringent response affects multiple aspects of symbiosis. *Mol. Microbiol.*, *43*, 1115-1127.
- Wells, D. H., and Long, S. R. (2003). Mutations in *rpoBC* suppress the defects of a *Sinorhizobium meliloti* *relA* mutant. *J. Bacteriol.*, *185*, 5602-5610.
- Wexler, M., Gordon, D. M., and Murphy, P. J. (1996). Genetic-relationships among rhizopine-producing *Rhizobium* strains. *Microbiology*, *142*, 1059-1066.
- Wexler, M., Todd, J. D., Kolade, O., Bellini, D., Hemmings, A. M., et al. (2003). Fur is not the global regulator of iron uptake genes in *Rhizobium leguminosarum*. *Microbiology*, *149*, 1357-1365.
- Wilkinson, A., Danino, V., Wisniewski-Dyé, F., Lithgow, J. K., and Downie, J. A. (2002). N-acyl-homoserine lactone inhibition of rhizobial growth is mediated by two quorum-sensing genes that regulate plasmid transfer. *J. Bacteriol.*, *184*, 4510-4519.
- Willis, L. B., and Walker, G. C. (1999). A novel *Sinorhizobium meliloti* operon encodes an α -glucosidase and a periplasmic-binding-protein-dependent transport system for α -glucosides. *J. Bacteriol.*, *181*, 4176-4184.
- Wisniewski-Dyé, F., and Downie, J. A. (2002). Quorum-sensing in *Rhizobium*. *Antonie van Leeuwenhoek*, *81*, 397-407.
- Wright, E. L., Deakin, W. J., and Shaw, C. H. (1998). A chemotaxis cluster from *Agrobacterium tumefaciens*. *Gene*, *220*, 83-89.
- Yost, C. K., Rochepeau, P., and Hynes, M. F. (1998). *Rhizobium leguminosarum* contains a group of genes that appear to code for methyl-accepting chemotaxis proteins. *Microbiology*, *144*, 1945-1956.
- Yost, C. K., and Hynes, M. F. (2000). Rhizobial motility and chemotaxis: Molecular biology and ecological role. In E. Triplett (Ed.), *Prokaryotic nitrogen fixation: A model system of a biological process*. (pp. 237-250). Wymondham, UK: Horizon Scientific Press.
- Yost, C. K., Clark, K. T., Del Bel, K. L., and Hynes, M. F. (2003). Characterization of the nodulation plasmid encoded chemoreceptor gene *mcpG* from *Rhizobium leguminosarum*. *BMC Microbiol.* <http://www.biomedcentral.com/1471-2180/3/1>.

- Yost, C. K., Del Bel, K. L., Quandt, J., and Hynes, M. F. (2004). *Rhizobium leguminosarum* methyl-accepting chemotaxis protein genes are down-regulated in the pea nodule. *Arch. Microbiol.*, 182, 505-513.
- Yurgel, S., Mortimer, M. W., Rogers, K. N., and Kahn, M. L. (2000). New substrates for the dicarboxylate transport system of *Sinorhizobium meliloti*. *J. Bacteriol.*, 182, 4216-4221.
- Zahran, H. H. (1999). *Rhizobium*-legume symbiosis and nitrogen fixation under severe conditions and in an arid climate. *Microbiol. Mol. Biol. Rev.*, 63, 968-989.
- Zevenhuizen, L. P. T. M. (1981). Cellular glycogen, β -1,2-glucan, poly- β -hydroxybutyric acid and extracellular polysaccharides in fast growing species of *Rhizobium*. *Antonie van Leeuwenhoek*, 47, 481-497.
- Zlotnikov, K. M., Marunov, S. K., and Khmel'nitskii, M. I. (1984). Disturbance in assimilation of fixed nitrogen by soybean plants in symbiosis with the asp^- bacterium *Rhizobium japonicum*. *Dokl. Akad. Nauk SSSR.*, 275, 189-192.
- Zorreguieta, A., Geremia, R. A., Cavaignac, S., Cangelosi, G. A., Nester, E. W., and Ugalde, R. A. (1988). Identification of the product of an *Agrobacterium tumefaciens* chromosomal virulence gene. *Mol. Plant-Microbe Interact.*, 1, 121-127.

Chapter 10

CARBON AND NITROGEN METABOLISM IN LEGUME NODULES

C. P. VANCE

*USDA Agricultural Research Service,
411 Borlaug Hall, 1991 Upper Buford Circle,
St. Paul, MN 55108 U.S.A.*

1. LEGUME ROOT NODULES ARE CARBON AND NITROGEN FACTORIES

Nitrogen-fixing (Fix^+) symbiotic root nodules of legumes are model factories for carbon (C) and nitrogen (N) metabolism. Although nodules generally comprise less than 5% of legume total biomass, they can catalyze the reduction of more than 100 kg N per hectare each year. Globally, about 60-90 Tg of N_2 are fixed symbiotically each year, an amazing amount considering that only a few kg of the microbial enzyme nitrogenase are involved in catalysis (Delwiche, 1970). Although root nodules comprise only a small proportion of plant weight, they consume 13-28% of legume total photosynthate. This striking use of C is because reduction of N_2 to NH_4^+ requires a substantial energy input (Equation 1).



Based upon the average of more than 30 studies (Phillips, 1980; Schubert, 1982), the legume plant expends 6-7 grams of C per gram N reduced. The biological C cost of symbiotic N_2 fixation is substantially higher than the theoretical C (*ca.* 1.5 g C g^{-1} N) cost of Equation 1 due to the intrinsic complexity of the symbiotic system, which includes nodule growth and maintenance as well as plant N and C metabolism. It is, therefore, apparent that integration of N and C metabolism in root nodules plays a key role in legume plant N and C cycles as well as being critical for growth and development.

Direct measurements of nodule sugars coupled to $^{14}\text{CO}_2$ pulse-chase studies have shown sucrose derived from photosynthate to usually be the most abundant sugar present in root nodules (Streeter, 1980) (Table 1). Within 15 minutes of labeling leaves with $^{14}\text{CO}_2$, radioactive sucrose can be detected in nodules (Gordon *et al.*, 1985) with label subsequently found in nodule organic acids and amino acids. However, sucrose is not utilized directly to provide the energy for N_2 fixation. Several studies have shown that isolated symbiosomes actively take up malate and succinate, but they acquire sugars passively (Udvardi and Day, 1997; Vance *et al.*, 1997). Furthermore, rhizobia that have mutations, which knock out organic-acid uptake and/or metabolism, are ineffective (Fix^-), whereas those unable to utilize sugars remain effective (Fix^+). In addition, Fix^- nodules generally have significantly reduced quantities of organic acids (Table 2) but show much less impact on sugars. Thus, organic acids derived through sucrose metabolism and root nodule CO_2 fixation are the direct substrates needed by bacteroids for generating the ATP required for nitrogenase activity (Figure 1).

*Table 1. Predominant sugars in legume root nodules.
Typical values for soybean, common bean, alfalfa, pea, and clover.*

Sugar	Concentration (mg gFW ⁻¹)
Sucrose	6.0-9.0
Glucose	0.5
Fructose	0.2
Sugar Alcohols (soybean only)	3.0

*Table 2. Predominant amino acids and organic acids in
effective and ineffective legume root nodules.
Typical values from alfalfa, pea, common bean, and soybean.*

Nodule type	Aminoacid ($\mu\text{mol gFW}^{-1}$)						Organic acid ($\mu\text{mol gFW}^{-1}$)					
	Alanine	3-Aminobutyrate	Asparagine	Aspartate	Glutamate	Glutamine	Citrate	Fumarate	2-Oxoglutarate	Malate	Malonate	Succinate
Fix^-	0.1	0.1	0.2	0.1	0.1	0.1	0.1	0.5	0.2	1.3	0.1	0.3
Fix^+	1.5	1.8	15.5	1.0	2.1	1.5	0.4	1.5	0.8	5.4	1.0	3.0

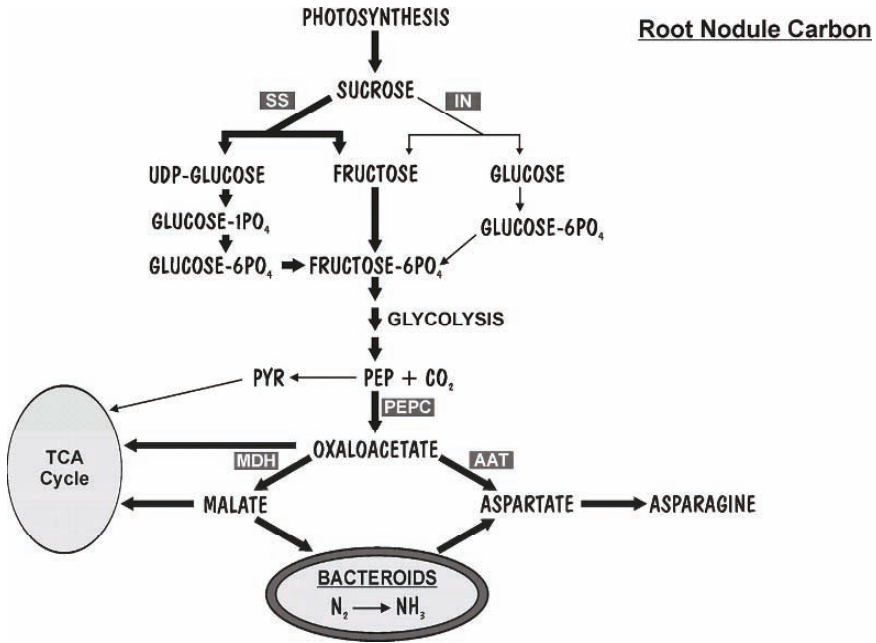

Figure 1. Carbon metabolism in legume root nodules is tightly linked to nitrogen fixation by bacteroids and the assimilation of fixed-N into amino acids.

Sucrose translocated from the shoot is cleaved by sucrose synthase (SS) to form UDP-glucose and fructose. Sucrose can also be cleaved by invertase (IN) but this does not appear to be a primary route for carbon in root nodules. The hexoses are metabolized via glycolysis to phosphoenolpyruvate (PEP), which can either be converted to pyruvate to enter the TCA cycle or alternatively to oxaloacetate by PEP carboxylase (PEPC).

Oxaloacetate plays a central role in nodules, it can: (i) be reduced to malate by malate dehydrogenase (MDH) to provide carbon for bacteroids; and (ii) provide the carbon backbone for aspartate biosynthesis through aspartate aminotransferase (AAT).

Aspartate is known to be synthesized in plant cells, but it may also be released from bacteroids into the plant cells.

Likewise, nodule organic acids provide the C skeletons for the assimilation of NH_4^+ derived from N_2 fixation into amino acids (King *et al.*, 1986; Rosendahl *et al.*, 1990; Schulze *et al.*, 2002). Labeling of root nodules with either $^{15}\text{N}_2$ or $^{14}\text{CO}_2$ shows an incorporation pattern consistent with the pathway outlined in Figure 2. In most Fix^- nodules resulting from mutations that impair sucrose metabolism, nodule CO_2 fixation, and nitrogenase activity, both the concentration (see Table 2) of and label incorporated into amino acids is decreased. As noted in Figure 2 and evidenced from labeling studies in Fix^+ nodules, $^{15}\text{N}_2$ is rapidly incorporated into NH_4^+ , and then into amino acids, particularly glutamine, glutamate, aspartate, asparagine, and alanine (Table 2). However, in Fix^- nodules, $^{15}\text{N}_2$ is not incorporated into either NH_4^+ or amino acids. Moreover, treatment of nodules with

inhibitors that block the activity of enzymes involved in N assimilation results in increased NH_4^+ accumulation and a rapid depletion of the amino-acid pools.

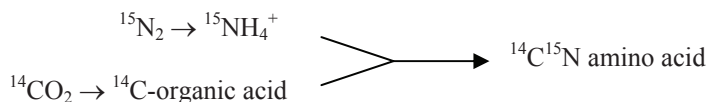

Figure 2. Pathway for incorporation of ${}^{14}\text{CO}_2$ and ${}^{15}\text{N}_2$ into amino acids in legume nodules.

Recently, the long-held paradigm that N_2 -fixing bacteroids provide the plant with fixed-N solely in the form of NH_4^+ has undergone significant revision. Studies with pea and soybean (Lodwig *et al.*, 2003; Waters *et al.*, 1998) have shown that bacteroids not only provide fixed-N in the form of NH_4^+ but also as amino acids (see Chapter 9 of this volume). Pea rhizobia, which are unable to take up amino acids due to mutations in amino-acid permease genes, continue to be Fix^+ but plants inoculated with these mutants show a Fix^- phenotype. This outcome reflects the fact that amino acids provided by the plant are exchanged with the bacteroid in return for NH_4^+ and amino acids needed for asparagine synthesis. At this time, neither the identity of amino acids exchanged nor the quantitative abundance of N exchanged as amino acids has been resolved. In isolated soybean bacteroids, symbiotically fixed-N is rapidly incorporated into alanine but the significance of this process *in vivo* remains to be established.

2. NODULE CARBON METABOLISM

The major pathway for C metabolism in root nodules involves the cleavage of sucrose to UDP-glucose and fructose followed by glycolysis to produce the organic acids oxaloacetate and malate (Figure 1). This pathway requires the activity of some 14 enzymes, most of which have enhanced activity (3-fold or more) in nodules as compared to roots (Day and Copeland, 1991; Kouchi *et al.*, 1988; Tajima *et al.*, 2000; Vance and Heichel, 1991), a not unexpected result in view of the large flux of C through nodules. Studies of soybean (Copeland *et al.*, 1989), chickpea (Copeland *et al.*, 1995), and alfalfa (Irigoyen *et al.*, 1990) have shown that the host-plant cytosol fraction contains essentially all of the enzymes required for sucrose utilization, whereas bacteroids appear to be deficient in activity for one or more of the enzymes required for sucrose cleavage and glycolysis. These observations provide added support for the importance of organic acids in bacteroid metabolism and N_2 fixation and they emphasize the plant's role in production of organic acids.

Even though the plant is the source of C required for bacteroid functioning, it remains unclear as to the cellular distribution and expression pattern of the C-pathway enzymes. Root nodules are complex organs that contain a variety of cell types, which undergo differentiation over time, including a central zone that contains both infected and uninfected cells, inner and outer cortical layers, vascular tissue, and, in some species, a persistent indeterminate meristem (see Chapter 6).

The expression of enzymes involved in C metabolism and the genes encoding them is, therefore, a function of metabolism, cell type, and developmental stage.

The picture emerging from studies utilizing a variety of cellular-localization approaches indicates that root-nodule enzymes involved in C metabolism are expressed throughout the nodule in both infected and uninfected cells. However, the relative importance of the enzyme x cell type contribution to C metabolism changes as nodules age and also depends on whether the nodule is determinate or indeterminate (see Chapter 6 of this volume). Determinate nodules, like those on soybean and chickpea, appear to have a greater proportion of C metabolism occurring in uninfected cells of the N₂-fixing zone and nodule inner cortex than do indeterminate nodules, like those of alfalfa and pea, which appear to have a more uniform distribution between infected and uninfected cells (Day and Copeland, 1991; Hohnjec *et al.*, 2003; Robinson *et al.*, 1999). Although infected cells of nodules are known to serve as a home for bacteroids and function in N assimilation, the role of nodule uninfected cells has been an ongoing question.

The fact that uninfected cells can metabolize sucrose to organic acids has given rise to two independent hypotheses. These are: (i) that carbon metabolism to malate in nodule inner-cortical cells is integrally related to an osmocontractile mechanism regulating cell swelling and O₂ entry into the infected zone; and (ii) that malate production by uninfected cells in the N₂-fixing zone provides the C necessary for bacteroid energy and plant amino-acid biosynthesis (Atkins *et al.*, 2001; Galvez *et al.*, 2000; Vance and Heichel, 1991).

Although several root-nodule enzymes involved in C metabolism have been purified and characterized biochemically, only four have received in-depth molecular analysis and immunochemical characterization; these are sucrose synthase (SS, EC 2.4.1.13), phosphoenolpyruvate carboxylase (PEPC, EC 4.1.1.31), carbonic anhydrase (CA, EC 4.2.1.1), and malate dehydrogenase (MDH, EC 1.1.1.82).

3. SUCROSE SYNTHASE

Sucrose synthase (SS) was among the first nodulins to be identified (Thummler and Verma, 1987) and is apparently the primary enzyme hydrolyzing sucrose to UDP-glucose plus fructose in root nodules. The enzyme occurs as a tetramer comprised of four *ca.* 92-kD subunits. The enzyme comprises a significant portion of nodule soluble protein (1%) and the enzyme activity in nodules is high (*ca.* 600 nmol min⁻¹ mg⁻¹ protein). Purified soybean nodule SS is readily inhibited by glucose and has a high affinity for UDP, further suggesting a role for SS in cleavage of sucrose. Moreover, the cellular energetics of sucrose metabolism *via* SS is much more favorable than through invertase and only little invertase is present in nodules.

Sucrose synthase cDNAs have been isolated from a number of plant sources and its expression evaluated under a variety of conditions. The enzyme is encoded by a multigene family with individual plant organs expressing one or more specific members of the family. Root nodule-enhanced forms of SS have been identified in *Glycine*, *Vicia*, *Lotus*, *Pisum*, *Phaseolus*, and *Medicago* (Thummler and Verma,

1987; Craig *et al.*, 1999; Fedorova *et al.*, 1999; Hohnjec *et al.*, 1999; Robinson *et al.*, 1999; Silvente *et al.*, 2003a). In all cases, nodule SS transcripts are 10- to 20-fold more abundant in nodules than other tissues (Figure 3). The activity of SS is a function of both transcriptional and post-translational events.

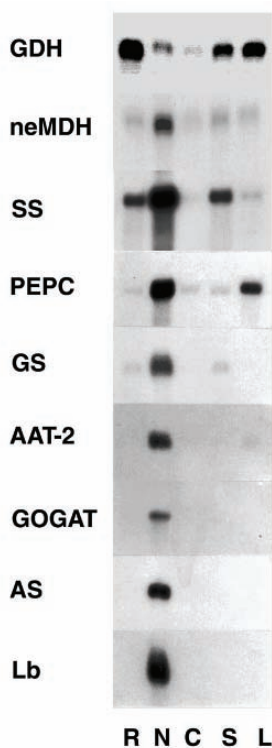

Figure 3. Steady state expression of mRNAs encoding the primary enzymes of carbon and nitrogen metabolism in *Medicago sativa*.

Lanes correspond to: R, roots; N, nodules; C, cotyledons; S, stems; and L, leaves.

All lanes contain 1 μ g of polyA+RNA.

Enzyme designations are: SS, sucrose synthase; PEPC, phosphoenolpyruvate carboxylase; MDH, malate dehydrogenase; GS, glutamine synthetase; GOGAT, NADH-dependent glutamate synthase; AAT, aspartate aminotransferase; AS, asparagine synthetase; and GDH, glutamate dehydrogenase.

Lb refers to the root nodule oxygen-binding protein leghemoglobin.

Although SS was for years thought to be only cytoplasmic, a portion of SS protein has recently been found plasma membrane-associated (Winter *et al.*, 1997). Proteomic analysis of symbiosome membrane proteins has also identified SS as a component of the membrane (Saalbach *et al.*, 2002; Wienkoop and Saalbach, 2003). Chollet's group has shown that the plasma membrane association of soybean-nodule SS is a function of the phosphorylation state of the serine-11 residue, the nodule

membrane SS being hypophosphorylated as compared to soluble SS. Moreover, treatments that have a negative impact on N₂ fixation modify the phosphorylation state of both forms of SS. The phosphorylation of nodule SS is catalyzed by a Ca²⁺-dependent protein kinase (Komina *et al.*, 2002; Zhang and Chollet, 1997). Despite the abundant evidence that SS undergoes phosphorylation, the significance of this post-translational event to both SS activity and its cellular location remains uncertain. Expression of SS is also regulated by metabolites and O₂ concentration. Common bean SS transcripts increase in response to added N metabolites, including glutamine and allantoin. Anaerobiosis induces SS in roots of many species, so induction of SS in the low-O₂ environment of nodules would be consistent with the SS response to anaerobiosis in other systems.

Although radiolabeling, enzyme activity, immunoblotting, and RNA-expression studies have shown that SS is much more abundant in root nodules as compared to roots, its functional importance in N₂ fixation was established only after SS-deficient mutants were developed. Pea plants containing a mutation in the *rug4* locus grow poorly when they are dependent upon N derived from symbiotic N₂ fixation but appear normal when grown on nitrate (Craig *et al.*, 1999; Gordon *et al.*, 1999). Although the *rug4* plants form nodules and those nodules contain some nitrogenase protein, they have strikingly decreased N accumulation compared to wild type due to an almost complete absence of nitrogenase activity. Measurement of C and N metabolism showed *rug4* nodules had a 95% reduction in SS activity, whereas most other enzymes showed no effect. The *rug4* mutation was shown to lie in the SS gene at position 1757 (converting ⁵⁷⁸Arg to ⁵⁷⁸Lys) and, thus, knocking out SS activity. Analysis of the *rug4* plants conclusively demonstrates the requirement for SS in symbiotic N₂ fixation.

4. PHOSPHOENOLPYRUVATE CARBOXYLASE

Phosphoenolpyruvate carboxylase (PEPC) is ubiquitous in C3 and C4 plants, where it catalyzes the irreversible carboxylation of phosphoenolpyruvate to oxaloacetate. The enzyme plays a key role in C4 and CAM plants by catalyzing the initial incorporation of CO₂ into organic acids and effectively concentrating fixed CO₂ in leaves (Chollet *et al.*, 1996). PEPC also plays important roles in C3 plants including stomatal opening, pulvinal movement, ion balance, and pH-stat. The best recognized role for PEPC in legumes (C3) is in N₂-fixing root nodules, where the enzyme provides both C for N assimilation into amino acids and malate for bacteroids as an energy source for bacteroid nitrogenase (Vance *et al.*, 1994; Vance, 2000). PEPC activity, protein, and mRNA are significantly more abundant in legume root nodules as compared to roots. The enzyme comprises *ca.* 1% of nodule soluble protein and enzyme activity is high (*ca.* 400-600 nmol min⁻¹ mg protein⁻¹). Carbon fixed *via* root-nodule PEPC provides some 30% of that needed for aspartate and asparagine biosynthesis in N₂-fixing nodules. In ineffective nodules, PEPC activity and mRNA abundance are frequently quite low (Egli *et al.*, 1989; Vance *et al.*, 1994; Vance, 2000).

Legume root-nodule PEPC has been characterized from *Glycine*, *Lotus*, *Medicago*, and *Pisum* (Fedorova *et al.*, 1999; Hata *et al.*, 1998; Nakagawa *et al.*, 2003; Pathirana *et al.*, 1997); all appear to have similar kinetic characteristics and antigenic determinants. The enzyme is a tetramer composed of subunits of M_r 110 kD and is localized to the cytosol (Chollet *et al.*, 1996; Pathirana *et al.*, 1997). It is encoded by a multigene family and, in legumes at least, one of the PEPC genes shows highly enhanced expression in root nodules (Figure 2).

Regulation of root-nodule PEPC occurs at both the transcriptional and post-translational levels. Post-translational regulation of nodule PEPC activity is achieved through protein turnover, phosphorylation of the enzyme, and allosteric modifications due to malate and glucose-6-phosphate (Chollet *et al.*, 1996). Upon phosphorylation, which is achieved through a nodule-enhanced PEPC serine/threonine kinase (Xu *et al.*, 2003), nodule PEPC becomes less susceptible to inhibition by malate. Reduced sensitivity to malate is a necessity when one considers the high malate concentrations in nodules.

Nodule immunolabeling and *in situ* mRNA hybridization studies show that PEPC protein and RNA occur in both infected and uninfected cells of the N_2 -fixing zone, with infected cells having greater expression than uninfected cells. Significant expression of PEPC has also been detected in the inner cortex and vascular bundles of nodules. Interestingly, deletion analysis of the alfalfa-nodule PEPC promoter showed that expression in various cell layers of the nodule resided in independent promoter elements. It is also noteworthy that PEPC can be induced in other plants in response to anaerobiosis and that the alfalfa-nodule PEPC promoter has an element similar to that which controls O_2 stress-induced PEPC genes.

The dependence of nodule function on PEPC activity has been shown through the effects of antisense expression of PEPC in nodules (Schulze *et al.*, 1998). Inhibition of nodule PEPC *via* antisense resulted in a decrease of nodule enzyme activity and mRNA, decreased N accumulation and plant growth, and lower nitrogenase activity. In addition, treatments that decrease N_2 fixation, like shading and stem girdling, lower both nodule PEPC and PEPC-kinase activity. Re-supply of carbohydrate to nodules restores PEPC and PEPC-kinase activity as well as that of N_2 fixation.

5. CARBONIC ANHYDRASE

Carbonic anhydrase (CA) catalyzes the reversible hydration of CO_2 to bicarbonate, thus providing the substrate for PEPC activity and the formation of oxaloacetate in root nodules. The enzyme is a zinc-containing tetrameric metalloenzyme with a native M_r of 100 kD and four 25-28 kD subunits. The enzyme is widely distributed throughout the plant world and functions in multiple processes, including C3 and C4 photosynthesis, pH balance, diffusion of inorganic acids between cells, and root-nodule C metabolism (Atkins *et al.*, 2001). It has been identified in root nodules of *Glycine*, *Medicago*, *Phaseolus*, *Pisum*, and *Lupinus* (Atkins *et al.*, 2001). Carbonic anhydrase enzyme activity, protein and mRNA increase markedly during the course

of root-nodule development. In leaves, CA occurs as either a cytosolic or chloroplastic form. Root-nodule cDNAs encoding CA have been characterized from *Glycine* and *Medicago* (de la Pena *et al.*, 1997; Kavroulakis *et al.*, 2003). Nodule CA's have a M_r of *ca.* 28 kD, do not contain a transit sequence, and appear to be located in the cytosol. Enzyme activity has been demonstrated in both the cortex and inner N_2 -fixing zone of both determinate and indeterminate nodules. Moreover, immunological studies suggest that nodules may contain at least two forms of CA that are targeted to different cell types. One form appears to function at the nodule periphery and in uninfected cells, whereas a second type occurs in infected cells.

Although a role for CA in generating organic acids for bacteroids and amino-acid synthesis seems intuitive because of its role in C4 metabolism, several authors have proposed other roles for the enzyme in nodules (de la Pena *et al.*, 1997; Galver *et al.*, 2000). CA activity in nodule periphery and uninfected cells may be important for the synthesis of malate for either a cellular osmocontractile mechanism that regulates O_2 entry into the nodule or for facilitating diffusion of some CO_2 out of nodules. Atkins *et al.* (2001) and Kavroulakis *et al.* (2003) propose that CA in the nodule cortex may facilitate diffusion of CO_2 out of nodules. The rapid diffusion of CO_2 out of the nodule would, as proposed by Atkins *et al.* (2001), result in a pressure gradient and, thus, facilitate O_2 diffusion into the nodule. As with some other nodule enzymes of C metabolism, identification of a definitive function for CA in N_2 fixation awaits analysis of mutants.

6. MALATE DEHYDROGENASE

Malate dehydrogenase (MDH) catalyzes the reversible reduction of oxaloacetate to malate. The enzyme is crucial in several metabolic pathways and higher plants contain at least five different forms that differ in coenzyme specificity and subcellular location (Gietl, 1992). Root nodules contain four NAD^+ -dependent malate dehydrogenases: (i) cytosolic (c) MDH; mitochondrial (m) MDH; glyoxysomal (g) MDH; and a nodule-enhanced (ne) MDH (Miller *et al.*, 1998). The $NADH$ -dependent chloroplast (dp) MDH is not detectable in root nodules. Each plant MDH is encoded by separate and distinct genes.

Nodule-enhanced MDHs have been characterized from *Glycine*, *Medicago*, and *Pisum* (Fedorova *et al.*, 1999; Imsande *et al.*, 2001; Miller *et al.*, 1998). The neMDH protein is a dimer with a M_r of *ca.* 80 kD and two 43-kD subunits. The neMDH contains an 82 amino-acid pre-sequence, which predicts subcellular targeting to plastids. The soybean nodule neMDH can be processed to a lower M_r polypeptide by isolated chloroplasts. Both neMDH transcripts and protein appear to increase in abundance as nodules develop (Figure 3), but total MDH in nodules remains relatively constant. It may be difficult to detect changes in total nodule MDH because the baseline activity of neMDH is very high ($15\text{--}25 \mu\text{mol min}^{-1} \text{mg}^{-1}$ protein) and changes in any particular form of MDH may be masked by the total activity. Although cMDH is also significantly expressed in nodules, neither cMDH

RNA nor protein level is enhanced as compared to roots and its expression does not correlate with N₂-fixation patterns.

Interestingly, kinetic studies show alfalfa neMDH is strikingly different from cMDH (Miller *et al.*, 1998; Schulze *et al.*, 2002). The neMDH has a 7-fold greater affinity for oxaloacetate than cMDH. The neMDH enzyme-turnover rates for malate oxidation and oxaloacetate reduction are 4- and 30-fold greater, respectively, than those for cMDH. Even more surprising, the neMDH kinetic constants for oxaloacetate and NADH are 70- and 100-fold greater than those for malate and NAD⁺. These data suggest that neMDH catalysis dramatically favors malate production over oxaloacetate and may be useful in modifying plant malate metabolism (Schulze *et al.*, 2002).

Recent *in situ* mRNA localization and promoter reporter-gene studies of neMDH and cMDH show that expression of these genes occurs in distinctly different patterns. In the infected cells of the N₂-fixing zone, neMDH is highly abundant. In comparison, cMDH expression is greatest in uninfected cells and the inner cortex (B. Bucciarelli and C. Vance, unpublished data). These observations would be consistent with neMDH providing malate for N₂ fixation and cMDH for mechanisms related to nodule oxygen regulation.

Although radiolabeling of nodules with ¹⁴CO₂ shows that C in malate and aspartate must be delivered by a pathway requiring CA, PEPC, and MDH, which form(s) of these enzymes is crucial to N₂ fixation remains to be established. Root nodule-enhanced enzymes of C metabolism have expression patterns consistent with a major role in N₂ fixation. Moreover, the kinetic parameters of neMDH favor rapid production of malate. However, the functional significance of individual forms of CA, PEPC, and MDH in N₂ fixation will require silencing of each form of the enzyme through either antisense RNA, RNAi silencing, or mutational lesions followed by phenotypic analysis.

7. INITIAL ASSIMILATION OF FIXED-N

Although there is uncertainty regarding which amino acids are exchanged and the quantity of amino acids exchanged between the host plant and bacteroids, overwhelming evidence indicates that a large quantity of NH₄⁺ is released from bacteroids (Meeks *et al.*, 1978) and travels across the symbiosome space (Kaiser *et al.*, 1998) into the plant, where initial assimilation into amino acids occurs. The predominant amino acids found in most legume nodules are asparagine, glutamine, aspartate, glutamate, and alanine (Table 2). Gamma-aminobutyric acid (GABA) is also frequently found in legume nodules, but its role and relevance to N₂ fixation remains obscure. Labeling and inhibitor studies indicate that, in temperate species like *Medicago*, *Pisum*, *Trifolium*, and *Lupinus*, the primary products containing fixed-N, which are being transported out of nodules into the xylem stream, are the amides asparagine and glutamine (Scharff *et al.*, 2003; Ta *et al.*, 1986). In contrast, in more tropical species like *Glycine*, *Phaseolus*, and *Vigna*, fixed-N is initially incorporated into asparagine, aspartate, glutamine, and glutamate but is then further metabolized in nodules to the ureides allantoin and allantoic acid, which are

exported to and transported in the xylem stream (Figure 4; Dart, 1977; Sprent, 1980). Irrespective of the nodule N-transport product, it is generally agreed that the primary assimilation of fixed NH_4^+ in nodules occurs through the concerted action of four enzymes (Coruzzi, 2003; Cren and Hirel, 1999; Ireland and Lea, 1999; Miflin and Habash, 2002).

LEGUME MAJOR NITROGEN TRANSPORT PRODUCTS

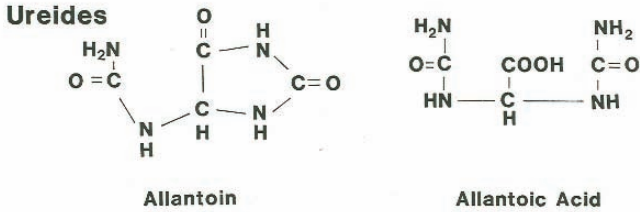

EXAMPLES: Glycine, Phaseolus, & Vigna
 NODULE MORPHOLOGY: Determinate (spherical)
 C:N RATIO 1:1

Amides

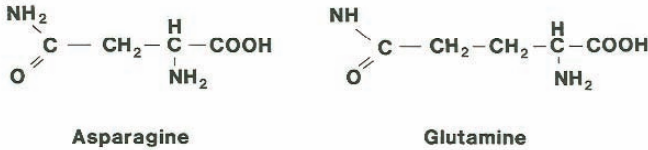

EXAMPLES: Medicago, Trifolium, Pisum, & Lupinus
 NODULE MORPHOLOGY: Indeterminate (elongate, cylindrical)
 C:N RATIO 2:1

Figure 4. Primary nitrogen-transport products synthesized in and exported from legume-root nodules.

Ureides predominate as transport products from determinate nodules of Glycine, Phaseolus, and Vigna, whereas amides predominate as transport products from indeterminate nodules of Lupinus, Medicago, Trifolium, and Pisum. Note that Lotus nodules, which are determinate in structure, synthesize and export amides.

Glutamine synthetase (GS, EC 6.3.1.2) and glutamate synthase (GOGAT, EC 1.4.1.14) are collectively referred to as the GS/GOGAT cycle (Figure 5) and catalyze the synthesis of glutamine and glutamate, respectively. Further incorporation of fixed-N into aspartate and asparagine occurs *via* aspartate aminotransferase (AAT, EC 2.6.1.1) and asparagine synthetase (AS, EC 6.3.5.4). The C skeletons needed for the initial assimilation of NH_4^+ are derived in part from sucrose cleavage *via* SS and glycolysis of hexoses to phosphoenolpyruvate, followed by synthesis of malate through phosphoenolpyruvate and MDH, yielding a

C backbone for aspartate and asparagine (Ireland and Lea, 1999). The C skeleton for glutamate and glutamine is derived from α -ketoglutarate through the TCA cycle (Figure 5). Collectively, these enzymes are highly expressed in effective root nodules (Egli *et al.*, 1989; Groat and Vance, 1982).

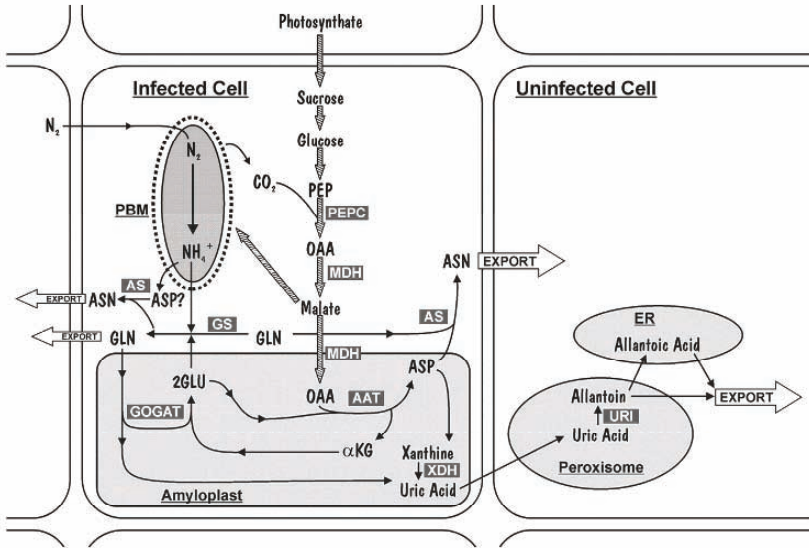

Figure 5. General scheme of C and N metabolism in legume root nodules.

Sucrose from photosynthesis is metabolized to oxaloacetate (OAA) and malate. Malate can then be utilized by the bacteroid as an energy source for nitrogenase activity. Malate can also enter the amyloplast and convert to OAA to be used for aspartate biosynthesis.

Initial assimilation of NH_4^+ derived from bacteroid N_2 fixation into glutamine (GLN) occurs in the host-plant cytosol. The bacteroids may also provide the plant with aspartate and/or other amino acids, but the amount and significance of the bacterial contribution to legume amino-acid synthesis is not clear.

Amyloplasts of infected cells appear to play a major role in the synthesis of glutamate (GLU), aspartate (ASP), and de novo purine synthesis (xanthine).

In ureide-producing legumes, xanthine is metabolized to uric acid in the infected cell.

Uric acid is transported into the uninfected cells and metabolized to allantoin and allantoic acid, which are exported to shoots.

Uninfected cells are also sites for C metabolism, but the pathways and enzymes involved remain to be established.

Other abbreviations: AAT, aspartate aminotransferase; AS, asparagine synthetase; ASN, asparagine; GOGAT, NADH-glutamate synthase; GS, glutamine synthetase; α KG, α -ketoglutarate; MDH, malate dehydrogenase; PBM, peribacteroid membrane; PEP, phosphoenolpyruvate; PEPC, phosphoenolpyruvate carboxylase; URI, uricase; XDH, xanthine dehydrogenase.

8. GLUTAMINE SYNTHETASE

Glutamine synthetase (GS) catalyzes the first step in amide biosynthesis through the ATP-dependent conversion of glutamate to glutamine using NH_4^+ as a substrate. The holoenzyme ranges in molecular mass (M_r) from 320-400 kDa and is an octamer of subunits ranging from 38-to-46 kDa M_r . Although the designation of GS isoforms varies between species, there are two main classes, cytosolic GS (GS1) and chloroplast/plastid GS (GS2) (Coruzzi, 2003; Ireland and Lea, 1999). GS1 and GS2 are immunologically and kinetically distinct. GS nomenclature is complex because individual subunits of isozymes can be encoded by different GS genes. For example, chloroplast/plastid GS2 generally occurs as a single homo-octameric isozyme encoded by a single nuclear gene (Coruzzi, 2003; Cren and Hirel, 1999). In comparison, cytosolic GS1 is under the control of three or more genes that, when translated, can result in numerous homo- and hetero-octameric isozymes. The expression of GS isozymes is a function of tissue, environment, N-fertilizer, and C status of the plant. Chloroplast GS has two major roles, the capture of NH_4^+ generated by photorespiration and the assimilation of N derived from nitrate reduction. Although GS2 can be expressed in non-green tissue, especially when plants are grown in the presence of NH_4^+ , cytosolic GS is the predominant form in roots and root nodules.

In pea (*Pisum sativum* L.), root-nodule, root, and leaf-cytosolic GSs are encoded by three distinct genes. A 37-kD cytosolic GS polypeptide is encoded by two genes, which are nearly identical, now termed twin genes *GS3A* and *GS3B* (Tingey *et al.*, 1987); a separate and distinct 38-kD polypeptide is encoded by *GS1*. There is selective expression of specific cytosolic GS genes. Cytosolic *GS3A* and *GS3B*, for example, are highly expressed in both root nodules and the cotyledons of germinating seeds, but *GS3A* is consistently expressed at higher levels than *GS3B*. The predominant form in roots is *GS1*, which is also expressed in nodules but at much lower levels than *GS3A*. Promoter:reporter chimeric gene fusions show highest expression of *GS3A* in nodules, further confirming its role in assimilation of symbiotically fixed N.

GS has been purified from various organs of *P. vulgaris* and antibodies prepared to root-nodule cytosolic GS (Chen and Cullimore, 1988). The cytosolic enzyme in each organ contained various proportions of three isoelectric variants α , β , and γ , which are encoded by three distinct genes designated *gln- α* , *gln- β* , and *gln- γ* . The cytosolic GS genes encode proteins that are about 80-90% identical but are highly divergent in their 5'- and 3'- untranslated regions (Gebhardt *et al.*, 1986). Cytosolic GS activity in leaves involves expression of all three genes with preferential enhancement of the gene encoding the α variant. Similarly, *gln- β* shows preferentially enhanced expression in roots, whereas *gln- γ* is preferentially expressed in nodules. The Gln- γ polypeptide (and its gene) was originally thought to be nodule specific but *gln- γ* mRNAs have been detected in other plant organs. Nodule GS, originally thought to be comprised of equal amounts of the γ and β subunits, may occur as other combinations of these polypeptides. Promoter analysis of *Phaseolus gln- β* and *gln- γ* in transgenic *Lotus corniculatus* shows: (i) that *gln- γ* is preferentially expressed in rhizobial infected cells of nodules; and (ii) that *gln- β*

shows high expression levels in roots. The *gln-β* promoter also directs expression in the nodule cortex and infected cell zone of very young nodules, but is restricted to vascular bundles of older nodules.

In *Medicago*, GS has been evaluated in both the tetraploid out-crossing *M. sativa* (Temple *et al.*, 1995) and the diploid self-compatible *M. truncatula* (Carvalho *et al.*, 2000). Three cytosolic *GS* genes have been identified in *M. truncatula*, *MtGSa*, *MtGSb*, and *MtGSc*. Gene-specific probes and promoter:reporter constructs show that both *MtGSa* and *MtGSb* were induced during development of effective root nodules. Expression of *MtGSa* was greater than that of *MtGSb* in infected cells of nodules, whereas uninfected cells seem to have greater expression of *MtGSb*. Two *GS* genes isolated from alfalfa (*M. sativa*) are orthologs to the *M. truncatula* *GS* genes that show high expression in nodules (Figure 3). The alfalfa *GS13* gene, whose expression is enhanced some 20-fold in nodules, is similar to *MtGSa*, whereas alfalfa *GS100* is more similar to *MtGSb*. *In situ* hybridization experiments with alfalfa nodules showed that *GS13* transcripts predominated in infected cells of nodules.

Efforts to affect plant growth *via* transgenic modification of *GS* have, for the most part, had equivocal results (Mifflin and Habash, 2002), but recent studies with *Medicago* and *Lotus* show that down-regulation of nodule cytosolic *GS* affects asparagine metabolism and may enhance plant growth (Carvalho *et al.*, 2003; Harrison *et al.*, 2003). In both instances, lowering of *GS* expression enhanced AS mRNA expression and tissue asparagine levels, a result only possible if nodule AS could utilize NH_4^+ as a substrate. In the case of *Lotus* plants with lowered nodule *GS*, there was an increase in plant fresh weight. Enhanced plant growth upon lowering nodule *GS* expression was demonstrated some years ago, when alfalfa was treated with a bacterial pathogen that produces a *GS* inhibitor (Knight and Langston-Unkefer, 1988). This finding, however, has been controversial but could offer a giant step in improving plant nitrogen metabolism if proven true.

Although *GS* catalyzes the first committed step in amide biosynthesis, it is unclear whether it is a key to regulating N assimilation. Cytosolic *GS* may be regulated in part by phosphorylation, which seems to be a common regulatory control among many enzymes of N and C metabolism (Mifflin and Habash, 2002). *GS* in nodules is probably not limiting, because it comprises about 1.5-2.0% of the total soluble protein in root nodules and occurs as numerous isozymes. In addition, the expression of *GS* at the enzyme, protein, and mRNA levels is independent of N_2 fixation. Such large amounts of protein occurring as numerous active forms provide a good avenue for molecular compensation to occur.

9. GLUTAMATE SYNTHASE

In higher plants, glutamate synthase (GOGAT) catalyzes the transfer of the amide group from glutamine to α -ketoglutarate to yield two molecules of glutamate (Figure 5), a reaction which, in conjunction with *GS*, is referred to as the *GS/GOGAT* cycle (Ireland and Lea, 1999; Temple *et al.*, 1998). This cycle provides the amino/amide donor for the synthesis of all other amino acids. The

enzyme occurs as two distinct isoforms, NADH-GOGAT (EC 1.4.1.14) and ferredoxin-dependent (Fd) GOGAT (EC 1.2.7.1); these differ in M_r , subunit composition, enzyme kinetics, antigenic specificity, tissue localization, and metabolic function. Fd-GOGAT is an iron-sulfur flavoprotein with a subunit molecular mass of 130-180 kDa that is generally considered to function as a monomer. Studies with *Arabidopsis*, barley, and pea mutants, either lacking Fd-GOGAT or having reduced enzyme activity, show that this form of the enzyme functions in assimilation of NH_4^+ derived from reduction of nitrate and NH_4^+ generated during photorespiration (Coruzzi, 2003; Temple *et al.*, 1998).

NADH-GOGAT, like Fd-GOGAT, is also an iron-sulfur flavoprotein, but found primarily in non-green tissues. NADH-GOGAT has been purified and characterized from legume root nodules and rice cell cultures (Temple *et al.*, 1998). In N_2 -fixing legume nodules, NADH-GOGAT activity and mRNA increase markedly during nodule development (Figure 3) and this increase is associated with a single form of the enzyme. In higher plants, NADH-GOGAT exists as monomers with a native subunit mass of *ca.* 225-230 kDa. There is negligible NADH-GOGAT mRNA, enzyme activity, or enzyme protein in alfalfa leaves and roots. However, alfalfa nodules contain a single NADH-GOGAT isozyme, which increases in activity, protein, and mRNA during effective nodule development (Gregerson *et al.*, 1993). In comparison, bean nodule NADH-GOGAT occurs as two isoforms (I and II) (Chen and Cullimore, 1988), with the observed increase in GOGAT activity during nodule development resulting primarily from an increase in activity of isozyme II. A bean root-nodule cDNA library has yielded two distinct cDNAs for NADH-GOGAT, both of which are highly expressed in bean nodules (M. Lara, L. Blanco, and C. Vance, unpublished data).

Alfalfa NADH-GOGAT has been extensively characterized at the biochemical and molecular level (Gregerson *et al.*, 1993; Vance *et al.*, 1995). The responsible gene encodes a 7.2 kb mRNA, which translates into a deduced 240-kDa protein. N-terminal amino-acid sequence determination showed that the mature protein resulted from a processing event at position 101. The deduced amino-acid sequence of the presequence resembles a plastid and mitochondrial-targeting structure equally. Recent immunogold localization studies show that the enzyme is localized in amyloplasts of infected root-nodule cells (Trepp *et al.*, 1999). The 5'-upstream promoter of the alfalfa gene encoding NADH-GOGAT results in high *GUS*-reporter gene activity in root nodules and pollen. Suppression of NADH-GOGAT expression in alfalfa impairs both C and N assimilation and results in reduced growth and N accumulation, inefficient photosynthesis, ineffective nodules, and pollen sterility (Schoenbeck *et al.*, 2000). By comparison, constitutive ectopic overexpression of nodule NADH-GOGAT in tobacco stimulated growth and dry matter accumulation in plants fed with either NH_4^+ or NO_3^- (Chichkova *et al.*, 2001).

The pivotal role that NADH-GOGAT plays in the assimilation of symbiotically fixed N is reflected in several findings. First, NADH-GOGAT in amide transporters occurs as a single gene encoding a single isozyme; second, the protein comprises 0.1-0.4% of the total nodule soluble protein; third, the enzyme is the junction for

channeling amino-acid synthesis to both glutamine and asparagine; fourth, selection for decreased enzyme activity and the expression of antisense NADH-GOGAT transcripts both have a significant negative effect on plant growth, which can be overcome by nitrate fertilization; and fifth, all other genes involved in primary N and C metabolism are expressed at high levels in ineffective nodules, whereas NADH-GOGAT is not.

10. ASPARTATE AMINOTRANSFERASE

Aspartate aminotransferase (AAT) is a pyridoxal-5'-phosphate-dependent enzyme that catalyzes an essential step in the biosynthesis and degradation of aspartate in all species (Ireland and Lea, 1999). AAT catalyzes the reversible reaction:

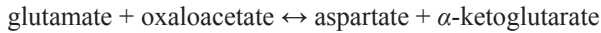

In plants, AAT plays an essential role in several metabolic pathways, including: (i) the transfer of fixed C from mesophyll cells to bundle-sheath cells in C_4 plants, (ii) a malate-aspartate shuttle that distributes reducing equivalents to chloroplasts, mitochondria, and peroxisomes, and (iii) the assimilation of NH_4^+ into aspartate and asparagine. Cytosolic, mitochondrial, plastid, and glyoxysomal forms of the enzyme have been purified from several species, including common bean, carrot, soybean, lupin, *Arabidopsis*, *Panicum*, and alfalfa. AAT is a dimer with a native M_r ranging from 80-94 kDa and subunit M_r s from 40-47 kDa. Antibodies raised against cytosolic, plastid, and mitochondrial forms of AAT are immunologically distinct.

Alfalfa and lupin serve as models for the molecular basis of differential regulation of *AAT* genes in legumes (Farnham *et al.*, 1990; Mett *et al.*, 1994; Yoshioka *et al.*, 1999). In nodules of both species, two AAT isozymes have been studied in detail. *AAT-1* is expressed in leaves, stems, roots, and nodules and consists of a single isoform, whereas *AAT-2* is highly expressed in root nodules with low expression in other tissues (Figure 3). *AAT-1* and *AAT-2* cDNAs, cloned from both alfalfa and lupin, could rescue an *Escherichia coli* aspartate auxotroph. The *AAT-1* transcript is 1.5 kb and encodes a 46-kDa polypeptide (424 amino acids). In comparison, the *AAT-2* transcript is 1.7 kb and encodes a 50-kDa polypeptide (465 amino acids). The M_r of AAT-2 purified from nodules is about 40 kDa.

AAT-2 is synthesized as a preprotein with a presequence of approximately 6-10 kDa. *AAT-2* transcripts are highly expressed in root nodules with slight expression in leaves and cotyledons and little or no expression in roots and stems (Figure 3). Nodules appear to contain 15- to 20-fold more *AAT-2* mRNA and protein than do other tissues. When analyzed by PSort, the N-terminal domain of AAT-2 indicates that the protein is targeted to plastids. Immunogold localization studies localize AAT-2 in amyloplasts of infected cells of alfalfa nodules, whereas AAT-1 is located in the cytosol.

A comparison of the region upstream of the ATG translational initiation codon of *AAT-2* with that of *AAT-1* showed that *AAT-2* contains two sequence motifs

(CTCTT and AAAGAT) that are conserved in several nodule-enhanced genes but absent from *AAT-1*. The sequences have been implicated as *cis*-acting elements necessary for appropriate expression of *N-23* and leghemoglobin genes from soybean. The 5'-upstream promoter of *AAT-2* directs high reporter-gene activity to the infected-cell zone of nodules, whereas the promoter of *AAT-1* is much weaker and shows maximum activity in nodule vascular bundles and parenchyma cells (Yoshioka *et al.*, 1999).

Root-nodule development, effectiveness, and cellular location interact to modulate expression of nodule *AAT-2*. As nodules develop prior to the onset of detectable nitrogenase activity, *AAT-2* activity, protein, and mRNA are expressed. As bacterial nitrogenase is expressed, *AAT-2* expression is further enhanced to maximum levels. In ineffective nodules, *AAT-2* expression shows the initial increase correlated with nodule development, but fails to show the further increase associated with effective nitrogenase. *AAT-1* activity, protein, and mRNA are uniformly present at all stages of nodule development. *In situ* hybridization studies demonstrate that *AAT-2* mRNA is fairly limited to infected cells of nodules, whereas *AAT-1* transcripts occurred in uninfected cells, nodule vascular bundles, and nodule parenchyma. A critical role for *AAT-2* in nodule function and N assimilation has been demonstrated through antisense suppression of *AAT-2* in *Lotus*, which caused decreased enzyme activity, lack of asparagine synthesis, and impaired growth (Mett *et al.*, 1996). A recently characterized common bean-nodule *AAT-2* (Silvente *et al.*, 2003b) showed greater expression under conditions when amides were synthesized rather than ureides. The authors concluded that *AAT-2* may be an important switch in driving metabolic flow through either amide or ureide synthesis in bean nodules.

11. ASPARAGINE SYNTHETASE

Asparagine synthetase (AS) catalyzes the glutamine-dependent amidation of aspartate to asparagine with the simultaneous hydrolysis of ATP to AMP (Ireland and Lea, 1999; Vance, 2000). In *E. coli*, glutamine- and ammonia-dependent AS have both been characterized but whether plants produce an ammonia-dependent AS has not been established. Inhibitor studies and antisense inhibition of GS have shown that asparagine synthesis can occur in some species at low levels when GS is inhibited, implying that an NH_4^+ -dependent AS is present. However, plant AS is quite unstable and the enzyme has been purified extensively only from alfalfa, where two forms apparently occur in nodules, both of them dimers with a M_r of 62-66 kDa. The major form of AS from alfalfa nodules will form asparagine with high concentrations of ammonia as a substrate. Antibodies produced to the major nodule AS recognize a 64-kDa polypeptide, whose expression is highly enhanced during nodule development and which immunoprecipitate AS-enzyme activity from root-nodule extracts.

Although AS cDNAs have been isolated from *Lotus*, bean, and soybean (Hughes *et al.*, 1997; Osuna *et al.*, 2001; Waterhouse *et al.*, 1996), only the gene encoding alfalfa AS has received detailed analysis. A full-length cDNA isolated

from alfalfa nodules encodes a 2.2-kb transcript for 586 deduced amino acids, giving a polypeptide of 66.5 kDa (Shi *et al.*, 1997). The alfalfa nodule AS was 90% similar to those from *P. sativum* *AS1* and *Arabidopsis* *ASN1*. Transcription of *AS* was found to be 20- to 40-fold higher in nodules than in any other tissue (Figure 3). In alfalfa and pea, the nodule-enhanced form of AS was abundant in dark-adapted leaves but rapidly disappeared when leaves were exposed to light. RNA and protein blots showed that AS expression increased in N₂-fixing nodules in conjunction with nitrogenase expression, but was nearly absent in ineffective nodules. *In situ* hybridization analysis showed that ASmRNA was abundant in the infected cells and nodule parenchyma, but little transcript was found in ineffective nodules.

When fused to the *GUS*-reporter gene, the 5'-flanking region of *AS* directed high reporter-enzyme activity to the infected cells of root nodules. Reporter activity was also detected in the vascular bundles, nodule parenchyma, and uninfected cells. Reporter-gene activity was 10- to 50-fold higher in root nodules than in any other tissue.

The lack of *as* mutants precludes any conclusion about the essentiality of the glutamine-dependent enzyme for plant function. Multiple *AS* genes have been characterized from pea, *Lotus*, soybean, *Arabidopsis*, and maize and, thus, the various isoforms may be able to compensate for each other. Strategies, using antisense expression and/or generation of mutants, will be required to explain the functional role of this enzyme in most plant tissues.

The interrelatedness between the expression of nitrogen-assimilating enzymes in both leaves and tubers with sugars and light may be relevant to their expression in nodules (Coruzzi, 2003; Shi *et al.*, 1997). The transcription of N-assimilation genes in leaves seems to be regulated by C:N ratios as a function of leaf metabolism in the light *versus* that in the dark. Plants appear to “sense” low C in the dark and suppress *AS* expression in leaves. In contrast, high C in light signals enhanced *GS* expression and suppression of *AS*. Addition of organic N relieves the dark C-starved suppression of *AS* and conversely reverses the induction of light C-sufficient *GS*. Thus, low C:N stimulates *AS* expression, whereas high C:N stimulates that of *GS*. Similarly, reduced sucrose (C) import into potato tubers stimulates amino-acid synthesis and induces expression of several genes involved in amino-acid synthesis. Although the role of C:N ratios in regulating nodule enzymes of N and C metabolism is not clear, the fact that nodules have high concentrations of both C and N metabolites suggests that metabolic regulation of enzyme expression in nodules will not completely mirror that occurring in other plant organs.

12. UREIDE BIOSYNTHESIS

Most legumes of tropical or sub-tropical origin with determinate nodules transport symbiotically fixed N from nodules to other organs as ureides (Figure 4). Legumes that transport ureides have evolved a complex cellular and subcellular compartmentalization to regulate ureide biosynthesis (Figure 5). Ureide formation is initiated as *de novo* purine biosynthesis in plastids and mitochondria of infected cells (Smith and Atkins, 2002; Tajima *et al.*, 2004). The fixed-N required for purine

biosynthesis is derived directly from glutamine, glycine, and aspartate. In addition to requiring the enzymes of NH_4^+ assimilation, purine biosynthesis requires an additional 10 enzymes (Table 3). After *de novo* synthesis in infected cells, xanthine is oxidized to uric acid, which is then transported to the uninfected cells. In the peroxisomes of uninfected cells, uric acid is oxidized further to the ureides, allantoin and allantoic acid.

Table 3. Enzymes of *de novo* purine biosynthesis^a

Enzyme	EC #	Gene	Deduced AA	Phaseolus Contig #
Phosphoribosyl pyrophosphate amidotransferase (PRAT)	2.4.2.14	<i>pur1</i> , <i>purF</i>	573	2191
Glycinamide ribonucleotide synthetase (GARS)	6.3.4.13	<i>pur2</i> , <i>purD</i>	515	
Glycinamide ribonucleotide transformylase (GART)	2.1.2.2	<i>pur3</i> , <i>purN</i>	305	singleton
Formylglycinamide ribonucleotide amidotransferase (FGARAT)	6.3.5.3	<i>pur4</i> , <i>purL</i>	1100	singleton
Aminoimidazole ribonucleotide synthetase (AIRS)	6.3.3.1	<i>pur5</i> , <i>purM</i>	404	2033
Aminoimidazole ribonucleotide carboxylase (AIRC)	4.1.1.21	<i>pur6</i> , <i>purEK</i>	621	1175
Succinoaminoimidazole-carboxyimide ribonucleotide synthetase (SAICARS)	6.3.2.6	<i>pur7</i> , <i>purC</i>	399	singleton
Adenylosuccinate-AMP lyase (ASAL)	4.3.2.2	<i>pur8</i> , <i>purB</i>	542	674
Aminoimidazolecarboxyimide ribonucleotide transformylase (AICART)	2.1.2.3	<i>pur9/10</i> , <i>purH</i>	612	829
Inosine monophosphate cyclohydrolyase (IMPCH)	3.5.4.10	<i>pur9/10</i> , <i>purH</i>	612	829

^a Data from Smith and Atkins, 2002; Tajima et al., 2004; van der Graaff et al., 2004. Phaseolus contigs and singletons from Ramirez et al., 2005.

Conclusive proof that fixed-N was transported as ureides in soybean was gained by treating nodulated plants with allopurinol, an inhibitor of xanthine dehydrogenase (EC 1.1.7.1.4) (Atkins *et al.*, 1988; Fujihara and Yamaguchi, 1978). Allopurinol-treated plants accumulate xanthine in nodules with a concomitant reduction in allantoin and allantoic acid biosynthesis and transport. It is noteworthy that xanthine dehydrogenase activity is abundant in bean nodules and appears to be located within infected cells. Likewise, antisense suppression of uricase, which catalyzes oxidation of uric acid to allantoin, results in plants showing N-deficiency symptoms and reduced allantoin synthesis (Lee *et al.*, 1993). More recently, an allantoin transporter has been characterized in common bean (Pellissier *et al.*, 2004). Greatest expression of the allantoin transporter occurred in N₂-fixing nodules, whereas ineffective nodules and N fertilizer-treated plants had greatly reduced expression.

The cellular complexity of ureide biosynthesis is evidenced by several findings. First, ureide synthesis is dependent upon the infected cell for purine formation and the uninfected cell for uric-acid oxidation. Second, enzymes of *de novo* purine synthesis are located in both plastids and mitochondria (Atkins and Smith, 2000; Goggin *et al.*, 2003). Third, oxidation of uric acid to allantoin by uricase occurs in peroxisomes of uninfected cells. Fourth, subsequent conversion of allantoin to allantoic acid is associated with the ER. Finally, ureide-transporter mRNAs are highly expressed in the nodule endodermis and vascular bundles. An even greater complexity in ureide-transporting species is that allantoin and allantoic acid are not used directly for N assimilation in sink tissues, such as pods and leaves, but must be catabolized to glyoxylate and urea and then reassimilated through anabolic pathways (Winkler *et al.*, 1988).

Such complexity in the transport of fixed-N begs the question, "What is the evolutionary significance of ureide synthesis and transport of fixed-N in tropical legume species?" It has been argued that, because the ureides have a C:N ratio of 1 and amides have a C:N ratio of 2.0-2.5, they are more efficient to the N economy of the plant, but the complexity of using ureide metabolism offsets any C:N-ratio advantage they may have.

Because the metabolic pathways for ureide biosynthesis and the enzymes catalyzing each step have been addressed in recent reviews (Smith and Atkins, 2002; Tajima *et al.*, 2004; and van der Graaff *et al.*, 2004), only salient features will be mentioned here. Of the ten enzymes involved in *de novo* purine synthesis, seven have been identified in cDNA libraries derived from nodules of ureide-transporting legumes (Chapman *et al.*, 1994; Goggin *et al.*, 2003; Schnorr *et al.*, 1996). Most of the cDNAs that encode the *de novo* purine biosynthesis genes (*pur*), were cloned through complementation of *E. coli pur* mutants. To date, each of the *pur* enzymes found in legumes appears to be synthesized with a preprotein carrying a signal sequence consistent with plastid and/or mitochondrial targeting. Smith *et al.* (1998) have shown that *pur5*, AIR synthase, is targeted to both nodule plastids and mitochondria. All *pur* genes isolated from legumes have highly enhanced expression in nodules (some 5- to 15-fold) as compared to roots. The complete sequencing of the *Arabidopsis* genome has yielded the sequence for the three remaining *pur* genes, which have not as yet been defined in legumes. Recent EST

sequencing of bean root nodules revealed the nucleotide sequence of seven nodule-specific proteins involved in *de novo* purine biosynthesis (Ramirez *et al.*, 2005; Table 3). Compared with the genes involved in amide biosynthesis, those involved in ureide biosynthesis have received scant attention with respect to location of message and protein.

It is surprising that an inosine dehydrogenase (IDH, EC1.1.1.205) gene has not yet been isolated from any legume, particularly because the enzyme is required for ureide synthesis. We recently found a *Phaseolus* IDH gene during EST sequencing of nodules. The IDH contig contained 8 ESTs.

Because *de novo* purine synthesis requires direct incorporation of glycine, one might expect that key enzymes in glycine biosynthesis would be up-regulated in nodules of ureide-producing legumes. This expectation is borne out by the highly enhanced expression of serine hydroxymethyltransferase (EC 2.1.2.1) and other enzymes in the serine/glycine pathway in bean nodules (Ramirez *et al.*, 2005).

The oxidation of uric acid to allantoin is catalyzed by uricase (EC 1.7.3.3) (Lee *et al.*, 1993; Smith and Atkins, 2002; Tajima *et al.*, 2004). This enzyme was originally designated as Nodulin-35 and was among the first nodulins to be characterized. The protein has a M_r of *ca.* 35 kD and its gene contains a 3'-terminal signal sequence that predicts a peroxisome target. Immunocytochemical and *in situ* mRNA-localization studies demonstrate that nodule uricase is located in the peroxisomes of uninfected cells. Reporter-gene constructs that contain the bean nodule-uricase promoter fused to *GUS* show greatest activity in uninfected cells. Uricase transcripts have also been detected in RNA isolated from nodules of the amide-transporting legumes *Lotus* and *Medicago*, but their significance to nodule metabolism in these species is unknown.

13. GENOMIC INSIGHTS

Within the past few years, root-nodule EST-sequencing projects and proteome analysis have yielded a vast storehouse of information on genes and proteins expressed in amide- and ureide-forming species (Lamblin *et al.*, 2003; Quackenbush *et al.*, 2000). In The Institute for Genome Research (TIGR) Gene Indices <http://www.tigr.org/tdb/tgi/>, some 667,000 ESTs are cataloged (as of May 2005) from *Medicago* (227,000), *Lotus* (110,000), and *Glycine* (330,000). These ESTs have been contiged and annotated to yield a unigene set of 36,878, 28,460, and 63,676 for *Medicago*, *Lotus*, and *Glycine*, respectively. Each legume gene index can be queried in several formats, including key word, functional category, GenBank #, EST #, library source, and electronic-expression analysis. Genes that are either expressed specifically in nodules or are highly enhanced in nodules can be identified through computer (*in silico*) expression analysis. For example, a query of the TIGR *M. truncatula* data base, requesting individual tentative consensus sequences (TCs) originating from a specific organ, reveals that 411 TCs are found solely in nodules, whereas 2,000, 422, 300, and 43 originate only from root, leaf, stem, and pod libraries, respectively. The number of ESTs that comprise a TC may indicate the relative expression of that gene TC in a tissue or organ. However, the

expression pattern of genes identified by *in silico* methods must be verified by RNA blots or PCR.

Sequencing nodule ESTs and *in silico* analysis of the transcript profile for *Medicago* (Fedorova *et al.*, 2002; Journet *et al.*, 2002; and El Yahyaoui *et al.*, 2004), *Lotus* (Colebatch *et al.*, 2004; Szczyglowski *et al.*, 1997), *Glycine* (Lee *et al.*, 2004), and *Phaseolus* (Ramirez *et al.*, 2005) show that TCs encoding enzymes involved in N and C metabolism are frequently comprised of numerous ESTs (Table 4). Recent studies of *Phaseolus* nodules show that of the 25 TCs comprised of highly abundant ESTs, 11 encode enzymes related to either C or ureide N metabolism (Ramirez *et al.*, 2005).

Table 4. *Medicago truncatula* nodule enzymes as revealed by *in silico* analysis of the TIGR *Medicago* Gene Index.

Pathway enzyme	Number of TCs	Nodule-enhanced TC identity number	Total ESTs in TC	Nodule-derived ESTs in TC	% EST nodule
<i>Carbon metabolism</i>					
Hexose transporter	7	107287	26	17	65
Sucrose synthase	7	100410	213	83	39
PEP carboxylase	11	107075	25	8	33
Carbonic anhydrase	11	100150	102	99	97
Malate dehydrogenase	10	101675	12	8	66
Fructokinase	9	94345	93	51	55
<i>Nitrogen assimilation</i>					
Glutamine synthetase	8	106729	106	58	50
Glutamate synthase (NADH)	2	94780	32	1	3
Asparagine synthetase	5	100391	79	24	30
Aspartate aminotransferase	2	106918	50	4	8
Glutamate dehydrogenase	5	94778	20	2	10
Alanine aminotransferase	2	100696	31	6	19

Surprisingly, however, ESTs, which code for some enzymes that are required for C and N assimilation, are not found or occur in very low frequency in genome-wide EST profiling. For example, to date, very few ESTs encoding NADH-GOGAT, AAT-isozyme 2, hexokinase, glutamate dehydrogenase, and inosine monophosphate cyclohydrolyase have been identified. This may relate to the significance that these genes play in regulating pathways. Both NADH-GOGAT

and hexokinase have been implicated as key regulators of N and C signaling and metabolism.

Nodule-proteome analysis complements and is consistent with EST profiling in that several plant proteins that catalyze reactions related to nodule N and C metabolism have been identified as expressed during symbiosis (Catalano *et al.*, 2004; Natera *et al.*, 2000; Saalbach *et al.*, 2002; Wienkoop and Saalbach, 2003). To date, proteome analysis has tended to identify the most abundant proteins in an organ or tissue. However, as proteomic technology progresses, this powerful tool will allow us to identify less abundant proteins and numerous types of post-translational modifications that occur in expressed proteins.

A challenge facing modern biologists is how to effectively utilize the massive amount of data that can and will be generated through whole genome sequencing, transcript profiling, and proteome analysis. Fundamental objectives may include: (i) enhanced gene identification and functional analysis by comparisons of wild-type plants with those having single gene changes; (ii) functional characterization of genes through directed gene silencing; (iii) definition of the genetic and molecular components that underpin metabolic and developmental pathways; (iv) identification of protein complexes that catalyze pathways; and (v) designing new pathways to improve plant adaptation to stress.

14. OVERVIEW

Symbiotic root nodules are in essence highly integrated factories for C utilization and N assimilation. Significant progress has been made in the physical, biochemical, and molecular characterization of the primary enzymes involved in C utilization and amide-N assimilation. Recent advances in genomic methods in *Glycine* and *Phaseolus* have opened the doors for similar progress to be made on many of the enzymes involved in legume ureide-N metabolism. Our understanding of the biochemical and molecular components involved in root-nodule N and C metabolism is growing at a logarithmic pace. However, we remain challenged in understanding how the plant and bacteria integrate and regulate information into a coherent model(s) that defines growth and development. Identifying how the integration of N and C is balanced between symbiont and host requires that multidisciplinary approaches be encouraged and supported. Even more importantly, we will need to translate our advances at the fundamental level into plant improvement. The *gen-*, *prote-*, *metabol-*, and *transcript-* omics era will give unimaginable insights into symbiotic N₂ fixation. To utilize these insights and improve the well being of humankind through food security and nutrition will require exceptional communication as well as exceptional science.

REFERENCES

- Atkins, C. A., Sanford, P. J., Storer, P. J., and Pate, J. S. (1988). Inhibition of nodule functioning in cowpea by a xanthine oxidoreductase inhibitor, allopurinol. *Plant Physiol.*, 88, 1229-1234.

- Atkins, C. A., and Smith, P. M. C. (2000). Ureide synthesis in legume nodules. In E. J. Triplett (Ed.), *Prokaryotic nitrogen fixation: A model system for the analysis of a biological process* (pp. 559-587). Wymondham, UK: Horizon Scientific Press.
- Atkins, C. A., Smith, P., Mann, A., and Thumfort, P. (2001). Localization of carbonic anhydrase in legume nodules. *Plant Cell Environ.*, *24*, 317-326.
- Carvalho, H., Lescure, N., de Billy, F., Chabaud, M., Lima, L., Salema, R., *et al.* (2000). Cellular expression and regulation of the *Medicago truncatula* cytosolic glutamine synthetase genes in root nodules. *Plant Mol. Biol.*, *42*, 741-756.
- Carvalho, H. G., Lopes-Cardoso, I. A., Lima, L. M., Melo, P. M., and Cullimore, J. V. (2003). Nodule specific modulation of glutamine synthetase in transgenic *Medicago truncatula* leads to inverse alterations in asparagine synthetase expression. *Plant Physiol.*, *133*, 243-252.
- Catalano, C., Lane, W. S., and Sherrier, D. J. (2004). Biochemical characterization of symbiosome membrane proteins from *Medicago truncatula* root nodules. *Electrophoresis*, *25*, 519-531.
- Chapman, K. A., Delauney, A. J., Kim, J. H., and Verma, D. P. S. (1994). Structural organization of *de novo* purine biosynthesis enzymes in plants: 5-aminoimidazole ribonucleotide carboxylase and 5-aminoimidazole-4-*N*-succinocarboxamide ribonucleotide synthetase cDNAs from *Vigna aconitifolia*. *Plant Mol. Biol.*, *24*, 389-395.
- Chen, F. L., and Cullimore, J. V. (1988). Two isoenzymes of NADH-dependent glutamate synthase in root nodules of *Phaseolus vulgaris* L.: Purification, properties and activity changes during nodule development. *Plant Physiol.*, *88*, 1411-1417.
- Chichkova, S., Arellano, J., Vance, C. P., and Hernandez, G. (2001). Transgenic tobacco plants that overexpress alfalfa NADH-glutamate synthase have higher carbon and nitrogen content. *J. Exp. Bot.*, *52*, 2079-2087.
- Chollet, R., Vidal, J., and O'Leary, M. H. (1996). Phosphoenolpyruvate carboxylase: A ubiquitous, highly regulated enzyme in plants. *Annu. Rev. Plant Physiol. Plant Mol. Biol.*, *47*, 273-298.
- Colebatch, G., Desbrosses, G., Ott, T., Krusell, L., Montanari, O., Kloska, S., *et al.* (2004). Global changes in transcription orchestrate metabolic differentiation during symbiotic nitrogen fixation in *Lotus japonicus*. *Plant J.*, *39*, 487-512.
- Copeland, L., Lee, H.-S., and Cowlshaw, N. (1995). Carbon metabolism in chickpea nodules. *Soil Biol. Biochem.*, *27*, 381-385.
- Copeland, L., Vella, J., and Hong, Z.-Q. (1989). Enzymes of carbohydrate metabolism in soybean nodules. *Phytochemistry*, *28*, 57-61.
- Coruzzi, G. (2003). Primary N-assimilation into amino acids in *Arabidopsis*. In C. R. Somerville and E. M. Meyerowitz (Eds.), *The Arabidopsis book*, Vol. 31 (pp. 1-17). Rockville, MD: American Society of Plant Biologists.
- Craig, J., Barratt, P., Tatge, H., Dejardin, A., Handley, L., Gardner, C. D., *et al.* (1999). Mutations at the *rug4* locus alter the carbon and nitrogen metabolism of pea plants through an effect on sucrose synthase. *Plant J.*, *17*, 353-362.
- Cren, M., and Hirel, B. (1999). Glutamine synthetase in higher plants: Regulation of gene and protein expression from the organ to the cell. *Plant Cell Physiol.*, *40*, 1187-1193.
- Dart, P. (1977). Infection and development of legume nodules. In R. W. F. Hardy and W. S. Silver (Eds.), *A treatise on nitrogen fixation*, Vol. III, *Biology* (pp. 367-472). New York, NY: Wiley Interscience.
- Day, D. A., and Copeland, L. (1991). Carbon metabolism and compartmentation in nitrogen-fixing legume nodules. *Plant Physiol. Biochem.*, *29*, 185-201.
- de la Pena, T. C., Frugier, F., McKhann, H. I., Bauer, P., Brown, S., Kondorosi, A., *et al.* (1997). A carbonic anhydrase gene is induced in the nodule primordium and its cell-specific expression is controlled by the presence of *Rhizobium* during development. *Plant J.*, *11*, 407-420.
- Delwiche, C. C. (1970). The nitrogen cycle. *Sci. Amer.*, *223*, 136-146.
- Egli, M. A., Griffith, S. M., Miller, S. S., Anderson, M. P., and Vance, C. P. (1989). Nitrogen assimilating enzyme activities and enzyme protein during development and senescence of effective and plant gene-controlled ineffective alfalfa nodules. *Plant Physiol.*, *91*, 898-904.
- El Yahyaoui, F., Kuster, H., Amor, B. B., Hohnjec, N., Pühler, A., Becker, A., *et al.* (2004). Expression profiling in *Medicago truncatula* identifies more than 750 genes differentially expressed during nodulation, including many potential regulators of the symbiotic program. *Plant Physiol.*, *136*, 3159-3176.

- Farnham, M. W., Miller, S. S., Griffith, S. M., and Vance, C. P. (1990). Aspartate aminotransferase in alfalfa root nodules. II. Immunological distinction between two forms of the enzyme. *Plant Physiol.*, *93*, 603-610.
- Fedorova, M., Tikhonovich, I. A., and Vance, C. P. (1999). Expression of C-assimilating enzymes in pea (*Pisum sativum*) root nodules. *In situ* localization in effective nodules. *Plant Cell Environ.*, *22*, 1249-1262.
- Fedorova, M., van de Mortel, J., Matsumoto, P. A., Cho, J., Town, C. D., VandenBosch, K. A., *et al.* (2002). Genome-wide identification of nodule-specific transcripts in the model legume *Medicago truncatula*. *Plant Physiol.*, *130*, 519-537.
- Fujihara, S., and Yamaguchi, M. (1978). Effects of allopurinol [4-hydroxyprazolo(3, 4-d)pyrimidine] on the metabolism of allantoin in soybean plants. *Plant Physiol.*, *62*, 134-138.
- Galvez, S., Hirsch, A. M., Wycoff, K. L., Hunt, S., Layzell, D. B., Kondorosi, A., *et al.* (2000). Oxygen regulation of a nodule-located carbonic anhydrase in alfalfa. *Plant Physiol.*, *124*, 1059-1068.
- Gebhardt, C., Oliver, J. E., Forde, B. G., Saarelainen, R., and Mifflin, B. J. (1986). Primary structure and differential expression of glutamine synthetase genes in nodules, roots, and leaves of *Phaseolus vulgaris*. *EMBO J.*, *5*, 1429-1435.
- Gietl, C. (1992). Malate dehydrogenase isoenzymes: Cellular locations and role in the flow of metabolites between the cytoplasm and cell organelles. *Biochim. Biophys. Acta.*, *1100*, 217-234.
- Goggin, D. E., Lipscombe, R., Fedorova, E., Millar, A. H., Mann, A., Atkins, C. A., *et al.* (2003). Dual intracellular localization and targeting of aminoimidazole ribonucleotide synthetase in cowpea. *Plant Physiol.*, *131*, 1033-1041.
- Gordon, A. J., Minchin, F. R., James, C. L., and Komina, O. (1999). Sucrose synthase in legume nodules is essential for nitrogen fixation. *Plant Physiol.*, *120*, 867-877.
- Gordon, A. J., Ryle, G. J. A., Mitchell, D. F., and Powell, C. E. (1985). The flux of ¹⁴C-labeled photosynthate through soybean root nodules during N₂ fixation. *J. Exp. Bot.*, *36*, 756-769.
- Gregerson, R. G., Miller, S. S., Twary, S. N., Gantt, J. S., and Vance, C. P. (1993). Molecular characterization of NADH-dependent glutamate synthase from alfalfa nodules. *Plant Cell*, *5*, 215-226.
- Groat, R. G., and Vance, C. P. (1982). Root and nodule enzymes of ammonia assimilation in two plant-conditioned symbiotically ineffective genotypes of alfalfa (*Medicago sativa* L). *Plant Physiol.*, *69*, 614-618.
- Harrison, J., Pou de Crescenzo, M.-A., Sene, O., and Hirel, B. (2003). Does lowering glutamine synthetase activity in nodules modify nitrogen metabolism and growth of *Lotus japonicus*? *Plant Physiol.*, *133*, 253-262.
- Hata, S., Izui, K., and Kouchi, H. (1998). Expression of a soybean nodule-enhanced phosphoenolpyruvate carboxylase gene that shows striking similarity to another gene for a house-keeping isoform. *Plant J.*, *13*, 267-273.
- Hohnjec, N., Becker, J. D., Pühler, A., Perlick, A. M., and Küster, H. (1999). Genomic organization and expression properties of the *MtSuc1* gene which encodes a nodule enhanced sucrose synthase in the model legume *Medicago truncatula*. *Mol. Gen. Genet.*, *261*, 514-522.
- Hohnjec, N., Perlick, A. M., Pühler, A., and Küster, H. (2003). The *Medicago truncatula* sucrose synthase gene *MtSuc1* is activated both in the infected region of root nodules and in the cortex of roots colonized by arbuscular mycorrhizal fungi. *Mol. Plant-Microbe Interact.*, *16*, 903-915.
- Hughes, C. A., Beard, H. S., and Matthews, B. F. (1997). Molecular cloning and expression of two cDNAs encoding asparagine synthetase in soybean. *Plant Mol. Biol.*, *33*, 301-311.
- Imsande, J., Berkemeyer, M., Scheibe, R., Schumann, U., Gietl, C., and Palmer, R. G. (2001). A soybean plastid targeted NADH-malate dehydrogenase: Cloning and expression analysis. *Amer. J. Bot.*, *88*, 2136-2142.
- Ireland, R. J., and Lea, P. J. (1999). The enzymes of glutamine, asparagine, and aspartate metabolism. In B. K. Singh (Ed.), *Plant amino acids* (pp. 49-109). New York, NY: Marcel Dekker.
- Irigoyen, J. J., Sanchez-Diaz, M., and Emerich, D. W. (1990). Carbon metabolism enzymes of *Rhizobium meliloti* cultures and bacteroids and their distribution within alfalfa nodules. *Appl. Environ. Microbiol.*, *56*, 2587-2589.
- Journet, E.-P., van Tuinen, D., Gouzy, J., Crespeau, H., Carreau, V., Farmer, M. J., *et al.* (2002). Exploring root symbiotic programs in the model legume *Medicago truncatula* using EST analysis. *Nucleic Acids Res.*, *30*, 5579-5592.

- Kaiser, B. N., Finnegan, P. M., Tyerman, S. D., Whitehead, L. F., Bergersen, F. J., Day, D. A., *et al.* (1998). Characterization of an ammonium transport protein from the peribacteroid membrane of soybean nodules. *Science*, *281*, 1202-1206.
- Kavroulakis, N., Fletmetakis, E., Aivalakis, G., Dahiya, P., Brewin, N. J., Fasseas, K., *et al.* (2003). Tissue distribution and subcellular localization of carbonic anhydrase in mature soybean root nodules indicates a role in CO₂ diffusion. *Plant Physiol. Biochem.*, *41*, 479-484.
- King, B. J., Layzell, D. B., and Canvin, D. T. (1986). The role of dark carbon dioxide fixation in root nodules of soybean. *Plant Physiol.*, *81*, 200-205.
- Knight, T. J., and Langston-Unkefer, P. J. (1988). Enhancement of symbiotic dinitrogen fixation by a toxin-releasing plant pathogen. *Science*, *241*, 951-954.
- Komina, O., Zhou, Y., Sarath, G., and Chollet, R. (2002). *In vivo* and *in vitro* phosphorylation of membrane and soluble forms of soybean nodule sucrose synthase. *Plant Physiol.*, *129*, 1664-1673.
- Kouchi, H., Fukai, K., Katagiri, H., Minamisawa, K., and Tajima, S. (1988). Isolation and enzymological characterization of infected and uninfected cell protoplasts from root nodules of *Glycine max.* *Physiol. Plant.*, *73*, 327-334.
- Lamblin, A.-F. J., Crow, J. A., Johnson, J. E., Silverstein, K. A. T., Kunau, T. M., Kilian, A., *et al.* (2003). MtDB: A database for personalized data mining of the model legume *Medicago truncatula* transcriptome. *Nucleic Acids Res.*, *31*, 196-201.
- Lee, H. L., Hur, C.-G., Oh, C. J., Kim, H. B., Park, S. Y., and An, C. S. (2004). Analysis of the root nodule-enhanced transcriptome in soybean. *Mol. Cells*, *18*, 53-62.
- Lee, N. G., Stein, B., Suzuki, H., and Verma, D. P. S. (1993). Antisense expression of nodulin-35 RNA in *Vigna aconitifolia* root nodules retards peroxisome development and affects nitrogen availability to the plant. *Plant J.*, *3*, 599-606.
- Lodwig, E. M., Hosie, A. H. F., Bourdes, A., Findlay, K., Allaway, D., Karanakaran, R., *et al.* (2003). Amino-acid cycling drives nitrogen fixation in the legume-*Rhizobium* symbiosis. *Nature*, *422*, 722-726.
- Meeks, J. C., Wolk, P. C., Schilling, N., Shaffer, P. W., Avissar, Y., and Chien, W. S. (1978). Initial organic products of fixation of ¹⁵N dinitrogen by root nodules of soybean (*Glycine max.*) *Plant Physiol.*, *61*, 980-983.
- Mett, V., Mett, V. L., and Reynolds, P. H. S. (1994). The aspartate aminotransferase-P₂ gene from *Lupinus angustifolius*. *Plant Physiol.*, *106*, 1683-1684.
- Mett, V. L., Podivinsky, E., Tennant, A. M., Lochhead, L. P., Jones, W. T., and Reynolds, P. H. S. (1996). A system for tissue-specific copper-controllable gene expression in transgenic plants: Nodule specific antisense of aspartate aminotransferase P-2. *Transgenic Res.*, *5*, 105-113.
- Mifflin, B. J., and Habash, D. Z. (2002). The role of glutamine synthetase and glutamate dehydrogenase in N assimilation and possibilities for improvement in nitrogen utilization by crops. *J. Exp. Bot.*, *53*, 979-987.
- Miller, S. S., Driscoll, B. T., Gregerson, R. G., Gantt, J. S., and Vance, C. P. (1998). Alfalfa malate dehydrogenase (MDH): Molecular cloning and characterization of five different forms reveals a unique nodule-enhanced MDH. *Plant J.*, *15*, 173-184.
- Nakagawa, T., Izumi, T., Banba, M., Umehara, Y., Kouchi, H., Izui, K., and Hata, S. (2003). Characterization and expression analysis of genes encoding phosphoenolpyruvate carboxylase and phosphoenolpyruvate carboxylase kinase of *Lotus japonicus*, a model legume. *Mol. Plant-Microbe Interact.*, *16*, 281-288.
- Natera, S. H. A., Guerreiro, N., and Djordjevic, M. A. (2000). Proteome analysis of differentially displayed proteins as a tool for the investigation of symbiosis. *Mol. Plant-Microbe Interact.*, *13*, 995-1009.
- Osuna, D., Galvez-Valdivieso, G., Piedras, P., Pineda, M., and Aguilar, M. (2001). Cloning, characterization and mRNA expression analysis of *PVas1* a type 1 asparagine synthetase gene from *Phaseolus vulgaris*. *Planta*, *13*, 402-410.
- Pathirana, M. S., Samac, D. A., Roeven, R., Yoshioka, H., Vance, C. P., and Gantt, J. S. (1997). Analyses of phosphoenolpyruvate carboxylase gene structure and expression in alfalfa nodules. *Plant J.*, *12*, 293-304.
- Pellissier, H. C., Frerich, A., Desimone, M., Schumacher, K., and Tegeder, M. (2004). PvUPS1, an allantoin transporter in nodulated roots of French bean. *Plant Physiol.*, *134*, 664-675.
- Phillips, D. A. (1980). Efficiency of symbiotic nitrogen fixation in legumes. *Annu. Rev. Plant Physiol.*, *31*, 29-49.

- Quackenbush, J., Liang, F., Holt, I., Perlea, G., and Upton, J. (2000). The TIGR gene indices: Reconstruction and representation of expressed gene sequences. *Nucleic Acids Res.*, 28, 141-145.
- Ramirez, M., Graham, M. A., Blanco-Lopez, L., Silvente, S., Medrano-Soto, A., *et al.* (2005). Sequencing and analysis of common bean ESTs. Building a foundation for functional genomics. *Plant Physiol.*, 137, 1211-1227.
- Robinson, D. L., Trepp, G. B., Gregerson, R. G., Twary, S. N., Roeven, R., Gantt, J. S., *et al.* (1999). Cloning and developmental expression of a nodule-enhanced sucrose synthase cDNA from alfalfa. In E. Martinez and G. Hernandez (Eds.), *Highlights of nitrogen fixation research* (pp. 23-31). Dordrecht, The Netherlands: Kluwer Academic Publishers/Plenum Press.
- Rosendahl, L., Vance, C. P., and Pederson, W. B. (1990). Products of dark CO₂ fixation in pea root nodules support bacteroid metabolism. *Plant Physiol.*, 93, 12-19.
- Saalbach, G., Erik, P., and Wienkoop, S. (2002). Characterization by proteomics of peribacteroid space and peribacteroid membrane preparations from pea (*Pisum sativum*) symbiosomes. *Proteomics*, 2, 325-337.
- Scharff, A. M., Egsgaard, H., Hansen, P. E., and Rosendahl, L. (2003). Exploring symbiotic nitrogen fixation and assimilation in pea root nodules by *in vivo* ¹⁵N nuclear magnetic resonance spectroscopy and liquid chromatography-mass spectrometry. *Plant Physiol.*, 131, 367-378.
- Schnorr, K. M., Laloue, M., and Hirel, B. (1996). Isolation of cDNAs encoding two purine biosynthetic enzymes of soybean and expression of the corresponding transcripts in roots and root nodules. *Plant Mol. Biol.*, 32, 751-757.
- Schoenbeck, M. A., Temple, S. J., Trepp, G. B., Blumenthal, J. M., Samac, D. A., Gantt, J. S., *et al.* (2000). Decreased NADH glutamate synthase activity in nodules and flowers of alfalfa (*Medicago sativa* L.) transformed with an antisense glutamate synthase transgene. *J. Exp. Bot.*, 51, 29-39.
- Schubert, K. R. (1982). The energetics of biological nitrogen fixation. In *Workshop summaries 1*. Rockville, MD: American Society of Plant Physiologists (30 pp.).
- Schulze, J., Shi, L.-F., Blumenthal, J., Samac, D. A., Gantt, J. S., and Vance, C. P. (1998). Inhibition of alfalfa root nodule phosphoenolpyruvate carboxylase through an antisense strategy impacts nitrogen fixation and plant growth. *Phytochemistry*, 49, 341-346.
- Schulze, J., Tesfaye, M., Litjens, R. H. M. G., Bucciarelli, B., Trepp, G., Miller, S., *et al.* (2002). Malate plays a central role in plant nutrition. *Plant Soil*, 247, 133-139.
- Shi, L.-F., Twary, S. N., Yoshioka, H., Gregerson, R. G., Miller, S. S., Samac, D. A., *et al.* (1997). Nitrogen assimilation in alfalfa: Isolation and characterization of an asparagine synthetase gene showing enhanced expression in root nodules and dark-adapted leaves. *Plant Cell*, 9, 1339-1356.
- Silvente, S., Camas, A., and Lara, M. (2003a). Heterogeneity of sucrose synthase genes in bean (*Phaseolus vulgaris* L.): Evidence for a nodule-enhanced sucrose synthase gene. *J. Exp. Bot.*, 54, 749-755.
- Silvente, S., Camas, A., and Lara, M. (2003b). Molecular cloning of the cDNA encoding aspartate aminotransferase from bean root nodules and determination of its role in nitrogen metabolism. *J. Exp. Bot.*, 54, 1545-1551.
- Smith, P. M. C., Mann, A. J., Goggin, D. E., and Atkins, C. A. (1998). AIR synthetase in cowpea nodules: A single gene product targeted to two organelles? *Plant Mol. Biol.* 36, 811-820.
- Smith, P. M. C., and Atkins, C. A. (2002). Purine biosynthesis. Big in cell division, even bigger in nitrogen assimilation. *Plant Physiol.*, 128, 793-802.
- Sprent, J. I. (1980). Root nodule anatomy, type of export product, and evolutionary origin in some Leguminosae. *Plant Cell Environ.*, 3, 35-43.
- Streeter, J. G. (1980). Carbohydrates in soybean nodules. II. Distribution of compounds in seedlings during the onset of nitrogen fixation. *Plant Physiol.*, 66, 471-476.
- Szczyglowski, K., Hamburger, D., Kapronov, P., and de Bruijn, F. J. (1997). Construction of a *Lotus japonicus* late nodulin expressed sequence tag library and identification of novel nodule-specific genes. *Plant Physiol.*, 114, 1335-1346.
- Ta, T.-C., Faris, M. A., and Macdowall, F. D. H. (1986). Pathways of nitrogen metabolism in nodules of alfalfa (*Medicago sativa* L.). *Plant Physiol.*, 80, 1002-1005.
- Tajima, S., Nomura, M., and Kouchi, H. (2004). Ureide biosynthesis in legume nodules. *Front. Biosci.*, 9, 1374-1381.
- Tajima, S., Takane, K., Nomura, M., and Kouchi, H. (2000). Symbiotic nitrogen fixation at the late stage of nodule formation in *Lotus japonicus* and other legume plants. *J. Plant Res.*, 113, 467-473.

- Temple, S. J., Heard, J., Ganter, J., Dunn, K., and Sengupta-Gopalan, C. (1995). Characterization of a nodule-enhanced glutamine synthetase from alfalfa: Nucleotide sequence, *in situ* localization, and transcript analysis. *Mol. Plant-Microbe Interact.*, *8*, 218-227.
- Temple, S. J., Vance, C. P., and Gantt, J. S. (1998). Glutamate synthase and nitrogen assimilation. *Trends Plant Sci.*, *3*, 51-56.
- Thummler, F., and Verma, D. P. S. (1987). Nodulin-100 of soybean is the subunit of sucrose synthase regulated by availability of free heme in nodules. *J. Biol. Chem.*, *262*, 14730-14736.
- Tingey, S. V., Walker, E. L., and Coruzzi, G. M. (1987). Glutamine synthetase genes of pea encode distinct polypeptides which are differentially expressed in leaves, roots and nodules. *EMBO J.*, *6*, 1-9.
- Trepp, G. B., van de Mortel, M., Yoshioka, H., Miller, S. S., Samac, D. A., Gantt, J. S., *et al.* (1999). NADH-glutamate synthase in alfalfa root nodules. Genetic regulation and cellular expression. *Plant Physiol.*, *119*, 817-828.
- Udvardi, M. K., and Day, D. A. (1997). Metabolite transport across symbiotic membranes of legume nodules. *Annu. Rev. Plant Physiol. Plant Mol. Biol.*, *48*, 493-523.
- Vance, C. P. (2000). Amide biosynthesis in root nodules of temperate legumes. In E. W. Triplett (Ed.), *Prokaryotic nitrogen fixation: A model system for analysis of a biological process* (pp. 589-608). Wymondham, UK: Horizon Scientific Press.
- Vance, C. P., Gregerson, R. G., Robinson, D. L., Miller, S. S., and Gantt, J. S. (1994). Primary assimilation of nitrogen in alfalfa nodules: Molecular features of the enzymes involved. *Plant Sci.*, *101*, 51-64.
- Vance, C. P., and Heichel, G. H. (1991). Carbon in N₂ fixation: Limitation or exquisite adaptation. *Annu. Rev. Plant Physiol. Plant Mol. Biol.*, *42*, 373-390.
- Vance, C. P., Miller, S. S., Driscoll, B. T., Robinson, D. L., Trepp, G. B., Gantt, J. S., *et al.* (1997). Nodule carbon metabolism: Organic acids for N₂ fixation. In C. Elmerich, A. Kondorosi, and W. E. Newton (Eds.), *Biological nitrogen fixation for the 21st century* (pp. 443-448). Dordrecht, The Netherlands: Kluwer Academic Publishers.
- Vance, C. P., Miller, S. S., Gregerson, R. G., Samac, D. A., Robinson, D. L., and Gantt, J. S. (1995). Alfalfa NADH-dependent glutamate synthase: Structure of the gene and importance in symbiotic N₂ fixation. *Plant J.*, *8*, 345-358.
- van der Graaf, E., Hooykas, P., Lein, W., Lerchl, J., Kunze, G., Sonnewald, U., *et al.* (2004). Molecular analysis of "de novo" purine biosynthesis in solanaceous species and in *Arabidopsis thaliana*. *Front. Biosci.*, *9*, 1803-1816.
- Waterhouse, R. N., Smyth, A. J., Massonneau, A., Prosser, I. M., and Clarkson, D. T. (1996). Molecular cloning and characterization of asparagine synthetase from *Lotus japonicus*: Dynamics of asparagine synthesis in N-sufficient conditions. *Plant Mol. Biol.*, *30*, 883-897.
- Waters, J. K., Hughes, B. L., Purcell, L. C., Gerhardt, K. O., Mawhinney, T. P., and Emerich, D. W. (1998). Alanine, not ammonia, is excreted from N₂-fixing soybean nodule bacteroids. *Proc. Natl. Acad. Sci. USA*, *95*, 12038-12042.
- Wienkoop, S., and Saalbach, G. (2003). Proteome analysis. Novel proteins identified at the peribacteroid membrane from *Lotus japonicus* root nodules. *Plant Physiol.*, *131*, 1080-1090.
- Winkler, R. G., Blevins, D. G., Polacco, J. C., and Randall, D. D. (1988). Ureide catabolism in nitrogen fixing legumes. *Trends Biochem Sci.*, *13*, 97-100.
- Winter, H., Huber, J. L., and Huber, S. C. (1997). Membrane association of sucrose synthase: Changes during the graviresponse and possible control by protein phosphorylation. *FEBS Lett.*, *420*, 151-155.
- Xu, W., Zhou, Y., and Chollet, R. (2003). Identification and expression of a soybean nodule-enhanced PEP-carboxylase kinase gene (NE-Ppck) that shows striking up-/down-regulation *in vivo*. *Plant J.*, *34*, 441-452.
- Yoshioka, H., Gregerson, R. G., Samac, D. A., Hoevens, K. C. M., Trepp, G. B., Gantt, J. S., *et al.* (1999). Aspartate aminotransferase in alfalfa nodules: Localization of mRNA during effective and ineffective nodule development and promoter analysis. *Mol. Plant-Microbe Interact.*, *12*, 263-274.
- Zhang, X.-Q., and Chollet, R. (1997). Seryl-phosphorylation of a soybean nodule sucrose synthase (nodulin-100) by a Ca²⁺-dependent protein kinase. *FEBS Lett.*, *410*, 126-130.

Chapter 11

OXYGEN DIFFUSION, PRODUCTION OF REACTIVE OXYGEN AND NITROGEN SPECIES, AND ANTIOXIDANTS IN LEGUME NODULES

F. R. MINCHIN¹, E. K. JAMES², AND M. BECANA³

¹*Institute for Grassland and Environmental Research,
Aberystwyth SY23 3EB, Wales, UK.*

²*School of Life Sciences, University of Dundee,
Dundee DD1 5EH, Scotland, UK.*

³*Estación Experimental de Aula Dei,
CSIC, Aptdo 202, 50080 Zaragoza, Spain.*

1. INTRODUCTION

This review follows the terminology of Minchin (1997) for determinate and lupinoid nodules and that of Vasse *et al.* (1990) for indeterminate nodules. Thus, in “typical” determinate nodules, such as those of soybean (*Glycine max*), as well as in indeterminate lupinoid nodules, a central zone of bacteroid-containing “infected cells”, which may be interspersed with smaller, uninfected “interstitial” cells, is surrounded by a multi-layered cortex. Next to the infected zone is an inner cortex (or “nodule parenchyma”; Van de Wiel *et al.*, 1990a) that consists of a distribution zone of small cells, often with large intercellular spaces and a boundary layer (BL) of closely-packed cells with no apparent traversing intercellular spaces. Next is a mid-cortex of large cells with thickened but un lignified cell walls, then a common endodermis/scleroid layer, which appears to form a second boundary layer (Brown and Walsh, 1994; Iannetta *et al.*, 1995). The final outer cortex has large loosely packed cells, with large intercellular spaces, sometimes surrounded by a periderm. A gaseous connection between the outer cortex is achieved either by large

intercellular spaces in the periderm or “eruptions” of outer cortical cells to form a very loosely-packed lenticel system. In soybean, the lenticel lines tend to overlay the vascular strands, which lie between the mid and inner cortex, and “close up” under water stress (Pankhurst and Sprent, 1975).

In contrast, “typical” indeterminate nodules, such as those of pea (*Pisum sativum*), alfalfa (*Medicago sativa*), and broad bean (*Vicia faba*), have a persistent meristem and, in longitudinal section, can be divided into four zones: (i) the meristem at the nodule tip; (ii) the invasion zone immediately behind the meristem with newly-divided cells being invaded by rhizobial-containing infection threads; (iii) the N₂-fixing zone, where the cells contain fully differentiated bacteroids; and (iv) the senescent zone, closest to the point where the nodule is attached to the root (Brewin, 1991; Soupene *et al.*, 1995; Vasse *et al.*, 1990). Indeterminate nodules also have an inner cortex/nodule parenchyma, which contains vascular bundles that extend from the proximal end to near the meristematic tissue, and which is separated from the nodule outer cortex by a suberised endodermal cell layer. However, nodules of other legumes may vary in detail from these “typical” structures (Brown and Walsh, 1994; 1996).

1.1. The “Oxygen Paradox”

The requirement of O₂ for bacteroid respiration to meet the high ATP demand of nitrogenase activity *versus* the inhibitory effects of free O₂ on nitrogenase is often referred to as the “O₂ paradox” of N₂-fixing legume nodules, but this is almost certainly simplistic. Firstly, bacteroids may offer partial protection to their nitrogenase through conformational changes (Denison *et al.*, 1992) as occurs in the free-living *Azotobacter* (Robson and Postgate, 1980). Secondly, the potential for the production of reactive oxygen species (ROS) within the bacteroid-containing zone of legume nodules is large (see, *e.g.*, Dalton *et al.*, 1993; Matamoros *et al.*, 2003b). So, if the antioxidant protection in this zone is optimal for a microaerobic reducing environment, any major rise in O₂ ingress would rapidly overwhelm it, leading to large-scale cellular damage well beyond nitrogenase inactivation. Indeed, such oxidative stress has been linked to senescence of legume nodules (Evans *et al.*, 1999; Hernández-Jiménez *et al.*, 2002). Thus, there is probably a close link to be explored between antioxidant defences and the requirement for regulated O₂ diffusion within legume nodules.

1.2. Production of Reactive Oxygen and Nitrogen Species

The partial reduction of O₂ during respiration and other metabolic processes results in the formation of ROS, a term including free radical species, such as the superoxide (O₂⁻) and hydroxyl (·OH) radicals, and non-free radical species, such as hydrogen peroxide (H₂O₂) and organic peroxides (ROOH, ROOR'). Although most of the O₂ consumed in mitochondria is reduced to water (a four-electron transfer) by cytochrome oxidase, about 1-3% is reduced to ROS, especially O₂⁻ (one electron)

and H_2O_2 (two electrons). The production of $\cdot\text{OH}$ radicals is difficult to demonstrate *in vivo* because of their extremely high reactivity (Halliwell and Gutteridge, 1984) as compared with that of O_2^- radicals (lifetime of 2-4 μs) and H_2O_2 (lifetime of 1 ms). The $\cdot\text{OH}$ radicals can be formed from H_2O_2 by Fenton reactions that are catalyzed by traces of redox-active metals, like iron and copper, and, therefore, the concentrations of free “catalytic” metals in cells tend to approach zero (Halliwell and Gutteridge, 1984). Even though formation of toxic amounts of $\cdot\text{OH}$ radicals have been detected in senescent nodules (Becana and Klucas, 1992), the $\cdot\text{OH}$ radicals, under certain conditions, might play physiological roles (as occurs for other ROS), such as the cell-wall loosening, which is required for growth of plant organs (Schopfer, 2001).

In nodules, ROS formation is also favored by the slightly acidic cytosolic pH, the high concentration of leghemoglobin (Lb) with its propensity to autoxidize, the abundance of heme iron, and the strongly reducing conditions in the infected zone. The electron-transport chains in bacteroids, mitochondria, peroxisomes, endoplasmic reticulum, and plasma membranes can generate ROS as can enzymes, such as xanthine oxidase and uricase in peroxisomes (Corpas *et al.*, 2001). Lipoygenases, which can also generate O_2^- radicals, are expressed in the apex of pea nodules, suggesting that these enzymes are involved in nodule development (Wisniewski *et al.*, 1999). Interestingly, there is strong expression of a lipoygenase (*LOXI*) gene in the nodule parenchyma and in the cells surrounding the stele of broad bean nodules (Perlick *et al.*, 1996). Oxidation of Lb, nitrogenase, hydrogenase, and ferredoxin also generates ROS. Although previously thought to only be toxic by-products of aerobic metabolism, ROS are key signals in many plant processes, including nodulation and defence against pathogens, and, hence, their steady-state concentrations are strictly controlled. The functions of ROS in nodule formation and senescence are discussed in sections 7.1 and 7.2.

Nodules also generate reactive nitrogen species (RNS), including the free radical nitric oxide (NO) and the non-free radical peroxyxynitrite (ONOO^-), which are molecules of moderate reactivity. Nitric oxide has multiple functions in plants, including cell elongation, stomatal closure, germination, and flowering. Peroxyxynitrite is mainly formed by the reaction between NO and the O_2^- radical. The possible functions of RNS in nodules are described in section 7.3.

1.3. Oxygen Diffusion, Leghemoglobins, and other Hemoglobins

The obvious way to prevent potential ROS damage in infected cells is to limit the rate of O_2 influx to that required for their respiration, thus minimising the levels of free O_2 . However, this creates two further problems: firstly, the respiratory requirement will vary; and secondly, diffusion at very low O_2 concentrations cannot adequately supply all the bacteroids within the large infected cells. Legume nodules have solved the first problem by developing structural and biochemical systems to regulate O_2 influx to and within the infected cells. Unfortunately, despite 20 years' work on these systems, agreement as to their nature is lacking and the signaling and

biochemistry behind such processes is poorly understood. The experimental evidence leading to the concept of an oxygen-diffusion barrier (ODB) in legume nodules is reviewed in section 2.

Legume nodules have solved the second problem of O₂ movement within infected cells by utilising the O₂-carrying properties of Lbs, usually present as a mixture of isoproteins. Typically, symbiotic Lbs are myoglobin-like monomeric hemoproteins of approximately 16 kDa, which are present at 1-5 mM. Their well-recognized function is to deliver O₂ to the symbiosomes while preserving the activity of O₂-sensitive nitrogenase. This is possible because their extremely fast O₂-association rate is coupled to a relatively slow O₂-dissociation rate, resulting in a very high O₂ affinity. The Lb isoproteins may have different O₂-binding affinities and capacities to support N₂ fixation by isolated bacteroids (Appleby, 1984). The relative proportions of the isoproteins vary with nodule development (Dakora *et al.*, 1991), suggesting that the heterogeneity of Lbs contributes to effective N₂ fixation by changing the capacity to transport O₂. Interestingly, two genes encoding Lbs with different O₂-binding affinities are differentially expressed within the infected zone of pea nodules, possibly implying distinct roles for the Lb isoproteins during nodule development (Kawashima *et al.*, 2001).

Plants contain at least two other types of hemoglobin (Hb) functionally and genetically distinct from Lb. In *Arabidopsis thaliana*, the non-symbiotic Hb of class 1 (*e.g.*, AHB1) occurs at low levels in root tissue and is induced by hypoxia. Class 1 Hbs also include those of barley (*Hordeum vulgare*) and rice (*Oryza sativa*), which have been fully characterized. They are amply distributed in tissues of both monocots and dicots, but occur at much lower concentrations than Lbs; the dimeric barley Hb is present in roots or aleurone tissue at only 20 µM. Less is known about class 2 non-symbiotic Hbs, such as that of *A. thaliana* (AHB2). It has limited homology with AHB1, but significant homology with Lbs and the Hb of *Casuarina*, and has a much lower affinity for O₂ than do class 1 Hbs. It is expressed at low levels in rosette leaves and is induced by low temperatures. Because non-symbiotic Hbs generally have a high avidity for O₂, they are unlikely to act as O₂ sensors or carriers (Hunt *et al.*, 2002). Rather, Hbs may be oxygenases able, in conjunction with flavoproteins, to oxidize NADH to maintain glycolysis and improve the energy status of the cells under low O₂ stress. The possible functions of Hbs in relation to RNS in nodules are discussed in sections 7.3. and 9.1.

2. PHYSIOLOGICAL EVIDENCE FOR A VARIABLE OXYGEN DIFFUSION BARRIER

2.1. Indirect Evidence

Indirect measurements of the resistance (or permeability) to O₂ diffusion of legume nodules can be made using flow-through gas systems (Witty and Minchin, 1998a). All, or a part, of a nodulated root system is enclosed and simultaneous measurements made of nitrogenase activity (as acetylene reduction or H₂ production) and respiration (as CO₂ production or O₂ consumption). Oxygen

diffusion resistance is then calculated using equations based on Fick's first law of gaseous diffusion. Several laboratories have used this approach to provide a plethora of indirect evidence for a variable ODB (reviewed by Hunt and Layzell, 1993; Minchin, 1997; Witty *et al.*, 1986). Changes in diffusion resistance have been measured in response to: (a) exposure to 10% acetylene or Ar/O₂ atmospheres; (b) variations in external O₂ concentration; (c) reductions in nodular carbohydrate supply due to detachment, stem girdling, defoliation or stem darkening; and (d) other stresses (nitrate, drought, salt, temperature, and phosphate deficiency). More direct evidence has been obtained by the use of microelectrodes, Lb spectroscopy, and the diffusion of unusual gas mixtures.

2.2. O₂ and H₂ Microelectrodes

The first O₂ microelectrode studies with nodules (Tjepkema and Yokum, 1974) used platinum microelectrodes to qualitatively measure the O₂ concentration through soybean nodules and recorded an abrupt and very substantial decline in pO₂ in the inner cortex (at a depth of approx. 250 μm). Witty *et al.* (1987) used O₂-specific microelectrodes able to quantify pO₂ down to 1 μM to substantiate these findings for both pea and common bean (*Phaseolus vulgaris*) nodules by finding a very sharp O₂ gradient at approximately 200-300 μm within the inner cortex. Intriguingly, a decline in O₂ concentration across the nodule cortex still occurred, albeit less steeply, in nodules lacking either nitrogenase or Lb (Masepohl *et al.*, 1993; Ott *et al.*, 2005). Similar O₂ profiles are also apparent in nodules on alfalfa (Soupeine *et al.* 1995), pea (Romanov *et al.*, 1996), and *Sesbania* (James *et al.*, 1998), all of which provides evidence that the nodule cortex is the major site of resistance to gaseous diffusion. Variation in this ODB was evidenced by a transient (duration of 2-4 min) "spike" in the inner cortical O₂ concentration following exposure of bean nodules to 40% O₂ (Witty *et al.*, 1987). This "spike" was interpreted as an initial rapid increase in the ODB resistance in the inner cortex on exposure of the nodule to increased pO₂, followed by the excess O₂ (initially detected by the electrode) being subsequently consumed by the actively respiring infected cells.

H₂-specific microelectrodes provided further evidence for a cortical barrier (Witty, 1991) by showing reciprocal changes in H₂ and O₂ concentrations. The H₂ concentration in the outer cortex was zero, sharply increasing across the inner cortex to a uniform concentration of approx. 1% H₂ in the infected region of soybean nodules containing Hup⁻ bacteroids.

Combining H₂ microelectrode measurements with those of H₂ efflux from soybean nodules with Hup⁻ bacteroids (Witty and Minchin, 1998a) produced direct evidence for a variable physical barrier within the nodule cortex (Witty and Minchin, 1998b). Unlike measurements based on fluxes of O₂ or CO₂, there is no metabolism of H₂ gas produced by nitrogenase activity, so that the relationship between the concentration of H₂ within the infected region and its efflux from the nodule must be determined by the resistance of a physical diffusion barrier. Given a constant resistance of this barrier, factors that affect H₂ production should induce

proportional changes in the internal H_2 concentration. This did not happen with detopping, which caused a marked decrease in H_2 evolution from nodules but a small increase in internal H_2 concentration (Witty and Minchin, 1998b). Increasing external O_2 concentration slightly increased H_2 evolution and markedly increased its internal concentration. Both observations could only be explained by a four-fold increase in nodular resistance to H_2 diffusion, thus providing incontrovertible evidence for changes in the diffusion resistance of a physical barrier.

2.3. Leghemoglobin Spectroscopy

Fibre-optic spectrophotometry, using transmitted light of specific wavelengths to determine the levels of oxyleghemoglobin ($Lb \cdot O_2$) and reduced Lb in legume nodules, initially used cut attached nodules (Appleby, 1969; Bergersen, 1962), but was further developed for flattened attached nodules (Klucas *et al.*, 1985). It was also used to study environmental effects. Franco-Vizcaino *et al.* (1988) showed a decrease of Lb content following treatment of cowpea (*Vigna unguiculata*) nodules with either nitrate or ammonia, whereas King *et al.* (1988) reported a transient increase in the $Lb \cdot O_2$ content after exposing soybean nodules to 25 kPa O_2 . The recovery of the Lb oxygenation state to its initial level within 7.5 min is further direct evidence for the operation of a variable ODB.

Diffuse-reflectance spectroscopy (Monroe *et al.*, 1989) has apparent advantages over the use of transmitted light but has the major disadvantage of using detached nodules. It was superseded by a pulse-modulated spectroscopic system (Denison *et al.*, 1991; Layzell *et al.*, 1990) for use with undisturbed attached nodules in both the laboratory and the field. These studies showed lowered O_2 concentrations within infected cells following treatments with nitrate, stem girdling, continuous darkness, nodule disturbance, or plant detopping. All these treatments also increase the resistance to O_2 diffusion within legume nodules (see above), demonstrating the potential for Lb spectroscopy to directly measure changes in the resistance of the ODB by following changes in the fractional oxygenation of Lb (Denison and Layzell, 1991; Denison *et al.*, 1992).

Together, measurements using Lb spectroscopy (or nodule oximetry) and H_2 microelectrodes demonstrated a rapid recovery of nitrogenase activity in soybean nodules following complete inhibition by a briefly elevated infected-cell O_2 concentration (Denison *et al.*, 1992). Although this result was interpreted as possible evidence for conformational protection of nitrogenase within soybean nodules, direct confirmation of this hypothesis has not surfaced. A further combination of nodule oximetry and membrane-potential microelectrodes demonstrated a rapid and reversible depolarisation of membrane potentials in nodules of several legumes after an exposure of 1-2 min to 100 kPa O_2 (Denison and Kinraide, 1995). These results are consistent with an osmoelectrical mechanism for the operation of the ODB and support other observations (Purcell and Sinclair, 1994; Serraj *et al.*, 1995) to be discussed in section 5.2.

Nodule oximetry has recently been used with a range of transmission wavelengths and coupled to video microscopy of indeterminate nodules to produce

2-D images of the fractional oxygenation of Lb, which show gradients in internal O₂ concentration (Denison and Okana, 2003; Shimada *et al.*, 1997). Short-term changes in these gradients followed exposure of all, or just one side, of the nodules to increased external O₂. The presence of these gradients implies some restriction of O₂ diffusion within the infected region. Localized changes in the gradients produced by exposure of one part of a nodule to increased O₂ imply that changes in the resistance of the ODB can occur at specific points without inducing changes across the whole nodule.

2.4. Hydrogen and Helium Diffusion

Denison *et al.* (1992) calculated that their measured values for internal H₂ concentration and nodule resistance to H₂ and O₂ diffusion indicated the presence of air-filled pores through a largely water-filled diffusion barrier. Although consistent with some early structural studies (Bergersen and Goodchild, 1973; Sprent, 1972), this proposal seemed to contradict later studies that reported one or more layers of tightly interconnected cells, which formed a continuous water-filled boundary layer (BL) (de Lorenzo *et al.*, 1993; Iannetta *et al.*, 1993b; James *et al.*, 1991; Parsons and Day, 1990). This apparent discrepancy was resolved by Witty and Minchin (1994), who argued that for diffusion through air-filled pores, O₂ would move more rapidly through a He atmosphere than through air or Ar, but that the background gas atmosphere would make no difference to diffusion through a liquid-filled barrier. This approach was validated using millipore filters and then applied to measurements of H₂ production and respiration of soybean nodules under Ar/O₂ or He/O₂. The results for soybean indicated that about 50% of O₂ diffusion occurs through gas-filled pores in unstressed nodules, but that these “close” to produce a liquid-filled barrier in stressed nodules. In contrast, there was no evidence for gas-filled pores in lupin nodules. Thus, the BL of soybean nodules must be traversed by a small number of open, but “adjustable”, intercellular spaces, that are absent from the BL of lupin nodules.

3. STRUCTURE OF THE CORTICAL OXYGEN DIFFUSION BARRIER

Early studies strongly suggested that O₂ levels in the central infected zone were very low (Allison *et al.*, 1940; Smith, 1949) and that N₂ fixation was limited by O₂ (Bond, 1950; Bergersen, 1962; Ferguson and Bond, 1954), all of which led to the speculation that some sort of barrier impeded the influx of O₂ to the infected zone. The first support for such a barrier came from Frazer (1942), who observed that the influx of dyes into both determinate and indeterminate nodules was impeded by the “common” endodermis, which she hypothesised was possibly also an ODB. More sophisticated light (LM) and electron microscopy (EM) techniques in the 1960s and 1970s allowed more detailed studies of nodule structure with regard to O₂ diffusion. Thus, Bergersen and Goodchild (1973) observed a network of continuous air spaces from the outer surface to the infected zone and concluded that there was no physical barrier in the cortex of soybean nodules. They hypothesised that the reduced pO₂

within the infected zone resulted from O₂ sinks in the nodule inner-cortical cells, in the interstitial cells in the central zone, and in the numerous mitochondria at the periphery of infected cells. A subsequent transmission EM study of water-stressed soybean nodules (Sprent, 1972) also showed continuous air pathways through the cortex. After scanning EM studies, Pankhurst and Sprent (1975) concluded that, for soybean nodules, the surface lenticels were the most likely points for O₂ entry into the impermeable periderm around the nodule and so where O₂ influx would be regulated. This hypothesis (Jacobsen *et al.*, 1998; Ralston and Imsande, 1982; Webb and Sheehy, 1991) is discussed further in section 3.7.

In contrast, a mathematical model (Sinclair and Goudriaan, 1981) predicted a continuous water-filled layer in the inner cortex of 45 µm, a conclusion supported by a combined anatomical and mathematical study of pea and lupin nodules (Dixon *et al.*, 1981). In resin-embedded sections of lupin nodules, they focused on three-to-four cortical cell layers (approx. 50 µm thick) close to the infected zone and concluded that they had relatively few (if any) intercellular spaces. However, they also concluded that intercellular spaces within the infected zone were not interconnected, thus disagreeing with earlier results and predictions (Bergersen and Goodchild, 1973; Tjepkema and Yocum, 1974; Sinclair and Goudriaan, 1981). The reason suggested (Dixon *et al.*, 1981) for the difference was that the earlier studies had been on soybean nodules and these were on pea and lupin nodules, which were “smaller” and required an “extra restriction on gaseous diffusion”.

3.1. Development of the Witty-Sheehy-Minchin Model

In 1983, Sheehy *et al.* presented the hypothesis that not only was there a “fixed” or minimal O₂-diffusion resistance, but also a “variable” component under plant control. Although physiological and mathematical studies proliferated, few (if any) examined the location and function of the proposed variable barrier until the development of an anatomical model (Witty *et al.*, 1986). This model included a fixed inner-cortical O₂ barrier, a network of air spaces adjacent to the infected zone for the spherical distribution of the greatly reduced pO₂ around it, and a system of interconnected air spaces within the infected zone itself. Witty *et al.* (1987) speculated that the variable component of the ODB was most likely controlled by altering the extent to which intercellular spaces within the cell layers of the inner cortex are occluded by water (or other material). Indeed, the discovery that the cortical ODB is variable may reconcile the earlier, apparently contradictory, reports of continuous air spaces from the nodule surface to the infected zone with those of sharp O₂ gradients and no apparent air spaces (see sections 2.4. and 3.1.).

3.2. Effects of Long-term Culture in Variable pO₂ on Determinate and Indeterminate Nodules

The cortical structure of the Witty-Sheehy-Minchin model has been largely validated by several detailed LM and EM studies, at least for determinate nodules (Figure 1A). For example, when nodulated soybean roots were grown for 15 d at

pO_2 ranging from 4.7-75 kPa, all the nodules had a layer (or layers) of cells within the inner cortex that did not contain any obvious radially traversing air spaces (Parsons and Day, 1990). This layer was named the BL and considered to be the most likely major contributor to the “fixed” water-filled ODB (see section 2.4.). Parsons and Day (1990) also observed a “distribution zone” internal to the BL and adjacent to the infected tissue. This zone consisted of loosely-connected cells with large air spaces, as reported by Witty *et al.* (1987), and its structure, particularly the number and size of intercellular spaces within it, did not vary with pO_2 .

The BL and distribution zone are also evident in the micrographs of Newcomb *et al.* (1989) in their study of ureide production and uricase localization in soybean nodules. Indeed, they regarded the distribution zone cells (but not those in the BL) as being structurally and functionally very similar to the uninfected interstitial cells within the infected zone, in that they also expressed uricase. It was, therefore, suggested that, if microaerobic conditions were important for uricase expression, then these cell layers must be exposed to the same pO_2 as the interstitial cells within the infected zone. The BL, although varying in morphology across species (*e.g.*, in its number of cell layers and whether or not it is “collapsed” in appearance), may be ubiquitous in the inner cortex in all legume nodules (Brown and Walsh, 1994).

Long-term (>20 d) altered pO_2 studies on cowpea nodules (Dakora and Atkins, 1990a; 1990b) and soybean nodules (Atkins *et al.*, 1993; Dakora and Atkins, 1991) also revealed structural changes similar to those reported by Parsons and Day (1990). These included both enhanced lenticel growth and an increase in air spaces in the outer cortex in nodules grown under lowered pO_2 . The occurrence of 2-5 layers of cells without intercellular spaces in the inner cortex was confirmed; these layers, which must include the BL of Parsons and Day (1990), conformed closely to the predictions of Sinclair and Goudriaan (1981) in being 40-45 μm thick in nodules grown in air. However, there were differences from the study of Parsons and Day (1990). The area of the “inner cortex” (Dakora and Atkins, 1990a; 1991), which is analogous to the “distribution zone” plus the BL (Parsons and Day, 1990), was not constant for all pO_2 's, but actually increased at the lowest values (1-2.5% O_2), even though estimates of the ODB under these very low pO_2 's suggested that its thickness was greatly reduced (*e.g.*, only 7.5 μm thick in nodules grown in 1% O_2). For cowpea and soybean nodules (Dakora and Atkins, 1990a; 1991), a “sheath” of overlapping cell layers formed in the inner cortex as pO_2 increased, but with nodules grown at sub-ambient pO_2 , the cells in these layers became more rounded and no longer overlapped. Therefore, the tortuosity (and hence diffusion resistance) of the O_2 pathway through these critical cell layers decreased with decreasing pO_2 . In a Hup⁻ soybean symbiosis, the nodule BL increased from one layer of cells in 2.8% O_2 to five or six layers in nodules grown in 61.2% O_2 (Atkins *et al.*, 1993). These studies with cowpea and soybean nodules differ from that of Parsons and Day (1990), where the boundary-cell layer(s) in soybean nodules remained more or less constant in all the pO_2 treatments. They suggested that changes in the permeability of the nodules were affected by the close packing of cells and by the variable occlusion of intercellular spaces in the cortical-cell layers external to the BL, *i.e.*, within the “mid cortex” of Dakora and Atkins (1990a; 1991).

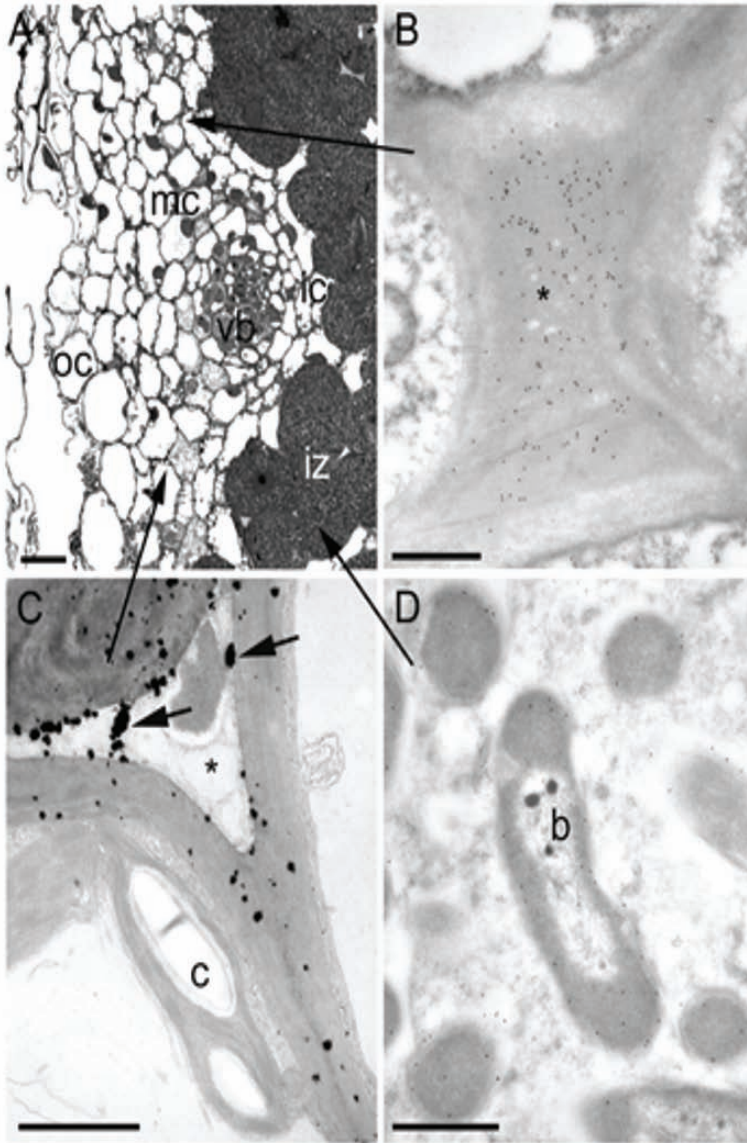

Figure 1. (A) LM of a cortical cross section of a *L. japonicus* nodule showing the infected zone (iz), inner cortex (ic), mid cortex (mc), outer cortex (oc), and vascular bundle (vb). (B) TEM of an intercellular space, which is occluded with material (*), including the matrix glycoprotein (immunogold labeled with the monoclonal antibody MAC236), in the mc of a *L. japonicus* root nodule. (C) TEM of an intercellular space [*]; stained with electron-dense cerium perhydroxide that is localized (arrows) within the intercellular space and cell walls close to chloroplasts (c) in the photosynthetic mc of a *S. rostrata* stem nodule. (D). TEM of a bacteroid (b) in the infected zone of a high-pressure frozen cowpea nodule immunogold labelled with an Mn-SOD antibody. Bars: 20 μm (A), 1 μm (B), 2 μm (C), 500 nm (D).

Fewer structural studies have been made of indeterminate nodules grown under variable pO_2 , presumably because of the additional “complicating factor” of a longitudinal age gradient from the apex to the subtended root. When making observations about the ODB in these nodules, it is necessary to confirm that these are taken from the cortex adjacent to the N_2 -fixing zone. In one of the few studies of indeterminate nodule ODB structure (Arrese-Igor *et al.*, 1993), alfalfa nodules grown under 1% O_2 produced aerenchyma in the outer cortex external to the endodermis, and the inner cortex of these nodules had a much more “open” structure than nodules grown under 21% O_2 , which had most of their intercellular spaces occluded with dark-staining material. Other structural studies of indeterminate nodules (alfalfa) grown under varying pO_2 (Wycoff *et al.*, 1998; Weisbach *et al.*, 1999; Gálvez *et al.*, 2000) are discussed in section 3.6.

3.3. Intercellular Occlusions and Matrix Glycoprotein

VandenBosch *et al.* (1989) used monoclonal antibodies against pea nodule components to examine the composition of the infection thread and matrices. After immunogold labelling, three of these antibodies (MAC204, MAC236 and MAC265) not only labelled the infection-thread matrix but were also found in the intercellular spaces of pea and soybean nodules. Intercellular spaces in uninfected pea roots were also labelled but less strongly than in nodules, suggesting that the epitopes recognised by the antibodies were nodule-enhanced. Each of the antibodies appeared to recognise different epitopes on a 95-kDa glycoprotein, termed matrix glycoprotein (MGP) (Rae *et al.*, 1991; VandenBosch *et al.*, 1989). The antigen recognised by MAC265, now known to belong to a family of extensin-like glycoproteins (Rathbun *et al.*, 2002), was strongly expressed within intercellular spaces in the cortex of pea nodules (Rae *et al.*, 1991), and particularly in the “mid-cortex” region external to the BL. Further, when nodulated soybean roots were grown under atmospheres containing 10, 20 or 40% O_2 , immunogold labelling with MAC236 (Figure 1B) showed that the occlusion of intercellular spaces by the MGP in the mid-cortex of the nodules increased with increasing pO_2 (James *et al.*, 1991). Enzyme-linked immunosorbent assays (ELISA) with MAC236 (Iannetta *et al.*, 1993a) on extracts from the nodules used by James *et al.* (1991) confirmed the qualitative microscopy. In addition, soybeans with high nodule resistance to O_2 diffusion (*e.g.*, the supernodulating mutant *nts382*; Schuller *et al.*, 1988) had higher concentrations of the MAC236 antigen than those with lesser resistance (in this case, the parent genotype cv. Bragg; Iannetta *et al.*, 1993a).

Further studies with a wide range of symbioses across all three legume sub-families (as well as the non-legume *Parasponia*) showed the MAC236/MAC265 antigens to be ubiquitous in rhizobia-containing nodules (James *et al.*, 1994), including those on the flooding-tolerant plants, *Neptunia plena* (James *et al.*, 1992a), *Discolobium pulchellum* (Loureiro *et al.*, 1994), *Aeschynomene fluminensis* (Loureiro *et al.*, 1995), and *Sesbania rostrata* (James *et al.*, 1996). Indeed, flooding-tolerant legumes have helped clarify the potential role of MGP occlusions in O_2 regulation.

Two *Lotus* spp., which differ in tolerance to prolonged submergence, were found to respond differently to hypoxia (James and Crawford, 1998). Nodules on the non-tolerant species, *L. corniculatus*, were adversely affected when grown in water bubbled with N₂ rather than air, whereas growth and N₂ fixation by the flooding-tolerant species (*L. uliginosus*) were enhanced in the N₂-bubbled water. In flooding-tolerant nodules, the concentration of MAC236 antigen was less under N₂-bubbling than under air-bubbling. This ELISA data correlated with immunolocalization of MAC236 in nodule sections, which showed many of the intercellular spaces in the mid-cortex in air-bubbled *L. uliginosus* nodules to be occluded with MGP, particularly beneath lenticels (the “choke points” of Jacobsen *et al.*, 1998; see section 3.7.). In contrast, the spaces in similar regions of N₂-bubbled nodules were relatively empty. James and Crawford (1998) then concluded that submerged (hypoxic) *L. uliginosus* nodules could “open” air pathways to the N₂-fixing zone by decreasing the MGP occlusion of cortical intercellular spaces.

3.4. The Matrix Glycoprotein in Non-papilionoid Nodules

In their survey of N₂-fixing nodules and the occurrence of the MAC265 antigen, Brown and Walsh (1996) considered that the MGP was important in regulating O₂ diffusion in “advanced” Papilionoid nodules, but was less so in “primitive” nodules from the Caesalpinioideae, especially those with “persistent infection threads”, which were first discovered in nodules on the non-legume *Parasponia* (Trinick, 1979). These persistent infection threads consist of a sheath of cell-wall material around each bacteroid (de Faria *et al.*, 1986; Naisbitt *et al.*, 1992) and may well be a considerable barrier to O₂ diffusion to the enclosed bacteroid, thereby lessening the need for cortical regulation of O₂ diffusion. However, Brown and Walsh (1996) only examined one Caesalpinoid species (*Chamaecrista pilosa*) for this character and, given that the MAC236 antigen occurred in nodules from five *Chamaecrista* species, including one with persistent infection threads (*C. desvauxii*; James *et al.*, 1994), no firm conclusions about a role for MGP in nodules from this sub-family can yet be made. Although MGP occurs in nodules from nine Mimosoid species (James *et al.*, 1994), the only evidence for a role *vis a vis* O₂ diffusion in such nodules is its localization in the cortex of aquatic *Neptunia plena* nodules (James *et al.*, 1992a). However, although *N. plena* nodules grow equally well in well-aerated and submerged conditions and can finely regulate their ODB (James *et al.*, 1992b), MGP occlusions cannot yet be assigned a definite role.

3.5. ENOD2 and Other Occluding Materials

Although the MGP recognised by MAC236 and MAC265 is the most-studied material so far identified within cortical intercellular spaces, there is ample evidence for other material in the occlusions, *e.g.*, lectins in peanuts (VandenBosch *et al.*, 1994) and alfalfa (Bauchrowitz *et al.*, 1996), proline-rich proteins in peas (Sherrier and VandenBosch, 1994), and diprenylated isoflavones in lupins (Grandmaison and Ibrahim, 1995). In addition, the hydroxyproline-rich cell-wall protein encoded by

ENOD2 is expressed in the densely-packed cells of the inner cortex (“nodule parenchyma”) of pea, soybean, and alfalfa root nodules as well as in stem and root nodules on *S. rostrata*, making it a good candidate for participating in the operation of the ODB (Chen *et al.*, 1998; Van de Wiel *et al.*, 1990a; 1990b). In clover (*Trifolium repens*) and *L. corniculatus* nodules, however, the detection of *ENOD2* several cell layers away from the infected zone and always around vascular bundles (Lauridsen *et al.*, 1993) may indicate functions other than involvement in the ODB.

Indeed, conclusions as to the role of *ENOD2* in the ODB vary with the symbiosis. Nodules of *L. corniculatus* transformed with antisense *ENOD2* had lower nitrogenase activity and a different O₂ profile compared to control nodules (Skot *et al.*, 1996), and boron-deficient bean nodules, which lack a protein encoded by an *ENOD2* homolog, had aberrant cell-wall structures in the inner cortex and greatly decreased nitrogenase activity (Bonilla *et al.*, 1997). In contrast, in alfalfa nodules grown under 8%, 20%, or 50% O₂, levels of *ENOD2* mRNA and protein were unaltered (Wycoff *et al.*, 1998), suggesting that neither *ENOD2* transcription nor synthesis is involved in the ODB (although the possibility remains of changes in extractable protein due to cross-linking under different O₂ levels). Also, *ENOD2*-antisense alfalfa plants grow normally under different pO₂ levels (unpublished data quoted in Wycoff *et al.*, 1998), which suggests that *ENOD2* is required for neither normal alfalfa nodule development nor proper functioning of the ODB.

Significantly, despite these differing conclusions, immunolabelling of bean (Bonilla *et al.*, 1997) and alfalfa (Wycoff *et al.*, 1998) showed *ENOD2* primarily localized within cell walls and intercellular spaces of the inner cortex, suggesting that it is part of the intercellular “gel” that occludes these spaces (Minchin, 1997). If and how the components of this gel interact remains to be seen (Minchin, 1997; and see below) but, of all these materials, only the MGP varies with changes in external pO₂. Concentrations and intercellular expression of *ENOD2* did not alter in alfalfa nodules grown under varying pO₂ levels (Wycoff *et al.*, 1998), whereas the levels of expression of lectins, proline-rich proteins (Sherrier and VandenBosch, 1994), and diprenylated isoflavones (Grandmaison and Ibrahim, 1995) have not yet been evaluated in nodules where changes in O₂ permeability have been induced.

3.6. Endodermis and Outer Cortex Barriers: Indirect and Direct Evidence

The hypothesis (Fraser, 1942) that the nodule “common endodermis”, separating the inner (nodule parenchyma) from the outer cortex, could constitute a barrier to gaseous diffusion has been much studied. Fraser (1942) defined the endodermis as a layer of cells containing suberin in a Casparian strip, but this review will consider the layer of lignified sclereid cells often present in determinate papilionoid nodules (Sutherland and Sprent, 1984) to be analogous to the common endodermis. Brown and Walsh (1994) surveyed the anatomy of a wide range of nodules from 43 species across all three legume sub-families, concluding that the common endodermis, together with a suberised periderm within the outer cortex and deposition of material in inner cortical intercellular spaces, would act as a series of fixed resistances to O₂. However, when they used Casparian strip-specific stains

(Brundrett *et al.*, 1988) and the endodermal cell wall-specific monoclonal antibody, JIM13 (Rae *et al.*, 1991), to better identify the endodermis and the periderm (Brown and Walsh, 1996), they found the endodermis not to be the universal feature of legume nodules proposed by Frazer (1942), but to be actually present in only a few Papilionoid nodules. Those lacking the common endodermis, especially in the Mimosoideae and Caesalpinioideae, generally had a suberised periderm in the outer cortex. Brown and Walsh (1996) concluded that a suberised periderm, as opposed to a common endodermis, was a “primitive” feature for O₂ regulation and nodule evolution. As the membrane-impermeant dye lucifer yellow-CH penetrated the endodermis (when present), they also concluded it was not an apoplastic barrier, and was also unlikely to be a significant gaseous-diffusion barrier.

Apart from dye-infiltration experiments (Brown and Walsh, 1996; Frazer, 1942; Streeter and Salminen, 1992; Tjepkema and Yocum, 1974), what evidence is there that suberised and/or lignified cell layers, such as the endodermis and sclereid layer, are involved in the ODB? The apparently interlocking structure of endodermal cell layers suggests that their role may be analogous to the BL of Parsons and Day (1990). A lack of intercellular spaces in tangential sections of the outer cortex of bean nodules, particularly in a cell layer immediately adjacent and external to the endodermis, led Sutherland and Sprent (1984) to speculate that this layer may be a barrier to gaseous diffusion. When Iannetta *et al.* (1993a) compared the sclereid layers of mutant (*nts382*) soybean nodules with those of cv. Bragg, they found that the sclereid layer was two cells thick and uninterrupted in *nts382* nodules compared to a single cell layer with frequent gaps in cv. Bragg nodules, and that the sclereids were more lignified in the former. The potential of the sclereid layer as a gaseous-diffusion barrier in soybean nodules was also demonstrated, when it was dissected out as a sheet and shown to lack intercellular spaces (Brown and Walsh, 1994). Interestingly, the nodules from the study of Parsons and Day (1990), which were grown in 50% or 80% O₂, showed no discernible increase in sclerification of the common endodermis compared to control nodules and Brown and Walsh (1994) argued that this apparently “constant” nature of the endodermis under variable pO₂ has parallels with the BL. Indeed, because of the lack of radially-orientated intercellular spaces within it, Iannetta *et al.* (1995) considered the endodermis in lupin nodules to be an additional BL to that present in the inner cortex.

The other often-suberised layer with potential as an ODB is the periderm (“cork”) of dead cells in the outer cortex (Brown and Walsh, 1994; 1996; Frazer, 1942; Jacobsen *et al.*, 1998; Webb and Sheehy, 1991). Most nodules so far examined for this trait appear to have a periderm of variable thickness with some possible exceptions, such as the indeterminate nodules on alfalfa and pea (Brown and Walsh, 1996; Frazer, 1942; Jacobsen *et al.*, 1998). The outer cortex needs to be hydrophobic to prevent water loss (Pankhurst and Sprent 1975; Sprent, 1972), but also to prevent water influx from the soil that would block air pathways into the nodule (Webb and Sheehy, 1991). Under the cryo-scanning EM, frozen soybean, clover, and alfalfa nodules all showed surfaces covered in loosely packed cortical cells, as well as areas of collapsed cells covering intact ones (Webb and Sheehy, 1991). In soybean nodules, the loosely-packed “superficial” cells were in ridges (most likely the lenticels of Pankhurst and Sprent, 1975) interspersed with troughs,

which consisted of collapsed cells, and a smooth amorphous matrix that covered large areas of the nodule surface. This matrix, absent from clover and alfalfa nodules (Webb and Sheehy, 1991), was relatively thick, had embedded bacteria, and extended as far as the phellogen (Pankhurst and Sprent, 1975). It has, to our knowledge, neither been reported by others nor had its composition analysed. Soybean nodules were noted as very difficult to wet (Webb and Sheehy, 1991). Under the cryo-scanning EM, the loosely-packed “superficial” cells of the lenticels on frozen soybean nodules showed a hydrophobic coating in the form of a solvent-extractable “stippling” that is absent from conventionally fixed material. The outer cortical cells of clover and alfalfa nodules also had a hydrophobic coating (Webb and Sheehy, 1991), possibly analogous to the hydrophobic (and antibiotic) triterpenoid coating on the walls of the outer cortical cells of broad bean nodules (Hartmann *et al.*, 2002). These hydrophobic coatings (as well as the amorphous matrix, if present) may have roles in preventing both water influx and water loss.

Jacobsen *et al.* (1998) and Hartmann *et al.* (2002) provide more definitive evidence concerning suberised cell layers and gaseous diffusion. The former dissected nodules of *L. corniculatus* and alfalfa which, after exposure to iodine vapour, revealed gaseous pathways marked by the dense blue iodine-starch complex. In determinate *Lotus* nodules, the iodine gas only entered at the lenticels, thus confirming their proposed aeration role (Frazer, 1942; Pankhurst and Sprent, 1975); however, it also indicated that the suberised periderm over the rest of the nodule surface was an effective barrier to gas entry. Once in the nodule, the iodine was restricted to the cortical regions containing vascular bundles situated just below the lenticels. No iodine was seen in the infected zone, strongly suggesting that it had been impeded at the inner cortex, most likely at the BL and/or the MGP-occluded intercellular spaces in *Lotus* spp. nodules (James and Crawford, 1998; James and Sprent, 1999). However, there was evidence of air pathways through the inner cortex near the vascular bundles (see section 2.4.). With indeterminate alfalfa nodules, which lack lenticels, the iodine vapour did not penetrate the endodermis around the infected tissue, but entered mainly at the meristem where the endodermis ends. These iodine studies (Jacobsen *et al.*, 1998) indicate that gaseous entry was most likely controlled by strategic “choke points” located at lenticels in determinate nodules and at the meristem in indeterminate ones.

Analyses of the suberised layers in indeterminate nodules of broad bean, particularly their chemical composition, indicate that the nodule endodermis matures rapidly in sub-meristematic regions (Hartmann *et al.*, 2002), reaching a considerably greater (10-fold) suberin concentration than the vascular endodermis. Moreover, unlike either the root or nodule vascular endodermis, it is also substantially lignified. Taken together with LM and EM analyses showing the nodule endodermis to form a “tight cover” around the nodules, Hartmann *et al.* (2002) concluded that it could be a barrier to both water loss from the nodule and the influx of gases. However, small “gaps” in the nodule endodermis composed of unsuberised endodermal “passage cells” immediately above vascular bundles may allow for limited gas exchange into indeterminate nodules (Hartmann *et al.*, 2002). These gaps are presumably additional to the sub-meristematic “choke points” in alfalfa nodules and analogous to the unsuberised peridermal cells located beneath

lenticels of determinate nodules, such as those on *L. corniculatus* (Jacobsen *et al.*, 1998) and soybean (Brown and Walsh, 1994; Frazer, 1942).

The cell-wall composition of the endodermis and the periderm means that they are almost certainly more rigid than the thin-walled cells in the inner cortical BL. Therefore, unlike the inner-cortical BL, they are likely to be part of a “fixed” and not a “variable” barrier, although this needs confirmation. An inconsistency in this hypothesis is that O₂-microelectrode traces of root nodules do not show a sharp drop in pO₂ in the outer cortex (Tjepkema and Yocum, 1974; Witty *et al.*, 1987). However, in nodules with a highly developed sclereid layer, like those on soybean, the insertion of microelectrodes may cause deformation and sudden puncturing of the tough lignified sclereid layer (Brown and Walsh, 1994). This may also occur in indeterminate nodules with heavily suberised endodermal cell layers, as on pea. James *et al.* (1998) used O₂ microelectrodes to prove that the suberised “epidermis” or periderm on stem nodules of *S. rostrata* (Brown and Walsh, 1996; Parsons *et al.*, 1993) is a very substantial barrier, so confirming an outer-cortex ODB.

The “waxy epidermis” on *S. rostrata* stem nodules, which is absent from root nodules, is necessary to prevent water loss in their exposed position (Parsons *et al.*, 1993). However, it clearly has an extra role as an O₂ barrier because James *et al.* (1998) found a major decline in pO₂ at a depth of only 40 µm (compared to *ca.* 250 µm in root nodules), and also showed that the efflux of O₂ generated photosynthetically within the nodule is greatly impeded by this epidermal barrier.

4. DEVELOPMENT OF THE CORTICAL OXYGEN DIFFUSION BARRIER

4.1. Nodule Size, Leghemoglobin, and Nitrogenase Expression

Developing legume nodules will not express the components of the O₂-labile nitrogenase enzyme unless and until the nodule provides the newly-released rhizobia with a microaerobic environment (Mylona *et al.*, 1995; Soupene *et al.*, 1995). In a theoretical study of the O₂-sensitive gene, *nifA*, Sheehy and Thornley (1988) calculated that a spherical legume nodule would need a radius of 0.91 mm before the combination of a very high respiratory activity in the meristematic nodule centre and a water-filled diffusion barrier in the developing cortex could lower the internal pO₂ to a level (<5 µM) at which *nifA* can be induced and its corresponding protein expressed (Ditta *et al.*, 1987). Some nodules, such as those on lupin that can fix N₂ 17 d after inoculation, conform to this model (James *et al.*, 1997). At this stage, the largest nodules in their study were 1.25 mm in radius and expressed nitrogenase, whereas the smaller nodules with a radius of 0.6 mm did not. However, soybean and pea nodules do not conform to the Sheehy and Thornley (1988) model and can fix N₂ with a radius of <0.4 mm (Goodchild and Bergersen, 1973; Vasse *et al.*, 1990). Moreover, *S. rostrata* nodules as young as 3-d old (and presumably small) are capable of fixing N₂ (Ndoye *et al.*, 1994).

Why do nodules from different species differ in the size that is required before they can express nitrogenase? The factors involved could include nodule type, the

respiration rate of the meristematic cells and/or the newly-released bacteria (about to become rapidly-respiring bacteroids), the effectiveness of the invading rhizobia, and the Lb concentration. Whatever the reason(s) for differences between nodule types in the time/diameter needed, it seems that infected zone pO_2 must be reduced to $<5 \mu M$ before *nifA* can be expressed, after which expression of both hydrogenase genes (Brito *et al.*, 1995) and nitrogenase genes follows rapidly. Subsequent induction of nitrogenase-linked respiration by the bacteroids should then decrease the infected zone pO_2 to lower levels (10-20 nM; Hunt and Layzell, 1995).

Another essential component of the O_2 regulatory system in nodules, namely Lb, is expressed 1-2 d before the onset of nitrogenase activity in developing pea and alfalfa nodules (Bisseling *et al.*, 1980; de Billy *et al.*, 1991). Moreover, in mature alfalfa nodules, Lb-gene transcription is triggered in a single cell layer in the region denoted as "interzone II-III" (de Billy *et al.*, 1991), which immediately precedes the onset of the N_2 -fixing zone (Vasse *et al.*, 1990). These studies indicate that, just prior to the onset of N_2 -fixation, O_2 concentrations in the developing nodule infected zone are at such a low level that an O_2 -carrying protein is required to maintain aerobic respiration by both the host cells and the newly-formed bacteroids. What prevents external atmospheric O_2 from diffusing into the developing nodule?

4.2. Anatomical Evidence for Formation of the Cortical O_2 -Diffusion Barrier

Sheehy and Thornley (1988) hypothesised that a cortical ODB was essential in establishing the low pO_2 necessary for nitrogenase induction and expression, implying that any putative components of the ODB (the BL, the MGP, and the endodermis) would all be present before nitrogenase. As it is such a constant feature of all nodule types so far examined (Brown and Walsh, 1994) and is relatively unaffected by growth in variable pO_2 , the inner cortical BL of cells with interlocked walls may well be one of the first components of the water-filled barrier to form around the developing nodule. Indeed, close inspection of micrographs of lupin nodules (James *et al.* 1997) or *Lotus* nodules (James and Sprent, 1999) shows the BL in very early pre- N_2 -fixing nodules on these plants. The situation is less clear for other BLs, such as the suberised endodermis and/or lignified sclereid layers. However, the sclereid layer is apparent in soybean nodules within 5 d of inoculation (Brown and Walsh, 1994) and Hartmann *et al.* (2002) observed an endodermis in the cortex of broad bean nodules adjacent to the non-fixing meristematic region and indicated that it must be part of the ODB. Further studies are required to establish exactly when the BLs, both inner and outer cortical, are formed in relation to the onset of nitrogenase expression.

Arguably, the best evidence for any of these components being involved in the development of the ODB is that for the MGP. In lupin (de Lorenzo *et al.*, 1998; James *et al.*, 1997) and *L. uliginosus* (James and Sprent, 1999), the MAC236/265 antigens are expressed in the intercellular spaces of the developing cortical tissue in nodule primordia prior to nitrogenase expression. In immunogold-labelled sections of both nodule types, the MGP occluded spaces in the cortex in a manner suggestive of a concentric ring around the developing infected tissue (James *et al.*, 1997; James

and Sprent, 1999). In addition, the MAC265 antigen has been seen occluding intercellular spaces in the developing cortex of very early stem and root nodule primordia on *S. rostrata* (E.K. James, unpublished data). MGP production in legume nodules is proposed to be part of a “modified defence response” to pathogen attack (Minchin, 1997). Evidence for this view includes its role as a component of the infection-thread matrix and the fact that non-fixing nodules, which contain “incompatible” rhizobia or rhizobial mutants, *e.g.*, those defective in LPS (Perotto *et al.*, 1994) or dicarboxylate transport (Olsson *et al.*, 2002)], produce much more MAC265 antigen, which often surrounds the invading bacteria in a manner reminiscent of a host response to a pathogen (Perotto *et al.*, 1994). A developing nodule formed from a “compatible” interaction between legume and symbiotic bacterium may co-opt the enhanced production of MGP, typical of potentially pathogenic bacterial invasion, and use it to make an ODB.

5. REGULATION OF THE CORTICAL OXYGEN DIFFUSION BARRIER

5.1. “Capturing” the Cortical Barrier in Action

Legume nodules adapt not only to long-term (days to weeks) exposure to variations in external pO_2 , but also to medium (hours) and even very short-term (minutes) increases in pO_2 and/or treatments causing an increase in ODB resistance (Minchin, 1997; see section 2.). Effects on nodule morphology and structure are readily observed both macro- and micro-scopically over the long-term, particularly in those subjected to reduced pO_2 , which apparently mimics flooding effects, *e.g.*, the production of lenticels and aerenchyma (Arrese-Igor *et al.*, 1993; James and Crawford, 1998; James *et al.*, 1992a). However, nodule responses to increases in pO_2 (*i.e.*, above ambient) are hard to observe under “natural” conditions because above-ambient pO_2 values within, or external to, plant tissues only occur with aquatic plants actively photosynthesising and producing O_2 that gets trapped within their tissues (Raven *et al.*, 1994). Because nodules normally occur on roots and do not photosynthesise (exceptions are stem nodules on *S. rostrata* and *Aeschynomene* spp.; James *et al.*, 1998), they will not naturally experience hyperoxia. Similarly, treatment with atmospheres in which N_2 has been substituted with Ar, which is also known to increase the resistance of the ODB (Hunt and Layzell, 1993; Witty *et al.*, 1986), will not be encountered in nature. Thus, it could be argued that experiments subjecting soybean nodules to above-ambient pO_2 and/or Ar: O_2 create a highly unnatural situation (Streeter, 1995). A more realistic (and complementary) approach to exposing root nodules to hyperoxia is subjecting them to physical or nutritional treatments known to cause a decrease in permeability, such as lower root temperature, shoot darkening, shoot removal, added nitrate, or salt stress.

A major problem of microscopically capturing the ODB “in action” is the sheer speed at which it is activated to reduce permeability. In many symbioses (*e.g.*, those with soybean), nodule permeability can be decreased within <5 min of the application of abiotic stresses and/or disturbances (Hunt and Layzell, 1993; Minchin, 1997; Witty *et al.*, 1986). Given that even the most effective microscopy

fixatives, *e.g.*, glutaraldehyde, can take up to 15 min to penetrate plant tissues (James *et al.*, 2000), most LM and EM studies of nodules that have used chemicals to “fix” the nodule tissues will only give images of an already activated (*i.e.*, closed) ODB. This problem may be overcome in three ways: (i) by chemically fixing nodules that are known to have a slow-reacting ODB, *i.e.*, one which takes >15 min to activate; (ii) by using an *in vivo* technique that causes little or no disturbance to the nodules, *e.g.*, magnetic resonance imaging; or (iii) by instantly freezing nodules in a cryogen, *e.g.*, liquid N₂.

In the first case, the relatively slow-reacting ODB (30 min to “close”; Iannetta *et al.*, 1993b) in the lupin/*Bradyrhizobium* sp. ISLU16 symbiosis has been used for LM and TEM studies to demonstrate where (and possibly how) the ODB is reacting to various stresses, such as the nitrate application, lowered root-zone temperature, shoot darkening, and salt stress (de Lorenzo *et al.*, 1993; Fernandez-Pascual *et al.*, 1996; Iannetta *et al.*, 1993b; 1995). The cortex of lupin nodules has a very distinct layer of thick-walled cells in the “mid-cortex”, which was first identified by Fernandez-Pascual *et al.* (1992) as possibly being of relevance to the ODB. This was confirmed in subsequent microscopy studies, which showed that the intercellular spaces in this cell layer had MGP-containing occlusions. These increased concomitantly with an increase in the extractable amounts of MAC265 antigen upon application of medium-term stresses (dark, low temperature, and nitrate) that are known to decrease O₂ permeability (de Lorenzo *et al.*, 1993; Iannetta *et al.*, 1993b). In a more detailed study, Iannetta *et al.* (1995) demonstrated that the effects of shoot darkening on intercellular occlusions in the lupin-nodule cortex could be reversed and could also be mimicked by subjecting the nodules to an atmosphere containing 50% O₂. In the latter case, MGP was observed being formed in the Golgi apparatus adjacent to intercellular spaces, while the number of labelled MAC236 antigenic sites within the thick cell walls that surround the occluded spaces increased significantly within 15 min of the O₂ increase. This suggested that MGP was produced within the cortical cells and transported across the cell wall in response to the raised pO₂.

5.2. Osmotic Regulation of the Cortical Barrier

Apart from intercellular occlusions, the ODB may also have an osmotic control component (see section 2.3. for physiological evidence) in a similar manner to stomata or motor cells, which could involve the rapid “collapse” of the BL and other inner cortical-cell layers to create an increased barrier to gaseous diffusion (Minchin, 1997). These collapsed cell layers have been observed in both chemically-fixed soybean nodules (Parsons and Day, 1990; Serraj *et al.*, 1995) and in lupin nodules (Iannetta *et al.*, 1995). In each case, the corresponding cell layers in control (unstressed) nodules had fully turgid uncollapsed cells. This result suggests that water moves rapidly from these cortical cells into the apoplast and such an osmotic effect should be accompanied by the movements of ions. Such ionic movements have been detected using X-ray microanalysis on freeze-fractured rapidly-frozen soybean nodules (Minchin *et al.*, 1995). Concomitantly, water

movement in the cortex of soybean nodules has been suggested by non-invasive magnetic resonance imaging (Brown *et al.*, 1997; MacFall *et al.*, 1992; Pfeffer *et al.*, 1992). Moreover, aquaporins, which are proteins involved in large and rapid turgor changes in pulvinus osmocontractile motor cells, have also been localized in the inner cortical cells of soybean nodules (Brown *et al.*, 1997; Serraj *et al.*, 1998).

Many of the enzymes involved in both carbon and nitrogen assimilation in nodules (see Chapter 10 of this volume for details), such as carbonic anhydrase (CA) (Atkins *et al.*, 2001; Gálvez *et al.*, 2000; Kavroulakis *et al.*, 2003), phosphoenolpyruvate carboxylase (PEPC) (Federova *et al.*, 1999; Robinson *et al.*, 1996), sucrose synthase (Federova *et al.*, 1999; Gordon *et al.*, 1992), and aspartate aminotransferase (Yoshioka *et al.*, 1999), are located in the inner cortex as well as in the infected zone. This has led to several authors (see above) suggesting that some (or all) of these are involved in the operation of a variable ODB. For example, in the case of CA, Gálvez *et al.* (2000) grew alfalfa nodules at various pO_2 levels and observed that there was an inverse correlation between external pO_2 and the expression of the protein encoded by one of the CA genes (*MscA1*) in the inner cortex. Furthermore, Atkins *et al.* (2001) have detected significant CA activity in nodules from several legumes, including soybean, cowpea, and lupin, and have also immunolocalized the *MscA1* protein in the infected tissue and inner cortex of both determinate and indeterminate nodules. Both Gálvez *et al.* (2000) and Atkins *et al.* (2001) have suggested that the inner cortical cells may behave like stomatal cells and be dependent on the synthesis of malate through PEPC. They, therefore, envisaged a role for CA either in accelerating the hydration of CO_2 to ensure a rapid supply of HCO_3^- for PEPC activity or in enhancing the convective flow of gas into the infected zone and so acting more directly on the ODB itself. However, a biochemical mechanism underlying rapid osmotic changes in the inner cortical region, which takes into account all the observations of enzyme activity and localization in the inner cortex, has yet to be proposed.

5.3. Evidence Against a Cortical Barrier

Despite the plethora of physiological and structural evidence reviewed above, some evidence against the existence of a cortical barrier has come from cryo-scanning EM studies on soybean nodules (Van Cauwenberghe *et al.*, 1993; 1994) and alfalfa nodules (Weisbach *et al.*, 1999) that have been grown under elevated pO_2 and then instantly frozen in either liquid nitrogen (Van Cauwenberghe *et al.*, 1993) or liquid ethane (Weisbach *et al.*, 1999). When examined under the scanning EM after they were either freeze-fractured or cryoplaned (Williamson and Duncan, 1989), both nodule types showed no discernible changes either in cell size and shape or in the extent of intercellular occlusions for growth at 80% O_2 compared with 21% O_2 . Further TEM studies were conducted on alfalfa nodules that had been high-pressure frozen (Studer *et al.*, 1992) and then immunogold-labelled with MAC236. Again, no differences in the extent of intercellular spaces that were occluded with the MGP were observed between treatments (Weisbach *et al.*, 1999). Thus, the general conclusion from both sets of studies was that nodule permeability was not

associated either with changes in cell shape/morphology or with the extent of occluded intercellular spaces (be they occluded with water or MGP). This conclusion, however, has been countered by a subsequent study on frozen soybean nodules that were cryo-sectioned and immunolabelled with MAC236 (James *et al.*, 2000). These latter studies clearly showed that occlusions were present in both the cortex and infected zone of frozen nodules, and that their extent increased in nodules taken from detopped plants. This apparent discrepancy between the studies of Van Cauwenberghe *et al.* (1993; 1994) and that of James *et al.* (2000) has still not been resolved. However, given that there have been so many studies showing significant changes in cell shape/morphology and/or intercellular occlusions, it is possible that the marked temperature changes associated with cryo-SEM preparations may produce artifacts in the cortices of nodules. These could include the removal of intercellular-space occlusions, perhaps through sublimation of aqueous material (Webb and Sheehy, 1991).

The results with indeterminate alfalfa nodules (Weisbach *et al.*, 1999) are more difficult to interpret as such nodules have distinct zonation in terms of the location of the active N₂-fixing cells (Vasse *et al.*, 1990). Nevertheless, further TEM studies on nodules that have been prepared using high-pressure freezing, a technique which is considered to preserve biological material as close to its “natural” state as possible (Studer *et al.*, 1992), could help in resolving these discrepancies.

6. INFECTED ZONE CONTROL

It is unlikely that the cortical ODB could allow O₂ into the infected zone at a concentration that was appropriate for all the infected cells and, in the case of ureide-exporting nodules, for uricase activity within the interstitial cells. Thus, it is logical to consider the cortical ODB as a coarse control of O₂ diffusion, whereas fine control resides within the infected cells themselves.

Mathematical models have proposed mechanisms for infected-cell O₂-diffusion regulation based on mitochondrial respiration (Bergersen, 1994; Millar *et al.*, 1995) and Lb-facilitated O₂ diffusion (Thumfort *et al.*, 1994), but more recent models have combined these concepts together with the resistance of both cell walls and plasmalemma (Thumfort *et al.*, 1999) and changes in the diffusion of adenylates (Wei *et al.*, 2004a). Additional biochemical information has come from the development of a non-aqueous separation technique, which allowed for measurements of the adenylate energy charge (the ratio of ATP to ADP+AMP) within the plant cell and bacteroid compartments of the infected zone (Kuzma *et al.*, 1999; Wei *et al.*, 2004b).

In response to treatment with Ar/O₂, which prevents N₂ fixation and induces closure of the ODB, there was an initial increase in the adenylate energy charge of the plant-cell component, followed by a decrease in the same parameter of the bacteroid fraction. This change was interpreted as suggesting that adenylates in infected cells act as signal molecules for the control of O₂ diffusion, possibly mediated through the activation of ion pumps. Wei and Layzell (2006) have now provided evidence for changes in cortical K⁺ concentrations that correlate with

changes in the ODB. Such results lend support to the existence of an osmotic component of the ODB (see section 5.2.), but critical data are still required to provide identification of the signalling pathways involved in such osmotic regulation.

An alternative suggestion for the regulation of O_2 diffusion within the infected zone is that the intercellular spaces become occluded with glycoproteins (James *et al.*, 2000). These and other components of the “intercellular space matrix” within infected cells, such as lectins (VandenBosch *et al.*, 1994) and diprenylated isoflavones (Grandmaison and Ibrahim, 1995), may be involved in oxidative cross-linking reactions that produce rigid matrixes. Such cross-linking could be catalyzed by H_2O_2 , which has been detected at low levels within infected cells (Rubio *et al.*, 2004).

7. REACTIVE OXYGEN AND NITROGEN SPECIES IN NODULES

7.1. Function of Reactive Oxygen Species in Nodule Formation

Formation of ROS, in particular O_2^- radicals and H_2O_2 , has been detected in infection threads of alfalfa, pea, and *S. rostrata* nodules (D’Haeze *et al.*, 2003; Rubio *et al.*, 2004; Santos *et al.*, 2001). The production of O_2^- radicals was visualized by LM as the reduction of yellow nitroblue tetrazolium to formazan precipitates (Doke, 1983); H_2O_2 accumulation was detected by TEM as the formation of electron-dense deposits of cerium perhydroxides from a reaction between cerium ions and H_2O_2 (Bestwick *et al.*, 1997) (Figure 1C). In *S. rostrata* nodules, H_2O_2 is associated with formation of infection pockets and is important for nodule initiation, whereas ethylene and ROS mediate the Nod-factor response (D’Haeze *et al.*, 2003). In alfalfa and pea nodules, H_2O_2 accumulated around the bacteria within the infection threads, in the thread walls, and in ‘patches’ in the thread matrices (Rubio *et al.*, 2004). At the TEM level, immuno- and cyto-chemical localization of H_2O_2 (in the presence or absence of enzyme inhibitors) showed that cytosolic CuZn-SOD co-localizes with H_2O_2 and that H_2O_2 accumulation is suppressed by inhibitors of NADPH oxidase and CuZn-SOD. These observations led to the proposal that at least part of the H_2O_2 in the infection threads and apoplast is produced by the sequential action of a membrane-bound NADPH oxidase (which generates O_2^- radicals) and CuZn-SOD (Rubio *et al.*, 2004). The H_2O_2 in the infection threads of all three legumes could be used for cross-linking and hence hardening the MGP, which is apparently required for infection-thread development (Wisniewski *et al.*, 2000). Overall, the results reveal that ROS formation is critical for nodule initiation and development. It seems likely, therefore, that the H_2O_2 detected in nascent nodules and in the infection threads of young and mature indeterminate nodules is produced as a specific response to infection associated with the nodule-developmental programme rather than as an oxidative burst similar to that encountered in pathogenic systems (Lamb and Dixon, 1997).

An important question is how the infecting rhizobia elude or suppress the plant’s defence response. Rhizobial mutants that are deficient in the synthesis of

exopolysaccharides (EPS), lipopolysaccharides (LPS), or cyclic β -glucans cannot infect the host cells successfully and/or form effective nodules (González *et al.*, 1996; Mithöfer, 2002). Rhizobial poly- and oligo-saccharides may, therefore, be essential signalling compounds for nodulation, possibly suppressing plant-defence reactions (Mithöfer, 2002). The lipochitin oligosaccharides (Nod factors) are involved in the plant's discrimination between potential pathogens (or other incompatible interactions) and symbionts (Bueno *et al.*, 2001). Thus, inoculation of alfalfa seedlings with wild-type *S. meliloti* strains increased some activities of ROS-scavenging enzymes, whereas *nodC* mutants, which are defective for Nod factors, triggered a defence response with an increase in H_2O_2 and salicylic acid in roots (Bueno *et al.*, 2001; Martínez-Abarca *et al.*, 1998). Application of Nod factors to *M. truncatula* root segments also suppressed H_2O_2 efflux (Shaw and Long, 2003). Salicylic-acid accumulation was inhibited in pea roots after inoculation with compatible rhizobia (Blilou *et al.*, 1999), but not in legumes forming determinate nodules (van Spronsen *et al.*, 2003). These results led the latter authors to conclude that salicylic acid inhibits indeterminate, but not determinate, nodulation. The mechanism of this salicylic acid-mediated inhibition is unknown. Although salicylic acid does not impair recognition of Nod factors by root hairs, it can bind catalases and peroxidases (in particular, the *Rhizobium*-induced peroxidase, Rip1) and so give rise to an increase in ROS. More work is needed to elucidate how ROS and antioxidants regulate the extent of nodule infection (autoregulation) and how they are (differentially) involved in compatible and incompatible interactions.

7.2. Function of Reactive Oxygen Species in Nodule Senescence

The little information concerning the role of ROS (and RNS) in nodule senescence includes apparent contradictions. Supporting information came from the observation that bean nodules that were induced to senesce by prolonged darkening of plants display *in vivo* production of $\cdot OH$ radicals (Becana and Klucas, 1992), mainly attributable to Fenton reactions catalyzed by Fe released from proteolytic activity (possibly cysteine proteases) on ferro-proteins. Likewise, the accumulation in soybean nodules of oxidized molecules, *e.g.*, lipid hydroperoxides, oxidized proteins (carbonyls), deamination products of DNA bases (xanthine and hypoxanthine), and catalytic Fe, shows that oxidative stress occurs during nodule senescence (Evans *et al.*, 1999). This view is also supported by the degradation of symbiosome membranes early in bean-nodule senescence (Puppo *et al.*, 1991) and the detection of protein free radicals in senescent soybean nodules (Mathieu *et al.*, 1998). In addition, programmed cell death (DNA cleavage), which co-localized with both cysteine protease transcripts and H_2O_2 accumulation, occurs in the periphery of the central zone in senescing soybean nodules (Alesandrini *et al.*, 2003). All these data clearly indicate generation of ROS during nodule senescence.

In contrast, cytochemical staining (Groten *et al.*, 2005) detected significant ROS (O_2^- radicals and H_2O_2) production only in the meristem and invasion zone of pea nodules. Furthermore, the staining intensity decreased with nodule development. No symptoms of oxidative damage (carbonyls) or programmed cell

death (DNA laddering) were seen during senescence, and it was concluded (Groten *et al.*, 2005) that natural ROS production underlies nodule development rather than triggering nodule senescence.

These discordant results for the nodules of various legumes (soybean or bean *versus* pea) may in part be due to differences between determinate and indeterminate nodules. However, detailed EM studies have shown that H₂O₂ also accumulates around degrading bacteroids in the senescent zone of alfalfa nodules (Rubio *et al.*, 2004). The roles of ROS, cysteine proteases, and programmed cell death in the senescence of the two nodule types require further clarification.

7.3. Production and Function of Reactive Nitrogen Species in Nodules

Early experiments on the inhibition of N₂ fixation by added nitrate detected nitrosyl complexes (Lb-NO) in extracts of soybean nodules; it was concluded that nitrite, which was formed from nitrate by the nitrate reductase of nodule host cells, was further reduced to NO (Kanayama *et al.*, 1990). Indeed, with *in vitro* experiments, the presence of dithiothreitol or ascorbate reduced nitrite to NO, which displaced O₂ from Lb-O₂ to form Lb-NO (Becana *et al.*, 1991; Kanayama and Yamamoto, 1990). Thus, nitrate inhibition of N₂-fixation could be explained by formation of Lb-NO in nitrate-treated nodules, which would interfere with the O₂-carrying function of Lb (Kanayama *et al.*, 1990; Kanayama and Yamamoto, 1991). The observation by the same authors that the equivalent of 10% of the Lb-NO concentration of nitrate-treated nodules was present in untreated nodules was not pursued.

The use of an assay system for NO detection, based on the oxidation of Hb-O₂ to ferric Hb, revealed that soluble extracts of lupin nodules and roots could generate NO (Cueto *et al.*, 1996). Such extracts catalyzed arginine conversion to citrulline (with Ca²⁺ and NADPH in the assay), which indicated the presence of NO synthase (NOS-like activity). The inhibition of the reaction by the specific NOS inhibitors N^G-monomethyl-arginine and N^G-nitroarginine methyl ester (arginine analogs) was reversible by increasing the arginine concentration, consistent with the presence of genuine NOS activity in the extracts. Mathieu *et al.* (1998) detected Lb-NO complexes in intact nodules by EPR spectroscopy and the signal intensity (assigned to an Fe-nitrosyl complex) decreased with nodule ageing, suggesting that NO plays a modulatory role in N₂ fixation. They also found that NO is produced in soybean nodules not treated with nitrate. These results suggest that the formation of Lb-NO should be considered as part of a physiological process, probably more relevant in early nodule development, rather than a mechanism by which nitrate inhibits N₂ fixation.

Nitric oxide can, thus, be produced in nodules in at least two ways; these are non-enzymatic reduction of nitrite and NOS activity. It is also very likely that nitrate reductase itself can generate NO from nitrite in nodules as in other plant organs. Indeed, there is a constitutive nitrate reductase in the host-cell cytosol and at least one bacteroid nitrate reductase (albeit not in all rhizobia) that is induced by nitrate and low O₂ (Becana *et al.*, 1989; Giannakis *et al.*, 1988). However, nitrate access to the infected zone of nodules seems to be restricted and most nitrate

accumulates in the cortex, so that, even when nitrate does reach the infected zone, little nitrite is produced (Arrese-Igor *et al.*, 1998; Becana *et al.*, 1989; Giannakis *et al.*, 1988). The small amount of nitrite formed in the infected zone may be sufficient to explain Lb-NO formation (Kanayama and Yamamoto, 1991), but the demonstrated NOS activity in nodules may well be the main source of NO rather than cytosolic or bacteroid nitrate reductases. This explanation would be consistent with the presence of the Lb-NO complex in nodules unexposed to nitrate.

What roles might NO and other RNS have in nodules? The detection of large amounts of Lb-NO in intact young nodules and the known roles of NO in organogenesis suggest that NO may function in nodule formation. However, why NO is not toxic (by interfering with Lb function) for nodule activity remains unclear. Nevertheless, NO metabolism is closely linked to at least some functions of Lb and non-symbiotic Hb. Application of an artificial NO donor (*S*-nitroso-*N*-acetyl-D,L-penicillamine) to uninoculated plants of *L. japonicus* induced expression of one of the two genes (*Hb1*) encoding non-symbiotic Hb (Shimoda *et al.*, 2005). This gene was also induced by hypoxia, cold stress, or inoculation with *M. loti*, and this induction was concomitant with the generation of NO. Thus, non-symbiotic Hb's and NO could have important roles in stress adaptation and in early stages of the *M. loti*-*L. japonicus* symbiosis. It might well be that, as occurs with animal Hb's, non-symbiotic Hb's (and possibly also Lb's) may modulate NO bioactivity by transporting it and extending its lifetime (Dordas *et al.*, 2003).

Biochemical studies *in vitro* with purified Lb show that Lb-O₂ scavenges NO, suggesting that Lb may help to stop the NO-mediated plant-defence reaction (Herold and Puppo, 2005a). The functionally inactive ferryl-Lb (formed *in vitro* by oxidation of ferric-Lb with H₂O₂) is reduced by NO. The physiological relevance of these findings is uncertain, but they suggest that NO and peroxynitrite could contribute to the regeneration of functional ferrous-Lb from the inactive forms of ferric- and ferryl-Lb (Herold and Puppo, 2005b). Interestingly, the non-symbiotic AHB1, but not AHB2, of *A. thaliana* can convert nitrite into RNS, which can then nitrate either the protein itself or other proteins (Sakamoto *et al.*, 2004). There may be a function of non-symbiotic Hb's that is related to RNS because tyrosine nitration by RNS appears now to be a post-translational protein modification regulating critical cell functions (Schopfer *et al.*, 2003). In summary, all these observations suggest that both non-symbiotic Hb's and Lb's may be involved in metabolism, transport, and signalling of RNS, in addition to other better known functions, such as the maintenance of the energy status of cells (Hbs) and the transport and delivery of O₂ to the symbiosomes at concentrations compatible with nitrogenase activity (Lbs).

8. ANTIOXIDANTS IN NODULES

8.1. Antioxidant Metabolites

Legume nodules contain a variety of enzymes and metabolites ("antioxidants") to prevent the formation of potentially toxic concentrations of ROS and subsequent

“oxidative stress”. This stress occurs when the antioxidant defences are overwhelmed by excessive ROS production and can be diagnosed by the accumulation of oxidized products of lipids (malondialdehyde, 4-hydroxynonenal), proteins (formation of carbonyl groups, and hydroxynonenal adducts), and DNA (8-hydroxyguanine, 8-oxoguanine, thymine glycol). Antioxidants also protect cell components from attack by RNS (“nitrosative stress”), evidenced by nitrosylated products of amino acids (3-nitrotyrosine) and DNA (nitration products of guanine). The oxidation (by ROS) or nitration (by RNS) of specific proteins may have either signalling or regulatory functions (Mittler *et al.*, 2004; Schopfer *et al.*, 2003).

Not surprisingly, antioxidants are ubiquitous in nodule cells, either associated with membranes or in soluble form in the cytosol and matrix of organelles. The most abundant water-soluble antioxidants in nodules are ascorbic acid (vitamin C) and glutathione (GSH; γ Glu-Cys-Gly), with average concentrations of 0.5-2 mM (Dalton *et al.*, 1986; Matamoros *et al.*, 2006).

Ascorbate can directly scavenge free radicals and other ROS, but is also required as a substrate in the ascorbate-GSH pathway for H₂O₂ detoxification (see section 7.2.). Its concentration is particularly high in the apex of indeterminate nodules and in the infected zone of both indeterminate and determinate nodules.

The thiol tripeptide GSH is an important antioxidant in its own right but also as a substrate for glutathione reductase and glutathione peroxidase (GPX) as described below. In some legumes, the homolog, homogluthathione (hGSH; γ Glu-Cys- β Ala), can be found instead of, or in addition to, GSH. Thus, hGSH is the major tripeptide in soybean, common bean, and mungbean (*Vigna radiata*) nodules, whereas GSH is predominant in pea, alfalfa, and cowpea nodules (Matamoros *et al.*, 1999). The synthesis of GSH and hGSH proceeds through two ATP-dependent steps catalyzed, respectively, by γ -glutamylcysteine synthetase (γ ECS) and by either a glutathione synthetase (GSHS) or a homogluthathione synthetase (hGSHS). The first enzyme is localized in the plastids and the second two enzymes in both the cytosol and plastids (Moran *et al.*, 2000).

Chromosome mapping, exon-intron composition, and detailed sequence analyses of the *GSHS* and *hGSHS* genes in model legumes reveal that they probably originated by duplication after legumes had diverged from other higher plants (Frendo *et al.*, 2001; Matamoros *et al.*, 2003a). Why the *hGSHS* gene was recruited during evolution only in legumes and why it is only expressed in some species or organs remain unanswered questions, but the differential expression of the two genes suggests specific roles for their products. Dissection of pea nodules has shown that the concentration of GSH is very high in the infected zone, high in the apex, and low in the senescent zone. In common-bean nodules, the hGSH concentration is higher in the infected tissue than in the cortex (Matamoros *et al.*, 1999). GSH and hGSH may, therefore, play direct roles in protecting the N₂-fixing zone, probably as antioxidants of the ascorbate-(h)GSH pathway, but may also function in nodule development. The use of *M. truncatula* transgenic roots with (*h*)*GSHS*-antisense constructs has shown that (h)GSH is required for nodule formation (Frendo *et al.*, 2005).

Bacteroids also have high GSH concentrations due to their own γ ECS and GSHS. They lack hGSHS and the significant amount of hGSH that has been found in bean-nodule bacteroids results from uptake from the host cells. GSH may be internally consumed by bacteroids in metabolic reactions and for the maintenance of cellular redox status rather than being exported. A mutant of *Rhizobium tropici* defective in GSHS contains only 3% of the GSH present in the wild-type strain (Riccillo *et al.*, 2000). This mutant is sensitive to weak organic acids and to osmotic and oxidative stress, but the addition of GSH restores stress tolerance to wild-type levels. Interestingly, the mutant forms effective nodules on bean but is outcompeted by the wild type, indicating that GSH is also important in the nodulation process.

Other metabolites in nodules have antioxidant properties, but little is known about their role *in vivo*. Uric acid is abundant in determinate nodules and is a powerful scavenger of peroxynitrite. Polyamine concentrations in nodules are 5-10 times higher than in other organs; their functions are unknown but there is evidence of an involvement in nodule development (Flemetakis *et al.*, 2004), in providing H_2O_2 (*via* diamine oxidase) for the insolubilization of the MGP within the infection threads (Wisniewski *et al.*, 2000), and in antioxidant defence (Fujihara *et al.*, 1994). Tocopherols (vitamin E) and ubiquinol-10 are also present in membranes of nodule cells, acting as chain-breaking antioxidants of lipid peroxidation. Flavonoids with diverse solubilities in the membrane and cytosol can also act as antioxidants and, in some cases, as chelators of Fe ions, thus, preventing toxic Fenton reactions, which otherwise might generate $\cdot OH$ radicals. Iron-chelating properties have also been reported for phytic acid, but its presence in nodules is unexplored.

8.2. Antioxidant Enzymes

Plants contain multiple antioxidant enzyme families with each member usually located in different subcellular compartments. The superoxide dismutase (SOD) family of metalloenzymes catalyze the dismutation of superoxide radicals into H_2O_2 , thus providing a primary defence against ROS. In plants, there are three types of SOD, which differ in the metal(s) at their catalytic site. All SOD isoforms have been found in nodules: (i) CuZn-SOD occurs in the cytosol, plastids, apoplast, and bacteroids; (ii) Mn-SOD is in the mitochondria, peroxisomes, and bacteroids (Figure 1D); and (iii) Fe-SOD is in the plastids and cytosol.

Mutants of *S. meliloti* deficient in Mn-SOD reveal that it is essential for nodule initiation (Santos *et al.*, 2000). In the plant fraction of alfalfa nodules (Rubio *et al.*, 2004), cytosolic CuZn-SOD (mRNA and protein) is expressed preferentially in the meristematic and invasion zones, whereas Mn-SOD occurs mainly in the infected zone. It, therefore, appears that cytosolic CuZn-SOD is mainly involved in early processes associated with nodule formation, whereas mitochondrial Mn-SOD is involved in the protection of infected cells against ROS.

Another group of important antioxidant enzymes of nodules are those involved in the ascorbate-GSH pathway. Ascorbate peroxidase (APX), dehydroascorbate reductase, monodehydroascorbate reductase, and glutathione reductase were all

initially found in the cytosol (Dalton *et al.*, 1986) and subsequently in mitochondria (Dalton *et al.*, 1993). Cytosolic APX is abundant (0.9% of total soluble protein) in nodules. This hemoprotein is not inactivated in the absence of ascorbate, unlike its chloroplast counterparts, and is predominantly localized (mRNA and protein) in the infected cells of nodules (Dalton *et al.*, 1998), consistent with participation of the ascorbate-GSH pathway in protecting N₂ fixation against ROS (Dalton *et al.*, 1986). The correlation between N₂ fixation and the enzyme activities of the ascorbate-GSH pathway, plus the fact that feeding ascorbate to nodules results in higher rates of N₂-fixation, nodule number, Lb content and APX activity, and delays nodule senescence (Swaraj and Garg, 1970; Bashor and Dalton, 1999), supports such a role. However, in nodules of alfalfa and possibly other legumes, APX (mRNA and protein) and ascorbate are abundant in some cell layers in the nodule inner cortex (nodule parenchyma), implying that APX could be involved as part of the ODB.

Much less is known about other enzymes of the ascorbate-GSH pathway. Monodehydroascorbate reductase is present in the cytosol and mitochondria but is also associated with the cell walls, where it may allow regeneration of the ascorbate used for proline hydroxylation for cell-wall proteins (extensins). Glutathione reductase is involved in the pathway, but also in the maintenance (and possibly regulation) of the activity of thiol-containing enzymes. Dehydroascorbate reductase is localized in the cytosol and mitochondria of nodules (Dalton *et al.*, 1993; Iturbe-Ormaetxe *et al.*, 2001).

All four enzymes of the ascorbate-GSH pathway are encoded by multigene families. To date, the nucleotide-sequence databases of the model legume *L. japonicus* contain partial or complete sequences of at least five genes for APX (isoforms in cytosol, stroma, thylakoids, peroxisomes and mitochondria), two for dehydroascorbate reductase (isoforms in cytosol, plastids and mitochondria), two for glutathione reductase (isoforms in cytosol and plastids), and three for monodehydroascorbate reductase (isoforms in cytosol, peroxisomes, plastids and mitochondria), but their differential expression in nodules has not been examined.

Catalases are hemoproteins of *ca.* 240 kDa that catalyze the decomposition of H₂O₂ to water and O₂. In plants, these enzymes are encoded by multigene families, are found in peroxisomes and glyoxysomes (although isoform CAT-3 occurs in the mitochondria of *Zea mays*; Scandalios *et al.*, 1980), and are regulated developmentally and in response to stress factors. Because catalases display low affinity for H₂O₂ (K_m= 40-80 mM) as compared with APX (apparent K_m=70 μM), they may only be efficient at sites with high rates of H₂O₂ formation. Both types of H₂O₂-scavenging enzymes may, therefore, function in a complementary way by having different subcellular locations and affinities for H₂O₂. In addition, APX requires ascorbate, whereas catalase needs no reductant. Where catalase is required in leaves to avoid necrotic lesions under high light conditions, the enzyme may function as a sink for H₂O₂ (Willekens *et al.*, 1997).

Little is known about catalases in nodules. Although abundant in the large peroxisomes of uninfected cells of determinate nodules, it is unclear if catalase activity occurs in nodule mitochondria. The three rhizobial catalases of *S. meliloti*, *i.e.*, the monofunctional catalases (KatA and KatC) and the bifunctional

catalase-peroxidase (KatB), are differentially regulated (Jamet *et al.*, 2003). KatA is induced by H₂O₂ and expressed in bacteroids, whereas KatB and KatC occur in the bacteria within infection threads. Either a *kata* or *katC* single mutant nodulates normally, *katAC* or *katBC* double mutants produce nodules with a dramatic decrease in N₂ fixation, and *katAB* mutants are not viable. All three catalases may, therefore, be required for symbiosis, possibly at different stages of infection and nodule formation.

Nodules also contain other types of heme peroxidases that have been associated, as for other plant organs, with metabolic processes taking place in the apoplast, cell walls, and vacuoles. For example, near maximal mRNA levels of the peroxidase gene *RIP1* occur *ca.* 3 h post-inoculation of *M. truncatula* roots with *S. meliloti* and are localized in the epidermal cells in the differentiating root zone to be infected by the bacteria (Cook *et al.*, 1995). This observation suggests a role for Rip1 in the ROS-mediated signalling pathway leading to nodule morphogenesis. Likewise, Staehelin *et al.* (1992) localized peroxidase (along with chitinase) primarily in the cortex of soybean nodules, with lower levels in the infected zone, and concluded that both enzymes were possibly part of the nodule's defences against external pathogens. Further localization studies of peroxidases, using higher resolution microscopy, are clearly needed to establish both its exact location and function.

Glutathione peroxidases (GPX) are a group of non-heme peroxidases that catalyze the reduction of H₂O₂, organic hydroperoxides, and lipid peroxides with GSH. Most plant GPX enzymes are markedly similar to animal phospholipid hydroperoxide glutathione peroxidases. These types of plant GPX are encoded by large multigene families, but their identification is difficult because of the high amino-acid homology between GPX and glutathione *S*-transferases. In *A. thaliana*, there are eight *GPX* genes (Rodriguez-Milla *et al.*, 2003, and GenBank database) and six orthologs have already been detected in *L. japonicus* (J. Ramos, M.A. Matamoros, and M. Becana, unpublished data). These genes are differentially expressed in leaves, roots, and nodules, but the isoform-specific functions (if any) remain unknown. In nodules, the mRNAs encoding GPX1 (plastidic isoform) and, in particular, GPX3 (cytosolic isoform) are the most abundant and their expression is responsive to salt stress.

Peroxiredoxins (Prx) are also a large family of non-heme peroxidases relying on an external electron donor (usually thioredoxin or glutaredoxin) to reduce organic peroxides to alcohols (Rouhier and Jacquot, 2002). The plant enzymes fall into four groups based on phylogenetic trees, subunit organization, and number of catalytic cysteine residues (Dietz, 2003). The 1-Cys Prx occur in the nucleus and are specifically expressed in the embryo and aleurone layer of developing seeds. The 2-Cys Prx and PrxQ are located in the chloroplasts. Finally, the type II Prx is a family of enzymes located in the cytosol (isoforms B, C and D), chloroplasts (isoform E), and mitochondria (isoform F). The PrxIIA isoform of *A. thaliana* may be encoded by a pseudogene. In nodules, Groten *et al.* (2006) detected PrxIIA and PrxIIF in pea nodules, using Western blots, and concluded that both Prx isoforms are differentially expressed in response to exogenous ascorbate. They did not detect PrxIIB, C or D in nodules at any stage of development.

8.3. Other Functions of “Antioxidants” in Nodules

In addition to either preventing the formation of toxic ROS and RNS or scavenging those that do form, most “antioxidant” metabolites and enzymes fulfill critical roles in plants, in part because of their ability to control the intracellular steady-state concentrations of the reactive species. ROS and RNS can act as secondary messengers and some antioxidants may, therefore, have an indirect role in molecular signalling by modulating their physiological concentrations. However, antioxidants may also have a more direct role as molecular signals because they can affect redox homeostasis and regulate the activity of transcription factors. Although ascorbate and GSH can trigger transcription of defence genes (Pastori *et al.*, 2003; Wingate *et al.*, 1988), little is known about the molecular mechanism. MAP kinases, intermediates in many plant-stress responses, may be involved but direct effects on redox-active residues in the transcription factors themselves are also likely.

Ascorbate and GSH are major antioxidants and redox buffers in plant cells but have many additional functions. Ascorbate is a cofactor of violaxanthin de-epoxidase (violaxanthin-zeaxanthin conversion), prolyl-hydroxylases (hydroxyproline synthesis), 1-amino-cyclopropane-1-carboxylate oxidase (ethylene synthesis), and 9-*cis*-epoxycarotenoid dioxygenase (abscisic acid synthesis); it is, therefore, involved in photoprotection, cell expansion, and plant development (Arrigoni and De Tullio, 2002; Conklin, 2001; Smirnov, 2000). These multiple roles have led to suggestions that ascorbate may be a signalling molecule involved in regulating complex plant processes, such as senescence, response to ozone, photo-oxidative conditions, or pathogen attack (Conklin and Barth, 2004; Pastori *et al.*, 2003; Smirnov, 2000).

The main pathway for ascorbate biosynthesis in plants involves a series of enzymatic reactions with D-mannose and L-galactose as precursors (Wheeler *et al.*, 1998). Recently, it has been proposed that mature nodules cannot synthesize ascorbate and need to import it from leaves or roots, which would allow ascorbate (probably in conjunction with abscisic acid and other hormones) to orchestrate nodule senescence (Groten *et al.*, 2005; Puppo *et al.*, 2005). The two main supporting observations are: (i) feeding excised pea nodules with the GalLDH substrate, L-galactono-1,4-lactone, shows that they have a very limited capacity to synthesize ascorbate compared with leaves or roots; and (ii) Western analysis with an antibody against maize GalLDH found the protein in leaves and roots but not in nodules. If correct, these findings have important implications. Thus, if nodule activity depends on plant-supplied ascorbate, nodule senescence could be delayed by manipulating their ascorbate content or their molecular cross-talk with the shoot or root. However, alfalfa nodule mitochondria have an active GalLDH enzyme, which is expressed at the mRNA and activity levels (in decreasing order) in the infected zone, the apex, and the senescent zone (Matamoros *et al.*, 2006). Interestingly, the distribution of ascorbate parallels that of GSH (Matamoros *et al.*, 1999), suggesting that both redox metabolites are intimately associated with nodule activity. The capacity of nodules to synthesize ascorbate probably decreases with age, but this cannot explain the negative results of Groten *et al.* (2005). Thus, in

bean nodules, the GalLDH activity at 6 weeks is still 80% of that at 3 weeks, suggesting that the capacity of mature nodules to synthesize ascorbate, albeit lower than in young nodules, is still sufficient to sustain nodule activity. Furthermore, ascorbate content and GalLDH activity are correlated in the various tissues of alfalfa and bean nodules, and the genes encoding some other important enzymes of ascorbate biosynthesis are functional in nodules (Matamoros *et al.*, 2006). In all, these findings support the operation of the Wheeler-Smirnoff pathway in legume nodules.

GSH is involved in the regulation of cell divisions in apical root meristems (Sánchez-Fernández *et al.*, 1997) and, thus, GSH (and probably hGSH) could also participate in cell division in the meristematic zone of nodules. Experimentally decreasing (h)GSH levels in *M. truncatula* roots either by treatment with buthionine sulfoximine (a specific inhibitor of γ ECS) or by expression of an antisense construct for (*h*)*GSHS* caused a marked decrease in nodule number and in early nodulin-gene expression, implying that (h)GSH is required for nodule development (Frendo *et al.*, 2005). This function of GSH and hGSH in nodule formation would be consistent with the high levels of both thiols in the apex of indeterminate nodules.

The two thiols also take part in plant defence against toxicity by heavy metals (cadmium, lead, and mercury). Thus, GSH and hGSH are precursors of phytochelatins, (γ Glu-Cys)₂₋₁₁-Glu, and homophytochelatins, (γ Glu-Cys)₂₋₁₁- β Ala, in a reaction catalyzed by phytochelatin synthases. These two types of polypeptides are synthesized by transfer of one glutamylcysteine (Glu-Cys) unit from a GSH molecule (donor) onto either another (h)GSH or onto a nascent (homo)phytochelatin molecule (acceptor), giving rise to a longer chain (homo)phytochelatin polypeptide. Legumes exposed to heavy metals rapidly synthesize (homo)phytochelatins, principally in the roots, but also in the nodules and leaves. The specific functions of the several phytochelatin synthases expressed in nodules and roots are unknown. The rapid mobilization of (h)GSH for (homo)phytochelatin synthesis after heavy metal treatment of plants makes this system very useful to study the regulation of the (h)GSH-biosynthetic pathway.

9. CONCLUDING REMARKS

9.1. Possible Signals for the Oxygen-diffusion Barrier

As mentioned in section 6, recent studies from Layzell's group have suggested that changes in the adenylate energy charge could act as signals for the ODB through alterations in K⁺ concentration that affect an osmotic component of the cortical barrier. However, it is more difficult to envisage how these changes could affect the level of intercellular space occlusions within the mid-cortex. Then again, Neo and Layzell (1997) exposed soybean and lupin plants to an atmosphere containing ammonia, which increased the concentrations of amino compounds (particularly amides) within the phloem sap and induced N-feedback regulation of nodule activity, which appeared to be operating through an increase in the resistance of the

ODB. Unfortunately, this work has not been followed up and no mechanism has yet been proposed for signalling of ODB operation by nitrogenous compounds.

One possibility is that N-feedback regulation operates, at least in part, through production of RNS, especially NO. This free radical can act as a signal molecule and also interacts with Lb (Herold and Puppo, 2005a), non-symbiotic Hbs (Dordas *et al.*, 2003), and thiols, such as GSH, to form nitrosothiols (Feechan *et al.*, 2005). These observations, along with the capacity of non-symbiotic Hb's to detect and protect against hypoxia (Hunt *et al.*, 2002), suggest a close association between the metabolism of O₂ (including ROS formation) and NO in nodules. The possibility that NO, or a product derived therefrom, is involved in O₂ regulation through the ODB certainly deserves a thorough investigation.

9.2. Is the Oxygen-diffusion Barrier Activated by Reactive Oxygen Species?

Several studies have reported a correlation between stress-induced increases in the resistance of the ODB and ROS-induced damage in legume nodules (Escuredo *et al.*, 1995; Gogorcena *et al.*, 1997; Matamoros *et al.*, 1999; Rubio *et al.*, 2002). However, it has yet to be determined if such correlations are causal or coincidental. It is possible that ROS are involved in the operation of the ODB, but evidence for this is indirect and rather fragmentary. There is, however, evidence that the ODB involves osmocontractile responses of the inner cortical cells (Denison and Kinraide, 1995; Serraj *et al.*, 1995; Wei and Layzell, 2006) and such responses would require rapid changes in membrane potentials and Ca²⁺/K⁺ shifts (Minchin *et al.*, 1995). Minchin (1997) proposed that the 'osmoelectrical' component of the ODB may involve ROS, especially H₂O₂, which is known to induce Ca²⁺ shifts (Price *et al.*, 1994). ROS could also be involved in other ODB components, such as the formation and/or hardening of intercellular occlusions through glycoprotein cross-linking (Bradley *et al.*, 1992; Brisson *et al.*, 1994), an idea supported by the localization of H₂O₂ within the intercellular spaces of the inner cortex of pea nodules (Rubio *et al.*, 2004) and *S. rostrata* stem nodules (Figure 1C). Ca²⁺ fluxes and membrane depolarization (caused by ROS?) are now implicated in other rapid plant responses, such as the signalling cascade initiated by Nod factors on legume root hairs (Cárdenas *et al.*, 2000) and the changes in Ca²⁺ and K⁺ efflux from guard cell vacuoles during stomatal closure (MacRobbie, 2002). Thus, the proposal (Minchin, 1997) that H₂O₂ could act as a universal signal for the cortical ODB still appears to be valid, although direct experimental evidence has yet to be produced.

Furthermore, the expression of APX (mRNA and protein) in alfalfa nodules is especially enhanced in the endodermis and infected cells (Dalton *et al.*, 1998) with cytochemical staining at the LM level also showing high levels of ascorbate, GSH, and respiratory activity in the endodermis and nearby cell layers (the "nodule parenchyma"). The enhanced antioxidant (especially APX and ascorbate) levels in the nodule parenchyma may, therefore, be induced by high levels of H₂O₂ as a result of enhanced respiratory activity (Dalton *et al.*, 1998). These co-localization studies support the suggestion (Minchin *et al.*, 1992) that the ODB has a respiratory component that reflects activity of the nodule parenchyma and vascular bundles.

Rapid respiration within the nodule parenchyma would be consistent with a “scavenging” or “protective” role of the ODB against excess O₂.

Interactions between ROS production and ODB operation may, therefore, be an important component of nodule activity regulation. Such interactions may also feature in both natural and stress-induced nodule senescence.

REFERENCES

- Alesandrini, F., Mathis, R., Van de Sype, G., Hérouart, D., and Puppo, A. (2003). Possible roles for a cysteine protease and hydrogen peroxide in soybean nodule development and senescence. *New Phytol.*, *158*, 131-138.
- Allison, F. E., Ludwig, C. A., Hoover, S. R., and Minor, F. W. (1940). Biochemical nitrogen fixation studies. I. Evidence for limited oxygen supply within the nodule. *Bot. Gaz.*, *101*, 513-534.
- Appleby, C. A. (1969). Properties of leghaemoglobin *in vivo* and its isolation as ferrous oxyleghaemoglobin. *Biochim. Biophys. Acta*, *188*, 222-229.
- Appleby, C. A. (1984). Leghemoglobin and *Rhizobium* respiration. *Annu. Rev. Plant Physiol.*, *35*, 443-478.
- Arrese-Igor, C., Royuela, M., de Lorenzo, C., de Felipe, M. R., and Aparicio-Tejo, P. M. (1993). Effect of low rhizosphere oxygen on growth, nitrogen fixation and nodule morphology in lucerne. *Physiol. Plant.*, *89*, 55-63.
- Arrese-Igor, C., Gordon, A. J., Minchin, F. R., and Denison, R. F. (1998). Nitrate entry and nitrite formation in the infected region of soybean nodules. *J. Exp. Bot.*, *49*, 41-48.
- Arrigoni, O., and De Tullio, M. C. (2002). Ascorbic acid: Much more than just an antioxidant. *Biochim. Biophys. Acta*, *1569*, 1-9.
- Atkins, C. A., Hunt, S., and Layzell, D. B. (1993). Gaseous diffusive properties of soybean nodules cultured with non-ambient pO₂. *Physiol. Plant.*, *87*, 89-95.
- Atkins, C. A., Smith, P., Mann, A., and Thumfort, P. (2001). Localization of carbonic anhydrase in legume nodules. *Plant Cell Environ.*, *24*, 317-326.
- Bashor, C. J., and Dalton, D. A. (1999). Effects of exogenous application and stem infusion of ascorbate on soybean (*Glycine max*) root nodules. *New Phytol.*, *142*, 19-26.
- Bauchrowitz, M. A., Barker, D. G., and Truchet, G. (1996). Lectin genes are expressed throughout root nodule development and during nitrogen-fixation in the *Rhizobium-Medicago* symbiosis. *Plant J.*, *9*, 31-43.
- Becana, M., Minchin, F. R., and Sprent, J. I. (1989). Short-term inhibition of legume N₂ fixation by nitrate. I. Nitrate effects on nitrate-reductase activities of bacteroids and nodule cytosol. *Planta*, *180*, 40-45.
- Becana, M., Salin, M. L., Ji, L., and Klucas, R. V. (1991). Flavin-mediated reduction of ferric leghemoglobin from soybean nodules. *Planta*, *183*, 575-583.
- Becana, M., and Klucas, R. V. (1992). Transition metals in legume root nodules: Iron-dependent free radical production increases during nodule senescence. *Proc. Natl. Acad. Sci. USA*, *89*, 8958-8962.
- Bergersen, F. J. (1962). The effects of partial pressure of oxygen upon respiration and nitrogen fixation by soybean root nodules. *J. Gen. Microbiol.*, *29*, 113-125.
- Bergersen, F. J. (1994). Distribution of O₂ within infected cells of soybean root nodules: A new simulation. *Protoplasma*, *183*, 49-61.
- Bergersen, F. J., and Goodchild, D. J. (1973). Aeration pathways in soybean root nodules. *Aust. J. Biol. Sci.*, *26*, 729-740.
- Bestwick, C. S., Brown, I. R., Bennett, M. R., and Mansfield, J. W. (1997). Localization of hydrogen peroxide accumulation during the hypersensitive reaction of lettuce cells to *Pseudomonas syringae* pv. *phaseolicola*. *Plant Cell*, *9*, 209-221.
- Bisseling, T., Moen, A. A., Van Den Bos, R. C., and Van Kammen, A. (1980). The sequence of appearance of leghaemoglobin and nitrogenase components I and II in root nodules of *Pisum sativum*. *J. Gen. Microbiol.*, *118*, 377-381.
- Blilou, I., Ocampo, J. A., and Garcia-Garrido, J. M. (1999). Resistance of pea roots to endomycorrhizal fungus or *Rhizobium* correlates with enhanced levels of endogenous salicylic acid. *J. Exp. Bot.*, *50*, 1663-1668.

- Bond, G. (1951). Symbiosis of leguminous plants and nodule bacteria. IV. The importance of the oxygen factor in nodule formation and function. *Ann. Bot.*, 15, 95-108.
- Bonilla, I., Mergold-Villaseñor, C., Campos, M. E., Sánchez, N., Pérez, H., *et al.* (1997). The aberrant cell walls of boron-deficient bean root nodules have no covalently bound hydroxyproline-/proline-rich proteins. *Plant Physiol.*, 115, 1329-1340.
- Bradley, D. J., Kjellbom, P., and Lamb, C. J. (1992). Elicitor and wound-induced oxidative cross-linking of a proline-rich plant cell wall protein: a novel, rapid defense response. *Cell*, 70, 21-30.
- Brewin, N. J. (1991). Development of the legume root nodule. *Annu. Rev. Cell Biol.*, 7, 191-226.
- Brisson, L. F., Tenhaken, R., and Lamb, C. J. (1994). Function of oxidative cross-linking of cell wall structural proteins in plant disease resistance. *Plant Cell*, 6, 1703-1712.
- Brito, B., Palacios, J. M., Imperial, J., Ruiz-Argueso, T., Yang, W.-C., Bisseling, T., *et al.* (1995). Temporal and spatial co-expression of hydrogenase and nitrogenase genes from *Rhizobium leguminosarum* bv. *viciae* in pea (*Pisum sativum* L.) root nodules. *Mol. Plant-Microbe Interact.*, 8, 235-240.
- Brown, S. M., and Walsh, K. B. (1994). Anatomy of the legume nodule cortex with respect to nodule permeability. *Aust. J. Plant Physiol.*, 21, 49-68.
- Brown, S. M., and Walsh, K. B. (1996). Anatomy of the legume nodule cortex: species survey of suberisation and intercellular glycoprotein. *Aust. J. Plant Physiol.*, 23, 211-225.
- Brown, S. M., Chudek, J. A., Hunter, G., Sprent, J. I., Walsh, K. B., and Wurtz, G. (1997). Proton density and apoplastic domains within soybean nodules in relation to the oxygen diffusion barrier. *Plant Cell Environ.*, 20, 1019-1029.
- Brundrett, M. C., Enstone, D. E., and Peterson, C. A. (1988). A berberine-aniline blue fluorescent staining procedure for suberin, lignin and callose in plant tissues. *Protoplasma*, 146, 133-142.
- Bueno, P., Soto, M. J., Rodríguez-Rosales, M. P., Sanjuan, J., Olivares, J., and Donaire, J. P. (2001). Time-course of lipoxygenase, antioxidant enzyme activities and H₂O₂ accumulation during the early stages of *Rhizobium*-legume symbiosis. *New Phytol.*, 152, 91-96.
- Cárdenas, L., Holdaway-Clarke, T. L., Sánchez, F., Quinto, C., Feijó, J. A., Kunkel, J. G., *et al.* (2000). Ion changes in legume root hairs responding to Nod factors. *Plant Physiol.*, 123, 443-451.
- Chen, R., Silver, D. L., and de Bruijn, F. J. (1998). Nodule parenchyma-specific expression of the *Sesbania rostrata* early nodulin gene *SrEnod2* is mediated by its 3' untranslated region. *Plant Cell*, 10, 1585-1602.
- Cook, D., Dreyer, D., Bonnet, D., Howell, M., Nony, E., and VandenBosch, K. (1995). Transient induction of a peroxidase gene in *Medicago truncatula* precedes infection by *Rhizobium meliloti*. *Plant Cell*, 7, 43-55.
- Conklin, P. L. (2001). Recent advances in the role and biosynthesis of ascorbic acid in plants. *Plant Cell Environ.*, 24, 383-394.
- Conklin, P. L., and Barth, C. (2004). Ascorbic acid, a familiar small molecule intertwined in the response of plants to ozone, pathogens, and the onset of senescence. *Plant Cell Environ.*, 27, 959-970.
- Corpas, F. J., Barroso, J. B., and del Río, L. A. (2001). Peroxisomes as a source of reactive oxygen species and nitric oxide signal molecules in plant cells. *Trends Plant Sci.*, 6, 145-150.
- Cueto, M., Hernández-Perera, O., Martín, R., Bentura, M. L., Rodrigo, J., Lamas, S., *et al.* (1996). Presence of nitric oxide synthase activity in roots and nodules of *Lupinus albus*. *FEBS Lett.*, 398, 159-164.
- Dakora, F. D., and Atkins, C. A. (1990a). Morphological and structural adaptation of nodules of cowpea to functioning under sub- and supra-ambient oxygen pressure. *Planta*, 182, 572-582.
- Dakora, F. D., and Atkins, C. A. (1990b). Effect of pO₂ on growth and nodule functioning of symbiotic cowpea (*Vigna unguiculata* L. Walp). *Plant Physiol.*, 93, 948-955.
- Dakora, F. D., and Atkins, C. A. (1991). Adaptation of nodulated soybean (*Glycine max* L. Merr.) to growth in rhizospheres containing nonambient pO₂. *Plant Physiol.*, 96, 728-736.
- Dakora, F. D., Appleby, C. A., and Atkins, C. A. (1991). Effect of pO₂ on the formation and status of leghemoglobin in nodules of cowpea and soybean. *Plant Physiol.*, 95, 723-730.
- Dalton, D. A., Russell, S. A., Hanus, F. J., Pascoe, G. A., and Evans, H. J. (1986). Enzymatic reactions of ascorbate and glutathione that prevent peroxide damage in soybean root nodules. *Proc. Natl. Acad. Sci. USA*, 83, 3811-3815.
- Dalton, D. A., Baird, L. M., Langeberg, L., Taugher, C. Y., Anyan, W. R., Vance, C. P., *et al.* (1993). Subcellular localization of oxygen defense enzymes in soybean (*Glycine max* [L.] Merr.) root nodules. *Plant Physiol.*, 102, 481-489.

- Dalton, D. A., Joyner, S. L., Becana, M., Iturbe-Ormaetxe, I., and Chatfield, J. M. (1998). Antioxidant defenses in the peripheral cell layers of legume root nodules. *Plant Physiol.*, 116, 37-43.
- D'Haese, W., De Rycke, R., Mathis, R., Goormachtig, S., Pagnotta, S., Verplancke, C., *et al.* (2003). Reactive oxygen species and ethylene play a positive role in lateral root base modulation of a semiaquatic legume. *Proc. Natl. Acad. Sci. USA*, 100, 11789-11794.
- de Billy, F., Barker, D. G., Gallusci, P., and Truchet, G. (1991). Leghaemoglobin gene transcription is triggered in a single cell layer in the indeterminate nitrogen-fixing root nodule of alfalfa. *Plant J.*, 1, 27-35.
- de Faria, S. M., McInroy, S. G., and Sprent, J. I. (1987). The occurrence of infected cells with persistent infection threads in legume root nodules. *Can. J. Bot.*, 65, 553-558.
- de Lorenzo, C., Iannetta, P. P. M., Fernandez-Pascual, M., James, E. K., Lucas, M. M., Sprent, J. I., *et al.* (1993). Oxygen diffusion in lupin nodules. II. Mechanisms of diffusion barrier operation. *J. Exp. Bot.*, 44, 1469-1474.
- de Lorenzo, C., Fernandez-Pascual, M., and de Felipe, M. R. (1998). Subcellular localization of glycoprotein epitopes during the development of lupin root nodules. *Protoplasma*, 201, 71-84.
- Denison, R. F., and Kinraide, T. B. (1995). Oxygen-induced membrane depolarizations in legume root nodules: Possible evidence for an osmoelectrical mechanism controlling nodule gas permeability. *Plant Physiol.*, 108, 235-240.
- Denison, R. F., and Layzell, D. B. (1991). Measurement of legume nodule respiration and O₂ permeability by noninvasive spectrophotometry of leghemoglobin. *Plant Physiol.*, 96, 137-143.
- Denison, R. F., and Okano, Y. (2003). Leghaemoglobin oxygenation gradients in alfalfa and yellow sweetclover nodules. *J. Exp. Bot.*, 54, 1085-1091.
- Denison, R. F., Smith, D. L., and Layzell, D. B. (1991). Noninvasive measurement of internal oxygen concentrations of field-grown soybean nodules. *Agron. J.*, 83, 166-169.
- Denison, R. F., Witty, J. F., and Minchin, F. R. (1992). Reversible O₂ inhibition of nitrogenase activity in attached soybean nodules. *Plant Physiol.*, 100, 1863-1868.
- Dietz, K.-J. (2003). Plant peroxiredoxins. *Annu. Rev. Plant Biol.*, 54, 93-107.
- Ditta, G., Virts, E., Palomares, A., and Kim, C. H. (1987). The *nifA* gene of *Rhizobium meliloti* is oxygen regulated. *J. Bacteriol.*, 169, 3217-3223.
- Dixon, R. O. D., Blunden, E. A. G., and Searl, J. W. (1981). Intercellular space and hydrogen diffusion in pea and lupin root nodules. *Plant Sci. Lett.*, 23, 109-116.
- Doke, N. (1983). Involvement of superoxide anion generation in the hypersensitive response of potato tuber tissues to infection with an incompatible race of *Phytophthora infestans* and to the hyphal wall components. *Physiol. Plant Pathol.*, 23, 345-357.
- Dordas, C., Rivoal, J., and Hill, R. D. (2003). Plant haemoglobins, nitric oxide and hypoxic stress. *Ann. Bot.*, 91, 173-178.
- Escuredo, P. R., Minchin, F. R., Gogorcena, Y., Iturbe-Ormaetxe, I., Klucas, R. V., and Becana, M. (1996). Involvement of activated oxygen in nitrate-induced senescence of pea root nodules. *Plant Physiol.*, 110, 1187-1195.
- Evans, P. J., Gallesi, D., Mathieu, C., Hernández, M. J., de Felipe, M. R., Halliwell, B., *et al.* (1999). Oxidative stress occurs during soybean nodule senescence. *Planta*, 208, 73-79.
- Federova, M., Tikhonovich, I. A., and Vance, C. P. (1999). Expression of C-assimilating enzymes in pea (*Pisum sativum* L.) root nodules. In situ localization in effective nodules. *Plant Cell Environ.*, 22, 1249-1262.
- Feechan, A., Kwon, E., Yun, B.-W., Wang, Y., Pallas, J. A., and Loake, G. J. (2005). A central role for S-nitrosothiols in plant disease resistance. *Proc. Natl. Acad. Sci. USA*, 102, 8054-8059.
- Ferguson, T. P., and Bond, G. (1954). Symbiosis of leguminous plants and nodule bacteria. V. The growth of red clover at different oxygen tensions. *Ann. Bot.*, 18, 385-396.
- Fernández-Pascual, M., de Lorenzo, C., Pozuelo, J. M., and de Felipe, M. R. (1992). Alterations induced by four herbicides on lupin nodule cortex structure, protein metabolism and some senescence-related enzymes. *J. Plant Physiol.*, 140, 385-390.
- Fernández-Pascual, M., de Lorenzo, C., de Felipe, M. R., Rajalakshmi, S., Gordon, A. J., Thomas, B. J., *et al.* (1996). Possible reasons for relative salt stress tolerance in nodules of white lupin cv. Multolupa. *J. Exp. Bot.*, 47, 1709-1716.
- Flemetakis, E., Efröse, R. C., Desbrosses, G., Dimou, M., Delis, C., Aivalakis, G., *et al.* (2004). Induction and spatial organization of polyamine biosynthesis during nodule development in *Lotus japonicus*. *Mol. Plant-Microbe Interact.*, 17, 1283-1293.

- Fleurat-Lessard, P., Michonnnneau, P., Mashima, M., Drevon, J.-J., and Serraj, R. (2005). The distribution of aquaporin subtypes (PIP1, PIP2 and α -TIP) is tissue dependent in soybean (*Glycine max*) root nodules. *Ann. Bot.* 96, 457-460.
- Franco-Vizcaino, E., Deal, W. J., and Jarrell, W. M. (1988). Fiber-optic spectrophotometry of cowpea nodules treated with nitrate or ammonium. *Commun. Soil Plant Anal.*, 19, 691-706.
- Frazier, H. L. (1942). The occurrence of endodermis in leguminous root nodules and its effect upon nodule function. *Proc. Roy. Soc. Edin. (B)*, 61, 328-343.
- Frendo, P., Hernández-Jiménez, M., Mathieu, C., Duret, L., Gallesi, D., Van de Sype, G., et al. (2001). A *Medicago truncatula* homogluthathione synthetase is derived from glutathione synthetase by gene duplication. *Plant Physiol.*, 126, 1706-1715.
- Frendo, P., Harrison, J., Norman, C., Hernández-Jiménez, M. J., Van de Sype, G., Gilbert, A., et al. (2005). Glutathione and homogluthathione play a critical role in the nodulation process of *Medicago truncatula*. *Mol. Plant-Microbe-Interact.*, 18, 254-259.
- Fujihara, S., Abe, H., Minakawa, Y., Akao, S., and Yoneyama, T. (1994). Polyamines in nodules from various plant-microbe interactions. *Plant Cell Physiol.*, 35, 1127-1134.
- Gálvez, S., Hirsch, A. M., Wycoff, K. L., Hunt, S., Layzell, D. B., et al. (2000). Oxygen regulation of a nodule-located carbonic anhydrase in alfalfa. *Plant Physiol.*, 124, 1059-1068.
- Giannakis, C., Nicholas, D. J. D., and Wallace, W. (1988). Utilization of nitrate by bacteroids of *Bradyrhizobium japonicum* in the soybean root nodule. *Planta*, 174, 51-58.
- Gogorcena, Y., Gordon, A. J., Escuredo, P. R., Minchin, F. R., Witty, J. F., Moran, J. F., and Becana, M. (1997). N₂ fixation, carbon metabolism, and oxidative damage in nodules of dark-stressed common bean plants. *Plant Physiol.*, 113, 1193-1201.
- González, J. E., Reuhs, B. L., and Walker, G. C. (1996). Low molecular weight EPSII of *Rhizobium meliloti* allows nodule invasion in *Medicago sativa*. *Proc. Natl. Acad. Sci. USA*, 93, 8636-8641.
- Goormachtig, S., Van Montagu, M., and Holsters, M. (1998). The early nodulin gene *ENOD2* shows different expression patterns during *Sesbania rostrata* stem nodule development. *Mol. Plant-Microbe Interact.*, 11, 237-241.
- Gordon, A. J., Thomas, B. J., and Reynolds, P. H. S. (1992). Localization of sucrose synthase in soybean root nodules. *New Phytol.*, 122, 35-44.
- Grandmaison, J., and Ibrahim, R. (1995). Ultrastructural localization of a diprenylated isoflavone in *Rhizobium lupini-Lupinus albus* symbiotic association. *J. Exp. Bot.*, 46, 231-237.
- Groten, K., Vanacker, H., Dutilleul, C., Bastian, F., Bernard, S., Carzaniga, R., et al. (2005). The roles of redox processes in pea nodule development and senescence. *Plant Cell Environ.*, 28, 1293-1304.
- Groten, K., Dutilleul, C., van Heerden, P. D. R., Vanacker, H., Bernard, S., Finkemeier, I., et al. (2006). Redox regulation of peroxiredoxin and proteinases by ascorbate and thiols during pea root nodule senescence. *FEBS Lett.*, 580, 1269-1276.
- Halliwell, B., and Gutteridge, J. M. (1984). Oxygen toxicity, oxygen radicals, transition metals and disease. *Biochem. J.*, 219, 1-14.
- Hartmann, K., Peiter, E., Koch, K., Schubert, S., and Schreiber, L. (2002). Chemical composition and ultrastructure of broad bean (*Vicia faba* L.) nodule endodermis in comparison to the root endodermis. *Planta*, 215, 14-25.
- Hernández-Jiménez, M. J., Lucas, M. M., and de Felipe, M. R. (2002). Antioxidant defence and damage in senescing lupin nodules. *Plant Physiol. Biochem.*, 40, 645-657.
- Herold, S., and Puppo, A. (2005a). Oxyleghemoglobin scavenges nitrogen monoxide and peroxynitrite: A possible role in functioning nodules? *J. Biol. Inorg. Chem.*, 10, 935-945.
- Herold, S., and Puppo, A. (2005b). Kinetics and mechanistic studies of the reactions of metleghemoglobin, ferrylleghemoglobin, and nitrosylleghemoglobin with reactive nitrogen species. *J. Biol. Inorg. Chem.*, 10, 946-957.
- Hunt, S., and Layzell, D. B. (1993). Gas exchange of legume nodules and the regulation of nitrogenase activity. *Annu. Rev. Plant Physiol. Mol. Biol.*, 44, 483-511.
- Hunt, P. W., Klok, E. J., Trevasakis, B., Watts, R. A., Ellis, M. H., Peacock, W. J., et al. (2002). Increased level of hemoglobin 1 enhances survival of hypoxic stress and promotes early growth in *Arabidopsis thaliana*. *Proc. Natl. Acad. Sci. USA*, 99, 17197-17202.
- Iannetta, P. P. M., James, E. K., McHardy, P. D., Sprent, J. I., and Minchin, F. R. (1993a). An ELISA procedure for quantification of relative amounts of intercellular glycoprotein in legume nodules. *Ann. Bot.*, 71, 85-90.

- Iannetta, P. P. M., de Lorenzo, C., James, E. K., Fernández-Pascual, M., Sprent, J. I., *et al.* (1993b). Oxygen diffusion in lupin nodules. I. Visualisation of diffusion barrier operation. *J. Exp. Bot.*, *44*, 1461-1467.
- Iannetta, P. P. M., James, E. K., Sprent, J. I., and Minchin, F. R. (1995). Time course of changes involved in the operation of the oxygen diffusion barrier in white lupin nodules. *J. Exp. Bot.*, *46*, 565-575.
- Iturbe-Ormaetxe, I., Matamoros, M. A., Rubio, M. C., Dalton, D. A., and Becana, M. (2001). The antioxidants of legume nodule mitochondria. *Mol. Plant-Microbe Interact.*, *14*, 1189-1196.
- Jacobsen, K. R., Rousseau, R. A., and Denison, R. F. (1998). Tracing the path of oxygen into birdsfoot trefoil and alfalfa nodules using iodine vapor. *Bot. Acta*, *111*, 193-203.
- James, E. K., and Crawford, R. M. M. (1998). Effect of oxygen availability on nitrogen fixation by two *Lotus* species under flooded conditions. *J. Exp. Bot.*, *49*, 599-610.
- James, E. K., and Sprent, J. I. (1999). Development of N₂-fixing nodules on the wetland legume *Lotus uliginosus* exposed to conditions of flooding. *New Phytol.*, *142*, 219-231.
- James, E. K., Sprent, J. I., Minchin, F. R., and Brewin, N. J. (1991). Intercellular location of glycoprotein in soybean nodules: Effect of altered rhizosphere oxygen concentration. *Plant Cell Environ.*, *14*, 467-476.
- James, E. K., Sprent, J. I., Sutherland, J. M., McNroy, S. G., and Minchin, F. R. (1992a). The structure of nitrogen fixing root nodules on the aquatic Mimosoid legume *Neptunia plena*. *Ann. Bot.*, *69*, 173-180.
- James, E. K., Minchin, F. R., and Sprent, J. I. (1992b). The physiology and nitrogen-fixing capability of aquatically and terrestrially grown *Neptunia plena*: The importance of nodule oxygen supply. *Ann. Bot.*, *69*, 181-187.
- James, E. K., Iannetta, P. P. M., Naisbitt, T., Goi, S. R., Sutherland, J. M., Sprent, J. I., *et al.* (1994). A survey of N₂-fixing nodules in the leguminosae with particular reference to intercellular glycoproteins and the control of oxygen diffusion. *Proc. Roy. Soc. Edin. (B)*, *102*, 429-432.
- James, E. K., Iannetta, P. P. M., Nixon, P. J., Whiston, A. J., Peat, L., Crawford, R. M. M., *et al.* (1996). Photosystem II and oxygen regulation in *Sesbania rostrata* stem nodules. *Plant Cell Environ.*, *19*, 895-910.
- James, E. K., Minchin, F. R., Iannetta, P. P. M., and Sprent, J. I. (1997). Temporal relationships between nitrogenase and intercellular glycoprotein in developing white lupin nodules. *Ann. Bot.*, *79*, 493-503.
- James, E. K., Minchin, F. R., Oxborough, K., Cookson, A., Baker, N. R., Witty, J. F., *et al.* (1998). Photosynthetic oxygen evolution within *Sesbania rostrata* stem nodules. *Plant J.*, *13*, 29-38.
- James, E. K., Iannetta, P. P. M., Deeks, L., Sprent, J. I., and Minchin, F. R. (2000). Detopping causes production of intercellular space occlusions in both the cortex and infected region of soybean nodules. *Plant Cell Environ.*, *23*, 377-386.
- Jamet, A., Sigaud, S., Van de Sype, G., Puppo, A., and Hérouart, D. (2003). Expression of the bacterial catalase genes during *Sinorhizobium meliloti*-*Medicago sativa* symbiosis and their crucial role during the infection process. *Mol. Plant-Microbe Interact.*, *16*, 217-225.
- Kanayama, Y., Watanabe, I., and Yamamoto, Y. (1990). Inhibition of nitrogen fixation in soybean plants supplied with nitrate. I. Nitrite accumulation and formation of nitrosylleghemoglobin in nodules. *Plant Cell Physiol.*, *31*, 341-346.
- Kanayama, Y., and Yamamoto, Y. (1990). Inhibition of nitrogen fixation in soybean plants supplied with nitrate. II. Accumulation and properties of nitrosyl leghemoglobin in nodules. *Plant Cell Physiol.*, *31*, 207-214.
- Kanayama, Y., and Yamamoto, Y. (1991). Formation of nitrosylleghemoglobin in nodules of nitrate-treated cowpea and pea plants. *Plant Cell Physiol.*, *32*, 19-24.
- Kavroulakis, N., Fletmetakis, E., Aivalakis, G., Dahiya, P., Brewin, N. J., Fasseas, K., *et al.* (2003). Tissue distribution and subcellular localization of carbonic anhydrase in mature soybean root nodules indicates a role in CO₂ diffusion. *Plant Physiol. Biochem.*, *41*, 479-484.
- Kawashima, K., Suganuma, N., Tamaoki, M., and Kouchi, H. (2001). Two types of pea leghemoglobin genes showing different O₂-binding affinities and distinct patterns of spatial expression in nodules. *Plant Physiol.*, *125*, 641-651.
- King, B. J., Hunt, S., Weagle, G. E., Walsh, K. B., Pottier, R. H., Canvin, D. T., and Layzell, D. B. (1988). Regulation of O₂ concentration in soybean nodules observed by *in situ* spectroscopic measurement of leghemoglobin oxygenation. *Plant Physiol.*, *87*, 296-299.

- Klucas, R. V., Lee, K. K., Saari, L., and Erickson, B. K. (1985). Factors affecting functional leghemoglobin in legume nodules. In P. W. Ludden and J. E. Burris (Eds.) *Nitrogen fixation and CO₂ metabolism* (pp. 13-20). New York, NY: Elsevier.
- Kuzma, M. M., Winter, H., Storer, P., Oresnik, I., Atkins, C. A., and Layzell, D. B. (1999). The site of oxygen limitation in soybean nodules. *Plant Physiol.*, *119*, 399-407.
- Lamb, C., and Dixon, R. A. (1997). The oxidative burst in plant disease resistance. *Annu. Rev. Plant Physiol. Plant Mol. Biol.*, *48*, 251-275.
- Lauridsen, P., Franssen, H., Stougaard, J., Bisseling, T., and Marcker, K. A. (1993). Conserved regulation of the soybean early nodulin *ENOD2* gene promoter in determinate and indeterminate transgenic root nodules. *Plant J.*, *3*, 483-492.
- Layzell, D. B., Hunt, S., and Palmer, G. R. (1990). Mechanisms of nitrogenase inhibition of soybean nodules. Pulse-modulated spectroscopy indicates that nitrogenase activity is limited by O₂. *Plant Physiol.*, *92*, 1101-1107.
- Loureiro, M. F., de Faria, S. M., James, E. K., Pott, A., and Franco, A. A. (1994). Nitrogen-fixing stem nodules of the legume, *Discolobium pulchellum* Benth. *New Phytol.*, *128*, 283-295.
- Loureiro, M. F., James, E. K., Sprent, J. I., and Franco, A. A. (1995). Stem and root nodules on the tropical wetland legume *Aeschynomene fluminensis*. *New Phytol.*, *130*, 531-544.
- MacFall, J. S., Pfeffer, P. E., Rolin, D. B., MacFall, J. R., and Johnson, G. A. (1992). Observation of the oxygen diffusion barrier in soybean (*Glycine max*) nodules with magnetic resonance microscopy. *Plant Physiol.*, *100*, 1691-1697.
- MacRobbie, E. A. C. (2002). Evidence for a role for protein tyrosine phosphatase in the control of ion release from the guard cell vacuole in stomatal closure. *Proc. Natl. Acad. Sci. USA*, *99*, 11963-11968.
- Martínez-Abarca, F., Herrera-Cervera, J. A., Bueno, P., Sanjuan, J., Bisseling, T., and Olivares, J. (1998). Involvement of salicylic acid in the establishment of the *Rhizobium meliloti*-alfalfa symbiosis. *Mol. Plant-Microbe Interact.*, *11*, 153-155.
- Masepohl, B., Witty, J. F., Riedel, K.-U., Klipp, W., and Pühler, A. (1993). *Rhizobium meliloti* mutants defective in symbiotic nitrogen fixation affect the oxygen gradient in alfalfa (*Medicago sativa*) root nodules. *J. Exp. Bot.*, *44*, 419-426.
- Matamoros, M. A., Baird, L. M., Escuredo, P. R., Dalton, D. A., Minchin, F. R., Iturbe-Ormaetxe, I., et al. (1999a). Stress-induced legume root nodule senescence. Physiological, biochemical and structural alterations. *Plant Physiol.*, *121*, 97-111.
- Matamoros, M. A., Moran, J. F., Iturbe-Ormaetxe, I., Rubio, M. C., and Becana, M. (1999b). Glutathione and homogluthathione synthesis in legume root nodules. *Plant Physiol.*, *121*, 879-888.
- Matamoros, M. A., Clemente, M. R., Sato, S., Asamizu, E., Tabata, S., Ramos, J., et al. (2003a). Molecular analysis of the pathway for the synthesis of thiol tripeptides in the model legume *Lotus japonicus*. *Mol. Plant-Microbe Interact.*, *16*, 1039-1046.
- Matamoros, M. A., Dalton, D. A., Ramos, J., Clemente, M. R., Rubio, M. C., and Becana, M. (2003b). Biochemistry and molecular biology of antioxidants in the rhizobia-legume symbiosis. *Plant Physiol.*, *133*, 499-509.
- Matamoros, M. A., Loscos, J., Coronado, M. J., Ramos, J., Sato, S., Testillano, P. S., et al. (2006). Biosynthesis of ascorbic acid in legume root nodules. *Plant Physiol.*, *141*, 1068-1077.
- Mathieu, C., Moreau, S., Frendo, P., Puppo, A., and Davies, M. J. (1998). Direct detection of radicals in intact soybean nodules: presence of nitric oxide-leghemoglobin complexes. *Free Rad. Biol. Med.*, *24*, 1242-1249.
- Millar, A. H., Day, D. A., and Bergersen, F. J. (1995). Microaerobic respiration and oxidative phosphorylation by soybean nodule mitochondria: Implications for nitrogen fixation. *Plant Cell Environ.*, *18*, 715-726.
- Minchin, F. R., Iannetta, P. P. M., Fernández-Pascual, M., de Lorenzo, C., Witty, J. F., and Sprent, J. I. (1992). A new procedure for the calculation of oxygen diffusion resistance in legume nodules from flow-through gas analysis data. *Ann. Bot.*, *70*, 283-289.
- Minchin, F. R., Thomas, B. J., and Mytton, L. R. (1995). Ion distribution across the cortex of soybean nodules: Possible involvement in control of oxygen diffusion. *Ann. Bot.*, *74*, 613-617.
- Minchin, F. R. (1997). Regulation of oxygen diffusion in legume nodules. *Soil Biol. Biochem.*, *29*, 881-888.
- Mithöfer, A. (2002). Suppression of plant defence in rhizobia-legume symbiosis. *Trends Plant Sci.*, *7*, 440-444.

- Mittler, R., Vanderauwera, S., Gollery, M., and Van Breusegem, F. (2004). Reactive oxygen gene network of plants. *Trends Plant Sci.*, *9*, 490-498.
- Monroe, J. D., Owens, T. G., and La Rue, T. A. (1989). Measurement of the fractional oxygenation of leghemoglobin in intact detached pea nodules by reflectance spectroscopy. *Plant Physiol.*, *91*, 598-602.
- Moran, J. F., Iturbe-Ormaetxe, I., Matamoros, M. A., Rubio, M. C., Clemente, M. R., Brewin, N. J., *et al.* (2000). Glutathione and homogluthathione synthetases of legume nodules. Cloning, expression, and subcellular localization. *Plant Physiol.*, *124*, 1381-1392.
- Mylona, P., Pawlowski, K., and Bisseling, T. (1995). Symbiotic nitrogen fixation. *Plant Cell*, *7*, 869-885.
- Naisbitt, T., James, E. K., and Sprent, J. I. (1992). The evolutionary significance of the genus *Chamaecrista* as determined by nodule structure. *New Phytol.*, *122*, 487-492.
- Ndoye, I., de Billy, F., Vasse, J., Dreyfus, B., and Truchet, G. (1994). Root nodulation of *Sesbania rostrata*. *J. Bacteriol.*, *176*, 1060-1068.
- Neo, H.-H., and Layzell, D. B. (1997). Phloem glutamine and the regulation of O₂ diffusion in legume nodules. *Plant Physiol.*, *113*, 259-267.
- Newcomb, E. H., Kaneko, Y., and VandenBosch, K. A. (1989). Specialization of the inner cortex for ureide production in soybean root nodules. *Protoplasma*, *150*, 150-159.
- Olsson, P. A., Kjellbom, P., and Rosendahl, L. (2002). *Rhizobium* colonization induced changes in membrane-bound and soluble hydroxyproline-rich glycoprotein composition in pea. *Physiol. Plant.*, *114*, 652-660.
- Ott, T., van Dongen, J. T., Günther, C., Krussel, L., Desbrosses, G., *et al.* (2005). Symbiotic leghemoglobins are crucial for nitrogen fixation in legume root nodules but not for general plant growth and development. *Curr. Biol.*, *15*, 531-535.
- Pankhurst, C. E., and Sprent, J. I. (1975). Surface features of soybean root nodules. *Protoplasma*, *85*, 85-98.
- Parsons, R., and Day, D. A. (1990). Mechanism of soybean nodule adaptation to different oxygen pressures. *Plant Cell Environ.*, *13*, 501-512.
- Parsons, R., Sprent, J. I., and Raven, J. A. (1993). Humidity and light affect the growth, development and nitrogenase activity of stem nodules of *Sesbania rostrata* (Brem). *New Phytol.*, *125*, 749-755.
- Pastori, G. M., Kiddle, G., Antoniw, J., Bernard, S., Veljovic-Jovanovic, S., Verrier, P., *et al.* (2003). Leaf vitamin C contents modulate plant defense transcripts and regulate genes that control development through hormone signaling. *Plant Cell*, *15*, 939-951.
- Perlick, A. M., Albus, U., Stavridis, T., Fruhling, M., Küster, H., and Pühler, A. (1996). The *Vicia faba* lipoxygenase gene *VfLOX1* is expressed in the root nodule parenchyma. *Mol. Plant-Microbe Interact.*, *9*, 860-863.
- Perotto, S., Brewin, N. J. and Kannenberg, E. I. (1994). Cytological evidence for a host defense response that reduces cell and tissue invasion in pea nodules by lipopolysaccharide-defective mutants of *Rhizobium leguminosarum* strain 3841. *Mol. Plant-Microbe Interact.*, *7*, 99-112.
- Pfeffer, P. E., Rolin, D. B., Kumosinski, T. F., MacFall, J. S., and Schmidt, J. H. (1992). ³¹P relaxation responses associated with N₂/O₂ diffusion in soybean nodule cortical cells and excised cortical tissue. *Plant Physiol.*, *100*, 1682-1690.
- Price, A. H., Taylor, A., Ripley, S. J., Griffiths, A., Trewavas, A. J., and Knight, M. R. (1994). Oxidative signals in tobacco increase cytosolic calcium. *Plant Cell*, *6*, 1301-1310.
- Puppo, A., Herrada, G., and Rigaud, J. (1991). Lipid peroxidation in peribacteroid membranes from French-bean nodules. *Plant Physiol.*, *96*, 826-830.
- Puppo, A., Groten, K., Bastian, F., Carzaniga, R., Soussi, M., Lucas, M. M., *et al.* (2005). Legume nodule senescence: Roles for redox and hormone signalling in the orchestration of the natural aging process. *New Phytol.*, *165*, 683-701.
- Purcell, L. C., and Sinclair, T. R. (1994). An osmotic hypothesis for the regulation of oxygen permeability in soybean nodules. *Plant Cell Environ.*, *17*, 837-843.
- Rae, A. L., Perotto, S., Knox, J. P., Kannenberg, E. L., and Brewin, N. J. (1991). Expression of extracellular glycoproteins in the uninfected cells of developing pea nodule tissue. *Mol. Plant-Microbe Interact.*, *4*, 563-570.
- Ralston, E. J., and Imsande, J. (1982). Entry of oxygen and nitrogen into intact soybean nodules. *J. Exp. Bot.*, *33*, 208-214.
- Rathbun, E. A., Naldrett, M. J., and Brewin, N. J. (2002). Identification of a family of extensin-like glycoproteins in the lumen of *Rhizobium*-induced infection threads in pea root nodules. *Mol. Plant-Microbe Interact.*, *15*, 350-359.

- Raven, J. A., Johnston, A. M., Parsons, R., and Kubler, J. (1994). The influence of natural and experimental high O₂ concentrations on O₂-evolving phototrophs. *Biol. Rev.*, *69*, 61-94.
- Riccillo, P. M., Muglia, C. I., de Bruijn, F. J., Roe, A. J., Booth, I. R., and Aguilar, O. M. (2000). Glutathione is involved in environmental stress responses in *Rhizobium tropici*, including acid tolerance. *J. Bacteriol.*, *182*, 1748-1753.
- Robinson, D. L., Pathirana, S. M., Gantt, J. S., and Vance, C. P. (1996). Immunogold localization of nodule-enhanced phosphoenolpyruvate carboxylase in alfalfa. *Plant Cell Environ.*, *19*, 602-608.
- Robson, R. L., and Postgate, J. R. (1980). Oxygen and hydrogen in biological nitrogen fixation. *Annu. Rev. Microbiol.*, *34*, 183-207.
- Rodríguez-Milla, M. A., Maurer, A., Rodríguez Huete, A., and Gustafson, J. P. (2003). Glutathione peroxidase genes in *Arabidopsis* are ubiquitous and regulated by abiotic stresses through diverse signaling pathways. *Plant J.*, *36*, 602-615.
- Romanov, V. I., Gordon, A. J., Minchin, F. R., Witty, J. F., Sköt, L., James, C. L., *et al.* (1995). Anatomy, physiology and biochemistry of root nodules of Sprint-2 Fix⁻, a symbiotically defective mutant of pea (*Pisum sativum* L.). *J. Exp. Bot.*, *46*, 1809-1816.
- Rouhier, N., and Jacquot, J.-P. (2002). Plant peroxiredoxins: Alternative hydroperoxide scavenging enzymes. *Photosynthesis Res.*, *74*, 259-268.
- Rubio, M. C., Gonzalez, E. M., Minchin, F. R., Webb, K. J., Arrese-Igor, C., Ramos, J., and Becana, M. (2002). Effects of water stress on antioxidant enzymes of leaves and nodules of transgenic alfalfa overexpressing superoxide dismutase. *Physiol. Plant.*, *115*, 531-540.
- Rubio, M. C., James, E. K., Clemente, M. R., Bucciarelli, B., Fedorova, M., Vance, C. P., *et al.* (2004). Localization of superoxide dismutases and hydrogen peroxide in legume root nodules. *Mol. Plant-Microbe Interact.*, *17*, 1294-1305.
- Sakamoto, A., Sakurao, S., Fukunaga, K., Matsubara, T., Ueda-Hashimoto, M., Tsukamoto, S., *et al.* (2004). Three distinct *Arabidopsis* hemoglobins exhibit peroxidase-like activity and differentially mediate nitrite-dependent protein nitration. *FEBS Lett.*, *572*, 27-32.
- Sánchez-Fernández, R., Fricker, M., Corben, L. B., White, N. S., Sheard, N., Leaver, C. J., *et al.* (1997). Cell proliferation and hair tip growth in the *Arabidopsis* root are under mechanistically different forms of redox control. *Proc. Natl. Acad. Sci. USA*, *94*, 2745-2750.
- Santos, R., Hérouart, D., Sigaud, S., Touati, D., and Puppo, A. (2001). Oxidative burst in alfalfa-*Sinorhizobium meliloti* symbiotic interaction. *Mol. Plant-Microbe Interact.*, *14*, 86-89.
- Scandalios, J. G., Tong, W.-F., and Roupakias, D. G. (1980). *Cat3*, a third gene locus coding for a tissue-specific catalase in maize: Genetics, intracellular location, and some biochemical properties. *Mol. Gen. Genet.*, *179*, 33-41.
- Schopfer, P. (2001). Hydroxyl radical-induced cell-wall loosening *in vitro* and *in vivo*: Implications for the control of elongation growth. *Plant J.*, *28*, 679-688.
- Schopfer, F. J., Baker, P. R. S., and Freeman, B. A. (2003). NO-dependent protein nitration: A cell signaling event or an oxidative inflammatory response? *Trends Biochem. Sci.*, *28*, 646-654.
- Schuller, K. A., Minchin, F. R., and Gresshoff, P. M. (1988). Nitrogenase activity and oxygen diffusion in nodules of soybean cv. Bragg and a supernodulating mutant: Effects of nitrate. *J. Exp. Bot.*, *39*, 865-877.
- Serraj, R., Fleurat-Lessard, P., Jaillard, B., and Drevon, J. J. (1995). Structural changes in the inner-cortex cells of soybean root nodules are induced by short-term exposure to high salt or oxygen concentrations. *Plant Cell Environ.*, *18*, 455-462.
- Serraj, R., Frangne, N., Maeshima, M., Fleurat-Lessard, P., and Drevon, J. J. (1998). A α -TIP cross-reacting protein is abundant in the cortex of soybean N₂-fixing nodules. *Planta*, *206*, 681-684.
- Shaw, S. L., and Long, S. R. (2003). Nod factor inhibition of reactive oxygen efflux in a host legume. *Plant Physiol.*, *132*, 2196-2204.
- Sheehy, J. E., and Thornley, J. H. M. (1988). Oxygen, the *nifA* gene, nodule structure and the initiation of nitrogen fixation. *Ann. Bot.*, *61*, 605-609.
- Sheehy, J. E., Minchin, F. R., and Witty, J. F. (1983). Biological control of the resistance to oxygen flux in nodules. *Ann. Bot.*, *52*, 565-571.
- Sherrier, D. J., and VandenBosch, K. A. (1994). Localization of repetitive proline-rich proteins in the extracellular matrix of pea root nodules. *Protoplasma*, *183*, 148-161.
- Shimada, S., Rousseau, R., and Denison, R. F. (1997). Wavelength options for monitoring leghaemoglobin oxygenation gradients in intact legume root nodules. *J. Exp. Bot.*, *48*, 1251-1258.

- Shimoda, Y., Nagata, M., Suzuki, A., Abe, M., Sato, S., Kato, T., *et al.* (2005). Symbiotic *Rhizobium* and nitric oxide induce gene expression of non-symbiotic hemoglobin in *Lotus japonicus*. *Plant Cell Physiol.*, *46*, 99-107.
- Sinclair, T. R., and Goudriaan, J. (1981). Physical and morphological constraints on transport in nodules. *Plant Physiol.*, *67*, 143-145.
- Sköt, L., Minchin, F. R., Timms, E., Fortune, M. T., Webb, K. J., and Gordon, A. J. (1996). Analysis of the two nodulins, sucrose synthase and ENOD2, in transgenic *Lotus* plants. *Plant Soil*, *186*, 99-106.
- Smirnoff, N. (2000). Ascorbate biosynthesis and function in photoprotection. *Phil. Trans. Roy. Soc. Lond.*, *B*, *355*, 1455-1464.
- Smith, J. D. (1949). Haemoglobin and the oxygen uptake of leguminous root nodules. *Biochem. J.*, *64*, 591-598.
- Soupe, E., Foussard, M., Boistard, P., Truchet, G., and Batut, J. (1995). Oxygen as a key developmental regulator of *Rhizobium meliloti* N₂-fixation gene expression within the alfalfa root nodule. *Proc. Natl. Acad. Sci. USA*, *92*, 3759-3763.
- Sprent, J. I. (1972). The effects of water stress on nitrogen-fixing root nodules. II. Effects on the fine structure of detached soybean nodules. *New Phytol.*, *71*, 443-450.
- Stachelin, C., Müller, J., Mellor, R. B., Wiemken, A., and Boller, T. (1992). Chitinase and peroxidase in effective (fix⁺) and ineffective (fix⁻) soybean nodules. *Planta*, *187*, 295-300.
- Streeter, J. G., and Salminen, S. O. (1992). Evidence supporting a non-phloem source of water for export of solutes in the xylem of soybean root nodules. *Plant Cell Environ.*, *15*, 735-741.
- Streeter, J. G. (1995). A new model for the rapid effects of non-invasive treatments on nitrogenase and respiratory activity in legume nodules. *J. Theor. Biol.*, *174*, 441-452.
- Studer, D., Hennecke, H., and Müller, M. (1992). High-pressure freezing of soybean nodules leads to an improved preservation of ultrastructure. *Planta*, *188*, 155-163.
- Sutherland, J. M., and Sprent, J. I. (1984). Calcium-oxalate crystals and crystal cells in determinate root nodules of legumes. *Planta*, *161*, 193-200.
- Swaraj, K., and Garg, O. P. (1970). The effect of ascorbic acid, when applied to the rooting medium, on nodulation and nitrogen fixation in gram (*Cicer arietinum*). *Physiol. Plant.*, *23*, 889-897.
- Thumfort, P. P., Atkins, C. A., and Layzell, D. B. (1994). A re-evaluation of the role of the infected cell in the control of O₂ diffusion in legume nodules. *Plant Physiol.*, *105*, 1321-1333.
- Thumfort, P. P., Layzell, D. B., and Atkins, C. A. (1999). Diffusion and reaction of oxygen in the central tissue of ureide-producing legume nodules. *Plant Cell Environ.*, *22*, 1351-1363.
- Tjepkema, J. D., and Yokum, C. S. (1974). Measurement of oxygen partial pressure within soybean nodules by oxygen microelectrodes. *Planta*, *119*, 351-360.
- Trinick, M. J. (1979). Structure of nitrogen-fixing nodules formed by *Rhizobium* on roots of *Parasponia andersonii* Planch. *Can. J. Microbiol.*, *25*, 565-578.
- Van Cauwenberghe, O. R., Newcomb, W., Canny, M. J., and Layzell, D. B. (1993). Dimensions and distribution of intercellular spaces in cryo-planned soybean nodules. *Physiol. Plant.*, *89*, 252-261.
- Van Cauwenberghe, O. R., Hunt, S., Newcomb, W., Canny, M. J., and Layzell, D. B. (1994). Evidence that short-term regulation of nodule permeability does not occur in the inner cortex. *Physiol. Plant.*, *91*, 477-487.
- Van de Wiel, C., Scheres, B., Franssen, H., van Lierop, M. J., van Lammeren, A., *et al.*, (1990a). The early nodulin transcript ENOD2 is located in the nodule parenchyma (inner cortex) of pea and soybean root nodules. *EMBO J.*, *9*, 1-7.
- Van de Wiel, C., Norris, J. H., Bochenek, B., Dickstein, R., Bisseling, T., and Hirsch, A. M. (1990b). Nodulin gene expression and ENOD2 localization in effective, nitrogen-fixing and ineffective, bacteria-free nodules of alfalfa. *Plant Cell*, *2*, 1009-1017.
- van Spronsen, P. C., Tak, T., Rood, A. M. M., van Brussel, A. A. N., Kijne, J. W., and Boot, K. J. M. (2003). Salicylic acid inhibits indeterminate-type nodulation but not determinate-type nodulation. *Mol. Plant-Microbe Interact.*, *16*, 83-91.
- VandenBosch, K. A., Bradley, D. J., Knox, J. P., Perotto, S., Butcher, G. W., and Brewin, N. J. (1989). Common components of the infection thread matrix and the intercellular space identified by immunocytochemical analysis of pea nodules and uninfected roots. *EMBO J.*, *8*, 335-342.
- VandenBosch, K. A., Rodgers, L. R., Sherrier, D. J., and Kishinevsky, B. D. (1994). A peanut nodule lectin in infected cells and vacuoles and the extracellular matrix of nodule parenchyma. *Plant Physiol.*, *104*, 327-337.

- Vasse, J., de Billy, F., Camut, S., and Truchet, G. (1990). Correlation between ultrastructural differentiation of bacteroids and nitrogen fixation in alfalfa nodules. *J. Bacteriol.*, *172*, 4295-4306.
- Webb, J., and Sheehy, J. E., (1991). Legume nodule morphology with regard to oxygen diffusion and nitrogen fixation. *Ann. Bot.*, *67*, 77-83.
- Wei, H., Atkins, C. A., and Layzell, D. B. (2004a). Adenylate gradients and Ar:O₂ effects on legume nodules: I. Mathematical models. *Plant Physiol.*, *134*, 801-812.
- Wei, H., Atkins, C. A., and Layzell, D. B. (2004b). Adenylate gradients and Ar:O₂ effects on legume nodules: II. Changes in the subcellular adenylate pools. *Plant Physiol.*, *134*, 1775-1783.
- Wei, H., and Layzell, D. B. (2006). Adenylate-coupled ion movement. A mechanism for the control of nodule permeability to O₂ diffusion. *Plant Physiol.*, *141*, 280-287.
- Weisbach, C., Walther, P., Hartwig, U. A., and Nosberger, J. (1999). Electron microscopic investigation of water occlusions in intercellular spaces in the inner cortex of lucerne nodules. *J. Struct. Biol.*, *126*, 59-71.
- Wheeler, G. L., Jones, M. A., and Smirnov, N. (1998). The biosynthetic pathway of vitamin C in higher plants. *Nature*, *393*, 365-369.
- Williamson, B., and Duncan, G. H. (1989). Use of cryo-techniques with scanning electron microscopy to study infection of mature red raspberry fruits by *Botrytis cinerea*. *New Phytol.*, *111*, 81-88.
- Willekens, H., Chamnongpol, S., Davey, M., Schraudner, M., Langebartels, C., Van Montagu, M., et al. (1997). Catalase is a sink for H₂O₂ and is indispensable for stress defence in C₃ plants. *EMBO J.*, *16*, 4806-4816.
- Wingate, V. P. M., Lawton, M. A., and Lamb, C. J. (1988). Glutathione causes a massive and selective induction of plant defense genes. *Plant Physiol.*, *87*, 206-210.
- Wisniewski, J.-P., Gardner, C. D., and Brewin, N. J. (1999). Isolation of lipoxygenase cDNA clones from pea nodule mRNA. *Plant Mol. Biol.*, *39*, 775-783.
- Wisniewski, J.-P., Rathbun, E. A., Knox, J. P., and Brewin, N. J. (2000). Involvement of diamine oxidase and peroxidase in insolubilization of the extracellular matrix: implications for pea nodule initiation by *Rhizobium leguminosarum*. *Mol. Plant-Microbe Interact.*, *13*, 413-420.
- Witty, J. F. (1991). Microelectrode measurements of hydrogen concentrations and gradients in legume nodules. *J. Exp. Bot.*, *42*, 765-771.
- Witty, J. F., and Minchin, F. R. (1994). A new method to detect the presence of continuous gas-filled pathways for oxygen diffusion in legume nodules. *J. Exp. Bot.*, *45*, 967-978.
- Witty, J. F., and Minchin, F. R. (1998a). Methods for the continuous measurement of O₂ consumption and H₂ production by nodulated legume root systems. *J. Exp. Bot.*, *49*, 1041-1048.
- Witty, J. F., and Minchin, F. R. (1998b). Hydrogen measurements provide direct evidence for a variable physical barrier to gas diffusion in legume nodules. *J. Exp. Bot.*, *49*, 1015-1020.
- Witty, J. F., Minchin, F. R., Sköt, L., and Sheehy, J. E. (1986). Nitrogen fixation and oxygen in legume root nodules. *Oxf. Surv. Plant Mol. Cell Biol.*, *3*, 275-314.
- Witty, J. F., Sköt, L., and Revsbech, N. P. (1987). Direct evidence for changes in the resistance of legume root nodules to O₂ diffusion. *J. Exp. Bot.*, *38*, 1129-1140.
- Wycoff, K. L., Hunt, S., Gonzales, M. B., VandenBosch, K. A., Layzell, D. B., and Hirsch, A. M. (1998). Effects of oxygen on nodule physiology and expression of nodulins in alfalfa. *Plant Physiol.*, *117*, 385-395.
- Yoshioka, H., Gregerson, R. G., Samac, D. A., Kim, C. M., Hoevens, K. C. M., Trepp, G., et al. (1999). Aspartate aminotransferase in alfalfa nodules: Localization of mRNA during effective and ineffective nodule development and promoter analysis. *Mol. Plant-Microbe Interact.*, *12*, 263-274.

Chapter 12

PROSPECTS FOR THE FUTURE USE OF LEGUMES

J. G. HOWIESON^{1,2}, R. J. YATES^{1,2}, K. J. FOSTER²,
D. REAL³, AND R. B. BESIER²

¹*Centre for Rhizobium Studies, Murdoch University,
Murdoch, Western Australia 6150.*

²*Department of Agriculture and Food Western Australia,
South Perth, Western Australia 6151.*

³*Co-operative Research Centre for
Plant-Based Management of Dryland Salinity,
University of Western Australia, Nedlands, Western Australia 6907.*

1. INTRODUCTION

As rhizobiologists or soil scientists, our reflex is to think of legumes in the primary role of providing fixed nitrogen to otherwise depauperate soils. However, other scientists see them as vital food or forage plants, as essential rotational species to improve cereal yields, or as a forestry commodity that provides wood for fuel or shelter. Some scientists now see them as a source of pharmaceutical drugs for a range of maladies. This last role is not unrealistic when we note that legumes have been components of traditional medicines for many centuries (Duke, 1981). No matter the end use, the symbiotic association between root-nodule bacteria (hereafter, rhizobia) and legumes plays a significant role in world agricultural productivity by reducing *ca.* 100 million MT (metric tonnes) of atmospheric dinitrogen into ammonia (Freiberg *et al.*, 1997; Herridge and Rose, 2000; see Chapter 2 of this volume) and saving US\$10 billion on fertilizer N each year. After photosynthesis, we might consider biological nitrogen fixation (BNF) by legumes as the most fundamentally important biological process on the planet. This is a critical issue because many countries (both developing and advanced) have not fully

embraced BNF and are substantially reliant upon fertiliser nitrogen to drive agricultural productivity. Lack of adoption is attributed to many factors, which range from a paucity of knowledge and expertise both in manufacturing inoculants and in growing and inoculating legumes with rhizobia (Giller, 2001) to government subsidies in some advanced economies that mitigate against the use of biological N₂ fixation. Sadly, with the price of fossil fuels inevitably increasing, small economies will be faced with either food shortages or an inflated bill for fertiliser nitrogen. Many developing countries, such as those in SE Asia, rely upon buying urea for rice production (Thein and Hein, 1997). Their declining purchasing power in real terms will be deleterious for food production. This problem must be addressed now because current reviews forecast that food production will need to double by 2020 to feed our expanding population (Byerlee and White, 2000) and this cannot happen without inputs of N.

The Leguminosae is one of the largest families of flowering plants with more than 18,000 species classified into 650 genera (Sprent, 2001), just under one-twelfth of all known flowering plants. Not all legumes fix atmospheric N₂ and, among the subfamilies of the Leguminosae, the species within the Fabaceae are recognised as those of primary agricultural importance. Herbaceous and woody legumes from the Fabaceae have been traditionally used for pastures, conserved animal feed, erosion control, agro-forestry, and green-manuring. They also yield important substances like tannin, dyes, perfumes, insecticides, biofuels, and resins (Tyler *et al.*, 1981). Some of our most valuable food crops - peas (*Pisum*), beans (*Phaseolus*), peanuts (*Arachis*) and soybeans (*Glycine*) - are legumes that produce high protein grains for human consumption. Of all the plants that man uses for food perhaps only the grasses (Graminae) are more important than the legumes (Graham and Vance, 2003). Although considerable resources have been directed towards developing grasses, such as rice (whose full genome sequence is available), maize (whose genome is currently being sequenced), and wheat, only peanuts and soybeans within the legumes have been as thoroughly examined (Vietmeyer, 1986). Our increasing population and the concomitant need to adequately feed people to prevent particular health problems will necessitate a larger dietary contribution from legumes (Morris, 2003).

Apart from the direct benefits of N₂ fixation, legumes provide added value in weed, insect, and pathogen control, in improving soil stability, and in increasing soil organic matter when rotated with crops in farming systems (O'Hara *et al.*, 2002; Robson, 1990). In the USA alone, alfalfa (*Medicago sativa*) is now estimated to be the third or fourth most valuable crop and is worth nearly \$7 billion annually (Graham and Vance, 2003). However, pressures from biological, environmental, human health, and economic sources dictate that the suite of legumes, and how they are used in modern civilisation, not be fixed, but dynamic. This chapter outlines how legumes and their rhizobia can be developed for future exploitation, including opportunities outside mainstream agriculture.

2. CURRENT AND PAST LEGUME-USAGE PATTERNS

2.1. *Legume Use in Antiquity, in Undisturbed Global Environments, and in Today's Agricultural Systems*

The evidence that legumes have been an integral component of human diets on all the continents for millennia is found in archaeological deposits containing seeds or sometimes DNA (Sprent, 2001), in religious scripts and mythologies from the earliest records, as well as in commentaries on daily life in such ancient sources as the Egyptian hieroglyphs, Indian Vedas, and the Sumerian texts (Hancock, 2002). *Phaseolus* (dry beans) and *Lupinus* (lupin) in central and south America, *Cajanus* (pigeonpea) and *Vigna sinensis* (cowpea) in south-east Asia and central Africa, and *Lens*, *Lupinus*, *Cicer*, *Pisum*, and *Vicia* in parts of west Asia, north Africa, the Mediterranean basin and the Asian sub-continent, have provided a major protein source for humans as agriculture evolved over the last 10,000 years in these disparate civilisations. Simultaneously, as key animals were domesticated, forage legumes of the rangelands and forests provided high value grazing, as evidenced by the stomach contents of frozen animals in recently thawed Arctic ice (Hapgood, 1958). These forage legumes contributed fixed-nitrogen to the herbs and grasses growing alongside them in mixed swards. Recognition of the value of legumes in cereal rotations in early agriculture came well before modern science understood the role of microorganisms in the N₂-fixing process. The Romans wrote of the re-invigoration by lupins of cropping lands for cereal production almost 2000 years before microbiologists actually isolated rhizobia from nodules (Gladstones, 1998).

Surprisingly little has altered in legume-usage patterns in the Mediterranean basin since antiquity. A Roman farmer transported to the 21st century would see substantially the same suite of grain legumes (*i.e.*, pulses and oilseeds) in the fields, and his animals would graze the same wide diversity of forage legumes in the rangelands. Even *Lupinus angustifolius*, one of the few grain legumes to have been domesticated since biblical times (Hamblin, 1998), was widespread on mildly acid-to-neutral sandy soils of the western and northern Mediterranean basin in the Roman era. Without doubt, the greatest global changes in grain-legume usage have occurred in the tropics, sub-tropics, and warm temperate zones of Africa, Asia and America. In these regions, *Glycine max* (soybean) now dominates grain-legume production, with nearly 70 million MT produced annually in the USA, and 34 and 53 million MT in Argentina and Brazil, respectively (USDA, 2005). Compared with the global trade in cool season grains of *ca.* 60 million MT (Kelley *et al.*, 2000), soybean is probably the world's single largest traded legume.

As for soybean in the Americas, large tracts of land have been cleared of their native vegetation in central Asia, temperate America, and southern Australia and planted to cool season forage legumes from two main genera; *Trifolium* (clovers) and *Medicago* (medics). The perennial forage *M. sativa* has wide adaptation to soil and climate, notwithstanding intolerance of soil acidity (Cheng *et al.*, 2005), and has, therefore, spread from its centre of origin in the temperate zones of Persia to become a dominant forage on all continents except Antarctica (Lesins and Lesins, 1979). No perennial form of *Trifolium* has achieved such prominence. Possible

reasons for this are covered later in this review. Annual clovers and medics were established across 25 million ha of arable land throughout southern Australia during the 150 years preceding the current millennium. The N fixed from these pastures produces more than 50% of the protein exported in cereal grains from the same agricultural region (when grown in rotation with the pastures; see Chapter 4 of this volume).

Despite examples of success in legume breeding and adoption, it is of some concern that there are perhaps only 50 species of forage legumes and less than 15 species of grain legumes in global commercial trade (Kelley *et al.*, 2000). Is it prudent, from a gene conservation perspective, to cover the globe so completely with only 65 of a potential 18,000 species of legume?

2.2. Legumes in Modern Temperate and Tropical Agriculture

Current legume-usage patterns reveal a substantial dichotomy in the global development of legumes species between warm and cool environments. Forage-legume development for the cool environments has greatly outstripped that for warm environments, whereas it has been very much the reverse for the grain legumes. For example, soybean plantings have increased from 2 to 60 million ha in sub-tropical America during the last 30 years but grain-legume sowings have actually decreased in the traditional cool (mostly Mediterranean) environments over the last decade (Byerlee and White, 2000). Disease pressures are at least partly to blame for this latter pattern (Porta-Puglia *et al.*, 2000). In contrast, forage breeding of cool season species has been enormously successful in this same period. As an example, the development of a second generation of ley species for southern Australia has been an outstanding commercial success with new cultivars, species, and genera planted on more than 3 million ha since 1996 (Howieson *et al.*, 2000a; Loi *et al.*, 2005). Despite substantial investment, few new legume species, with the possible exception of *Stylosanthes scabra*, have been widely adopted in warm environments during this period (Miles, 2001). A recent analysis of outcomes in tropical forage-legume breeding and adoption has listed some 30 species adopted world-wide since 1980, but only on 5 million ha (Shelton *et al.*, 2005).

We can speculate on the reasons for this disparity. In warm environments, C₄ grasses are adapted to tolerate heat and have an efficient water usage that provides them with a competitive advantage over legumes. Grasses in the tropics can produce large quantities of forage (100 tonnes per ha per yr) and grow as tall as 2 m. The legumes that have evolved to co-exist with these grasses climb to avoid being shaded by the tall grasses. These climbing legumes are not grazing tolerant, because their growing points (apical meristems) are exposed to the grazing animals, whereas the grasses conceal theirs at ground level or below. Therefore, when grazed, the tropical legumes do not persist, even when planted as pure swards. Furthermore, most temperate legumes introduced into tropical environments withstand neither the grass competition nor the extreme summer heat.

In contrast to the tropical grasses, temperate grasses (mostly C₃) are not as highly productive. For example, perennial ryegrass (*Lolium perenne*) is one of the

most productive temperate species, but produces only 12-15 tonnes per ha dry matter annually, and only when supplied with N fertilizer. The height of C₃ grasses is also much less than the tropical grasses. The optimum height for grazing many temperate grasses is 20 cm (down to 5 cm after grazing) and this is compatible with legume phenology. Temperate legumes can co-exist and, in fact, be complementary to these grasses under normal grazing pressures (1-25 sheep per ha), sometimes developing into pure swards, if they have reduced palatability. To assist their competition with grasses and herbs, temperate forage legumes have also evolved reproductive strategies, such as high fecundity, hard seed, delayed imbibition, and seeds whose shape and size can allow them to pass through the animal digestive tract undamaged (Loi *et al.*, 2005). Exploiting these attributes in breeding forage legumes for the cool environments has been highly successful over the last 50 years. We believe this is because the strategies evolved by temperate legumes to make them competitive with C₃ grasses suit them for agricultural exploitation. Perhaps the recent development of new tropical cultivars of butterfly pea (*Clitoria ternatea*) and burgundy bean (*Macroptilium bracteatum*) can reverse this apparent imbalance between the warm and cool environments for commercially successful forage breeding (Conway *et al.*, 2001). For the grain legumes, there are opportunities in the future development of *Cicer*, *Lupinus*, *Vicia*, *Lens*, *Vigna*, and others.

2.3. Constraints to Breeding New Legumes

Given that very few of the 18,000 species of legumes have been commercially exploited, what have been the major constraints to their broader development? The four key constraints appear to be difficulties in:

1. breeding acceptable quality traits in legumes for human consumption;
2. placing legumes into farming systems, which is particularly difficult for forages in warm climates;
3. selecting legumes (and rhizobia) well adapted to both soil and climate; and
4. discovering and then acquiring suitable germplasm.

Breeding new grain legumes with high nutritional quality for monogastric or human consumption has to contend with the many anti-nutritional factors prevalent in wild legumes. These include non-protein amino acids, alkaloids, glycosides, tannins, saponins, and protease inhibitors (Enneking and Wink, 2000). Although some societies have dealt with these anti-nutritional factors by processing (*e.g.*, boiling, soaking, leaching, fermentation or dehulling; Uauy *et al.*, 1995), this is often not practical in today's large economies. Even though some anti-nutritional traits are governed by single genes (Gladstones, 1998), it is not trivial to combine all genes required for domestication into a species that will then displace (or augment) the suite of contemporary grain legumes in farming systems and in markets.

The modern example of the domestication of *L. angustifolius* in the 1970s, followed by its adoption on acid sandy infertile soils in Western Australia (Nelson and Hawthorne, 2000), highlights some of the difficulties of market penetration by novel legumes. Despite *L. angustifolius* acquiring a very important niche in rotation with cereals on 750,000 ha annually, the price paid for lupin seed constrains its

wider adoption. Lupin is considered primarily as an animal feed in the marketplace, whereas traditional cool season grain legumes are grown for human consumption (e.g., *Cicer*, *Vicia* and *Lens*) and fetch higher prices. Lupins remain popular in this particular farming system because they can fix more than 100 units of N per ha (Unkovich *et al.*, 1994), while providing the many additional rotational benefits associated with legume cultivation (Robson, 1990).

There are other technical and social barriers to legume adoption in the modern world. Farming systems that are distorted by price subsidisation often ignore the direct and associated benefits of cultivating legumes - common practice in the rural economies of North America and Europe (Carrouee *et al.*, 2000). Direct financial support to farmers ensures that arable lands remain occupied, but removes the incentive to develop efficient farming systems based upon biologically fixed N. Recognition of environmental pollution in the manufacture and utilisation of fertiliser N is slowly increasing the pressure to embrace BNF in these regions. In other circumstances, the investment in legumes is often not realised for several growing seasons and the opportunity lost in growing legumes instead of crops that generate higher immediate cash flow is significant. Just as importantly, in communally owned lands, it is often difficult to manage the longer term custody of improved forage to retrieve the benefit to the investor.

There are also complex biological hurdles to legume adoption. These include unfavourable soil type or climate (Graham, 1992) that can affect any of the components of the legume symbiosis (Robson, 1969), and the presence of competitive, yet ineffective, rhizobia that compromise N₂ fixation (Brockwell *et al.*, 1995). Legumes are also often more difficult to grow, in an agronomic sense, than cereals. A final consideration is that legumes introduced to new environments often require parallel selection of appropriate rhizobial inoculants (Howieson and Ballard, 2004) and then, the commercial manufacture of these inoculants. The expertise required to nurture a high-quality inoculant-manufacturing industry should not be underestimated (Deaker *et al.*, 2004). Some factors limiting legume exploitation have recently been reviewed (O'Hara *et al.*, 2002; Sessitsch *et al.*, 2002).

It remains to acknowledge the key role of woody and herbaceous legumes, both annual and perennial, in communal rangelands both in drier regions and in forests (both tropical and sub-tropical) around the globe. Where forestry has not disturbed them, the majority of our legume and rhizobial diversity is found *in situ* in these non-arable lands. These repositories are now being recognised for their extremely high conservation value, particularly as *ex situ* germplasm centres become expensive to retain (Maxted, 1999; Sabanci, 1999). It is from these *in situ* repositories that many of the legumes and their root-nodule bacteria with unique future roles in agriculture, horticulture, and medicine will be drawn.

3. NEW USES FOR LEGUMES

Global agriculture is facing unprecedented challenges in sustainability, whether those challenges arise from environmental, economic, or biological constraints (Howieson *et al.*, 2000a). Since that review was written, the price of oil has

doubled, and this will eventually inflate the price of nitrogenous fertiliser manufactured through the Haber-Bosch process. Legumes offer relief from reliance on fertiliser nitrogen in broad-acre cereal production and in more intensive primary production systems where N is limiting, such as in aquaculture. In animal feed lots, which have traditionally used waste products, such as offal, to provide protein, this practice must now be abandoned because of bovine spongiform encephalopathy (mad cow disease). To realise the benefits of legume N, however, new cultivars or even new species must often be developed to precisely satisfy the demands of either the production system or the end-user. It is new uses for legumes that currently offer major opportunities in legume discovery, selection, and breeding outside of traditional agriculture.

3.1. Developing Legumes for their Pharmaceutical and Health Benefits

There is a strong consumer-driven trend for natural products in the USA and Europe. Of the active compounds that are in prescribed pharmaceuticals, 25% are derived from flowering plants and this is expected to increase to 30% over the next ten years. Moreover, of the antineoplastic drugs prescribed in Western countries and Japan, 54% are natural products or their analogs (Kinghorn *et al.*, 2003). The global market for natural-product pharmaceuticals has been estimated at US\$30 billion and growing at 6% per annum (RIRDC, 2000). Many consumers want natural drugs, believing that the natural drugs are safer than synthetics. Herbs (including many legumes) that possess anti-cancer or penile potency properties are the focus of smuggling into markets into Europe, Japan and the USA (Hoareau and DaSilva, 1999). Advances in analytical chemical techniques, such as high performance liquid chromatography (HPLC), mass spectroscopy (MS), and nuclear magnetic resonance (NMR) allow the rapid identification of novel compounds that are increasing the value of legumes, in particular, to the pharmaceutical industry. Dixon and Sumner (2003) propose that the legume species combine emerging genomic accessibility with biochemistry that is of acute relevance to human health.

Non-traditional benefits from legumes in human diets have been emphasized in recent years; alfalfa sprouts (*M. sativa*) and soybeans as sources of phytoestrogens to reduce menopause symptoms and to maintain bone health in women are good examples (see below). In Chinese medicine, one of the oldest known beneficial plants is licorice (*Glycyrrhiza glabra*), a legume herb whose roots contain an anti-inflammatory and anti-ulcer agent. Legumes contain chemicals that may prove useful for their anti-oxidant, anti-viral, anti-microbial, anti-diabetic, anti-allergenic, and anti-inflammatory activities (Tyler *et al.*, 1981). The Plant Genetic Resource Conservation unit within the USDA is conserving 17 species of legumes that contain phytochemicals with potential human-health impact. Some of these species include butterfly pea (*Clitoria ternatea* L.) for anti-fungal proteins, hyacinth bean (*Lablab purpureus* L.) for its anti-hypertensive properties, and Kudzu (*Pueraria montana* var. *lobata* Willd.), which contains the isoflavone daidzein for anti-inflammatory, anti-microbial, and cancer-preventive treatments (Morris, 1999).

Five pyrano-isoflavones were isolated by Drewes *et al.* (2002) from the rootstock of *Eriosema kraussianum* (family Fabaceae). The most active of these compounds had an activity 75% of that of Viagra in increasing blood flow to rat penile tissue. *Trigonella foenum-graecum* L., widely known in Indian herbal medicine for increasing lactation (Duke, 1981), contains numerous chemical components of interest to the modern pharmaceutical industry, such as diosgenin and coumarin (Bhardwaj *et al.*, 1977; Liu *et al.*, 2002). A comprehensive cross-referenced compendium of compounds isolated from legumes, including a section on pharmacological applications, has recently been compiled by S. Hughes and A. Humphries (unpublished data).

Legumes contain phytoestrogens with broad biological activities that are now being applied to humans as treatments for menopause and osteoporosis. Phytoestrogens are plant-derived molecules, so named because they possess both oestrogenic and anti-oestrogenic activity, although much less potent than the endogenously produced human oestrogens (Stephens, 1997). Isoflavonoids are one major class of phytoestrogens that includes genistein, daidzein, and equol and are among the classes of phytoestrogens most extensively researched. Isoflavonoids are particularly prevalent in the Fabaceae subfamily of the Leguminosae and the most extensively studied are those from soybeans and red clover (*Trifolium pratense* L.). Isoflavonoid extracts from red clover and soybean are now used as alternative compounds for hormone replacement therapy (HRT) for menopausal disorders (Beck *et al.*, 2003).

Soybeans are the main dietary source in humans of two isoflavonoids, genistein and daidzein, which are present in the form of their glycosides. Consumption of foods containing soy-based products results in high plasma, urine, and prostate fluid concentrations of phytoestrogens. Epidemiological studies suggest that women in Asian countries with a typically high dietary intake of phytoestrogens have a decreased risk of breast cancer (Adlercreutz, 1998) and a lower incidence of menopausal symptoms (Albertazzi, 2003). As well, Asian men consuming a traditional diet high in soy products have a lower incidence of prostate cancer compared to European and American men (Adlercreutz *et al.*, 1993). Although these examples may only provide correlative evidence, numerous *in vitro* studies support a role of genistein in inhibiting the growth of a number of cancers (Ren *et al.*, 2001).

We have hypothesised that temperate legumes may also offer the same anti-cancer benefits as genistein extracted from soybean. *In vitro* studies in our laboratories have produced alcohol extracts from a wide range of legume leaf and stem tissues that inhibit the growth of MCF7 breast and LNCaP prostate cancer cells (P. Leedman, V. Russell, S.F. Wang, K. Foster and J.G. Howieson, Royal Perth Hospital, unpublished data). The isoflavones from soybean may also have a role in maintaining healthy brain tissue and in both treating age-associated cognitive declines, such as Alzheimer's disease (Gleason *et al.*, 2004), and improving cognitive function (File *et al.*, 2001).

Many of these secondary plant compounds are frequently found in small quantities and tend to be synthesised in specialised plant cells or at specific growth stages. This makes their extraction and purification more challenging (Balandrin

et al., 1985) and yet, with the equipment now available, we are likely to see a rapid expansion of the role for legumes or their extracted compounds in human medicines.

3.2. Developing Legumes for Specific Anti-helminthic Benefits to Ruminants

As for the emergence of resistance to herbicides in weed populations (*e.g.*, Burnet *et al.*, 1994), developing and implementing chemical control (anthelmintic) programs for gastrointestinal parasites in grazing animals is a balance between seeking efficacy and avoiding the creation of resistance. Sheep nematodes, such as *Ostertagia (Teladorsagia) circumcincta*, *Haemonchus contortus*, and *Trichostrongylus* species, are major causes of livestock mortalities and reduced production and, furthermore, widespread resistance to anti-helminthics threatens effective control (Besier and Love, 2003). There is good evidence, however, that plant tannins, which occur naturally in many forage legumes, can reduce worm burdens in grazing animals, hence reducing the requirement for drenching, and potentially provide a new weapon in the management of anti-helminthic resistance.

The tannins of interest for their potential anti-helminthic properties (condensed tannins or CTs) are described as proanthocyanidins, which are phenolic compounds present in varying concentrations in a wide range of plants, including leguminous forages. These CTs form part of the chemical defences of plants against bacterial and insect predation and against grazing by herbivores. CTs may also have a positive effect on ruminant nutrition by increasing the efficiency of protein utilisation. Through reversible binding to plant proteins, CTs are postulated to interfere with the activity of proteases produced by rumen microorganisms, thus reducing protein degradation in the rumen and allowing a greater proportion of protein to reach the small intestine (Aerts *et al.*, 1999; Min *et al.*, 2003). However, despite demonstrated benefits in terms of increased wool growth, milk production, reproductive rates, and bloat control, high concentrations of tannins can also reduce voluntary feed intake, which results in reduced animal performance (Min *et al.*, 2003). The effects of CTs evidently vary according to the nature, concentration, and structure of the different compounds and potential anti-helminthic benefits must be considered in this light.

Positive effects of various CT forages in lessening sheep-worm burdens have been noted in numerous studies. In field trials, significant reductions in worm burdens have occurred in sheep grazing on tanniferous forages, such as sulla (*Hedysarum coronarium*; Niezen *et al.*, 1998a; 2002a), lotus (*Lotus pedunculatus*; Niezen *et al.*, 1998b), birdsfoot trefoil (*L. corniculatus*; Marley *et al.*, 2003a), and chicory (*Cichorium intybus*; Marley *et al.*, 2003a; Scales *et al.*, 1995; Tzamaloukas *et al.*, 2005). Pen studies with a tannin extract (Quebracho) also indicated a decrease in sheep worm-egg counts and lowered worm burdens (Athanasiadou *et al.*, 2000; Max *et al.*, 2005). In goats, pen studies with Quebracho (Paolini *et al.*, 2003) and a tanniferous tree ration (Kahiya *et al.*, 2003) decreased the numbers of *Haemonchus contortus*, and significant anti-parasitic effects were obtained with the forage *Sericia lespedeza* with goats in both pen (Min *et al.*, 2004) and grazing trials

(Shaik *et al.*, 2006). In general, worm-egg counts are lowered within a week of introduction to CT pastures or rations, with most decreases in total worm numbers of the order of 30-50% in comparison to non-CT groups.

However, the role of CT forages as an alternative to chemical anti-helminthics is far from clear because the results and conclusions from various studies vary considerably. In contrast to earlier studies, little or no effect was seen in grazing studies with either sulla (Tzamaloukas *et al.*, 2005) or *L. pedunculatus* (Niezen *et al.*, 1998a). Variation in the effect on different worm species has also been shown. Several authors report reductions in burdens of *Teladorsagia (Ostertagia) circumcincta* but not *Trichostrongylus* spp. (Marley *et al.*, 2003a; Niezen *et al.*, 1998b), whereas Athanasiadou *et al.* (2000) found effects on intestinal, but not abomasal, species. It is not clear whether these inconsistencies reflect varying concentrations of CTs or the presence of different CT compounds.

There is also uncertainty regarding the mode of action of CTs on worm populations. In particular, it is not clear whether effects are due to the high nutritive value of proteins protected from rumen degradation or to a direct anti-helminthic action of CTs on various stages of the nematode life cycle. The effects of high-protein diets on the immunological competence of livestock have been well-established (*e.g.*, Coop and Kyriazakis, 1999), although this does not necessarily explain all anti-parasitic effects seen in sheep that graze pastures, which are high in protein. Direct effects on worms are reported in *in vitro* studies, including the inhibition of worm-egg hatching and larval migration of *H. contortus*, *T. circumcincta*, and *Tr. colubriformis* with sulla extracts (Molan *et al.*, 2000a) and similar effects with sulla, birdsfoot trefoil, lotus, sainfoin (*Onobrychus viciifolia*), and *Dorycnium* spp. on *Tr. colubriformis* of sheep (Molan *et al.*, 2000a) and nematodes of deer (Molan *et al.* 2000b). Similarly, larval development was decreased in faecal cultures from sheep that were fed chicory (Marley *et al.*, 2003b), *Dorycnium* spp. and *L. pedunculatus* (Niezen *et al.*, 2002b). However, the significance of these effects for the natural situation is not clear because *in vitro* egg-hatching results have not always been in accord with those from field trials (Waghorn *et al.*, 2006).

Further investigations, both *in vitro* and field-based, are essential to indicate whether CT-containing forages are likely to become a reliably effective addition to non-chemical worm control in livestock. Such studies should report CT concentrations and the proportions of different worm species involved, and also note any animal-production effects. The mechanism of action requires elucidation to explain the variable results obtained in grazing trials. The identification of specific compounds associated with dose-dependent inhibitory effects against nematode developmental stages (Molan *et al.*, 2003) will provide an objective basis for relating the results of laboratory assays to those occurring in the field.

Authors of the reports cited have often noted that CT-containing forages are relatively more difficult and expensive to establish and maintain than traditional pastures. As we note later, unless the economic benefits of new legume species are clear - in terms of both anti-helminthic effect and pasture-management costs - and the sociological effects are considered, their adoption may be compromised.

3.3. Developing Legumes to Replace Fishmeal in Aquaculture Feeds

Aquaculture has expanded so rapidly over the last decade that it now provides more than 30% of global fishery products (Allan, 2000). Although marine-based ingredients, such as fishmeal and fish oil, remain the preferred source of protein and energy to aquaculture, it is predicted that, by 2006, 50% of the global fish catch will be directed towards manufacturing aquaculture feeds (Tacon, 1996). Modern intensive aquaculture is, thus, perceived as a net fish-user rather than producer (Naylor *et al.*, 2000), which is clearly undesirable. Soybean-meal extracts have already been accepted as an alternative protein and energy source by the aquaculture industries; sweet lupin (*L. angustifolius*) and other grain extracts are currently being evaluated and appear to be adequate substitutes for soybean. Can other legumes, particularly those that can be produced inexpensively, satisfy this increasing demand for protein and energy in the aquaculture industries?

Fish do not require carbohydrates. Their presence in grain legumes can lead to reduced digestibility of fishmeal produced from legumes and a concomitant decrease in protein retention (Allan, 2000). Yet fish require protein (particularly S-rich amino acids) and oils, fatty acids, or lipids in their diets (Glencross, 2000). Although these may be provided by legumes in various ratios (Wang *et al.*, 2003), anti-nutritional factors, similar to those previously listed for humans and monogastrics, also affect fish; most notably protease inhibitors, saponins, oligosaccharides, and a high cellulose/fibre content. These and other potential tainting molecules, *e.g.*, coumarins (Wang *et al.*, 1999), cannot be ignored in formulating fish diets, but removing them from legumes requires either expensive processing or extensive breeding programs.

An important role for fish in human health relates to the ratio of long chain (more than 18 carbon atoms in a straight chain) omega-3 to omega-6 oils in marine products. There are two issues of importance here in relation to the oils from plants. Firstly, legumes produce predominantly C18 oils rather than the C20-C22 fish oils that are noted as beneficial to human health. Fresh-water fish can synthesise C22 fats from C18 precursors, but marine fish, particularly those from cold waters, are much less able to do so. Secondly, as can be seen from Table 1, the ratio of omega-3 to omega-6 oils varies considerably between legumes and fishmeal (a difference of more than 100-fold). For increased human health, a high ratio of omega-3 to omega-6 oils is desirable (Dry and Vincent, 1991). If the low ratio of omega-3 to omega-6 oils in some legumes is ultimately reflected in the fatty-acid content of the aquaculture end-products, the value of legume-fed fish in human diets might need to be reassessed.

Nonetheless, the substitution of fishmeal in aquaculture fish diets with high protein grains is attractive, particularly grains that contain omega-3 and omega-6 fats. Before embarking upon a program to breed pulse legumes specifically for fish feeds, we should ask whether any naturally available legume seeds contain the range of nutritional factors essential for aquaculture feeds. Table 1 indicates that, among the clover species, *T. glanduliferum* might be a candidate for future research. It combines an average level of total fats of 5.7% with a high proportion of these (40%) being present as omega-3 fats. This compares well with *L. angustifolius*

(already advanced as a fishmeal substitute), which contains 6% fats but with only 5.3% present as omega-3 fats, and an omega-3/omega-6 ratio one-tenth that of *T. glanduliferum*. Both species have acceptably high levels of protein. Among the legume species adapted to alkaline soils, *Trigonella balansa* contains a relatively high level of omega-3 and omega-6 fats, but a lower omega-3 /omega-6 ratio than *T. glanduliferum*. A broader search of the legume family may well uncover other agronomically adapted species that are nutritionally adequate for aquaculture diets.

Table 1. A comparison of the levels of fats and proteins in soybean meal and fishmeal with those in kernels of canola and a range of legumes that might be considered as alternatives to fishmeal in aquaculture diets.

Source	% total fats	% of fats as omega-3*	% of fats as omega-6*	Ratio of omega-3 to omega-6	% crude protein (N x 6.25)
Fishmeal	7.9	33.9	2.3	14.7	65
Soybean meal	19.6	7.5	56.6	0.13	48
canola	13.6	12.7	19.6	0.65	35
<i>Lupinus angustifolius</i>	6.0	5.3	37.5	0.14	38
<i>Trigonella balansa</i>	5.5	23.0	43.0	0.53	38
<i>Trifolium strictum</i>	3.8	29.3	40.9	0.71	32
<i>Trifolium glanduliferum</i>	5.7	40.1	25.3	1.60	32
<i>Trifolium dichroanthum</i>	7.1	18.6	41.5	0.45	40
<i>Onobrychus aurantiaca</i>	13.4	nd	nd		58

*These include C14 to C22 fats; nd = not determined.

Data from van Barnefeld (1999); Glencross (2000); Petterson (2000); and S. F. Wang (unpublished data).

The aerial-seeding clovers, such as *T. glanduliferum*, appeal as likely candidates for fishmeal substitution because, under low-input conditions, they can produce large quantities of seeds, which are readily harvested by conventional machinery (Loi *et al.*, 2005). This attribute will be essential if new species are to be price competitive with soymeal. The agronomic potential of *Onobrychus aurantiaca* is unknown, but its protein and oil concentrations approach those of soybean meal. The crude protein estimate of 58% for *O. aurantiaca* (based on N analysis) is very high, raising the question of whether much of the N in that particular species is actually present as non-protein N.

3.4. *New Perennial Legumes with Deeper Roots for Increased Access to Water*

A further opportunity for the future use of legumes is in providing hydrological stability to low-input agricultural ecosystems. Undisturbed grassland and rangeland ecosystems often contain a mix of annual and perennial species that include herbs, shrubs, trees, and grasses. This mix of bio-types in temperate climates has contributed to hydrological stability in the groundwater systems of much of the global land mass, with the deeper-rooting species translocating water from depth during the drier autumn and summer periods. In southern Australia, the natural mixture of perennial shrubs, trees, annual grasses, and herbs was violently perturbed with the clear felling of 25 million ha for agriculture in the 19th and 20th centuries. Large areas of southern Australia have since become seriously affected by the combination of salinity and waterlogging as a result of rising water tables due to decreased water utilisation. The current estimate of affected land exceeds 5 million ha (Rogers *et al.*, 2005). Pasture for use by livestock has been recognised as the large-scale land use with the greatest potential for remediating this disaster (Ewing and Dolling, 2003). Farming systems in southern Australia are, therefore, likely to be redesigned in this century to mimic the water-use patterns of native flora (Lefroy and Stirzaker, 1999) with the key to this activity being the discovery of plants with both economic and hydrological benefit.

Perennial legumes are projected to play a key role in this redesigned agriculture. Cocks (2003) estimates *M. sativa* is adapted to 96% of the soil types of south-eastern Australia, where soils are fertile and alkaline. Many of the perennial legume species found in the rangelands surrounding the Mediterranean basin (Gintzburger and Le Houerou, 2003) might be evaluated against *M. sativa* in this setting, if improvements are required. However, for the acid and coarse-textured soils of south-western Australia, which represent approximately 30% of the agricultural land in this region, a different suite of perennial legumes and rhizobia to those currently exploited in agriculture will need to be developed. None of the current commercial species is adapted to the combined edaphic stresses of aridity, infertility, and acidity that typify this region (Howieson and Ballard, 2004) and this situation will provide another major opportunity for developing legumes for future uses.

Remarkably little is known about the essential reproductive, agronomic, rhizobiological and physiological characteristics of perennial forage legumes other than perhaps for *M. sativa*, *T. repens*, *T. pratense*, and *Lotus corniculatus*, which are used commercially in many parts of the world. This lack of knowledge is a serious constraint to the development of other perennial legumes for future agricultural usage. These constraints are further discussed below in relation to the genus *Trifolium*, under the column headings in Table 2, namely, rhizobiology, seed and herbage production, and seedling vigour.

3.4.1. *Mode of Reproduction of Perennial Legumes*

Many perennial legumes must cross-pollinate to produce seed, *i.e.*, they are allogamous, which has two immediate impacts in breeding programs; it requires

Table 2. Some perennial *Trifolium* species and their characteristics relative to the annual species *T. subterraneum* that have contributed to, or inhibited, their commercial exploitation.

<i>Trifolium</i> species	Centre of diversity	mb grouping*	Seedling vigour	Herbage production**	Seed production characteristics***	Commercial adoption
<i>T. subterraneum</i>	Euro-Mediterranean	1	F	H	I	Yes
<i>T. ambiguum</i>	Euro-Mediterranean	2	I	I	I	Yes
<i>T. fragiferum</i>	Euro-Mediterranean	3	I	H	H	Yes
<i>T. hybridum</i>	Euro-Mediterranean	3	I	I	I	Yes
<i>T. medium</i>	Euro-Mediterranean	3	I	I	I	Yes
<i>T. ochroleucum</i>	Euro-Mediterranean	3	S	I	L	No
<i>T. pratense</i>	Euro-Mediterranean	3	F	H	H	Yes
<i>T. repens</i>	Euro-Mediterranean	3(1)	F	H	H	Yes
<i>T. tumens</i>	Euro-Mediterranean	3	S	L	L	No
<i>T. uniflorum</i>	Euro-Mediterranean	3	S	L	L	No
<i>T. polymorphum</i>	South America	4	S	L	L	No
<i>T. longipes</i>	North America	5	S	I	L	No
<i>T. wigginsii</i>	North America	6	S	I	L	No
<i>T. wormskioldii</i>	North America	7	S	L	L	No
<i>T. africanum</i>	Africa	8	S	I	L	No
<i>T. burchellianum</i>	Africa	9	S	I	L	No
<i>T. cryptopodium</i>	Africa	10	S	L	L	No
<i>T. semipilosum</i>	Africa	11	I	I	I	Yes

F = Fast, I = Intermediate, S = Slow, H = High, L = Low.

*Those with the same numeral are cross compatible for nodulation and N₂ fixation (from Howieson et al., 2005).

**An assessment of leaf to stem ratio and woodiness.

***Amount of seed production, ease of seed capture and cleaning after harvest.

the presence of appropriate pollinating insects or vectors and it also generates variability within seed stocks. Both strictures require the breeder to take elaborate precautions to ensure his seed stocks are replenished while remaining pure. In contrast, self-pollinating legumes (such as most annual species) are usually highly genetically stable and fecund, and therefore, relatively simple to propagate and preserve. For a perennial legume to be extensively studied (and in the longer term to be economically attractive), adequate and inexpensive seed supplies must be available. However, perennial legume seed crops are perceived as high risk and recent trends, particularly in New Zealand, show a decline in their production and, concomitantly, in research associated with them (Rolston, 2003). In association with a reduced fecundity, perennial species also tend to concentrate their resources

into vegetative reproduction rather than seed production. This is counter to some of the baseline-selection parameters developed for the ideotypic commercial legume (Howieson *et al.*, 2000a). To develop cultivars producing consistently high levels of seed is, thus, the major initial challenge when researching new perennial forage legumes.

The phenology of perenniality presents additional challenges for the plant breeder. Seedling establishment is comparatively slow in perennial plants because they prefer to secure a substantial rooting system prior to the development of aerial foliage. Annual plants, in contrast, are often very well adapted to rapid establishment because this attribute assists their primary reproductive strategy of seed production from aerial parts, as well as allowing them to be competitive with weeds. The slow establishment of perennial species is a second major constraint to the development of novel commercial species.

3.4.2. *The Rhizobiology of Perennial Legumes*

Producing compatible rhizobial inoculants is a third impediment to the utilisation of perennial legumes. This is exemplified by our current understanding in the well-researched genus *Trifolium*. Substantial specificity for root-nodule bacteria is seen between different clover species, between the same species growing in different geographic origins, and between annual and perennial species (Yates *et al.*, 2003). Many of the cross-reactions between clover and rhizobial strains may, in actuality, be parasitic (Friedericks *et al.*, 1990). Howieson *et al.* (2005) describe both 'geographic' and 'phenological' barriers to effective nodulation in this genus. These authors consider it very difficult to select inoculants with a sufficiently broad host range to fix N₂ in association with both annual and perennial clovers, particularly if their centres of origin are disparate. The annual clovers so far exploited in global commerce originate primarily from the Mediterranean basin. In Australia, the inoculant strain for clovers, WSM1325, although broadly effective with a wide range of annual clovers (Howieson *et al.*, 2000b; Loi *et al.*, 2005), is restricted almost entirely in terms of N₂ fixation to annual clovers from the Mediterranean basin (Howieson *et al.*, 2005).

Table 2 groups perennial clovers according to their rhizobial associations and then comments on their commercial adoption. It illustrates that the majority of current commercial perennial clovers arise from the Euro-Mediterranean region (Zohary and Heller, 1984) and share common strains of effective rhizobia (primarily group 3). Most cross-inoculation reactions between these commercial perennial clovers, therefore, lead to compatible nodulation (effective for N₂ fixation). Very few perennial clovers have been successfully commercialised from either the American or African continents, where rhizobial specificities are marked, *i.e.*, the different clover species require different inoculants, from groups 4-11. Within the Euro-Mediterranean region, a species such as *T. ochroleucum* might offer rhizobial compatibility with commercial perennial clovers but be deficient in other essential agronomic characteristics, such as seed production. Further, few inoculants for perennial clovers are effective on the annuals, such as *T. subterraneum* (group 1, Table 2) and, in fact, may be competitive for nodulation, yet ineffective. Yates

et al. (2003) emphasised that the release of new perennial clover cultivars with specific inoculants must be undertaken with care to ensure that this activity is not detrimental to annual clovers already established in the target farming system.

Other attributes common to the successful perennial clover species listed in Table 2 appear to be intermediate (or better) seed and herbage production, combined with seedling vigour. Table 3 indicates that of the commercial perennial clovers in Australia, only *T. repens* can be considered as a successful species relative to the widely sown annual *T. subterraneum*, on the basis of certified seed production in the years 2000-2004. It is no coincidence that *T. repens* can nodulate and fix N₂ reasonably well with rhizobia from annual clover species originating in the European centre of origin of the genus (Howieson *et al.*, 2005).

Table 3. Certified seed production (MT) for five perennial and one annual *Trifolium* sp in Australia under the OECD, AOSCA and domestic seed certification schemes (2000 – 2004[#]).

<i>Trifolium</i> species	2000	2001	2002	2003	2004	Total
<i>T. ambiguum</i>	<1	<1	<1	<1	<1	?
<i>T. fragiferum</i>	75	67	7	4	57	210
<i>T. pratense</i>	5	<1	<1	13	80	98
<i>T. repens</i>	424	451	1732	657	1926	5190
<i>T. semipilosum</i>	<1	<1	<1	<1	<1	?
<i>T. subterraneum</i> *	1484	461	1981	1568	2569	8063

*An annual *Trifolium*. [#]Compiled by Australian Seeds Authority Ltd from data provided by Seed Services Australia, AgriQuality Ltd, AGWEST, NSW Agriculture, QSEED Pty Ltd, and Tasmanian Dept of Primary Industries, Water & Environment.

In summary, the few successful perennial clover species, such as *T. repens* (Table 3), appear to be those that have been bred to include the key attributes that we actually find widespread in the annual forage legumes, *i.e.*, high seed production, rapid seedling development, intermediate or greater herbage production, and broad compatibility with root-nodule bacteria. These attributes should become baseline selection parameters when identifying perennial forage legumes in other legume genera for future domestication.

3.4.3. Need to Develop New Perennial Forage Legumes for Acid and Infertile Soils

The globe contains large pockets of acidic and acidifying soils in important climatic zones, such as the temperate, Mediterranean, and elevated sub-tropical regions (Andrew, 1978). It comes as a surprise that there are few well-adapted and commercial perennial forage legumes for this edaphic niche, particularly where annual rainfall is low. As we have indicated, the premier perennial forage species for temperate zones is *M. sativa*, which is productive on fertile well-drained soils in the pH range 6-9. If *M. sativa* is not well suited to the farming systems on these

soils, then species from the genera *Onobrychus*, *Hedysarum* or *Astragalus* offer many opportunities for commercialisation. Unfortunately, the suite of perennial legume herbs commercialised for acidic infertile soils in temperate, sub-tropical and Mediterranean zones is very narrow, and non-existent if rainfall is below 500 mm.

It is essential in developing novel perennial legumes for commerce that species are matched for key soil characteristics, such as clay content, pH, cation-exchange capacity, and inorganic fertility. Although there are exceptions, as these individual parameters decrease, abiotic stress on plants and rhizobia substantially increases. Sometimes, these abiotic stresses occur together and, where they do, they represent a significant challenge to the establishment of symbiotic plants (Howieson and Ballard, 2004; Zahran, 1999). In this context, the exploration of world flora to develop novel perennial legumes for acid soils in arid regions should focus largely upon edaphic homologs. At present, the reflex for many plant collectors is to focus their activities on climatic homologs. These can be found by interrogation of simple climate-matching models, but are of little real value where the target environment for plant improvement harbours the abiotic stresses summarised above.

A surprisingly diverse suite of palatable and herbaceous perennial legumes has emerged from a recent botanical exploration of the Cape regions of South Africa. The perennial legumes there grow under rangeland conditions, with annual rainfall between 150mm and 600mm, and where coarse-textured low-pH and infertile soils are common (J.G. Howieson, R.J. Yates, D. Real, I. Law and B.E. Van Wyk, unpublished data). The climate is dry-Mediterranean and, thus, these species might augment the narrow suite of perennial legumes available for this edaphic niche. Perhaps the first genus to explore for agriculture might be *Lessertia*, predominantly from the Western Cape. *L. incana*, *L. diffusa*, *L. capitata*, and *L. excisa* exhibit many of the attributes we are seeking in new perennial legumes adapted to acid and infertile soils. Like many successful annual legumes, they are self-fertile and prolific seeders, with large seeds that germinate vigorously, and with fruits that adhere relatively strongly to the stems. *Lessertia* species are grazed in their natural habitat and become prostrate under high-grazing pressure. Unusual characteristics that are found in other South-African herbaceous legumes, which might assist their adaptation to agricultural farming systems, are their ability to root from stolons or rhizomes (as in several species of *Lotononis*), and to store carbohydrate in subterranean woody organs, as reported for *L. hirsuta* (van Wyk, 1991).

The rhizobiology of these herbaceous South African legumes is somewhat complicated with recent reports of beta-bacteria from the genus *Burkholderia* (Moulin *et al.*, 2001) and both pigmented and non-pigmented slow-growing *Methylobacterium* (Sy *et al.*, 2001; Jaftha *et al.*, 2002) among the unusual nodule occupants. Adding to this complexity, we have isolated *Burkholderia* from the nodules of *Rhynchosia ferulifolia* and fast-growing pink-pigmented *Methylobacterium* from species of *Lotononis* other than *L. bainesii* (Yates *et al.*, 2007). The latter appear to be taxonomically distinct from the microsymbiont for *L. bainesii* previously reported (Jaftha *et al.*, 2002; Norris, 1958). Parenthetically, pink-pigmented bacteria arise quite frequently in our isolations from non-traditional legumes and we can only assume that they have been overlooked in the past because of the routine use of Congo Red dye in rhizobial media (Vincent, 1970). Although

the *Lessertia* are nodulated by *Mesorhizobium* sp (J.G. Howieson and R.J. Yates, unpublished data), the majority of the nodule occupants from these South African Cape legumes await taxonomic identification.

In selecting novel legume species for the acid and infertile soils of the world, we should perhaps initially focus upon legume species that form a symbiotic association with rhizobia from the genera *Bradyrhizobium* and *Mesorhizobium*, which have proven adaptation to stressful soils (Howieson and Ballard, 2004; Parker *et al.*, 1977). A corollary to this is that, if we release new genera of rhizobia into agricultural soils, issues of inter-strain competition are probably greatly diminished.

4. MATCHING LEGUMES AND THE SYMBIOSIS TO EDAPHIC AND ECONOMIC PARAMETERS

4.1. *Mechanics of Developing New Legumes and Their Root-nodule Bacteria for Production Systems*

We see five key steps in developing new legumes for agriculture. They are:-

1. the identification of the requirement for a new legume, *i.e.*, data on where and why current species fail;
2. an assessment of the economic and social issues relating to the introduction (or domestication) of a new species and its likely adoption;
3. the identification of appropriate germplasm with which to experiment;
4. selection or breeding of legumes and their rhizobial genotypes that are adapted to each other and to the target edaphic niche; and
5. assessment of the broader biological implications of introduction of both plant and microsymbiont, including “duty of care” issues, such as understanding any biological threat posed by the new material.

We have discussed environmental issues, such as salinity and rising water tables, acid soils, and the global requirement for higher protein diets, all of which exemplify the need to develop new species of legumes for agriculture (key step 1). A new legume must have a definable role in the farming system of the region and must be manageable in the social context of that farming system (key step 2). A flow diagram for sensible decision making in an economic and biological framework has been reported (Sessitsch *et al.*, 2002) and this also covers the need to develop inoculant rhizobia. Herridge (see Chapter 4 of this volume) also reviews methodology for developing experimental evidence of the need to inoculate. Some constraints to legume use and adoption have been reviewed recently, including economic farming systems and social issues (Sessitsch *et al.*, 2002) and marketing issues (Knight, 2000).

A major consideration when domesticating new species is that matching plants to climate is more complex for perennial than for annual species. This relates to key step 3. Perennial legumes must survive for several years, whereas annual plants may need to survive for only a few months in every year and their dormant seed may carry them through to the next growing season. To match plants to climates for

only half of the year is much more readily achieved than matching them for the whole year. Annual species in cold climates are often dormant in winter, but grow during the spring and summer on conserved moisture or from melting ice or snow. These same species may be sown in subtropical or Mediterranean environments for winter production, because these winters are relatively mild. Thus, the warm-season pulse *Cajanus* is now grown under cool-season conditions in northern Nigeria, and the cool-season pulse *Cicer* is grown in warmer environments, such as southern India (Byerlee and White, 2000). Whereas perennial species from cold areas might grow during winter in other climatic zones, they rarely survive the warmer months and the drier summers with low ambient humidity. In the development of novel perennial legumes, it is likely to be more important to closely match species to a similar climate than it has been in the past for annual plants (key step 3).

We have also covered some of the other decision-making processes that relate to the acquisition of appropriate germplasm for key step 3, from either *ex situ* or *in situ* repositories, preferably in edaphic homologs. Part of the reason for the broad adaptation of legumes may be that, in their complex root systems, they seem to have adopted many characteristics from other plant families acknowledged as essential for survival in harsh soils. Apart from nodulation, these features include cluster roots, mycorrhizal associations (both ecto- and endo-; Sprent, 2001) and (as noted above) root tubers that store water and carbohydrate. It is important to identify the factors likely to limit legume cultivation before deciding upon where to source new germplasm and then focus upon regions where legumes may have evolved with adaptation to these factors. The Cape legumes illustrate this critical aspect of key step 3 in a search for concurrent adaptation to acidity and low rainfall.

Although legumes can exist under harsh conditions, many species are substantially more productive if given fertiliser. Very few legumes, however, can be cultivated economically (especially in broad-acre agriculture) when reliant upon large inputs of nutrients (N and P) and water, because the cost of these inputs exceeds the value of the end-products. Exceptions include legumes whose production is subsidised, legume sprouts grown horticulturally for salads, *T. pratense* sold into the nutraceutical market, *G. max*, *Phaseolus vulgaris* and forages such as *M. sativa*, whose seeds or hay fetch a high price. For most new legumes, it is mandatory that close to maximum growth and N₂ fixation is achieved under low input conditions and this relates to key step 4 above.

For maximum N₂ fixation in the longer term (key step 4), the legume must be intimately matched to an appropriate strain of rhizobia, and the symbiosis then be robust in the target edaphic niche. The Centre for *Rhizobium* Studies at Murdoch University has developed a set of protocols that assesses these attributes, including the saprophytic competence of strains to persist in soils over several seasons (Chatel and Parker, 1973). As an example, in the development of the second-generation ley species of annual clovers (Loi *et al.*, 2005), it quickly became apparent that the narrow host range of the long-term Australian inoculant strain for subterranean clover (WU95) would compromise agronomic evaluations of other annual *Trifolium* spp. (Howieson, 1999). The WSM strain collection was searched for strains with a broad-host range through glasshouse studies on N₂ fixation (Howieson *et al.*,

2000b). Approximately 10 highly effective broad host-range strains were then assessed for their adaptation to the target acid soils in Australia (Watkin *et al.*, 2000) and Uruguay (Real *et al.*, 2005; Yates *et al.*, 2005). After more than six years of experimentation, strains WSM409 and subsequently WSM1325 were released commercially, and have since proven to be very successful (Bullard *et al.*, 2005).

Other technical aspects of applying N₂ fixation in the field (key step 4) have been brought together in two recent journal special issues, *viz.* Graham and Vance (2000) and Herridge *et al.* (2005). Rather than attempting to summarise the information in those volumes, we focus in the remainder of this section on some newer concepts.

Legume exploitation today often involves their utilisation outside their geographic centres of origin, potentially exposing both legumes and rhizobia to conditions under which they have not evolved. Yet this may not necessarily hinder their success, if the process of selection is expert. After legumes and rhizobia have been introduced to a new environment (the final stage of key step 4), the challenge arises of maintaining the symbiosis in a state of maximum N₂ fixation. This is just one aspect of key step 5.

4.2. *Maintaining an Effective Symbiosis*

Brockwell and Bottomley (1995) and Giller (2001) give many examples of sub-optimal N₂ fixation in world agricultural systems. A major cause is considered to be competition for nodulation by ineffective soil-borne rhizobia. Such competition is rarely simple to manage and, at times, it has been difficult even to determine the origin of competitive, yet ineffective, strains. Rhizobia are highly mobile as contaminants of dust and seed. For example, Stepkowski *et al.* (2005) have demonstrated that many of the contemporary lupin and serradella nodule occupants in farmland in South Africa and Western Australia derive from contaminant European strains imported to those continents unintentionally, probably in the preceding 200 years. In the Australian environment, high-quality commercial inocula for medics and clovers have been made available to farmers since the early 1900s (Bullard *et al.*, 2005), yet these same inoculant strains are rarely recovered from nodules (Brockwell *et al.*, 1995; McInnes, 2002) and nodule occupants are frequently ineffective (Ballard *et al.*, 2003). A similar scenario exists for soybeans in some parts of the USA (O'Hara *et al.*, 2002) and Brazil (Hungria and Vargas, 2000; see Chapter 2 of this volume and Volume 4 *Nitrogen Fixation in Agriculture, Forestry, Ecology, and the Environment* of this series).

Evolutionary theorists argue that host sanctions against ineffective nodule occupants should reduce the prevalence of mediocre symbioses (see Chapter 3 of this volume). As this has not yet become evident in the agricultural legumes examined, perhaps the time-frame for such evolution is much greater than the few hundred years in which agriculture has been exploiting legumes outside their centres of evolution. However, even in relatively undisturbed ecosystems, there is abundant evidence of the prevalence of ineffective rhizobial strains. Mesorhizobia that are poorly effective on the annual forage legume *Biserrula pelecinus* were

isolated (5 of 33 strains) from nodules of this species growing in the grasslands of Morocco, Sardinia, and Greece (Howieson, 1999). Perhaps more dramatically, only 1 of 8 strains isolated from the annual herb *Hymenocarpus circinnatus* growing in its natural environment of the Cyclades Greek Islands was capable of N₂ fixation with this host (Howieson, 2000). If the host is indeed placing sanctions upon ineffective nodule occupants, it would appear that there is still scope for the survival of these strains, in both agricultural and natural settings.

This serious issue of competition for nodulation by ineffective rhizobia might be averted, at least initially, by the introduction of novel species or even genera of rhizobia to agricultural environments as inoculants for alternative legumes. Because of genetic incompatibility, these novel genotypes would be incapable of nodulating the existing legumes. The grasslands of Uruguay, where production from grasses is limited by nitrogen deficiency, provide an example of this approach. A native perennial clover (*T. polymorphum*), although well established in these grasslands, is not a highly productive species. It would, therefore, be beneficial to overall system productivity to supplement the growth of this clover with other legumes. A successful approach was the sourcing of alternative legumes, which did not nodulate with the dominant rhizobial ecotypes and whose specific rhizobia could be introduced to that environment (Real *et al.*, 2005). This approach may only offer transient relief from competition, however, as eventually we expect diversification in the rhizobia for the alternative legumes. How does this diversity of soil-inhabiting rhizobial strains arise and can it be managed?

4.3. Diversification of Rhizobia in situ

Research by Sullivan and Ronson (1998) has revealed a potential mechanism for the evolution of diversity in rhizobia in agricultural settings. They have described the transfer of symbiotic DNA in discrete units, termed 'symbiosis islands', from legume inoculants to soil bacteria. Nandasena *et al.* (2006) have subsequently described for the first time how the transfer of a symbiosis island from inoculant mesorhizobia to soil bacteria resulted in the rapid evolution of ineffective strains in the soil. Nodule isolates were recovered from *Biserrula pelecinus* six years after its introduction (with inoculant) to a new environment, which was free of rhizobia that were capable of nodulating this legume. Of 88 nodule isolates, 81 very closely resembled the original inoculant strain of *Mesorhizobium spp.* (WSM1271), and produced equivalent amounts of N₂ fixation under glasshouse conditions. So, six years post-inoculation, and after two intervening cereal crops, nearly 90% of the nodule occupants remained identifiable progeny of the inoculant strain. However, several of the other seven isolates were very poor at N₂ fixation. These isolates (termed novel isolates) had mismatches with WSM1271 in the *16S-rRNA* gene of between three and 23 nucleotides, and clustered separately to WSM1271 in phylogenetic trees constructed using intragenic fragments of the *16S rRNA*, *dnaK*, and *GSII* genes. The novel isolates also had distinct carbon-source utilization patterns that indicated they were different organisms, yet they contained identical sequences for the intragenic regions of *nifH*, *nodA*, and *intS* to WSM1271. These

results provided strong evidence of an exchange of symbiotic DNA that led to the development of an ineffective suite of nodulating bacteria within six years. This key finding explains how ineffective nodule occupants have arisen in agricultural systems, where inoculation by elite strains has been strictly controlled.

The future management of this phenomenon, perhaps through understanding and manipulating the role of genes for excision and integration of the symbiosis island, is one avenue towards maximising long-term N₂ fixation in agriculture. In the future, this may be a “duty of care” issue in key step 5 above. It is also possible that host-mediated sanctions against the mediocre symbioses will prevent the domination of the soil rhizobial populations by these “novel” strains (see Chapter 3 of this volume). However, the emergence of these novel ineffective, but competitive, strains seems to present evidence against the global application of this theory.

5. UTILISING THE BASIC ADVANCES

How does our exploitation of legumes and nitrogen fixation benefit from three decades of molecular investigation? As many chapters in this volume testify, molecular technologies now provide unique tools and approaches that greatly expedite our exploration of the legume symbiosis. In the 1980s, we saw the benefit of reporter-gene fusions to indicate gene transcription. Insertional mutagenesis, a decade later, enabled phenotyping of knock-out mutations, whereas the modern ‘omic’ eras have provided information on enzyme, protein and gene structure and activity. In rhizobiology, these techniques have perhaps been applied most extensively to unravelling the complex signal pathways that govern the early stages of legume–bacterial recognition (see Chapters 5, 6, 7, and 8 of this volume). Further, molecular-marker techniques, such as IVET (*in vivo* expression technology), allow us to now monitor gene expression directly in complex environments, such as in the rhizosphere (Allaway *et al.*, 2001), thus providing the opportunity to understand success or failure of strain genotypes in these environments. Molecular markers have also greatly enhanced the efficiency of legume breeding, for example, in rapidly developing cultivars resistant to anthracnose and phomopsis diseases of *L. angustifolius* (Yang *et al.*, 2004). But can molecular intervention be employed to create transgenic individuals of the nodule bacteria or the legume, which have been modified in any way to enhance function in a given environment? Although there are few outcomes of engineering that have been adopted in current agricultural products, the exploitation of engineered herbicide resistance in *Glycine max* (soybean), insect resistance in cotton *via* the *Bt*-toxin genes, and enhanced β -carotene production in rice, are evidence that applied outputs can be achieved by basic advances. In the latter example, seven foreign genes from two separate pathways were engineered into rice (Potrykus, 2001), although it is contested that the level of β -carotene produced in the transgenic plant will alleviate vitamin-A deficiency.

Foreign-gene insertion is an especially appealing approach to modify characters that respond to manipulation of a single gene. Unfortunately, many of the processes

that are the subject of current research interest are highly complex; stress tolerance, control of recognition and infection, N₂ fixation, bacterial competition, and saprophytic competence (see Chapter 2 of this volume) are all polygenic traits. Further, genes governing some of these traits are now known to be controlled by an associated set of regulatory-gene products. The sigma factors are a good example of regulatory proteins, or protein subunits, whose task it is to ensure that RNA polymerase binds stably at a specific promoter site on DNA. Bacteria use alternative sigma factors to control sets of genes required for specific conditions. Thus, sigma factors may recognise and then potentiate a rapid bacterial response to extracellular signals (Gross, 1996). So, when molecular scientists planned and initiated the molecular manipulation of groups of genes in the late 1980s, they quickly discovered a further level of complexity that involved the regulation of these genes.

Is it then foolish to consider that we will eventually be able to manage the transfer of complex polygenic traits in either the prokaryotic or the eukaryotic components of N₂-fixation systems? Are there already examples where we have achieved this? The greatest likelihood of successful manipulation of a complex trait is where the complete set of genes, which govern and regulate that trait, are found on discrete units of DNA rather than distributed around the chromosome. Localisation of genes that govern a major trait into an operon may allow them to be transferred *in toto*. This appears to be the situation with the symbiosis islands that control nodulation and N₂ fixation in some microbial genera. The recent evidence of the *in situ* transfer of a symbiosis island from both *Lotus* and *Biserrula* mesorhizobia (Nandasena *et al.*, 2006; Sullivan and Ronson, 1998) to soil bacteria to create new nodulating organisms strongly suggests that we should be able to exploit this mechanism in the laboratory. As nature already has, we should be able to produce bacteria with an altered host range for nodulation. For other genera, such as *Sinorhizobium* and *Rhizobium*, where symbiotic genes appear to be located on discrete plasmids, it is feasible that we might also transfer the nodulation character between genera.

Will this provide benefit to agriculture however? A scenario where this might be beneficial is in the acid-sensitive symbiosis between *M. sativa* and *S. meliloti*. This symbiosis is universally accepted as extremely acid sensitive (Dilworth *et al.*, 2001), whereas the symbiosis between *P. vulgaris* and *R. tropici* is considered to be acid tolerant (Graham *et al.*, 1994). The pH-sensitive component of both symbioses resides primarily (but not entirely) with the prokaryotic partner (Cheng *et al.*, 2005; Vargas and Graham, 1988). The bacterial genes for nodulation and N₂ fixation in both symbioses are found on plasmids. The opportunity exists, therefore, to alter the host range of *R. tropici* and so enable it to nodulate *M. sativa*. This approach would potentially create an acid-tolerant microsymbiont for the most important perennial forage legume on the planet.

The current molecular era provides unprecedented opportunities for researching complex traits because complete genome sequences of symbiotic organisms are becoming available. The phenotype(s) expressed following directed or focussed gene disruption provide unprecedented clarity of information on gene function. The availability of rapid sequencing has also been applied to phylogenetic and

taxonomic research, and this has produced a revolution in the classification of the nodulating prokaryotes (see Chapter 2 of this volume). Nodule bacteria now include several representatives of the *beta*-proteobacteria (Chen *et al.*, 2003). Access to molecular methodology for bacterial classification has been especially useful to confront the uncertainty that arises when a legume is apparently nodulated by unusual microsymbionts. In such situations, it has been possible to probe nodule isolates for symbiosis-essential genes, such as *nodA* and *nifH* and, if these are present, to then sequence the *16S-rRNA* gene of the organism to assist in its eventual identification.

There have also been enticing hints that intervention in the genetics of the microsymbiont (Bosworth *et al.*, 1994) or the legume (Carroll *et al.*, 1985) can increase N₂ fixation. Many years on from these reports, these advances have not yet seen large commercial adoption. This is, perhaps, because in situations where the symbiosis is mildly sub-optimal, the genetics of the symbiotic partners are less limiting to N₂ fixation in the field than are other factors, such as light, moisture, and nutrient supply. Where the symbiosis is substantially sub-optimal, straightforward empirical screening, such as that reported by Brockwell *et al.* (1995) and Howieson *et al.* (2000b), can provide a cost-effective and immediate solution to mediocre N₂ fixation.

6. CONCLUSIONS

Despite their widespread biological benefits, most of our legumes have neither been surveyed for their potential contribution to primary production systems nor indeed for their biologically active constituents. This review has attempted to highlight some future uses to which our legumes may be put and pathways to achieve this development. However, our genetic biodiversity is constantly under threat through loss of habitat, desertification, overgrazing, or illegal trade of medicinal plants. Of the 6,000 Latin American legume species, many are considered to be at risk of extinction in the next few decades (Rumbaugh, 1990). Currently, ten species of *Trifolium* endemic to the USA have been identified as threatened and sixteen Old World taxa are known or suspected to be endangered or vulnerable (Morris and Greene, 2001). For several centuries, medicinal plants have also been used by farmers and pastoralists as a primary source of prevention and control of livestock diseases (Hoareau and DaSilva, 1999). With the rapid loss of ethnic cultures and customs, some of these plants used in organized traditional medical systems will also no doubt disappear. It is becoming more important now than ever before that we explore and preserve these species before they are lost to science. Whereas most of the agronomic research into legumes over the last century was directed at increasing yields in food and fibre plants (Abelson, 1994), considerably more emphasis in this century needs to be focused on research to identify plants with potential to supply valuable products for pharmaceutical and nutraceutical use, and for other alternative but valuable roles in modern society. This chapter has attempted to project forward and anticipate some of those roles that may be applicable to legumes and their rhizobia. To quote Akerele (1988), we need to

“Save Plants that Save Lives”. A research focus on the continued exploitation of the enormous natural genetic variation available in both legumes and their microsymbionts will contribute to continued field application of biological N₂ fixation, which is undeniably one of the key biological processes on this planet.

REFERENCES

- Abelson, P. H. (1994). Continuing evolution of U.S. agronomy. *Science*, 264, 1383.
- Adlercreutz, H. (1998). Epidemiology of phytoestrogens. *Baillieres Clin. Endocrinol. Metab.*, 12, 605–623.
- Adlercreutz, H., Markkanen, H., and Watanabe, S. (1993). Plasma concentrations of phyto-oestrogens in Japanese men. *Lancet*, 342, 1209–1210.
- Aerts, R. J., McNabb, W. C., Molan, A., Brand, A., Barry, T. N., and Peters, J. S. (1999). Condensed tannins from *Lotus corniculatus* and *Lotus pedunculatus* exert different effects on the *in vitro* rumen degradation of ribulose-1,5-bisphosphate carboxylase/oxygenase (Rubisco) protein. *J. Sci. Food Agric.*, 79, 79–85.
- Akerle, O. (1988). Medicinal plants and primary health care: An agenda for action. *Fitoterapia*, 59, 355–363.
- Albertazzi, P. (2003). Clinical use of soy products. In G. Samsioe and S. Skouby (Eds.) *Midlife health – Current concepts and challenges for the future* (pp. 189–193). Elsevier International Congress Series, 1229. Amsterdam, The Netherlands: Elsevier.
- Allan, G. L. (2000). Potential for pulses in aquaculture systems. In R. Knight (Ed.), *Linking research and marketing opportunities for pulses in the 21st century* (pp. 507–516). Dordrecht, The Netherlands: Kluwer Academic Publishers.
- Allaway, D., Schofield, N. A., Leonard, M. E., Gilardoni, L., Finan, T. M., and Poole, P. S. (2001). Use of differential fluorescence induction and optical trapping to isolate environmentally induced genes. *Environ. Microbiol.*, 3, 397–406.
- Andrew, C. S. (1978). Mineral characterisation of tropical forage legumes. In C. S. Andrew and E. J. Kamprath (Eds.), *Mineral nutrition of legumes in tropical and subtropical soils* (pp. 93–111). Melbourne, Australia: CSIRO Publishing.
- Athanasiadou, S., Kyriazakis, I., Jackson, F., and Coop, R. L. (2000). Direct effects of condensed tannins towards different gastrointestinal nematodes of sheep: *in vitro* and *in vivo* studies. *Vet. Parasitol.*, 99, 205–219.
- Ballard, R. A., Shepherd, B. R., and Charman, N. (2003). Nodulation and growth of pasture legumes with naturalized soil rhizobia, 3. Lucerne (*Medicago sativa* L.). *Aust. J. Exp. Agric.*, 43, 135–140.
- Balandrin, M. F., Klocke, J. A., Wurtele, E. S., and Bollinger, W. H. (1985). Natural plant chemicals: Sources of industrial and medicinal materials. *Science*, 228, 1154–1160.
- Beck, V., Unterrieder, E., Krenn, L., Kubelka, W., and Jungbauer, A. (2003). Comparison of hormonal activity (estrogen, androgen and progestin) of standardized plant extracts for large scale use in hormone replacement therapy. *J. Steroid Biochem. Mol. Biol.*, 84, 259–268.
- Besier, R. B., and Love, S. C. J. (2003). Anthelmintic resistance in sheep nematodes in Australia: The need for new approaches. *Aust. J. Exp. Agric.*, 43, 1383–1391.
- Bhardwaj, D. K., Murari, R., Seshadri, T. R., and Radikha, S. (1977). Isolation of 7-acetoxy-4-methylcoumarin from *Trigonella foenum-graecum*. *Indian J. Chem.*, 15, 94–95.
- Bosworth, A. H., Williams, M. K., Albrecht, K. A., Kwiatkowski, R., Beynon, J., *et al.* (2004). Alfalfa yield response to inoculation with recombinant strains of *Rhizobium meliloti* with an extra copy of *dctABD* and/or modified *nifA* expression. *Appl. Environ. Microbiol.*, 60, 3815–3832.
- Brockwell, J., and Bottomley, P. J. (1995). Recent advances in inoculant technology and prospects for the future. *Soil Biol. Biochem.*, 27, 683–697.
- Brockwell, J., Bottomley, P. J., and Thies, J. E. (1995). Manipulation of rhizobia microflora for improving legume productivity and soil fertility: A critical assessment. *Plant Soil*, 174, 143–180.
- Bullard, G. K., Roughley, R. J., and Pulsford, D. J. (2005). The legume inoculant industry and inoculant quality control in Australia: 1953–2003. *Aust. J. Exp. Agric.*, 45, 127–140.
- Burnet, M. W. M., Hart, Q., Holtum, J. A. M., and Powles, S. B. (1994). Resistance to nine herbicide classes in a population of rigid ryegrass (*Lolium rigidum*). *Weed Sci.*, 42, 369–377.

- Byerlee, D. E., and White, R. (2000). Agricultural systems intensification and diversification through food legumes: Technological and policy options. In R. Knight (Ed.), *Linking research and marketing opportunities for pulses in the 21st century* (pp. 31-47). Dordrecht, The Netherlands: Kluwer Academic Publishers.
- Carroll, B. J., McNeil, D. L., and Gresshoff, P. M. (1985). Isolation and properties of soybean [*Glycine max* (L.) Merr.] mutants that nodulate in the presence of high nitrate concentrations. *Proc. Natl. Acad. Sci. USA*, *82*, 4162-4166.
- Carrouee, B., Gent, G., and Summerfield, R. J. (2000). Production and uses of grain legumes in the European Union. In R. Knight (Ed.), *Linking research and marketing opportunities for pulses in the 21st century* (pp. 79-98). Dordrecht, The Netherlands: Kluwer Academic Publishers.
- Chatel, D. L., and Parker, C. A. (1973). Survival of field-grown rhizobia over the dry summer period in Western Australia. *Soil Biol. Biochem.*, *5*, 415-423.
- Chen, W. M., Moulin, L., Bontemps, C., Vandamme P., Béna, G., and Boivin-Masson, C. (2003). Legume symbiotic nitrogen fixation by β -Proteobacteria is widespread in nature. *J. Bacteriol.*, *185*, 7266-7272.
- Cheng, Y., Watkin, E. L. J., Howieson, J. G., and O'Hara, G. W. (2005). Root and root hair mechanisms that confer symbiotic competence for nodulation in acidic soils within *Medicago* species: A holistic model. *Aust. J. Exp. Agric.*, *45*, 231-240.
- Cocks, P. S. (2003). The adaptation of perennial legumes to Mediterranean conditions. In S. J. Bennett (Ed.), *New perennial legumes for sustainable agriculture* (pp. 35-56). Perth, W. Australia: University of Western Australia Press.
- Conway, M. J., McCosker, K. J., Osten, V. A., Coaker, S., and Pengelly, B. C. (2001). Butterfly pea - a legume success story in cropping lands of central Queensland, Australia. *Proceedings of 10th Australian Agronomy Conference*, Hobart, Tasmania. Australian Society of Agronomy.
- Coop R. L., and Kyriazakis, I. (1999). Nutrition-parasite interaction. *Vet. Parasitol.*, *84*, 187-204.
- Deaker, R., Roughley, R. J., and Kennedy, I. R. (2004). Legume seed inoculation technology - a review. *Soil Biol. Biochem.*, *36*, 1275-1288.
- Denison, R. F. (2000). Legume sanctions and the evolution of symbiotic cooperation by rhizobia. *Am. Nat.*, *156*, 567-576.
- Dilworth, M. J., Howieson, J. G., Reeve, W. G., Tiwari, R. P., and Glenn, A. R. (2001). Acid tolerance in legume root nodule bacteria and selecting for it. *Aust. J. Exp. Agric.*, *41*, 435-446.
- Dixon, R., and Sumner, L. W. (2003). Legume natural products: Understanding and manipulating complex pathways for human and animal health. *Plant Physiol.*, *131*, 878-885.
- Drewes, S. E., Horn, M. M., Munro, O. Q., Dhlamini, J. T. B., Meyer, J. M. M., and Rakuamboc, C. (2002). Pyrano-isoflavones with erectile-dysfunction activity from *Eriosema kraussianum*. *Phytochemistry*, *59*, 739-747.
- Dry, J., and Vincent, D. (1991). Effect of a fish oil diet on asthma: Results of a 1-year double-blind study. *Int. Arch. Allergy Appl. Immunol.*, *95*, 156-157.
- Duke, J. A. (1981). *Handbook of legumes of world economic importance*. New York, NY: Plenum Press (345 pp.)
- Enneking, D., and Wink, M. (2000). Towards the elimination of anti-nutritional factors in grain legumes. In R. Knight (Ed.), *Linking research and marketing opportunities for pulses in the 21st century* (pp. 671-685). Dordrecht, The Netherlands: Kluwer Academic Publishers.
- Ewing, M. A., and Dolling, P. (2003). Herbaceous perennial pasture legumes: Their role and development in Southern Australian farming systems to enhance system stability and profitability. In S. J. Bennett (Ed.), *New perennial legumes for sustainable agriculture* (pp. 3-14). Perth, W. Australia: University of Western Australia Press.
- File, S. E., Jarrett, N., Fluck, E., Duffy, R., Casey, K., and Wiseman, H. (2001). Eating Soya improves human memory. *Psychopharmacology*, *157*, 430-436.
- Freiberg, C., Fellay, R., Bairoch, A., Broughton, W. J., Rosenthal, A., and Perret, X. (1997). Molecular basis of symbiosis between Rhizobium and legumes. *Nature*, *387*, 394-401.
- Friedericks, J. B., Hagedorn, C., and Vanscoyoc, S. W. (1990). Isolation of *Rhizobium leguminosarum* (biovar *trifolii*) strains from Ethiopian soils and symbiotic effectiveness on African annual clover species. *Appl. Env. Microbiol.*, *56*, 1087-1092.
- Giller, K. E. (2001). *Nitrogen fixation in tropical cropping systems*. Wallingford, UK: CABI Publishing (448 pp.).

- Gintzburger, G., and Le Houerou, H. N. (2003). Useful plants for Mediterranean climate agriculture and rangeland: Problems and solutions for Mediterranean Australia: a review. In S. J. Bennett (Ed.), *New perennial legumes for sustainable agriculture* (pp.15-34). Perth, W. Australia: University of Western Australia Press.
- Gladstones, J. S. (1998). Distribution, origin, taxonomy, history and importance. In J. S. Gladstones, C. A. Atkins and J. Hamblin (Eds.), *Lupins as crop plants: Biology, production, and utilisation* (pp. 1-37). Cambridge, UK: CABI Publishing.
- Gleason, C. E., Ohrt, T., Slattery, A., Meade, S., Carlsson, C. M., et al. (2004). Potential of soy isoflavones to treat age-associated cognitive declines. *Neurobiol. Aging*, 25, S210.
- Glencross, B. D. (2000). Essential fatty acid and lipid requirements of farmed aquatic animals – sourcing the good oils. *Proc. Nutr. Soc. Aust.*, 24, 216-224.
- Graham, P. H. (1992). Stress tolerance in *Rhizobium* and *Bradyrhizobium*, and nodulation under adverse soil conditions. *Can. J. Microbiol.*, 38, 475-484.
- Graham, P. H., Draeger, K. J., Ferrey, M. L., Conroy, M. J., Hammer, B. E., Martinez-Romero, E., et al. (1994). Acid pH tolerance in strains of *Rhizobium* and *Bradyrhizobium*, and initial studies on the basis for acid tolerance in *Rhizobium tropici* UMR1899. *Can. J. Microbiol.*, 40, 198-207.
- Graham, P. H., and Vance, C. P. (2000). Nitrogen fixation in perspective: An overview of research and extension needs. *Field Crops Res.*, 65, 93-106.
- Graham, P. H., and Vance, C. P. (2003). Legumes: Importance and constraints to greater use. *Plant Physiol.*, 131, 872-877.
- Gross, C. A. (1996). Function and regulation of the heat shock proteins. In F. C. Neidhardt, R. Curtiss, J. L. Ingraham, E. C. C. Lin, K. B. Low, B. Magasanik, et al. (Eds.), *Escherichia coli and Salmonella typhimurium: cellular and molecular biology* (pp. 1382-1399). Washington, D.C.: American Society for Microbiology.
- Hamblin, J. (1998). Preface to J. S. Gladstones, C. A. Atkins and J. Hamblin (Eds.), *Lupins as crop plants: Biology, production, and utilisation* (pp. xi -xiii). Cambridge, UK: CABI Publishing.
- Hancock, G. (2002). *Underworld*. New York, NY: Crown Publishers (784 pp.).
- Hapgood, C. H. (1958). *Earth's shifting crust: A key to some basic problems of earth science*. New York, NY: Pantheon Books (446 pp.).
- Herridge, D., and Rose, I. (2000). Breeding for enhanced nitrogen fixation in crop legumes. *Field Crops Res.*, 65, 229-248.
- Herridge, D. F., Howieson, J. G., Anderson, C. A., and Muir, L. L. (2005). Application of rhizobial inoculants to Australian agriculture. *Aust. J. Exp. Agric.*, 45, 127-299.
- Hoareau, L., and DaSilva, E. J. (1999). Medicinal plants: A re-emerging health aid. *Electronic J. Biotechnol.* www.ejbiotechnology.info/content/vol2/issue2/full/2/index.
- Howieson, J. G. (1999). The host-rhizobia relationship. In S. J. Bennett and P. S. Cocks (Eds.), *Genetic resources of Mediterranean pasture and forage legumes* (pp 96-106). Dordrecht, The Netherlands: Kluwer Academic Publishers.
- Howieson, J. G. (2000). Root-nodule bacteria. In N. Maxted and S. J. Bennett (Eds.), *Plant genetic resources of the Mediterranean basin* (pp. 231-244). Dordrecht, The Netherlands: Kluwer Academic Publishers.
- Howieson, J. G., and Ballard, R. (2004). Optimising the legume symbiosis in stressful and competitive environments within southern Australia – some contemporary thoughts. *Soil Biol. Biochem.*, 36, 1261-1273
- Howieson, J. G., O'Hara, G. W., and Carr, S. J. (2000a). Changing roles for legumes in Mediterranean agriculture: Developments from an Australian perspective. *Field Crops Res.*, 65, 107-122.
- Howieson, J. G., Malden, J., Yates, R. J., and O'Hara, G. W. (2000b). Techniques for the selection and development of elite inoculant rhizobial strains in southern Australia. *Symbiosis*, 28, 33-48.
- Howieson, J. G., Yates, R. J., O'Hara, G. W., Ryder, M., and Real, D. (2005). The interactions of *Rhizobium leguminosarum* biovar *trifolii* in nodulation of annual and perennial *Trifolium* spp from diverse centres of origin. *Aust. J. Exp. Agric.*, 45, 199-207.
- Hungria, M., and Vargas, M. A. T. (2000). Environmental factors affecting N₂ fixation in grain legumes in the tropics, with an emphasis on Brazil. *Field Crops Res.*, 65, 151-164.
- Jaftha, J. B., Strijdom, R. W., and Steyn, P. L. (2002). Characterization of pigmented methylotrophic bacteria which nodulate *Lotononis bainesii*. *Syst. Appl. Microbiol.*, 25, 440-449.
- Kahiya, C., Mukaratirwa, S., and Thamsborg, S. M. (2003). Effects of *Acacia nilotica* and *Acacia karoo* diets on *Haemonchus contortus* infection in goats. *Vet. Parasitol.*, 115, 265-274.

- Kelley, T. G., Parthasarathy Rao, P., and Grisko-Kelley, H. (2000). The pulse economy in the mid-1990s: A review of global and regional developments. In R. Knight (Ed.), *Linking research and marketing opportunities for pulses in the 21st century* (pp. 1-30). Dordrecht, The Netherlands: Kluwer Academic Publishers.
- Kingham, A. D., Farnsworth, N. R., Soejarto, D. D., Cordell, G. A., Swanson, S. M., *et al.* (2003). Novel strategies for the discovery of plant-derived anticancer agents. *Pharmaceut. Biol.*, 41(Supplement), 53-67.
- Knight, R. (2000). *Linking research and marketing opportunities for pulses in the 21st century*. Dordrecht, The Netherlands: Kluwer Academic Publishers.
- Lefroy, E. C., and Stirzaker, R. J. (1999). Agroforestry for water management in the cropping zone of Southern Australia. *Agroforestry Syst.*, 45, 277-302.
- Lesins, K. A., and Lesins, I. (1979). *Genus Medicago (Leguminosae): A taxogenetic study*. The Hague, The Netherlands: Dr W. Junk Publishers (228 pp.).
- Liu, M. J., Yue, P. Y. K., Wang, Z., and Wong, R. N. S. (2002). Methyl protodioscin induces G₂/M arrest and apoptosis in K562 cells with the hyperpolarization of mitochondria. *Cancer Lett.*, 224, 229-241.
- Loi, A., Howieson, J. G., Nutt, B. J., and Carr, S. J. (2005). A second generation of annual pasture legumes and their potential for inclusion in Mediterranean-type farming systems. *Aust. J. Exp. Agric.*, 45, 289-299.
- Marley, C. L., Cook, R., Keatinge, R., Barrett, J., and Lampkin, N. H. (2003a). The effect of birdsfoot trefoil (*Lotus corniculatus*) and chicory (*Cichorium intybus*) on parasite intensities and performance of lambs naturally infected with helminth parasites. *Vet. Parasitol.*, 112, 147-155.
- Marley, C. L., Cook, R., Barrett, J., Keatinge, R., Lampkin, N. H., and McBride, S. D. (2003b). The effect of dietary forage on the survival of helminth parasites in ovine faeces. *Vet. Parasitol.*, 118, 93-107.
- Max, R. A., Wakelin, D., Dawson, J. M., Kimambo, A. E., Kassuku, A. A., Mtenga, L. A., *et al.* (2005). Effect of quebracho tannin on faecal egg counts and worm burdens of temperate sheep with challenge nematode infections. *J. Agric. Sci.*, 143, 519-527.
- Maxted, N. (1999). Ecogeography and genetic conservation. In S. J. Bennett and P. S. Cocks (Eds.), *Genetic resources of Mediterranean pasture and forage legumes* (pp. 53-66). Dordrecht, The Netherlands: Kluwer Academic Publishers.
- McInnes, A. (2002). *Bradyrhizobium* sp. (*Lupinus*) associated with serradella in Western Australia. Ph.D. thesis. The University of Western Australia.
- Miles, J. W. (2001). Achievements and perspectives in the breeding of tropical grasses and legumes. *Proc. XIX International Grasslands Congress, Brazil*. São Paulo, Brazil: Brazilian Society of Agronomy.
- Min, B. R., Barry, T. N., Attwood, G. T., and McNabb, W. C. (2003). The effect of condensed tannins on the nutrition and health of ruminants fed fresh temperate forages: A review. *Anim. Feed Sci. Technol.*, 106, 3-19.
- Min, B. R., Pomroy, W. E., Hart, S. P., and Sahlu, T. (2004). The effect of short-term consumption of a forage containing condensed tannins on gastro-intestinal nematode parasite infections in grazing wether goats. *Small Rum. Res.*, 51, 279-283.
- Molan, A. L., Alexander, R. A., Brookes, I. M., and McNabb, W. C. (2000a). Effects of an extract from sulla (*Hedysarum coronarium*) containing condensed tannins on the migration of three sheep gastrointestinal nematodes *in vitro*. *Proc. N.Z. Soc. Anim. Prod.*, 60, 21-25.
- Molan, A. L., Hoskin, S. O., Barry, T. N., and McNabb, W. C. (2000b). Effects of condensed tannins extracted from four forages on the viability of the larvae of deer lungworms and gastrointestinal nematodes. *Vet. Record*, 147, 44-48.
- Molan, A. L., Meagher, L. P., Spencer P. A., and Sivakumaran, S. (2003). Effects of flavan-3-ols on *in vitro* egg hatching, larval development and viability of infective larvae of *Trichostrongylus colubriformis*. *Int. J. Parasitol.*, 33, 1691-1698.
- Morris, J. B. (1999). Legume genetic resources with novel "value added" industrial and pharmaceutical use. In J. Janick (Ed.), *Perspectives on new crops and new uses* (pp. 196-201). Alexandria, VA: ASHS Press.
- Morris, J. B. (2003). Bio-functional legumes with nutraceutical, pharmaceutical, and industrial uses. *Econ. Bot.*, 57, 254-261.
- Morris, J. B., and Greene, S. L. (2001). Defining a multiple-use germplasm collection for the genus *Trifolium*. *Crop Sci.*, 41, 893-901.

- Moulin, L., Munive, A., Dreyfus, B., and Boivin-Masson, C. (2001). Nodulation of legumes by members of the beta-subclass of Proteobacteria. *Nature*, *411*, 948-950.
- Nandasena, K. G., O'Hara, G. W., Tiwari, R. P., and Howieson, J. G. (2006). Rapid *in situ* evolution of nodulating strains for *Biserrula pelecinus* L. through lateral transfer of a symbiosis island from the original mesorhizobial inoculant. *Appl. Env. Microbiol.*, *72*, 7365-7367.
- Naylor, R. L., Goldberg, R. J., Primavera, J. H., Kautsky, N., Beveridge, M. C. M., *et al.* (2000). Effect of aquaculture on world fish supplies. *Nature*, *405*, 1017-1024.
- Nelson, P., and Hawthorne, W. A. (2000). Development of lupins as a crop in Australia. In R. Knight (Ed.), *Linking research and marketing opportunities for pulses in the 21st century* (pp. 549-559). Dordrecht, The Netherlands: Kluwer Academic Publishers.
- Niezen, J. H., Robertson, H. A., Waghorn, G. C., and Charleston, W. A. G. (1998a). Production, faecal egg counts and worm burdens of ewe lambs which grazed six contrasting forages. *Vet. Parasitol.*, *80*, 15-27.
- Niezen, J. H., Waghorn, G. C., and Charleston, W. A. G. (1998b). Establishment and fecundity of *Ostertagia circumcincta* and *Trichostrongylus colubriformis* in lambs fed lotus (*Lotus pedunculatus*) or perennial ryegrass (*Lolium perenne*). *Vet. Parasitol.*, *78*, 13-21.
- Niezen, J. H., Charleston, W. A. G., Robertson, H. A., Shelton, D., Waghorn, G. C., and Green, R. (2002a). The effect of feeding sulla (*Hedysarum coronarium*) or lucerne (*Medicago sativa*) on lamb parasite burdens and development of immunity to gastrointestinal parasites. *Vet. Parasitol.*, *105*, 229-245.
- Niezen, J. H., Waghorn, G. C., Graham, T., Carter, J. L., and Leathwick, D. M. (2002b). The effect of diet fed to lambs on subsequent development of *Trichostrongylus colubriformis* larvae *in vitro* and on pasture. *Vet. Parasitol.*, *105*, 269-283.
- Norris, D. O. (1958). A red strain of *Rhizobium* from *Lotononis bainesii* Baker. *Aust. J. Agric. Res.*, *9*, 629-632.
- O'Hara, G. W., Howieson, J. G., and Graham, P. H. (2002). Nitrogen fixation and agricultural practice. In G. J. Leigh (Ed.), *Nitrogen fixation in the millennium* (pp. 391-410). Amsterdam, The Netherlands: Elsevier.
- Paolini, V., Bergeaud, J. P., Grisez, C., Prevot, F., Dorchies, P., and Hoste, H. (2003). Effects of condensed tannins on goats experimentally infected with *Haemonchus contortus*. *Vet. Parasitol.*, *113*, 253-261.
- Parker, C. A., Trinick, M. J., and Chatel, D. L. (1977). Rhizobia as soil and rhizosphere inhabitants. In R. W. F. Hardy and A. H. Gibson (Eds.), *A Treatise on dinitrogen fixation IV. Agronomy and ecology* (pp. 311-352). New York, NY: John Wiley and Sons.
- Pettersson, D. S. (2000). The use of lupins in feeding systems – a review. *Asian Aust. J. Anim. Sci.*, *13*, 861-882.
- Porta-Puglia, A., Bretag, T. W., Brouwer, J. B., Haware, M. P., and Khalil, S. A. (2000). Direct and indirect influences of morphological variations on diseases, yield and quality. In R. Knight (Ed.), *Linking research and marketing opportunities for pulses in the 21st century* (pp. 199-220). Dordrecht, The Netherlands: Kluwer Academic Publishers.
- Potrykus, I. (2001). Golden rice and beyond. *Plant Physiol.*, *125*, 1157-1161.
- Real, D., Labandera, C., and Howieson, J. G. (2005). Performance of temperate and subtropical forage legumes when over-seeding native pastures of the basaltic region of Uruguay. *Aust. J. Exp. Agric.*, *45*, 279-287.
- Ren, M. Q., Kuhn, G., Wegner, J., and Chen, J. (2001). Isoflavones, substances with multi biological and clinical properties. *Eur. J. Nutr.*, *40*, 135-146.
- Robson, A. D. (1969). Soil factors affecting the distribution of annual *Medicago* species. *J. Aust. Inst. Agric. Sci.*, *35*, 154-167.
- Robson, A. D. (1990). The role of self-regenerating pasture in rotation with cereals in Mediterranean areas. In A. E. Osman, M. M. Ibrahim and M. A. Jones (Eds.), *The Role of legumes in the farming systems of the Mediterranean areas* (pp. 217-236). Dordrecht, The Netherlands: Kluwer Academic Publishers.
- Rogers, M. E., Craig, A. D., Munns, R. E., Colmer, T. D., Nichols, P. G. H., *et al.* (2005). The potential for developing fodder plants for the salt-affected areas of southern and eastern Australia: An overview. *Aust. J. Exp. Agric.*, *45*, 301-329.
- Rolston, M. P. (2003). Seed production issues that limit supplies or result in high market prices of dryland legume species. *Grassland Res. Prac. Ser.*, *11*, 161-167.

- Rumbaugh, M. (1990). Special purpose forage legumes. In J. Janick and J. E. Simon (Eds.), *Advances in new crops* (pp. 183-190). Portland, OR: Timber Press.
- RIRDC (2000). *New pharmaceutical, nutraceutical and industrial products. The Potential for Australian agriculture*. Rural Industries Research and Development Corporation publication No. 00/173 (145 pp.).
- Sabancı, C. O. (1999). Plant genetic resources program in Turkey with special reference to forage legumes. In S. J. Bennett and P. S. Cocks (Eds.), *Genetic resources of Mediterranean forage legumes* (pp.150-162). Dordrecht, The Netherlands: Kluwer Academic Publishers.
- Scales, G. H., Knight, T. L., and Saville, D. J. (1995). Effect of herbage species and feeding level on internal parasites and production performance of grazing lambs. *N.Z. J. Agric. Res.*, 38, 237-247.
- Sessitsch, A., Howieson, J. G., Perret, X., Antoun, H., and Martínez-Romero, E. (2002). Advances in *Rhizobium* research. *Crit. Rev. Plant Sci.*, 21, 323-78.
- Shaik, S. A., Terrill, T. H., Miller, J. E., Kouakou, B., Kannan, G., Kaplan, R. M., et al. (2006). *Sericea lespedeza* hay as a natural deworming agent against gastrointestinal nematode infection in goats. *Vet. Parasitol.*, 139, 150-157.
- Shelton, H. M., Franzel, S., and Peters, M. (2005). Adoption of tropical legume technology around the world: Analysis of success. In D. A. McGilloway (Ed.), *Grassland: A Global resource* (pp. 149-166). Wageningen, The Netherlands: Wageningen Academic Publishers.
- Sprent, J. (2001). *Nodulation in legumes*. Kew, UK: Kew Publishing (156 pp.).
- Stephens, F. O. (1997). Phytoestrogens and prostate cancer: Possible preventive role. *Med. J. Aust.*, 167, 138-140.
- Stepkowski, T., Moulin, L., Krzyzanska, A., McInnes, A., Law, I. J., and Howieson, J. G. (2005). European origin of *Bradyrhizobium* populations infecting lupins and serradella in soils of Western Australia and South Africa. *Appl. Environ. Microbiol.*, 71, 7041-7052.
- Sullivan, J. T., and Ronson, C. W. (1998). Evolution of rhizobia by acquisition of a 500-kb symbiosis island that integrates into a *phe*-tRNA gene. *Proc. Nat. Acad. Sci. USA*, 95, 5145-5149.
- Sy, A., Giraud, E., Jourand, P., Garcia, N., Willems, A., De Lajudie, P., et al. (2001). Methylophilic *Methylobacterium* bacteria nodulate and fix nitrogen in symbiosis with legumes. *J. Bacteriol.*, 183, 214-220.
- Tacon, A. G. J. (1996). *Global trends in aquaculture and aquafeed production. Globefish/FAO Research Program Report*. Rome, Italy: FAO.
- Thein, M. M., and Hein, M. (1997). Rhizobial inoculants production and their on-farm use in Myanmar. In O. P. Rupela, C. Johansen and D. F. Herridge (Eds.), *Extending nitrogen fixation research to farmers' fields* (pp. 227-236). Patancheru, AP, India: ICRISAT.
- Tyler, V. E., Brady, L. R., and Robbers, J. E. (1981). *Pharmacognosy*, 8th ed. Philadelphia, PA: Lea and Febiger.
- Tzamaloukas, O., Athanasiadou, S., Kyriazakis, I., Jackson, F., and Coop, R. L. (2005). The consequences of short-term grazing of bioactive forages on established adult and incoming larvae populations of *Teladorsagia circumcincta* in lambs. *Int. J. Parasitol.*, 35, 329-335.
- Uauy, R., Gattas, V., and Yanez, E. (1995). Sweet lupins in human nutrition. *World Rev. Nutr. Dietetics.*, 77, 75-88.
- Unkovich, M. J., Pate, J. S., and Hamblin, J. (1994). The nitrogen economy of broadacre lupin in southwest Australia. *Aust. J. Agric. Res.*, 45, 149-164.
- USDA (2005). Oil seeds: World markets and trade. <http://www.fas.usda.gov/oilseeds/circular/2004/04-12/FULL.pdf>
- van Barneveld, R. J. (1999). Understanding the nutritional chemistry of lupin (*Lupinus* spp.) seed to improve livestock production efficiency. *Nutr. Res. Rev.*, 12, 203-230.
- van Wyk, B. E. (1991). A synopsis of the genus *Lotononis* (Fabaceae: Crotalarieae). Contributions from the Bolus Herbarium N^o. 14. Wynberg, Cape Town, South Africa: Rustica Press (PTY).
- Vargas, A. A. T., and Graham, P. H. (1988). *Phaseolus vulgaris* cultivar and *Rhizobium* strain variation in acid pH-tolerance and nodulation under acid conditions. *Field Crops Res.*, 19, 91-101.
- Vietmeyer, N. D. (1986). Lesser-known plants of potential use in agriculture and forestry. *Science*, 232, 1379-1384.
- Vincent J. M. (1970). *A Manual for the practical study of the root-nodule bacteria*. IBP handbook No. 15. Oxford, UK: Blackwell Scientific Publications (164 pp.).
- Waghorn, T. S., Molan, A. L., Deighton, M., Alexander, R. A., Leathwick, D. M., et al. (2006). *In vivo* antihelminthic activity of *Dorycnium rectum* and grape seed extract against *Ostertagia* (*Teladorsagia*) *circumcincta* and *Trichostrongylus colubriformis* in sheep. *N. Z. Vet. J.*, 54, 21-27.

- Wang, S. F., Ghisalberti, E. L., and Ridsdill-Smith, J. (1999). Volatile components from *Trifolium* species plants. *Phytochemistry*, *55*, 601-605.
- Wang, T. L., Domoney, C., Hedley, C. L., Casey, R., and Grusak, M. A. (2003). Can we improve the nutritional quality of legume seeds? *Plant Physiol.*, *131*, 886-891.
- Watkin, E. L. J., O'Hara, G. W., Howieson, J. G., and Glenn, A. R. (2000). Identification of tolerance to soil acidity in inoculant strains of *Rhizobium leguminosarum* bv *trifolii*. *Soil Biol. Biochem.*, *32*, 1393-1403.
- Yang, H., Boersma, J. G., You, M., Buirchell, B. J., and Sweetingham, M. W. (2004). Development and implementation of a sequence-specific PCR marker linked to a gene conferring resistance to anthracnose disease in narrow-leaf lupin (*Lupinus angustifolius* L.). *Mol. Breeding*, *14*, 145-151.
- Yates, R. J., di Mattia, E., O'Hara, G. W., Real, D., and Howieson, J. G. (2003). The role of *Rhizobium leguminosarum* bv. *trifolii* in extending (or restricting) the adaptation of *Trifolium* spp. in natural and managed ecosystems. In S. J. Bennett (Ed.), *New perennial legumes for sustainable agriculture* (pp. 116-130). Perth, W. Australia: University of Western Australia Press.
- Yates, R. J., Howieson, J. G., Real, D., Reeve, W. G., Vivas-Marfisi, A., and O'Hara, G. W. (2005). Evidence of selection for effective nodulation in the *Trifolium* spp. symbiosis with *Rhizobium leguminosarum* biovar *trifolii*. *Aust. J. Exp. Agric.*, *45*, 189-198.
- Yates, R. J., Howieson, J. G., Reeve, W. G., Nandasena, K. G., Law, I. J., et al. (2007). *Lotononis angolensis* forms nitrogen fixing, lupinoid nodules with phylogenetically unique, fast-growing, pink-pigmented bacteria, which do not nodulate *L. bainesii* or *L. listii*. *Soil Biol. Biochem.*, *39*, 1680-1688.
- Zahrán, H. H. (1999). *Rhizobium*-legume symbiosis and nitrogen fixation under severe conditions and in an arid climate. *Microbiol. Mol. Biol. Rev.*, *63*, 968-989.
- Zohary, M., and Heller, D. (1984). *The Genus Trifolium*. The Israel Academy of Sciences and Humanities. Jerusalem, Israel: Ahva Coop Printing Press (600 pp).

SUBJECT INDEX

- Acacia*, 9–10, 14
Acid stress, 270–273
Aculeiferum, 10
Acyl homoserine lactones (AHL),
263–266
Aeschynomene, 13, 331, 338
Agrobacterium, 8, 129–130, 132, 139,
165, 176, 248, 256, 260–262,
270–272
Alanine synthesis/metabolism,
248, 296
Albizia, 2
Alfalfa, *see* *Medicago*
Allorhizobium, 25
Alnus, 2
Amide export, 303
 γ -aminobutyric acid, *see* GABA
Ammonia assimilation/transport,
248, 250
Andira, 13
Antioxidants in nodules, 345–351
Arabidopsis, 129, 163–164, 170, 203,
213–217, 307–308, 310, 312,
324, 345, 349
Arachis, 13, 176, 212–213, 217, 364
Ascorbate peroxidase, 347–348
Ascorbic acid, 346, 350–351
Aspalathus, 14
Asparagine synthetase, 309–310
Aspartate aminotransferase, 308–309
Aspergillus, 102
Astragalus, 15, 379
Ateleia, 11
Atropa, 253
AUX/AUX, 164–165
Auxin, 163–165
Azorhizobium, 14, 25, 118, 132, 247
Azospirillum, 41, 102, 126, 263
Azotobacter, 322
Bacillus, 102
Bacteroids, 173–177, 226
developmental fate of, 175–176
differentiation, 174–175
endocytosis, 173–174
gene expression in, 266–267
physiology, 241–276
plant signals in, 176–177
Bean, *see* *Phaseolus*
“ β -rhizobia”, 11, 24
Biserrula, 37, 382–383, 385
Blastobacter, 24–25
Bobgunnia, 11
Bradyoxetin, 135–136, 266
Bradyrhizobium 25–26, 31–32, 37,
39, 41, 60, 122, 127–130, 132,
135–136, 139, 242–251, 254–260,
262, 266, 269–270, 273, 275,
339, 380
Brucella, 176, 256, 272
Burkholderia, 11, 24, 26, 379
Caesalpinioideae, 9
Cajanus, 14, 381
Calcium gradients, 156–159, 162,
194–197
Calopogonium, 123
Calystegia, 253
Campsiandra, 9
Carbonic anhydrase, 300–301
CASTOR/CASTOR, 159, 196,
202, 229
Casuarina, 2
Catalase, 273, 348–349
Cdk/CDK, 160–161, 172
Ceanothus, 2
Cell cycle, 160–161
Chaetocalyx, 13
Chamaecrista, 9, 16, 332

- Chamaecytisus*, 13
 Chemotaxis and motility, 259–263
Chlamydomonas, 203
Cicer, 365, 367–368, 381
Cichorium, 371
Clitoria, 367, 369
 Clover, *see* *Trifolium*
 Colonization of roots, *see* Root colonization
 Commercial inoculants, 92–101
 Competitiveness, 38–39
Convolvulus, 253
Coriaria, 2
 Cortical-cell activation, 160–169
 Cotton, 39, 384
Cupriavidus, 11, 26
Cyathostegia, 11
cyc/Cyc, 160
Cyclolobium, 12, 14
Cyclopia, 14
 Cytokinins, 165
- Dahlstedtia*, 14
Dalea, 31, 36
Datisca, 2
Desmanthus, 31
Devosia, 24, 26
 Dicarboxylate metabolism and transport, 244–247, 251
Dimorphandra, 9
Discolobium, 331
DMI/DMI, 159–160, 173–174, 196–199, 201–204, 221, 230–232
Dorycnium, 372
- Ecology of root-nodule bacteria, 23–43
 Ecto-mycorrhizal fungi, 7, 14
 Endo-mycorrhizal fungi, 3–6, 14
Enod/ENOD, 162, 167–168, 195, 204, 332–333
Ensifer, 24, 26
Eriosema, 370
Erythrophleum, 9, 16
 Ethylene (as hormone), 165–167
- Evolution
 of apyrases, 3–6
 of hemoglobins, 3–6
 of legumes, 1–21
 of mycorrhizas, 3–7
 of signals, 3–6
 of symbiosis, 1–21
 Extracellular polysaccharides (EPS), 134, 142, 162, 265–266, 343
- Faidherbia*, 10
 Flagella, 259–263
 Flavonoids, 117–121, 140–143, 163–165
 perception by NodD, 120–121
Flemingia, 129
 Functional genomics, *see* Genomics
Fusarium, 40–41
- GABA (γ -aminobutyric acid), 246, 302
 Genes in symbiosis, *see* Rhizobia or plant symbiotic genes
 Genome
 conservation, 215–219
 sequencing, 193, 214–215
 Genomics, 193–194, 211–233
Gleditsia, 17
gln/Gln, 225
 Gluconeogenesis (rhizobia), 243–244
 Glutamate synthase (GOGAT), 306–308
 Glutamine synthetase (GS), 225, 305–306
 Glutathione, 346–351
 Glutathione peroxidase, 349
Glycine, *see* Soybean
 Glycogen metabolism, 247–248
Glycyrrhiza, 369
 GOGAT, *see* Glutamate synthase
Grazielodendron, 13
 GS, *see* Glutamine synthetase
Gunnera, 17
- H4/H4*, 161
HAR/HAR, 196, 204, 231, 233
HCL/HCL, 159, 222, 231, 233

- Heat stress, 274–275
Hedysarum, 371–372, 379
 Heme peroxidases, 349
 Hemoglobins
 evolution of, 3–6
 function, 345
 occurrence, 323–324
 Homoglutathione, *see* Glutathione
 Hormones (plant), *see* Plant hormones
 or nodulation
 Host plant, ecosystem fragmentation
 by, 36
 Host-plant sanctions, 35–36, 66–70, 176
 Host-symbiont cooperation
 cheating symbionts, 70–71
 explanations for, 61–70
 mixed nodules, in, 70–71
 problems with, 60–61
 HRGP, 162
 Hydrogenases, 257
 Hydrogen peroxide (H₂O₂), 169, 273,
 322–323, 342–344
 Hydroxyl radical, *see* Reactive oxygen
 species
Hymenocarpus, 383
Hymenolobium, 13

Indigofera, 14
 Infection, 5, 15–16, 156–159, 191–192
 Infection thread
 formation, 156–158
 growth, 162
Inocarpus, 13
 Inoculation
 co-inoculation with PGP
 organisms, 102–103
 commercial inoculants for, 92–101
 constraints to, 107–109
 custom-inoculated seed, 101–102
 formulations for, 93–98
 future prospects for, 105–107
 need for, 78–88
 predicting need for, 86–88
 pre-inoculated seed, 101–102
 quality control for, 103–107
 rhizobia numbers in soil, 81–86
 selecting strains for, 88–92
 storage and shelf life for 99–101
 technologies for, 77–109
 Iron uptake/use, 254–256

Kalanchoe, 140
Kennedy, 14

Lablab, 369
Lactococcus, 200
Lathyrus, 34
 LAX/LAX, 164–165
 Leghemoglobin, 323–324, 336–337,
 344–345
 Legumes
 acid and infertile soils, for,
 378–380
 agricultural uses of, 366–367
 anti-helminthic uses of, 371–372
 aquaculture uses of, 373–374
 breeding constraints of, 367–368,
 375–378
 evolution of, 8–17
 fishmeal, as, 373–374
 future uses for, 363–386
 genetic analysis of, 228–230
 genomics of, 211–219, 228–233,
 313–315
 health benefits of, 369–371
 hydrological stability, for, 375
 maintaining the symbiosis,
 382–383
 metabolomics of, 226–228
 new uses for, 368–380
 pharmaceuticals from, 369–371
 production systems using,
 380–384
 proteomics of, 223–226, 315
 research advances for, 384–386
 transcriptomics of, 219–223
 usage patterns, 365–366
Lens, 34, 365, 367–368
Lessertia, 379–380
Leucaena, 123, 126, 128–129, 244, 252
 Lipochitooligosaccharides, *see* Nod
 factors

- Lipopolysaccharides (LPS), 142–143, 177, 343
- Lolium*, 366
- Lotononis*, 379
- Lotus*, 14, 17, 63, 122–123, 128–129, 142, 162, 165–166, 170, 175, 191–194, 196, 200–201, 203–205, 211–223, 226–233, 297, 300, 305–306, 309, 313–314, 330, 332–333, 335–337, 345, 348, 371–372, 375, 385
- Lupinus*, 13, 38, 170, 248, 300, 302–303, 308, 321, 328, 332, 337, 339–340, 344, 365, 367–368, 373–374
- LYK/LYK, 196, 201, 231–232
- lysR*/LysR-type transcriptional regulator, 118, 121–122, 132
- Macroptilium*, 123, 128, 130, 136, 139, 244, 367
- Maize, *see* *Zea mays*
- Malate dehydrogenase, 301–302
- Malic enzyme, 246
- Malonate metabolism, 246
- Manganese uptake/use, 258
- Medicago*, 4, 15, 34, 42, 64, 122–123, 125, 134, 159, 161–162, 164–166, 168, 170–171, 174–175, 177, 179, 191–194, 196–197, 200–201, 203–205, 211–224, 228–233, 244, 249–250, 297, 300–303, 306–310, 313–314, 322, 325, 331, 333–335, 340, 342, 344, 346–349, 351–352, 364–365, 369, 375, 378, 381, 385
- Melanoxylon*, 9
- Mesorhizobium*, 26, 36–37, 122, 128–130, 132, 142, 242, 254–259, 345, 380, 382–383, 385
- Metabolism (by rhizobia)
- alanine, 248–249
 - ammonium of, 248
 - C and N linkages, 250
 - carbon, of, 242–248
 - Entner-Doudoroff pathway in, 242
 - GABA, of, 246
 - gluconeogenesis, 243–244
 - glycogen of, 247–248
 - malic enzyme, 246
 - malonate of, 246
 - metals in, 254–258
 - nitrogen, of, 248–251
 - organic acid, of, 244–246, 251
 - O₂ regulation of, 244–245
 - pentose-phosphate pathway, 242
 - PHB, of, 247
 - polyols, of, 242–243
 - rhizosphere-associated, 251–253
 - sugars, of, 242–243
 - TCA cycle, 245–246
 - vitamins, of, 258
- Metabolism (in nodules)
- allantoin formed in, 303–304
 - asparagine formed by, 309–310
 - carbon, of, 296–302
 - malate production in, 301–302
 - nitrogen, of, 302–310
 - oxaloacetate made by, 299–301
 - sugars, of, 294–295, 297–299
- Metabolomics, 226–228
- Metal effects
- on legumes, 351
 - on root-nodule bacteria, 351
- Metarhizium*, 102
- Methylobacterium*, 13, 24, 379
- Microsynteny, 215–219
- Mimosa*, 9, 11
- Mimosoideae, 9–11
- Moldenhauwera*, 9
- Motility, *see* Chemotaxis
- Mycorrhiza
- dual infection with, 14, 221
 - evolution of AM, 3–6
 - evolution of ECM, 7
 - infection pathway, 198–199
- Myrica*, 2
- Myxococcus*, 140, 262
- N₂ fixation, 177–178
- O₂ effects on, 321–324
- NARK/NARK, 204, 231
- NCR/NCR, 177

- Nematodes, 7, 371–372
Neptunia, 15, 166, 331–332
NFP/NFP, 196–197, 198–201, 231–232
NFR/NFR, 196, 200–201, 229, 231–232
NGR234, 136–140, 244, 247
Nickel uptake/use, 258
Nif genes, 132–134, 225
NIN/NIN, 196, 203–204, 228–229, 231–233
Nissolia, 13
N₂ fixation, 177–178
 O₂ effects on, 321–324
Nitric oxide, *see* Reactive nitrogen species
Nitrogen assimilation, 302–310
Nod/noe/nol/nop genes, 105, 122–123, 127, 130–140, 154, 200
Nod boxes, 118–120, 122–132, 135, 137–139, 140–141
NodD/NodD, 118–122, 130–140
Nod factors, 105, 122–127
 receptors, 199–201
 signaling, 117–140, 156–160, 194–199
 synthesis genes, 122–125
Nodulation
 autoregulation of, 204–205
 cell-cycle involvement, 160–161
 ethylene (as hormone) in, 165–167
 evolution of, 16
 hydrogen peroxide (H₂O₂) in, 169
 induction of, 160–169, 191–192
 nitric oxide (NO) in, 169
 plant hormones in, 163–169
 reactive oxygen species (ROS) in, 169
Nodules
 adaptation to O₂, 328–331
 allantoin in, 303–304, 311–313
 amide export from, 302–304
 amino acids in, 294–296
 antioxidant enzyme in, 347–349
 antioxidants in, 345–347, 350–351
 asparagine synthetase in, 309–310
 aspartate aminotransferase in, 308–309
 autoregulation in, 204–205
 development of, 3–5, 153–156
 differentiation in, 169–173
 endoreduplication in, 169–173
 glutamate synthase in, 306–308
 glutamine synthetase in, 305–306
 glutathione in, 346–351
 hemoglobins in, 323–324, 345
 internal O₂ of, 324–327, 336–337
 leghemoglobin in, 323–324, 336–337, 344–345
 metabolism in, 226–227, 293–315
 mycorrhizas and, 3–7
 N₂ fixation in, 177–178
 nematode galls and, 7
 nitric oxide in nodules, *see* Reactive nitrogen species
 nitrogenase in, 336–337
 nutrient exchange in, 225–228
 O₂-diffusion barrier, 324–342
 O₂ diffusion into, 324–342
 organic acids in, 294–295
 oxidative stress in, 345–351
 pathways for C/N use in, 293–315
 plant hormones, role of, 163–169
 plasmid transfer, 264–265
 pollen tubes and, 7–8
 polyamines in, 227
 polyols in, 227
 primitive, 15–16
 protection from O₂ in, 324–342
 proteins expressed in, 224–226
 reactive nitrogen species (RNS) in, 322–323, 342–345
 reactive oxygen species (ROS) in, 169, 322–323, 342–345
 responses to O₂, 324–342
 root involvement in, 6–8
 senescence of, 178–179, 350
 sugars in, 294–295
 supply of C to, 293–302
 supply of N to, 302–313
 transporters in, 227–228
 types of, 1–5

- ureide biosynthesis in, 310–313
 ureide export from, 302–304
- Nodulin genes, *see* ENOD
- NORK/NORK*, 159, 231–232
- NSP/NSP*, 160, 196–197, 202–203, 205, 221, 231–232
- ntr/Ntr*, 225
- Ochrobactrum*, 24
- O₂ diffusion/protection, 324–342
- O₂-diffusion barrier in nodules
 development of, 336–338
 evidence against, 340–341
 evidence for, 324–327
 infected zone, in, 341–342
 regulation of, 338–341
 structure of, 327–336
- Onobrychus*, 374, 379
- Ormosia*, 12
- Osmotic stress, 268–270
- Oxidative stress, 273, 345–351
- Pachyrhizus*, 123, 128–129
- Panicum*, 308
- Papilionoideae, 11–15
- Parasponia*, 3, 331–332
- Pea, *see* *Pisum*
- Peanut, *see* *Arachis*
- Penicillium*, 102
- Pentaclethra*, 10
- Peribacteroid, *see* Symbiosome
- Peroxides, *see* Reactive oxygen species
- Peroxiredoxins, 349
- Peroxynitrite in nodules, *see* Reactive nitrogen species
- Phaseolus*, 28–32, 34, 41, 63, 123, 212–213, 215, 271, 297, 299–300, 302–303, 305, 309, 311–315, 325, 333, 343–344, 346, 364–365, 381, 385PHB, *see* Polyhydroxybutyrate
- pH effects on rhizobia, *see* Rhizobia
- PHB, *see* Polyhydroxybutyrate
- Phosphate uptake, 274
- Phosphoenolpyruvate carboxylase (PEPC), 299–300
- Phyllobacterium*, 24
- Phyllostineae*, 10
- Phytochelatin, 351
- Phytophthora*, 102
- PIN/PIN*, 164–165
- Pisum*, 2, 15, 34, 37, 64–65, 125, 142, 174, 196, 200–201, 203, 212, 215, 230–233, 242–243, 246, 248–249, 296–297, 299–303, 305, 310, 322, 324–325, 328, 331–334, 336, 342–344, 346, 352, 364–365
- Pithecellobium*, 11
- Pithium*, 40
- Plant hormones, 163–169
- Poecilanthe*, 12, 14
- Pollen tubes, 7–8, 162
- POLLUX/POLLUX*, 159, 196, 202, 229
- Polyhydroxybutyrate, 64–65, 247
- Primitive nodules, 15–16
- Protein-secretion systems
 TFSS type (IV), 129–131, 140, 142
 TTSS type (III), 128–131, 140, 142
- Proteomics, 223–226
- Pseudomonas*, 4, 40–41, 102, 176
- Pterocarpus*, 13
- Pueraria*, 369
- Quorum sensing, 34–35, 136, 263–266
- Ralstonia*, 11, 24, 26, 121, 139
- Reactive nitrogen species (RNS), 322–323, 342–345
- Reactive oxygen species (ROS), 169, 322–323, 342–345
- Rhizobia
 biocontrol agents, as, 39–40
 chemotaxis by, 259–263
 co-inoculation with PGP organisms, 102–103
 competitiveness of, 38–39
 diversity in soil, 28–33, 383–384
 ecology of, 23–43
 edaphic factors on, 41–43
 effect of host diversity, 37–38

- endophytes, as, 39–41
environmental effects on, 259–266
EPS by, 265
host influence on, 33–35
host sanctions on, 35–36, 66–70
metabolism of, 242–251
motility of, 259–263
persistence of, 38–39
pH effects on, 41–42, 270–273
physiology of, 241–276
plasmid transfer, 264–265
quorum sensing by, 263–266
stress responses of, 267–276
symbiotic genes in, 117–142,
158–160
nod-box regulation of, 130–140
temperature effects on, 41–42
- Rhizobium* 26–32, 34, 36, 39–42, 63,
118, 120, 122–123, 125–126,
128–134, 136–143, 157, 165,
175, 200, 242–265, 269–274,
343, 347, 385
- Rhizopines, 63–64, 176, 252
Rhizosphere and metabolism,
251–253
Rhynchosia, 379
Rice, 39, 213, 324, 364, 384
Root colonization, 38–39
Root-hair
calcium gradients, 156–159, 162
deformation, 156–159,
194–195, 198
Root involvement, 6–8
Rosid I clade, 1–3
- Salinity, effect on rhizobial
populations, 41
Salmonella, 176, 249, 255, 259
Sanctions, *see* Host-plant sanctions
Sclerobolium, 9
Senegalia, 10
Sericia, 371
Sesbania, 14–15, 126, 165–167, 173,
204, 231–232, 325, 331, 333,
336, 338, 342, 352
- Shepherdia*, 2
Sinorhizobium, 27, 31, 34, 40–41, 63,
158, 162, 174–175, 177, 221–222,
224, 226, 242–265, 267, 269–274,
343, 347–349, 385
Sophora, 11–12
Sorghum, 39
soybean 31–33, 63, 128–130, 136,
204, 212–217, 219–223, 231–233,
246, 248, 250, 297–298, 300–303,
308–310, 312–315, 321, 327–328,
331, 333–334, 336–341, 343–344,
346, 349, 364, 369–370, 373–374,
381, 384
Starvation stress, 274–275
Streptomyces, 41
Stress responses, 267–276
Stringent response, 274–275
Stylosanthes, 366
Styphnolobium, 11
Sucrose synthase, 297–299
Sugar metabolism, 242–243
Superoxide, *see* reactive oxygen
species
Superoxide dismutase (SOD),
272–273, 342, 347
SUNN/SUNN, 196, 204, 231, 233
Swartzia, 11
SYM/SYM, 159, 196, 200–201,
203–204, 228–233
Symbiosis
diversity of, 1–21
evolution of, 1–21
mycorrhizas and, 3–7
Symbiosome membrane proteins,
223–225
Symbiotic genes, *see* Rhizobia or plant
symbiotic genes
SyrM/SyrM, 132–135, 137–138,
140–141
- Tachigali*, 9, 16
Taxonomy of host plants, 1–21
Taxonomy of root-nodule bacteria,
24–27

- populations, 41–42
- Tephrosia*, 128, 139
- TFSS systems, *see* Protein-secretion systems
- Thermopsis*, 12
- Transcriptomics, 219–223
- Transport
 - amino acids, 249–250
 - ammonium, 250
 - dicarboxylic acids, 246–247
- Trevoa*, 2
- Trichoderma*, 102
- Trifolium*, 15, 64, 242, 246, 302–303, 333, 335, 365, 370, 373–378, 381, 383
- Trigonella*, 370, 375
- TTSS systems, *see* Protein-secretion systems
- Vachellia*, 10
- VAM fungi, *see* Mycorrhiza
- Vicia*, 34, 37, 123, 174, 212, 297, 322, 365, 367–368
- Vigna*, 126, 129–130, 136, 139, 244, 302–303, 326, 329, 340, 346, 365, 367
- Vitamins, 258
- Volvox*, 200
- Wautersia*, 11
- Wheat, 39–40, 364
- Xanthomonas*, 129, 139
- Xylella*, 139
- Zapoteca*, 10
- Zea mays*, 310, 348, 364