



Harvard University  
Library of  
The Medical School  
and  
The School of Public Health



The Gift of

Dr. M. N. Fulton.

Harvard Medical Library  
in the Francis A. Countway  
Library of Medicine - Boston

VERITATEM PER MEDICINAM QUÆRAMUS

L. M. Johnson M. D.



Digitized by the Internet Archive  
in 2011 with funding from  
Open Knowledge Commons and Harvard Medical School

A MANUAL  
OF  
X-RAY TECHNIC

BY  
ARTHUR C. CHRISTIE

MAJOR, MEDICAL OFFICERS' RESERVE CORPS, U. S. ARMY; CHIEF, SECTION OF RÖNTGENOLOGY, SURGEON GENERAL'S OFFICE, U. S. ARMY; FORMERLY CAPTAIN, MEDICAL CORPS, U. S. ARMY, AND PROFESSOR OF RÖNTGENOLOGY AND OPERATIVE SURGERY, ARMY MEDICAL SCHOOL, WASHINGTON, D. C.

*WITH 48 ILLUSTRATIONS*

SECOND EDITION, REVISED AND ENLARGED



PHILADELPHIA & LONDON  
J. B. LIPPINCOTT COMPANY

[1917]

HARVARD UNIVERSITY  
SCHOOL OF MEDICINE AND PUBLIC HEALTH

LIBRARY  
*Gift. Dr. M. N. Fulton*  
21 APR 1937

COPYRIGHT, 1913, BY J. B. LIPPINCOTT COMPANY

COPYRIGHT, 1917, BY J. B. LIPPINCOTT COMPANY

PRINTED BY J. B. LIPPINCOTT COMPANY  
AT THE WASHINGTON SQUARE PRESS  
PHILADELPHIA, U. S. A.

## PREFACE TO SECOND EDITION

THE technic of röntgenology has undergone considerable change in the past few years due to important improvements in apparatus and to increased knowledge gained from experience. It seems desirable for this reason to revise this manual at the present time.

In this revision a description of the Coolidge tube has been added to Chapter III, the chapter on the technic of gastro-intestinal examination has been rewritten and newly illustrated, the chapter on diseases and injuries of the bones has been made more complete by a section on bone tumors, a chapter has been added on the technic of röntgenotherapy, written by my colleague, Dr. Thos. A. Groover, and some minor changes and additions made throughout the manual.

The following terminology has been adopted by the American Röntgen Ray Society and is used throughout this book:

Röntgen—pronounced rent gen; Röntgen ray—a phenomenon in physics discovered by William Conrad Röntgen; Röntgenology—the study and practice of the Röntgen ray as it applies to medicine and surgery; Röntgenologist—one skilled in röntgenology; Röntgenogram—the shadow picture produced by the

Röntgen ray on a sensitized plate or film; Röntgenograph—(verb) to make a röntgenogram; Röntgenoscope—an apparatus for examination with the fluoroscopic screen excited by the Röntgen ray; Röntgenoscopy—examination by means of the röntgenoscope; Röntgenography—the art of making röntgenograms; Röntgenize—to apply the Röntgen ray; Röntgenization—the application of the Röntgen ray; Röntgenism—untoward effect of the Röntgen ray; Röntgen Diagnosis—diagnosis by aid of the Röntgen ray; Röntgenotherapy—treatment by the application of the Röntgen ray; Röntgen Dermatitis—skin reaction due to too strong or too oft-repeated application of the Röntgen ray.

THE AUTHOR.

OCTOBER, 1917.



## PREFACE

THIS short manual on the technic of X-ray examination has been prepared with a view to the needs of the medical service of the United States Army. The small number of medical officers in the service necessitates frequent change of station, so that it often becomes necessary for one to familiarize himself in a comparatively short time with the essentials of radiologic technic. With this in mind it has been the author's aim to limit this work to the absolute essentials, a knowledge of which will enable the operator to do satisfactory work in X-ray diagnosis.

The book may also be found useful by that increasingly large number of physicians and surgeons in private practice who find it necessary or expedient to do their own X-ray work for diagnosis. Resort to a specialist in radiology is earnestly recommended whenever such services can be obtained, but in the smaller cities and towns this is often impossible. It is believed that mastery of the facts contained in this manual will enable those so situated to do satisfactory radiography.

In the preparation of this book many of the larger text-books and many monographs have been freely drawn upon. It has not been deemed necessary, how-

ever, to give an extensive bibliography, for the publications in the entire field of radiology, from the time of the discovery of the X-ray up to the present, are covered in that excellent work, "Die Röntgen-Literatur," by Prof. Dr. Hermann Gocht.

Only a few reproductions of radiograms are published as illustrations to the text because it is believed that ability to interpret radiograms can be gained only by experience with the originals.

Every X-ray operator is urged to make himself thoroughly familiar with the details of construction of the particular apparatus with which he is working. He is then in position to keep it constantly at its point of maximum efficiency. With his apparatus in good condition he can then gradually master the small details so essential to good X-ray work, and with practice in examining radiograms he will finally acquire ability to properly interpret them and so to arrive at correct diagnoses.

A. C. CHRISTIE.

WASHINGTON, D. C., October, 1913.

# CONTENTS

CHAPTER	PAGE
I. ELECTRICITY AND MAGNETISM.....	1
II. THE RÖNTGEN RAY. HISTORY AND PROPERTIES.....	10
III. APPARATUS FOR THE PRODUCTION OF RÖNTGEN RAYS.....	13
IV. APPARATUS FOR EXCITING THE RÖNTGEN-RAY TUBE.....	28
V. APPARATUS FOR EXCITING THE RÖNTGEN-RAY TUBE ( <i>Continued</i> )..	39
VI. RÖNTGENOGRAPHY.....	50
VII. RÖNTGENOSCOPY. STEREOSCOPIC RÖNTGENOGRAPHY. LOCALIZA- TION OF FOREIGN BODIES.....	59
VIII. DISEASES AND INJURIES OF BONES AND JOINTS.....	75
IX. EXAMINATION OF THE HEAD.....	87
X. THE THORAX.....	91
XI. EXAMINATION OF THE GASTRO-INTESTINAL TRACT.....	101
XII. THE URINARY SYSTEM.....	116
XIII. RÖNTGEN THERAPY.....	122
INDEX.....	149



# ILLUSTRATIONS

FIG.	PAGE
1. THE GALVANIC CELL.....	2
2. CELLS GROUPED IN SERIES.....	5
3. CELLS GROUPED IN PARALLEL.....	5
4. ACTION OF BAR MAGNET ON IRON FILINGS.....	8
5. SOLENOID.....	9
6. ELECTRO-MAGNET.....	9
7. EARLY TYPE OF RÖNTGEN-RAY TUBE.....	14
8. JACKSON'S FOCUS TUBE.....	15
9. MODERN TYPE OF RÖNTGEN-RAY TUBE.....	15
10. QUEEN'S SELF-REGULATING TUBE.....	17
11. THE COOLIDGE TUBE.....	24
12. THE OSCILLOSCOPE.....	29
13. VALVE TUBE.....	30
14. THE WEHNELT ELECTROLYTIC INTERRUPTER.....	34
15. ALUMINUM CELL RECTIFIER.....	37
16. RING TYPE OF TRANSFORMER.....	40
17. DIAGRAM OF CONNECTION OF INTERRUPTERLESS APPARATUS.....	42
18-19. ILLUSTRATING RECTIFICATION OF CURRENT BY REVOLVING DISCS	45
20. DIAGRAM OF CONNECTIONS OF AN "INTERRUPTERLESS" APPARATUS OPERATING ON AN ALTERNATING CURRENT.....	46
21. RHEOSTAT.....	49
22. POSITION FOR LATERAL RÖNTGENOGRAPHY OF HEAD.....	88
23. RÖNTGENOGRAPHY OF FRONTAL SINUSES.....	88
24. INTRA-ORAL METHOD OF DENTAL RÖNTGENOGRAPHY.....	88
25. CARDIOSPASM.....	102
26-28. TYPES OF NORMAL STOMACH AND DUODENAL CAP.....	104
29. ORTHOTONIC STOMACH.....	104

30. HYPERTONIC STOMACH.....	104
31. ATONIC STOMACH.....	104
32. PERFORATED GASTRIC ULCER.....	104
33, 34. DISTORTION OF DUODENAL CAP BY ADHESIONS.....	104
35. INCISURA, PRODUCING HOUR-GLASS STOMACH, CAUSED BY ULCER OF LESSER CURVATURE.....	104
36. INCISURA OPPOSITE ULCER OF LESSER CURVATURE.....	104
37. INCISURA OPPOSITE PENETRATING ULCER OF LESSER CURVATURE...	104
38. CARCINOMA OF STOMACH INVOLVING LESSER CURVATURE.....	108
39. LARGE CARCINOMA OF PYLORIC END OF STOMACH.....	108
40. ANNULAR CARCINOMA AT PYLORUS.....	108
41. LARGE CARCINOMA AT PYLORUS.....	108
42. LARGE INFILTRATING CARCINOMA OF STOMACH.....	108
43. GUMMA OF STOMACH.....	108
44. RÖNTGENOGRAM ILLUSTRATING FILLING OF COLON AND ILEUM WITH BARIUM ENEMA.....	114
45. JACKSON'S MEMBRANE CAUSING PARTIAL OBSTRUCTION JUST DISTAL TO HEPATIC FLEXURE.....	114
46. ADHESIONS OF PROXIMAL COLON TO WHOLE EXTENT OF ASCENDING COLON AND CÆCUM.....	114
47. TRANSVERSE COLON ADHERENT TO SIGMOID.....	114
48. PRESSURE OF LARGE TUMOR (CYSTIC KIDNEY) UPON HEPATIC FLEXURE	114

# A MANUAL OF X-RAY TECHNIC

## CHAPTER I.

### ELECTRICITY AND MAGNETISM.

NATURE AND PROPERTIES.—The nature of electricity is known only by its effects. The word is derived from the Greek *elektron*, meaning amber, in which substance Thales, about 600 B.C. first noticed some of the phenomena of electricity. The word “electrics” was first applied by Dr. Gilbert about the year 1600 A.D. to certain substances like amber, sealing wax, etc., which become electrified by friction. The phenomena of electricity are supposed to be due to some stress or strain in the ether.

Electricity may be either static or dynamic.

Static electricity is electricity at rest; it is produced by some form of friction or “influence” machine.

Dynamic electricity may be galvanic or faradic.

Faradic electricity is a derived (induced) form of electricity, so named from Michael Faraday, in which there are rapid alternations of direction.

Galvanic electricity is that produced by the gal-

vanic cell, which, in its simplest form, consists of a jar of dilute sulphuric acid in which are dipped a plate of zinc and one of copper (Fig. 1).

According to the theory of Arrhenius the affinity of the zinc for the acid radical  $\text{SO}_4$  starts a chemical

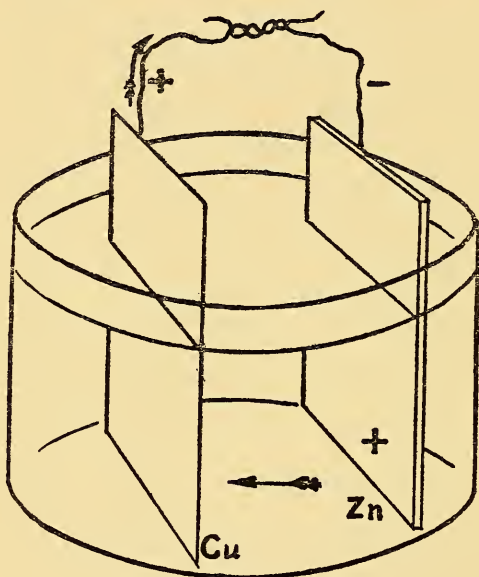

FIG. 1.—The galvanic cell.

reaction which results in the determination of positive ions toward the copper and of negative ions toward the zinc. In consequence of this ionic movement an electrical current is produced from the zinc to the copper through the liquid, and outside of the cell from the copper to the zinc through a connecting wire.



Polarization of a galvanic cell takes place by the collection of bubbles of hydrogen gas on the copper plate and interferes with or stops the action of the cell. Various devices have been used to prevent this.

**TYPES OF CELLS.**—There are many different types of cells, but only two will be described here.

The Daniell cell consists of a zinc plate immersed in dilute sulphuric acid contained in a porous vessel, outside of which is a perforated copper plate surrounded by a solution of copper sulphate. The hydrogen is taken up by the sulphate before it reaches the copper plate. This cell is very constant because polarization is entirely prevented.

The potassium bichromate cell consists of zinc and carbon plates immersed in a solution of potassium bichromate in dilute sulphuric acid. The action of the sulphuric acid on the bichromate liberates chromic acid, which oxidizes the hydrogen to form water and thus prevents polarization.

**DEFINITIONS OF ELECTRICAL TERMS.**—The *ohm* is the unit of electrical resistance and is represented by the resistance of a column of mercury 106.3 cm. long and 14.4521 gm. in mass at 0°C.

The *ampere* is the unit of current strength and is that current which deposits silver at the rate of 0.001118 gm. per second.

The *volt* is the unit of electrical pressure or electro-motive force; it is that electro-motive force which applied to one ohm produces one ampere.

The *coulomb* is the unit of quantity, being the quantity of electricity conveyed by one ampere in one second.

The *watt* is the unit of power. One ampere with a pressure of one volt produces one watt.

These terms are analogous to certain hydraulic terms. The voltage or electro-motive force corresponds to the head or pressure of water. Electrical resistance, the unit of which is the ohm, is analogous to the frictional resistance to the flow of water in a pipe. The current strength, whose unit is the ampere, is represented by the rate of flow of the water through the pipe. The quantity of electricity per second (coulomb) corresponds to the amount of water delivered per second. In other words, if an electro-motive force of one volt is working against a resistance of one ohm it produces a current of one ampere, which, flowing for one second, produces a coulomb of electricity.

**OHM'S LAW.**—Current strength in amperes is equal to the electro-motive force in volts divided by the resistance of ohms.

$$C = \frac{E}{R} \text{ or } E = C \times R \text{ or } R = \frac{E}{C}$$

**METHODS OF GROUPING GALVANIC CELLS.**—Cells may be grouped in series or in parallel. They are grouped in series (Fig. 2) when the positive pole of one is connected to the negative of the next, and so on. The grouping is in parallel or multiple arc (Fig. 3)

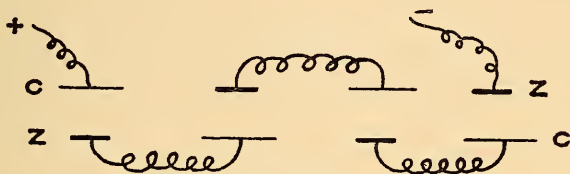

FIG. 2.—Cells grouped in series.

when all of the positive poles are connected together on one side and all of the negatives on the other.

By connecting cells in series a relatively high voltage may be obtained. The E. M. F. is made to

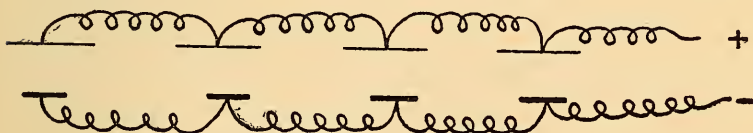

FIG. 3.—Cells grouped in parallel.

equal the E. M. F. of each cell multiplied by the number of cells. With  $n$  cells grouped in this manner we have the following adaptation of Ohm's law:

$$C = \frac{nE}{nr + R}$$

$R$  being the external and  $r$  the internal resistance. From this it is evident that when the external resis-

tance is great, grouping cells in series will give a greater current than parallel grouping.

By connecting cells in parallel the E. M. F. remains that of only one cell, while the resistance becomes that of one cell divided by the number of cells. The amperage is thus increased and becomes the amperage of one cell multiplied by the number of cells. The formula for Ohm's law now becomes

$$C = \frac{E}{\frac{r}{n} + R}$$

This method of grouping would therefore give the best results when the external resistance is small.

**KINDS OF ELECTRIFICATION.**—Electrification may be manifested by repulsion as well as by attraction, and is of two kinds, opposite in character. The electrification developed by rubbing glass with silk is called positive, and that developed by rubbing sealing wax with flannel is called negative. Bodies similarly electrified repel each other and those oppositely electrified attract each other.

**CONDUCTION.**—Electrification by conduction is the process of charging a body by putting it in contact with an electrified body. The charge thus produced is of the same kind as that of the communicating body.

**INDUCTION.**—This is the process of electrifying a body by bringing it near to, but not in contact with, an

electrified body. The charge thus produced is of the opposite kind to that of the communicating body. A current of electricity in one of two wires placed near each other produces no effect in the second wire so long as the current flows steadily, but whenever the current is increased or decreased in strength a current is "induced" in the second wire. This current in the second wire depends upon the presence of a "field of force" which surrounds every electrically charged body. At the instant when the primary current begins or increases in strength a weak current in the opposite direction is generated in the secondary wire; at the instant when the primary current stops or decreases in strength a strong current in the same direction is generated in the secondary.

**MAGNETISM.**—Magnetism is the property by virtue of which a body attracts iron or steel, and which causes the iron or steel when suspended to take a position pointing approximately north and south.

A magnet may be a natural one, as lodestone, or an artificial one. Artificial magnets are either permanent or temporary.

The ends of a magnet are called the poles. The end which points to the north when the magnet is freely suspended is the north, marked, or + pole, while that which points to the south is the south, unmarked, or - pole.

**MAGNETIC FIELD.**—When a bar magnet is placed beneath a sheet of paper on which are some iron filings, the filings will arrange themselves in lines radiating from each pole of the magnet as shown in Fig. 4. The area surrounding any magnetic body is called a magnetic field; it is the space through which the magnetic force acts. The lines of force are supposed to flow from the north to the south pole outside of the magnet and in the opposite direction inside, making a complete circuit.

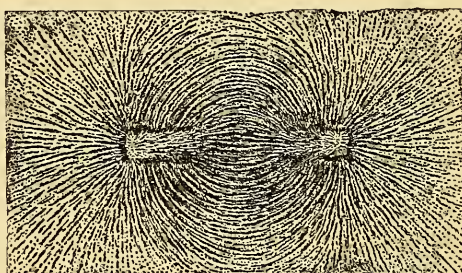

FIG. 4.—Action of bar magnet on iron filings.

**ELECTRO-MAGNETISM.**—It can be shown experimentally that an electric current has magnetic properties; it will deflect the magnetic needle and will cause iron filings to arrange themselves as they do when placed in the field of a magnet.

A coil of wire through which a current is passing is called a solenoid and has all the properties of a magnet (Fig. 5). An electro-magnet is a bar of iron magnetized by an electric current passing through a coil of wire surrounding it (Fig. 6).

The strength of an electro-magnet is directly proportional to the strength of the current passing through the wire surrounding it, and to the number of turns of the wire. Since electric currents may be made very strong and since we may use as many turns of wire as desired, it becomes possible to make electro-magnets of enormous strength.



FIG. 5.—Solenoid.

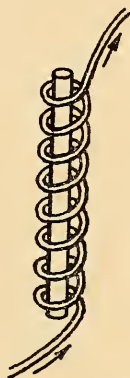

FIG. 6.—Electro-magnet.

Just as a current may be induced in one of two wires lying near each other by increasing or decreasing the strength of the current in the other wire, in the same manner a current may be induced in a coil of wire surrounding an electro-magnet but insulated from it. Upon this fact depends the action of induction coils, transformers, and motor generators, all of which are used in X-ray work.

## CHAPTER II.

### THE RÖNTGEN RAY. HISTORY AND PROPERTIES.

**HISTORY.**—The first vacuum tubes were made by Geissler about the year 1858. The passage of an electric current through these tubes, which were of low vacuum, caused a faint glow, varying in intensity with the degree of vacuum. Hittorf discovered about 1860 that the stream of discharge in a Geissler tube could be deflected by a magnet. It was in 1879 that Sir William Crookes, experimenting with tubes of very high vacuum, discovered the cathode rays. The glow which is present in the tubes of low vacuum has disappeared in these high vacuum tubes and is replaced by a greenish fluorescence of the walls of the tube. To this form of radiant energy Crookes gave the name of cathode rays.

The study of the discharge in high vacuum tubes was continued by many investigators, prominent among whom were Professor Hertz and his assistant Professor Lenard. In 1894 Lenard proved that the cathode rays caused phenomena outside of the tube, for experimenting with a tube having a sheet of aluminum in the end opposite to the cathode he observed that the radiation which passed through the aluminum could cause fluorescence in such substances



as platino-barium cyanide. The next year, 1895, Prof. William Conrad Röntgen, at Würzburg, was experimenting with a high vacuum tube covered with black paper impervious to ordinary light. He noticed that a near-by paper covered with platinobarium cyanide fluoresced brilliantly while the tube was in action. Röntgen realized that this phenomenon must be caused by some hitherto unrecognized force, differing essentially from the cathode rays. Continuing his experiments Röntgen found that he could obtain shadow pictures on photographic plates of metallic objects in a box which was impervious to light, and also of the bones of the hand. He soon made his discovery public and it was only a short time until the use of the rays became general for diagnosis, and not long until valuable therapeutic effects were also observed.

**THE CATHODE RAYS.**—These rays are formed at the cathode of high vacuum tubes and are believed to be streams of electrified molecules shot off from the cathode. They have the following properties: (1) they can be deflected by a magnet; (2) they cause fluorescence and phosphorescence of certain substances; (3) they affect photographic plates like ordinary light; (4) they have no known effect on the bodily tissues.

**THE RELATION OF THE CATHODE RAYS TO X-RAYS.**  
—The X-ray is formed at the point of impact of the cathode ray upon any solid object.

X-rays themselves are believed to be due to some disturbance in the ether and to be true rays. They have the following properties: (1) they are not deflected by a magnet; (2) they are invisible but cause fluorescence and phosphorescence of certain substances; (3) they affect photographic plates like ordinary light; (4) they travel in straight lines,—cannot be reflected or refracted; (5) they will pass through all known substances with varying degrees of intensity; (6) they cause the air to become a conductor and consequently cause the discharge of electrically charged bodies; (7) they have marked effects on the bodily tissues.

## CHAPTER III.

### APPARATUS FOR THE PRODUCTION OF RÖNTGEN RAYS.

THE apparatus necessary for the production of Röntgen rays consists of suitable vacuum tubes, and of some form of installation for the production of suitable currents (static machine, induction coil, or transformer).

#### VACUUM TUBES.

The earliest forms of vacuum tubes were the Geissler tubes. These are of low vacuum and transmit electric currents more readily than air. During such passage the tube lights up with a soft luminous glow. As the tube is still further exhausted the current passes with greater difficulty and the luminous glow is replaced by a greenish fluorescence of the walls of the tube. When it reaches this degree of vacuum it is known as a Crookes tube and in it are produced the cathode rays. These in turn give rise to the Röntgen ray wherever they strike any solid object.

The first Röntgen-ray tubes were somewhat conical in shape, the cathode, which was a flat disc, being placed in the small end (Fig. 7). The cathode rays were thus thrown upon the opposite end of the tube, the anode being ring-shaped so as not to obstruct the passage of the rays.

A great advance was made when Herbert Jackson devised a tube with a metallic target fixed within it at or near the focus point of the cathode stream (Fig. 8). This "focus" tube has undergone many modifications, among which the most important were the addition of an accessory anode, and of a device to regulate the vacuum.

A late model Röntgen tube is one in which the air

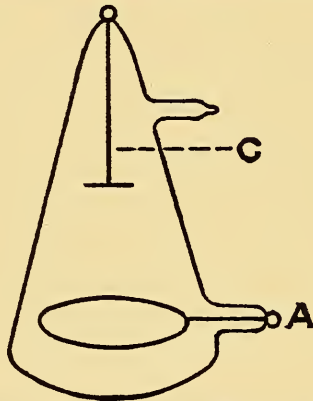

FIG. 7.—Early type of Röntgen-ray tube.

has been exhausted by means of mercury pumps to about one-millionth of an atmosphere. The essential parts of the tube are the cathode, the anti-cathode or target, the accessory anode, and some device to regulate the vacuum (Fig. 9).

The cathode of a focus tube is made of aluminum, because this metal does not suffer disintegration with consequent discoloration of the walls of the tube. The

concave form of the cathode causes the cathode rays to be focussed upon a point on the target, or anti-cathode, as it is called.

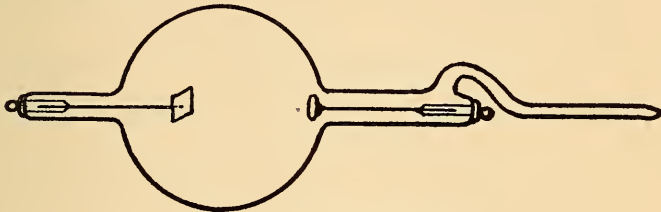

FIG. 8.—Jackson's focus tube.

As tubes are now constructed, the target is always an anode of the tube, but it is not necessarily so. The target is usually made of platinum, because the intense

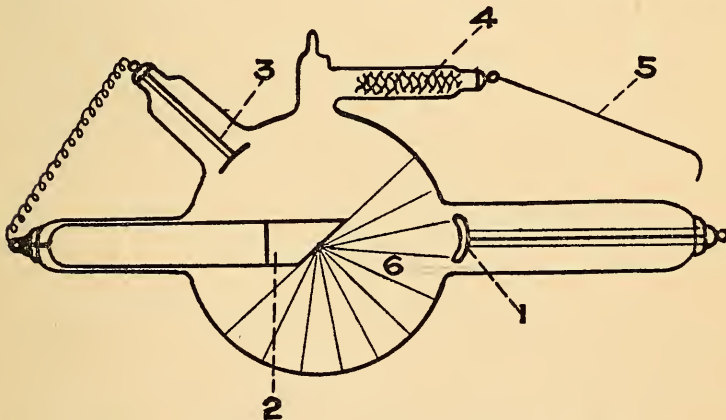

FIG. 9.—Modern type of Röntgen-ray or focus tube. 1, cathode; 2, target; 3, accessory anode; 4, vacuum regulator; 5, adjustable wire; 6, X-ray hemisphere.

heat generated at the point of impact of the cathode stream requires a metal whose fusing point is very high. Even platinum is not entirely infusible and

often melts under the intense heat generated. Iridium and osmium have been used to some extent, and tubes are now being made with tungsten targets. The latter has now practically replaced platinum for this purpose. The target is usually surrounded by a heavy block of some metal, such as copper, which is a good conductor of heat. As an additional precaution against fusing, the target is often placed at a point just beyond the mathematical focus of the tube. Water-cooled tubes, in which a column of water is sealed in a tube surrounding the anti-cathode, or allowed to flow through it, are also used to prevent fusing of the target. If certain defects, such as the danger of breakage, could be overcome in these tubes they would be ideal for Röntgen work. The target is placed obliquely to the axis of all tubes so that the greater part of the Röntgen rays are thrown out at one side.

The accessory anode is made of aluminum. It is connected to the anti-cathode by a wire outside of the tube. Tubes furnished with an accessory anode do not increase in resistance so rapidly as do those of older models.

**REGULATING THE VACUUM IN THE RÖNTGEN TUBE.**—The tendency of the Röntgen tube to increase in resistance, making it increasingly difficult for the current to pass through it, has caused the introduction of many contrivances for lowering the vacuum when

it has become too high. One of these was the osmo-regulator of Villard. It consisted of a platinum pin sealed into the tube with one end projecting outside. Heating the projecting end with a flame caused the platinum to become porous and to absorb hydrogen, thus lowering the vacuum of the tube.

Baking a tube in an oven at  $200^{\circ}$  to  $300^{\circ}$  F. for several hours will also lower the vacuum.

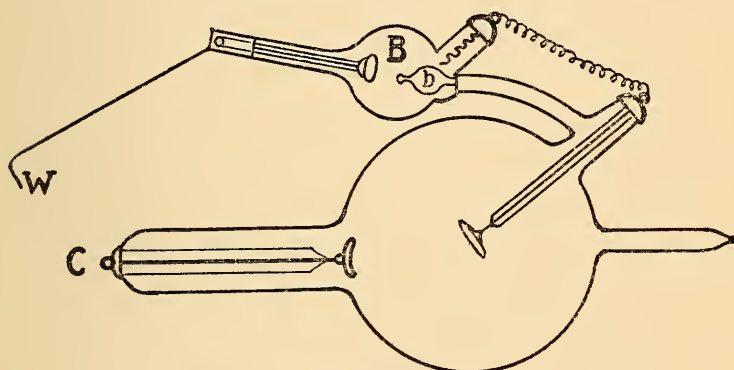

FIG. 10.—Queen's self-regulating tube.

In 1896 Queen's self-regulating tube came into use (Fig. 10). This tube had a relatively large accessory bulb *B* in which was sealed a smaller bulb *b*, the latter containing some chemical such as potassium chlorate. The smaller bulb connected directly with the main bulb. When the vacuum in the main bulb was too high the current could no longer pass directly through the tube but sparked across the path of less resistance

from the cathode *C* to the end of the adjustable wire *W*, causing the potassium chlorate in the small bulb to become heated. The vapor given off into the tube from the potassium chlorate lowered the vacuum in the main bulb until the current could pass directly through, when the sparking from the cathode to the adjustable wire ceased.

The regulating device most largely used at present is one in which the accessory tube connects directly with the main bulb (Fig. 9). Asbestos is the substance usually used instead of the chemical of the old Queen tube. When the current sparks across from the cathode to the adjustable wire, air is forced out of the interstices of the asbestos and the vacuum consequently lowered. Instead of using the adjustable wire on the tube the regulating device may be connected by a third wire to an adjustable spark gap on the coil or transformer. This is the most convenient method since it enables the operator to regulate the vacuum from a distance.

When new tubes are ordered it is necessary to specify whether they are to be used with a coil or a transformer, since tubes pumped for use with a coil are of too high vacuum for use with a transformer.

When a new tube is received it is usually found to be of relatively low vacuum, but after being used a few times it reaches its point of maximum usefulness.



The vacuum then seems to remain about stationary for some time and then gradually increases until it reaches a point where it must be lowered every time it is used. Finally the vacuum becomes so high that it can no longer be lowered sufficiently to allow the current to pass.

**DIRECTIONS FOR REGULATING THE VACUUM.**—If the current cannot pass through the tube on account of the high vacuum it sparks across between the positive and negative terminals of the coil or transformer. An adjustable spark gap is provided so that the operator may measure the length of the spark. The length of spark that a tube will “back-up” is a measure of the resistance of that tube.

If the tube is too high to allow the current to pass when the latter is at its full strength, the end of the adjustable wire should be placed at a distance of about two inches from the cathode (never touching it) and the weakest current possible allowed to spark across to the regulator. The wire is then moved to a distance of five or six inches from the cathode and the current turned on to its full strength. This process is repeated until the tube lights up properly and there is no sparking at the parallel spark gap. The same method is followed when the adjustable regulating spark-gap on the apparatus is used instead of the adjustable wire on the tube. Great care must be

exercised in this matter of lowering the vacuum of a tube for it is exceedingly easy to lower it to such an extent as to render it valueless until it is re-pumped. If a strong current is used for regulating it will cause a thick yellow spark to jump across and probably destroy the vacuum.

To increase the vacuum of a tube a weak current may be run through it in a reverse direction for several times. If this is done every day for considerable time the tube becomes higher. A tube will also increase in resistance by constant use.

A Röntgen tube is said to be soft when the vacuum is low, and hard when it is high. The penetrative power of the rays increases with the degree of vacuum and with the strength of the current.

When working well the tube shows a well-marked hemisphere of greenish fluorescence in front of the target, while the part of the tube behind the target is dark.

**SECONDARY RAYS OR SAGNAC RAYS.**—These are rays given off when the Röntgen ray strikes an object, as parts of the apparatus or tissues of the body. They pass in all directions and may blur the röntgenogram; they may even pass through the plate in the wrong direction.

**INDIRECT RAYS.**—These are rays formed at the extremities of the arc and are useless for röntgenogra-

phy. The useful rays are those which come off at right angles from the target. The use of a diaphragm with a circular aperture eliminates most of the indirect rays, and also much of the secondary radiation.

MEANS OF DETERMINING THE INTENSITY OR PENETRATIVE POWER OF THE RÖNTGEN RAYS.—(1)

*Appearance of the Tube:* In a tube of low vacuum the greenish fluorescence is soft and somewhat yellowish and the tube is not so distinctly divided into hemispheres. There is also a bluish color just in front of the cathode, and if the vacuum is very low a blue line may be seen extending from the cathode to the target. In the tube of high vacuum the fluorescence is of a bright green color and the tube is divided into two distinct hemispheres. (2) *Röntgenoscopy:* Using the röntgenoscope and some object such as a skeleton hand as an indicator. It is very dangerous for the operator to use his own hand because of the liability to Röntgen dermatitis and its sequels. (3) *The Spark Gap:* The length of the spark that a tube "backs up" varies with the strength of the current as well as with the resistance of the tube, but if taken in conjunction with the reading of the milliamperemeter it is a good indication of the penetrative power. (4) *The milliammeter:* The reading of the milliammeter also varies with the strength of current and resistance of

tube. It must be remembered that a high reading does not necessarily mean a tube of high penetration. Indeed it more often means just the opposite. The lower the tube the greater the amount of current that can pass through and consequently the higher the reading of the milliammeter. But if the tube gives a spark of four and a half to six inches in length, and at the same time the milliammeter has a high reading, then the degree of penetration is great. (5) *The radiochromometer of Benoist*: The construction of this instrument is based upon the fact that different metals vary in their penetrability to the Röntgen ray. A silver disk 0.11 mm. in thickness placed in the centre of the device is used as the standard of comparison. Around this centre are placed layers of aluminum of varying thickness. The diaphragm is rotated until the tint of the sector corresponds to that of the centre, when it is read off, as No. 1, 2, 3, 4, etc., Benoist.

For röntgenographic work the length of the spark gap and the reading of the milliammeter taken together probably afford the most practical and best method of determining the degree of penetration.

CARE OF THE RÖNTGEN TUBE.—It is necessary to take certain precautions in using focus tubes in order to keep them at the point of maximum usefulness for the longest possible time. In cold weather the tube

should be warmed before use. When hot it should not be allowed to cool off too suddenly. The lead wires ought not to come in contact with the tube when in action, since a spark may jump across to the glass and cause puncture. Keep tubes perfectly clean; a small particle of dust may attract the current and cause puncture. New tubes are likely to be rather unstable in vacuum and should be used cautiously with weak currents, and with very short exposures with strong currents, until they become seasoned. Avoid overheating the tube by too long or too frequent use. The place of greatest heating is around the cathode, and it is here that the greatest number of punctures occur.

MEANS OF DETERMINING THE POSITIVE AND NEGATIVE TERMINALS.—In order to connect the Röntgen-ray tube properly it is necessary to know which is the positive and which the negative terminal of the apparatus from which the current is being taken. This may be determined in the following ways: (1) On the induction coil or transformer the left hand side is usually the positive pole; (2) if both poles are immersed in water, bubbles arise from the negative; (3) the negative pole ionizes a solution of potassium iodide, turning the solution red around this pole by liberating free iodine; (4) the spark at the negative

pole is thick and white, while that at the positive is thin and wiry; (5) when the tube is properly connected, the anode to the positive terminal and the cathode to the negative, the tube lights up in the normal manner with well-marked hemispheres, while if the current is passing through in the opposite direction rings of light are seen extending around the tube in many different directions.

The Coolidge tube (Fig. 11), invented by Mr. Coolidge, of Schenectady, N. Y., constitutes a remarkable

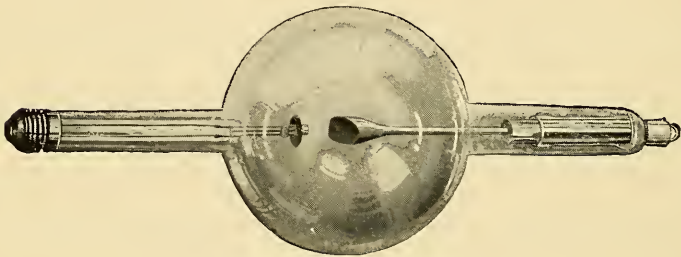

FIG. 11.—The Coolidge tube.

advance in Röntgen apparatus. It differs fundamentally from the older type of tubes. In the latter the stream of electrons is produced by the bombardment of the cathode with positive ions which are produced by the passage of the electric current through the gas contained in the tube. The Coolidge tube is pumped to a much higher degree of vacuum than the gas tubes, so high in fact that no current will pass through it unless the cathode is heated. The electrons constituting the

cathode stream are thrown out by the heated cathode instead of being produced by bombardment of the cathode with positive ions. In order to secure a pure electron discharge from the heated cathode it is, of course, necessary to completely exhaust the tube itself and also to entirely free the electrodes from gas. It was known that the rate of emission of electrons from a hot cathode in very high vacuum increases as the temperature of the cathode rises.

The Coolidge tube differs from the ordinary tube in the following particulars:

(1) The vacuum is as high as it is possible to make it.

(2) The cathode consists of a cylindrical tube of molybdenum, 6.3 mm. inside diameter. This is supported on two molybdenum wires which are sealed into the end of the glass tube. This molybdenum ring acts as a focussing device. Inside of the ring is a closely wound spiral of very fine tungsten filament mounted so as to be concentric with the ring. The spiral is welded to two wires which pass out at the negative end of the tube. Through these two wires passes a low voltage current which serves to heat the tungsten filament, the degree to which it is heated being controlled by an adjustable rheostat. The source of the current for heating the filament may be a small storage battery, or the 110 V. alternating current reduced to the proper

voltage by a suitable transformer. When only the direct current is available a small motor generator is necessary in addition to the transformer. Whether a storage battery or transformer is used it must be insulated from the ground, since it is connected with the high potential current.

(3) The target, instead of being a platinum- or tungsten-faced copper block, is a solid block of tungsten. The target functions as anode, and there is no accessory anode.

The great advantage of the Coolidge tube over the older type consists largely in the ability to regulate the penetration of the former by varying the temperature of the cathode. This is of especial value in röntgenotherapy, since results may be practically duplicated on different occasions. Another great advantage in röntgenotherapy is the fact that the Coolidge tube can be used for practically any length of time. With the gas tube it is necessary either to have a water-cooled target or to make frequent changes of tubes as they become heated.

There is considerable objection to the use of the Coolidge tube for röntgenography and röntgenoscopy, good detail being somewhat lessened by the rays from points on the target other than the focus point. Many of the best röntgenologists use the Coolidge tube for röntgenotherapy and gas tubes for all other work. The



durability and ease of control of the Coolidge tube make it desirable to use it for all purposes, and many have found that very satisfactory practical results can be obtained in röntgenography if care is taken to regulate the tube so that it never has a greater resistance than is necessary to enable the ray to penetrate the particular part being röntgenographed. For instance, it has been found that practically all stomach work can be done with a maximum spark-gap of five inches and forty milliamperes of current, the spark-gap being decreased to as low as four inches with thin patients. Good bone detail can be obtained with the Coolidge tube by using a short spark-gap and about twenty to twenty-five milliamperes of current, and a relatively long exposure. The author uses the Coolidge tube for all purposes, including röntgenography and röntgenoscopy.

## CHAPTER IV.

### APPARATUS FOR EXCITING THE RÖNTGEN-RAY TUBE.

#### STATIC MACHINE AND INDUCTION COIL.

THE apparatus used to excite Röntgen-ray tubes may be a static machine, an induction coil, or a high potential transformer.

The static machine is now little used for Röntgen work, its use being confined to röntgenotherapy. It gives a very uniform discharge at exceedingly high voltage, but the amperage is so low as to necessitate unduly long exposures for röntgenographic work.

#### THE INDUCTION COIL.

An induction coil consists of a core of soft iron wire upon which is wound a primary coil of coarse wire. Upon the primary coil, carefully insulated from it, is wound the secondary coil. The latter is made up of very many turns of fine wire, while the primary consists of relatively few turns of coarse wire. A current is passed through the primary winding and magnetizes the iron core, thus setting up a strong magnetic field through and around the secondary winding. The current in the primary is made to vary rapidly in strength by means of some form of

interrupter, thus producing rapid changes in the intensity of the magnetic field. This reacts upon the windings of the secondary and induces an electromotive force in each turn of the wire. At each make of the current in the primary coil a weak current flowing in the opposite direction is set up in the secondary; while at each break in the current there is induced in the secondary a strong current flowing in the same direction. This break current is the one used to excite the Röntgen-ray tube. If the make current is allowed to pass into the tube "inverse rays" are produced and the efficiency of the ray is greatly reduced.

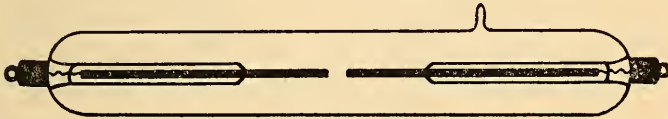

FIG. 12.—The oscilloscope.

**INVERSE CURRENTS.**—A tube in which the inverse current plays a part does not have the clear-cut hemispheres of a properly working tube, but will have one or more green rings back of the target.

The production of inverse currents can also be demonstrated by means of the oscilloscope (Fig. 12). When connected in series with a coil, if the current is unidirectional a violet band will be seen at the negative end, while if there are inverse currents bands of equal or unequal length will be seen at both ends.

Inverse currents may be prevented from entering the tube by introducing a spark-gap of such length that the make current is too weak to pass it.

Another method is to use the ventril or valve tube of Villard (Fig. 13). One pole of the Villard tube is made of a spiral of aluminum giving a large surface. This pole acts well as a cathode and permits currents to pass readily when it is the negative pole.

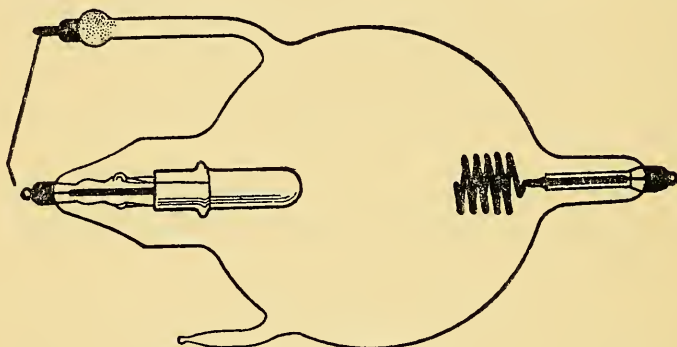

FIG. 13.—Valve tube.

As stated above, the secondary of the induction coil consists of many windings of very fine wire sometimes ten miles or more in length. It is usually wound in sections and these subsequently assembled. All the layers of the coil must be thoroughly insulated, each from the other.

The effect of the induction coil is to change a current of relatively low potential (110 volts) and

high amperage (5-25) to a current of very high potential (100,000 to 150,000 volts) but of correspondingly low amperage.

#### THE INTERRUPTER.

Some means of interrupting the current must be supplied with the induction coil, for it is only by varying the number of lines of force surrounding the primary winding that a current can be set up in the secondary.

Interrupters may be classified as follows:

(1) MECHANICAL.

(a) *Vibrating*. This is the slowest.

(b) *Mercury*. Medium rate.

1. Dipper.

2. Rotary.

3. Jet.

(2) ELECTROLYTIC. Most rapid and therefore give the strongest current.

1. Wehnelt.

2. Caldwell-Simon.

VIBRATING INTERRUPTER.—This interrupter operates on the same principle as the electric bell, and consists essentially of a spring carrying at its end a platinum contact point and an armature of soft iron. The armature is close to the end of the induction coil. The instant a current flows through the primary of

the coil the core becomes magnetized, and acting upon the armature of soft iron pulls the platinum contact point away from its contact with the general circuit. When this happens the circuit is of course broken and the core becomes demagnetized. The armature is no longer held against the core and the spring carries the platinum contact point back to its contact with the main circuit.

There are many modifications of the vibrating interrupter and in some form or other it has been very widely used with Röntgen-ray apparatus, but there are many objectionable features to all of them. The platinum points may become uneven or may fuse, the spring may break, and they are very noisy. They are still used with portable apparatus but practically never with stationary installations. It is quite probable also that the portable apparatus of the future will be some form of high potential transformer actuated by a gas engine, with which an interrupter is unnecessary.

**MERCURY INTERRUPTERS.**—These give a medium rate of make and break and medium strength of current.

*Dipper Mercury Interrupter.*—The contacts are made by a metallic rod dipping into the mercury. The mercury should be covered with a layer of some non-

conducting substance such as paraffin or alcohol so as to effectually prevent sparking. The shaft raising and lowering the metallic rod is operated by a motor connected with a shunt circuit.

*Rotary Mercury Interrupter.*—This consists of a turbine attached to a shaft which is rotated by a motor. There are platinum tips on the turbine and the interruptions are made by these entering and leaving the mercury.

The rate of interruptions with both of these interrupters is regulated by varying the speed of the motor.

*Jet Mercury Interrupters.*—A motor operates a pump which throws jets of mercury in opposite directions. These jets striking the armatures produce the contacts. By raising or lowering the armatures the strength of the current may be increased or decreased.

**ELECTROLYTIC INTERRUPTERS.** — These interrupters depend upon the fact that when a current of electricity is passed through a liquid and one of the metallic electrodes is very small the surface of this electrode becomes covered with a thin layer of gas which stops the flow of the current. As soon as the current stops the gas disappears and the current again flows. These interrupters give as high as 40,000 breaks per minute.

*The Wehnelt Interrupter* (Fig. 14).—The fluid in this interrupter is sulphuric acid diluted with six

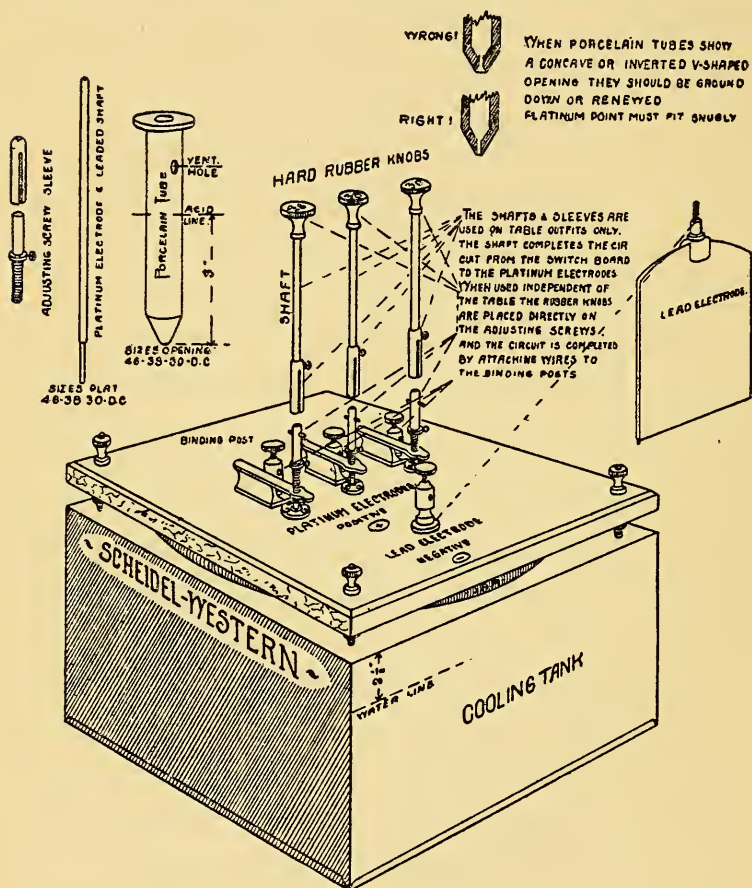

FIG. 14.—The Wehnelt electrolytic interrupter.

times as much water. The small electrode is of platinum, and the large one of lead. The platinum rod is enclosed in a porcelain sheath and by means of a



screw a smaller or larger amount of the platinum may be made to project into the liquid. When a small amount projects the impulses are small and rapid, and when a larger amount projects they are heavier and less rapid.

*The Caldwell-Simon Interrupter.*—This has two large lead electrodes dipping into dilute sulphuric acid, the vessel containing which is divided into halves by a vertical partition. There are very small holes in this partition and when the current passes small bubbles of vapor are formed in them. This causes the break in the current. In this form of interrupter either pole may be the positive, while in the Wehnelt the platinum rod must always form the positive pole.

The electrolytic interrupter is the best for röntgenographic work, while a mercury interrupter is better for röntgenoscopy and for röntgenotherapy.

#### SOURCES OF CURRENT FOR OPERATING AN INDUCTION COIL.

(1) **ELECTRIC BATTERIES.**—All forms of batteries are objectionable because of the corrosive solutions they contain, and because of their rapid deterioration. They are practically never used in X-ray work.

(2) **STORAGE BATTERIES.**—The storage battery of an electric automobile will operate a coil and inter-

rupter. Small portable storage batteries may also be used. The greatest objections to the use of storage batteries for portable apparatus are their great weight and the difficulties of getting them charged. The latter is now accomplished in the military service by using a generator connected with the motor of an automobile or with a small portable gas engine.

(3) **ELECTRIC LIGHTING AND POWER CIRCUITS.**—The 110 or 220 volt lighting circuit with direct current is the best available source of power for a Röntgen-ray coil. The alternating current of the same voltage is also often used, but requires additional apparatus to render it unidirectional. This is described below. Another available source of energy is the 500-volt-power circuit.

**USE OF COIL WITH ALTERNATING CURRENT.**—When only an alternating current can be obtained to operate a coil some means must be used to render it unidirectional. It is possible to use the Wehnelt interrupter for this purpose, but the platinum pole being the negative during one phase of the current gives it an undesirable polarity and causes its rapid destruction.

The aluminum cell rectifier is the device usually employed to rectify alternating currents for use with Röntgen-ray coils. This rectifier transmits about 90

per cent. of the current passing in one direction and almost none of that passing in the other. The rectifier consists of four glass jars containing a solution of Rochelle salts (1 part water to 1 part saturated solution of Rochelle salts). Each jar contains a lead and

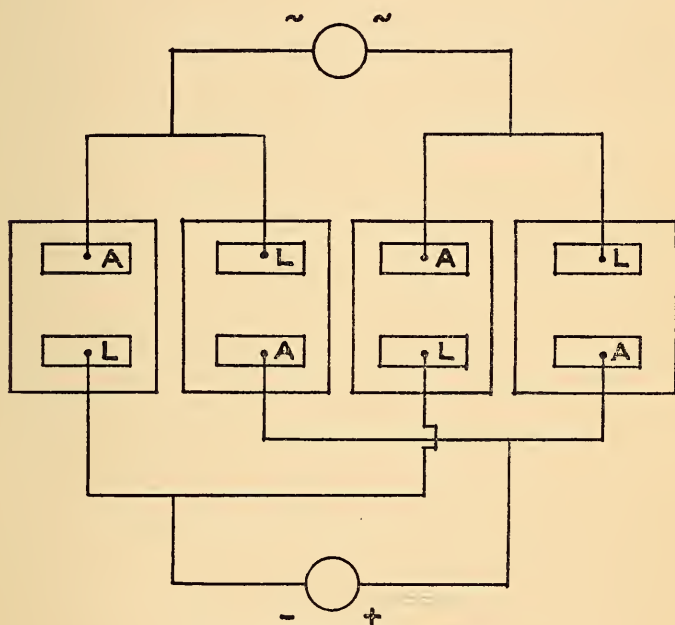

FIG. 15.—Aluminum cell rectifier.

an aluminum plate. The alternating current wires are connected as shown in Fig. 15. The wire which delivers the positive current is connected to the aluminum of two cells and the negative wire comes from the lead of the other two cells. The current

flows readily so long as it is passing from the lead through the solution to the aluminum, but not in the opposite direction, polarization preventing the flow in one direction while offering little obstruction to its passage in the other.

There are other forms of rectifiers for the alternating current, such as the mercury arc and mercury vapor vacuum tube rectifiers, but the one described above is the most commonly used at the present time.

The loss of power is so great with an alternating current that the direct current is always used to operate a coil if it can be obtained.

## CHAPTER V.

### APPARATUS FOR EXCITING THE RÖNTGEN-RAY TUBE (*Continued*).

HIGH-TENSION TRANSFORMERS.—The necessity for using some form of interrupter, and also a rectifier in the case of alternating currents, both containing some liquid, are disadvantages always encountered with coil apparatus. Even with the use of these appliances inverse currents often persist and cause rapid deterioration of tubes, besides making it difficult or impossible to obtain good pictures. For these reasons and because of its added efficiency, the type of apparatus known as a transformer is at present the most satisfactory for exciting the Röntgen-ray tube.

The transformer consists essentially of a primary and a secondary coil, both surrounding a continuous soft iron core. The principle is exactly the same as in the induction coil. With the latter, however, an interrupter must be used, while in the former an alternating current is utilized and the interruptions are supplied directly from the dynamo. The voltage of the secondary current depends upon the proportion between the number of turns of wire in the secondary to the number of turns in the primary. If, for instance, the secondary coil has twice as many turns

as the primary then its voltage will be twice as great as that of the primary. It should be remembered that the amperage undergoes opposite variations at

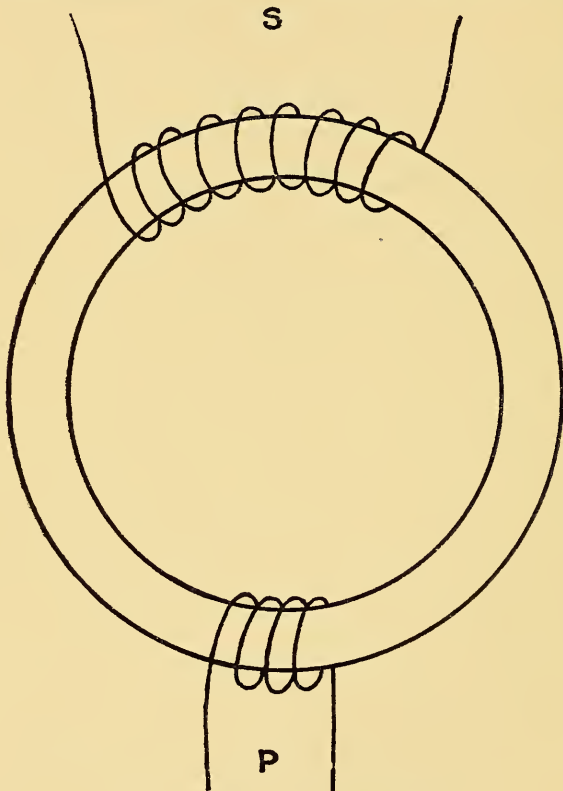

FIG. 16.—Ring type of transformer.

the same time. The transformer is a step-up or step-down transformer, depending upon whether the secondary has a greater or less number of turns than the primary. For Röntgen-ray work the step-up

transformer is necessary. The ring type of transformer is illustrated in Fig. 16, showing the primary and secondary coils surrounding a ring-shaped core of iron. The transformer may be of the shell or jacket type, in which the primary and secondary coils are surrounded by laminated masses of iron, which, from an electrical standpoint, constitute the core.

The efficiency of the transformer is very high, being about 97 per cent. of the energy of the primary. The current furnished to the primary must be an alternating one. If only a direct current is available it must be changed to an alternating one by a motor generator. Operating the generator necessitates a considerable loss of energy, from 30 per cent. to 50 per cent. being lost in this manner. For this reason an alternating current supply is to be greatly preferred to the direct. It is necessary to use a motor even with an alternating current, for reasons which will be explained later, but this causes very little loss of energy.

The 220-volt alternating current is the ideal one for operating a transformer.

Thorough insulation of the primary and secondary coils is necessary. Some makers bury the coils in oil and others use only wax as insulation. The terminals of the secondary coil must also be insulated or separated to a considerable distance from each other, to prevent sparking across.

**METHODS OF RECTIFYING THE CURRENT.**—Just as the current passing through the primary of the transformer is an alternating one, so that in the secondary is of the same character. Before this current can be used to excite a Röntgen-ray tube it must be rendered

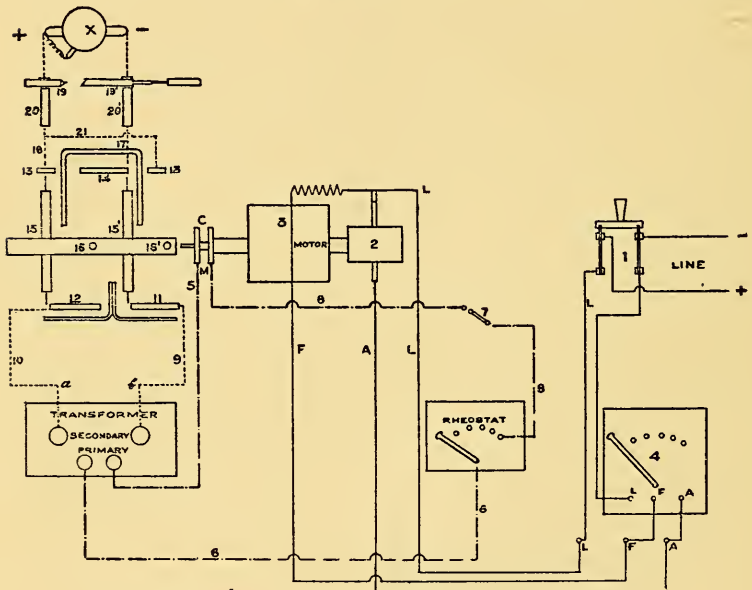

Fig. 17.—Diagram of connections of interrupterless apparatus.

unidirectional by some means. Ventril or valve tubes, previously described, have been used for this purpose, but most high-tension transformers are now provided with some form of mechanical rectifying switches.

Fig. 17 represents diagrammatically the connections of the motor, transformer and rectifying



switches of the so-called "interrupterless" apparatus used for Röntgen-ray work. A direct current is furnished from the line and passes through the switch 1, the line *L* to the armature 2, and the field 3 of the motor generator. From the generator the current returns through the wires *A* and *F* to the motor starter 4, and thence back through the main switch to the line. The motor starter is simply a resistance box and enables one to start the motor gradually. In the generator the current is changed to an alternating one, necessitating a considerable loss of power as mentioned above. This alternating current is taken off from the collecting rings *C* by the brushes *M*, passes through wire 5 to the primary of the transformer, through the windings of the primary to wire 6, through rheostat to wire 8, and the switch 7, back to the collecting ring on the motor. This complete circuit constitutes the primary circuit. The poles of the secondary coil are marked *a* and *b*. As previously stated, the current is here an alternating one, just as in the primary winding. Before it can be utilized to excite the Röntgen-ray tube it must be rendered unidirectional, this being accomplished by means of the four revolving arms 15, 15', 16 and 16'. These arms are mounted on the same shaft as the motor, thus insuring that the revolutions of the rectifying arms are synchronous with the phases of the current from the motor.

This is the reason also why a motor is used even with alternating currents, for if the current were taken directly from an alternating light or power circuit there would be no means of accurately synchronizing the revolutions of the rectifying switches with the phases of the primary current. The manner of operation of the revolving arms is as follows: When *a* is the positive pole of the transformer the current passes through wire 10 to the metal collecting ring 12, sparks across to the end of the copper wire on the revolving arm 15 which is then in position to transmit it, sparks across from this wire at the other end of 15 to the metal plate 13, and passes through wire 18 to the terminal 20 which is connected with the positive terminal of the Röntgen-ray tube. It then passes through the tube to the negative terminal (cathode), through 20' and 17 to the metal plate 14, sparks across to 15' and from 15' to the metal plate 11, which is connected with the negative terminal *b* of the transformer. At the opposite phase of the current *b* is the positive terminal of the secondary and the current is conveyed through 9 to the plate 11; the shaft has now made a quarter turn and instead of 15' being in position to convey the current, 16' is now in position; the current therefore passes through 16' to the metal plate 13' and is conveyed through wire 21 to 18 and thence to the positive

terminal of the tube, just as it was in the first instance when *a* was the positive of the secondary; the current then returns through 20', 17, 14, and revolving arm 16, to 12 and thence to *a*, which is at this instant the negative terminal of the secondary. Thus both phases of the current are utilized, but it always passes through the tube in the same direction, no inverses being produced.

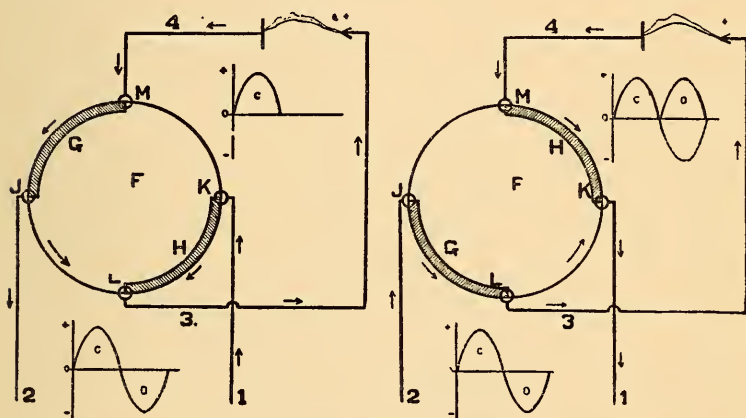

Figs. 18 and 19.—Illustrating rectification of current by revolving discs.

Instead of using four revolving arms to rectify the current, a revolving disc on which are mounted two metal strips is used in some constructions, to secure a unidirectional current. Figs. 17 and 18 illustrate this method of rectification. *F* is a mica disc, *G* and *H* the two metal strips. *J* and *K* are the terminals of the secondary of the transformer. *L* and

*M* represent the brushes which receive the rectified current. In Fig. 18, if 1 is +, the current is taken up by the metal strip *H* and passes out through *L* to the anode of the tube. At the next alternation of the current the condition is shown in Fig. 19. No.

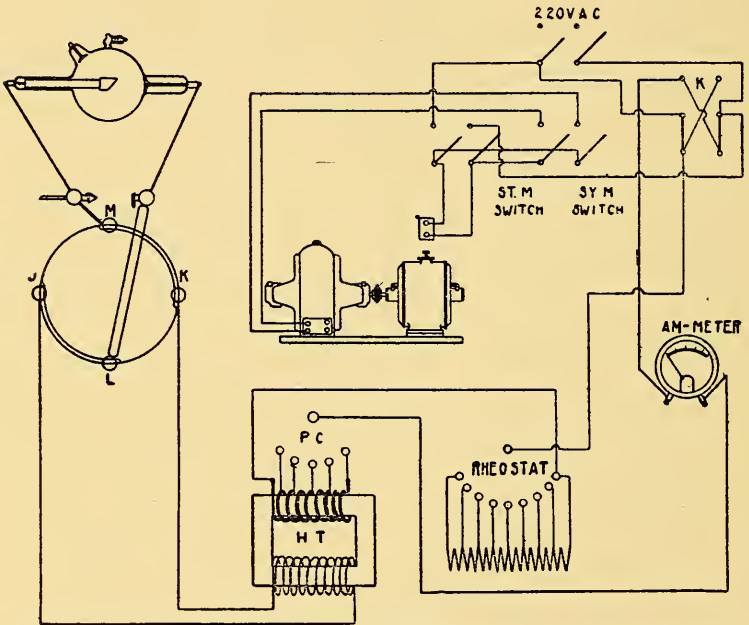

FIG. 20.—Diagram of connections of an "interrupterless" apparatus operating on an alternating current.

2 is now the positive and the metal strips have assumed the position shown by a quarter revolution of the disc; the current again passes through *L* to the anode of the tube. The arrows show the direction of flow of the current in each instance.

Both the system of the four revolving arms and that of the single revolving plate have been found in practice to be durable and efficient.

Fig. 20 is a diagram of the connections of an "interrupterless" apparatus operating on an alternating current. The main current flows directly from the line through the primary of the transformer instead of through the rotary converter as in the case of the direct current.

The two small motors, the starting motor and the synchronous motor, serve simply to revolve the rectifying disc  $J M K$ , the motors and rectifying disc all being mounted on the same shaft. The switch for the starting motor  $S T M$  is first closed, and when this motor has reached its maximum speed the switch to the synchronous motor  $S Y M$  is closed. The shaft is then revolving at the same rate as that of the dynamo in the power house which is the source of the current. This insures that the revolutions of the rectifying disc are exactly synchronous with the alternations of the current passing from the secondary of the transformer to the terminals  $J$  and  $K$ .

#### REGULATING THE CURRENT ON COIL OR TRANSFORMER.

Electric currents are controlled by means of resistance, the current strength being equal to the

electro-motive force divided by the resistance (Ohm's law). Electrical resistance depends upon the material of which the conductor is made, the diameter of its cross-section, its length, and its temperature. Copper wire is one of the best practical conductors of electricity, iron wire not so good, and German silver one of the poorest. The latter is not used at all as a conductor but is very widely used as a resisting medium. The resistance of a conductor is directly proportional to its length and inversely proportional to the area of its cross-section or square of its diameter.

A rheostat is an appliance used to vary the strength of a current by changing the amount of the resistance. For Röntgen-ray apparatus, rheostats are usually made of a number of coils of German silver wire.

In Fig. 21 the dots represent contact-points to which the movable arm may be shifted. Nos. 1 and 2 are connected at the bottom, 2 and 3 at the top, and so on. The leading-in current enters at *H* and when the movable arm is set on the first contact point the current passes through *A*, down coil No. 1, up coil No. 2, down No. 3, and so on until it passes out at *B*. Shifting the arm to the second point eliminates coil No. 1 from the circuit and reduces the amount of resistance, thus increasing the strength of the current.

Resistance may thus be gradually reduced by shifting to successive points until the last one is reached and

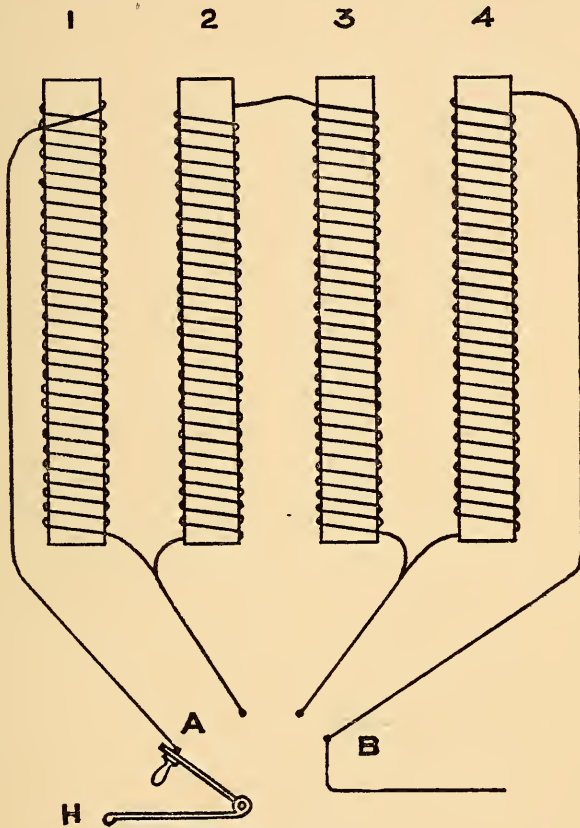

FIG. 21.—Rheostat.

the current flows directly from *H* through the movable arm to *B*, the rheostat no longer being in the circuit.

## CHAPTER VI.

### RÖNTGENOGRAPHY.

THE Röntgen ray acts upon sensitized plates like ordinary light, therefore the making of röntgenograms has much in common with photography. It must always be remembered, however, that whereas the photograph is produced by the action of light which is reflected from the object to be photographed, the röntgenogram, on the other hand, is a record of the penetrability of the different parts of the object to the Röntgen ray.

The photographic plate consists of a piece of glass coated with gelatin containing sensitive silver salts. The salt may be either the bromide, the chloride, or the iodide of silver. The iodide is not often used except occasionally as an addition to the bromide, and the chloride is used only for slow emulsions such as are used on printing-out paper and for lantern slides. The gelatin-bromide emulsion, either with or without the iodide, is the one usually employed. The sensitiveness of the emulsion is governed by the manufacturer by the length of time during which it is subjected to boiling or other method of "ripening." The increase of sensitiveness is said to be due to the enlargement of the particles, something like the growth of particles by crystallization. The



particles as they become larger are able to absorb more light and consequently a greater amount of silver is reduced, rendering the plate more rapid. A similar explanation is given as to why the amount of emulsion on the plate affects its sensitiveness.

Röntgen-ray plates differ from photographic plates only in their greater sensitiveness, the emulsion being thicker than on photographic plates.

The exact effect that light has on silver salts is not yet entirely understood. So far as known, light exerts a reducing effect on the salt, setting free the chlorine, bromine, or iodine. The latent image consists of some modification of the halogen.

In order to bring out the latent image some form of developer is necessary. A developer contains several ingredients known respectively as the reducer, the accelerator, the restrainer, and the preservative. There are a great variety of reducing agents, among which are pyrogallic acid, hydroquinon, metol, amidol, eikonogen, ortal, rodinal, etc. The function of the reducer is to reduce the exposed silver bromide to metallic silver, for it is this metallic silver that produces the lines of the picture. Most of the reducers named, however, will not act quickly enough by themselves, so that an accelerator must be added. Some alkali, usually sodium carbonate, fulfills this function.

The restrainer is added, usually potassium

bromide, so that the developing may be more under control and not take place too rapidly. Sodium sulphite is usually added to act as a preservative, which it does by taking up oxygen and thus preventing oxidation of the reducer.

Following are some formulas for developing solutions:

HYDROQUINON OR QUINOL.

No. 1. Hydroquinon . . . . .	6	gm.
Sodium sulphite . . . . .	50	gm.
Water . . . . .	500	c.c.
 No. 2. Potassium carbonate . . . . .	 100	 gm.
Potassium bromide . . . . .	1.5	gm.
Water . . . . .	500	c.c.

For use take equal parts of No. 1 and No. 2.

The hydroquinon developer may be made in one solution, according to the following formula, but should be made fresh for each day's work:

Hydroquinon . . . . .	36	gm.
Sodium sulphite, dry . . . . .	90	gm.
Potassium carbonate, dry . . . . .	180	gm.
Potassium bromide . . . . .	9	gm.
Water . . . . .	1800	c.c.

Hydroquinon is a reducer which gives great contrast in pictures and since this is a very desirable thing in radiographs it makes a good developer in Röntgen-ray work. Where softer negatives with

greater detail are desired metol is a valuable reducer. Hydroquinon and metol may be used together according to the following formula:

No. 1. Metol .....	1 gm.
Hydroquinon .....	4 gm.
Sodium sulphite .....	50 gm.
Potassium bromide, 10 per cent. sol. ....	4 c.c.
Water .....	250 c.c.
 No. 2. Sodium carbonate .....	 50 gm.
Water .....	250 c.c.
Mix No. 1 and No. 2 in equal parts.	

The advantages of having the accelerator, sodium carbonate, in a separate solution are that the developer keeps better and that development is better under control. If the plate is over-exposed then a small amount of No. 2 should be added; if under-exposed, a proportionately larger amount.

After the negative has been developed it is necessary to remove the silver from the unexposed parts of the film. This is known as fixing, and is effected by placing the plate in a solution of sodium hyposulphite, made according to the following formula:

## A

Water .....	4000 c.c.
Sodium hyposulphite .....	1000 gm.

## B

Water .....	1000 c.c.
Sodium sulphite, dry .....	90 gm.
Sulphuric acid .....	15 c.c.
Powdered chrome alum .....	60 gm.

Mix B in exactly the proportions and sequence given above.

Pour B into A while stirring. During cold weather one-half of B is sufficient for the full quantity of A.

## TECHNIC OF RÖNTGENOGRAPHY.

The X-ray plate is placed in a black envelope, and the latter in an orange envelope. It is so placed that the film side of the plate is next to the smooth side of the envelopes, that is, the side opposite the flaps. The film side is recognized by its dull appearance and by the fact that the slightly moistened finger sticks to it. Some form of plate holder may be used instead of the envelopes. The plate is placed in its envelopes or plate holder in a photographic dark-room illuminated only by a good ruby light. All plates kept in stock should be kept in a lead-lined box in a cool, dry place, and should be put into envelopes or plate holder only immediately before use.

After being placed in its envelopes the plate is taken to the Röntgen-ray room and protected from the ray in a lead-lined box or behind a lead partition

while the tube is being tried and regulated. When the tube is ready the plate is placed under the patient with its centre immediately beneath the centre of the part to be radiographed. The target of the tube is then centred over the centre of the plate at a distance of 18 to 25 inches from the plate.

No definite rules can be given for the time of exposure, since it differs with the strength of the current, the condition of the tube, distance of the tube from the plate, thickness of the part to be röntgenographed, and the sensitiveness of the plate. Every röntgenographer must determine the time of exposure for different parts of the body on his particular apparatus. By recording the reading of the milliammeter, the length of the parallel spark gap, the distance of tube from plate, and the thickness of the part, he will soon be able to estimate very closely the exposure time in each particular case. In general it may be said that the transformer with alternating current supply enables one to do the most rapid work while the transformer with direct current is next. Coil apparatus with direct current comes next to the transformer, while the coil with alternating current supply requires the longest exposures of all.

At the present time excellent intensifying screens made of calcium tungstate are to be had, and when properly used greatly shorten the time of exposure.

The screen should be brushed off carefully each time before using and should be placed in contact with the film side of the plate against which it must be snugly pressed while the exposure is being made. The ray must pass through either the screen or the plate to reach the film. The latter is the most common method. The screen enables one to take practically instantaneous pictures of the bismuth-filled stomach and colon and is indispensable for such work. It is not possible to obtain such fine detail with the screen, however, as without it.

After exposure the plate is taken to the dark room, removed from its envelopes, and placed in the developing solution. It should be slid into the tray of developer and the solution made to cover the entire plate immediately by a wave-like motion. It is important that the developer be kept at a temperature of about 65° to 68° F. All air bubbles should be removed from surface of the plate by rocking the tray. Complete development is judged by the even black appearance of the back of the plate when it is held up to the ruby light. When developed the plate is washed for a moment in running water and placed in the fixer. After it has remained in the fixer for about a minute the light may be turned on. The plate is fixed when all the dull white film has disappeared from it,—a fact which may be determined by looking

at the back of the plate, but it should be left in the solution for about 15 minutes after this has occurred. When the plate is fixed it should be washed for at least an hour in running water.

**OVER-EXPOSED PLATES.**—A plate on which the image flashes up almost immediately upon placing it in the developer is usually over-exposed, and if developed in the usual way would be so dense that the picture could scarcely be seen. It may be taken from the developer immediately and the process finished in a weaker developer, or a few drops of 10 per cent. solution of potassium bromide may be added to restrain the development. If after development the plate is still found to be too black and dense it may be greatly improved by treating it with a reducer. For this purpose the following solution may be used:

Potassium permanganate . . . . .	.5 gm.
Sulphuric acid . . . . .	1 c.c.
Water . . . . .	1050 c.c.

Before treating with this reducer the plate should be washed but does not require to be entirely free from hypo. Rock the dish continually while the plate is in the reducer. If a stain is left by the permanganate it may be removed by a 1 per cent. solution of oxalic acid.

Potassium cyanide is often used as a reducer according to the following formula:

Potassium cyanide .....	1 gm.
Potassium iodide .....	.5 gm.
Mercuric chloride .....	.5 gm.
Water .....	300 c.c.

The plate must be well washed to remove the poisonous chemicals in the above formula.

**UNDER-EXPOSED PLATES.**—Plates that have had insufficient exposure will need to be developed for a long time in a strong developer. Leaving them in too long, however, will often fog them. Under-exposed plates may be much improved by treating them with an intensifying solution such as the following:

Mercuric chloride .....	11 gm.
Potassium bromide .....	6 gm.
Water .....	210 c.c.

Leave the plate in this solution until it looks white, then wash it in running water for about one-half hour. The plate is then placed in

Sodium sulphite .....	45 gm.
Water .....	180 c.c.

until it has turned black, and is then thoroughly washed.

Of course the ideal is to give the correct exposure and to develop to the proper density, but this is not always attained, and many otherwise valueless plates may be saved by reduction or intensification.

Practice is the only way to become proficient in taking and developing röntgenograms.



## CHAPTER VII.

### RÖNTGENOSCOPY. STEREOSCOPIC RÖNTGENOGRAPHY. LOCALIZATION OF FOREIGN BODIES.

#### RÖNTGENOSCOPY.

THE röntgenoscopic screen is made of platino-barium cyanide crystals which fluoresce when the Röntgen ray falls upon them. This screen may be fitted into the end of a light-proof box into which the observer looks, or built into other forms of apparatus. When a part of the body is held between the screen and the Röntgen-ray tube the rays pass with varying degrees of penetration. Around the part where there is no obstruction, they cause the screen to fluoresce very brilliantly; under the soft parts the fluorescence is less brilliant; and if the degree of penetration is correct there is no fluorescence at all beneath the bones, and they appear black.

The long exposures necessary for röntgenoscopic work have made it a very dangerous method to the operator, a fact all-too-well proven by the loss of limbs and even of lives of röntgenographers. Apparatus is now built, however, so that röntgenoscopic work may be done while the operator remains well protected even from secondary radiations.

It is essential for good röntgenoscopic work that the voltage be as high as possible, but only a few milliamperes of current are necessary. The static machine is therefore ideal for this purpose. Satisfactory röntgenoscopic work may be done, however, with either coil or transformer if they are equipped with some arrangement for delivering a very small current to the tube without lessening the voltage. Different manufacturers have accomplished this in different ways. Some makes of apparatus are so arranged that a variable number of windings of the primary may be used, others depend upon a choke-coil in which inductance reduces the current strength with practically no change in the voltage. Another arrangement, which has proven very satisfactory in operation, is the invention of Dr. Harry Waite of New York. It is essentially a revolving disc fixed upon the same shaft as the motor and the rectifying switches. A metal plate forms a quarter of the circle of this disc which is mounted so that three carbon brushes connected in the primary circuit press against it. The leads from these three brushes pass through a rocking switch and the connections are so made that when the switch is open only fifteen of the sixty cycles of the alternating current are transmitted; when the switch is closed on one side thirty cycles of the current will pass, while if it is closed on the other side the current

is short-circuited through the switch and the full sixty cycles are transmitted to the tube. Excellent fluoroscopic work may be done with both the fifteen- and thirty-cycle current with very little wear on the tube.

The best field for röntgenoscopy is the chest, in which the contrast between the different parts is great enough to render the shadows very distinct. The presence of cardiac hypertrophy or aneurism of the aorta is readily made out. Limitations in the excursion of the diaphragm may be seen and the extent of pleuritic effusion determined. Gross lesions of the lungs are rendered visible, but for the finer lesions röntgenoscopy is much less valuable than röntgenography.

Röntgenoscopy has also been found of considerable help in studying the movements of the stomach filled with a bismuth meal, and of the colon while giving a bismuth enema.

The operator should never lose sight of the danger of exposing himself to the Röntgen ray, and should do röntgenoscopy only under the most favorable conditions. The room should be completely darkened and the operator should remain in the dark at least three minutes before the ray is turned on. It is only by observing these two points that satisfactory röntgenoscopic work can be done. The smallest current that will give distinct shadows should be employed and the

opening in the diaphragm should be reduced to the smallest size practicable for the work in hand. For the safety of the patient it is important that the examination be made in as short a time as possible.

With the proper apparatus, and observance of the necessary precautions, there is no doubt that röntgenoscopy will increase in value.

#### STEREOSCOPIC RÖNTGENOGRAPHY.

Röntgenograms are necessarily perfectly flat pictures—that is, they give no perspective. It is often of the greatest advantage to be able to tell which parts in the picture project towards, and which parts away from, the observer. For this purpose stereoscopic röntgenograms are made. This is done by taking two pictures of the part, the plate for the second one being placed in exactly the same position as the first, the tube having been displaced laterally a short distance. Both pictures must be taken without any movement on the part of the patient. This procedure gives two pictures of the part, taken from slightly different view-points, which may be placed side by side and fused into one image by some form of reflecting or refracting stereoscope. The observer thus gets a sense of perspective, or depth, in the picture and sees all the parts in their proper relations.

The technic of making stereoscopic röntgenograms is not difficult. It is necessary only to have some form of plate-changing device so that the second plate may be substituted for the first without any movement of the patient, and such construction of the tube-holder as will provide for readily shifting the position of the tube. Most tables and tube-holders are now constructed to meet all the requirements of stereoscopic work.

The procedure in making stereoscopic röntgenograms is as follows: The part to be röntgenographed is placed firmly upon the plate-holder so that no movement will take place. A plate is placed in the plate-holder and the first exposure made. The plate is then removed and another placed in the holder in exactly the same position as the first one. The tube is then shifted to the right or left of its first position for a distance of about three inches, corresponding to the distance between the pupils of the eyes, and a second exposure made. When developed these two plates are placed side by side, and viewed with a stereoscope. Positives can then be made on one small plate and the pictures viewed conveniently through the common hand stereoscope, but this is not usually done.

Stereoscopic röntgenograms are invaluable in fractures and dislocations, the relation to each other of the fragments or displaced articular surfaces being

shown accurately. The position of foreign bodies in relation to surrounding parts can be seen very clearly. The value of röntgenography in the diagnosis of intrathoracic disease has been increased greatly by stereoscopic work. Stereoscopic röntgenography has also been found of definite value in the study of the bismuth-filled colon. Study of the nasal accessory sinuses is also rendered much more intelligent if stereoscopic röntgenograms are taken.

No röntgenographer who has once recognized the immense improvement of stereoröntgenograms over the simple flat picture, especially in fractures, dislocations, and intrathoracic lesions, and in the study of the colon, will ever be content to rest a diagnosis upon the evidence furnished by the simple röntgenogram.

#### THE LOCALIZATION OF FOREIGN BODIES.

The image of foreign bodies in the tissues may be seen on the fluorescent screen, and also in simple röntgenograms, but it is often difficult to estimate their distance from the surface.

Many different methods have been used for the accurate localization of foreign bodies.

The stereoscopic method has already been mentioned and is of undoubted value unless it is necessary to make an absolutely accurate localization.

The Mackenzie-Davidson method, based upon triangulation, is probably the one most commonly employed and has been found perfectly satisfactory by the author. Briefly, it consists of making two exposures upon the same plate without any movement of the patient or the plate, the tube being shifted laterally a known distance for the second exposure. To carry out this method the plate is placed on the table beneath two crossed wires. One of these wires must be parallel to the horizontal bar carrying the tube, so that when the tube is displaced the focus point on the target will always be perpendicularly above a point in the wire. The focus point of the target is accurately centred perpendicularly above the point of intersection of the cross-wires. The tube is now displaced a known distance, two inches, for instance, from the centre. The part to be röntgenographed is placed firmly upon the table. It is necessary to have the position of the cross-wires marked upon the patient's body, and this may readily be done by inking the wires, or when the patient arises by rendering the red marks left by the wires more permanent by the marks of an indelible pencil. It is also well to place a small lead marker on one corner of the plate and to mark its position on the patient's body. The first exposure is now made, and without movement on the part of the patient, or movement of the plate, the tube is shifted two inches to the other

side of the centre and the second exposure made. The plate is then developed and shows the images of the cross wires dividing the plate into quadrants, two images of the foreign body, and the image of the lead marker which enables one to select the corresponding quadrants on plate and patient. The plate is placed on a table beneath a horizontal bar from which two threads are hanging. The bar is the same distance above the plate as the focus point on the target of the tube was in taking the pictures. The threads are fixed on the bar two inches each side of a point which is perpendicularly above the point of intersection of the image of the cross-wires on the plate, thus representing the target of the tube in its two different positions. Not only must the intersecting point on the plate be perpendicularly beneath the selected middle point on the bar but one of the cross-wires must be parallel to the bar.

The end of one of the threads is now placed upon a point in one image of the foreign body, and the end of the other thread upon the corresponding point in the other image. The point where the threads cross obviously represents the position of the foreign body in relation to the plate. A perpendicular can be dropped from this point to the plate and a mark made on the plate. If the foreign body is large, like a bullet for instance, each end of it can be localized in this manner.



The distance of the mark on the plate from the two cross-wires can now be measured.

The perpendicular distance of the point of intersection of the threads from the plate represents the distance of the foreign body beneath the skin which rests upon the plate. The marks of the wires being left upon the patient's skin it is only necessary to measure the distances found above from each wire. The point of intersection of lines representing these two measurements gives the point on the patient's body below which will be found the foreign body, at the exact distance ascertained above.

This method is rapid and accurate and it requires no complicated mathematical calculations in its application.

There are some objections to any method of localization of foreign bodies depending upon the use of plates. One of these is the liability of the body to be moved by muscular action so that at operation it is at some distance from the point where it was situated when localized. Then again the relation of the marks made upon the skin to the deeper tissues may not be the same at operation as at the time of localization because of a different position of the part containing the foreign body. Another disadvantage is the fact that, although the foreign body may be localized very accurately and may remain at exactly that point, the

surgeon may be unable to find it without extensive dissection. He may cut down to the point where the localization has shown it to be, and still be separated from it by a very thin fascia which prevents his finding it and necessitates search in different fascial planes. Theoretically a method depending upon röntgenograms enables one to localize a foreign body with absolute accuracy, but practically many cases have occurred in which the surgeon either cannot find the body at all or finds it only after prolonged search.

During the present European war a great number of methods for localizing have been devised. The consensus of opinion now greatly favors some method of röntgenoscopic localization either immediately preceding or at the time of operation for removal.

An adaptation of the *ring localizer* is described by Dr. Hernaman-Johnson. The patient lies upon a table with the tube underneath the part containing the foreign body. The general position of the foreign body is ascertained by examination on the screen with a wide-open diaphragm. The diaphragm is then gradually reduced to about one inch in diameter, keeping the shadow of the foreign body in the centre of the illuminated area. The image on the screen is then vertically above the body itself. A metal ring about three-fourths inch in diameter, fixed to the end of a wooden handle about one foot in length, is slipped under the

screen and placed so that its shadow encircles that of the foreign body. The screen is removed without displacing the ring and a mark made with silver nitrate in the centre of the ring. The same procedure is repeated, but with the ring between the patient and the table, and a second mark made, this time on the lower aspect of the limb. The part is now turned at right angles and the above procedure repeated so that there are four localizing marks. The point of intersection of lines connecting the opposite skin points can be estimated with fair accuracy.

This method is, of course, applicable only to parts which can be examined in two different directions.

Another method which has been widely used is that of Sutton. This utilizes small cannulas of different lengths, according to the thickness of the part. With each cannula there is a sharp-pointed trocar and a blunt obturator. Piano wire of suitable size is furnished cut in lengths corresponding to the cannula with which it is to be used. These wires are bent at an acute angle to form a hook at one end. The method of localization consists in roughly locating the position of the foreign body by observation on the screen. The skin is anæsthetized at a suitable point by injection of novocaine and under proper antiseptic precautions the cannula with sharp-pointed trocar is passed through the skin and the trocar replaced by the obturator. The

area is then covered with a sterile towel and the cannula with obturator under fluoroscopic control passed toward the foreign body until it touches the latter. The obturator is then removed and a wire passed through the cannula and hooked into the tissues in immediate contact with the foreign body. The cannula is then removed and the wire left in place to guide the operator to the location of the foreign body.

The Sutton method is an excellent one for the extremities. Obviously, it is not applicable in the neck, chest, or abdominal cavity, where there are many structures liable to be injured by the passage of the obturator.

Dr. Joseph Marshall Flint<sup>1</sup> has described a method which utilizes a ring localizer, but in addition to it an instrument which he calls a profundometer. His method has the great advantage of being applicable to any region of the body. The profundometer is simply a band of malleable metal, such as block tin, with a hinge in its middle. They are made in different lengths so as to be used conveniently to encircle the chest, abdomen, leg, arm, or smaller part.

The localization is carried out by using the ring localizer in the manner previously described, but in order to insure accuracy four, instead of two, observations are usually made and sometimes six or eight.

---

<sup>1</sup> *Annals of Surgery*, August, 1916.

Marks are made upon the skin with small wooden stamps, the stamps being different from each other so that opposing marks may later be identified.

After the skin marks are made the profundometer is placed around the body or part at the level of the marks. It is very carefully molded to the contour of the body and a mark made to show the amount of overlapping of the ends. The marks on the skin are transferred to the profundometer and the latter carefully opened at the hinge and removed. It is now laid on a piece of paper and a tracing made, the position of the skin marks being transferred to the tracing. The profundometer is now removed and diagonals drawn between the corresponding skin markings, their point of intersection representing the position of the foreign body. By using a cross-section atlas the contour sketch may be filled in with a sketch of the structures and a very accurate representation obtained of the position of the foreign body with relation to anatomical structures.

At the operation for removal of the foreign body Dr. Flint often uses a Sutton localizer as a guide. In neck, chest, or abdominal cases where use of the Sutton localizer would be dangerous, he uses a small tripod made of the same material as the profundometer with a socket at its centre through which a pointer can be passed and secured at any point by a set screw. The

tripod is molded to the skin contour on the chart at the point selected for incision and then placed upon the corresponding point on the patient, and the position of the three ends of the tripod marked on the patient's skin. Then placing it again upon the chart the pointer is inserted until it touches the image of the foreign body and is secured in that position. This instrument can be inserted in the wound at time of operation and will furnish a good guide to the position of the foreign body.

This method of localization seems somewhat complicated, but in practice it has been found very simple and easy of application. It is undoubtedly one of the most accurate methods described and depends upon the use of very simple and inexpensive apparatus.

*Direct röntgenoscopic control* at the time of operation is favored by many operators. A preliminary examination should be made and a mark made upon the skin immediately above the foreign body. By rotating the part behind the screen it is also possible to find what point on the skin the foreign body is nearest to. This having been done, the surgeon makes incision at the most suitable point and then gradually works toward the foreign body under the guidance of the röntgenologist who is observing the shadow on the screen. Convenient types of röntgenoscopes to fit upon the forehead have been devised so that the sur-

geon may himself use the röntgenoscope. The screen is so mounted that it may be slid out of the way or turned back on hinges to enable the operator to view the field directly after making the röntgenoscopic examination. By using a probe mounted on a handle at right angles to it and gradually pressing it toward the foreign body until the shadow of the latter on the screen is seen to move, the foreign body may be located accurately. The probe should be so directed and the tube so placed that the shadow of the point of the probe is at all times hidden by that of the shaft. It is then certain that the probe is being moved straight towards the object. When the foreign body is seen to move the probe is kept in position until the surgeon dissects down and grasps the body.

A great number of instruments and devices have been used to assist in the localization and removal of foreign bodies under röntgenoscopic control, but they cannot be described here. In general it may be stated that the apparatus should be as simple as possible, and whatever method is used, its details should be worked out with the utmost care. Great care must be exercised to avoid the dangers to patient and operator attendant upon exposure to the ray. The smallest current with which penetration can be obtained should be used and the time of exposure made as short as possible. When the examination is made while the surgeon is operating

the ray should be turned on only when needed. The opening in the diaphragm should be as small as possible and there should be a good thickness of lead glass over the screen. The surgeon's hands will be out of the field if he uses a probe with a long handle at right angles, but the röntgenologist should wear gloves.

For the localization of foreign bodies in the eye it is necessary to have some special form of apparatus. The localizer devised by Dr. Sweet, of Philadelphia, is the one used by the author, and has been found perfectly satisfactory. Detailed description of the method of using this apparatus can be obtained from the manufacturer and will not be included here.



## CHAPTER VIII.

### DISEASES AND INJURIES OF BONES AND JOINTS.

THERE seems to be little necessity for insisting upon the importance of Röntgen examination of bone and joint lesions, for this is the field in which röntgenography has proven of the greatest value.

It should be an invariable rule to secure röntgenograms, not only in cases of undoubted fracture or dislocation, but in every case of injury to the bones. This is especially important when the injury is near a joint. The necessity for this is demonstrated by the great number of cases in which no clinical diagnosis could be made other than contusion or sprain, and in which the röntgenogram revealed a fracture or dislocation. Röntgenograms are especially valuable in bone and joint injuries to establish the presence or absence of a complicating lesion, such, for instance, as a fracture of the greater tuberosity or head of the humerus in shoulder-joint dislocations, or dislocations of the carpal or tarsal bones in injuries about the wrist or ankle.

In examining bones either for injuries or diseases it is always well, where practicable, to make röntgenograms from two different angles. The target of the tube should be centred directly over the lesion to

avoid the distortion which occurs if the picture is taken obliquely and which may give an entirely erroneous impression of the amount of overriding or separation of the fragments in fractures.

Stereoröntgenograms are invaluable in determining the correct relation of the fragments in fractures and of the articular surfaces in dislocations.

No special instructions need be given for röntgenographing the different joints of the body, but a few practical points may be mentioned.

The *spinal column* in the dorsal and lumbar regions should be röntgenographed in both the antero-posterior and lateral directions. The lateral view is of especial value in cases of fracture of the bodies of the vertebræ. The dorsal spine can be shown very well with the patient turned obliquely so that the ray enters about two inches outside of the right nipple. This prevents superimposing the shadows of the heart and great vessels upon that of the spine. When taking the lumbar spine and sacro-iliac region it is best to have the knees drawn up so that the lumbar region is flat against the table. Immobilization is very important in pictures of the spine, as indeed it is in all bone pictures. The use of a large rubber bag on the patient's abdomen against which the cone on the tube holder is pressed very snugly has been found of great value in röntgenographing the lower spine and sacro-iliac regions. This

bag may also be used to advantage for bone and joint pictures. A liberal use of sandbags also aids in immobilization.

The *shoulder* should be röntgenographed with the target centred over the glenoid cavity, the patient being in the supine position. Stereoscopic röntgenograms should always be made in cases of fracture or dislocation of the shoulder.

The *elbow*, *wrist*, *knee*, and *ankle* should be röntgenographed both anteroposteriorly and laterally. The side with the lesion should be placed nearest to the plate.

Röntgenograms of the *hip* are made with the target directly over the centre of the acetabulum, the patient usually lying upon the back. In interpreting röntgenograms of the hip it is important to remember that the arch formed by the under surface of the neck of the femur and the upper border of the obturator foramen normally make an unbroken curve. Good röntgenograms of the hip should show the posterior border of the acetabulum through the head of the femur.

#### DISEASES OF THE BONES AND JOINTS.

PERIOSTITIS and OSTITIS, whether of traumatic or infectious origin, are usually associated. Early in the disease when there is only periosteal involvement the only thing to be seen in the röntgenogram is a bulging

in the contour of the bone at the site of the lesion. Later a distinct shadow is produced by the exudate thrown out, and later still the dense shadows due to sclerotic changes are seen.

OSTEOMYELITIS shows the exudative and sclerotic changes of periostitis and ostitis, but in addition, changes due to bone destruction are evident. Well-marked abscesses and cavities due to necrosis are present. In older cases sequestra are seen. The course of sinuses through the bone and soft tissues may be marked out by injecting bismuth paste. To show the exact course and relations of the sinus stereoröntgenograms should be made.

TUBERCULOSIS.—The distinguishing characteristic of tuberculosis of bone is the absence of lime salts, causing the shadow of the bone to appear faint and indistinct. It usually attacks the epiphyses and seldom involves the periosteum, the contrary being the case with syphilis.

SYPHILIS.—Bone destruction due to syphilis presents an irregular moth-eaten appearance quite characteristic of this disease. The periosteum is nearly always involved and sclerotic changes which produce dense shadows in the röntgenogram are always present.

Syphilis is distinguished from tuberculosis by these dense black shadows which are in distinct contrast to the faint shadows of the latter disease.

Osteomyelitis of non-syphilitic origin does not show such extensive periosteal involvement nor does it present the irregular moth-eaten appearance of syphilitic bone disease.

The shadow of osteosarcoma is considerably less dense than that of gumma. The most important distinguishing point between these two is that gumma remains confined to the bone and periosteum while sarcoma invades the soft tissues.

**ARTHRITIS DEFORMANS.**—The theory of the causation of arthritis deformans, which seems to be gaining rapidly in acceptance, is that the disease is of infectious origin, and that it is usually due to infection from some pre-existing focus in the body. According to this theory the disease may be due to the streptococcus, staphylococcus, gonococcus, or to any other organisms which may invade the joint, the pathological changes differing little with the various organisms.

This theory has now a large amount of clinical, and some experimental, evidence to support it.

The röntgenographic appearances vary greatly from almost no change whatever to extensive hypertrophic alterations. In the first class of cases there may be considerable swelling about the joint and the disease may run a chronic course, but the röntgenogram shows no change in the bones except a slightly decreased density.

Other cases have the characteristics of a productive osteitis. There is increased density in the ends of the bones, some exudate may be present, and there may be "lipping" about the joint. Any degree of these changes may be present up to the condition in which there is extensive bone formation about the joint, with great limitation of motion.

SPONDYLITIS DEFORMANS, unless arrested, passes through all of the above stages, from that in which there is only slight irregularity along the articular margins to that of complete welding of the vertebræ by bridges of solid bone.

BONE TUMORS.—Tumors of bone, like those of soft parts, may be classified as benign or malignant, and may be of connective-tissue or of epithelial origin. Malignant tumors are much more common in bone than benign ones, and since epithelial cells are not normally found in bone, epithelial tumors are more rare than those of connective-tissue origin.

An osteoma is a tumor composed entirely of bone. Endostoma is a rare tumor arising in the centre of bone. Exostoses of fibrous origin usually occur in the auditory canal, jaws, or skull. They arise from periosteum and are rare.

Cartilaginous exostoses arise from preëxisting islands of cartilage and are important because of their frequency. When single they arise from the epiphy-

seal cartilage by a lateral growth, or from the diaphysis near to the epiphyseal line. The upper end of the tibia is the most common site.

Multiple cartilaginous exostoses is a disease characterized by the presence of multiple exostoses with marked deformity of the skeleton. It often occurs in several different members of the same family or in several generations. Its diagnosis depends upon the presence of multiple hard tumors near to the epiphyses, with more or less deformity. The röntgenogram gives a typical appearance and serves to exclude chondroma.

Chondroma is a tumor composed of cartilage and may be single or multiple. The single chondroma growing laterally from the epiphysis has a typical Röntgen appearance. Multiple enchondroma is also easy to identify because of the recurrence of the tumors in the long bones of the hands and feet, and their typical Röntgen picture. Single chondroma developing centrally in bone is very difficult to distinguish from bone cysts and from giant-cell sarcoma.

Sarcoma is the most frequent and most important tumor originating in bones. The jaws and long bones of the extremities are the most frequent sites. They are of two main classes, periosteal and medullary. The early diagnosis of periosteal sarcoma offers great difficulty. Early Röntgen examination may show only a slight roughening or dissecting up of the periosteum.

In the osteoid form there is later a trabeculation or spiculation at right angles to the shaft of the bone, giving the röntgenogram a somewhat cloudy or smoky appearance. In pure spindle- or round-cell sarcoma there may be practically no new bone formation and the cortex is rarefied or entirely destroyed.

Medullary sarcomata of bone of the round- or spindle-cell type are usually located near the epiphysis, but the round-cell variety is not infrequently found in the shaft. Pain usually precedes the appearance of tumor in medullary sarcoma, while the opposite sequence occurs in the periosteal type. The pain is referred to the neighboring joint in many cases and may lead to a diagnosis of arthritis. It is not increased by motion, however, nor relieved by rest or fixation. The Röntgen appearance of central round- and spindle-cell sarcomata in the early stages is not characteristic. Practically the same picture is given by cyst or chondroma. A diagnosis may be arrived at only by frequent examinations to show the rapid destructive effect with breaking down of the cortex.

The question as to what giant-cell tumors shall be called is not yet settled. Giant cells may be found in any form of sarcoma, but the tumor to which the name is commonly applied is the myelogenous giant-cell tumor seen almost exclusively in the extremities of long bones or in the jaws. The only conditions



with which the giant-cell sarcoma is likely to be confused are benign cyst and chondroma. (The Röntgen appearance is practically identical in all three.) This is not a very serious matter, however, since giant-cell sarcoma is now known to be only slightly malignant and is treated conservatively.

The condition most closely resembling sarcoma of bone is tuberculosis of bone, and it is sometimes impossible to distinguish between them. This is particularly so in sarcoma of the spine or near to one of the large joints. The most important point in the differential diagnosis is the failure of immobilization and extension to relieve the pain of sarcoma. If suspicion is aroused by failure of fixation to relieve pain, röntgenograms taken at frequent intervals will show the rapid destruction due to sarcoma and establish the diagnosis. These same statements apply to those rare cases of sarcoma originating in the synovial membranes of joints, of which only seventeen have been reported.

Charcot's joint may also be mistaken for sarcoma, but careful attention to the history, the fact that Charcot's joint is painless, and careful study of the Röntgen appearance usually serve to differentiate them.

Myositis ossificans may also be mistaken for sarcoma, but the Röntgen appearance of the former is typical.

**BONE CYSTS.**—These may be primary or secondary. Of the primary cysts, odontoma is the only one of importance. It arises from some part of a malformed tooth germ. The follicular odontoma is the tumor usually called dentigerous cyst. The röntgenogram serves to distinguish cysts of the jaws from exostosis and chondroma, but sarcoma must always be ruled out.

The majority of bone cysts are now believed to be some phase of the disease known as osteitis fibrosa. Of the eighty-nine cases collected by Bloodgood, sixty-nine were of this type. As stated under sarcoma, it is often impossible to differentiate benign cysts from chondroma and sarcoma. At operation, however, the gross appearance is stated by Bloodgood to be very typical. In sarcoma the tumor is a red friable mass of hemorrhagic granulation tissue in appearance, while in benign cyst there is a cavity filled with serous or bloody fluid and having a connective-tissue wall. This wall may be very thin or so thick as to fill the entire cavity.

Multiple myeloma is a primary multiple neoplasm of bone affecting chiefly the sternum, ribs, vertebræ and skull. The diagnosis depends upon the presence of multiple tumors demonstrated by the Röntgen ray and upon the presence of albumose in the urine.

Endothelioma is a rare malignant tumor of bone which it is clinically impossible to differentiate from sarcoma.

Carcinoma, or epithelioma, as a secondary disease, is not uncommon in the bones. Bone may become involved either by metastasis or by direct extension. Metastases occur in women most frequently from the breast and in men from the prostate, but carcinoma anywhere in the body may produce secondary involvement.

The Röntgen appearance of bone carcinoma is fairly characteristic. There is always bone destruction and usually replacement of bone, giving the area a ragged, moth-eaten appearance. Osteoporosis, osteosclerosis, and exostoses may be seen in the same bone.

The differential diagnosis of bone tumors may be summed up shortly as follows: Exostoses may be accurately diagnosed by their Röntgen appearance. Chondroma when growing laterally from the epiphysis gives a typical Röntgen picture, and multiple enchondromata are readily recognized. Single chondroma occurring centrally may be mistaken for benign cyst or giant-cell sarcoma, but the treatment is practically identical for all three. Periosteal sarcoma of the osteoid variety gives a typical Röntgen picture, the spiculation at right angles to the bone giving the cloudy or smoky appearance. The round- or spindle-cell periosteal sarcoma may be confused with tuberculosis, osteomyelitis, syphilis, or Charcot's joint, and the greatest care is necessary to differentiate them.

Multiple myeloma and endothelioma are rare. The former can usually be recognized, but the latter cannot be distinguished clinically from sarcoma. Benign cysts are likely to be confused only with chondroma or giant-cell sarcoma. Carcinoma of bone may be confused with tubercular disease, especially in the spine, but if care is taken in examining for areas of regeneration, and to discover the primary cancer, a mistake is usually avoided.

## CHAPTER IX.

### EXAMINATION OF THE HEAD.

**FRACTURES.**—Lateral röntgenograms of the head show fractures of the vault very well, but it is only rarely that fractures of the base can be shown.

Fractures of the lower jaw can be shown quite plainly if care is taken to have the head in the best position and the rays passing at the correct angle. Fig. 22 illustrates the method used by the author. The fractured side should be nearest to the plate. The wedge-shaped block of wood shown in this illustration is useful for most head pictures and should be a part of the equipment.

**NEW GROWTHS.**—Tumors of the bones of the skull or in the sinuses or orbit can usually be shown in a röntgenogram, but it is very seldom that much information can be gained concerning intracranial tumors. Tumor involving the pituitary body may cause absorption of the sella turcica and surrounding bony tissue and its presence diagnosed because of this.

**THE ACCESSORY SINUSES.**—Much valuable information may be gained by röntgenography of the nasal accessory sinuses. The correct relation of tube and patient is of the utmost importance in röntgenography of the sinuses.

**THE FRONTAL SINUSES.**—The position of patient and tube is shown in Fig. 22. The patient's head is placed on the wedge-shaped block with forehead and tip of nose touching the plate. The target is centred over a point about midway between the occipital protuberance and the vertex. If the ray passes at a lower plane shadows of the heavy bones at the base of the skull will blot out those of the sinuses, and if a higher point is selected the shadows of the sinuses will be greatly distorted. Thickening of the mucous membrane causes a blurring of the shadow on the affected side, and the presence of pus, tumor, or granulation tissue renders the sinus so opaque to the ray that a dense white shadow is thrown. In the presence of symptoms of inflammation of the accessory sinuses röntgenograms are of immense help in locating the sinus involved. The presence or absence of one or both frontal sinuses may be established by good röntgenograms.

**THE MAXILLARY ANTRA** may be röntgenographed with the tube in the same position as for the frontal sinuses, or with the ray directed at a point well below the base of the skull. Difference in the opacity of the shadows on the two sides is the point of importance in making a diagnosis.

The sphenoidal sinuses can be shown in röntgenograms, but it requires considerable skill in technic and

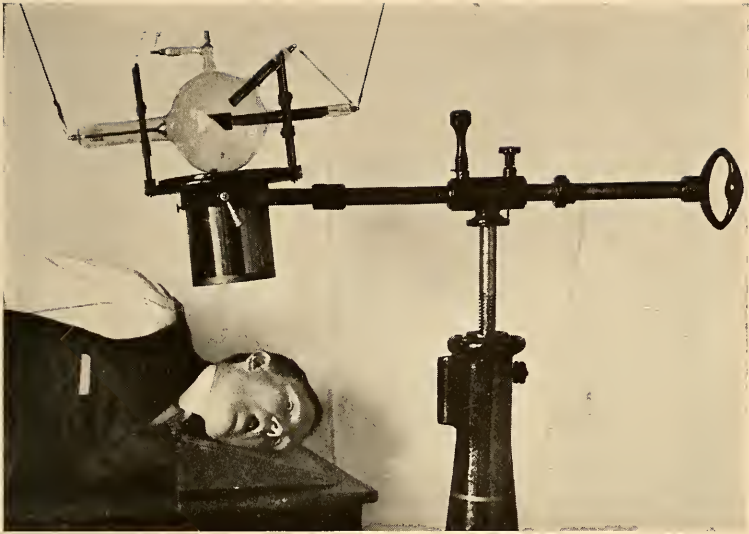

FIG. 22.—Position for lateral röntgenography of head.

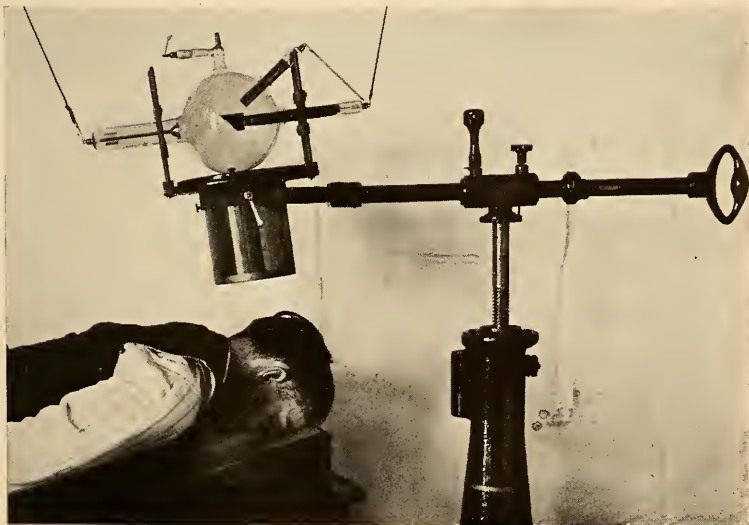

FIG. 23.—Röntgenography of frontal sinuses.

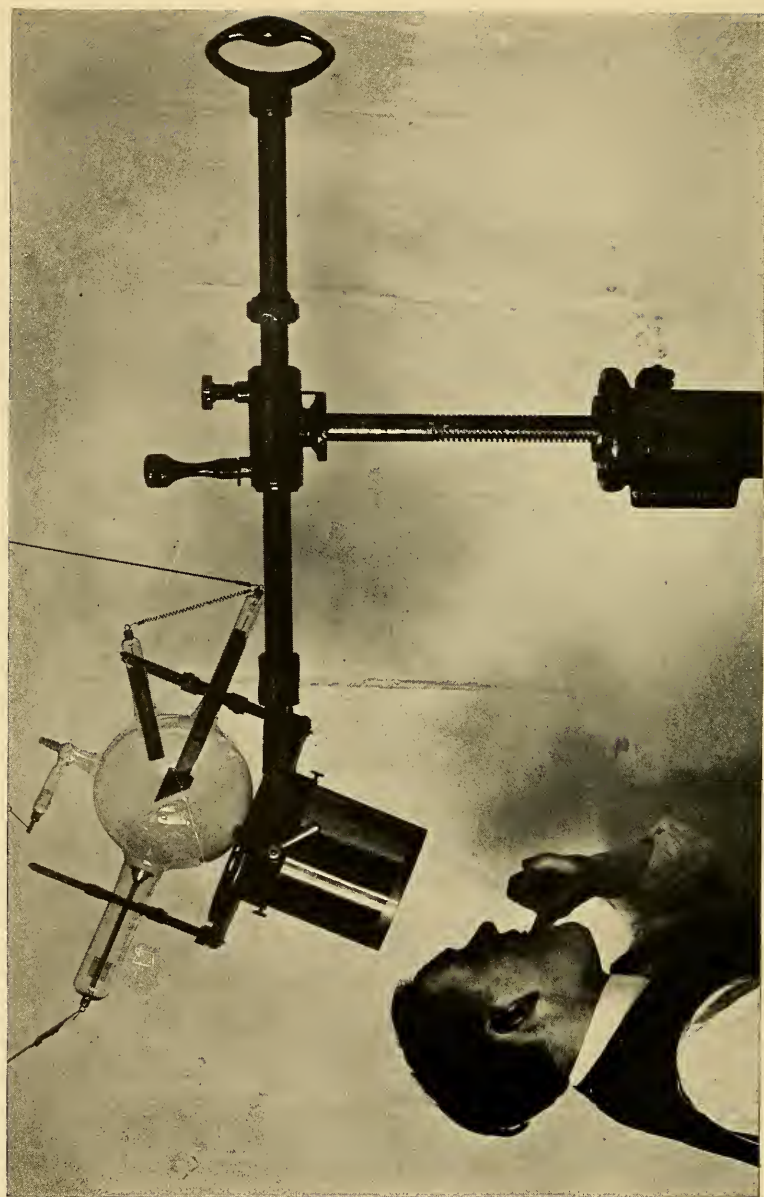

Fig. 24.—Intra-oral method of dental röntgenography.



experience in interpretation to be able to draw conclusions as to their condition. To study these sinuses Pfahler makes six röntgenograms, two postero-anterior, two lateral (stereoscopically), and two oblique.<sup>1</sup>

**DENTAL RÖNTGENOGRAPHY.**—There are two methods of making röntgenograms of the teeth, the intra-oral and the extra-oral method.

In the intra-oral method a small photographic film wrapped in black paper is placed inside the mouth, as nearly as possible against the teeth that are under investigation. In the extra-oral method the picture is taken upon an X-ray plate placed beneath the patient's head (Fig. 22).

In both methods the important point is to have the correct angle of incidence of the Röntgen rays upon the film or plate. This is especially true of the intra-oral method. It is readily seen that in röntgenographing the teeth of the upper jaw the film cannot be placed parallel to the teeth. Its position depends upon the slant of the roof of the mouth. If the picture is made with the direction of the rays at right angles to the teeth they will appear elongated and distorted, while if the angle is too small the shadow of the teeth will be foreshortened. Fig. 24 illustrates the proper position for the majority of cases for röntgenography of the front teeth of the upper jaw.

---

<sup>1</sup>The Amer. Quarterly of Röntgenology, November, 1912.

The intra-oral method is the best for all cases in which it is desired to secure detail about the teeth, but for fractures of either jaw, and in cases where it is necessary to show the relations over a wider area than can be covered by a film the extra-oral method is applicable. Fig. 22 illustrates the proper relation of the patient to the plate and tube in taking these pictures.

Good röntgenograms of the teeth and jaws give much valuable information in various abnormal conditions. Among these may be mentioned pyorrhœa alveolaris, localized alveolar abscess, the presence or absence and the position of unerupted teeth, the condition of root fillings and pivot teeth, and the presence of a foreign body such as a broken drill.

## CHAPTER X.

### THE THORAX.

RÖNTGENOSCOPY is of greater value in examination of the thorax than of any other part of the body because of the great contrast produced in the shadows by the air-filled lungs.

Some röntgenologists use röntgenoscopy alone for examination of the thoracic organs, while others rely almost entirely upon röntgenography.

It seems the best practice to make use of röntgenoscopy to determine the mobility of ribs and diaphragm, the presence of expansile pulsation in suspected aneurism, the presence of such gross lesions as pleural effusion or pneumothorax, and in a general way the aëration of different parts of the lung.

The fine details of lung structure, however, can be studied only in röntgenograms, so that it is necessary to make them both for purposes of diagnosis and in order to have a permanent record of the case.

The *technic* of röntgenography of the thorax is not difficult, but considerable care and experience are necessary to secure röntgenograms which give the greatest possible detail.

Stereoscopic röntgenograms are of immense value in diagnosing intrathoracic conditions, so much so that

the author no longer makes single röntgenograms of the chest. In the stereoröntgenogram every structure appears in its true relation to other structures, making it possible to avoid those mistakes in interpretation unavoidably caused by the superimposed shadows of the flat picture.

With the patient in either the erect or prone position the target of the tube is centred over the spinal column at the level of the spines of the scapulæ, the distance from the plate being at least thirty inches. The patient inhales deeply and the first exposure is made. While he holds his breath the tube is shifted three inches towards his feet, a second plate substituted for the first, and the second exposure made. The entire time for this complete operation ought not to be more than ten or twelve seconds, since some patients cannot hold the breath for a longer time.

For adults the plates should be 14 x 17 inches. Plates of such large size make the expense of stereoröntgenography a material consideration, but the added accuracy in diagnosis justifies the use of this method.

**SCREEN EXAMINATION.**—In studying the chest upon the fluorescent screen one of the first things to be observed is the movement of the diaphragm. Diminished excursion of the diaphragm is often found in diseases of the lungs and pleura (Williams' sign).

This sign if present is of marked value in directing attention to early pulmonary tuberculosis, but it is too often absent even in advanced cases to be of great value.

**THE HEART.**—The size of the heart may be made out roughly on the screen or plate, and quite accurately with the orthodiagraph. In a short work of this kind space cannot be given for description of the latter method. Separation of the tube to a distance of five feet or more from the plate lessens the exaggeration so that it is almost negligible and one can arrive at a fairly accurate judgment of the size of the heart without orthodiagraphy.

An important feature to note is the angle formed by the right ventricle with the diaphragm, the cardio-hepatic angle, which is obliterated in pericarditis with effusion but not in cardiac enlargements.

**THORACIC ANEURISM.**—The best position for screen examination is that with the ray passing from behind and the patient turned obliquely with the right anterior part of the chest pressing against the screen.

Care should be taken not to diagnose as aneurism the slight bulging of the aortic arch to the left which often occurs in normal subjects.

The diagnosis of thoracic aneurism is based upon the appearance of a large, smoothly rounded shadow in which expansile pulsation can often be detected.

Tumors of the posterior mediastinum are more likely to be irregular in outline rather than smooth like aneurism, and one may be able to distinguish the shadow of the normal aorta separate from the tumor.

**PNEUMOTHORAX.**—This condition is readily diagnosed either by screen examination or by röntgenography. The space filled by the air offers but little resistance to the passage of the ray, so that it appears very bright on the screen and perfectly black on röntgenograms. Another important point, and one which distinguishes pneumothorax from emphysema, is the absence of the lung markings over the area occupied by the air.

**PLEURISY.**—Acute pleurisy without effusion gives no röntgenologic evidence except limitation of movement of ribs and diaphragm. Pleurisy with effusion causes a dense shadow, which is first noted in the angle between the diaphragm and ribs. The fact that the density of the shadow is unaffected by respiration distinguishes it from pulmonary consolidations. If unencapsulated it may be distinguished from simple thickened pleura by its change in level upon change in position of the patient. Encapsulation is so common, however, that this is not a very valuable sign.

**PULMONARY TUBERCULOSIS.**—The present estimation of the value of Röntgen examination in pulmonary tuberculosis is well-stated in the following words:

“although in the great bulk of cases, it (the stereograph) tells us no more than a careful clinical examination, yet in a fair number of cases, and these among the most interesting and puzzling, it gives additional information. But we must add the caution that a careful history is indispensable, since not even the stereograph can tell an active from a healed lesion.”<sup>1</sup>

The first essential in studying pulmonary tuberculosis röntgenographically is experience in interpreting the shadows cast by the normal chest.

The dense shadow extending down through the middle of the röntgenogram is cast by the spinal column and sternum, the heart and large blood-vessels, the œsophagus, the trachea, lymphatics, and connective tissue.

On either side of the central shadow is an irregular shadow of less density, that of the hilus. This is cast by the primary branches of the pulmonary vessels with their contained blood, the walls of the primary bronchi, and lymphatic and fibrous tissue surrounding these structures.<sup>2</sup>

Radiating from the hilus are seen the shadows of the heavy trunks, three on the right and two on the

---

<sup>1</sup> Wolman, Bulletin of the Johns Hopkins Hospital, vol. xxii, No. 245, July, 1911.

<sup>2</sup> Dunham, *ibid.*

left. The "fine linear markings" are seen to be subdivisions of the heavier trunks, the shadows of which disappear in normal cases before the periphery is reached.

It has been definitely proven by Boardman and Dunham<sup>3</sup> that the "linear markings" in the röntgenogram of normal lungs are a composite shadow of the artery and vein and their contained blood, the bronchus, and the supporting connective tissue.

Dunham<sup>2</sup> gives the following as the changes to be found in early tuberculosis:

1. Increase in area and density of the hilus shadow.

2. Small areas of great density in the hilus due to caseous, fibrous, or calcified glands.

3. Increase in density and breadth of the heavy trunks extending towards the diseased area.

The above changes may be due to mediastinitis or other conditions and are not typical of tuberculosis.

4. In the diseased area the fine linear markings are "broader, denser, and less regular in outline, frequently studded, almost to obliteration of the lines."

The markings are broken in continuity and extend to the periphery.

Interweaving of the lines to form a delicate mesh is quite characteristic.

---

<sup>3</sup> Boardman and Dunham, *ibid.*



As the lesion progresses the linear markings become more irregular, the studdings increase in size and density, the interweaving is closer, and the entire diseased area throws a shadow of increased density.

Dunham describes three branches in the upper lobes which show more plainly in disease than in health and in which the changes described above usually make their first appearance. One of these, the vertebral branch, passes upward from the hilus parallel with the spine, another passes outward behind the first interspace, and the third behind the second interspace.

Besides these changes in the lung markings, certain other signs of pulmonary tuberculosis have been described. One of these is limitation in diaphragmatic movement on the affected side. When present this is a valuable sign. Other signs such as the so-called "hanging heart," calcification of the costal cartilages, and the presence of narrow intercostal spaces, are of very doubtful value.

It should be remembered that pleuritic effusion often accompanies pulmonary tuberculosis and that it may be diagnosed röntgenologically when it has given no clinical signs. There seems little doubt that Röntgen examination is a considerable aid in the diagnosis of early pulmonary tuberculosis, but here, as elsewhere, it must be used in conjunction with the history and all the other findings.

When the disease is advanced and can be diagnosed by clinical signs alone the Röntgen-ray is still of value in determining its extent, the presence of small cavities, etc. It is often the case that physical signs are present at only one apex when the röntgenogram shows a beginning lesion on the opposite side.

One of the principal difficulties is to distinguish an old healed process from an active lesion. A point of importance in this connection is the hazy, blurred appearance of the areas of active disease, in direct contrast with the clear-cut outlines of the healed lesions. It is often impossible, however, to decide between these from Röntgen examination alone.

ABSCESS OF THE LUNG has a somewhat typical Röntgen appearance. The area involved, being denser than the surrounding lung structure, is more opaque to the ray and, therefore, appears white on the plate. The abscess cavity itself may sometimes be distinguished if it is partly emptied and contains some air, but usually the appearance is that of a more or less oval area, densely opaque in the centre, gradually thinning out toward the periphery, and with irregular edges. It can usually be distinguished from tubercular disease by the localized character and by the clinical course.

BRONCHIECTASIS.—Röntgen examination is important in all cases of suspected bronchiectasis since clinically this disease is very difficult to differentiate

from abscess and tuberculosis. The Röntgen ray does not always suffice to differentiate these conditions but it assists greatly in doing so, and in addition gives valuable information about the position, extent, and operability of the lesion.

Moore in an unusually good presentation<sup>1</sup> of the value of the Röntgen ray in diagnosis of this condition classifies bronchiectasis as infiltrative, cylindrical, and sacculated. He states that these three forms probably represent different stages of the disease. The infiltrative stage is characterized in the röntgenogram simply by increased density along the trunks at the base of the lung, the Röntgen appearance not being at all characteristic.

The cylindrical stage shows a somewhat fan-shaped shadow extending outward from the root of the lung with small areas of decreased density scattered through the area of shadow. These areas are dilated bronchioles and their presence is pathognomonic of the disease. They may be demonstrated more certainly by having the patient discharge the secretion from them by forced coughing.

The sacculated stage shows distinct pseudocavitations surrounded by dense fibrous tissue.

Moore also states that the disease " may be differen-

---

Röntgen Diagnosis of Bronchiectasis. Alex. B. Moore. American Journal of Röntgenology, 1916, III, 524-531, and republished in collected papers of The Mayo Clinic, VIII, 1916.

tiated from chronic bronchitis by the greater increase in density along the bronchial trunks in bronchiectasis, the tendency to localize at the base of the lungs, the extension of this increased density to the periphery of the chest even as far as the costo-phrenic angle, and the presence of bronchiectatic pseudocavitation or sacculation. Bronchiectasis is usually differentiated without difficulty from abscess of the lungs by its location, and the fact that the walls of its cavity are relatively thin and small. The cavities are multiple and there is absence of a fluid level within them.”

## CHAPTER XI.

### EXAMINATION OF THE GASTRO-INTESTINAL TRACT.

THE gastro-intestinal tract may be studied both röntgenoscopically and röntgenographically by filling the lumen of the organ, with some substance opaque to the rays. The opaque substance now in general use is barium sulphate. This must be especially prepared for use in Röntgen diagnosis so that it is free from all soluble barium salts. Barium sulphate has the advantage of being much cheaper than bismuth subcarbonate which was formerly in general use.

The barium meal is prepared by mixing three ounces of barium sulphate with eight ounces of buttermilk, either natural, or artificial. Sweet milk does not hold the barium in suspension nearly so well as buttermilk. If the patient dislikes buttermilk some other vehicle such as apple-sauce, cream-of-wheat, or potato-flour pap may be used.

The preparation of the patient for the examination consists in administration of a laxative, preferably an ounce of castor-oil, on the evening preceding the examination. He comes to the Röntgen laboratory in the morning without breakfast. Not more than one thin layer of cotton clothing, entirely free from buttons or

pins should intervene between the patient and the plate, or the patient and the tube.

**THE ŒSOPHAGUS.**—Examination of the œsophagus is made both röntgenoscopically and röntgenographically. Röntgenoscopic examination is carried out by having the patient stand with his chest against the screen, the ray passing from behind. He is then rotated slightly so that the right breast is against the screen and the ray passing obliquely through the chest from left to right. He now places his right hand back of his head, holding the elbow well up, and holds the glass of barium mixture to his lips with his left hand. The ray is then turned on and the operator observes the shadow of the barium in its passage from the pharynx into the stomach as the patient slowly drinks it. Normally the barium passes down the œsophagus with a slight backward deflection behind the arch of the aorta, and with sometimes a very slight delay at the cardiac orifice. If a spasmodic stricture is suspected and none is demonstrated by the use of barium in a liquid vehicle it is advisable to mix some crusts of bread with the barium and buttermilk. The passage of this will sometimes reveal a spasmodic stricture which is not shown by the liquid meal.

*Cardiospasm* (Fig. 25) produces obstruction either at the point where the œsophagus passes through the diaphragm or at the cardiac orifice. The œsophagus



FIG. 25.—Cardiospasm.





above the point of obstruction may be greatly dilated. The appearance, röntgenoscopically or on plates, is that of a smooth conical shadow. This is the characteristic that distinguishes it from carcinoma and benign organic stricture. Care must be taken to exclude the presence of food particles in the sac since the latter may produce irregularity in the barium shadow.

Carcinoma of the œsophagus is characterized by the ragged, irregular appearance of the barium-filled lumen. The obstruction may vary from none at all to almost complete blocking of the lumen. It may be difficult or impossible to differentiate carcinoma from benign organic constriction.

Diverticula of the œsophagus usually occur near its upper end and appear in the röntgenogram as smooth rounded sacs either at one side or behind the œsophagus.

**THE STOMACH.**—When the röntgenoscopic examination of the œsophagus is completed the stomach is immediately examined röntgenoscopically. This shows the position and the tone of the stomach, and any gross departure from the normal contour. The mobility of the organ is determined by palpation while watching the image on the screen, and at the same time the character of the peristalsis is noted. The röntgenoscopic examination of both œsophagus and stomach is readily finished within a very few minutes.

The patient now lies upon a table in the prone position and a plate is placed beneath the abdomen. The tube is centred over the plate at a distance of twenty-four inches and the exposure made while the patient holds his breath. It is the custom of the author to examine this plate as it is coming up in the developing solution in order to be sure that the image of the stomach is well centred on the plate, and whether or not all parts of the stomach and duodenal cap are well filled with the barium mixture. If there is a defect in the fundus of the stomach due to pressure of the spine a pillow is placed under the patient's hips. If the duodenal cap has not filled, the patient is made to turn upon the right side and pressure made with the hand over the epigastrium in such a manner as to assist the filling of the cap. The patient now lies prone again and three or four pictures are taken at intervals of about one minute. The patient is then turned upon his right side and the same procedure followed as for the prone position. If the first picture taken in this position shows no defect in the contour of the cap no others are taken, but if there is deformity it is necessary to take several more in order to determine whether the deformity is constant or not. Usually one or two röntgenograms are then taken with the patient erect. Of course, the above procedure is often varied to suit different cases. In patients having much abdominal



FIG. 26.—“Types of normal stomach and duodenal cap.”



FIG. 27.—“Types of normal stomach and duodenal cap.”

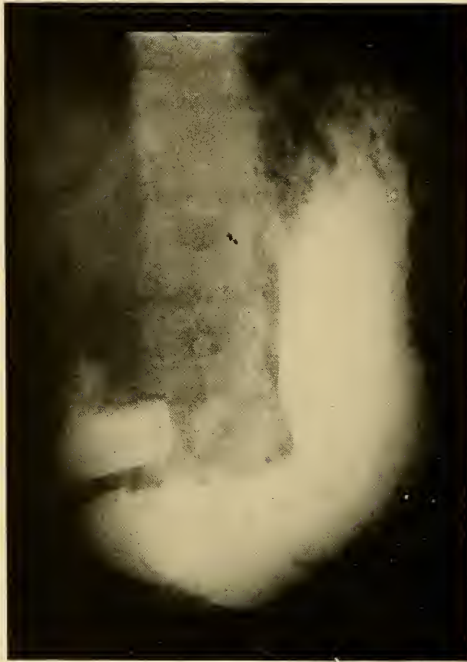

FIG. 28.—“Types of normal stomach and duodenal cap.”



FIG. 29.—Orthotonic stomach.



FIG. 30.—Hypertonic stomach.

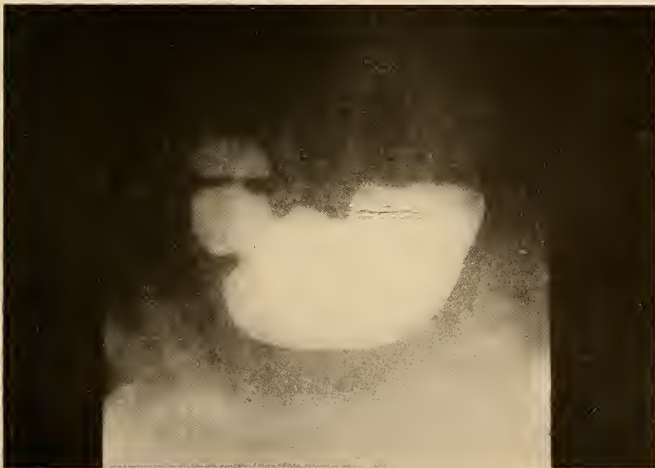

FIG. 31.—Atonic stomach.



FIG. 32.—Perforated gastric ulcer.

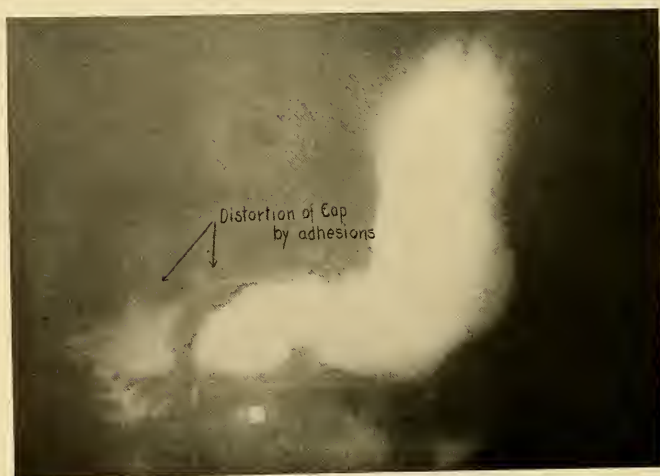

FIG. 33.—Distortion of duodenal cap by adhesions.

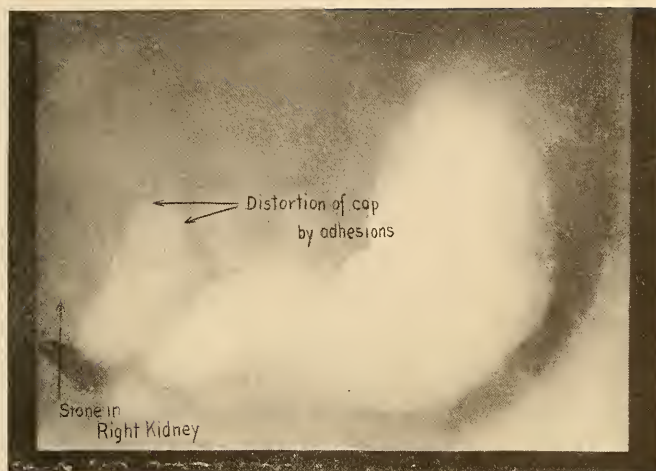

FIG. 34.—Distortion of duodenal cap by adhesions.



FIG. 35.—Incisura, producing hour-glass stomach, caused by ulcer of lesser curvature.

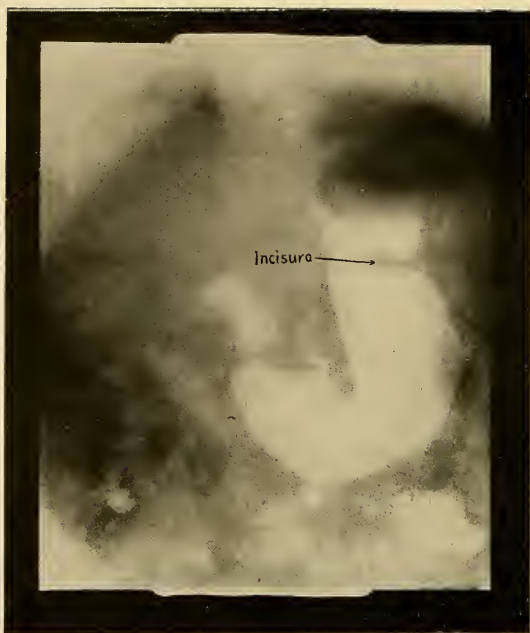

FIG. 36.—Incisura opposite ulcer of lesser curvature.



FIG. 37.—Incisura opposite penetrating ulcer of lesser curvature.



fat, or in those having a very hypertonic stomach most of the examination is made in the erect posture, since the duodenal cap does not show so well in these individuals when the examination is made with them in the prone position.

*The appearance of the normal stomach* varies greatly in different individuals and in the same individuals as a result of different postures, pressure, nervous influences, etc. The best classification is probably that based upon muscular tone. The orthotonic stomach grasps its contents and maintains its tubular shape with the patient erect (Fig. 29). The hypertonic variety (Fig. 30) is the so-called "steer-horn" stomach, lying high in the epigastrium and more or less horizontal. In the atonic stomach (Fig. 31) the meal gravitates to the most dependent portion, little or none remaining in the vertical part. In determining the emptying time of the stomach its tone must be taken into consideration. Six hours is considered a liberal limit for complete evacuation, but an atonic stomach may require at least eight hours.

The first part of the duodenum, known as the "cap" or duodenal bulb, is very important from a röntgenologic standpoint. Constant variations in its contour may furnish evidence of the presence of various abnormalities. Figures 26 to 31 show röntgenograms of the stomach and cap which may be considered normal.

**ULCER OF THE STOMACH.**—The Röntgen ray has become of great assistance in the detection of gastric ulcer, in many cases not only furnishing positive evidence of its presence but also giving information as to its position and extent. Two varieties of gastric ulcer may be positively diagnosed by Röntgen examination. These are the penetrating ulcer with deep crater, and the perforating ulcer with cavity formation outside of the stomach walls. A penetrating ulcer is shown in Fig. 37, and one which has perforated in Fig. 32. It is necessary to use the greatest care in order to visualize the “niche” of the penetrating, or the cavity of the perforating ulcer, since it may be located on the posterior wall and hence visible only in lateral röntgenograms.

There are other röntgenologic signs of value as corroborative evidence of the presence of ulcer, although not diagnostic in themselves. These are the incisura, the hour-glass stomach, and the six-hour residue.

The incisura (Figs. 35, 36 and 37) is an indentation of the wall of the stomach occurring opposite to an ulcer. It practically always occurs on the greater curvature opposite to an ulcer of the lesser curvature. Care must be taken not to confuse the incisura cardiaca occurring in the normal stomach under the left costal margin, or the incisura angularis occurring in the angle

of the lesser curvature, with true incisuræ. Typical looking incisuræ may be caused by reflex irritation, such as appendix or gall-bladder disease. To be of value as a diagnostic aid, the incisura must be constant in position and accompanied by other signs of ulcer. The cause of the incisura is thought to be the contraction of the circular muscular fibres of the stomach due to the irritation of the ulcer. The edges of a true incisura are smooth and the end is bluntly rounded. The occurrence of two ulcers together, however, may give it a ragged appearance.

The hour-glass stomach has about the same value in the diagnosis of ulcer as the incisura since it usually has the same cause—a spasmodic contraction due to irritation. This condition may, however, be organic, due to extensive adhesions or cicatricial contraction accompanying ulcer. The hour-glass stomach due to carcinoma differs from that of ulcer and will be described later.

*A marked residue* in the stomach at the end of six hours is considered a confirmatory sign of the presence of gastric ulcer. The increased acidity in the duodenum which interferes with the normal pyloric reflex is thought to be the cause of retention in cases of gastric ulcer in which there is no actual pyloric stenosis. There are, however, other causes of retention which must be taken into account, such as obstruction due to neo-

plasm, obstructive adhesions due to cholecystitis, and reflex spasm of the pylorus resulting from conditions elsewhere in the abdomen. It is obvious that the tone of the stomach must be taken into consideration in judging the significance of a six-hour residue. A residue having no significance at all in an atonic stomach may be of importance in one that is hypertonic. If interpreted in the light of other findings the six-hour residue is of value as a diagnostic sign. The presence of a well-marked incisura, for instance, accompanying a good sized six-hour residue is considered good evidence of the presence of ulcer.

CARCINOMA OF THE STOMACH (Figs. 38, 42) gives a very characteristic picture in advanced cases. Even in early ones it is usually possible to make a diagnosis of the presence of an organic lesion with probably beginning malignancy. The diagnosis is based upon the occurrence of defects in the barium shadow of the stomach appearing constantly on screen and plates. If the growth is a nodular one the defects in the shadow may be small circular areas—the so-called “fingerprint” defects (Fig. 38). The area involved may have a ragged, worm-eaten appearance due to the irregular nature of the growth or it may progress in the shape of a cone. The latter appearance is frequently seen in the antrum pylori, the constricted pylorus forming the apex of the cone. Carcinoma

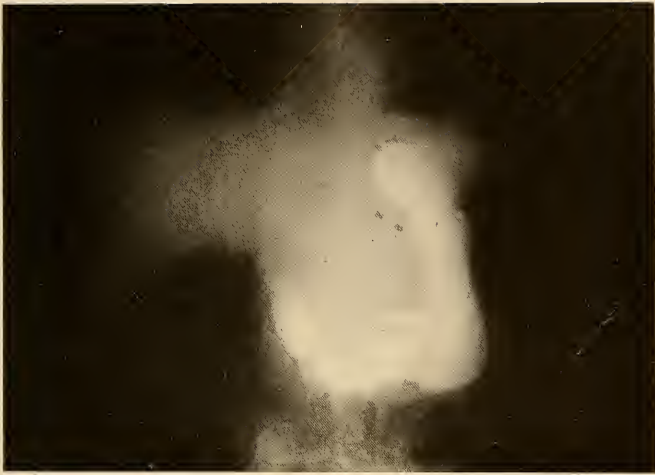

FIG. 38.—Carcinoma of stomach involving lesser curvature.

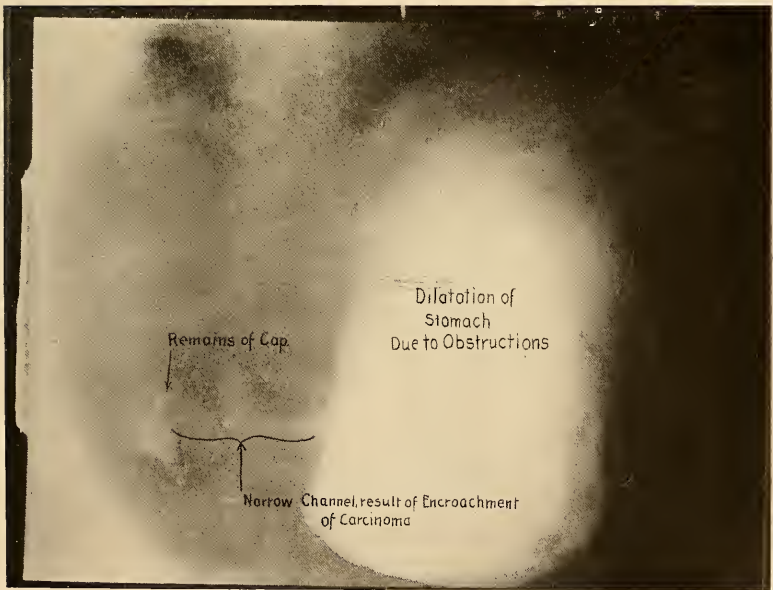

FIG. 39.—Large carcinoma of pyloric end of stomach.

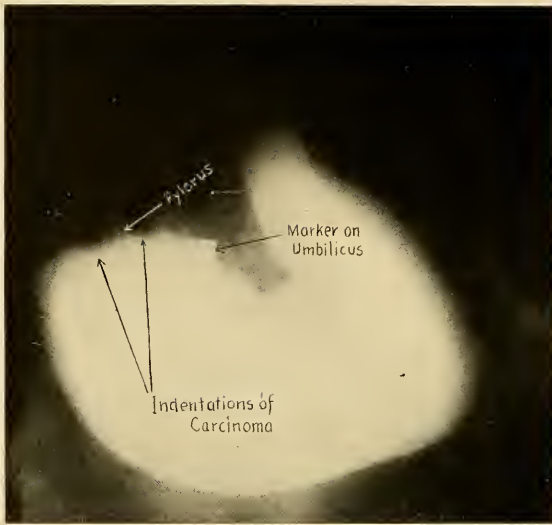

FIG. 40.—Annular carcinoma at pylorus.



FIG. 41.—Large carcinoma at pylorus.



Fig. 42.—Large infiltrating carcinoma of stomach.

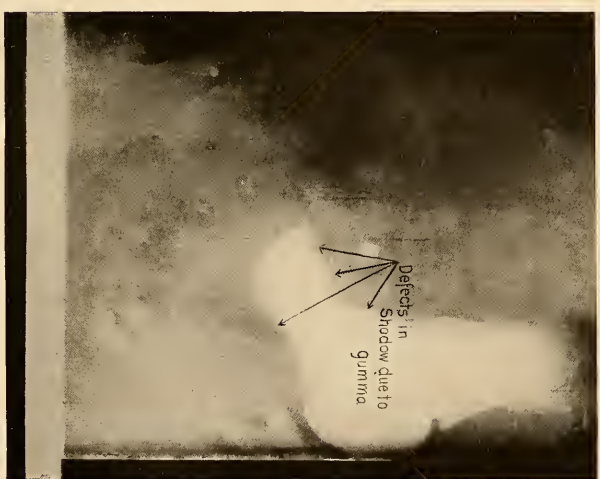

Fig. 43.—Gumma of stomach.





may, by a general infiltration, cause a fixation and stiffening of the walls of the entire stomach (Fig. 42). Rapid evacuation of the stomach is often present in early carcinoma just as in cases of achylia and may also occur in late carcinoma which infiltrates the pyloric region and interferes with the contraction of the pyloric sphincter. The deformities caused by extra-gastric tumors may be differentiated from gastric carcinoma by the fact that the former do not interfere with the normal progression of the peristaltic waves as observed on the fluorescent screen. Röntgenograms made in the erect, prone and lateral positions, and palpation while the stomach is observed on the screen also aid in ruling out tumors outside of the stomach. Syphilis of the stomach (Fig. 43) often causes deformities which cannot be distinguished by Röntgen examination from carcinoma. It should, therefore, be a rule to have a Wassermann made in all cases giving a Röntgen picture of carcinoma. Spasm sometimes simulates the deformities caused by carcinoma, but can usually be relieved by giving the patient tincture of belladonna until the physiological effects of dilatation of the pupils and dryness of the throat are observed.

Hour-glass deformity of the stomach when caused by carcinoma is irregular in outline and the lumen is usually central in position, while that caused by ulcer

is usually smooth in outline and the lumen near to the lesser curvature.

The *pyloric region* of the stomach and the duodenum are best studied by the "*direct method*," so well marked out by Cole, of New York, and George, of Boston. Information as to the mobility of this region can be obtained only by screen examination, but the author has found the direct visualization of defects and deformities of the pylorus and cap upon a number of plates the only satisfactory and certain method of diagnosis.

In the application of this method considerable experience in interpretation of röntgenograms is necessary and the technical part of the work must be well done. It must be demonstrated beyond doubt that the defect in the barium shadow is not due to spasm or to accidental effects of pressure or to mere lack of filling. This can be accomplished sometimes by making only a few plates, while at other times it is necessary to make many plates in the prone, lateral and erect postures. One can often determine by the röntgenoscopic examination in what position the duodenal cap will show best, and can also ascertain whether there is likely to be difficulty in filling the cap.

The exact cause of deformities cannot always be stated definitely. The presence of a surgical lesion at or near the outlet of the stomach is often the only state-

ment justified by the Röntgen findings. Sometimes it can be quite definitely stated that the lesion is an ulcer, or that the deformity is caused by adhesions arising from the gall-bladder (Figs. 34 and 35), the degree of exactness depending upon the nature of the deformity and the experience of the röntgenologist. Of course, the final diagnosis is made by correlating the Röntgen findings with all other information obtainable about the case. At the present time there is scarcely any region of the body where the Röntgen examination is more valuable than in the region of the pylorus and first part of the duodenum.

Pressure defects in the stomach may be produced by pancreatic or other extragastric tumors, and in the cap by an enlarged gall-bladder with or without gall-stones, or by an enlarged or anomalous lobe of the liver.

The GALL-BLADDER is frequently visualized on the plate. It is thought by some that a gall-bladder which is dense enough to cast a shadow on the Röntgen plate is always pathologic, but there is not sufficient evidence to establish this. An enlarged caudate lobe of the liver may closely simulate the shadow of the gall-bladder and produce a deformity of the duodenal cap, which cannot be distinguished from that produced by the gall-bladder itself. It is generally agreed now that from forty to fifty per cent. of all gall-stones may be shown on the Röntgen plate. Whether they will

show or not depends upon the percentage of lime salts contained in them. Gall-stones usually show as rings with a dark centre, but the shadows are sometimes of even density throughout.

The second and third portions of the duodenum, and the jejunum and ileum do not lend themselves so readily to Röntgen examination because of the rapidity with which the barium mixture passes through them. Sometimes a dilated diverticulum of Vater or other diverticulum is visualized. Obstruction at any point in the small intestine may be determined by delay in passage of the barium meal. The terminal ileum is usually well seen at the six-hour period when the presence of any unusual fixation, kinking, or obstruction, may be determined by palpation in front of the fluorescent screen.

The COLON is usually examined twenty-four hours after the administration of the barium meal, when the cæcum, transverse colon, sigmoid and rectum usually contain barium. Examination is first made in the röntgenoscope to determine the presence or absence of any unusual fixation of the cæcum or other parts of the colon. In a certain percentage of cases the appendix will be found filled with barium at this time and any unusual fixation or kinking may be determined by palpation. The V-shaped transverse colon is often found low down in the true pelvis, and to

decide whether or not it is fixed in that position it is sometimes necessary to place the patient in the Trendelenburg position while the röntgenoscopic examination is being made. A plate is made after the röntgenoscopic examination to serve as a record of the condition at the end of twenty-four hours. The patient then lies upon the table on his left side and a barium enema is administered. The enema consists of five ounces of barium sulphate in one and one-half litres of warm water, with the addition of about a teaspoonful of gum arabic to hold the barium in suspension. This is placed in a fountain syringe connected with a soft rectal tube. The latter is passed to the distance of about two inches and the enema allowed to flow in slowly with the receptacle about three feet above the table on which the patient is lying. When the entire amount has passed in the tube is withdrawn, the patient turns upon the abdomen, and the röntgenogram, or a stereoröntgenogram, is made immediately. Röntgenoscopic examination is then made.

The above routine is usually sufficient for a complete study of the colon, but in some cases further study must be made. To determine the presence and extent of obstruction it is sometimes necessary to make examination forty-eight and even seventy-two hours after ingestion of the barium meal. In some cases it is found necessary to rid the colon of the barium

present from the meal and to give the enema with the colon empty, watching the shadow on the röntgenoscope as the colon fills.

The colon varies greatly in different patients in size, position, and mobility.

Dilatation of the cæcum may be due to the presence of adhesions or pericolonc membranes about the cæcum, causing obstruction (Fig. 45), or simply to an atonic condition. A small contracted cæcum may be caused by adhesions following appendicitis or cæcal inflammation independent of the appendix, or by an investing membrane. The cæcum is often abnormally fixed by adhesions or congenital membranes (Figs. 45 and 46), the fixation tending to produce cæcal stasis. On the other hand it is sometimes abnormally movable (cæcum mobile). In the latter case it is also dilated and atonic. Other parts of the colon may also be fixed or reduplicated in such a manner as to offer obstruction to the passage of its contents (Fig. 46). Ptosis of the transverse colon is very common, especially in the tall, thin individual. In nearly all patients the transverse colon makes a considerable downward curve when the patient is erect, but in cases of marked ptosis both the hepatic and the splenic flexures may descend below the iliac crests and the transverse colon may be well down in the pelvis. The colon is a very movable viscus and it is often of

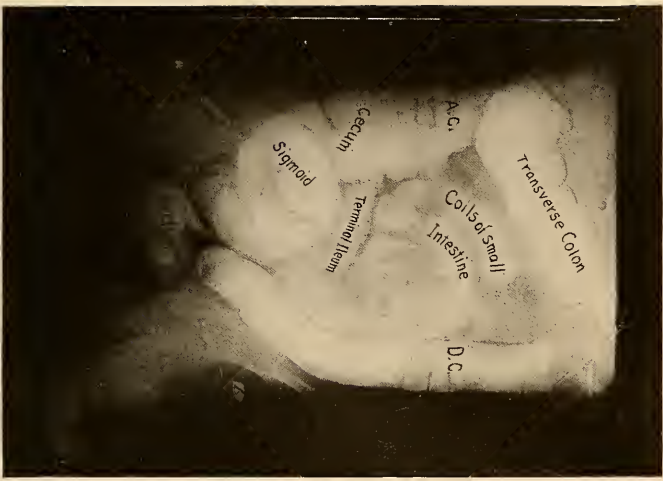

FIG. 44.—Röntgenogram illustrating filling of colon and ileum with barium enema.

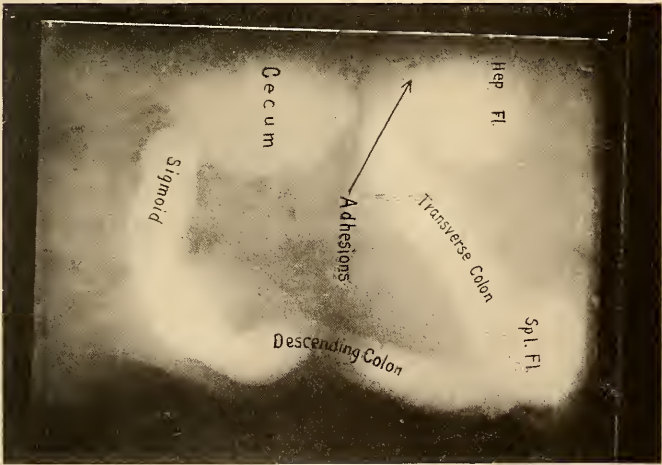

FIG. 45.—Jackson's membrane causing partial obstruction just distal to hepatic flexure.



FIG. 46.—Adhesions of proximal colon to whole extent of ascending colon and cæcum.

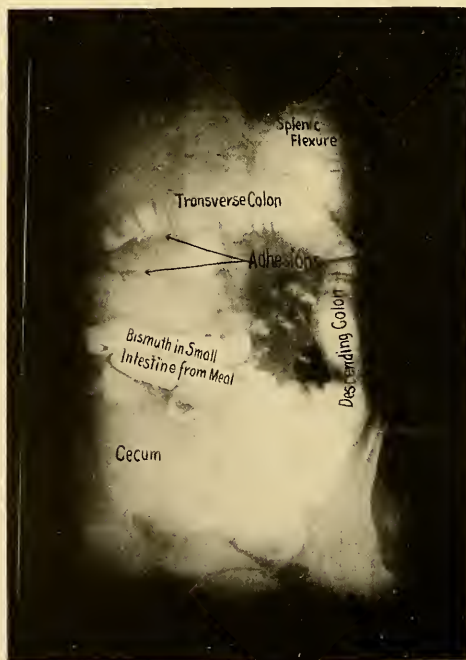

FIG. 47.—Transverse colon adherent to sigmoid.





FIG. 48.—Pressure of large tumor (cystic kidney) upon hepatic flexure.



great importance to determine whether some seemingly abnormal position is a fixed one (Fig. 47). This may be done by palpation while observing the colon in the röntgenoscope, and sometimes additional evidence may be obtained by making röntgenograms in the erect, prone and Trendelenburg positions.

The cause of constipation may be found in a kink or constriction; in a large, dilated, atonic cæcum; in the marked atony of the entire colon; or in a spastic condition of the colon.

The sigmoid is sometimes long and redundant, and may be adherent in the region of the appendix or in almost any other part of the abdomen. Case reports a case in which the sigmoid was adherent to both a diseased appendix and to the gall-bladder.

Neoplasm of the colon, especially carcinoma, can usually be diagnosed by Röntgen examination. It may produce almost complete obstruction with dilatation in the proximal portion.

The carcinoma is usually represented by an annular defect in the barium shadow with the narrow stream of barium passing through the more or less centrally placed lumen. Great care must be exercised in studying the region of the sigmoid and rectum for suspected carcinoma. Examinations should be made twenty-four and forty-eight hours after the meal, and more important still, the barium enema should be watched carefully on the screen as it enters.

## CHAPTER XII.

### THE URINARY SYSTEM.

RÖNTGENOSCOPY is of very little value in examination of the urinary system. Röntgenograms furnish the only reliable evidence upon which to base either positive or negative diagnoses.

TECHNIC OF EXAMINATION.—The most painstaking care in technic is necessary in röntgenography of the kidneys, ureters, and bladder.

The first essential is the thorough preparation of the patient, without which Röntgen examination is valueless. A very light diet should be taken for twenty-four hours previous to the examination, and the bowels should be thoroughly cleared by means of aperients. An enema should be given shortly before the examination is made. Fecal shadows make it very difficult to arrive at correct conclusions, and for this reason it is often necessary for the patient to continue on a restricted diet for an additional twenty-four hours and to undergo a second preparation by means of purgatives and enemata. The best of technic will fail to produce satisfactory results if the patient is not thoroughly prepared.

The examination should include a röntgenogram of each kidney region, one covering the course of each

ureter, and a stereographic pair of the pelvis, six in all. This is always necessary because it has often happened that the röntgenogram showed the stone in the opposite kidney from the one suspected, while in other cases there may be calculi on both sides. The pelvis must be included because the stone which has caused the renal symptoms may have passed into the bladder.

Plates 8 x 10 inches in size have been found the most satisfactory because their area can be completely covered by the ray with the use of a rather small cylindrical diaphragm. The 10 x 12 size is best for the pelvis.

A soft tube with sharp focus and having clear-cut hemispheres should be used. A tube which is too hard fails to give the detail in the soft structures essential to a good röntgenogram of the kidney regions, and may fail to show the softer calculi.

Compression by means of some form of compression diaphragm, rubber bag, or other apparatus is a valuable aid in securing good detail, because it displaces the abdominal contents over the kidney.

The plate for the kidney should be so placed that the last two ribs and the first three lumbar vertebrae will show upon it. The target is adjusted over the centre of the plate at a distance of about eighteen inches, and the exposure made while the patient holds the breath.

The essential features of a satisfactory röntgenogram of the kidney region are that it shall show clearly the last two ribs, the three upper lumbar vertebræ including the transverse processes, the outline of the psoas muscle, and the crest of the ilium. It is now usually possible to show the outline of the kidney itself. It is important to use every effort to do this, for if a röntgenogram gives sufficient detail to show the kidney a negative diagnosis of calculus can be based upon it with only very slight probability of error. Even in very fat patients with thorough preparation and the use of good compression the kidney shadow may be shown.

The plate for the ureter should show the third, fourth, and fifth lumbar vertebræ and the sacro-iliac synchondrosis, while that of the pelvis should include both sacro-iliac synchondroses, the sacrum, and the coccyx to its tip.

**CALCULUS.**—The greatest value of röntgenography of the urinary tract has been in the diagnosis of calculus. Formerly it was thought that only a positive finding was of value, but with improved technic such fine detail can now be obtained that the errors in negative diagnosis are very few.

The positive diagnosis of renal calculus is based upon the presence of a definite shadow over the kidney

region. If the shadow of the kidney itself shows on the plate no difficulty is experienced in locating the stone either in the pelvis or cortex of the kidney. The shadow is sometimes between the eleventh and twelfth ribs but more often below the twelfth rib. If the kidney is in its normal position the shadow is always internal to a line erected perpendicularly from the middle of the iliac crest.

A stone in the ureter produces a shadow somewhere along the line of the tips of the transverse processes of the lumbar vertebræ or over the sacro-iliac synchondrosis. In the great majority of cases it lies below the pelvic brim.

**DIFFERENTIAL DIAGNOSIS.**—Calcareous glands resemble calculi but may be distinguished from them by their more irregular outline and the fact that they are not usually over the course of the ureter.

Small calcareous bodies called phleboliths sometimes appear along the lower part of the ureter, but they are usually multiple, and may be arranged in a line at an angle to the course of the ureter.

Fecal concretions or foreign bodies in the intestine are distinguished from calculi by the fact that they change position or disappear entirely if several examinations are made.

Gall-stones only rarely throw dense enough

shadows to be seen on the röntgenogram and when they do they usually have a fairly characteristic appearance. Because of the greater density of the outer layer of the stone the shadow has a ring-shaped appearance with a dark centre. Gall-stones may also be distinguished from renal calculi by the fact that they show much better when the patient lies with the abdomen next to the plate, while renal calculi cast their sharpest shadow with the patient on the back.

Difficulty in the diagnosis of renal calculus may arise because of displacement of the kidney from its normal position. The kidney may then be located by the injection into the pelvis through a ureteral catheter of some form of silver preparation such as collargol.

Sometimes a calcareous gland or other calcified body may throw a shadow directly on the line of the ureter. It then becomes necessary to take other röntgenograms with a bismuth-impregnated ureteral catheter in position. It must not be inferred, however, that a shadow is not that of a ureteral calculus simply because the catheter can be passed beyond it, for this has frequently happened. Röntgenograms at different angles and also stereoröntgenograms will need to be taken to establish the exact relation of the shadows.

The pelvis may be röntgenographed with the



patient lying upon his back or upon his abdomen. If the latter position is used it is well to tilt the tube so that the rays pass obliquely forward and toward the patient's head. This prevents superimposing the shadow of the sacrum upon the region of the bladder.

Röntgenography is of great value in cases of vesical calculus, since it not only reveals the stones which might be discovered by the sound, but also shows the presence of stones which are encysted and cannot be so discovered.

## CHAPTER XIII.

### RÖNTGEN THERAPY.

THE technic of Röntgen therapy may be comparatively simple or extremely complicated, depending largely upon the personal choice of the Röntgen therapist. The author believes that a simple, well standardized technic, in which dosage is the only variable factor, will on the whole give as good practical results as one in which many variable factors have to be reckoned. It is particularly recommended that the novice in Röntgen therapy adopt and adhere strictly to a standard technic, and not attempt to vary any of its factors until he has completely mastered it.

APPARATUS.—The exciting apparatus for Röntgen therapy should be one capable of maintaining for at least two hours of constant running a potential equivalent to an eight, or preferably a ten-inch spark, with at least five milliamperes of current passing through the tube. A well-built high-tension transformer is suitable for this purpose.

TUBES.—The Coolidge tube has many points of superiority over any type of gas tube for Röntgen therapy and its use greatly simplifies the technic. It is at present almost universally used and recommended where treatment work on an extensive scale is under-

taken. A broad or medium focus tube should be chosen for this purpose.

**QUALITY OF RAY.**—Theoretically, rays of high penetration would seem to be desirable in the treatment of deep-seated lesions, while rays of relatively less penetration would be used in the treatment of lesions at or near the surface. Practically, a wide range in the selection of the quality of ray to be employed does not seem to be necessary or desirable. The Röntgen beam is not homogeneous, but is composed of a bundle of rays differing greatly in wave length. A large percentage of these rays are absorbed in a comparatively superficial layer of tissue—a quantity quite sufficient to accomplish the therapeutic aim in superficial lesions even if using the most penetrating rays at present obtainable. It should be remembered that rays of relatively low penetration are the ones most likely to produce disastrous burns, although none are immune from this effect.

In using the Coolidge tube the quality or penetrability of the ray is estimated on the basis of the length of spark as measured on the parallel spark gap. A spark of not less than eight inches, with five milliamperes of current passing through the tube, affords a satisfactory working basis for practically all Röntgen therapy. For deep lesions a spark length of nine or ten inches may be employed.

**SKIN-FOCUS DISTANCE.**—The distance of the focal point of the anode of the tube from the surface of the body is called the skin-focus distance or is sometimes designated simply as the focal distance. The value of the rays varies inversely with the square of the distance. Thus it will be seen that distance is a very important factor in estimating dosage, and should always be as nearly constant as circumstances well permit. Eight inches is a convenient standard for nearly all work.

**FILTRATION.**—By filtration, as the name implies, is meant the interception or absorption of some of the rays of relatively low penetration. This is accomplished by interposing certain substances between the tube and the patient. Aluminum is quite commonly employed for this purpose, and is placed in sheets of uniform thickness over the diaphragm of the tube stand. Leather or chamois is sometimes placed next to the body surface to protect it from secondary radiations. The thicker the filter the more rays it will absorb. No arbitrary rule can be laid down as to the thickness of filter to be employed. Three millimetres of aluminum is a practical and conservative standard for developing a working technic. The author uses filtration for all Röntgen therapy, both superficial and deep. Filtration is an important factor in dosage as by its use a considerably larger dose can be administered without deleterious skin effects.

**DOSAGE.**—By a dose of Röntgen rays is meant a quantity sufficient to produce a slight erythema of the skin. Several different instruments and methods have been devised for the measurement of quantity. As may be seen from the foregoing there are a number of factors which enter into the estimation of dosage, the essential ones being the milliamperage through the tube, the quality of ray, filtration, and the skin-focus distance. It would appear that if the above factors are constant, the only additional factor requisite for the delivery of a definite quantity, would be the time of exposure. This, indeed, does form the basis of one of the methods of estimating dosage and is known as the indirect method. It is an entirely practical method in the hands of an experienced operator if using a Coolidge tube. If using the ordinary type of gas tube the fluctuation in the quality of ray is such as to render the method unreliable. Unfortunately, it is not practical to state in definite terms of minutes and seconds the time required to deliver an erythema dose under given conditions. To do so would invite disaster. This may be due in part to variations in equipment, but is believed to be due in large measure to the personal equation that enters into the interpretation of the various factors. For instance, the author in his own laboratory is able to administer an erythema dose in six minutes with five milliamperes of current passing

through the tube, a parallel spark of eight inches, an aluminum filter of three millimetres, and a skin-focus distance of eight inches. Under the same conditions an exposure time of eight minutes will produce a very decided reddening of the skin with a desquamation of the outer layer. The above results may not, however, be obtained by another operator working as he believes with identically the same technic. Notwithstanding this fact, it is quite possible for one by careful experimentation to standardize his exposures, and thus develop a workable technic, but for purposes of standardization, and for the purpose of checking up the results of the indirect method as well, one of the direct methods of measurement should be employed.

There are several methods of direct measurement which will be mentioned in this connection. Unfortunately, each of these methods has a different numerical scale or terminology for indicating dosage.

The method of Kienboeck consists of strips of photographic paper placed upon the skin of the patient during the exposure, then developed and compared with a standard scale, ten units of which is the quantity required to produce erythema of the skin. The erythema dose in terms of the Kienboeck quantimeter is commonly expressed as 10 X. This method of measurement is probably as accurate as any if careful attention is given to details, but it is susceptible of so many technical errors that it is practically but little used.

All of the other methods of direct dose measurement in practical use are based upon the fact that platino-cyanide of barium changes in color when exposed to the Röntgen ray. The degree of discoloration is estimated by comparison with a color scale. The only essential difference in instruments of this type is the difference of the scale of the color indicator. Thus the degree of discoloration sufficient to produce an erythema is expressed on the Sabouraud-Noiré instrument as "tint B"; on the Hampson radiometer as four points; and on the Holzknacht radiometer five units indicate an erythema dose. The reading on the latter scale is commonly expressed as so many "H" units or as so many "H." It is well to remember, therefore, that 10 X, tint B, four points Hampson, and 5 H, are all terms which designate an erythema dose on their respective scales when the exposure is made without a filter. Filtration permits the above doses to be exceeded quite considerably. Eight H units may safely be administered if the rays are filtered through three millimetres of aluminum. There is some variation in the biological effect of these doses as above expressed, depending upon the quality of the ray employed, but for practical purposes, and as a matter of safety, it is assumed that a Coolidge tube backing up a spark of not less than eight inches is used in making the exposure.

The Holz knecht radiometer is one of the most satisfactory instruments of its type for the direct measurement of dosage. The index consists of a suitably tinted celluloid band. Pastilles of platino-cyanide of barium, commonly known as Sabouraud pastilles, constitute the reacting agent, just as in other instruments of this type. One-half of a pastille, which is suitably mounted on a holder, is wrapped in black paper to protect it from ordinary light, and placed upon the skin of the patient. The exposure is then made. Another half pastille which has not been exposed to Röntgen rays, is also suitably mounted and slides underneath the tinted celluloid band. The exposed half pastille is placed in the instrument and slides up and down synchronously with the exposed half. When the shades of the two exactly match, the reading is made from the appropriate scale. The reading should be made by artificial light, and for the sake of uniformity and accuracy, the same source and angle of incidence should always be employed. There are two scales on the instrument, one of which is employed when the pastille has been placed on the skin, and the other when the pastille has been placed half-way between the skin and the anode of the tube. The full skin distance is the one generally employed. For accurate results the pastilles should be reasonably fresh. They should be kept in a glass humidior where daylight has free access to them.



They should never be exposed to sunshine, nor kept too near a radiator. They become useless quite rapidly if kept in an atmosphere that is excessively dry and hot. A pastille that has been exposed to the Röntgen ray approximately regains its original color upon exposure to daylight, and may thus be used for a number of exposures, but it will gradually become discolored to such an extent that it will have to be discarded. It is not necessary to use the direct method of measurement of every dose if one adopts and masters a standard technic, but its occasional employment as a check on results is desirable, and its use is imperative if any factor of technic is varied, the influence of which is not definitely known.

The personal equation as regards the individual operator is a factor in the interpretation of the results of direct measurement, as well as of indirect, and the fact should constantly be borne in mind that a "dose" as interpreted by one operator may be distinctly dangerous as interpreted by another. This is not the case as a general rule, but is of sufficient importance to justify a word of caution.

**REPETITION OF DOSAGE.**—No area of the body surface which has received a full erythema dose should be again exposed to the Röntgen ray before the lapse of at least three weeks. Ordinarily, it is advisable not to repeat the exposure under five or six weeks, and in no

event should the exposure be repeated until all evidences of active skin irritation, due to a previous exposure, have entirely disappeared. Skin that has been exposed to a therapeutic dose is more susceptible to the effects of subsequent exposures, and the dose should be somewhat smaller. As a rule the erythema due to a therapeutic dose of the Röntgen ray reaches its maximum in about two weeks. There are rare instances, however, of delayed reaction where the erythema does not reach its maximum before the lapse of several weeks.

There is a limit to the number of doses that the skin will tolerate even when spaced by longer intervals than has been recommended. If treatment is continued for too long a time there is danger of establishing a chronic dermatitis, with possible ulceration, that may be incurable. The latter may not manifest itself until long after the treatment has been abandoned. It is advisable, therefore, not to unduly prolong Röntgen treatment. If the therapeutic aim is not accomplished in a reasonable time it would be better to abandon the treatment altogether, or at least greatly prolong the interval between exposures. A single erythema dose may cause telangiectasis of the skin. This is a fact well worth remembering, particularly where the final cosmetic result is a matter of great moment.

**CROSS-FIRING.**—Cross-firing is a procedure em-

ployed where it is desired to give a maximum dose to a deeply-seated lesion with a minimum effect upon the skin. Its practice is based upon the well-known fact that the rays diverge from the focal point on the anode of the tube, the Röntgen beam thus assuming the shape of a cone, the base of which becomes larger as the distance from the anode increases. For example, if an area of the body surface an inch in diameter is exposed, with a skin-focus distance of eight inches, the area through which the rays emerge on the opposite side of the body will be considerably larger, the degree of enlargement, of course, depending upon the thickness of the subject. A thorough understanding of this principle makes it apparent that a deep-seated lesion may be exposed or "cross-fired" through a number of different portals, care, of course, being taken not to duplicate the exposure over any single portal. There is ordinarily very little danger in delivering too large a dose of Röntgen rays to a deeply-seated lesion, regard, of course, always being had to the limit of skin tolerance. There are a few important exceptions to this rule. In Hodgkin's disease, leukæmia, and certain massive neoplasms, heavy dosage may cause such a rapid breaking down of tissue as to induce an alarming or even fatal toxæmia. Caution should be exercised in the treatment of such cases.

**PROTECTIVE MEASURES.**—In the treatment of dis-

ease by the Röntgen ray it is usually necessary to limit the exposure to restricted areas of the body surface. This is accomplished by covering the surrounding surface with material opaque to the ray. Lead foil, tin foil, or specially prepared fabrics are used for this purpose. Their efficiency for the purpose can be readily tested. Particular care is necessary in the protection of the face and scalp. It requires a somewhat smaller dose to produce an erythema of the face than of the trunk. Accidental depilation of the scalp should be avoided.

The author routinely orders a lotion recommended by Dr. Walter Dodd to be applied to skin which has received an erythema dose. It seems to limit the reaction to a certain extent and as a rule is grateful to the patient. The formula is as follows:

		c. c. or grammes
Carbolic acid.....	½ f. dram	2.
Zinc oxide.....	½ ounce	15.
Glycerin.....	½ ounce	15.
Lime water, q. s. ad . . . . .	6 ounces	180.

The patient is instructed to mop the lotion on the exposed areas for five minutes, twice daily, allowing it to dry on the skin.

Irritants should never be applied to skin that has recently been exposed.

The importance of complete protection of the oper-

ator from the Röntgen ray cannot be too strongly emphasized. The danger is particularly great in Röntgen therapy because of the quality of ray employed, and the large amount of secondary radiation which takes place. The protection afforded by the usual commercial equipment is entirely inadequate. The only safe procedure for the Röntgen therapist is to have his protection booth so constructed that photographic plates or films distributed at various places therein will remain free from fog over a prolonged period of operating.

**RÖNTGEN SICKNESS.**—Many patients after the administration of large doses of Röntgen rays exhibit a train of symptoms that are often distinctly annoying. They are depressed, prostrated, have headache, distaste for food, nausea or vomiting, and often state that they “taste or smell the ray” for several days. The symptoms vary greatly in intensity in different individuals and some appear to be entirely immune even to very large doses. It is not known how these symptoms are produced. They can be minimized by having the treatment room well ventilated, and the use of smelling salts, or the inhalation of aromatic spirits of ammonia or other perfume during the exposure is of value.

It is not within the scope of a short chapter on Röntgen therapy to discuss in detail the application of

this agent to the large number of diseases in which it has been found useful. Only a few diseases which the specialist in röntgenology is called upon to treat will receive brief mention.

**MALIGNANT NEOPLASMS.**—The Röntgen ray has an established place in the treatment of malignant new growths. On the whole the results are frequently discouraging just as they are with any other method of treatment. It is believed that the proper attitude to assume with regard to the treatment of malignant disease is to regard no single method of treatment as being the best. Each method may be the one of choice in different cases, and often a combination of methods offers the best chance of cure.

**PRECANCEROUS LESIONS.**—There are a number of dermatoses that are potentially malignant that can be cured by Röntgen therapy. The treatment is particularly applicable to the keratoses which quite commonly appear on the face late in life. They can be cured as a rule by a single full dose in accordance with the technic above described. The area exposed should include the lesion and a small margin of healthy skin.

**SKIN CANCER.**—Basal-cell carcinoma is as a rule amenable to Röntgen therapy. A single exposure will cure many growths of this variety. Only rarely is it necessary to give more than two or three doses. A fairly wide margin of healthy skin should be included

in the exposure. A full dose should be given. A quantity somewhat in excess of the erythema dose is advisable in many cases. From ten to fifteen Holzknecht units may be advisable, particularly if the lesion is covered by thick crusts or if there is an exuberant overgrowth of tissue that has to be destroyed. It is not necessary to treat the neighboring lymphatic drainage areas in this type of cancer as they do not tend to metastasize.

Prickle-celled cancer is much more resistant to Röntgen therapy than the basal-cell type. As a rule this method of treatment should not be given first choice in this type of growth. A considerable number can doubtless be cured by Röntgen therapy alone, but stated as a general principle, this method of treatment as a primary measure should be reserved for inoperable cases. Both as a pre-operative and post-operative surgical adjunct the treatment is of undoubted value. Much objection has been raised to the pre-operative treatment of cancer, none of which is believed to be valid, assuming of course that it does not unduly delay surgical procedure. With the present technic the latter is no longer necessary. Thoroughness should be the keynote in the Röntgen treatment of these growths whether it is used as a primary measure or as a surgical adjunct. The cardinal principle to be observed is to deliver to every diseased cell,

and to neighboring lymphatic channels, which may or may not be diseased, all the rays possible without doing irreparable damage to the healthy tissue. To do this rays of high penetration, adequate filtration, and a rational application of the principle of cross-firing are essential.

**DEEP-SEATED CANCER.**—The same principles apply to the treatment of deep-seated cancer, wherever located as have been described in the treatment of prickle-cell skin cancer. There is good ground for believing that post-operative treatment is of considerable value in preventing recurrences. Post-operative recurrences can rarely be made to disappear permanently. Inoperable growths will occasionally become operable. It is exceedingly difficult, however, to gain the patient's consent to surgical intervention after experiencing the benefit of Röntgen therapy, and the possibility of such a contingency should be clearly explained to the patient before instituting the treatment. There are undoubtedly far too many cancers subjected to surgical intervention, much to the patient's detriment, that are clearly inoperable. Such patients would undoubtedly live longer, and in far greater comfort, if treated by the Röntgen ray alone. By following such a course the use of opiates can frequently be avoided entirely, and only rarely is it necessary to begin their use until quite late in the disease.



SARCOMA.—As is well known, sarcomas vary greatly in their degree of malignancy. It also seems to be well established that they vary greatly in their degree of sensibility to Röntgen therapy. Experience has demonstrated that the latter is not necessarily a correlary of the former. Some of the most malignant tumors of this type will occasionally respond in a most satisfactory way to Röntgen therapy, while others of a relatively benign type are but little influenced. It is therefore impossible to state with any degree of certainty what the result will be in a given case, but in general terms it may be stated that the disease is primarily surgical, and that Röntgen therapy as a primary measure should be reserved for inoperable cases. The latter constitute a very large group.

The same principles of technic apply to the Röntgen treatment of sarcoma that apply to the treatment of deep-seated carcinoma. The growth should be cross-fired from every possible angle. In massive neoplasms involving the viscera, and particularly in very large lymphosarcomas, the initial dose should be comparatively small, as the rapid destruction of a large mass of tumor cells may induce a profound toxæmia. The latter should be carefully watched for, and the dose regulated accordingly. Sarcoma, as a rule, metastasizes through the blood-stream, hence the treatment of adjacent lymphatic glands is not essential unless they show evidence of disease.

**HODGKIN'S DISEASE.**—Röntgen treatment causes very marked and rapid reduction of the enlarged glands of Hodgkin's disease, and often a marked improvement in the general condition of the patient. While the initial improvement is often spectacular it is very rarely, or perhaps never, permanent. The same technic as to filtration and quality of ray is used as in the treatment of malignant neoplasms, but the treatment should not be nearly so intensive. The initial dose should always be small and the condition of the patient is the only safe guide to its subsequent size or frequency of repetition.

**LEUKÆMIA.**—Leukæmia is favorably influenced by Röntgen therapy, but it is doubtful if permanent cures are affected. Life can, however, often be greatly prolonged, and long periods of comparatively good health maintained in true leukæmia as well as in the pseudoleukæmic states. There is as a rule a marked improvement in the blood picture, and in the general well-being of the patient.

No definite standard of technic for the treatment of leukæmia can as yet be laid down. Both the spleen and the epiphyseal ends of the long bones should be exposed. The blood-picture and general condition of the patient afford the best guide to dosage and the frequency of its repetition.

**TUBERCULAR ADENITIS.**—In tubercular adenitis

Röntgen therapy is believed to be the most efficacious of all methods of treatment. By its intelligent use, in combination with appropriate hygienic measures, radical excision of tubercular glands will very rarely be necessary. The advantages of the former are quite obvious. Certain types of cases are more favorable for treatment than others, but there are none in which Röntgen therapy is not well worth a trial. If possible treatment should be instituted before breaking down of the glands has begun. If breaking down has already commenced Röntgen therapy will likely hasten the process. The pus may then be evacuated through a small incision. The most refractory cases are those with extensive sinuses and an abundance of scar tissue, such cases often having been subjected to repeated operations. Even in the latter the results of treatment are often most gratifying. Coëxistent tubercular disease of the lungs is by no means a contra-indication to treatment, but renders the prognosis less favorable.

There is no standard of technic for the Röntgen treatment of tubercular glands that has been universally adopted. Good results are doubtless obtained by widely different methods. Many operators administer a comparatively small dose at frequent intervals, while others give a fairly large dose less frequently. The author's practice is to administer 6 H units, using a filter of three millimetres of aluminum with a parallel

spark of eight inches. This dose is repeated in three weeks and then at progressively longer periods. It is advisable to treat both sides of the neck whether both show evidence of disease or not. Where there is a large amount of scar tissue, caution should be observed as to dosage, as such tissue is comparatively easily damaged by Röntgen rays. Often it is necessary to continue the treatment of these cases for a prolonged period, a sufficient interval being allowed between exposures to safeguard against a chronic Röntgen dermatitis. Treatment should not be abandoned too soon as the sinuses will often heal only after many months of patient effort.

NON-MALIGNANT DISEASES OF THE UTERUS.—*Uterine Fibroids*.—The indications for the Röntgen treatment of fibroids may be conservatively stated as follows:

1. All cases, regardless of the age of the patient, in which a surgical operation is contra-indicated either by the association of some other disease, or by a high grade of anæmia in consequence of hemorrhage.

2. All patients over forty years of age who present no contra-indication to Röntgen treatment.

The contra-indications to Röntgen therapy are as follows:

1. Small tumors causing no symptoms and requiring no treatment of any character.

2. Submucous polypoid growths.

3. Rapidly growing tumors in patients below forty years of age, where the symptoms are of such urgency as to necessitate prompt relief.

4. Gangrenous or infected tumors, or where there is an associated disease of the adnexa.

5. Cases in which malignant disease cannot be excluded with reasonable certainty. In this class Röntgen therapy should be regarded as a surgical adjunct.

The results to be expected from Röntgen therapy are as follows:

1. Reduction in size, or a complete disappearance of the tumor, with a proportionate relief of pressure symptoms.

2. Cessation of bleeding with a consequent improvement of the anæmia and general well-being of the patient.

Cessation of bleeding usually occurs within two or three months after beginning treatment. Occasionally the bleeding is increased temporarily following treatment, but does not tend to occur after the artificial menopause has once been established. Symptoms common to the normal menopause may be present.

The degree of reduction in the size of the tumor mass is variable. Usually it is quite marked, and a progressive reduction in size may continue for some time after all bleeding has been permanently checked

and treatment has been discontinued. A complete disappearance of the tumor is not uncommon.

*Metropathic Hemorrhages.*—Included under this head are that group of cases characterized by menorrhagia or metrorrhagia in which no tumor or other gross pathological defect is present. Although commonly classified as “metritis” or “endometritis” there is often no discoverable pathologic basis. The so-called climacteric hemorrhages belong to this group. In the latter the results of Röntgen therapy are very gratifying. In general it may be stated that the nearer the climacteric age is approached, the more suitable the case for Röntgen therapy. Good results are, however, often obtained in younger subjects. The ideal result in the latter would be to check excessive bleeding without permanently abolishing the menstrual function, but such is by no means always possible, and the probability of a permanent menopause should be explained to the patient before instituting treatment.

The technic of Röntgen treatment of uterine fibroid and metropathic hemorrhage is essentially the same as that of deep-seated malignant disease, so far as the quality of ray and filtration are concerned. There is some difference of opinion as to the proper number of areas for cross-firing. Six or eight portals of entry are an ample number for the average case. Two of

these may be located over the sacral region and the remainder over the lower abdomen. A full dose should be administered through each portal. The ovaries, as well as the tumor, if one be present, should be included in the field of irradiation, as it seems more than probable that the beneficial effect of the Röntgen ray in these cases is due in a large measure to its influence on the ovarian function. A series of exposures thus administered should not be repeated for at least five weeks. The number required is quite variable. In some cases one such series will completely abolish the ovarian function, and the average case seldom requires more than three or four. Much more irradiation is required to accomplish this result in young subjects than in those at or near the climacteric age. It does not seem to be desirable to continue treatment after the menopause is permanently established.

In summarizing the value of Röntgen therapy in gynæcology it may be stated that in properly selected cases the results are excellent. The proper selection of cases for this method of treatment is of prime importance, and to this end the earnest coöperation of the gynæcologist and röntgenologist is absolutely essential.

#### EXOPHTHALMIC GOITRE AND HYPERTHYROIDISM.

—The results of the Röntgen treatment of exophthalmic goitre and hyperthyroidism are quite variable. Some cases are clinically cured, and a majority show

more or less improvement. Quite a large number, however, show no material improvement that can definitely be attributed to the Röntgen therapy. There are no definite clinical criteria that will determine the type of case which will respond in a satisfactory manner. Occasionally cases which are profoundly toxic will show prompt and permanent benefit, while others of a comparatively mild type may not be improved.

The improvement in the symptomatology usually follows a definite order of sequence. There is at first a lessening of the general nervousness. The patients become less emotional; they sleep better, and often state that they feel much better long before there is any obvious improvement in the objective symptoms. A decrease of tremor occurs, as a rule, quite early in favorable cases. A decrease in the pulse-rate not infrequently occurs, and it may become normal. The improvement in the tachycardia, however, is by no means always proportionate to the improvement in the general well-being of the patient. This may be due to the fact that the tachycardia is not necessarily an expression solely of toxicity, but may be due, in part at least, to the condition of the myocardium. Decrease in the size of the thyroid gland is occasionally quite marked, but it is not a conspicuous result of Röntgen therapy. There may, however, be a marked improvement in the condition of the patient without any appreciable de-



crease in the size of the gland. The exophthalmos is but rarely influenced to any great extent by Röntgen therapy.

Mean and Aub<sup>1</sup> publish some interesting observations on the basal metabolism in exophthalmic goitre, and undertake to estimate the value of the various methods of treatment from that standpoint. Their conclusions are as follows:

“1. The general metabolism shows a characteristic increase in hyperthyroidism.

“2. This rise may be used as a functional test of the thyroid activity or as an index of the intensity of the thyroid intoxication.

“3. An extended study of the metabolism in various types of toxic goitre show that:

“(a) Rest alone usually causes a marked decrease in toxicity.

“(b) Drugs in addition to rest do not materially accelerate this decrease.

“(c) The Röntgen ray, in some cases, produces a definite improvement, while in others it seems to be quite without effect.

“(d) The usual immediate effect of surgery is a marked decrease in toxicity, but there is a very definite tendency toward a subsequent recurrence.

---

<sup>1</sup>Jour. A. M. A., July 7, 1917.

“ 4. The lesson in therapeutics to be drawn from these results we believe to be as follows:

“(a) Complete rest in bed plus irradiation should be continued until the metabolism reaches a level.

“(b) If rest and the Röntgen ray fail to restore the metabolism to within 20 per cent. of the normal, it is proper to resort to surgery, unless there is some definite contra-indication. Among contra-indications a rising metabolism, in spite of complete rest, seems to be very important.

“(c) Following operation, if the metabolism again increases, further active treatment should be carried out. The observations in the cases that we have followed for a long time emphasize the importance of keeping cases of exophthalmic goitre under observation for months rather than weeks, and preferably years rather than months.”

The above conclusions, which in general would be anticipated from a clinical study of the disease, express in a sane and conservative manner the place of Röntgen therapy in its management.

The technic of Röntgen therapy in exophthalmic goitre, so far as the quality of ray and filtration are concerned, is essentially the same as that for treating other lesions heretofore described. A dose is delivered to each lobe of the thyroid. It is also a common practice to expose the thymus through one or two portals

located on either side of the sternum upon the assumption that the thymus and thyroid are in some way inter-related in the production of the symptom-complex of exophthalmic goitre. The evidence of such an inter-relationship does not seem to be conclusive, but it is the author's practice at present to expose both the thyroid and thymus. The dosage should be accurate. An intense skin reaction is not desirable, not only from a therapeutic standpoint, but for the purpose of avoiding as far as possible permanent cosmetic defects. The exposures as a rule should not be repeated oftener than every four or five weeks, and should be discontinued as soon as the symptoms are under control. It has been stated that if the treatment is unduly prolonged a condition of hypothyroidism may result. The possibility of such an occurrence is probably remote. If definite improvement has not occurred within from four to six months from the time of instituting Röntgen therapy, it is not likely that it will ever contribute to the recovery of the patient. It should be remembered that complete physical, and as far as possible mental rest, form an important supplement to any of the present methods of treating exophthalmic goitre.



# INDEX

- Abscess, alveolar, 90  
     of lung, 98  
 Accelerator, sodium carbonate as, 51  
 Amidol, 51  
 Ampere, definition of, 3  
 Aneurism, thoracic, 93  
     diagnosis of, 93  
     fluoroscopy in, 93  
 Ankle, röntgenography of, 77  
 Anode, accessory, 14, 16  
 Anti-cathode, 14  
 Appendix, vermiform, 114  
 Arrhenius, theory of, 2  
 Arthritis deformans, 79  
 Barium sulphate, 101  
     enema, 113  
     meal, 101  
 Batteries, electric, 35  
     galvanic, 2  
     storage, 35  
 Benoist, radiochromometer of, 22  
 Bone, tumors of, 80  
     cysts of, 84  
 Bones, cysts of, 84  
     diseases and injuries of, 75, 79  
     exostoses of, 80  
     sarcoma of, 19  
     syphilis of, 78  
     tubercular disease of, 78  
 Bronchiectasis, 98, 100  
 Carcinoma, diagnosis of, 85  
     of bone, 85  
     of colon, 112  
     of œsophagus, 103  
     of stomach, 108  
         treatment of, 134  
         basal-cell, 134  
         prickle-cell, 135  
     of stomach, skin, 134  
         deep-seated, 136  
 Cardiospasm, 102  
 Cathode, aluminum, 14  
 Cathode rays, 11  
 Cell, galvanic, 2, 5  
     Daniell, 3  
     potassium bichromate, 3  
 Charcot's joint, 83  
 Chondroma, 81  
 Coil, induction, 28  
 Colon, 112  
     constriction of, 112-113  
     enema for examination of, 113  
     ptosis of, 114  
 Conduction, 6  
 Constipation, causes of, 115  
 Copper wire best for conductors, 48  
 Coulomb, definition of, 4  
 Cross-firing, 130-131  
 Current for induction coil, 35  
     for transformer, 41  
 Current strength, unit of, 4  
 Developing solutions, 52  
 Diaphragm, diminished excursion of,  
     72  
 Duodenum, 105  
 Eikonogen, 51  
 Elbow, röntgenography of, 77  
 Electricity, 1  
     dynamic, 1  
     faradic, 1  
     galvanic, 1  
     nature and properties of, 1  
     static, 1  
 Electrification, kinds of, 6  
 Electro-magnet, 8, 9  
 Electro-motive force, unit of, 4

- Elektron, 1  
 Erythema dose, 125  
 Esophagus, 102  
 Enchondroma, differential diagnosis of, 80  
 Exostoses, 80  
 Exposure, length of, 55  
 Fibroids, uterine, 140  
   treatment of, 140  
 Filters, materials for, 124  
 Filtration, 124  
 Fixing solutions, 56  
 Foreign bodies, 64, 74  
   direct röntgenoscopic, 72  
   Flint's method, 70  
   Hernaman-Johnson method, 68  
   in the eye, 74  
   localization of, 64  
   Mackenzie-Davidson method, 65  
   stereoscopic, 64  
   Sutton method, 69  
 Gall-bladder, 111  
 Gall-stones, 111, 112  
 Grouping of galvanic cells, 5  
 Hampson radiometer, 127  
 Head, fractures of, 87  
   new growths of, 87  
 Heart, röntgenography of, 93  
 Hemorrhages, metropathic, 140  
 Hip, röntgenography of, 77  
 Hodgkin's disease, 138  
 Holz knecht radiometer, 123  
 Hydroquinon, 52  
 Induction, 6  
   coil, 28  
   alternating current with, 36  
 Intensification, 58  
 Interrupter, 31  
   electrolytic, 33  
   Caldwell-Simon, 35  
   Wehnelt, 34  
 Interrupter, mechanical, 31  
   mercury, 32  
   dipper, 32  
   jet, 33  
   rotary, 33  
   vibrating, 31  
 Iridium target, 16  
 Inverse currents, 29  
 Kidney, calculus of, 118  
   diagnosis of, 118  
   technic of examination of, 119  
 Kienbøch quantimeter, 126  
 Knee röntgenography of, 77  
 Leukemia, treatment of, 138  
 Light, action on photographic plates, 50  
 Localizer, 68  
   ring, 68  
   Sutton, 69  
   Sweet's, 74  
 Localization of foreign bodies, 64, 67  
 Lungs, normal, 91  
   hilus of, 95  
 Magnet, 7  
 Magnetic field, 8  
 Mediastinum, posterior, tumors of, 94  
 Mercuric chloride for intensification, 58  
 Metol, 51, 53  
 Milliammeter, 21  
 Myeloma, multiple, 84  
 Esophagus, 102  
   dilation of, 102  
   obstruction of, 102  
   röntgenography of, 102  
   röntgenoscopy of, 102  
 Osteoma, 80  
 Ohm, definition of, 3  
 Ohm's law, 4, 48  
 Ortol, 51  
 Oscilloscope, 29  
 Osmium as material for target, 16  
 Osteomyelitis, 78, 79  
 Osteosarcoma, 79

- Osteosarcoma, differential diagnosis**  
 of, from syphilis, 79  
**Parallel, grouping of cells in, 5**  
**Periostitis, 77**  
**Plates, photographic, 50**  
   intensification of under-exposed,  
     58  
   reduction of over-exposed, 57  
   silver salts on, 51  
   X-ray, 54  
**Platinum as material for target, 15**  
**Pleurisy, acute, with effusion, 94**  
**Pneumothorax, 94**  
**Polarization action in rectifier, 36**  
**Potassium bromide as restrainer, 52**  
   cyanide as reducer, 57  
   permanganate, 57  
**Precancerous lesions, 134**  
**Preservative, sodium sulphite as, 52**  
**Profondometer, 70**  
**Protective measures, 131-132**  
**Pulmonary tuberculosis, 94, 98**  
**Pylorus, obstruction of, 107**  
**Pyorrhœa alveolaris, 90**  
**Pyrogallic acid as reducer, 51**  
**Radiochrometer of Benoist, 22**  
**Rays, 20**  
   cathode, 11  
     properties of, 11  
     relaxation to X-rays, 12  
   indirect, 20  
   inverse, 26  
   secondary, 20  
**Rectifier, 36**  
   aluminum cell, 37  
   mercury arc, 38  
   mercury vapor, 38  
**Reducer, function of, 57**  
**Resistance, electrical, 3, 4**  
**Restrainer, potassium bromide as,**  
   51, 52  
**Rheostat, 49**  
**Rodinal, 51**
- Röntgen sickness, 138**  
   therapy, 122  
     apparatus for, 122  
     Coolidge tube for, 122  
     dosage in, 125  
     of carcinoma, 85  
     of leukemia, 131  
     of tubercular adenitis, 139  
     of uterine fibroids, 140  
     of uterine hemorrhage, 142  
     quality of ray in, 123  
     untoward effects of, 124  
**Röntgenography, 50, 54**  
   dental, 89  
   stereoscopic, 62  
     advantages of, 63  
     apparatus for, 63  
     for dislocations, 63  
     for fractures, 63  
     for localization of foreign  
       bodies, 64  
     technic of, 63  
**Röntgoenscopy, dangers of, 21, 59, 61**  
   description of, 60  
   examination of chest by, 61  
   examination of colon by, 61  
   examination of stomach by, 61  
**Sarcoma, röntgen treatment of, 137**  
   of bone, 81  
**Screen, fluoroscopic, 92**  
   intensifying, 55  
**Series, grouping cells in, 5**  
**Shoulder, radiography of, 77**  
**Sinuses, accessory, 87**  
   frontal, 88  
   maxillary, 88  
   sphenoidal, 88  
**Skin-focus distance, 124**  
**Solenoid, 9**  
**Spark-gap, 21**  
   adjustable, 30  
**Spinal column, 76**  
**Spondylitis deformans, 80**

- Static electricity, 1  
 machine, 26
- Stomach, appearance of normal, 105  
 carcinoma of, 108  
 hour-glass contractions of, 107  
 pyloric region of, 110  
 röntgenoscopy of, 103  
 ulcer of, 106
- Target of X-ray tube, 15
- Teeth, röntgenography of, 89
- Terminals, positive and negative,  
 means of determining, 23
- Thorax, 91  
 röntgenography of, 91  
 stereoscopic, 91
- Transformer, 39  
 advantages of, 41  
 alternating current for, 41  
 description of, 39  
 direct current for, 41  
 oil as insulation, 41  
 ring type of, 40  
 shell or jacket type of, 41  
 "step-up" and "step-down," 40
- Tube, 13  
 Coolidge, description of, 24
- Tubercular adenitis, 138, 139  
 treatment of, 139
- Tubes, vacuum, 13  
 care of, 22  
 Crookes, 13  
 directions for regulating, 19
- Tubes, vacuum, for induction coil,  
 29  
 Geissler, 10  
 modern type, of X-ray, 15  
 Queen's self-regulating, 17  
 valve or ventril, 30  
 Villard, 30  
 water-cooled, 16
- Ulcer of duodenum, 88, 91  
 of stomach, 88
- Ureter, calculus of, 118, 119  
 radiography of, 118
- Urinary system, 116  
 fluoroscopy of, 117  
 radiography of, 116
- Vacuum, 10  
 devices for regulating, 16-18  
 directions for regulating, 19
- Valve, ileocæcal, 114  
 tube, 30
- Volt, definition of, 4
- Watt, definition of, 4
- X-ray, 10  
 discovery of, 11  
 history of, 10-12  
 penetrative power of, 21  
 plates, 51  
 properties of, 12  
 relation of, to cathode ray, 12  
 source of, 12  
 tubes, 13-16, 21, 22





Impure Boh - 4 grams

C - 3 gals. Water

8 lbs. Hyposulphite of soda

8 oz. Sodium sulphite

B - 1 gal. water

8 oz. Chrome Alum

1 oz. Sulphuric acid

for warm water

C - 1 gal. water

Chrome Alum

4 oz.

oxalic acid (28%)

24 oz. mix separately - when cool mix together

Best's  
Eastman's

Developer - 2 gallons  
Mix in order -

Diag.

8 qts  
1/2 oz  
1/2 oz  
2 oz  
1/2 oz  
1/5 oz

Water

Metol

Sodium Sulphite

Hydroquinone

Sodium Carbonate

Potassium Bromide

8 qts  
1/2 oz  
10 oz  
2 oz  
10 oz  
1/2 oz

128 oz = 1 gal.

480 gr. = 1 oz

COUNTWAY LIBRARY OF MEDICINE

RC  
78  
C46  
1917

RARE BOOKS DEPARTMENT

