

# HANDBOOK OF

# Dairy Foods Analysis

Edited by  
**LEO M.L. NOLLET**  
**FIDEL TOLDRÁ**



H A N D B O O K O F

---

**Dairy Foods  
Analysis**



H A N D B O O K O F

---

# Dairy Foods Analysis

Edited by  
LEO M.L. NOLLET  
FIDEL TOLDRÁ



CRC Press

Taylor & Francis Group

Boca Raton London New York

---

CRC Press is an imprint of the  
Taylor & Francis Group, an **informa** business

CRC Press  
Taylor & Francis Group  
6000 Broken Sound Parkway NW, Suite 300  
Boca Raton, FL 33487-2742

© 2010 by Taylor and Francis Group, LLC  
CRC Press is an imprint of Taylor & Francis Group, an Informa business

No claim to original U.S. Government works

Printed in the United States of America on acid-free paper  
10 9 8 7 6 5 4 3 2 1

International Standard Book Number: 978-1-4200-4631-1 (Hardback)

This book contains information obtained from authentic and highly regarded sources. Reasonable efforts have been made to publish reliable data and information, but the author and publisher cannot assume responsibility for the validity of all materials or the consequences of their use. The authors and publishers have attempted to trace the copyright holders of all material reproduced in this publication and apologize to copyright holders if permission to publish in this form has not been obtained. If any copyright material has not been acknowledged please write and let us know so we may rectify in any future reprint.

Except as permitted under U.S. Copyright Law, no part of this book may be reprinted, reproduced, transmitted, or utilized in any form by any electronic, mechanical, or other means, now known or hereafter invented, including photocopying, microfilming, and recording, or in any information storage or retrieval system, without written permission from the publishers.

For permission to photocopy or use material electronically from this work, please access [www.copyright.com](http://www.copyright.com) (<http://www.copyright.com/>) or contact the Copyright Clearance Center, Inc. (CCC), 222 Rosewood Drive, Danvers, MA 01923, 978-750-8400. CCC is a not-for-profit organization that provides licenses and registration for a variety of users. For organizations that have been granted a photocopy license by the CCC, a separate system of payment has been arranged.

**Trademark Notice:** Product or corporate names may be trademarks or registered trademarks, and are used only for identification and explanation without intent to infringe.

---

**Library of Congress Cataloging-in-Publication Data**

---

Handbook of dairy foods analysis / Leo M.L. Nollet, Fidel Toldrá.  
p. cm.

Includes bibliographical references and index.  
ISBN 978-1-4200-4631-1 (hardcover : alk. paper)

1. Dairy products--Analysis--Handbooks, manuals, etc. I. Nollet, Leo M. L., 1948- II. Toldrá, Fidel. III. Title.

SF253.H35 2009  
637--dc22

2009032734

---

Visit the Taylor & Francis Web site at  
<http://www.taylorandfrancis.com>

and the CRC Press Web site at  
<http://www.crcpress.com>

---

# Contents

---

Preface.....	ix
Editors .....	xi
Contributors.....	xiii

## PART I: CHEMISTRY AND BIOCHEMISTRY

<b>1</b> Introduction to Analysis in the Dairy Industry .....	<b>3</b>
PATRICK F. FOX	
<b>2</b> Amino Acids in Dairy Foods .....	<b>9</b>
M. CONCEPCIÓN ARISTOY AND FIDEL TOLDRÁ	
<b>3</b> Peptides .....	<b>33</b>
ISIDRA RECIO AND ROSINA LÓPEZ-FANDIÑO	
<b>4</b> Milk Proteins.....	<b>79</b>
JERZY DZIUBA, PIOTR MINKIEWICZ, MAŁGORZATA DAREWICZ, AND BARTŁOMIEJ DZIUBA	
<b>5</b> Proteomics.....	<b>109</b>
STEFANO SFORZA, VALERIA CAVATORTA, AND ROSANGELA MARCHELLI	
<b>6</b> Carbohydrates .....	<b>139</b>
NIEVES CORZO, AGUSTÍN OLANO, AND ISABEL MARTÍNEZ-CASTRO	
<b>7</b> Triacylglycerols in Dairy Foods .....	<b>169</b>
JAVIER FONTECHA, MANUELA JUÁREZ, AND MIGUEL ANGEL DE LA FUENTE	
<b>8</b> Dairy Polar Lipids.....	<b>189</b>
ROELAND ROMBAUT AND KOEN DEWETTINCK	
<b>9</b> Fatty Acids.....	<b>211</b>
MIGUEL ANGEL DE LA FUENTE AND MANUELA JUÁREZ	
<b>10</b> Cholesterol .....	<b>229</b>
ZEHRA GÜLER AND YOUNG W. PARK	

<b>11</b>	<b>Organic Acids</b> .....	<b>259</b>
	HUIMIN ZHANG AND LLOYD E. METZGER	
<b>12</b>	<b>Flavor Formation</b> .....	<b>277</b>
	BARBARA D'ACAMPORA ZELLNER, PAOLA DUGO, GIOVANNI DUGO, AND LUIGI MONDELLO	

## **PART II: TECHNOLOGICAL QUALITY**

<b>13</b>	<b>Microstructure</b> .....	<b>295</b>
	ISABEL HERNANDO, ISABEL PÉREZ-MUNUERA, AMPARO QUILES, AND MARÍA-ANGELES LLUCH	
<b>14</b>	<b>Biosensors</b> .....	<b>307</b>
	NÓRA ADÁNYI	
<b>15</b>	<b>Physical Sensors and Techniques</b> .....	<b>329</b>
	COLETTE C. FAGAN AND COLM P. O'DONNELL	
<b>16</b>	<b>Rheological Properties and Flavor Release</b> .....	<b>345</b>
	NATHALIE CAYOT	
<b>17</b>	<b>Determination of Identity and Quality of Dairy Products</b> .....	<b>363</b>
	ROMDHANE KAROUI	
<b>18</b>	<b>Determination of Glycolysis</b> .....	<b>385</b>
	GASPAR PÉREZ-MARTÍNEZ	
<b>19</b>	<b>Determination of Proteolysis in Cheese</b> .....	<b>405</b>
	N. BANSAL, P. PIRAINO, AND PAUL L.H. MCSWEENEY	
<b>20</b>	<b>Determination of Lipolysis</b> .....	<b>427</b>
	KIERAN KILCAWLEY	
<b>21</b>	<b>Characterization of Lactic Acid Bacteria Used as Starter Cultures</b> .....	<b>449</b>
	TERESA REQUENA AND CARMEN PELÁEZ	
<b>22</b>	<b>Detection of Bacteriophages in Milk</b> .....	<b>469</b>
	ALFONSO H. MAGADÁN, VICTOR LADERO, NOELIA MARTÍNEZ, BEATRIZ DEL RIO, M. CRUZ MARTÍN, AND MIGUEL A. ALVAREZ	

## **PART III: NUTRITIONAL QUALITY**

<b>23</b>	<b>Prebiotics</b> .....	<b>485</b>
	K. C. MOUNTZOURIS AND P. TSIRTSIKOS	
<b>24</b>	<b>Probiotics</b> .....	<b>503</b>
	ANA M. GOMES, MANUELA E. PINTADO, AND F. XAVIER MALCATA	

- 25 Determination of Water- and Fat-Soluble Vitamins in Infant Formulae ..... 531  
OLIVIER HEUDI
- 26 Minerals and Trace Elements ..... 543  
AMPARO ALEGRÍA, REYES BARBERÁ, MARÍA JESÚS LAGARDA,  
AND ROSAURA FARRÉ

#### PART IV: SENSORY QUALITY

- 27 Color..... 581  
LAURENT DUFOSSÉ AND PATRICK GALAUP
- 28 Texture ..... 603  
KASIVISWANATHAN MUTHUKUMARAPPAN AND  
CHINNADURAI KARUNANITHY
- 29 Flavor..... 615  
BARBARA D'ACAMPORA ZELLNER, PAOLA DUGO, GIOVANNI DUGO,  
AND LUIGI MONDELLO

#### PART V: SAFETY

- 30 Microbial Flora..... 647  
EFFIE TSAKALIDOU
- 31 Spoilage Detection ..... 665  
MARIA CRISTINA DANTAS VANETTI
- 32 PCR-Based Methods for Detection of Foodborne Bacterial Pathogens  
in Dairy Products..... 677  
ILEX WHITING, NIGEL COOK, MARTA HERNÁNDEZ, DAVID RODRÍGUEZ-  
LÁZARO, AND MARTIN D'AGOSTINO
- 33 Mycotoxins and Toxins ..... 689  
CARLA SOLER, JOSÉ MIGUEL SORIANO, AND JORDI MAÑES
- 34 Detection of Adulterations: Addition of Foreign Lipids and Proteins ..... 719  
SASKIA M. VAN RUTH, MARIA G. E. G. BREMER, AND ROB FRANKHUIZEN
- 35 Detection of Adulterations: Identification of Milk Origin..... 733  
GOLFO MOATSOU
- 36 Residues of Food Contact Materials..... 755  
EMMA L. BRADLEY AND LAURENCE CASTLE
- 37 Chemical Contaminants: Phthalates..... 777  
JIPING ZHU, SUSAN P. PHILLIPS, AND XU-LIANG CAO



<b>38</b>	<b>Analysis of Antibiotics in Milk and Its Products .....</b>	<b>801</b>
	JIAN WANG	
<b>39</b>	<b>Environmental Contaminants.....</b>	<b>821</b>
	SARA BOGIALLI AND ANTONIO DI CORCIA	
<b>40</b>	<b>Allergens.....</b>	<b>843</b>
	VIRGINIE TREGOAT AND ARJON J. VAN HENGEL	
<b>41</b>	<b>Amines.....</b>	<b>861</b>
	TOMÁŠ KOMPRDA AND VLASTIMIL DOHNAL	
	<b>Index .....</b>	<b>879</b>

---

# Preface

---

Dairy foods include a wide variety of foods such as milk, butter, yogurt, cream, ice cream, and cheese. These foods represent some of the most important types of foods in Western societies. This book aims to be a reference book on the analysis of dairy foods with a description of the main analytical techniques and methodologies and their application to the compounds involved in sensory, nutritional, and technological quality and safety.

This book contains 41 chapters. Part I (Chapters 1 through 12) focuses on the analysis of the main chemical and biochemical compounds of dairy foods. Chapter 1 provides an introduction to the topics discussed in this book.

Part II (Chapters 13 through 22) describes the analysis of technological quality, including the use of noninvasive chemical and physical sensors to follow up the process, the analysis of the main ingredients and additives used for these types of products, and the progress of specific biochemical reactions and evolution of starter cultures of great importance for the final quality.

Part III (Chapters 23 through 26) deals with the analysis of nutrients in dairy foods, with some nutrients such as prebiotics and probiotics being particularly relevant to the modern diet.

Part IV (Chapters 27 through 29) is related to the sensory quality of the different dairy products and the description of the main analytical tools and most adequate methodologies to determine their color, texture, and flavor perception.

Finally, Part V (Chapters 30 through 41) is devoted to safety, especially to analytical tools for the detection of spoilage and pathogen microorganisms, allergens, adulterations, residues, and chemical toxic compounds, whether environmental, generated, or intentionally added, that can be found in these foods.

This book provides a complete overview of the analytical tools available for all kinds of analyses of dairy foods; the roles of these techniques; and the methodologies for the analysis of technological, nutritional, and sensory quality as well as of safety aspects. In short, the book discusses and compiles the main types of analytical techniques and methodologies available worldwide for the analysis of a wide variety of dairy foods.

The editors thank all the contributors for their outstanding work. Their achievements are very much appreciated.

**Leo M.L. Nollet**  
**Fidel Toldrá**



---

# Editors

---

**Leo M.L. Nollet** is a professor of biochemistry, aquatic ecology, and ecotoxicology in the Department of Applied Engineering Sciences at the University College Ghent, and a member of the Ghent University Association, Ghent, Belgium. His main research interests are in the areas of food analysis, chromatography, and analysis of environmental parameters.

Nollet edited the first and second editions of *Food Analysis by HPLC* and *Handbook of Food Analysis* for Marcel Dekker, New York—now CRC Press of Taylor & Francis Group. The last edition was a three-volume book. He also edited the third edition of *Handbook of Water Analysis, Chromatographic Analysis of the Environment* (CRC Press) and the second edition of *Handbook of Water Analysis* (CRC Press) in 2007. He coedited two books with F. Toldrá in 2006 and 2007, respectively: *Advanced Technologies for Meat Processing* (CRC Press) and *Advances in Food Diagnostics* (Blackwell Publishing). He coedited *Radionuclide Concentrations in Foods and the Environment* with M. Pöschl, which was also published in 2006 (CRC Press).

Nollet has been coediting the following books with Y. H. Hui and other colleagues: *Handbook of Food Product Manufacturing* (Wiley, 2007); *Handbook of Food Science, Technology and Engineering* (CRC Press, 2005); and *Food Biochemistry and Food Processing* (Blackwell Publishing, 2005). Finally, he also edited *Handbook of Meat, Poultry and Seafood Quality* (Blackwell Publishing, 2007).

Nollet is currently working on the following six books on analysis methodologies for foods of animal origin with F. Toldrá (to be published by CRC Press):

*Handbook of Muscle Foods Analysis*  
*Handbook of Processed Meats and Poultry Analysis*  
*Handbook of Seafood and Seafood Products Analysis*  
*Handbook of Dairy Foods Analysis*  
*Handbook of Analysis of Edible Animal By-Products*  
*Handbook of Analysis of Active Compounds in Functional Foods*

He is also working on the book *Food Allergens: Analysis, Instrumentation, and Methods* with A. Van Hengel, which is to be published in 2010 by CRC Press. He received his MS (1973) and PhD (1978) in biology from the Katholieke Universiteit Leuven, Leuven, Belgium.

**Dr. Fidel Toldrá**, PhD, is a research professor in the Department of Food Science at Instituto de Agroquímica y Tecnología de Alimentos (CSIC) and serves as European editor of *Trends in Food Science & Technology*, as the editor-in-chief of *Current Nutrition & Food Science*, and as a member of the CEF Panel at the European Food Safety Authority. He is also a member of the editorial boards

of nine journals including *Food Chemistry*, *Meat Science*, *Food Analytical Methods*, and *Journal of Muscle Foods* among others. In recent years, he has acted as an editor or associate editor of several books. He is the editor of *Research Advances in the Quality of Meat and Meat Products* (Research Signpost, 2002) and an associate editor of the *Handbook of Food and Beverage Fermentation Technology* and the *Handbook of Food Science, Technology and Engineering* published in 2004 and 2006, respectively, by CRC Press. He coedited two books with L. Nollet that were published in 2006 and 2007, respectively: *Advanced Technologies for Meat Processing* (CRC Press) and *Advances in Food Diagnostics* (Blackwell Publishing). Both Toldrá and Nollet are also associate editors of the *Handbook of Food Product Manufacturing*, published by John Wiley & Sons in 2007. Professor Toldrá has edited *Safety of Meat and Processed Meat* (Springer) in 2009 and has also written *Dry-Cured Meat Products* published by Food & Nutrition Press (now Wiley-Blackwell) in 2002.

He has worked on the following six books on analysis methodologies for foods of animal origin with L. Nollet (to be published by CRC Press):

*Handbook of Muscle Foods Analysis*  
*Handbook of Processed Meats and Poultry Analysis*  
*Handbook of Seafood and Seafood Products Analysis*  
*Handbook of Dairy Foods Analysis*  
*Handbook of Analysis of Edible Animal By-Products*  
*Handbook of Analysis of Active Compounds in Functional Foods*

Dr. Toldrá was awarded the 2002 International Prize for meat science and technology by the International Meat Secretariat and was elected as a Fellow of the International Academy of Food Science & Technology in 2008 and a Fellow of the Institute of Food Technologists in 2009.

---

# Contributors

---

**Nóra Adányi**

Unit of Analytics  
Central Food Research Institute  
Budapest, Hungary

**Amparo Alegría**

Nutrition and Food Chemistry  
Faculty of Pharmacy  
University of Valencia  
Burjassot, Spain

**Miguel A. Alvarez**

Instituto de Productos Lácteos de Asturias  
Consejo Superior de Investigaciones  
Científicas  
Villaviciosa, Spain

**M. Concepción Aristoy**

Instituto de Agroquímica y Tecnología de  
Alimentos  
Consejo Superior de Investigaciones  
Científicas  
Burjassot, Spain

**N. Bansal**

California Polytechnic State University  
San Luis Obispo, California

**Reyes Barberá**

Nutrition and Food Chemistry  
Faculty of Pharmacy  
University of Valencia  
Burjassot, Spain

**Sara Bogialli**

Dipartimento di Chimica  
Università La Sapienza  
Rome, Italy

**Emma L. Bradley**

Food and Environment Research Agency  
York, United Kingdom

**Maria G. E. G. Bremer**

RIKILT—Institute of Food Safety  
Wageningen University and Research Centre  
Wageningen, the Netherlands

**Xu-Liang Cao**

Food Research Division  
Health Canada  
Ottawa, Ontario, Canada

**Laurence Castle**

Food and Environment Research Agency  
York, United Kingdom

**Valeria Cavatorta**

Department of Organic and Industrial  
Chemistry  
University of Parma  
Parma, Italy

**Nathalie Cayot**

UMR 1129 FLAVIC  
AgroSup Dijon-INRA-UB  
Dijon, France

**Nigel Cook**

Food and Environment Research Agency  
York, United Kingdom

**Nieves Corzo**

Instituto de Fermentaciones Industriales  
Consejo Superior de Investigaciones  
Científicas  
Madrid, Spain

**Martin D'Agostino**

Food and Environment Research Agency  
York, United Kingdom

**Małgorzata Darewicz**

Department of Food Biochemistry  
University Warmia and Mazury in Olsztyn  
Olsztyn, Poland

**Miguel Angel de la Fuente**

Department of Dairy Products  
Instituto del Frío  
Consejo Superior de Investigaciones  
Científicas  
Madrid, Spain

**Beatriz del Rio**

Instituto de Productos Lácteos de Asturias  
Consejo Superior de Investigaciones  
Científicas  
Villaviciosa, Spain

**Koen Dewettinck**

Laboratory of Food Technology and  
Engineering  
Department of Food Safety and Food Quality  
Faculty of Bioscience Engineering  
Ghent University  
Gent, Belgium

**Antonio Di Corcia**

Dipartimento di Chimica  
Università La Sapienza  
Rome, Italy

**Vlastimil Dohnal**

Department of Food Technology  
Mendel University of Agriculture  
and Forestry Brno  
Brno, Czech Republic

**Laurent Dufossé**

Laboratoire de Chimie des Substances  
Naturelles et des Sciences des Aliments  
Ecole Supérieure d'Ingénieurs en  
Développement Agroalimentaire Intégré  
Université de la Réunion  
Sainte-Clotilde, France

**Giovanni Dugo**

Dipartimento Farmaco-chimico  
Facoltà di Farmacia  
Università di Messina  
Messina, Italy

**Paola Dugo**

Dipartimento Farmaco-chimico  
Facoltà di Farmacia  
Università di Messina  
Messina, Italy

**Bartłomiej Dziuba**

Department of Industrial and Food  
Microbiology  
University Warmia and Mazury in Olsztyn  
Olsztyn, Poland

**Jerzy Dziuba**

Department of Food Biochemistry  
University Warmia and Mazury in Olsztyn  
Olsztyn, Poland

**Colette C. Fagan**

Biosystems Engineering  
Food Science and Veterinary Medicine  
School of Agriculture  
University College Dublin  
Dublin, Ireland

**Rosaura Farré**

Nutrition and Food Chemistry  
Faculty of Pharmacy  
University of Valencia  
Burjassot, Spain

**Javier Fontecha**

Department of Dairy Products  
 Instituto Del Frío  
 Consejo Superior de Investigaciones  
 Científicas  
 Madrid, Spain

**Patrick F. Fox**

Department of Food and Nutritional Sciences  
 University College Cork  
 Cork, Ireland

**Rob Frankhuizen**

RIKILT—Institute of Food Safety  
 Wageningen University and Research Centre  
 Wageningen, the Netherlands

**Patrick Galaup**

Laboratoire ANTiOX  
 Université de Bretagne Occidentale  
 Quimper, France

**Ana M. Gomes**

Escola Superior de Biotecnologia  
 Universidade Católica Portuguesa  
 Oporto, Portugal

**Zehra Güler**

Department of Food Engineering  
 Faculty of Agriculture  
 Mustafa Kemal University  
 Hatay, Turkey

**Marta Hernández**

Laboratory of Molecular Biology and  
 Microbiology  
 Instituto Tecnológico Agrario de  
 Castilla y León  
 Valladolid, Spain

**Isabel Hernando**

Departamento de Tecnología de Alimentos  
 Universidad Politécnica de Valencia  
 Valencia, Spain

**Olivier Heudi**

Novartis Pharma  
 Basel, Switzerland

**Manuela Juárez**

Department of Dairy Products  
 Instituto del Frío  
 Consejo Superior de Investigaciones  
 Científicas  
 Madrid, Spain

**Romdhane Karoui**

Unité de Recherche Typicité des Produits  
 Alimentaires  
 ENITA de Clermont Ferrand  
 Lempdes, France

**Chinnadurai Karunanithy**

Agricultural and Biosystems Engineering  
 South Dakota State University  
 Brookings, South Dakota

**Kieran Kilcawley**

Teagasc  
 Moorepark Food Research Centre  
 Fermoy, Cork, Ireland

**Tomáš Komprda**

Department of Food Technology  
 Mendel University of Agriculture  
 and Forestry Brno  
 Brno, Czech Republic

**Victor Ladero**

Instituto de Productos Lácteos de Asturias  
 Consejo Superior de Investigaciones  
 Científicas  
 Villaviciosa, Spain

**María Jesús Lagarda**

Nutrition and Food Chemistry  
 Faculty of Pharmacy  
 University of Valencia  
 Burjassot, Spain

**María-Angeles Lluch**

Departamento de Tecnología de Alimentos  
 Universidad Politécnica de Valencia  
 Valencia, Spain



**Rosina López-Fandiño**

Instituto de Fermentaciones Industriales  
Consejo Superior de Investigaciones  
Científicas  
Madrid, Spain

**Alfonso H. Magadán**

Instituto de Productos Lácteos de Asturias  
Consejo Superior de Investigaciones  
Científicas  
Villaviciosa, Spain

**F. Xavier Malcata**

Escola Superior de Biotecnologia  
Universidade Católica Portuguesa  
Oporto, Portugal

**Jordi Mañes**

Laboratory of Food Chemistry and Toxicology  
Faculty of Pharmacy  
University of Valencia  
Burjassot, Spain

**Rosangela Marchelli**

Department of Organic and Industrial  
Chemistry  
University of Parma  
Parma, Italy

**M. Cruz Martín**

Instituto de Productos Lácteos de Asturias  
Consejo Superior de Investigaciones  
Científicas  
Villaviciosa, Spain

**Noelia Martínez**

Instituto de Productos Lácteos de Asturias  
Consejo Superior de Investigaciones  
Científicas  
Villaviciosa, Spain

**Isabel Martínez-Castro**

Instituto de Química Orgánica General  
Consejo Superior de Investigaciones  
Científicas  
Madrid, Spain

**Paul L. H. McSweeney**

Department of Food and Nutritional Sciences  
University College Cork  
Cork, Ireland

**Lloyd E. Metzger**

Dairy Science Department  
South Dakota State University  
Brookings, South Dakota

**Piotr Minkiewicz**

Department of Food Biochemistry  
University Warmia and Mazury in Olsztyn  
Olsztyn, Poland

**Golfo Moatsou**

Laboratory of Dairy Research  
Department of Food Science and Technology  
Agricultural University of Athens  
Athens, Greece

**Luigi Mondello**

Dipartimento Farmaco-chimico  
Facoltà di Farmacia  
Università di Messina  
Messina, Italy

**K. C. Mountzouris**

Department of Nutritional Physiology and  
Feeding  
Agricultural University of Athens  
Athens, Greece

**Kasiviswanathan Muthukumarappan**

Agricultural and Biosystems Engineering  
South Dakota State University  
Brookings, South Dakota

**Colm P. O'Donnell**

Biosystems Engineering  
Food Science and Veterinary Medicine  
School of Agriculture  
University College Dublin  
Dublin, Ireland

**Agustín Olano**

Instituto de Fermentaciones Industriales  
Consejo Superior de Investigaciones  
Científicas  
Madrid, Spain

**Young W. Park**

Georgia Small Ruminant Research &  
Extension Center  
Fort Valley State University  
Fort Valley, Georgia

**Carmen Peláez**

Department of Dairy Science and Technology  
Instituto del Frío  
Consejo Superior de Investigaciones  
Científicas  
Madrid, Spain

**Gaspar Pérez-Martínez**

Instituto de Agroquímica y Tecnología de  
Alimentos  
Consejo Superior de Investigaciones  
Científicas  
Valencia, Spain

**Isabel Pérez-Munuera**

Departamento de Tecnología de Alimentos  
Universidad Politécnica de Valencia  
Valencia, Spain

**Susan P. Phillips**

Departments of Family Medicine and  
Community Health and Epidemiology  
Queen's University  
Kingston, Ontario, Canada

**Manuela E. Pintado**

Escola Superior de Biotecnologia  
Universidade Católica Portuguesa  
Oporto, Portugal

**P. Piraino**

Paolo Piraino Statistical Consulting  
Rende, Italy

**Amparo Quiles**

Departamento de Tecnología de Alimentos  
Universidad Politécnica de Valencia  
Valencia, Spain

**Isidra Recio**

Instituto de Fermentaciones Industriales  
Consejo Superior de Investigaciones  
Científicas  
Madrid, Spain

**Teresa Requena**

Department of Dairy Science and Technology  
Instituto del Frío  
Consejo Superior de Investigaciones  
Científicas  
Madrid, Spain

**David Rodríguez-Lázaro**

Food Safety and Technology Research Group  
Instituto Tecnológico Agrario de  
Castilla y León  
Valladolid, Spain

**Roeland Rombaut**

Laboratory of Food Technology and  
Engineering  
Department of Food Safety and Food Quality  
Faculty of Bioscience Engineering  
Ghent University  
Gent, Belgium

**Stefano Sforza**

Department of Organic and Industrial  
Chemistry  
University of Parma  
Parma, Italy

**Carla Soler**

Laboratory of Food Technology  
Faculty of Pharmacy  
University of Valencia  
Burjassot, Spain

**José Miguel Soriano**

Laboratory of Food Chemistry and Toxicology  
Faculty of Pharmacy  
University of Valencia  
Burjassot, Spain

**Fidel Toldrá**

Instituto de Agroquímica y Tecnología de  
Alimentos  
Consejo Superior de Investigaciones  
Científicas  
Burjassot, Spain

**Virginie Tregoat**

European Commission  
Joint Research Centre  
Institute for Reference Materials and  
Measurements  
Geel, Belgium

**Effie Tsakalidou**

Department of Food Science and Technology  
Agricultural University of Athens  
Athens, Greece

**P. Tsirtsikos**

Department of Nutritional Physiology and  
Feeding  
Agricultural University of Athens  
Athens, Greece

**Maria Cristina Dantas Vanetti**

Department of Microbiology  
Federal University of Vicosa  
Vicosa, Brazil

**Arjon J. van Hengel**

European Commission  
Joint Research Centre  
Institute for Reference Materials and  
Measurements  
Geel, Belgium

**Saskia M. van Ruth**

RIKILT—Institute of Food Safety  
Wageningen University and Research Centre  
Wageningen, the Netherlands

**Jian Wang**

Canadian Food Inspection Agency  
Calgary Laboratory  
Calgary, Alberta, Canada

**Ilex Whiting**

Food and Environment Research Agency  
York, United Kingdom

**Barbara d'Acampora Zellner**

Dipartimento Farmaco-chimico  
Facoltà di Farmacia  
Università di Messina  
Messina, Italy

**Huimin Zhang**

Dairy Science Department  
South Dakota State University  
Brookings, South Dakota

**Jiping Zhu**

Exposure and Biomonitoring Division  
Health Canada  
Ottawa, Ontario, Canada

---

# **CHEMISTRY AND BIOCHEMISTRY**

---

**I**



# *Chapter 1*

---

# **Introduction to Analysis in the Dairy Industry**

---

Patrick F. Fox

## **CONTENT**

Reference .....	8
-----------------	---

Basically, foods are very complex chemical systems and are not merely sources of chemicals. Most commodities, e.g., drugs, fuels, metals, glass, ceramics, textiles, and paper, consist of one or a few chemicals, but most natural foods contain hundreds of compounds and their characteristics may be due to micro- rather than macroconstituents. Many of a food's constituents interact chemically, physically, and sensorially during the processing, storage, and ingestion of the food, the results of which dominate the physical and organoleptic properties of the food. Foods are unstable systems being susceptible to biological, chemical, and physical deterioration, and act as vectors for pathogenic and food-poisoning microorganisms and of indigenous or contaminating toxins or antinutrients. The primary function of foods is to supply all macro- and micronutrients in adequate and balanced amounts, but for most people, especially those in developed societies, who consume adequate or even excessive amounts of nutrients, the organoleptic aspects and safety of foods are most important. Food safety is of utmost importance and in this respect, at least three aspects are important: (1) freedom from indigenous, endogenous, and exogenous toxins and other contaminants, (2) freedom from pathogenic and food-poisoning microorganisms, and (3) balance of nutrients.

Food analysis is important for at least the following reasons:

1. To ensure compliance with local and international standards.
2. To provide information about the concentrations of nutrients, which is useful for consumer education on dietary matters.
3. To ensure freedom from toxins and antinutrients.
4. To ensure freedom from pathogenic and food-poisoning bacteria.
5. To assess the physicochemical attributes of foods and food ingredients, e.g., rheological properties, texture, and color.
6. To evaluate the sensoric properties, e.g., flavor, aroma, texture, and color.
7. To protect against fraud, e.g., the addition of water to milk, substitution of cheaper or inferior ingredients for milk constituents, or the use of bovine milk for more expensive caprine or ovine milk in certain products.
8. To assess the shelf-life of products.
9. To enable manufacturers to maximize product yield or optimize the functionality of food ingredients.
10. To assess the thermal history of a product or the health of the producing animal.
11. In the research on foods, food products, or food ingredients.

Research on all aspects of food science and technology, viz., chemical, physical, and biological, requires/depends on the application of analytical techniques.

Considering the complexity of foods and the wide range of physical, chemical, and biological properties to be assessed, it is not surprising that a very wide range of analytical principles have been used in food analysis; in fact, nearly all analytical principles have been applied very promptly in food analysis and some have originated from Food Science laboratories. These techniques range from relatively simple methods for the determination of gross composition to highly sophisticated methods used mainly in research laboratories. Some methods have been developed specifically for the analysis of foods, in general, or dairy products, in particular; others are general analytical methods that have been modified for application to foods in general or specifically. In certain circumstances, it is necessary to analyze large numbers of samples quickly, accurately, and cheaply, e.g., farm milk supplies, to achieve which automated methods have been developed. In many cases, it is desirable to obtain the result of the analysis in real time, which can be achieved by measuring some physical property in-line, e.g., by some form of spectroscopy or by conductimetric methods.

Milk secretion is the characteristic feature of all 4500 species of mammals for nourishing their young. Man has used the milk of other species, especially cattle, buffalo, sheep, and goats, and to a lesser extent from five or six other species, as a source of nutrients. In developed countries today, essentially all milk is processed to at least some extent and much of it serves as a raw material for the production of a wide range of products—milk is a very flexible raw material, which when subjected to one of several processing operations can be converted into unique new foods; dairy products are probably the most diverse of all food groups. Each of these types of food has its own unique properties and hence requires the application of specific analytical methods.

Foods became items of commerce several thousand years ago and since then have been the subject of some form of quality control. Laws controlling the manufacture and sale of foods have existed since Roman times. The first food legislation in England was the *Assize of Bread*, enacted in AD 1266 during the reign of Edward III, which fixed the weights and prices of bread. Bread sellers were sent to the streets with a “Baker’s Dozen” to ensure compliance with regulations; the 13th loaf was the commission for the seller or given to inspectors if the bread was found to be underweight. The Assizes of Bread were in force until the nineteenth century.

The adulteration of foods, frequently with very toxic materials, was widespread up to the end of the nineteenth century [1]. This practice was exposed through the work of Frederick Accum, Thomas Wakley (founder of *The Lancet*), and Arthur Hassall and led to a series of Acts to prevent it [Food Adulteration Act, 1860 (revised in 1862); Sale of Food & Drugs Act, 1875]. The Society of Public Analysts was founded in 1874, with Hassall as its first President; each county in the United Kingdom was required to appoint at least one Public Analyst. It is fair to state that food analysis seriously commenced with the enactment of the Sale of Food & Drugs Act, 1875 and the appointment of Public Analysts.

Industrialization of the dairy industry occurred rapidly following the development of the mechanical separator by Gustav de Laval in 1878 and created the requirement for easy and rapid methods for the determination of the fat content of milk as a basis for payment by creameries. The first method for the determination of fat in foods (and tissues) was developed by Franz von Soxhlet in 1879 (he also proposed the pasteurization of milk, in 1886). Since the Soxhlet method is not applicable to liquid samples, including milk, a modified ether-extraction method was developed by B. Roese in 1884 and modified by E. Gottlieb in 1892, which is still the standard method for the determination of the fat content of milk and dairy products. The Roese–Gottlieb method is slow and not suitable for the analysis of large numbers of samples, such as at creameries. Three principles were used in such situations: (1) the amount of butter produced from a representative sample of milk or cream, (2) the volume of cream formed in a sample of milk under standard conditions, or (3) the volume of fat released on dissolving the milk protein and destabilizing the fat emulsion initially by concentrated NaOH, which was soon replaced by concentrated H<sub>2</sub>SO<sub>4</sub>, as used in the methods developed by N. Gerber and S.M. Babcock around 1890. Other early methods for the quantitative analysis of milk were the use of the lactometer for the determination of the specific gravity of milk, from which the total solids content of milk could be calculated by using empirical formulae, by Theodore Auguste Quevenne (1805–1885) around 1840 and for the determination of nitrogen, and hence protein, by Jean Baptiste Dumas in 1833 and Johann Kjeldahl in 1873. These methods are still used; in fact, the Roese–Gottlieb and Kjeldahl methods are the reference methods for the determination of concentration of fat and protein in milk and dairy products, although they have been replaced by more rapid methods, based on infrared spectroscopy, for routine use.

During the twentieth century, a progression of increasingly more sophisticated techniques for the compositional analysis of foods and the characterization of food constituents were developed. Depending on the objective, any one of several analytical principles and almost all physical, chemical, biological, microbiological, and sensory/organoleptic methods may be used in food analysis. Some methods have been developed specifically for food analysis, but most are generally applicable methods, modified, if necessary, for application to foods. Some methods are used in food factory laboratories for quality control/assurance of the product or process, others are used primarily in industrial or academic/institutional laboratories to characterize the composition, properties, and functionality of foods and food constituents.

The gross composition (proximate analysis) of foods is of fundamental importance to manufacturers, consumers, and regulatory authorities. In certain cases/situations, more detailed information on composition is required, e.g., for nutritional purposes, product safety, or product authentication.

For nutritional, toxicological and, in some cases, technological reasons, it is necessary to quantify the inorganic elements in foods, which can be done by colorimetric, titrimetric, or polarographic methods for some elements but is usually done by some form of atomic absorption spectroscopy. There are at least 30 inorganic elements (at a macro- or microlevel) in milk; some of these elements are important for technological reasons, mostly for nutritional reasons, but some trace elements, present as contaminants, are extremely toxic.



The authentication of foods is very important for the avoidance of fraudulent practices; as mentioned above, this was the principal reason for introducing food legislation in the nineteenth century. Important examples of adulteration in the dairy industry are: addition of water to milk (detected and quantified by the elevation of freezing point), adulteration of butter with cheaper vegetable fats (detected and quantified by partial or complete fatty acid analysis), or adulteration of sheep, goat, or buffalo milk with cheaper bovine milk (accomplished by gas chromatography [GC], polyacrylamide gel electrophoresis, immunological principles, or molecular biology techniques). A recent challenge in the area of food adulteration is the detection of genetically modified organisms (GMOs) or the products of GMOs in foods, a practice prohibited in many countries; this is best accomplished by using molecular biology techniques in involving a polymerized chain reaction (PCR).

Since the late nineteenth century, there has been an incentive to characterize the macro- and microconstituents of foods, including milk; this has necessitated the isolation and purification of the constituents to homogeneity. Various chemical methods based on differential solubility were developed initially, but these have been replaced by various forms of chromatography (adsorption, ion exchange, size exclusion, hydrophobic, affinity, gas–liquid, liquid–liquid, etc.). Preparative electrophoresis, including electroblotting, is very useful for the small-scale isolation of proteins.

A very wide range of characterization techniques have been used. The classical techniques of organic chemistry for elemental analysis, functional group determination, mass determination, and infrared spectroscopy have been used to characterize molecular weight (MW) compounds, e.g., sugars, lipids, amino acids, and vitamins. Various forms of chromatography have been used to identify unknown compounds by comparison with known standards. Electrophoresis may also be useful, especially immunoelectrophoresis. Initially, mass spectrometry was used mainly to identify low MW, volatile compounds, usually in GC eluates, but mass spectrometers are now available, which can be used to determine the mass of very large molecules, including proteins.

The principal constituents of most foods are macromolecules, lipids, polysaccharides, and proteins. Characterization of these involves identification of the constituent molecular units and bonds by which they are polymerized. In the case of proteins, the amino acid composition, and the sequence of amino acids (primary structure) are key characteristics and are now determined routinely by chromatographic methods. Depending on the primary structure, polypeptides adopt specific secondary, tertiary, and quaternary structures (conformations). These higher structures determine the functionality and overall properties of a protein and are characterized by techniques such as circular dichroism, optical rotary dispersion, viscosity, and light scattering. Many food-processing operations alter these native structures (i.e., cause denaturation) and alter the physicochemical properties of the protein. Quantifying the extent of protein denaturation is a fairly routine procedure in food analysis and can be assessed by changes in solubility, optical or biological properties.

Many important properties of foods involve phase transitions from liquid to solid or *vice versa*, involving crystallization or gelation of polysaccharides or proteins, which may be monitored by various forms of rheology. Other important functional properties are related to surface activity (i.e., emulsification or foaming) or water binding. Gelation and/or surface activity are particularly important properties of polysaccharides or proteins used as food ingredients. Among dairy products, cheese has some rather unique properties, e.g., meltability, stretchability, and flowability; specific tests have been developed to assess these properties.

Indigenous, endogenous, or exogenous enzymes play very important roles in food processing, quality, and stability. Milk contains about 70 indigenous enzymes, some of which may cause spoilage, e.g., lipoprotein lipase and plasmin; some have antibacterial properties, e.g., lysozyme,

lactoperoxidase, or xanthine oxidoreductase; some serve as markers of mastitis, and hence of quality, e.g., *N*-acetylglucosaminidase; some serve as markers of heat treatment, and hence of safety or quality, e.g., alkaline phosphatase, lactoperoxidase,  $\gamma$ -glutamylpeptidase, and catalase. Therefore, the isolation, characterization, and quantitation of indigenous enzymes in milk has been an important activity for more than 100 years. Today, several standardized and automated colorimetric or fluorometric assay methods are used routinely.

Microorganisms (bacteria, yeasts, and molds) that grow in milk or on dairy products secrete extracellular enzymes, through the action of which they convert high molecular mass materials into smaller molecules that can be transported into the cell, where they are catabolized for the production of energy or used for the synthesis of cellular constituents. From the perspective of a Dairy Technologist, these enzymes may cause extensive damage and spoilage, e.g., liquefaction, gelation, or off-flavors (due to lipolysis or proteolysis). However, if properly controlled, these changes may be desirable, e.g., in the ripening of cheese.

Most dairy-related microorganisms do not secrete extracellular enzymes, but their intracellular enzymes are released following the death and lysis of the cell and may cause spoilage or desirable changes, e.g., the significance of lactic acid bacteria in cheese ripening.

The isolation and characterization of intra- and extracellular enzymes of dairy-related microorganisms is an important aspect of Dairy Science/Technology and such work requires the application of a wide range of analytical techniques.

A small number of exogenous enzymes are used in dairy technology, where they play important, and in some cases, essential roles. The most important exogenous enzymes in dairy technology are rennets (selected proteinases), which are essential in the manufacture of rennet-coagulated cheeses (~75% of all cheese) and rennet casein, an important food ingredient. The use of rennets in cheese-making is the largest single use of an enzyme in food processing, and the use of rennets produced by GMOs was one of the first applications of a GMO for the production of a food ingredient. Other significant exogenous enzymes are other proteinases (for the production of protein hydrolysates for dietary or pharmaceutical applications), lipases (in the manufacture of certain cheeses or modification of the structure and physical properties of lipids), and  $\beta$ -galactosidase (lactase; for the hydrolysis or structural rearrangement of lactose). Enzymes with minor applications include catalase, lactoperoxidase, and glucose oxidase.

The analysis of enzyme preparations used in food/milk processing is very important to ensure that they are of the type required, that their activity is of the required/specified type and strength, that they are free of contaminating enzyme activities, which may cause undesirable side effects in the product, and that they are free of undesirable microorganisms and other contaminants.

Milk is a very good substrate for the growth of many types of bacteria, which may cause spoilage; it may also serve as a vector of pathogenic bacteria originating from the dairy animals or from farm or factory personnel. Therefore, the enumeration and characterization of the total or selected microflora of milk or milk products have been standard procedures for more than 100 years. Until recently, these analyses involved growth on general or selective media, sometimes after enrichment, or measurement of an intermediate or terminal product, e.g., ATP or lactic acid, or the consumption of oxygen. Today, molecular biology techniques are widely used for the selective enumeration of bacteria. In factories that produce cheese or fermented milk products, the growth rate of bacteria is very important and routine monitoring of inhibitors or bacteriophage is a common practice.

For most consumers, the ultimate criteria of food quality are its sensoric properties, color/appearance, flavor (aroma/taste), and texture. These properties can be assessed subjectively using a trained or untrained taste panel in-house or at dedicated laboratories; probably all food producers

engage in some form of sensoric assessment of their products, and this work may become highly scientific with large food processors or food marketing companies. An important aspect of sensory analysis involves comparison of a company's products with those of its competitors. Trained taste panels are subjective, expensive to operate, and limited as to the number of samples they can assess at one sitting. Consequently, attempts have been made for at least 50 years to develop objective methods for quantifying food flavor, more usually food aroma, by analyzing the volatiles released from a food sample; this has become increasingly sophisticated over time and has involved GC, GC-MS, olfactory-GC (GCO), proton transfer reaction-mass spectrometry (PTR-MS), the electronic nose, etc. Color may be quantified relatively easily using colorimeters and various aspects of texture may be quantified by rheological methods integrated as texture profile analysis (TPA), using conditions that simulate the mastication of a piece of food in the mouth; such objective measurements of food texture are essentially confined to research laboratories. Food producers usually rely on subjective assessment of food texture by trained or untrained panellists.

In addition to the above more or less widely applicable analytical methods, there are numerous specific methods that are used only in certain cases. Examples of such methods are the assessment of digestibility *in vivo* or by *in vitro* methods that simulate *in vivo* digestion; toxicity testing *in vivo* or using tissue cultures and assessing the nutritional quality of proteins by *in vivo* feeding trials.

It will be evident that foods are subjected to a wide variety of analytical procedures for various reasons. A food sample is very rarely subjected to the full range of analyses; the analytical methods used depend on the objective of the investigation. In the following chapters, the principal analytical methods applied to foods will be described.

## Reference

1. Coley, N. 2005. The fight against food adulteration, *Education in Chemistry*, March, 46–49.

## Chapter 2

---

# Amino Acids in Dairy Foods

---

M. Concepción Aristoy and Fidel Toldrá

### CONTENTS

2.1	Introduction.....	9
2.2	Sample Preparation.....	12
2.2.1	Sample Preparation for Free Amino Acid Analysis.....	12
2.2.2	Sample Preparation for Total or Hydrolyzed Amino Acid Analysis .....	13
2.2.2.1	Acid Hydrolysis.....	13
2.2.2.2	Alkaline Hydrolysis .....	14
2.2.2.3	Enzymatic Hydrolysis.....	14
2.3	Amino Acid Analysis .....	15
2.3.1	Analysis of the Whole Amino Acid Content .....	15
2.3.2	Analysis of the Amino Acid Profile .....	15
2.3.2.1	High-Performance Liquid Chromatography .....	15
2.3.2.2	Gas–Liquid Chromatography .....	19
2.3.2.3	Capillary Zone Electrophoresis.....	21
2.4	Special Analysis .....	21
2.4.1	Lysine .....	21
2.4.2	Tryptophan .....	23
	References.....	23

### 2.1 Introduction

Amino acids constitute important compounds for the formation and maintenance of the body tissues. Among them, eight amino acids must be supplied in the diet because they cannot be synthesized in enough amounts inside the organism. These amino acids, which are known as

essential amino acids, are threonine, methionine, valine, isoleucine, leucine, phenylalanine, lysine, and tryptophan. Other amino acids are considered “conditionally essential.” This is the case of histidine, which is essential only during childhood, or tyrosine and cysteine, which are only synthesized from the essential amino acids phenylalanine and methionine, respectively. In general, foods of animal origin are very rich in essential amino acids and analytical technologies have been recently reported for muscle foods [1], meat products [2], and seafoods [3].

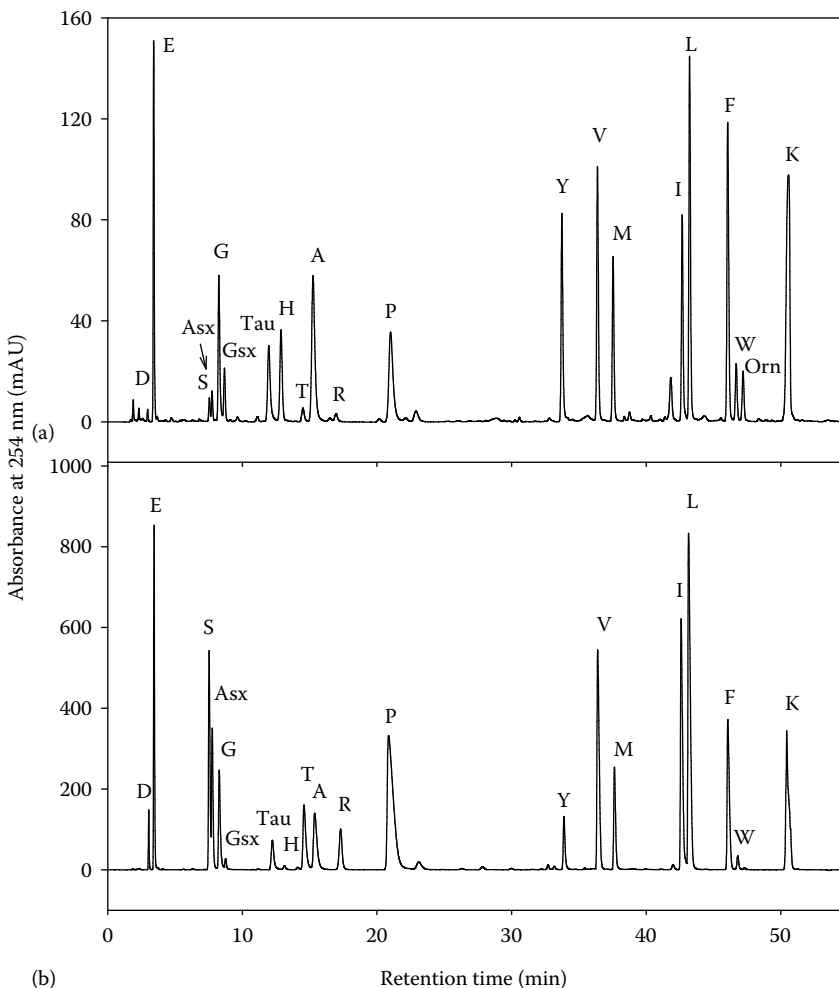
Amino acids may be found free or forming part of proteins in foods. Free amino acids fall within the nonprotein nitrogen (NPN) fraction of milk, which also includes peptides, urea, uric acid, ammonia, creatine, nucleic acids, amino sugars, and other compounds [4]. Free amino acids’ profile from milk depends on the origin species [5,6], but in general, the major amino acid is glutamic acid. The main difference is taurine, considered as “conditionally essential” in infant nutrition [6,7], which is especially abundant in human milk in comparison with cow’s milk. Heat treatments of milk affect its content in essential and nonessential free amino acids [8,9].

Milk and dairy products are considered good sources of high-quality dietary protein for humans because of the balanced amino acids content of its proteins. Indeed, casein, the major milk protein, was proposed by the FDA as the standard when expressing the percentage of reference daily intake (RDI) that a food protein source supplies, and also serves as a reference to calculate the protein efficiency ratio (PER). Milk composition depends on the origin, but casein is always the major protein. Casein is a phosphoprotein that accounts for nearly 80% of proteins in milk, provides calcium and phosphate and contains equalized amino acids except cysteine, a conditionally essential amino acid, which is the rate-limiting factor for the body’s production of glutathione, an important antioxidant. The rest of the proteins (20%) are whey proteins, which include a collection of globular proteins, mainly  $\beta$ -lactoglobulin (~65%),  $\alpha$ -lactalbumin (~25%), and serum albumin (~8%), which are soluble in their native forms, independent of pH. Whey has the highest biological value (BV) in comparison with any known protein, but can be denatured by heat. High heating (i.e., the high temperatures above 72°C, associated with the pasteurization process) denatures whey proteins, destroying some bioactive compounds, such as the amino acids cysteine and tryptophan. Nevertheless, undenatured whey proteins constitute a good source of cysteine. Lysine is a dietary essential amino acid that is sometimes problematic because it may be the first limit in diets for humans, particularly in diets rich in cereals. Generally, milk proteins contain high amounts of lysine, but this essential amino acid is susceptible to be blocked during heat treatments or prolonged storage, diminishing its nutritive value. Several methods to determine “chemically available” lysine like the 1-fluoro-2,4-dinitrobenzene (FDNB) or the furosine methods among others have been proposed [10–12] and will be described later.

Among the dairy products, cheese is the largest contributor to the amount of protein available in the food supply. The composition of milk proteins changes along cheese making as a result of separation of the curd from the whey, and ripening or curing of cheese. So, the proportion of protein from cheese may increase to more than fivefold. Casein is also the main protein in cheese, although the water-soluble milk proteins lactalbumin and lactoglobulin may also be present depending on the amount of whey entrapped in the cheese. Ripening also influences the nutrient content of cheese, although it does not imply a loss in the nutritive value. Main changes lead to the development of the sensory characteristics of cheese-like texture and flavor. Enzymes provided by starter cultures play an important role in flavor development [13–16]. Particularly, the enzyme degradation of proteins leads to the formation of flavor components, which contribute to the sensory perception of dairy products. More specifically, caseins are degraded into peptides and amino acids, which have been directly related to basic cheese taste [17] and the latter are precursors for volatile aroma compounds. In particular, the degradation of sulfur-containing amino acids,

methionine and cysteine, as well as the aromatic and the branched-chain amino acids, all of them essential, is crucial for cheese flavor development [18–22].

Others factors like the origin of the milk [23–25], the type of treatment (pasteurized, pressure-treated, or raw milk) [26–29], the method of coagulation of milk (enzyme- or acid-coagulated cheese), the starter used, and also the ripening in cheese making influence the extent of the proteolysis and the resulting compounds determine the characteristics, not only in flavor but also in texture of the final cheese [30]. In enzyme-coagulated soft cheeses (e.g., Camembert, Limburger), much of the protein is converted to water-soluble compounds, mainly peptides, but also amino acids and ammonia. The softness of these types of cheeses is due to the extensive solubilization of the proteins as well as to high moisture content of the cheese. In hard cheeses (e.g., Cheddar, Parmesan, Manchego, Swiss), an extense proteolysis with a high amino acid release occurs, much larger than in soft cheeses (see Figure 2.1). In acid-coagulated cheeses (e.g., cottage cheese), the



**Figure 2.1** Reversed phase HPLC chromatogram of free PITC-amino acids from (a) Camembert and (b) Parmesan cheeses.

proteolysis is not intense and, in some of them, like Ricotta or Queso Blanco, the three milk proteins, casein, lactoglobulin, and lactalbumin, are present in relevant amounts.

The analysis of amino acids in milk and dairy products may have different purposes like nutritive value after heat treatment (i.e., content of tryptophan, cysteine, and available lysine), markers of heat treatment or flavor development of cheese (influence of methionine, cysteine, the aromatic, and the branched-chain amino acids). General methods for food amino acid analysis are described elsewhere [31].

## 2.2 Sample Preparation

Sample preparation will depend on whether free or total amino acids have to be analyzed. Protocols for preparation for both cases are given below.

### 2.2.1 Sample Preparation for Free Amino Acid Analysis

Free amino acids are more easily absorbed by the organism than protein-derived amino acids and hence their nutritive value is highly appreciated, especially in the neonatal stage [32,33]. While liquid (milk) or semiliquid samples (yogurt) are readily deproteinized to separate the protein from the NPN fraction in which free amino acids are located, solid samples like cheese needs a previous extraction stage. Thus, cheese is usually grated and homogenized with water [34], HCl (i.e., 0.1 N) [35], or diluted buffers like citrate buffer [36,37], by using a Polytron™, Stomacher™, or Ultra-Turrax™ blenders. The obtained homogenate is filtered or centrifuged and the filtrate or the supernatant is deproteinized. Methods for deproteinization have been largely described [38–40] and include the protein precipitation with either organic solvents or strong acids (generally bulky anions), or ultrafiltration. Organic solvents cause precipitation of proteins by changing the solvation of the protein with water. The organic solvents used, acetone, methanol [6,41], ethanol, or acetonitrile [42], are miscible with water and their proportion is variable depending on the isoelectric point of proteins [43]. After removing the precipitated protein, the sample can be readily concentrated by evaporation. Bulky anions like 5-sulfosalicylic acid (SSA) [9,35,36], trichloroacetic acid (TCA) [35–37], and perchloric acid (PCA) [44] are the most used deproteinizing agents for milk or cheese analysis of free amino acids. Phosphotungstic acid (PTA)/sulfuric acid has been used to obtain an extract in which the whole free amino acids content in the cheese nonprotein fraction [45] is measured, but may lead to inexact results when analyzing individual amino acids because some of them, especially some essentials like lysine, may not be properly recovered in the obtained clean extract [38]. Both actions, extraction and deproteinization, may be achieved simultaneously by using 0.2–0.6 M HClO<sub>4</sub> as extracting–deproteinizing agent [46,47]. The neutralization of the supernatant may be required depending on the chosen subsequent analytical technique (see Section 2.3). Many authors have also used ultrafiltration through membranes with molecular weight cut-off of 1000 Da to isolate the cheese water-soluble fraction where the free amino acids are present [23,26,48]. The effect of some precipitants or filtrate membranes on the recovery of free amino acids from human plasma [49] or meat and meat products [38] have been investigated. An example of sample preparation for the analysis of free amino acids from cheese [47] is given: 10 g of cheese are dissolved in 40 mL of 0.6M PCA and homogenized in a Sorvall Omni-mixer for 2 min. The mixture is centrifuged at 10,000 × *g* for 5 min. The supernatant is filtered and its pH adjusted to 6.0–7.0 with 1 M potassium carbonate or hydroxide. After filtration, the solution is ready for analysis.

## 2.2.2 Sample Preparation for Total or Hydrolyzed Amino Acid Analysis

Sample preparation for the analysis of total amino acids includes the hydrolysis of proteins and peptides as a first step. Main hydrolysis methods are described below, but a quantitative hydrolysis may be difficult to achieve for some amino acids, so that cautions for those especially labile amino acids are pointed out.

### 2.2.2.1 Acid Hydrolysis

The knowledge of the total amino acids profile as an index of the nutritional value of milk and dairy products or the analysis of specific amino acids, which are part of milk peptides or proteins may be of interest. For both aims, proteins must be hydrolyzed into their constituent amino acids prior to the analysis. The most common method used for complete hydrolysis of proteins is acid digestion with hydrochloric or methanesulfonic acid. Preferably, conventional liquid- or gas-phase hydrolysis in constant boiling 6N hydrochloric acid is performed in an oven at 110°C for 23 h. Digestion at 145°C for 4 h has also been proposed [50–53]. The hydrolysis must be carried out in sealed vials under nitrogen or argon atmosphere and in the presence of antioxidants/scavengers to minimize the degradation suffered by some especially labile amino acids (tyrosine, threonine, serine, methionine, and tryptophan) in such acidic and oxidative medium. In conventional liquid-phase method, the hydrochloric acid contacts directly with the sample and is well suited to hydrolyze large amounts or complex samples. When limited amounts of sample are available, the vapor-phase hydrolysis method is preferred to minimize contaminants coming from aqueous 6N hydrochloric acid. In the vapor-phase hydrolysis method, the tubes containing the samples are located inside large vessels containing the acid. Upon heating, only the acid vapor comes into contact with the sample, thus excluding nonvolatile contaminants. In both cases, liquid phase or vapor phase, oxygen is removed and replaced by nitrogen or another inert gas, creating an appropriate atmosphere inside the vessels to assure low amino acid degradation. So, a system capable of alternative air evacuating/inert gas purging to get a correct inner deaeration is valuable [54,55]. Another alternative, once the inert gas has purged the sample, consists of closing the glass hydrolysis vial by melting its neck under vacuum. The use of microwave technology for the hydrolysis has been assayed by some authors [56–59]. Sample manipulation (sample evaporation to dryness, addition of constant boiling hydrochloric acid and additives, and performance under vacuum) is similar to that of a conventional oven, but the duration of the treatment is shorter (less than 20 min). Nevertheless, microwave radiation-induced hydrolysis was responsible for a higher degree of racemization of the residues, in particular histidine, methionine, and lysine showed a higher tendency to racemization, especially in the absence of 0.02% phenol [56].

Phenol (up to 1%) or sodium sulfite (0.1%) are typical protective agents and are effective for nearly all amino acids except tryptophan and cysteine. However, relevant tryptophan recoveries have been reported in the presence of phenol when using liquid-phase hydrolysis or in the presence of tryptamine when using gas-phase hydrolysis [55], and in the absence of oxygen.

Hydrolysis with 4 M methanesulfonic acid (115°C for 22–72 h or 160°C for 45 min, under vacuum) has been preferred for better tryptophan recovery [60,61]. In this case, the hydrolysis is possible only in the liquid phase owing to the high boiling point of the reagent, and the use of protective reagents like tryptamine [62–64] or thioglycolic acid [50,65] are recommended to prevent oxidation. An important fact to consider is the impossibility to evaporate methanesulfonic acid after the hydrolysis. This means that the hydrolyzate can be used for chromatographic analysis



only after pH adjustment and dilution and thus the fluorescence detection should be advisable, owing to its higher sensibility. This procedure, which is generally applied to the determination of tryptophan solely, is used in conjunction with the derivatization with 9-fluorenyl chloroformate (FMOC) [62], or 4-dimethyl-aminoazobenzene-4'-sulfonyl chloride (dabsyl-Cl) [63], resulting in very good recoveries for all amino acids, including tryptophan (see next section for these derivative details). The hydrolysis with 3 M mercaptoethanesulfonic acid at high temperature for short time (160°C–170°C for 15–30 min) has also been reported to improve tryptophan and methionine recoveries [66].

Whey protein is especially rich in cysteine but the content of cysteine in casein and whey protein differs by more than a factor of 10. This is the reason for why the analysis of cysteine has been used as a method to estimate the protein whey fraction in casein coprecipitates and milk powder [67]. Cysteine is one of the more difficult amino acids to quantitate by amino acid analysis, because its sulfhydryl group can undergo a variety of reactions during protein workup and acid hydrolysis [68]. Thus, cysteine (and also cystine) gets partially oxidized during acid hydrolysis yielding several adducts: racemic mixtures of L-cystine, cysteine sulfinic acid, and cysteic acid, making its analysis rather difficult. Several procedures have been proposed to better analyze cyst(e)ine submitted to acid hydrolysis. The use of alkylating agents to stabilize cysteine before the hydrolysis has been used as a valid alternative [69]. Good recoveries have been reported by using 4-vinyl-pyridine [70], 3-bromopropylamine [68], and 3,3'-dithiodipropionic acid [67,71,72]. The resulting derivatives will be analyzed by some of the methods described in the next section. Another widespread used procedure consists of the conversion of cysteine to cysteic acid by performic acid oxidation prior to acid hydrolysis [73–77]. Cysteic acid can be analyzed by some of the methods described in the next section.

As can be observed, no single set of conditions will yield the accurate determination of all amino acids. In fact, it is a compromise of conditions that offer the best overall estimation for the largest number of amino acids. In general, the 22–24 h acid hydrolysis at 110°C with the addition of a protective agent like phenol yields acceptable results for the majority of amino acids, being enough for the requirements of any food control laboratory. However, when the analysis of tryptophan or cyst(e)ine is necessary, adequate special hydrolysis procedures as those described earlier should be performed. When high sensitivity is required, the pyrolysis at up to 600°C overnight of all glass materials in contact with the sample and the gas-phase hydrolysis is advisable as well as the analysis of some blank samples to control the level of background present. The optimization of conditions based on the study of hydrolysis time and temperature, acid-to-protein ratio, presence and concentration of oxidation protective agents, importance of a correct deaeration, etc. has been extensively reported in the literature [52,53,55,56,78,79].

### 2.2.2.2 *Alkaline Hydrolysis*

The alkaline hydrolysis with 4.2 M of either NaOH, KOH, LiOH, or Ba(OH)<sub>2</sub>, with or without the addition of 1% (w/v) thiodiglycol for 18 h at 110°C in a conventional oven [74,80–86] or 18 min in a microwave oven [57] has been recommended for a better tryptophan determination, especially for food samples with high carbohydrate content like dairy products.

### 2.2.2.3 *Enzymatic Hydrolysis*

Enzymatic hydrolysis with proteolytic enzymes such as pepsine, trypsin, chymotrypsin, carboxypeptidase, aminopeptidase, papain, thermolysin, prolidase, and pronase have been used to analyze

specific amino acid sequences or single amino acids because of their specific and well-defined activity. Pronase has shown to be the most effective enzyme to release all lysine, methionine, tryptophan, and 60% of the cysteine from casein [87], or tryptophan from soy- and milk-based nutritional products [88], while a mixture of pepsine, pronase E, prolidase, and aminopeptidase has been used to ensure total hydrolysis of lysine, tryptophan [89,90], and glutamine [91] from milk proteins.

## 2.3 Amino Acid Analysis

After sample preparation, amino acids may be analyzed as a pool without separating each other by spectrophotometry or individually by chromatography (high-performance liquid chromatography [HPLC] or gas-liquid chromatography [GLC]) or capillary electrophoresis (CE).

### 2.3.1 Analysis of the Whole Amino Acid Content

The simplest aim consists in the analysis of the whole amino acids amount without discriminating each other. This analysis does not discriminate between free amino acids and small peptides and is based on the reaction of the  $\alpha$ -amino group with reagents like *o*-phthaldialdehyde (OPA) [92], cadmium-ninhydrin [93–96], or 2,4,6-trinitrobenzene sulfonic acid (TNBS) [97–100]. These reagents rend chromophores that increase the amino acids' ultraviolet response at a higher wavelength or confer visible or fluorescent characteristics to them.

Methods for this analysis have been extensively described and compared with each other [101–103]. They generally include the precipitation of sample proteins with TCA, SSA, or PTA. Amine nitrogen in the supernatant is determined through colorimetry, UV-absorption, or fluorescence with previous derivatization with the reagents enumerated above. This analysis is usually performed to study proteolysis changes during cheese ripening [97,104].

### 2.3.2 Analysis of the Amino Acid Profile

The separation of the individual amino acids in a mixture requires very efficient separation techniques like HPLC or GLC. The choice mainly depends on the available equipment or personal preferences, because each methodology has its advantages and drawbacks.

#### 2.3.2.1 High-Performance Liquid Chromatography

HPLC is the most versatile and widespread technique to analyze amino acids. Amino acids are derivatized either before or after separation to enhance their detection.

##### 2.3.2.1.1 Derivatization

Derivatization is a usual practice in the amino acid analysis. The goodness of a derivatizing agent is evaluated based on the following aspects: It must be able to react with both primary and secondary amino acids, give a quantitative and reproducible reaction, yield a single derivative of each amino acid, have mild and simple reaction conditions, possibility of automation, good stability of the derivatization products, and no interferences due to by-products or excess of reagent.

It is worthwhile to remark that the use of enough amount of derivatization reagent is of special importance when dealing with biological samples since reagent-consuming amines, although unidentified, are always present [105].

Some reports comparing amino acid derivatization methods for the HPLC [31,40,106–109] analysis of biological samples have been published. The most used derivatization methods are described below:

*Ninhydrin*: The most used postcolumn derivatization method after amino acid cation-exchange chromatographic analysis is the reaction of amino acids with ninhydrin. The reaction takes place in hot at pH 6 and renders colored derivatives detectable at 570 (primary amino acids) and 440 nm (secondary amino acids).

4-Dimethyl-aminoazobenzene-4'-sulfonyl chloride (dabsyl-Cl): This reagent forms stable (weeks) derivatives with primary and secondary amino acids, which are detectable in the visible range, presenting a maximum from 448 to 468 nm. The high wavelength of absorption makes the baseline chromatogram very stable with a large variety of solvents and gradient systems. Detection limits are in the low picomole range [63]. The reaction time is around 15 min at 70°C and takes place in a basic medium with an excess of reagent. The major disadvantage is that the reaction efficiency is highly matrix-dependent and variable for different amino acids, being affected by the presence of high levels of some chloride salts in particular [110]. To overcome this problem and obtain an accurate calibration, standard amino acids solution should be derivatized under similar conditions. By-products originating from an excess of reagent absorb at the same wavelength and appear in the chromatogram. Nevertheless, Krause et al. [111] obtained a good separation of more than 40 dabsyl-amino acids and by-products (amines) from foodstuffs including cheese.

*Phenylisothiocyanate (PITC)*: The methodology involves the conversion of primary and secondary amino acids to their phenylthiocarbamyl (PTC-) derivatives, which are detectable at 254 nm. The PTC-amino acids are moderately stable at room temperature for 1 day and much longer under frozen storage, especially in dry conditions. The methodology is well described in the literature [112–115]. Sample preparation is quite laborious; it requires a basic medium (pH 10.5) with triethylamine and includes several drying steps, being the last one necessary to eliminate the excess of reagent, which may cause damage to the chromatographic column. Twenty minutes of reaction time at room temperature is recommended for a complete reaction. The chromatographic separation takes around 20 min for hydrolyzed amino acids and 65 min for physiological amino acids.

The reproducibility of the method is very good, ranging from 2.6% to 5.5% for all amino acids except for histidine (6.3%) and cystine (10%). PTC-cystine shows a poor linearity that makes the quantitation of free cystine nonfeasible with this method [109]. The selection of the column is critical to get a good resolved separation, especially when the analysis of physiological amino acids is involved. The chromatograms of free PITC-amino acids from two types of cheese are shown in Figure 2.1. Parmesan cheese looks much more hydrolyzed than Camembert, as shown in the UV absorbance, and their amino acid patterns are very different, showing the characteristic proteolytic process taking place in each cheese.

The reliability of the method has been tested on food samples [107,113,116] and compared with the traditional ion-exchange chromatography and postcolumn derivatization [107,117].

*1-Dimethylamino-naphthalene-5-sulfonyl chloride (dansyl-Cl)*: Dansyl-Cl reacts with both primary and secondary amines to give a highly fluorescent derivative ( $\lambda_{\text{ex}}$ , 350;  $\lambda_{\text{em}}$ , 510 nm). The dansylated amino acids are stable for 7 days at -4°C [118] if protected from light. The sample derivatization appears as simple, only needs a basic pH, around 9.5, and a reaction time of 1 h at room temperature (in the dark), or 15 min at 60°C or even 2 min at 100°C. However, the reaction conditions (pH, temperature, and excess of reagent) must be carefully fixed to optimize the

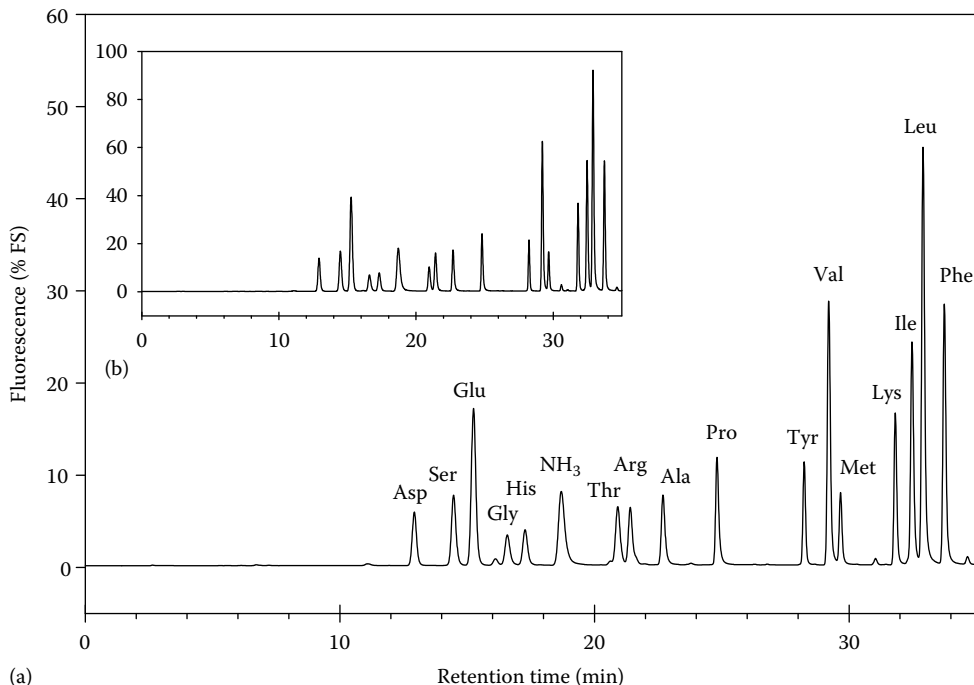
product yield and to minimize secondary reactions [118,119]. Even so, it will commonly form multiple derivatives with histidine, lysine, and tyrosine. Histidine gives a very poor fluorescence response (10% of the other amino acids), reinforcing the poor reproducibility of its results [109]. Another problem is that the excess of reagent (needed to assure a quantitative reaction) is hydrolyzed to dansyl sulfonic acid, which is highly fluorescent and probably interferes in the chromatogram as a huge peak. On the contrary, this methodology reveals excellent linearity for cystine and also cystine-containing short-chain peptides [108,109,120,121]. This derivative has been also used to analyze taurine [122].

*9-Fluorenylmethyl chloroformate (FMOC)*: This reagent yields stable derivatives (days) with primary and secondary amines. The derivative is fluorescent ( $\lambda_{\text{ex}}$ , 265 nm;  $\lambda_{\text{em}}$ , 315 nm) being detected at the femtomole range. The major disadvantage is due to the reagent itself or its hydrolyzed form, which is highly fluorescent and then, the excess may interfere in the chromatogram. It must be extracted (with pentane or diethyl ether) or converted into noninterfering adduct prior to injection. The first option was included in the automated Amino Tag™ chemistry system [123] developed by Varian (Varian Associates Limited). In the second option, the reaction of the reagent excess with a very hydrophobic amine as 1-adamantylamine (ADAM) gives a late-eluting noninterfering peak [124]. This method is preferred because the addition of ADAM is more easily automated. The reaction time is fast (45–90 s) and does not require any heating. To obtain reliable and precise results, reaction conditions, such as FMOC/amino acid ratio as well as reaction time have to be optimized very carefully. An automated precolumn derivatization routine, which includes the addition of ADAM, is of great advantage because it guarantees the repeatability of parameters. Tryptophan adducts do not fluoresce and histidine and cyst(e)ine adducts fluoresce weakly. The cysteine fluorescence can be enhanced by alkylation with 3-bromopropylamine, and the resulting *S*-3-aminopropylcysteine elutes well resolved between histidine and lysine [68].

*o-Phthalaldehyde*: This reagent reacts with primary amino acids in the presence of a mercaptan cofactor to give a highly fluorescent adduct. The fluorescence is recorded at 455 or 470 nm after excitation at 230 or 330 nm, respectively, and the reagent itself is not fluorescent. OPA derivatives can be detected by UV-absorption (338 nm) as well. It may be used either for pre- or postcolumn derivatization. This last is used to be coupled with cation-exchange HPLC [50,65]. The choice of mercaptan (2-mercaptoethanol, ethanethiol, or 3-mercaptopropionic acid) can affect derivative stability, chromatographic selectivity, and fluorescent intensity [50,65,125,126]. The derivatization is fast (1–3 min) and is performed at room temperature in alkaline buffer, pH 9.5. OPA-amino acids are not stable; this problem is overcome by standardizing the time between sample derivatization and column injection by automation. The major disadvantages are the low and variable yields with lysine and cysteine and that OPA does not react with secondary amines like proline. The addition of detergents like Brij 35 to the derivatization reagent seems to increase the fluorescence response of lysine [45,127,128]. On the other hand, to improve the cysteine determination and, previous to the OPA derivatization, several methods have been proposed like the conversion of cysteine and cystine to cysteic acid by oxidation with performic acid, the formation of the mixed disulfide *S*-2-carboxyethylthiocysteine (Cys-MPA) from cysteine and cystine, using 3,3'-dithiodipropionic acid [72] (see Section 2.2.2.1), or the carboxymethylation [69] of the sulfhydryl residues with iodoacetic acid [129]. The last two reactions can be incorporated into the automatic sample preparation protocol [125,109,129,130]. In these methods, cysteine and cystine are quantified together. Another proposal [131] consists of a slight modification in the OPA derivatization method by using 2-aminoethanol as a nucleophilic agent and altering the order in the addition of reagents in the automated derivatization procedure [130]. Secondary amines can be analyzed in the same run by combining the OPA with other derivatization methods as FMOC, which should

be taken sequentially. This is the basis of the AminoQuant system™ developed and marketed by Agilent Technologies and described by Schuster [130] and Godel et al. [125].

*6-Aminoquinolyl-N-hydroxysuccinimidyl carbamate (AQC)*: It reacts with primary and secondary amines from amino acids yielding very stable derivatives (1 week at room temperature) with fluorescent properties ( $\lambda_{\text{ex}}$ , 250 nm;  $\lambda_{\text{em}}$ , 395 nm). Ultraviolet detection (254 nm) may also be used. Sensitivity is in the fmol range. The main advantage of this reagent is that the yield and reproducibility of the derivatization reaction is scarcely interfered by the presence of salts, detergents, lipids, and other compounds naturally occurring in meat products. Furthermore, the optimum pH for the reaction is in a broad range, from 8.2 to 10, that facilitates sample preparation. The excess of reagent is consumed during the reaction to form aminoquinoline (AMQ), which is only weakly fluorescent at the amino acid derivatives detection conditions and does not interfere in the chromatogram. Reaction time is short, 1 min, but 10 min at 55°C would be necessary if tyrosine monoderivative is required, because both mono- and diderivatives are the initial adducts from tyrosine. Cysteine is usually analyzed as cysteic acid formed by oxidation with performic acid, previous derivatization [132]. Fluorescence of tryptophan derivative is very poor and UV detection at 254 nm may be used to analyze it. In this case, the AMQ peak appears very large at the beginning of the chromatogram, and may interfere with the first eluting peaks [132]. The chromatographic separation of these derivatives has been optimized for the amino acids from hydrolyzed proteins but, the resolution of physiological amino acids needs to be improved [133], which is the main drawback of this method. Figure 2.2 shows a chromatogram of the AQC-amino acids from



**Figure 2.2** Reversed phase HPLC chromatogram of AQC-amino acids from hydrolyzed (a) Manchego cheese and (b) casein.

hydrolyzed Manchego cheese and casein, where the coincidence between both amino acid profiles point out that casein is the major protein present.

Fluorescamine, which renders fluorescent derivatives with primary amino acids, has been used in precolumn derivatization of taurine. The column (RP-column) eluent was monitored at 480 nm (emission) after excitation at 400 nm [134]. This derivatization reagent may also be used postcolumn after ion-exchange separation.

### 2.3.2.1.2 Separation and Detection

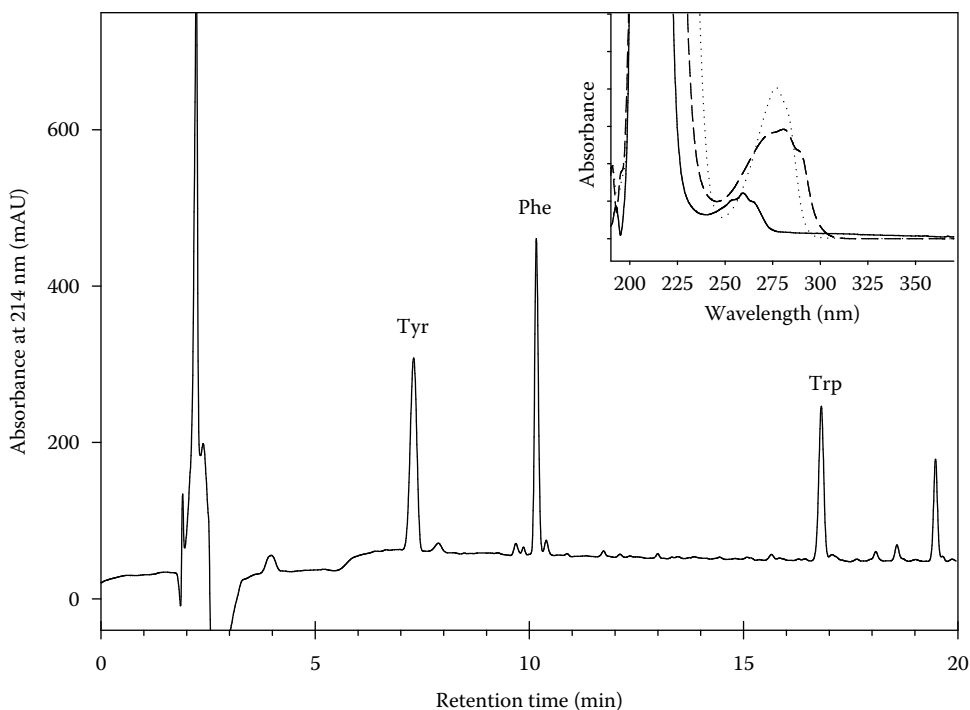
The HPLC separation techniques most used for the analysis of amino acids are cation exchange (CE-HPLC) and reversed phase (RP-HPLC). CE-HPLC used for the separation of nonderivatized amino acids, which are then postcolumn derivatized (by ninhydrin or OPA), is up to now the most frequently used technique for dairy products amino acids probably due to the widespread use of commercially available “amino acid analyzer.” Indeed, there are many manufacturers (Beckman, Biotronik, Dionex, LKB, Pickering, etc.) who offer integrated commercial systems including the column, buffer system, and an optimized methodology having the advantage of the ease of use and reliability. RP-HPLC is mainly used to separate precolumn-derivatized amino acids (see the previously described reagents). This is a more versatile technique and the used columns and facilities can be shared with other applications. The choice of the reversed phase column is essential to get a good separation because many peaks appear in the chromatogram, especially in the analysis of free amino acids. In the case of hydrolyzates, the sample is simpler and the use of shorter columns is advisable to reduce the time of analysis. Reversed phase has also been used to separate some underivatized amino acids like methionine, which is further detected at 214 nm [135] or the aromatic amino acids Tyr, Phe, and Trp that can be detected not only at 214 nm but also at 260 or 280 nm. Indeed, Phe presents a maximum of absorption at 260 nm, Tyr at 274.6, and Trp at 280 nm. The separation in this case may be achieved by using a gradient between 0.1% trifluoroacetic acid (TFA) in water and 0.08% of TFA in acetonitrile:water (60:40). Absorption spectra from these amino acids may add to their identification (see Figure 2.3).

For the rest of amino acids, the detector used depends on the chosen derivative, but it is worthwhile to take into account the previous section about derivatization (Section 2.3.2.1.1), because certain derivatives from some specific amino acids have a poor response.

### 2.3.2.2 Gas–Liquid Chromatography

The very high-resolution capacity is the main advantage of gas chromatography, in comparison with liquid chromatographic techniques, especially since the capillary columns appeared. Nevertheless, different conditions are sometimes needed to obtain a unique derivative from each amino acid, what constitutes a drawback of this technique that makes it not often used for the determination of amino acids from foods in general. To their analysis by GLC, the amino acids must be converted to volatile and thermostable molecule. Reactions consist in two stages: an esterification with an acidified alcohol followed by *N*-acylation with an acid anhydride in an anhydrous medium. The detector most widely used is the flame ionization detector (FID), which is universal, but in many cases, GLC has been combined with mass spectrometry (MS) for detection and identification [136].

Some commercially available proposals for the GLC analysis of amino acids are the kit offered by Supelco (Sigma-Aldrich, Bellefonte, PA), which uses *N*-methyl-*N*-(*t*-butyldimethylsilyl)-



**Figure 2.3** Reversed phase HPLC chromatogram of underivatized Manchego-type cheese extract showing the aromatic amino acids and their corresponding UV spectra. Chromatographic conditions are described in text (see Section 2.3.2.1.2). Tyrosine (···), phenylalanine (—), and tryptophan (---).

trifluoroacetamide (MTBSTFA) as derivatizing reagent and a short (20 m) capillary column (they give the conditions to separate 24 amino acids in 8 min) or the method EZ:fast, which is a patent pending method (Phenomenex, Torrance, CA) to analyze protein hydrolyzates and physiological amino acids from serum, urine, beer, wine, feeds, fermentation broths, and foodstuffs. This method includes a derivatization reaction (proprietary), in which both the amine and carboxyl groups of amino acids are derivatized. Derivatives are stable for up to 1 day at room temperature and for several days if refrigerated and are further analyzed by gas chromatography (GC)/FID, GC/nitrogen–phosphorous detection (NPD), GC/MS, and liquid chromatography (LC)/MS. Results (50 amino acids and related compounds) are obtained in about 15 min (sample preparation included) when using the GC method or 24 min by using the LC method.

There are some studies reporting the analysis of amino acids by GLC in milk [136], and in cheese [36,137]. Other more specific applications are the analysis of amino acids enantiomers [138] or the analysis of some indicators of thermal damage like lysinoalanine (LAL), carboxymethyllysine (CML), lactolosyllysine, or furosine [89,139–141]. GLC is in general not recommended for some of the essential amino acids like cysteine, tryptophan, or methionine. Nevertheless, a method of analysis for tryptophan in proteins based on the GLC separation of skatole produced by pyrolysis of tryptophan at 850°C was developed by Danielson and Rogers [142]. Sample pretreatment for this method is limited to only sample lyophilization to form a dry solid, and hydrolysis is not required.

### 2.3.2.3 Capillary Zone Electrophoresis

Capillary zone electrophoresis (CZE) is an extremely efficient technique for separations of charged solutes [143,144]. The high efficiency, speed, and the low requirements of sample amount make this technique very interesting when compared with classical electrophoresis and chromatographic techniques. The difficulty of separating amino acids by this technique relies in their structure. Amino acids constitute a mix of basic, neutral, and acidic constituents, and even though a particular pH can significantly improve the resolution of one kind, it is very likely to cause overlap with the others. Under the conditions of the electro-osmotic flow in CE, the species with different charge can be simultaneously analyzed, but with serious doubts in its adequate resolution. The primary limitation of CZE is its inability to separate neutral compounds from each other. Terabe et al. [145,146] introduced a modified version of CZE where surfactant-formed micelles were included in the running buffer to provide a two-phase chromatographic system for separating neutral compounds together with charged ones in a CE system. This technique has also been termed “micellar electrokinetic capillary chromatography” (MECC). Basic theoretical considerations on this technique [147] and its food application [148] are described elsewhere.

With few exceptions [149–151], derivatization is used to improve separation, to enhance ultraviolet detection, or to allow fluorescence detection of amino acids. Good separations have been reported for precapillary derivatized amino acids with dansyl-Cl [147,152,153], PITC [154], phenylthiohydantoin [155,156], FMOC [157], and OPA [158]. Liu et al. [158] compared the separation of OPA-amino acid derivatives by CZE with normal and micellar solutions, showing that higher efficiency is obtained by the MECC methods with sodium dodecyl sulfate (SDS) as micelle-forming substance. SDS is indeed the most used reagent to form micelles though others like dodecyltrimethylammonium bromide [156], Tween-20 [159] or octylglucoside [160] have been assayed. The effect of organic modifiers (acetonitrile, isobutanol, methanol, tetrahydrofuran...) and urea, as additives, on the electro-osmotic mobility and electrophoretic mobility of the micelle has been studied [161–163].

The applications of this technique is in many cases focused to resolve racemic mixtures of amino acids (D+L-amino acids) by adding a chiral additive like *N*-acetyl-L-cysteine [164] or  $\beta$ -cyclodextrin [157] among others. The CE coupled to electrospray ionization mass spectrometry (CE-ESI-MS) allows the direct amino acid analysis without derivatization [165], using 1 M formic acid as electrolyte. Protonated amino acids are separated by CE and detected selectively by a quadrupole mass spectrometer with a sheath flow electrospray ionization interface.

## 2.4 Special Analysis

The processing of milk and dairy products has a direct effect on the nutritive value of the milk protein for altering the biological availability of some essential amino acids, especially lysine and tryptophan. In this section, methods for the analysis of both are described.

### 2.4.1 Lysine

To assure microbiological safety and to extend the shelf-life period, milk and some milk products may be submitted to more or less severe thermal treatment like pasteurization, sterilization, concentration, or spray-drying, which may diminish the nutritive value by decreasing the digestibility of some essential amino acids. This is the case of lysine. During heat treatments and subsequent



prolonged storage of milk, some Maillard reactions or undesirable crosslinking reactions with the formation of LAL take place.

LAL is formed from the reaction of the  $\epsilon$ -amino group of lysine with dehydroalanine resulting from  $\beta$ -elimination of cyst(e)ine, serine, or its derivatives (phosphorylserine, glycosylserine) [166,167]. This reaction is favored by alkali treatment in milk products and mainly occurs in commercial caseinate; otherwise, very small concentrations are found in raw or pasteurized milk [168]. LAL has been presented as a useful parameter for distinguishing between natural Mozzarella cheese and the imitation products [139,168,169]. Also LAL has been used as a sensitive indicator for heat treatment of milk [168,170]. Methods for its analysis include acid hydrolysis (0.6N HCl at 110°C for 22h) and any of the following methods: (1) CE-HPLC followed by postcolumn derivatization with ninhydrin [171], (2) precolumn derivatization with dansyl-Cl and RP-HPLC with fluorescence detection [168], (3) precolumn derivatization with FMOC, solid-phase extraction (amino cartridge) to isolate the LAL and RP-HPLC with fluorescence detection [169], (4) GC-FID (or MS) analysis of *N*-*tert*-butyl dimethylsilyl (tBDMSi) derivatives [139,140].

Also, heat treatments and prolonged storage of milk promote Maillard reactions, which take place between amines and the reducing carbohydrate lactose. In the initial stage of this reaction, mainly the side-chain amino group of the protein-bound lysine reacts with lactose to form the first stable Amadori product lactuloselysine ( $\epsilon$ -(deoxylactose)lysine), leading to a loss of nutritional value due to blockage of the essential amino acid lysine [11]. Prolonged thermal treatment and furthermore, pro-oxidative conditions such as the presence of iron/ascorbic acid can promote the formation of stable advanced-glycation end products (AGEAs) [89,172] like the CML, which is proposed as a useful indicator of the nutritional quality of severely heat-treated foods [141]. The percentage of blocked lysine in milk products depends on the type of heat treatments and also on the composition of the products [166].

During the acid hydrolysis used in amino acid analysis, the lysine, which is found blocked in the native protein, reverts back to the parent amino acid, leading to errors in the estimates of the "available" lysine of dairy foods for nutritive concern. Thus, the determination of available lysine may be achieved by protecting the  $\epsilon$ -free-protein lysine group with (1) FDNB, (2) TNBS, (3)  $\text{NaBH}_4$  [173], or (4) OPA, previous to an eventually acid hydrolysis. Another option can be the enzymatic release of lysine as described in Section 2.2.2.3 followed by any of the chromatographic methods described in Section 2.3.2.

The measure of both blocked and lysine available is useful to evaluate either the effect of thermal treatment on the milk nutritive value or the correct treatment application, and also to detect the addition of powdered milk to a food [174,175]. Several methods as spectrophotometric (fluorometric) methods by using FDNB-reactive lysine method [176–179] or OPA [180,181], the furosine method [182–185] or the direct measurement of the lactuloselysine [90] among others have been proposed for this purpose.

FDNB-reactive lysine method was developed by Carpenter [179]. Briefly, sample is first derivatized with FDNB in dark at room temperature for 2h. Dried derivatized sample is hydrolyzed using 6M HCl (110°C, 24h). Hydrolyzed sample is evaporated to dryness and reconstituted with water:acetonitrile (1:4) and analyzed by RP-HPLC in a  $\text{C}_{18}$  column, following which, *N*- $\epsilon$ -(2,4-dinitrophenyl)-L-lysine (DNP-Lys) is detected at 360 nm. This same procedure is well described elsewhere [175].

OPA derivatization and analysis of chemically available lysine in milk matrices was described by Ferrer et al. [180] and Vigo et al. [181] and has the advantage of not requiring either hydrolysis or amino acid analysis of the sample.

The furosine method is based on the observation that the acid hydrolysis with 8 N HCl at 110°C for 23 h of the Amadori compound lactuloselysine produces the nonprotein amino acid furosine ( $\epsilon$ -*N*-(2-furoyl-methyl)-L-lysine) [167,186], which can serve as an index of the unavailable lysine and as suitable indicator of the effect of heat treatments on milk quality [187,188]. Microwave hydrolysis in less than 30 min is also successful [189]. After promoting its formation, furosine is analyzed by the procedure described as follows. Hydrolyzed sample is filtered or centrifuged and the filtrate or supernatant passed through a C<sub>18</sub> solid-phase extraction cartridge. Retained furosine is eluted with 3 M HCl and analyzed by ion-pair (sodium heptane sulfonate)-reversed phase HPLC with UV detection at 280 nm [183–185]. CZE has also been used to analyze furosine [190–193].

Because the furosine formation is not quantitative with a yield of only 30%–40% [186], this method can lead to a significant underestimation of lysine damage [90]. Nevertheless, this recovery rate is reproducible if consistent analytical conditions are applied and, on the other hand, pure standard furosine is commercially available, what constitutes an advantage, even though, Henle et al. [90] proposed the direct measure of its precursor lactuloselysine as an alternative.

*Measurement of lactuloselysine.* As mentioned, lactuloselysine ( $\epsilon$ -(deoxylactulose)lysine) is an Amadori compound formed at the first stages of Maillard reaction taking place between lysine and lactose under heat treatments or prolonged inadequate storage. The method proposed by Henle et al. [90] includes an enzymatic hydrolysis of sample by the sequential addition and incubation with the enzymes pepsin, pronase, aminopeptidase, and prolidase and the ion-exchange amino acid analysis with ninhydrin detection. This method allows the determination of lactuloselysine (blocked-lysine) and free lysine in the same chromatogram.

## 2.4.2 Tryptophan

Tryptophan is also an essential amino acid, which is easily destroyed by oxidation promoted by Maillard products or iron [172,194]. To analyze tryptophan sample hydrolysis with methanesulfonic or mercaptoethanesulfonic acids, alkaline or enzymatic hydrolysis are recommended to be better than HCl hydrolysis (see Section 2.2.2). Afterward, there are several possible analytical methods like cation-exchange chromatography with postcolumn derivatization with OPA [81], RP-HPLC previous or without derivatization, and direct UV or fluorescence detection [80,194] or even by GLC [142]. Direct determination of tryptophan without separation or even without hydrolysis of the sample are based on either the acid ninhydrin method [195] or the tryptophan forth-derivative UV-absorption spectrum [196].

## References

1. Aristoy, M.C. and Toldrá, F. Essential amino acids. In: *Handbook of Muscle Foods Analysis* (L.M.L. Nolle and F. Toldrá, Eds.). CRC Press, Boca Raton, FL, pp. 385–397, 2009.
2. Aristoy, M.C. and Toldrá, F. Essential amino acids. In: *Handbook of Processed Meats and Poultry Analysis* (L.M.L. Nolle and F. Toldrá, Eds.). CRC Press, Boca Raton, FL, pp. 215–232, 2009.
3. Aristoy, M.C. and Toldrá, F. Essential amino acids. In: *Handbook of Seafood and Seafood Products Analysis* (L.M.L. Nolle and F. Toldrá, Eds.). CRC Press, Boca Raton, FL, in press.
4. Walstra, P., Geurts, T.J., Noomen, A., et al. *Dairy Technology. Principles of Milk Properties and Processes*. Marcel-Dekker Inc., New York, pp. 3–104, 1999.

5. Prosser, C.G., McLaren, R.D., Frost, D., et al. Composition of the non-protein nitrogen fraction of goat whole milk powder and goat milk-based infant and follow-on formulae. *Int. J. Food Sci. Nutr.* 59: 123–133, 2008.
6. Agostoni, C., Carratú, B., Boniglia, C., et al. Free amino acid content ion standard infant formulas comparison with human milk. *J. Am. Coll. Nutr.* 19: 434–438, 2000.
7. Chesney, R.W., Helms, R.A., Christensen, M., et al. The role of taurine in infant nutrition. *Adv. Exp. Med. Biol.* 442: 463–476, 1998.
8. Yeung, C.Y., Lee, H.C., Lin, S.P., et al. Negative effect of heat sterilization on the free amino acid concentrations in infant formula. *Eur. J. Clin. Nutr.* 60: 136–141, 2006.
9. Vasson, M.P., Farges, M.C., Sarret, A., et al. Free amino acid concentration in milk: Effect of microwave versus conventional heating. *Amino Acids* 15: 385–388, 1998.
10. Moughan, P.J. and Rutherford, S.M. Available lysine in foods: A brief historical overview. *J. Assoc. Off. Anal. Chem.* 9: 901–906, 2008.
11. Hurrell, R.F. and Carpenter, K.J. The estimation of available lysine in foodstuffs after Maillard reactions. *Progr. Food Nutr. Sci.* 5: 159–176, 1981.
12. Hurrell R.F. and Carpenter K.J. Mechanisms of heat damage in proteins: 4. The reactive lysine content of heat damaged material as measured in different ways. *Br. J. Nutr.* 32: 589–604, 1974.
13. Smit, G., Smit, B.A., and Engels W.J.M. Flavour formation by lactic acid bacteria and biochemical flavour profiling of cheese products. *FEMS Microb. Rev.* 29: 591–610, 2005.
14. Martínez-Cuesta, M.C., de Palencia, P.F., Requena, T., et al. Enzymatic ability of *Lactobacillus casei* subsp. *casei* IFPL731 for flavour development in cheese. *Int. Dairy J.* 11: 577–585, 2001.
15. Smit, G., Verheul, A., van Kranenburg, R., et al. Cheese flavour development by enzymatic conversions of peptides and amino acids. *Food Res. Int.* 33: 153–160, 2000.
16. Engels, W.J.M. and Visser, S. Development of cheese flavour from peptides and amino acids by cell-free extracts of *Lactococcus lactis* subsp. *cremoris* B78 in a model system. *Neth. Milk Dairy J.* 50: 3–17, 1996.
17. Engels, W.J.M. and Visser, S. Isolation and comparative characterization of components that contribute to the flavor of different types of cheese. *Neth. Milk Dairy J.* 48: 127–140, 1994.
18. Landaud, S., Helinck, S., and Bonnarne, P. Formation of volatile sulfur compounds and metabolism of methionine and other sulfur compounds in fermented food. *Appl. Microbiol. Biotechnol.* 77: 1191–1205, 2008.
19. López del Castillo-Lozano, M., Mansour, S., Tache, R., et al. The effect of cysteine on production of volatile sulphur compounds by cheese-ripening bacteria. *Int. J. Food Microbiol.* 122: 321–327, 2008.
20. Smit, B.A., Engels, W.J.M., Alewijn, M., et al. Chemical conversion of alpha-keto acids in relation to flavor formation in fermented foods. *J. Agric. Food Chem.* 52: 1263–1268, 2004.
21. Engels, W.J.M., Alting, A.C., Arntz, M.M.T.G., et al. Partial purification and characterization of two aminotransferases from *Lactococcus lactis* subsp. *cremoris* B78 involved in the catabolism of methionine and branched-chain amino acids. *Int. Dairy J.* 10: 443–452, 2000.
22. McSweeney, P.L.H. and Sousa, M.J. Biochemical pathways for the production of flavour compounds in cheeses during ripening: A review. *Lait* 80: 293–324, 2000.
23. Taborda, G., Molina, E., Martínez-Castro, I., et al. Composition of the water-soluble fraction of different cheeses. *J. Agric. Food Chem.* 51: 270–276, 2003.
24. Molina, E., Ramos, M., Alonso, L., et al. Contribution of low molecular weight water soluble compounds to the taste of cheeses made of cows' ewes' and goats' milk. *Int. Dairy J.* 9: 613–621, 1999.
25. Caponio, F. and Alloggio, V. Taurine and other free amino acids: Comparison between Apulian goat milk and cow milk. *Latte* 20: 294–297, 1995.
26. Taborda, G., Gómez-Ruiz, J.A., Martínez-Castro, I., et al. Taste and flavor of artisan and industrial Manchego cheese as influenced by the water-soluble extract compounds. *Eur. Food Res. Technol.* 227: 323–330, 2008.
27. Juan, B., Ferragut, V., Buffa, M., et al. Effects of high pressure on proteolytic enzymes in cheese: Relationship with the proteolysis of ewe milk cheese. *J. Dairy Sci.* 90: 2113–2125, 2007.

28. Buffa, M., Guamis, B., and Trujillo, A.J. Specific effect of high-pressure treatment of milk on cheese proteolysis. *J. Dairy Res.* 72: 385–392, 2005.
29. Grappin, R. and Beuvier, E. Possible implications of milk pasteurization on the manufacture and sensory quality of ripened cheese. *Int. Dairy J.* 7: 751–761, 1997.
30. Butikofer, U. and Fuchs, D. Development of free amino acids in Appenzeller, Emmentaler, Gruyere, Raclette, Sbrinz and Tilsiter cheese. *Lait* 77: 91–100, 1977.
31. Aristoy, M.C. and Toldrá, F. Amino acids. In: *Handbook of Food Analysis*, 2nd edn. (L.M.L. Nollet, Ed.). Marcel-Dekker Inc., New York, pp. 83–123, 2004.
32. Pamblanco, M., Portoles, M., Paredes, C., et al. Free amino-acids in preterm and term milk from mothers delivering appropriate-for-gestational-age or small-for-gestational-age infants. *Am. J. Clin. Nutr.* 50: 778–781, 1989.
33. Carlson, S.E. Human milk nonprotein nitrogen: Occurrence and possible functions. *Adv. Pediatr.* 32: 43–70, 1985.
34. Kuchroo, C.N. and Fox, P.F. Soluble nitrogen in cheddar cheese—comparison of extraction procedures. *Milch.-Milk Sci. Int.* 37: 331–335, 1982.
35. Izco, J.M., Irigoyen, A., Torre, P., et al. Effect of the activity levels of the added proteolytic enzyme mixture on free amino acids in ripening Ossau-Iraty cheese. *J. Chromatogr. A* 881: 69–79, 2000.
36. Büetikofer, U. and Ardö, Y. Quantitative determination of free amino acids in cheese. *Bull. Int. Dairy Fed.* 337 (Part 2): 24–32, 1999.
37. Hickey, M.W., Vanleeuwen, H., Hillier, A.J., et al. Amino-acid accumulation in cheddar cheese manufactured from normal and ultrafiltered milk. *Aust. J. Dairy Technol.* 38: 110–113, 1983.
38. Aristoy, M.C. and Toldrá, F. Deproteinization techniques for HPLC amino acid analysis in fresh pork muscle and dry-cured ham. *J. Agric. Food Chem.* 39: 1792–1795, 1991.
39. Sarwar, G. and Botting, H.G. Rapid analysis of nutritionally important free amino acids in serum and organs (liver, brain, and heart) by liquid chromatography of precolumn phenylisothiocyanate. *J. Assoc. Off. Anal. Chem.* 73: 470–475, 1990.
40. Deyl, Z., Hyanek, J., and Horakova, M. Profiling of amino acid in body fluids and tissues by means of liquid chromatography. *J. Chromatogr.* 379: 177–250, 1986.
41. Carratú, B., Boniglia, C., Scalise, F., et al. Nitrogenous components of human milk: Non-protein nitrogen, true protein and free amino acids. *Food Chem.* 81: 357–362, 2003.
42. Knecht, R. and Chang, J.Y. Liquid chromatographic determination of amino acids after gas-phase hydrolysis and derivatization with (dimethylamino)azobenzenesulfonyl chloride. *Anal. Chem.* 58: 2375–2379, 1986.
43. Englard, S. and Seifter, S. Precipitation techniques. *Meth. Enzymol.* 182: 285–300, 1990.
44. Fresno, J.M., Tornadijo, M.E., Carballo, J., et al. Proteolytic and lipolytic changes during the ripening of a Spanish craft goat cheese (Armada variety). *J. Sci. Food Agric.* 75: 148–154, 1997.
45. Jarrett, H.W., Cooksy, K.D., Ellis, B., et al. The separation of *ortho*-phthalaldehyde derivatives of amino-acids by reversed-phase chromatography on octylsilica columns. *Anal. Biochem.* 153: 189–198, 1986.
46. Pinho, O., Ferreira, I.M.P.L.V.O., Mendes, E., et al. Effect of temperature on evolution of free amino acid and biogenic amine contents during storage of Azeitão cheese. *Food Chem.* 75: 287–291, 2001.
47. Freitas, A.C., Fresno, J.M., Prieto, B., et al. How milk type, coagulant, salting procedure and ripening time affect the profile of free amino acids in Picante da Beira Baixa cheese. *J. Sci. Food Agric.* 79: 611–618, 1999.
48. Salles, C., Septier, C., Roudot-Algaron, F., et al. Sensory and chemical analysis of fractions obtained by gel permeation of water-soluble Comté Cheese extracts. *J. Agric. Food Chem.* 43: 1659–1668, 1995.
49. Qureshi, G.A. and Qureshi, A.R. Determination of free amino-acids in biological samples—problems of quantitation. *J. Chromatogr. Biomed. Appl.* 491: 281–289, 1989.
50. Ashworth, R.B. Ion-exchange separation of amino acids with postcolumn orthophthalaldehyde detection. *J. Assoc. Off. Anal. Chem.* 70: 248–252, 1987.

51. Gehrke, C.W., Rexroad, P.R., Schisla, R.M., et al. Quantitative analysis of cystine, methionine, lysine, and nine other amino acids by a single oxidation—4 h hydrolysis method. *J. Assoc. Off. Anal. Chem.* 70: 171–174, 1987.
52. Gehrke, C.W. Wall, L.L., Absheer, J.S., et al. Sample preparation for chromatography of amino acids: Acid hydrolysis of proteins. *J. Assoc. Off. Anal. Chem.* 68: 811–821, 1985.
53. Lucas, B. and Sotelo, A. Amino acid determination in pure proteins, foods, and feeds using two different acid hydrolysis methods. *Anal. Biochem.* 123: 349–356, 1982.
54. Molnár-Perl, I. and Khalifa, M. Analysis of foodstuff amino acids using vapour-phase hydrolysis. *LC-GC Int.* 7: 395–398, 1994.
55. Molnár-Perl, I. and Khalifa, M. Tryptophan analysis simultaneously with other amino acids in gas phase hydrochloric acid hydrolyzates using the Pico-Tag™ Work Station. *Chromatographia* 36: 43–46, 1993.
56. Weiss, M., Manneberg, M., Juranville, J.F., et al. Effect of the hydrolysis method on the determination of the amino acid composition of proteins. *J. Chromatogr. A* 795: 263–275, 1998.
57. Carisano, A. Microwave oven hydrolysis of proteins in food matrixes. II. Determination of tryptophan. *Ind. Aliment.* 32: 346–348, 1993.
58. Carisano, A. Rapid microwave oven hydrolysis of proteins in food matrixes. I. Determination of amino acids other than tryptophan, cystine and methionine. *Ind. Aliment.* 31: 891–895, 1992.
59. Woodward, C., Gilman, L.B., and Engelhart W.G. An evaluation of microwave heating for the vapor phase hydrolysis of proteins. *Int. Labour Sept.* 40–45, 1990.
60. Chiou, S.H. and Wang, K.T. Peptide and protein hydrolysis by microwave irradiation. *J. Chrom. Biomed. Appl.* 491: 424–431, 1989.
61. Simpson, R.J., Neuberger, M.R., and Liu, T.Y. Complete amino-acid analysis of proteins from a single hydrolysate. *J. Biol. Chem.* 251: 1936–1940, 1976.
62. Malmer, M.F. and Schroeder, L.A. Amino acid analysis by high-performance liquid chromatography with methanesulfonic acid hydrolysis and 9-fluorenylmethylchloroformate derivatization. *J. Chromatogr.* 514: 227–239, 1990.
63. Stocchi, V., Piccoli, G., Magnani, M., et al. Reversed-phase high-performance liquid-chromatography separation of dimethylaminoazobenzene sulfonylaminoazobenzene and dimethylaminoazobenzene thiohydantoin amino-acid derivatives for amino-acid analysis and microsequencing studies at the picomole level. *Anal. Biochem.* 178: 107–117, 1989.
64. Umagat, H., Kucera, P., and Wen, L.F. Total amino-acid-analysis using precolumn fluorescence derivatization. *J. Chromatogr.* 239: 463–474, 1982.
65. Ashworth, R.B. Amino-acid-analysis for meat protein evaluation. *J. Assoc. Off. Anal. Chem.* 70: 80–85, 1987.
66. Csapo, J. Determination of tryptophan and methionine by mercaptoethanesulfonic acid hydrolysis at elevated temperature. *Acta Aliment.* 23: 257–266, 1994.
67. Ballin, N.Z. Estimation of whey protein in casein coprecipitate and milk powder by high-performance liquid chromatography. Quantification of cysteine. *J. Agric. Food Chem.* 54: 4131–4135, 2006.
68. Hale, J.E., Beidler, D.E., and Jue, R.A. Quantitation of cysteine residues alkylated with 3-bromopropylamine by amino acid analysis. *Anal. Biochem.* 216: 61–66, 1994.
69. Gurd, F.R.N. Carboxymethylation. *Methods Enzymol.* 25: 424–438, 1972.
70. Friedman, M., Krull, L.H., and Cavins, J.F. Chromatographic determination of cystine and cysteine residues in proteins as s-beta-(4-pyridylethyl)cysteine. *J. Biol. Chem.* 245: 3868–3871, 1970.
71. Tuan, Y.H. and Phillips, R.D. Optimized determination of cystine/cysteine and acid-stable amino acids from a single hydrolysate of casein- and sorghum-based diet and digesta samples. *J. Agric. Food Chem.* 45: 3535–3540, 1997.
72. Barkholt, V. and Jensen, A.L. Amino acid analysis: Determination of cysteine plus half-cystine in proteins after hydrochloric acid hydrolysis with a disulfide compound as additive. *Anal. Biochem.* 177: 318–322, 1989.

73. Rutherford, S.M., Schneuwly, A., and Moughan, P.J. Analyzing sulfur amino acids in selected feed-stuffs using least-squares nonlinear regression. *J. Agric. Food Chem.* 55: 8019–8024, 2007.
74. Viadel, B., Alegría, A., Farré, R., et al. Amino acid profile of milk-based infant formulas. *Int. J. Food Sci. Nutr.* 51: 367–372, 2000.
75. Toran, A., Barberá, R., Farré, R. et al. HPLC method for cyst(e)ine and methionine in infant formulas. *J. Food Sci.* 61: 1132–1135, 1170, 1996.
76. Hirs, C.H.W. Performic acid oxidation. *Methods Enzymol.* 11: 197–199, 1967.
77. Moore, S. On the determination of cystine and cysteic acid. *J. Biol. Chem.* 243: 235–237, 1963.
78. Albin, D.M., Wubben, J.E., and Gabert, V.M. Effect of hydrolysis time on the determination of amino acids in samples of soybean products with ion-exchange chromatography or precolumn derivatization with phenyl isothiocyanate. *J. Agric. Food Chem.* 48: 1684–1691, 2000.
79. Zumwalt, R.W., Absheer, J.S., Kaiser, FE., et al. Acid hydrolysis of proteins for chromatographic analysis of amino acids. *J. Assoc. Off. Anal. Chem.* 70: 147–151, 1987.
80. Delgado-Andrade, C., Rufián-Henares, J.A., Jiménez-Pérez, S., et al. Tryptophan determination in milk-based ingredients and dried sport supplements by liquid chromatography with fluorescence detection. *Food Chem.* 98: 580–585, 2006.
81. Ravindran, G. and Bryden, W.L. Tryptophan determination in proteins and feedstuffs by ion exchange chromatography. *Food Chem.* 89: 309–314, 2005.
82. Slump, P., Flissebaalje, T.D., and Haaksman, I.K. Tryptophan in food proteins: A comparison of two hydrolytic procedures. *J. Sci. Food Agric.* 55: 493–496, 1991.
83. Meredith, F.I., McCarthy, M.A., and Leffler, R. Amino acid concentrations and comparison of different hydrolysis procedures for American and foreign chestnuts. *J. Agric. Food Chem.* 36: 1172–1175, 1988.
84. Zarkadas, C.G., Zarcadas, G.C., Karatzas, C.N. et al. Rapid method for determining desmosine, isodesmosine, 5-hydroxylysine, tryptophan, lysinoalanine and the amino-sugars in proteins and tissues. *J. Chromatogr.* 378: 67–76, 1986.
85. Lucas, B. and Sotelo, A. Effect of different alkalies, temperature, and hydrolysis times on tryptophan determination of pure proteins and of foods. *Anal. Biochem.* 109: 192–197, 1980.
86. Hugli, T.E. and Moore, S. Determination of the tryptophan content of proteins by ion-exchange chromatography of alkaline hydrolysates. *J. Biol. Chem.* 247: 2828–2834, 1972.
87. Holz, F. Investigation into the enzymatical release of lysine, methionine, cyst(e)ine and tryptophan from casein and cereal proteins and their direct photometric-determination. *J. Anim. Physiol. Anim. Nutr.* 46: 72–89, 1981.
88. García, S.E. and Baxter, J.H. Determination of tryptophan content in infant formulas and medical nutritional. *J. Assoc. Off. Anal. Chem. Int.* 75: 1112–1119, 1992.
89. Birlouez-Aragón, I., Pischetsrieder, M., Leclere, J., et al. Assessment of protein glycation markers in infant formulas. *Food Chem.* 87: 253–259, 2004.
90. Henle, T., Walter, H., and Klostermeyer, H. Evaluation of the extent of the early Maillard-reaction in milk products by direct measurement of the Amadori-product latuloselysine. *Z. Lebensm. Unters. Forsch.* 193: 119–122, 1991.
91. Tsao, M. and Otter, D.E. Quantification of glutamine in proteins and peptides using enzymatic hydrolysis and reverse-phase high-performance liquid chromatography. *Anal. Biochem.* 269: 143–148, 1999.
92. Nielsen, P.M., Petersen, D. and Dambmann, C. Improved method for determining food protein degree of hydrolysis. *J. Food Sci.* 66: 642–646, 2001.
93. Katsiari, M.C., Alichanidis, E., Voutsinas, L.P. et al. Proteolysis in reduced sodium Kefalograviera cheese made by partial replacement of NaCl with KCl. *Food Chem.* 73: 31–43, 2001.
94. Pavia, M., Trujillo, A.J., Guamis, B., et al. Proteolysis in Manchego-type cheese salted by brine vacuum impregnation. *J. Dairy Sci.* 83: 1441–1447, 2000.
95. Baer, A., Ryba, I., Meyer, J., et al. Microplate assay of free amino acids in Swiss cheeses. *Lebensm-Wiss. Technol.* 29: 58–62, 1996.

96. Folkertsma, B. and Fox, P.F. Use of the Cd-ninhydrin reagent to assess proteolysis in cheese during ripening. *J. Dairy Res.* 59: 217–224, 1992.
97. Izco, J.M., Torre, P., and Barcina, Y. Ripening of Ossau-Iratzy cheese: Determination of free amino acids by RP-HPLC and of total free amino acids by the TNBS method. *Food Control* 11: 7–11, 2000.
98. Bouton, Y. and Grappin, R. Measurement of proteolysis in cheese: Relationship between phosphotungstic acid-soluble N fraction by Kjeldhal and 2,4,6-trinitrobenzenesulphonic acid-reactive groups in water-soluble N. *J. Dairy Res.* 61: 437–440, 1994.
99. Crowell, E.A., Ough, C.S., and Bakalinsky, A. Determination of alpha amino nitrogen in musts and wines by TNBS method. *Am. J. Enol. Vit.* 36: 175–177, 1985.
100. Adler-Nissen, J. Determination of the degree of hydrolysis of food protein hydrolysates by trinitrobenzenesulfonic acid. *J. Agric. Food Chem.* 27: 1256–1261, 1979.
101. Panasiuk, R., Amarowicz, R., Kostyra, H., et al. Determination of alpha-amino nitrogen in pea protein hydrolysates: A comparison of three analytical methods. *Food Chem.* 62: 363–367, 1998.
102. Lemieux, L., Puchades, R., and Simard, R.E. Free amino acids in Cheddar cheese: Comparison of quantitation methods. *J. Food Sci.* 55: 1552–1554, 1990.
103. Fields, R. The rapid determination of amino groups with TNBS. In: *Methods in Enzymology*, Vol. 25 (C.H.W. Hirs and S.N. Timasheff, Eds.). Academic Press: New York, 1972, pp. 464–468.
104. Ordóñez, A.I., Ibañez, F.C., Torre, P., et al. Characterization of the casein hydrolysis of Idiazabal cheese manufactured from ovine milk. *J. Dairy Sci.* 81: 2089–2095, 1998.
105. Godel, H. Graser, T., Foldi, P., et al. Measurement of free amino acids in human biological fluids by high-performance liquid chromatography. *J. Chromatogr.* 297: 49–61, 1984.
106. Aristoy, M.C. and Toldrá, F. Amino acids. In: *Handbook of Muscle Foods Analysis* (L.M.L. Noller and F. Toldrá, Eds.). CRC Press, Boca Raton, FL, pp. 11–40, 2008.
107. Sarwar, G. and Botting, H.G. Evaluation of liquid-chromatographic analysis of nutritionally important amino-acids in food and physiological samples. *J. Chromatogr. Biomed. Appl.* 615: 1–22, 1993.
108. Fekkes D. State-of-the-art of high-performance liquid chromatographic analysis of amino acids in physiological samples. *J. Chromatogr. Biomed. Appl.* 682: 3–22, 1996.
109. Fürst, P., Pollack, L., Graser, T.A., et al. HPLC analysis of free amino acids in biological material—An appraisal of four pre-column derivatization methods. *J. Liq. Chromatogr.* 12: 2733–2760, 1989.
110. Jansen, E.H.J.M., Vandenberg, R.H., Bothmiedema, R., et al. Advantages and limitations of precolumn derivatization of amino acids with dabsyl chloride. *J. Chromatogr.* 553: 123–133, 1991.
111. Krause, I., Bockhardt, A., Neckermann, H., et al. Simultaneous determination of amino acids and biogenic amines by reversed-phase high-performance liquid chromatography of the dabsyl derivatives. *J. Chromatogr. A* 715: 67–79, 1995.
112. Cohen, S.A. and Strydom, J. Amino acid analysis utilizing phenylisothiocyanate derivatives. *Anal. Biochem.* 174: 1–16, 1988.
113. Bidlingmeyer, B.A., Cohen, S.A., Tarvin, T.L., et al. New rapid high sensitivity analysis of amino acids in food type samples. *J. Assoc. Off. Anal. Chem.* 70: 241–247, 1987.
114. Bidlingmeyer, B.A., Cohen, S.A., and Tarvin, T.L. Rapid analysis of amino acids using pre-column derivatization. *J. Chromatogr.* 336: 93–104, 1984.
115. Heinrikson, R.L. and Meredith, S.C. Amino acid analysis by reverse-phase high-performance liquid chromatography: Precolumn derivatization with phenylisothiocyanate. *Anal. Biochem.* 136: 65–74, 1984.
116. White, J.A., Hart, R.J., and Fry, J.C. An evaluation of Waters Pico Tag system for the amino acid analysis of food materials. *J. Autom. Chem.* 8: 170–177, 1986.
117. Davey, J.F. and Ersser, R.S. Amino-acid-analysis of physiological fluids by high-performance liquid-chromatography with phenylisothiocyanate derivatization and comparison with ion-exchange chromatography. *J. Chromatogr. Biomed. Appl.* 528: 9–23, 1990.
118. Martín, P., Suárez A., Polo, C., et al. HPLC analysis of 19 amino acids. *Anal. Bromatol.* 32: 289–293, 1980.

119. Prieto, J.A., Collar, C., and Benedito de Barber, C. Reversed-phase high-performance liquid chromatographic determination of biochemical changes in free amino acids during wheat flour mixing and bread baking. *J. Chromatogr. Sci.* 28: 572–577, 1990.
120. Stehle, P., Albers, S., Pollack, L., et al. In vivo utilization of cystine-containing synthetic short chain peptides after intravenous bolus injection in the rat. *J. Nutr.* 118: 1470–1474, 1988.
121. Mackey, L.N. and Beck, T.A. Quantitative high-performance liquid chromatographic determination of sulfur amino acids in protein hydrolysates. *J. Chromatogr.* 240: 455–461, 1982.
122. Hischenhuber, C. High performance liquid chromatographic and thin-layer chromatographic determination of taurine in infant formulas. *Deut. Lebens.-Runds.* 84: 117–120, 1988.
123. Burton, C. Fully automated amino acid analysis using precolumn derivatization. *Int. Lab.* 30: 32–34, 36, 38, 1986.
124. Bëtner, I. and Foldi, P. The FMOC-ADAM approach to amino acid analysis. *LC-GC Int.* 6: 832–840, 1988.
125. Godel, H., Seitz, P., and Verhoef, M. Automated amino acid analysis using combined OPA and FMOC-Cl precolumn derivatization. *LC-GC Int.* 5: 44–49, 1992.
126. Euerby, M.R. Effect of differing thiols on the reversed-phase high-performance liquid chromatographic behaviour of *o*-phthaldialdehyde-thiol-amino acids. *J. Chromatogr.* 454: 398–405, 1988.
127. Jones, B.N. and Gilligan, J.P. *Ortho*-phthaldialdehyde precolumn derivatization and reversed-phase high-performance liquid-chromatography of polypeptide hydrolysates and physiological fluids. *J. Chromatogr.* 266: 471–482, 1983.
128. Gardner, W.S. and Miller, W.H. Reverse-phase liquid-chromatographic analysis of amino-acids after reaction with *ortho*-phthalaldehyde. *Anal. Biochem.* 101: 61–65, 1980.
129. Pripis-Nicolau, L., de Revel, G., Marchand, S., et al. Automated HPLC method for the measurement of free amino acids including cysteine in musts and wines; first applications. *J. Sci. Food Agric.* 81: 731–738, 2001.
130. Schuster, R. Determination of amino acids in biological, pharmaceutical, plant and food samples by automated precolumn derivatization and high-performance liquid chromatography. *J. Chromatogr.* 431: 271–284, 1988.
131. Park, S.K., Boulton, R.B., and Noble, A.C. Automated HPLC analysis of glutathion and thiol-containing compounds in grape juice and wine using pre-column derivatization with fluorescence detection. *Food Chem.* 68: 475–480, 2000.
132. Bosch, L., Alegría, A., and Farré, R. Application of the 6-aminoquinolyl-*N*-hydroxysuccinimidyl carbamate (AQC) reagent to the RP-HPLC determination of amino acids in infant foods. *J. Chromatogr. Anal. Technol. Biomed. Life Sci.* 831: 176–183, 2006.
133. Reverter, M., Lundh, T., and Lindberg, J.E. Determination of free amino acids in pig plasma by precolumn derivatization with 6-*N*-aminoquinolyl-*N*-hydroxysuccinimidyl carbamate and high-performance liquid chromatography. *J. Chromatogr. B* 696: 1–8, 1997.
134. Sakai, T. and Nagasawa, T. Simple, rapid and sensitive determination of plasma taurine by high-performance liquid-chromatography using precolumn derivative formation with fluorescamine. *J. Chromatogr. Biomed. Appl.* 576: 155–157, 1992.
135. Johns, P., Phillips, R., and Dowlati, L. Direct determination of free methionine in soy-based infant formula. *J. Assoc. Off. Anal. Chem. Int.* 87: 123–128, 2004.
136. Brüeckner, H. and Schieber, A. Determination of free D-amino acids in Mammalia by gas chromatography–mass spectrometry. *HRC* 23: 576–582, 2000.
137. Bertacco, G., Boschelle, O., and Lercker, G. Gas chromatographic determination of free amino acids in cheese. *Milchwissenschaft* 47: 348–350, 1992.
138. Casal, S., Oliveira, M.B., and Ferreira, M.A. Gas chromatographic quantification of amino acid enantiomers in food matrices by their N(O,S)-ethoxycarbonyl heptafluorobutyl ester derivatives. *J. Chromatogr. A* 866: 221–230, 2000.
139. Montilla, A., Gómez-Ruiz, J.A., Olanó, A., et al. A GC-FID method for analysis of lysinoalanine. *Mol. Nutr. Food Res.* 5: 415–422, 2007.



140. Bosch, L., Sanz, M.L., Montilla, A., et al. Simultaneous analysis of lysine, *N*-epsilon-carboxymethyllysine and lysinoalanine from proteins. *J. Chromatogr. B-Anal. Technol. Biomed. Life Sci.* 860: 69–77, 2007.
141. Charissou, A., Ait-Ameur, L., and Birlouez-Aragon, I. Evaluation of a gas chromatography/mass spectrometry method for the quantification of carboxymethyllysine in food samples. *J. Chromatogr. A* 1140: 189–194, 2007.
142. Danielson, N.D. and Rogers L.B. Determination of tryptophan in proteins by pyrolysis gas chromatography. *Anal. Chem.* 50: 1680–1683, 1978.
143. Jorgenson, J.W. and Lukacs, K.D. Capillary zone electrophoresis. *Science* 222 (4621): 266–272, 1983.
144. Jorgenson, J.W. and Lukacs, K.D. Free-zone electrophoresis in glass-capillaries. *Clin. Chem.* 27: 1551–1553, 1981.
145. Terabe, S., Otsuka, K., Ichikawa, K., et al. Electrokinetic separations with micellar solutions and open-tubular capillaries. *Anal. Chem.* 56: 111–113, 1984.
146. Terabe, S., Otsuka, K., and Ando, T. Electrokinetic chromatography with micellar solution and open-tubular capillary. *Anal. Chem.* 57: 834–841, 1985.
147. Matsubara, N. and Terabe, S. Separation of 24 dansylamino acids by capillary electrophoresis with a non-ionic surfactant. *J. Chromatogr. A* 680: 311–315, 1994.
148. Corradini, C. and Cavazza, A. Application of capillary zone electrophoresis (CZE) and micellar electrokinetic chromatography (MEKC) in food analysis. *Ital. J. Food Sci.* 10: 299–316, 1998.
149. Klampfl, C.W. Analysis of organic acids and inorganic anions in different types of beer using capillary electrophoresis. *J. Agric. Food Chem.* 47: 987–990, 1999.
150. Klampfl, C.W., Buchberger, W., Turner, M., et al. Determination of underivatized amino acids in beverage samples by capillary electrophoresis. *J. Chromatogr. A* 804: 347–355, 1998.
151. Ye, J. and Baldwin, R.P. Determination of amino acids and peptides by capillary electrophoresis and electrochemical detection at a copper electrode. *Anal. Chem.* 66: 2669–2674, 1994.
152. Cavazza, A., Corradini, C., Lauria, A., et al. Rapid analysis of essential and branched-chain amino acids in nutraceutical products by micellar electrokinetic capillary chromatography. *J. Agric. Food Chem.* 48: 3324–3329, 2000.
153. Skoc̆ir, E., Vindevogel, J., and Sandra, P. Separation of 23 dansylated amino acids by micellar electrokinetic chromatography at low temperature. *Chromatographia* 39: 7–10, 1994.
154. Arellano, M., Simeon, N., Puig, P., et al. Several applications of capillary electrophoresis for wines analysis. Quantitation of organic and inorganic acids, inorganic cations, amino acids and biogenic amines. *J. Int. Sci. Vigne Vin.* 31: 213–218, 1997.
155. Castagnola, D.V., Rossetti, D.V., Cassiano, L., et al. Optimization of phenylthiohydantoinamino acid separation by micellar electrokinetic capillary chromatography. *J. Chromatogr.* 638: 327–333, 1993.
156. Otsuka, K., Terabe, S., and Ando, T. Electrokinetic chromatography with micellar solutions separation of phenylthiohydantoin-amino acids. *J. Chromatogr.* 332: 219–226, 1985.
157. Boniglia, C., Carratu, B., and Sanzini, E. Enantiomer separation of D–L branched amino acids by capillary electrophoresis in sport nutritional supplements. *J. Food Sci.* 67: 1352–1355, 2002.
158. Liu, J., Cobb, K.A., Novotny, M., et al. Separation of pre-column *ortho*-phthalaldehyde-derivatized amino acids by capillary zone electrophoresis with normal and micellar solutions in the presence of organic modifiers. *J. Chromatogr.* 468: 55–65, 1989.
159. Matsubara, N. and Terabe, S. Micellar electrokinetic chromatography. *Meth Enzymol.* 270 (Part A): 319–341, 1996.
160. Tivesten, A., Lundqvist, A., and Folestad, S. Selective chiral determination of aspartic and glutamic acid in biological samples by capillary electrophoresis. *Chromatographia* 44: 623–633, 1997.
161. Otsuka, K. and Terabe, S. Effect of methanol and urea on optical resolution of phenylthiohydantoin-DL-amino acids by micellar electrokinetic chromatography with sodium *N*-dodecanoyl-L-valinate. *Electrophoresis* 11: 982–984, 1990.

162. Chen, N. and Terabe, S. A quantitative study on the effect of organic modifiers in micellar electrokinetic chromatography. *Electrophoresis* 16: 2100–2103, 1995.
163. Chen, N., Terabe, S., and Nakagawa, T. Effect of organic modifier concentrations in micellar electrokinetic chromatography. *Electrophoresis* 16: 1457–1462, 1995.
164. Rubio-Barroso, S., Santos-Delgado, M.J., Martin-Oliver, C., et al. Indirect chiral HPLC determination and fluorimetric detection of D-amino acids in milk and oyster samples. *J. Dairy Sci.* 89: 82–89, 2006.
165. Soga, T. and Heiger, D.N. Amino acid analysis by capillary electrophoresis electrospray ionisation mass spectrometry. *Anal. Chem.* 72: 1236–1241, 2000.
166. Finot, P.A., Deutsch, R., and Bujard, E. The extent of the Maillard reaction during the processing of milk. *Prog. Food Nutr. Sci.* 5: 345–355, 1981.
167. Finot, P.A., Bricout, J., Viani, R., et al. Identification of a new lysine derivative obtained upon acid hydrolysis of heated milk. *Experientia* 24: 1097–1099, 1968.
168. Faist, V., Drusch, S., Kiesner, C., et al. Determination of lysinoalanine in foods containing milk protein by high-performance chromatography after derivatisation with dansyl chloride. *Int. Dairy J.* 10: 339–346, 2000.
169. Pellegrino, L., Resmini, P., DeNoni, I., et al. Sensitive determination of lysinoalanine for distinguishing natural from imitation mozzarella cheese. *J. Dairy Sci.* 79: 725–734, 1996.
170. Ferrer, E., Alegría, A., Farré, R., et al. Indicators of damage of protein quality and nutritional value of milk. *Food Sci. Technol. Int.* 5: 447–461, 1999.
171. Wilkinson, J., Hewavitharana, A.K. Lysinoalanine determination in sodium caseinate using the LKB Alpha Plus Amino Acid Analyser. *Milch. Milk Sci. Int.* 52: 423–427, 1997.
172. Leclere, J., Birlouez-Aragón, I., and Meli, M. Fortification of milk with iron-ascorbate promotes lysine glycation and tryptophan oxidation. *Food Chem.* 76: 491–499, 2002.
173. Couch, J.R. and Thomas, M.C. A comparison of chemical methods for the determination of available lysine in various proteins. *J. Agric. Food Chem.* 24: 943–946, 1976.
174. Rufián-Henares, J.A., Delgado-Andrade, C., Jiménez-Pérez, S., et al., Assessing nutritional quality of milk-based sport supplements as determined by furosine. *Food Chem.* 101: 573–578, 2007.
175. Resmini, P., Pellegino, L., and Cattaneo, S. Furosine and other heat-treatment indicators for detecting fraud in milk and milk products. *Ital. J. Food Sci.* 15: 473–484, 2003.
176. Rodríguez, C., Frías, J., Vidal-Valverde, C., et al. Total chemically available (free and intrachain) lysine and furosine in pea, bean, and lentil sprouts. *J. Agric. Food Chem.* 55: 10275–10280, 2007.
177. Hernández, A., Serrano, M.A., Muñoz, M.M., et al. Liquid chromatographic determination of the total available (free and intrachain) lysine in various foods. *J. Chromatogr. Sci.* 39: 39–43, 2001.
178. Albalá-Hurtado, S., Bover-Cid, S., and Izquierdo-Pulido, M. Determination of available lysine in infant milk formulae by high-performance liquid chromatography. *J. Chromatogr. A* 778: 235–241, 1997.
179. Carpenter, K.J. The estimation of the available lysine in animal-protein foods. *Biochem. J.* 77: 604–610, 1960.
180. Ferrer, E., Alegría, A., Farré, R., et al. Fluorometric determination of chemically available lysine: Adaptation, validation and application to different milk products. *Nahrung-Food* 47: 403–407, 2003.
181. Vigo, M.S., Malec, L.S., Gómez, R.G., et al. Spectrophotometric assay using *ortho*-phthaldialdehyde for determination of reactive lysine in dairy-products. *Food Chem.* 44: 363–365, 1992.
182. Serrano, M.A., Castillo, G., Muñoz, M.M., et al. Influence of hydrolysis, purification, and calibration method on furosine determination using ion-pair reversed-phase high-performance liquid chromatography. *J. Chromatogr. Sci.* 87–91, 2002.
183. Delgado, N., Corzo, G., Santa-María, M.L., et al. Determination of furosine in milk samples by ion-pair reversed phase liquid chromatography. *Chromatographia* 33: 374–376, 1992.
184. Resmini, P. and Pellegrino, L. Analysis of food heat damage by direct HPLC of furosine. *Int. Chromatogr. Lab.* 6: 7–11, 1991.

185. Resmini, P., Pellegrino, L., and Battelli, G. Accurate quantification of furosine in milk and dairy products by a direct HPLC method. *Ital. J. Food Sci.* 2: 173–184, 1990.
186. Ebersdobler, H.F. and Somoza, V. Forty years of furosine—Forty years of using Maillard reaction products as indicators of the nutritional quality of foods. *Mol. Nutr. Food Res.* 51: 423–430, 2007.
187. Tokusoglu, O., Akalin, A.S., and Unal, K. Rapid high performance liquid chromatographic detection of furosine (epsilon-*N*-2-furoylmethyl-L-lysine) in yogurt and cheese marketed in Turkey. *J. Food Qual.* 29: 38–46, 2006.
188. Tokusoglu, O., Akalin, A.S., and Unal, K. A rapid high performance liquid chromatographic detection of furosine (epsilon-*N*-2-furoylmethyl-L-lysine) in pasteurized and UHT milks. *Milch-Milk Sci. Int.* 59: 502–505, 2004.
189. Marconi, E., Panfili, G., and Acquistucci, R. Microwave hydrolysis for the rapid analysis of furosine in foods. *Ital. J. Food Sci.* 9: 47–55, 1997.
190. Delgado-Andrade, C., Rufian-Henares, J.A., and Morales, F.J. Fast method to determine furosine in breakfast cereals by capillary zone electrophoresis. *Eur. Food Res. Technol.* 221: 707–711, 2005.
191. Vallejo-Córdoba, B., Mazorra-Manzano, M.A., and González-Córdova, A.F. New capillary electrophoresis method for the determination of furosine in dairy products. *J. Agric. Food Chem.* 52: 5787–5790, 2004.
192. Tirelli, A. Improved method for the determination of furosine in food by capillary electrophoresis. *J. Food Prot.* 6: 11400–1404, 1998.
193. Tirelli, A. and Pellegrino, L. Determination of furosine in dairy products by capillary zone electrophoresis: A comparison with the HPLC method. *Ital. J. Food Sci.* 7: 379–385, 1995.
194. Puscasu, C. and Birlouez-Aragon, I. Intermediary and/or advanced Maillard products exhibit prooxidant activity on Trp: In vitro study on alpha-lactalbumin. *Food Chem.* 78: 399–406, 2002.
195. Pintér-Szakács, M. and Molnár-Perl, I. Determination of tryptophan in unhydrolyzed food and feed-stuffs by the acid ninhydrin method. *J. Agric. Food Chem.* 38: 720–726, 1990.
196. Fletouris, D.J., Botsoglou, N.A., Papageorgiou, G.E., et al. Rapid-determination of tryptophan in intact proteins by derivative spectrophotometry. *J. Assoc. Off. Anal. Chem. Int.* 76: 1168–1173, 1993.

# Chapter 3

---

# Peptides

---

Isidra Recio and Rosina López-Fandiño

## CONTENTS

3.1	Introduction.....	33
3.2	Conventional Methods for Peptide Analysis .....	34
3.2.1	Electrophoretic Methods.....	34
3.2.2	Chromatographic Methods.....	40
3.2.3	Spectroscopic Techniques.....	45
3.2.4	Immunochemical Methods.....	46
3.3	Mass Spectrometry for Peptide Analysis.....	47
3.3.1	Instrumentation .....	47
3.3.2	Tandem Mass Spectrometry.....	49
3.3.3	Interpretation of Mass Spectra .....	49
3.3.4	Applications to Dairy Peptides .....	50
3.3.4.1	Milk Proteomics.....	50
3.3.4.2	Biologically Active Peptides.....	51
3.3.4.3	Evaluation of Proteolysis.....	59
3.3.4.4	Quantitative Analysis of Peptides by Mass Spectrometry .....	59
3.4	Future Prospects .....	63
	Acknowledgments.....	63
	References.....	63

## 3.1 Introduction

Peptides produced by the hydrolysis of milk proteins during technological processes and storage greatly influence the functional and biological properties of dairy products. For instance, in cheese, proteolysis during ripening is the most important biochemical event that decisively

contributes to texture and flavor development through the degradation of the protein network and formation of savory peptides and substrates for secondary catabolic changes [1]. On the other hand, modification of milk proteins based on enzymatic hydrolysis has a broad potential for designing hydrolysates containing peptides with the required functionality for specific applications, such as milk proteins, caseins, and whey proteins, which are commercially available in large quantities at a reasonable cost [2]. There also exists a possibility to modify hydrolysis to produce peptides for hypoallergenic formula, special diets, or clinical nutrition. Functional applications include improved whipping, gelling, and solubility of the formulated products. In addition, during the last two decades, several studies have shown the presence of peptides with biological activity [3]. These peptides are hidden in a latent state within the precursor protein sequence, but can be released by enzymatic proteolysis during gastrointestinal digestion *in vivo*, or during the manufacture of milk products. Thus, proteolysis during milk fermentation and cheese ripening leads to the formation of various peptides, some of which are capable of exhibiting bioactivities mentioned earlier or act as precursors of the active forms.

Irrespective of the target function, it is important to characterize milk peptides on the basis of size, sequence, posttranslational modifications (e.g., phosphorylation, glycosylation), chemical modifications occurring during processing, storage, etc. This implies separation, identification, and quantitative determination of peptides formed as a part of complex mixtures. This information can be used to explain their influence on the biological activity, flavor, and functional properties of food containing milk peptides, and can also be used for product authenticity and history assessment. Peptide analysis can also be applied for the characterization of milk proteins using a proteomic approach or to assess the specificity and suitability of proteolytic enzymes for certain uses [4].

This chapter deals with the main analytical techniques for milk-peptide analysis, and is divided into two parts. The first section deals with the conventional methods for peptide separation, detection, and quantification, such as electrophoretic and chromatographic methods, as well as spectroscopic and immunochemical techniques. However, an exhaustive description of these techniques is not included in this chapter, because a detailed explanation of their analytical basis can be found in the work of Gonzalez de Llano et al. [5]. Instead, the first part of the chapter focuses on the most recent applications of milk-peptide analysis, stressing the newest contributions to the assessment of quality of dairy-based products. The second section pays special attention to mass spectrometry, because its application to milk peptides has grown enormously during the last decade, constituting, nowadays, a key tool in this area. A brief survey of the most commonly used ionization techniques (electrospray and matrix-assisted laser desorption/ionization) and the mass analyzers is also included, along with several examples that illustrate the application of mass spectrometry in the analysis of dairy peptides.

## **3.2 Conventional Methods for Peptide Analysis**

### **3.2.1 Electrophoretic Methods**

Polyacrylamide gel electrophoresis (PAGE) has been widely applied to the study of milk proteins and large milk-derived peptides. These can be separated according to their mass to charge ratio (native PAGE or urea-PAGE), isoelectric point along a pH gradient (isoelectric focusing [IEF]), or molecular weight (sodium dodecyl sulfate-polyacrylamide gel electrophoresis [SDS-PAGE]). Classic PAGE methods are commonly used to monitor protein degradation while allowing the simultaneous detection of big proteolytic fragments. Table 3.1 shows several recent examples of the application of PAGE to study the extent and type of primary proteolysis in cheese. In most of these

**Table 3.1 Examples of Methods for Peptide Analyses Used for the Characterization of Cheese Ripening**

<i>Analytical Method<sup>a</sup></i>	<i>Chemometric or Other Method<sup>b</sup></i>	<i>Application and Main Results</i>	<i>References</i>
RP-HPLC of the WSF < 1000 Da	Analysis of volatile compounds	Several nitrogen and volatile compounds were characteristic of each of six Spanish cheese varieties	[6]
Urea-PAGE		Assessment of changes in the level of proteolysis in the internal portions of Pecorino Siciliano cheese	[7]
RP-HPLC			
Urea-PAGE of CN		There were only minor differences in the concentration of some peptides among Tulum cheese ripened in goat's skin bags (tulums) or plastic containers. Age-related differences were significant	[8]
RP-HPLC of NCN, EtSF, and non-EtSF			
CE of cheese samples	PCA	There were systematic differences between dairies in caseins and peptides, but only minor differences in sensory attributes	[9]
RP-HPLC of the WSF	Sensory analysis		
Urea-PAGE of CN	PCA	Ragusano cheeses were differentiated by age and farm origin using exploratory data analysis (PCA and HCA) of peptide profiles	[10]
RP-HPLC of EtSF and non-EtSF	HCA		
	PLS		
	PLSDA		
Urea-PAGE of CN	PCA	Multivariate analysis on soluble peptide profiles detected sample grouping in Mozzarella cheeses according to ripening time, but not by the cheese-making technology (stretching temperature, fat content, and time of brining)	[11]
RP-HPLC of WSF			
Urea-PAGE of CN		Proteolysis was similar in Kefalograviera cheeses of different sodium contents	[12]
RP-HPLC of WSF			
RP-HPLC of TCA-SF	PCA	Total salt concentration and ripening temperature significantly affected secondary proteolysis in Fynbo cheese, while NaCl replacement by KCl had no effect	[13]
Urea-PAGE of cheese		Increasing cooking temperature during cheese manufacture increased the relative contribution of plasmin, but decreased chymosin activity	[14]
RP-HPLC of WSF			

*(continued)*

**Table 3.1 (continued) Examples of Methods for Peptide Analyses Used for the Characterization of Cheese Ripening**

<i>Analytical Method<sup>a</sup></i>	<i>Chemometric or Other Method<sup>b</sup></i>	<i>Application and Main Results</i>	<i>References</i>
RP-HPLC of WSF	PCA	Cheese samples were separated according to the temperature of cheese milk treatment, cheese age, and trial	[15]
PAGE	PCA	Peptide profiles differentiated conventional and UF Iranian cheeses	[16]
RP-HPLC of WSF			
CE of cheese		Differences in casein degradation and appearance of breakdown products in Havarti cheese made from UF milk can result from inactivation of the plasminogen-activation system during UF concentration	[17]
Electrophoretic analysis of slurries		Despite differences in the cooking temperature, residual activity of chymosin was similar during manufacture of Cheddar and Swiss Cheese	[18]
Urea-PAGE of the nonWSF and non-EtSF	PCA (biochemical parameters, proteolysis, lipolysis, and flavor)	The use of lamb rennet paste and the time of the year influenced the composition and sensory properties of Idiazabal cheese	[19]
RP-HPLC of WSN	Sensory evaluation of bitterness	Bitterness in ewe's milk cheese made with microbial coagulant was correlated with peptides of MW 165–6500, but not with total hydrophobic peptides	[20]
SE-HPLC of the hydrophobic peptides			
Urea-PAGE of CN	PCA	Statistical analysis of results allowed clear discrimination between cheeses on the basis of coagulant used (crustacean <i>Munida</i> in comparison with chymosin)	[21]
RP-HPLC of EtSF			
Urea-PAGE of CN	PCA	Hydrophobic peptides contribute to the differentiation of cheeses made with plant coagulant or calf rennet	[22]
RP-HPLC of WSN			
RP-HPLC of pH 4.6, ethanol soluble, and non-EtSF	PCA	Manchego cheese samples were distributed according to the starter used in their manufacture (defined strain and <i>Lactobacillus plantarum</i> as adjunct)	[23]
CE		The peptide profile reflected variations in the composition of starter and nonstarter bacteria within dairies	[24]
RP-HPLC			

**Table 3.1 (continued) Examples of Methods for Peptide Analyses Used for the Characterization of Cheese Ripening**

<i>Analytical Method<sup>a</sup></i>	<i>Chemometric or Other Method<sup>b</sup></i>	<i>Application and Main Results</i>	<i>References</i>
Urea-PAGE	PCA	Low-fat high-moisture Kefalograviera cheeses were differentiated according to the starter culture and the scalding temperature	[25]
RP-HPLC of WSF, TCA-SF, and PTA-SF	CA		
RP-HPLC of EtSF	PCA	Peptides differentiated Cheddar cheeses based on the strain used as primary starter	[26]
Urea-PAGE of whole cheese and of NCN		Mozzarella cheese made by direct acidification had higher concentration and more hydrophobic peptides than that made with starter culture	[27]
RP-HPLC of NCN and EtSF			
Urea-PAGE of NCN	PCA	Turkish white-brined cheeses were significantly different in terms of their peptide profiles and quality, and they were grouped based on the use and type of starter and stage of ripening	[28]
	HCA		
RP-HPLC of NCN and EtSF	Sensory scores		
RP-HPLC of WSN	Correlation analysis	Peptide profiles of cheeses made using different strains of lactobacilli correlated with functional properties	[29]
	Functional properties (hardness, melt, and stretch)		
CE		Assessment of the effect of the enzymatic activity of <i>Micrococcus</i> to accelerate cheese ripening	[30]
RP-HPLC			
CE of cheese samples	Correlation analysis	Effect of the addition of nisin, free or incorporated in microparticles, a nisin-producing adjunct culture, and/or high hydrostatic pressure to accelerate Hispanico cheese ripening	[31–33]
RP-HPLC of WSN	PCA		
	Sensory analysis		
	Texture		
PAGE-urea of NCN	PCA	Addition of a plasminogen activator to Cheddar cheese accelerated the conversion of plasminogen to plasmin and proteolysis upon ripening	[34]
RP-HPLC of EtSF			

(continued)



**Table 3.1 (continued) Examples of Methods for Peptide Analyses Used for the Characterization of Cheese Ripening**

<i>Analytical Method<sup>a</sup></i>	<i>Chemometric or Other Method<sup>b</sup></i>	<i>Application and Main Results</i>	<i>References</i>
PAGE of CN	PCA	Profiles of caseins and peptides were similar in control, 50 MPa, and 400 MPa treated cheese, but there were different levels of free amino acids	[35]
RP-HPLC of EtSF	CA		
RP-HPLC of the NNC	LC-MS <sup>a</sup> analysis of selected peptides	Study of the mechanism of casein breakdown by chymosin and plasmin in cheeses, where microbial activities were prevented	[36]
RP-HPLC of NCN	IE-FPLC <sup>a</sup> for fractionation	Characterization and identification of phosphopeptides in Herrgard cheese	[37]
	MS <sup>a</sup>		
	N-terminal sequencing		
CE		Hydrolysis of certain casein fractions explained the undesired flavor developments in cheese and other products carried out with a neutral protease of <i>Bacillus subtilis</i>	[38]
CE of CN fraction	PCA	A PCR model constructed with the peak areas of the neutral CE electropherograms made it possible to predict the ripening time of ewe's milk cheese or mixture of cow's and ewe's milk cheeses	[39,40]
	PCR		
	PLS		

<sup>a</sup> CE, capillary electrophoresis; PAGE, polyacrylamide gel electrophoresis; IE-FPLC, ion-exchange fast protein liquid chromatography; RP-HPLC, reverse phase high-performance liquid chromatography; CN, casein; NCN, noncasein nitrogen; EtSF, 70% ethanol soluble fraction; MS, mass spectrometry; PTA-SF, phosphotungstic acid soluble fraction; TCA-SF, trichloroacetic acid soluble fraction; WSF, water-soluble fraction.

<sup>b</sup> CA, cluster analysis; PCA, principal component analysis; HCA, hierarchical CA; PCR, principal component regression; PLS, partial least squares regression analysis; PLSDA, partial least squares discriminant analysis.

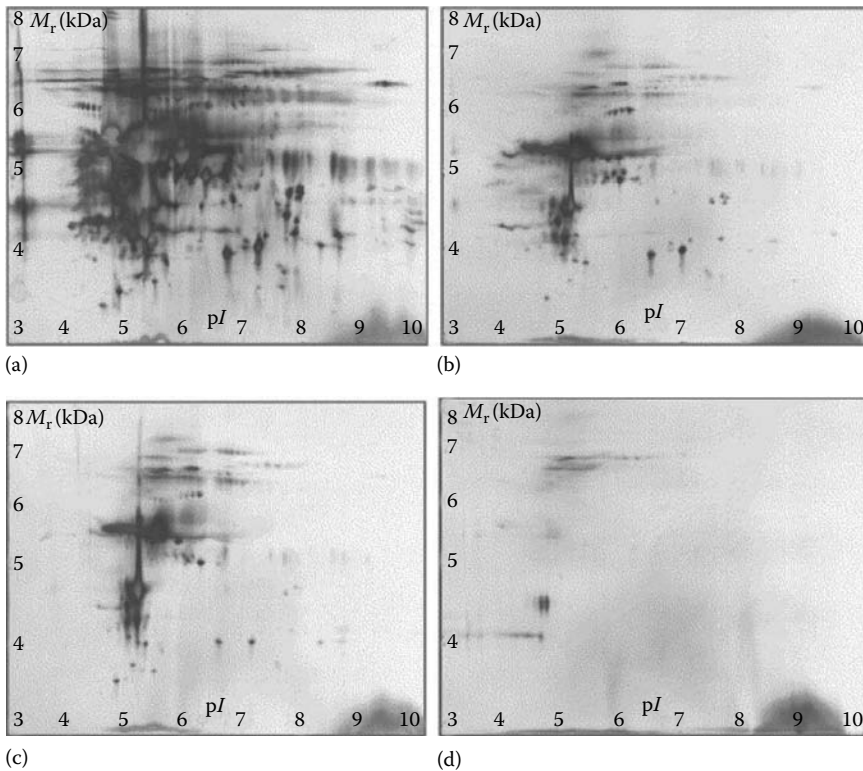
cases, the differential degradation of  $\alpha_{s1-}$ ,  $\alpha_{s2-}$ , and  $\beta$ -caseins (CN) and the appearance of specific degradation products (such as  $\gamma$ -CN) have set the basis for cheese classification. However, peptides of medium to small size are not well resolved or fixed in polyacrylamide gels, despite various efforts to improve their analysis by using gels with a high percentage of polyacrylamide, adding cross-linking agents, or modifying the composition of the buffer system [5]. In fact, the resolving power, reproducibility, and quantification of low molecular weight peptides in PAGE gels are not satisfactory, paving the way for capillary electrophoresis (CE) and chromatographic methods, and limiting

the use of PAGE to qualitative purposes. In any case, it is worth mentioning that it is possible to identify milk peptides separated by PAGE analysis. For instance, peptides visible by electrophoresis (Tricine-SDS-PAGE) can be sequenced by Edman degradation following electroblotting [41].

However, it should be noted that the combination of two electrophoretic methods into a two-dimensional separation (2-DE) gives unparalleled resolution of complex protein and/or peptide mixtures. When using 2-DE, proteins are usually separated by IEF in the first dimension and by SDS-PAGE in the second dimension. The gel is stained to visualize the protein pattern and the use of image-analysis software is helpful for evaluation. Protein identification of the spots on the gels can be performed by gel comparison, microsequencing, matrix-assisted laser desorption/ionization-time-of-flight (MALDI-TOF) mass spectrometry, peptide mass fingerprinting, or peptide sequencing using tandem mass spectrometry. Several papers have dealt with 2-DE analyses of bovine milk proteins as well as human, horse, and goat milk proteins, but 2-DE analyses of peptides are limited. Lindmark-Mansson et al. [42] studied the 2-DE pattern of peptides in milk samples and the changes in the peptide composition of colostrum collected 0–6 days postpartum, with the aim to trace the somatic cell count and the temperature with the intensity and number of peptide spots (Figure 3.1). Similarly, 2-DE separations (according to their charge/mass ratio by urea-PAGE at alkaline pH in the first dimension and isoelectric point by IEF in the second dimension) of proteins in 6-month-old Iberico cheese, a semihard Spanish variety manufactured from mixtures of cow's, ewe's, and goat's milk, allowed the elucidation of a complex and characteristic peptide map from each milk species [43].

“CE separations” offer a much higher precision and accuracy in the quantitative determination of peptides than the classical PAGE methods [44]. Owing to its advantages, the application of CE for the assessment of proteolysis in different cheese types has acquired an enormous importance in the past few years, as exemplified in Table 3.1. Several research groups have used hydrophilically coated capillaries and phosphate/urea buffers with polymeric additives at acid pH, or similar electrophoretic conditions but with uncoated silica capillaries, to separate the individual milk proteins and some of their genetic variants (see [45] for a review). CE has been hardly used specifically for the analysis of peptides, although it proved useful to separate the main degradation products arising from the action of different proteolytic agents on caseins and whey proteins in cheese, providing a very high resolution of protein fragments and peptides that, in some cases, differed in just one amino acid residue [24,43,46–48]. Furthermore, unlike conventional electrophoresis, there exists no limitation in the size of the components to be separated. For instance, CE analysis of the casein fraction of Serpa cheeses offered a rapid, straightforward method for the authentication of Protected Designation of Origin (PDO) cheeses made with *Cynara cardunculus*, through the presence of a peptide peak, specific for that coagulant that could be used as a marker [49].

In other dairy products, such as UHT or pasteurized milk, CE analysis of peptides can be performed to assess the extent of protein degradation during storage as a measurement of their keeping quality. Proteinase activity in UHT milk causes bitterness and gelation problems. This activity can be owing to the residual native alkaline proteinase (plasmin) or bacterial proteinases that originate from the growth of psychrotrophic bacteria in raw milk, which survive the UHT treatment that destroys the parent organisms. Bacterial proteinases of psychrotrophic origin are very specific toward  $\kappa$ -CN, releasing *para*- $\kappa$ -CN and caseinmacropeptide (CMP)-related soluble peptides, and thus, their action can be followed by the CE analysis of *para*- $\kappa$ -CN in the CN fraction [50] or CMP in the deproteinized noncasein nitrogen (NCN) fraction [51]. Plasmin mainly hydrolyzes  $\beta$ -CN, producing the pH 4.6-insoluble  $\gamma$ -CN and the water-soluble proteose peptones (PP). Products insoluble at pH 4.6, arising from plasmin action, can be analyzed by CE of the casein fraction, as shown in a study on plasmin activity in milk submitted to high pressure [52].



**Figure 3.1** 2-DE of peptides in permeate samples originating from ultrafiltered milk with various somatic cell counts. The gels show molecular weights ( $M_r$ ) and isoelectric points ( $pI$ ) of permeate samples: (a) cell count of  $980 \times 10^3$  cells  $\text{mL}^{-1}$ ; (b) cell count of  $140 \times 10^3$  cells  $\text{mL}^{-1}$ ; (c) cell count of  $50 \times 10^3$  cells  $\text{mL}^{-1}$ ; and (d) cell count of  $20 \times 10^3$  cells  $\text{mL}^{-1}$ . The samples were separated using IPG strip at pH 3–10 (linear pH gradient) in the first dimension and ExcelGel SDS 2-D Homogeneous 15% in the second dimension. Apparent molecular weight ( $M_r$ , logarithmic scale) and  $pI$  are indicated on the vertical and horizontal axes, respectively. (From Lindmark-Mansson, H. et al., *Int. Dairy J.*, 15, 111, 2005. With permission.)

Several methods for data analysis in CE can be used to extract relevant information contained in the electrophoretic responses, mainly the characterization of complex samples, the study of peak purity, deconvolution of comigrations, and the quantification of analytes in poorly resolved peaks, and these have been reviewed by Sentellas and Saurina [53].

### 3.2.2 Chromatographic Methods

Different chromatographic techniques have been extensively used in the characterization of protein hydrolysates and in the studies of enzyme activity and specificity. Among them, size exclusion (SE)-fast protein liquid chromatography (FPLC) and SE-high-performance liquid chromatography (HPLC) are accurate and efficient processes to evaluate and monitor protein degradation [54,55]. In addition, similar to SDS-PAGE, they allow the determination of the molecular mass of concomitantly appearing large- to medium-sized peptides. Furthermore, in the absence of

reducing agents, all these methods can verify the lack of aggregates formation or denaturation phenomena. Separation of components using SE-HPLC is principally based on the differences in the hydrodynamic volume of molecules, depending on their size and conformation. However, in protein hydrolysates, in addition to the molecular-weight distribution of the peptides, there also exists a nonideal retention of peptides owing to electrostatic and hydrophobic interactions. Thus, van der Ven et al. [56] correlated (by calculation of correlation coefficients and by partial least squares (PLS) regression) the molecular weight distribution of whey protein and casein hydrolysates obtained with 11 commercial enzymes, estimated by SE-HPLC, with their foaming properties. However, among the chromatographic techniques, reverse phase (RP)-HPLC is known to produce the most efficient separation of small peptides, while providing useful information regarding their hydrophobicity, and thus, it is frequently used to relate the physicochemical properties of milk-protein hydrolysates with the functional properties of the generated products [57].

“RP chromatography” is primarily, although not exclusively, based on differences in the hydrophobicity. In the case of small peptides, retention time appears to depend mainly on amino acid composition, while the retention time of larger peptides is also influenced by other effects, like conformational effects and molecular weight. Accordingly, the molecular-weight distribution of milk-protein hydrolysates could be predicted, in principle, on the basis of their RP-HPLC profiles, by using retention-time coefficients, calculated from a data set of retention times, and the amino acid composition of peptides from the same protein source [58]. However, the situation is far more complex in practice, because RP-HPLC profiles of milk-protein hydrolysates may cover over thousands of peptides derived from the four original casein molecules, different genetic and chemical variants, and from whey proteins. In this respect, it should be noted that multivariate statistical analysis offers a number of methods that are capable of extracting relevant information from such large data matrices. These have been recently reviewed by Coker et al. [59].

Prior to chemometric analysis, chromatographic data (raw signal) are usually transformed and reduced to replace a large number of measurements by a few characteristic data with all the relevant information. As explained by Piraino et al. [60], if the identities of the peaks in the chromatograms are known, then data processing can be simplified by considering the peak itself as a variable. Milk peptides have been identified by using amino acid sequencing and mass spectrometry, which will be covered in detail in the second part of the chapter. However, when the identities of the peaks are unknown, chromatographic data have to be processed to obtain variables, and this step can be time-consuming or can represent a source of error. Peak or band identification by visual matching is still the most common approach used to obtain variables from chromatograms (and also from electropherograms) of milk peptides. In addition, other approaches have been used, such as dividing chromatograms into sections and integrating each section. Piraino et al. [60] employed fuzzy logic to handle, in a systematic way, the uncertainty in the position of peptide peaks, and chromatograms were processed considering the classes of retention time, wherein peak heights were calculated by using the distance from the center of the class as a weight.

The water-soluble fraction (WSF), ethanol-soluble fraction (EtSF), or pH 4.6-soluble fraction (NCN) of cheese are commonly analyzed by RP-HPLC for the characterization of the peptide patterns. The information contained in the peptide profiles of cheese extracts is used to understand the biochemical pathways involved in proteolysis, which is valuable to typify the ripening process and to understand the influence of manufacturing practices on the properties of cheese. Thus, the number and concentration of peptides are usually compared, for instance, to differentiate various cheese varieties [61], or products of the same variety produced following different cheese-making technologies or in different regions [62,63]. Several recent examples of the use of RP-HPLC to follow the proteolysis in cheese are shown in Table 3.1.

While an indication of total proteolysis can be obtained by measuring the total peak area for all the peptides in each chromatogram, certain peptides are typical for a specific cheese during ripening and thus can be used to control the ripening process or to guarantee the authenticity of the cheese variety. For instance, the peptide composition at different ages is characteristic of the starter used [64,65]. In fact, starters can be selected based on the proteolytic RP-HPLC pattern that they produce when they act on the milk proteins (i.e., by the release of the fragment  $\alpha_{S1}$ -CN f 1–23), which correlates with their ability to improve the functional properties of cheese (i.e., Mozzarella cheese [66]) or to avoid the development of bitter flavor [67,68]. Similar studies have been conducted to assess the suitability of microorganisms belonging to the secondary flora of some cheeses, such as *Geotrichum candidum* and *Penicillium camemertii* [69], or of adjunct cultures [70]. The peptide pattern has also been used to characterize the proteolytic activity of different coagulant enzymes used as rennet substitutes [21,22,71]. The extent of the released peptides is monitored during ripening, and the end results may indicate that some peptides of interest may disappear and new ones may appear during the time period considered.

In the RP-HPLC analysis of cheese peptides, it is very popular to calculate the sum of the areas of the total peptide content, with the retention time of Trp being used to differentiate the hydrophobic (eluted after Trp) and the hydrophilic (eluted before Trp) peptides [6]. Differences in the time-dependent ratio between the hydrophobic and hydrophilic peptides suggest the differences in proteinase and/or peptidase specificity in the microorganisms. In general terms, the hydrophobic to hydrophilic peptide ratio tends to decrease as cheese ages [72,73] and a low proportion of hydrophobic peptides can be attributed to the action of starter and nonstarter aminopeptidases that degrade the hydrophobic peptides and release peptides of low molecular mass and amino acids [27]. Furthermore, the estimation of the quantities and the hydrophobic/hydrophilic balance of the peptides present in the WSF of different cheeses might show various degrees of primary proteolysis, owing to the cooking temperature or other manufacturing conditions that influence moisture retention and, ultimately, the contribution of lactococcal enzymes, chymosin, and plasmin to proteolysis during ripening.

In addition, the hydrophobic peptide portion has been considered to be responsible for the bitter taste in cheese [74]. The occurrence of bitterness is attributable to the unbalanced levels of proteolysis and peptidolysis. When extensive degradation of caseins and primary peptides by the activities of proteases produce large amounts of small- and medium-sized hydrophobic peptides that are not adequately removed by the peptidases of the microflora, these accumulate contributing to the bitter taste. The presence of hydrophobic peptides in bitter cheeses is observed to be related to high salt-in-moisture and low moisture contents that limited the enzymatic activities of the microflora, important in secondary proteolysis [75]. In fact, in certain studies, starters have been screened for bitterness using the levels of hydrophobic peptides that they produce, through RP-HPLC and chemometric methods [76,77]. While in some studies, a positive relationship between the hydrophobic peptide concentration, the hydrophobic/hydrophilic ratio, and the bitter taste of the cheeses could not be demonstrated [20], other studies showed the correlations between the profiles of small peptides determined by RP-HPLC and descriptors such as flavor intensity, off-flavor, and bitterness, confirming that peptides provide the background taste of cheese through their bitter and savory-taste properties [22,78].

In this respect and as mentioned earlier, chemometric analysis offers powerful tools to extract information from complex patterns of data. Thus, the application of chemometrics to study the proteolytic profiles in Ragusano cheese revealed that insoluble and soluble peptides with medium hydrophobicity are the most important predictors of age [10]. However, chemometric analyses also showed that the farm origin strongly affected the peptide profiles of the cheese. This was attributed

to the use of traditional technology that not only generates cheeses having unique features, but also a great variability in cheese quality. Such variability affects the biochemical events of cheese ripening, generating unpredictable proteolysis profiles [79]. In contrast, the uniformity of other cheeses, such as Parmigiano-Reggiano and Grana Padano, guaranteed by a well-standardized technology, conforms best to the chemometric modeling of compositional parameters [10]. Multivariate analysis on soluble peptide profiles of Mozzarella cheeses obtained by RP-HPLC also detected sample grouping according to ripening time, but did not evidence any separation caused by the cheese-making technology (stretching temperature, fat content, and time of brining) [11], irrespective of the residual rennet activity that may be significant in these cooked, long-ripened cheeses, depending on the cooking temperature [80].

Moving from cheese to processed milk, the peptides produced by plasmin and the proteinases of psychrotrophic bacteria can be separated by RP-HPLC of WSF, which makes it possible to distinguish between the two enzyme types and to determine both proteolysis and proteinase activity in milk [81,82]. The activity of bacterial proteinases of psychrotrophic origin can be estimated by RP-HPLC of the trichloroacetic acid (TCA) soluble fraction [83]. Similarly, De Noni et al. [84] studied the formation of PP in packaged pasteurized milk during refrigerated storage as a measurement of plasmin action, by employing RP-HPLC of the WSF. The levels of PP increased with the keeping time and were significantly ( $P < 0.05$ ) related to the microbiological quality of the starting raw milk, thus proving to be a reliable analytical index for evaluating ageing.

In addition to their basic nutritional and functional roles, milk proteins are capable of modulating certain biological functions. Some of these functions are mediated by peptides encrypted in the intact proteins that must be released by specific enzymatic hydrolysis to exert their effects on health. In principle, there are two approaches for releasing bioactive peptides from intact milk proteins. One approach is to exploit the proteolytic system of lactic acid bacteria to partially digest the caseins during the manufacture of dairy products, like fermented milk and cheese. The other approach is to subject the isolated milk protein preparations to hydrolysis *in vitro* by one or a combination of enzymes, which results in milk-protein hydrolysates containing a great number of peptides, including the bioactive peptides. The RP-HPLC is normally the analytical technique of choice to characterize milk-derived bioactive peptides, combined with bioactivity assays *in vitro* and/or *in vivo* [85–88]. However, particularly when the hydrolysate contains a large number of peptides, RP-HPLC requires extensive separation steps to detect a peptide of interest without any interference. Thus, it should be mentioned that as these components can represent only the minor constituents in a highly complex matrix, mass spectrometry has become an almost indispensable tool to determine the presence and behavior of bioactive peptides, and this will be explained in detail in the second part of this chapter. As an alternative to the more expensive, but sensitive and rapid, analysis of peptides by HPLC–tandem mass spectrometry, other strategies have been developed to monitor the peptides produced during hydrolytic processes. Zhu et al. [89] developed a column-switching HPLC technique for routine monitoring of the levels of bioactive small peptides with close retention times in food products, which can also be applied for the successive determination of peptides in other crude protein hydrolysates.

Structure–activity relationships have been proposed for some bioactive peptides. For instance, angiotensin-I-converting enzyme (ACE) inhibitors are peptides with hydrophobic amino acids at each of the three C-terminal positions, and it has been evaluated whether there is a correlation between the hydrophilic/hydrophobic proportion of peptides present in different matrices and their biological activity [90]. Hydrophobicity appears to be a property common to many peptides having biological and nutraceutical properties. For instance, medium-sized hydrophobic peptides from milk-protein hydrolysates demonstrate growth-promoting activity on keratinocytes from

human skin *in vitro*, probably by providing essential hydrophobic amino acids to the cell-culture medium [91]. However, with respect to the immunomodulation activity, the global hydrophobicity of peptides in the WSF of French Alp cheeses was not related to their biological activity, although peptide quantity, size, and hydrophobicity were related to the cheese-making technological parameters, such as cheese age and cooking temperature [61].

In addition, in several recent papers, RP-HPLC has been used to assess *in vitro* digestibility of proteins and peptides, to estimate their susceptibility to enzymatic hydrolysis. These studies are popular in the field of bioactive peptides, as many of them have to elude the action of digestive enzymes, to exert their physiological effects *in vivo* on oral administration. Susceptibility to gastric and pancreatic degradation is responsible for some of the peptides to exhibit *in vitro* bioactivity that is ineffective *in vivo* [92]. Protein hydrolysis is initiated by pepsin under acidic pH conditions, to mimic the digestion in the stomach. After this step, the products are hydrolyzed by pancreatic enzymes, such as trypsin, chymotrypsin, and membrane peptidases. Samples are analyzed by RP-HPLC and peptide peaks can be further identified by mass spectrometry [93,94].

Enzymatic hydrolysis of proteins, followed by the matching of specific products of the hydrolysis with particular proteins, has been used for the estimation of the protein content in food products. For instance, RP-HPLC can detect and quantify milk proteins that could be added as adulterants in soybean protein preparations. To this end, mixtures of milk and soyproteins have been hydrolyzed with trypsin and analyzed by RP-HPLC. The areas of the peaks in the chromatographic profiles of trypsin hydrolysates of soybean protein isolate containing different levels of milk protein have been updated into a database to produce a data matrix, and the principal component analysis (PCA) and cluster analysis (CA) have been carried out. Several peptide peaks have been found that could be used as markers for the presence of milk protein in the soybean protein preparations, allowing for the preparation of a special calculation sheet for the quantitative determination of adulteration [95].

Digestibility studies with proteinases can also be used as tools for elucidating conformation changes in the dairy proteins. For instance, in the case of bovine  $\beta$ -lactoglobulin (Lg), considerable evidence provides the basis for correlating its structural transformations to its susceptibility to hydrolysis. Native bovine  $\beta$ -Lg is highly resistant to peptic digestion, because its particular folding at acidic pH makes its peptic cleavage sites (hydrophobic or aromatic amino acid side chains) unavailable for hydrolysis. Thus, fine structural differences between ovine and bovine  $\beta$ -Lg change their susceptibility to pepsinolysis, as assessed by RP-HPLC [96]. Similarly, the different structures of the genetic variants, A, B, or C, of this protein are observed to be related to their stability toward hydrolysis by trypsin, determined by SDS-PAGE and RP-HPLC [97]. The RP-HPLC has also been used to study the structural changes in  $\beta$ -Lg induced by high hydrostatic pressure, which affect its susceptibility to hydrolysis by pepsin, trypsin, and chymotrypsin [98–101]. In these studies, RP-HPLC analyses are combined with HPLC–tandem mass spectrometry for peptide identification to elucidate changes in the accessibility of cleavage sites on the substrate to enzyme action. Similarly, digestibility studies constitute a functional tool to characterize the allergenic potential of proteins. Previously, the susceptibility of  $\beta$ -Lg toward peptic digestion after different processing practices, including fermentation or high pressure, was determined by CE and RP-HPLC, and indirect enzyme-linked immunosorbent assay (ELISA) was used to assess the resulting immunoreactivity against rabbit IgG and human IgE [102,103]. In these studies, the combination of chromatographic and electrophoretic methods of protein and peptide analysis is usually required for physicochemical characterization. Roufik et al. [94] used RP-HPLC, SE-HPLC, native, reducing, and nonreducing PAGE to study the complex formation and conformational changes brought about by the interaction of lactokinin ( $\beta$ -Lg f142–148) with  $\beta$ -Lg A.

In some other cases, the above-mentioned techniques are used for both analytical and preparative purposes. For instance, there are many examples of the application of RP-HPLC to monitor the peptide profile of probiotic and control yoghurts [87,104], cheese extracts [46], milk-protein hydrolysates obtained by enzymatic treatment [105], or fermentation [106], etc. In those cases, along with RP-HPLC analysis, the fractions obtained from SE-FPLC, followed by RP-HPLC, or from successive RP-HPLC runs, are collected, their purity is checked (frequently by CE), and are assayed using HPLC–mass spectrometry, HPLC–tandem mass spectrometry, or N-terminal amino acid sequencing, flavor, or biological activity, to determine the presence or the formation and degradation kinetics of specific peptides.

The examples given earlier illustrate that RP-HPLC is the most popular means of milk-peptide analysis, because these peptides are in a polarity interval that allows them to be well separated on an octadecyl-bonded phase, using aqueous buffers as eluents with a water-miscible solvent. However, in some cases, certain peptides can present low retention in RP packings. “Ion-exchange (IE) chromatography” can be an obvious choice that can be used for practically all charged solutes [37]. In addition, for the very hydrophilic and uncharged compounds, “hydrophilic interaction chromatography” (HILIC) can be used. As explained by Hemstrom and Irgum [107], in HILIC, retention is believed to be caused by the partitioning of the analyte between a water-enriched layer of stagnant eluent on a hydrophilic stationary phase and a relatively hydrophobic bulk eluent (often being 5%–40% water in acetonitrile). The use of water as the strongly eluting solvent gives HILIC a number of advantages over the conventional normal phase chromatography that uses nonpolar eluents that do not easily dissolve the polar analytes. The interface with electrospray (ESI) mass spectrometry is also a problem with normal phase chromatography, as ionization is not easily achieved in the totally organic, nonpolar eluents. The elution order in HILIC is more or less the opposite of that observed in RP separations, which signifies that HILIC works best for solutes that are problematic in RP. Thus, using an amide-bonded silica, suitable for separation of hydrophilic substances, Schlichtherle-Cerny et al. [108] analyzed the components that eluted in the void of a traditional RP-HPLC separation of a Parmesan-cheese extract, using HILIC–ESI–mass spectrometry, and found that it contained more than 25 unique substances, more or less well separated, including Arg, Lys, Glu, and a number of polar dipeptides.

### 3.2.3 Spectroscopic Techniques

In addition to chromatographic methods, spectroscopic methods are also used to characterize food-protein hydrolysates. “Infrared (IR) spectroscopy” is based on the absorption of radiation in the infrared region owing to vibrations between the atoms in a molecule and, therefore, provides information about the chemical composition and conformational structure of the food components. The fingerprint region of the IR spectrum, which is the region from 1800 to 800  $\text{cm}^{-1}$ , is often a very useful part for the analysis of proteins and derived materials, as this is the range absorbed by the bonds forming the amide group (C=O, N–H, and C–N). The two most important vibrational modes of amides are the amide I vibration, caused primarily by the stretching of the C=O bonds, and the amide II vibration, caused by deformation of the N–H bonds and stretching of the C–N bonds. The amide I vibration is measured in the range from 1700 to 1600  $\text{cm}^{-1}$  and the amide II region from 1600 to 1500  $\text{cm}^{-1}$ . The exact frequencies at which these bonds absorb depend on the secondary structure of the proteins or peptides.

As explained by van der Ven et al. [109], it is possible to study the correlations between the IR spectra and functional properties with respect to the hydrolysate as a “black box” system,



characterized by the IR spectrum. Thus, using multivariate regression analysis, the Fourier transform (FT) IR spectra of casein and whey hydrolysates are observed to be correlated to bitterness, solubility, emulsion, and foam properties.

“Raman spectroscopy” is a technique complementary to IR, which also involves vibrational energy levels related to stretching or bending deformation of bonds, but, unlike IR absorption, it depends on the changes in polarizability, mainly affecting the nonpolar groups. In this case, the sample is excited by a laser in the UV, visible, or near-IR region. Following an approach similar to that explained earlier, PLS regression analysis correlated FT-Raman spectra with peptide bitterness [110]. The FT-Raman spectroscopy was also used to study the interaction of cationic peptides, such as lactoferricin with different phospholipid membrane systems [111].

“Fluorescence spectroscopy” can give valuable information about small changes in the protein and lipid structure owing to their high sensitivity to the molecular environment. Intrinsic fluorescence of milk proteins is caused by the three aromatic amino acids: Trp, Tyr, and Phe. Among these three amino acids, Trp dominates the fluorescence emission and provides information about the protein structure. For example, Trp fluorescence is observed to shift to longer wavelength during cheese ripening. This variation is supported by PCA and is suggested to describe the exposure of Trp to the aqueous phase caused by proteolysis and increasing pH levels [112]. Front-face fluorescence spectroscopy is also used to study the interactions between bovine  $\beta$ -Lg and various  $\beta$ -Lg-derived bioactive peptides [113].

“Derivative spectrophotometry” has been used in some studies with varied purposes, including the quantification of proteins and the study of native and denatured proteins. Also, this technique can be used for the characterization of protein hydrolysates, evaluation of the exposition extent of aromatic amino acids during protein hydrolysis, and determination of the extent of encapsulation of casein hydrolysates [114]. According to these authors, this technique may present some advantages over other more traditional ones, owing to its simplicity, quickness, and relatively low cost.

### **3.2.4 Immunochemical Methods**

The majority of the immunoassay methods for peptide analysis uses the ELISA format, and has been mainly applied to allergen detection. The “ELISA competitive assay” is preferred for the detection of peptides. In this case, the antibody is incubated with the diluted sample before being added to the solid phase that contains the immobilized antigen. If there is antigen present in the sample, it inhibits the binding of the antibody to the immobilized antigen, so that the response (produced by using a specific substrate for the reaction with a second specific enzyme-labeled antibody that gives a measurable reaction) is inversely proportional to the concentration of the antigen. As reviewed by Monaci et al. [115], the majority of the immunochemical techniques focuses on the presence of intact proteins and fewer attempts have been reported on the development of assays for the detection of milk-derived peptides. Hence, adaptations have to be made based on the biochemical properties of the representative peptide of interest. Docena et al. [116] studied the residual allergenicity of milk substitutes employed in the treatment of cow’s milk allergy, using different immunoenzymatic methods (ELISA, EAST, and immunoblotting) and patient serum IgE. The residual allergenic components from cow’s milk could be identified in both the moderate and extensive hydrolysates analyzed, suggesting that extensive hydrolysates contained peptides that preserved the immunoreactive epitopes. The immunoreactivity of milk-protein hydrolysates produced with different enzymes was also tested using ELISA [98,117,118].

In addition to ELISA, electrophoresis methods (SDS-PAGE) followed by immunoblotting techniques have been widely used for the visualization of the molecular pattern of peptides in milk-protein hydrolysates [98]. Unfortunately, those techniques generally show a decreased sensitivity when compared with ELISA, owing to the separation and/or transfer process, which makes them less powerful for the detection of low quantities of allergens. In this respect, “immunoassay methods performed on chromatographic systems” retain the advantages of classic ELISA, while avoiding some of the disadvantages. Puerta et al. [119] applied sandwich enzyme-linked immunofluorescence chromatography (ELIAC) to determine  $\beta$ -Lg and its peptides in hypoallergenic formula, showing that peptides of less than 3000 Da demonstrate antigenic character.

As for allergen detection, different immunoassays with antibodies specific for certain peptide fragments, mostly bioactive peptides, have been applied to quantify those fragments in complex hydrolysates or cheeses, and their *in vitro* stability on incubation with gastrointestinal or serum proteinases and peptidases [120,121].

### 3.3 Mass Spectrometry for Peptide Analysis

Although mass spectrometry is used to characterize a wide variety of analytes, the advances in mass spectrometry presented in this chapter focus only on peptides of dairy origin. Mass spectrometry has emerged as an important tool for analyzing proteins and peptides produced from protein digestion, mainly owing to its high sensitivity, speed, and small sample-size requirements.

#### 3.3.1 Instrumentation

Mass spectrometers usually comprise seven major components: a sample inlet, an ion source, a mass analyzer, a detector, a vacuum system, an instrument-control system, and a data system. The sample inlet, ion source, and mass analyzer tend to define the type of instrument and the capabilities of the system. The instruments more widely used in milk-peptide analysis are composed of combinations of inlets, ion sources, and mass analyzers, to produce, basically, four different types of configurations (please note that in recent developments, HPLC has been substituted by CE):

1. HPLC–electrospray-quadrupole mass spectrometer
2. HPLC–electrospray-ion-trap mass spectrometer
3. HPLC–electrospray-quadrupole-time-of-flight mass spectrometer
4. Direct probe matrix-assisted laser desorption/ionization-time-of-flight mass spectrometer (MALDI-TOF)

Until the 1980s, the analysis of proteins and large polypeptides could not be accomplished by mass spectrometry, because of their polarity and nonvolatile nature. The development of ionization techniques, like field desorption, secondary ion, and fast atom bombardment (FAB) represented a major advance in the formation of gaseous proteins or peptides. FAB was the first ionization method that made possible routine mass spectrometric analysis of polar molecules, like peptides. Subsequently, other ionization techniques, such as atmospheric pressure chemical ionization and thermospray ionization were introduced; however, the application of desorption ionization techniques was restricted owing to their low sensitivity and suitability for only a limited range of molecular masses. In the mid-1980s, two ionization techniques, electrospray ionization and MALDI, emerged almost simultaneously for the analysis of proteins and peptides. Their common

features include: ionization without fragmentation, accurate mass determination, picomole-to-femtomole sensitivity, and broad applicability. In the “electrospray ionization mode,” an acidic, aqueous solution that contains the peptides is sprayed through a small-diameter needle. A high, positive voltage is applied to this needle, so that protons from the acidic conditions give the droplets a positive charge, moving them from the needle to the negatively charged instrument. During the course of this movement, evaporation reduces the size of the droplets until the number and proximity of the positive charges split the droplets into a population of smaller, charged droplets. Typically, this evaporation process is aided by a gas (nitrogen) and heat. In the case of “ionization by MALDI,” peptides are dissolved in a solution of a UV-absorbing compound, referred to as matrix. As the solvent dries, the matrix crystallizes, and the peptide molecules are incorporated into the matrix crystals. Pulses of UV laser light are used to vaporize small amounts of the matrix, and the incorporated peptide ions are carried into the gas phase in the process.

The nature of mass analyzers determines several characteristics of the overall experiment, the two most important being mass resolution and mass range. A variety of mass analyzers are available in the market, including quadrupole mass filters, ion trap, time-of-flight (TOF), magnetic sector, ion cyclotron resonance, etc.

“Quadrupole mass spectrometers” are the first mass analyzers to be used routinely in instrument systems that combined ease-of-use and high analytical performance. This type of mass analyzer is, essentially, a mass filter capable of transmitting only the ion of choice. It is composed of four rods, arranged as two sets of two electrically connected rods. A radio frequency voltage is applied between one pair of rods and the other, and a direct current voltage is then superimposed on the radio frequency voltage, so that the ions travel down the quadrupole in between the rods. Only the ions of a certain mass/charge ratio ( $m/z$ ) will reach the detector for a given ratio of voltages, while other ions will follow unstable trajectories, colliding with the rods. This allows the selection of a particular ion or the scanning, by varying the voltages, so that an increasing  $m/z$  is selected to pass through the mass filter and reach the detector. It is important to note that the majority of ions produced is directed out of the instrument and cannot be detected. This inefficient use of the ions significantly limits the sensitivity of the quadrupole instruments, especially when compared with ion traps and TOF mass analyzers. The  $m/z$  range of quadrupole systems typically covers from 10 to 2000, which is sufficient for the majority of peptides found in milk products or milk-protein hydrolysates. The accuracy of the  $m/z$  measurement is such that, when properly calibrated, the measured  $m/z$  of the ion is within approximately  $\pm 0.1$  Da of the true  $m/z$ .

“Ion-trap mass analyzers” are similar to quadrupole mass analyzers in that radio frequency voltages are applied to produce an oscillating trajectory of ions. However, in the ion trap, the fields are applied in such a manner that ions of all  $m/z$  are initially trapped and oscillate in the mass analyzer. Mass analysis is accomplished by sequentially applying an  $m/z$ -dependent matching radio frequency voltage that increases the amplitude of the oscillations in a manner that ejects ions of increasing  $m/z$  out of the trap and into the detector. Therefore, while mass resolution in ion traps is basically similar to that observed in quadrupole mass filters, the sensitivity of the ion-trap systems is much higher than that of quadrupole instruments (up to 500-fold, depending on the operating conditions).

In a “TOF mass analyzer,” the ions are given a certain kinetic energy by acceleration in an electric field generated by the application of high voltage (for peptides, it typically ranges from 20 to 30 kV). After acceleration, the ions enter a field-free region where they travel at a velocity that is inversely proportional to their  $m/z$ . The time required for an ion to travel the length of the field-free region is measured and used to calculate the velocity and the  $m/z$  of the ion. This type

of mass analyzers has good accuracy ( $\pm 0.2$  Da for a 1000 Da ion) as well as unlimited mass range. In addition, they can acquire data rapidly and are extremely sensitive. While quadrupole or ion-trap mass analyzers are limited to  $m/z$  values of less than 2000, in a TOF system, ions of any  $m/z$  can be accelerated and moved from the beginning to the end of the field-free flight tube. The high speed of data acquisition in this type of mass analyzers is related to the fact that no scanning of the mass analyzer is needed, and this speed is only dependent on the flight time of the ions. The high sensitivity is derived from the efficient use of all the ions, as TOF instruments collect all the ions introduced into the mass analyzer. As this mass analyzer requires the introduction of the set of ions to be studied in a pulse, MALDI is considered as the ideal ionization source, which produces ions in short, well-defined pulses. Electrospray can also be used as the ionization source, as long as electrostatic gates are added to control the entry of ions into the mass analyzer.

More detailed information about mass spectrometry instrumentation can be found elsewhere [122–124].

### 3.3.2 Tandem Mass Spectrometry

Mass analysis essentially relies on the separation of ions according to their  $m/z$ . Tandem mass spectrometers use this separation as a preparative tool to isolate an ion with a specific  $m/z$  to be fragmented, so that the  $m/z$  of the fragment ions is determined in a second stage of mass analysis. The term “tandem mass spectrometry” (often abbreviated MS/MS or MS<sup>n</sup>) indicates that two stages of mass analysis are used in a single experiment. Thus, specific ions in a complex mixture can be selectively studied in an experiment that gives the structural information about that ion. In the case of peptide ions, the structural information is the amino acid sequence of the peptide. The fragmentation of the ions is driven by an excess of internal energy in the ion, capable of breaking the covalent bonds to generate ionic and neutral species. The ionic species are referred to as product or fragment ions. The method most commonly used to energize a stable ion, after it has been selected to induce fragmentation reactions, is collisional activation. In this method, the mass-selected ion is transmitted to a high-pressure region of the tandem mass spectrometer, where it undergoes a number of collisions with the gas molecules contained in that region. These collisions make the ion unstable and drive the fragmentation reactions. Finally, the resulting fragment ions are analyzed in the second stage of mass analysis.

One way to classify tandem mass spectrometers is according to how the experiment is accomplished: tandem-in-space or tandem-in-time. Instruments in the “tandem-in-space” category include more than one mass analyzer that perform individually to accomplish the different stages of the experiment. These instruments are, for instance, tandem quadrupole (e.g., triple-quadrupole mass spectrometer), quadrupole-time-of-flight (QTOF), reflectron-time-of-flight, tandem sector, and sector-quadrupole. Instruments that perform tandem mass spectrometry in time have only one mass analyzer. An ion-trap mass analyzer and an ion cyclotron resonance (also known as FT) instruments are examples of this system [122].

### 3.3.3 Interpretation of Mass Spectra

In a typical mass spectrometry experiment, two broad classes of ions can be observed: molecular ions that contain the entire analyte molecule, and fragment ions that contain only a portion of the structure. If the charge ( $z$ ) is known, then the molecular weight of an analyte can be calculated from the  $m/z$  of a molecular ion, whereas the structural information is derived from measuring

the  $m/z$  of the fragment ions obtained in a tandem mass spectrometry experiment. The strategy used for spectra interpretation is an iterative process based on the understanding of the structure of the molecular ions, the reaction mechanisms by which they fragment, and the structure of the products ions that are produced. The fragmentation reactions that lead to the fragment-ion spectrum and its interpretation are beyond the scope of this chapter, but a description of collisionally induced dissociations of protonated peptide ions and interpretations of fragment-ion spectra can be found elsewhere [122].

Complete interpretation of fragment-ion spectra to deduce the entire sequence of a peptide has substantially been replaced by database search programs. These programs use unprocessed- to minimally processed-fragment-ion spectra to search large databases of theoretical spectra derived from the protein, to identify peptide sequences that are consistent with that spectrum. However, databases have not completely eliminated the need for understanding the peptide fragmentation and interpreting fragment-ion spectra. Most search programs can be classified into three categories: programs that use amino acid sequences produced by interpreting the spectra (e.g., FASTA, BLAST, MS-Edman), programs that use peptide molecular-weight information (such as, MS-Fit, MOWSE, PeptideSearch), and programs that use the data from uninterpreted product-ion spectra (e.g., SEQUEST, MS-Tag, PeptideSearch). These databases have grown considerably and will continue to grow in the future, in parallel with the sophistication of the methods and the information available. A recent review on available methods and tools can be found elsewhere [125].

### **3.3.4 Applications to Dairy Peptides**

There are diverse objectives for using mass spectrometry on dairy peptides, such as peptide sequencing from enzymatic mapping for structural characterization of proteins (proteomics), identification of biologically active peptides, evaluation of proteolytic processes, and quantitative determination of peptides in dairy products or protein hydrolysates.

#### **3.3.4.1 Milk Proteomics**

Undoubtedly, an important field of application of peptide analysis by mass spectrometry includes the characterization of milk proteins using a proteomic approach. Briefly, in proteomics, two complementary analytical strategies (gel-based and gel-free approaches) in combination with mass spectrometry analysis are used for separation and characterization of complex protein mixtures. In the first approach (gel-based approach), the protein identification is achieved following the separation of the protein mixture by a high-resolution separation technique (2D gel electrophoresis), protein digestion with proteolytic agents with specific cleavage sites, and sequencing the resulting peptides by tandem mass spectrometry alone or coupled to a separation technique (HPLC or CE). However, this strategy has some limitations in terms of analyzing proteins in low abundance, very high or very low molecular masses, and extreme  $pI$  or hydrophobicities. The second approach, named multidimensional protein identification technology or shotgun proteomics, differs from the first in that all proteins are directly digested in solution and the resulting peptides are fractionated by 2D chromatography (cation-exchange + RP-chromatography), before identification by tandem mass spectrometry and database searching. The critical point of this strategy, hardly used for milk-protein characterization, is the validation of the results obtained from the database searches. A general description of the different proteomic strategies, and the most commonly used protocols for protein digestion and peptide identification processes, including database search programs,

can be found in earlier studies [122,125], and the application of these proteomic approaches for the analysis of food proteins [126,127] and milk proteins [128–130] have also been reviewed.

Different proteomic strategies have successfully been employed for the identification and characterization of genetic variants of milk proteins [131–135], as well as posttranslational modification of proteins such as phosphorylation and glycosylation [136–143]. These procedures have also been employed to follow disulfide bond formation and redistribution during heating and lactosylation of proteins [144–147]. The identification of low-abundance proteins is particularly challenging; however, some works successfully identified them by removing the high-abundance proteins in colostrum and milk by immunoabsorption [148], by enrichment with a chromatographic support that combines size exclusion and anion exchange functionalities (restricted access media, RAM) [149], or by fractionation of whey by anion- and cation-exchange chromatography [150]. The milk fat globule membrane proteins are included in this category of minor proteins (2%–4% of the total protein in human milk), with the additional characteristic of high hydrophobicity that makes them difficult to solubilize. Using proteomic methodologies, several authors have been able to characterize a significant number of proteins present in the milk fat globule membrane [151–154]. The analysis of peptide mass fingerprints has also allowed the identification of biomarkers of bovine mastitis, such as lipocalin-type prostaglandin D synthase [155] or certain increased enzymatic activities [156]. Details about the strategy followed in each analysis and the mass spectrometer employed for peptide analysis are presented in Table 3.2.

### 3.3.4.2 *Biologically Active Peptides*

Biologically active peptides are of particular interest in food science and nutrition, because they have been shown to play different physiological roles, including antihypertensive, opioid, antimicrobial, and immunostimulating activities. As stated earlier in the first section of this chapter, these peptides are generated by protein hydrolysis or fermentation, and represent only minor constituents in a highly complex matrix. Therefore, identification of biologically active peptides in food matrices is a challenging task in food technology. In this context, mass spectrometry has become a necessary tool to assess the quality and safety of food [129], and more recently, to determine the presence and behavior of functional components (for a review, see [165,166]). Table 3.3 illustrates some of the applications of mass spectrometry in the analysis or identification of milk-derived bioactive peptides classified by the ionization source used in the analysis.

The FAB ionization is a pioneering desorption technique that has contributed to substantial progress in the mass determination of peptides and small proteins. This technique has successfully been used to identify biologically active peptides derived from milk and milk products, by combining the molecular mass value with the N-terminal sequence obtained by Edman degradation. By using this strategy, numerous phosphopeptides have been identified in Grana Padano cheese [170,171], Parmigiano-Reggiano cheese [172,173], Comté cheese [175], and cheese whey [174]. This combination of structural techniques has also been applied to identify the antihypertensive peptide  $\beta$ -Lactosin B from a commercial whey product [176], and antihypertensive peptides that naturally exist in Gouda cheese [169]. Other applications of the FAB–mass spectrometry, in combination with other techniques, includes the detection of immunostimulating, opioid, and antioxidant peptides [167,177].

Today, interfaces like electrospray and atmospheric pressure chemical ionization have displaced more antique soft ionization methods, like FAB. Thus, as shown in Table 3.3, electrospray has become the predominant ionization method for HPLC–mass spectrometry in bioactive peptide analysis. When it was first introduced, electrospray was mostly used in conjunction with a

**Table 3.2 Examples of Application of Mass Spectrometry in the Proteomic Analysis of Milk Proteins**

<i>Purpose<sup>a</sup></i>	<i>Strategy</i>	<i>Ion Source-Mass Analyzer<sup>b</sup></i>	<i>References</i>
<b>Characterization of Genetic Variants</b>			
Polymorphism of goat $\alpha_{s1}$ -casein	In-gel digestion	2-DE; MALDI-TOF; ESI-IT	[132]
Characterization of elephant milk proteins	In-capillary tryptic hydrolysis	NanoESI-QTOF	[157]
Identification of truncated goat $\beta$ -CN	Tryptic digestion	MALDI-TOF (reflectron), HPLC-ESI-IT	[133]
Identification of truncated forms of goat $\alpha_{s2}$ -CN A and E	Tryptic digestion	MALDI-TOF (reflectron), HPLC-ESI-IT	[134]
Detection of novel genetic variant of donkey $\beta$ -Lg		MALDI-TOF, HPLC-ESI-IT	[135]
<b>Characterization of Posttranslational Modifications</b>			
Degree of glycosylation and phosphorylation of ovine and caprine CMP	Offline RP-HPLC	ESI-QqQ	[158,159]
Detection of phosphoserines in caseinomacropепptide	Lost phosphoserine during fragmentation	MALDI-TOF (postsource decay spectra)	[136]
Characterization of ovine casein fractions	Offline HPLC, CE, PAGE	ESI-QTOF, MALDI-TOF, sector-TOF	[131]
Phosphorylation and glycosylation of ovine caseins	In-gel digestion immunoblotting	2-DE, immunoblotting, MALDI-TOF, ESI-QqQ	[137]
Phosphorylation, glycosylation, and genetic variants of $\kappa$ -casein	Enzymatic digestion	1-DE and 2-DE, ESI-IT	[138]
Characterization of $\kappa$ -CN isoforms	In-gel digestion	MALDI-TOF (reflectron)	[139]
Characterization of $\kappa$ -casein isoforms	Cystein tagging enrichment of $\kappa$ -CN	MALDI-TOF (reflectron), ESI-QTOF	[141]
	In-gel-digestion		

**Table 3.2 (continued) Examples of Application of Mass Spectrometry in the Proteomic Analysis of Milk Proteins**

<i>Purpose<sup>a</sup></i>	<i>Strategy</i>	<i>Ion Source-Mass Analyzer<sup>b</sup></i>	<i>References</i>
Phosphorylation and primary structure of equine $\beta$ -CN	Hydrolysis and precipitation CPPs	2-DE, HPLC-API-QqQ, ESI-QTOF	[160]
Identification of nitration sites	Labeling of nitration sites	1-DE, nanoHPLC-ESI-IT	[143]
Identification of phosphorylation sites of bovine caseins	CPP enrichment	HPLC-ESI-QTOF, SELDI-QTOF	[161]
Glycosylation sites in folate-binding protein	Hydrolysis and affinity enrichment of glycopeptides	HPLC-ESI-QTOF	[142]
<b>Low-Abundance Proteins</b>			
Characterization of milk fat globular membrane proteins	In-gel digestion	2-DE, MALDI-QTOF	[151]
Identification of minor proteins in colostrum and milk	Immunoabsorbents to remove major proteins + in-gel digestion	2-DE, MALDI-TOF, Q-TOF	[148]
Identification of biomarkers of mastitis	In-gel digestion	MALDI-TOF (postsource decay spectra)	[155]
Sequence of bovine folate-binding protein	Cis labeling	HPLC-ESI-IT	[162]
	Enzymatic digestion		
Identification of minor human milk proteins	Shotgun proteomics	2-D LC-nanoESI-IT	[149]
	Enrichment combined resin		
Fat globule membrane proteome	In-gel digestion	HPLC-QTOF	[152]
Changes in milk fat globule membrane from colostrum to milk	Shotgun proteomics	Cation-exchange, RP-HPLC-QTOF	[154]
Identification of peptides as biomarkers of mastitis	Chemical fractionation	MALDI-TOF (postsource decay spectra)	[156]
Identification of milk fat globule membrane proteins	In-gel digestion	2-DE, HPLC-QTOF	[153]
Characterization of minor whey proteins	In-gel digestion	2-DE, HPLC-QTOF	[154]

*(continued)*



**Table 3.2 (continued) Examples of Application of Mass Spectrometry in the Proteomic Analysis of Milk Proteins**

<i>Purpose<sup>a</sup></i>	<i>Strategy</i>	<i>Ion Source-Mass Analyzer<sup>b</sup></i>	<i>References</i>
<b>Modification of Proteins</b>			
Lactosylation of $\beta$ -Lg	Tryptic digest in solution	HPLC-ESI-QqQ	[144]
Lactosylation of $\beta$ -Lg, $\alpha$ -La, and $\alpha_{s2}$ -CN in infant formula	In-gel digestion	HPLC-QTOF	[145]
$\beta$ -CN tertiary structure by intramolecular cross-linking	Intramolecular cross-linking	MALDI-TOF	[163]
Disulfide bond formation in $\beta$ -Lg- $\kappa$ -CN during heating	Enzymatic hydrolysis	MALDI-TOF	[146]
Heat-induced redistribution of disulfide bonds	Tryptic hydrolysis	HPLC-API-QqQ	[140,164]
Identification of sulfhydryl groups exposed during heat treatment	Blocking SH groups	MALDI-QTOF	[147]
	Tryptic hydrolysis		

*Abbreviations:*  $\beta$ -Lg,  $\beta$ -lactoglobulin;  $\alpha$ -La,  $\alpha$ -lactalbumin; CN, casein; CMP, caseinmacropeptide; CPPs, caseinphosphopeptides; RP, reversed-phase; HPLC, high-performance liquid chromatography; CE, capillary electrophoresis; PAGE, polyacrylamide gel electrophoresis; 2-DE, two-dimensional electrophoresis; SCX, strong cation-exchange; MALDI, matrix-assisted laser desorption/ionization-time-of-flight; ESI, electrospray; API, atmospheric pressure ionization; TOF, time-of-flight; IT, ion trap, QqQ, triple-quadrupole; QTOF, quadrupole-time-of-flight.

<sup>a</sup> Unless indicated, it corresponds to milk proteins of bovine origin.

<sup>b</sup> The separation technique employed is also indicated: “-” indicates online coupling.

quadrupole mass analyzer. In this mode, numerous bioactive peptides have been characterized by combining mass determination with other analysis technique, as for instance, the amino acid composition or Edman degradation [191,192]. Nevertheless, currently, the vast majority of peptide sequencing experiments is carried out by tandem mass spectrometry. For instance, a triple-quadrupole mass analyzer has been used to sequence antibacterial peptides [205] and phosphopeptides [197]. This technique has been used to evaluate the digestibility of the caseinphosphopeptide  $\beta$ -CN f(1–25), recognized as a mineral carrier during its duodenal transit in rats [229].

The relative ease of combination of electrospray ionization with an ion-trap mass spectrometer has permitted many investigations related to milk proteins and peptides. This mass analyzer has allowed the characterization of phosphopeptides [211–215], peptides with antimicrobial [190,199–203], and antioxidant activities [207,230]. Electrospray–ion trap has also been used to follow the formation of antihypertensive peptides derived from various milk proteins by fermentation with different lactic acid bacteria [180–182,185]. Also, in a complex food matrix such as ripened cheeses, HPLC–tandem spectrometry performed in an ion trap and offline tandem spectrometry has allowed the identification of several ACE-inhibitory peptides [186–188]. Enzymatic hydrolysis of milk proteins has a great potential to produce ACE-inhibitory peptides, and their

**Table 3.3 Examples of Bioactive Peptides Derived from Milk Proteins Identified by Using Mass Spectrometry, Classified by the Type of Ion Source Employed in the Analysis**

<i>Origin</i> <sup>a</sup>	<i>Activity</i> <sup>b</sup>	<i>Mass Analyzer</i>	<i>References</i>
<b>FAB</b>			
Milk fermented by <i>Lactobacillus</i> GG and digested with pepsin and trypsin	Immunostimulating opioid	Double-focusing	[167]
Milk fermented by <i>Lactobacillus</i> sp. or <i>Lactococcus</i> sp.	ACE inhibitory	Four-sector	[168]
Gouda cheese	ACE inhibitory antihypertensive		[169]
Italian cheeses and cheese whey	Phosphopeptides	Double-focusing	[170–174]
Comté cheese	Phosphopeptides	Triple-quadrupole	[175]
Commercial whey milk product	ACE inhibitory antihypertensive		[176]
Peptic digest of casein	Antioxidant	Double-focusing	[177]
<b>Electrospray</b>			
Milk fermented with a mutant strain of <i>Lactobacillus helveticus</i> L89	Opioid	Triple-quadrupole	[178]
Milk proteins fermented and digested with pepsin and trypsin	ACE inhibitory		[179]
Sodium caseinate fermented by <i>Lactobacillus helveticus</i> NCC 2765	ACE inhibitory	Ion trap	[180]
Sodium caseinate fermented by <i>Lactobacillus animalis</i> DPC6134	ACE inhibitory	Ion trap	[181]
Milk fermented with <i>Enterococcus faecalis</i>	ACE inhibitory	Ion trap	[182,183]
	Antihypertensive		
Caprine whey fermented with microflora of different cheeses	ACE inhibitory	Ion trap	[184]
Commercial caprine kefir	ACE inhibitory	Ion trap	[185]
	Antimicrobial		
	Antioxidant		
Different Spanish cheeses	ACE inhibitory	Ion trap	[92,186–188]
Different Italian cheeses	Antimicrobial	Ion trap	[189,190]
Hydrolysis of $\beta$ -CN with chymosin	Immunomodulatory	Quadrupole	[191]

(continued)

**Table 3.3 (continued) Examples of Bioactive Peptides Derived from Milk Proteins Identified by Using Mass Spectrometry, Classified by the Type of Ion Source Employed in the Analysis**

<i>Origin<sup>a</sup></i>	<i>Activity<sup>b</sup></i>	<i>Mass Analyzer</i>	<i>References</i>
Tryptic hydrolysis of $\alpha_{s2}$ -CN	ACE inhibitory	Triple-quadrupole	[192,193]
Tryptic hydrolysis of BSA	ACE inhibitory	Triple-quadrupole	[194]
Tryptic hydrolysis of CMP	ACE inhibitory	Ion trap	[195]
Tryptic hydrolysis of ovine $\beta$ -Lg	ACE inhibitory	QTOF	[196]
Tryptic hydrolysis of $\alpha_5$ -CN	Phosphopeptides	Triple-quadrupole	[197,198]
Chymosin hydrolysis of sodium caseinate	Antibacterial	Ion trap	[199]
Peptic hydrolysis of casein	Antibacterial	Ion trap	[200]
Peptic hydrolysis of ovine $\alpha_{s2}$ -CN	Antibacterial	Ion trap	[201,202]
	Antioxidant		
	ACE inhibitory		
Peptic hydrolysis of $\kappa$ -CN	Antibacterial	Ion trap	[202,203]
	Antioxidant		
	ACE inhibitory		
Peptic hydrolysis of lactoferrin	Antimicrobial	Triple-quadrupole	[204]
Peptic hydrolysis of $\alpha_{s2}$ -CN	Antibacterial	Triple-quadrupole	[205]
Hydrolysis of $\alpha$ -La and $\beta$ -CN with thermolysin	ACE inhibitory	Ion trap	[107,206]
Hydrolysis of $\alpha$ -La and $\beta$ -Lg with Corolase PP®	Antioxidant	Ion trap	[207]
Commercial hydrolyzed caseinate	ACE inhibitory	QTOF	[208]
Ovine $\kappa$ -CN and whole casein hydrolyzed with digestive enzymes	ACE inhibitory	Ion trap	[209]
<i>In vitro</i> gastrointestinal digestion of human milk	ACE inhibitory	Ion trap	[210]
	Antioxidant		
<i>In vitro</i> gastrointestinal digestion of milk-based infant formulas, casein, and casein fractions	Phosphopeptides	Ion trap	[211–215]
<b>Matrix-Assisted Liquid Desorption Ionization</b>			
CMP	Antimicrobial	TOF	[216]

**Table 3.3 (continued) Examples of Bioactive Peptides Derived from Milk Proteins Identified by Using Mass Spectrometry, Classified by the Type of Ion Source Employed in the Analysis**

<i>Origin<sup>a</sup></i>	<i>Activity<sup>b</sup></i>	<i>Mass Analyzer</i>	<i>References</i>
Sodium caseinate fermented with <i>Lactobacillus acidophilus</i> DPC 6026	Antimicrobial	TOF	[217]
Sodium caseinate hydrolysed with a proteinase from <i>Lactobacillus helveticus</i> PR4	ACE inhibitory	TOF	[218]
Tryptic and pancreatic hydrolysis of casein	Phosphopeptides	TOF	[219]
Tryptic hydrolysis of sodium caseinate	Phosphopeptides	TOF	[220]
Tryptic hydrolysis of milk proteins	Phosphopeptides	TOF; QTOF	[221–226]
Peptic hydrolysis of human milk	Antimicrobial	TOF	[227]
Peptic hydrolysis of lactoferrin	Antimicrobial	TOF	[228]

Source: Adapted from Contreras, M.M. et al., *J. AOAC Int.*, 91, 981, 2008.

Note: The product of origin, the proposed bioactivity, and the mass analyzer are also specified.

Abbreviations: ACE, angiotensin-converting enzyme;  $\beta$ -Lg,  $\beta$ -lactoglobulin;  $\alpha$ -La,  $\alpha$ -lactalbumin; CN, casein; CMP, caseinmacropeptide; BSA, bovine serum albumin; TOF, time-of-flight; QTOF, quadrupole-time-of-flight.

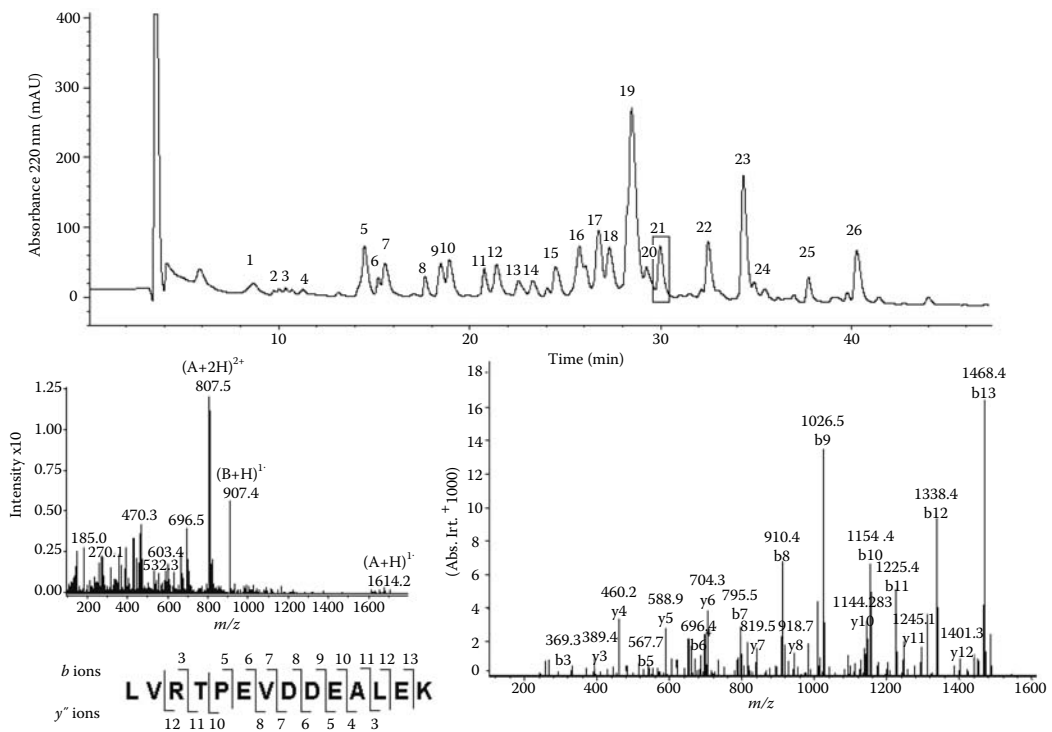
<sup>a</sup> Unless indicated, it corresponds to milk proteins of bovine origin.

<sup>b</sup> The term activity makes reference to the bioactivity of the food product and/or their derived peptides.

formation has been monitored by using an ion-trap mass spectrometer. Thus, tryptic hydrolysis of  $\kappa$ -casein macropeptide (CMP) [195] and thermolysin hydrolysis of caprine  $\beta$ -Lg [231], bovine  $\beta$ -lactoglobulin A [232], and  $\alpha$ -La and  $\beta$ -CN A2 [107,206] are good examples of the applications of this technique to search for bioactive sequences in food-protein hydrolysates. For example, Figure 3.2A shows the UV-chromatogram corresponding to a  $\beta$ -Lg hydrolysate obtained with thermolysin, Figure 3.2B shows the mass spectrum of one selected peak (peak 21 in Figure 3.2A), and the tandem mass spectrum of the doubly charged ion with  $m/z$  of 807.5 together with the amino acid sequence of the identified peptide are shown in Figure 3.2C.

Although HPLC–mass spectrometry is a powerful technique for peptide sequencing, certain RP separations entail some difficulties, as for instance, the identification of small hydrophilic peptides eluted in the first part of the chromatogram, which is usually discarded to avoid the entry of salts into the mass spectrometer. Using CE–ion trap, Gómez-Ruiz et al. [209] identified four novel potent ACE-inhibitory peptides from  $\kappa$ -CN hydrolyzed with digestive enzymes.

In recent reports, the characterization of bioactive peptides has been performed by tandem-in-space mass spectrometers. A quadrupole-TOF mass spectrometer has been used to identify a total of 21 peptides derived from tryptic hydrolysates of ovine  $\beta$ -Lg [196]. Van Platerink et al. [208] developed an at-line method for the identification of ACE-inhibitory peptides. The



**Figure 3.2** (A) UV-chromatogram corresponding to the  $\beta$ -Lg hydrolysate with thermolysin for 5 min at 37°C. (B) Mass spectrum of the selected chromatographic peak in Figure 3.1A. (C) Tandem mass spectrum of the doubly charged ion of  $m/z$  807.5. Following sequence interpretation and database searching, the MS/MS spectrum was matched to  $\beta$ -Lg f(122–135). The sequence of this peptide is displayed with the fragment ions observed in the spectrum. For clarity, only the  $b$  and the  $y''$  fragment ions are labeled. (From Hernández-Ledesma, B. et al., *J. Chromatogr. A*, 1116, 31, 2006. With permission.)

method consisted of activity measurements of fractions collected from a two-dimensional HPLC fractionation of the peptide mixture, followed by mass spectrometry identification of the peptides in the inhibiting fractions.

Because of their longer sequences, several milk-derived antimicrobial peptides have been identified with MALDI-TOF instruments [216,217,227]. MALDI-TOF was used to follow purification of lactoferricin, a potent antimicrobial milk-derived peptide, on an industrial grade cation-exchange resin [228]. MALDI, as ionization source, has also been employed for the identification and characterization of milk-derived antihypertensive peptides from casein hydrolyzed with a proteinase from a food-grade microorganism (*Lactobacillus helveticus* PR4) [218]. Furthermore, MALDI techniques have also contributed to study the bioavailability of antihypertensive peptides. Using MALDI-TOF mass spectrometry, the presence of the antihypertensive peptide derived from a tryptic digestion of  $\beta$ -lactoglobulin in both the mucosal and serosal sides of a Caco-2 cell monolayer has been demonstrated [233]. It has been observed that the heptapeptide are transported intact through the monolayer, but in concentrations too low to exert an ACE-inhibitory activity.

Phosphorylated peptides are usually in low concentrations in the hydrolysis products in such a way that the presence of nonphosphorylated peptides can suppress the ion signal of

the phosphorylated species in the mass spectrum [221]. Furthermore, the electronegativity of phosphate groups usually reduces the ionization efficiency during the positive mode of mass spectrometry analysis [222]. Therefore, enrichment or purification methods are usually necessary. Zhou et al. [223] showed the successful identification of  $\alpha$ - and  $\beta$ -casein-derived phosphopeptides, by applying immobilized metal ion affinity chromatography (IMAC) and direct analysis with MALDI-TOF mass spectrometry. Recently, other techniques have been successfully applied to selectively concentrate phosphopeptides prior to MALDI-TOF mass spectrometric analysis, such as titanium dioxide microcolumns [224], alumina- and zirconia-coated magnetic particles [221,225], and porous anodic alumina membrane [222]. A recent promising technique for the analysis of food-derived phosphopeptides involves the direct detection and sequencing of IMAC-enriched peptides through MALDI-tandem mass spectrometry on an orthogonal injection quadrupole-TOF mass spectrometer [234]. Bennet et al. [226] employed this technique with or without the IMAC purification step for phosphopeptides identification from  $\beta$ -casein.

### 3.3.4.3 Evaluation of Proteolysis

Proteolysis of milk proteins has been evaluated by using different mass spectrometry techniques. One of the main applications is the characterization of different cheese varieties, where proteolysis is regarded as one of the most important biochemical reaction. As stated in the first part of this chapter, chromatographic and electrophoretic techniques provide valuable information about peptides produced in cheese ripening, but the use of mass spectrometry has allowed increased sensitivity, specificity, and peptide sequencing in a shorter analysis time. MALDI-TOF mass spectrometry approaches have been applied to identify peptides in Cheddar cheese, prior to separation by HPLC [235,236]. This technique has also been used to quantify the bitter peptide  $\beta$ -CN f(193–207), to correlate its presence with cheese bitterness and to differentiate peptidase activities of starter and adjunct cultures on  $\beta$ -CN f(193–207) under cheese-like conditions [237–239]. Owing to the small size of these peptides, ion trap has been successfully applied to study the mechanism of casein breakdown in a starter-free model cheese made from microfiltered milk, and to identify ACE-inhibitory peptides and phosphopeptides in cheese [186,187,240]. The formation of peptides during ripening has also been studied by using a triple-quadrupole mass spectrometer as mass analyzer [241,242]. Several examples about the application of mass spectrometry to the analysis of peptides in cheese are summarized in Table 3.4.

Mass spectrometry in its different modes has extensively been used to characterize milk-protein hydrolysates. Table 3.4 includes some of the recent applications of this technique and the purpose that led to the characterization of the milk-protein hydrolysate. These applications are focused mainly to study the digestibility of milk proteins (in their native form or subjected to different treatments) and to determine the specificity of enzymes, either bacterial or digestive enzymes, used in the food industry. In all the cases, the introduction of mass spectrometry, mostly coupled with HPLC, has allowed the identification of peptide sequences, even those that are not chromatographically resolved.

### 3.3.4.4 Quantitative Analysis of Peptides by Mass Spectrometry

Although a remarkable progress in protein analysis as a consequence of proteomic research has been achieved, the field of absolute quantification of peptides by mass spectrometry has not grown rapidly. However, the well-established selectivity and sensitivity advantages offered by mass spectrometry for protein and peptide analysis suggest that peptide quantification can be achieved

**Table 3.4 Examples of the Application of Mass Spectrometry in the Analysis of Peptides in Cheese and Milk-Protein Hydrolysates**

<i>Purpose</i>	<i>Ion Source-Mass Analyzer</i>	<i>References</i>
<b>Cheese</b>		
Identification of peptides in Cheddar cheese	MALDI-TOF	[235,236]
Quantification of bitter peptide $\beta$ -CN f(193–209) in Queso Fresco	MALDI-TOF	[237]
Correlation of $\beta$ -CN f(193–209) and bitterness in Cheddar cheese	MALDI-TOF	[238]
Differentiation of peptidase activities in $\beta$ -CN f(193–209)	MALDI-TOF	[239]
Identification of small peptides in different cheese types	MALDI-TOF	[243]
Clotting mechanism of proteinase from glutinous rice wine	ESI-Q-TOF, MALDI-TOF	[244]
Taste characteristics of peptides in Manchego cheese	HPLC-ESI-IT	[245]
Identification of ACE-inhibitory peptides in Spanish cheeses	HPLC-ESI-IT	[187,188]
Identification of phosphopeptides in cheese	IMAC + RP-HPLC-ESI-IT	[240]
Identification of small peptides in goat cheese	ESI-QqQ	[242]
Formation of peptides during Cheddar cheese-making	ESI-QqQ	[241]
Primary proteolysis in cheese made with microfiltered milk	HPLC-IT	[36]
<b>Milk-Protein Hydrolysates</b>		
Detection of milk allergens	HPLC-QTOF	[246]
Antigenicity and immunoglobulin binding of $\beta$ -Lg hydrolysates	HPLC-ESI-IT	[103]
Digestibility of $\beta$ -Lg treated with high-pressure	MALDI-TOF; HPLC-IT	[247]
Effect of lactosylation on protein susceptibility of different proteases	MALDI-TOF/TOF	[248]
Digestibility of $\beta$ -Lg/ $\beta$ -Lg f(142–148) complexes	MALDI-TOF	[96]
Susceptibility of $\beta$ -Lg to chymotrypsin during and after high-pressure treatments	HPLC-ESI-IT	[100]

**Table 3.4 (continued) Examples of the Application of Mass Spectrometry in the Analysis of Peptides in Cheese and Milk-Protein Hydrolysates**

<i>Purpose</i>	<i>Ion Source-Mass Analyzer</i>	<i>References</i>
Identification of photolytic cleavage of disulfide bonds in goat $\alpha$ -La	MALDI-TOF/TOF; ESI-QTOF	[249]
Digestibility of whey proteins subjected to high pressure	MALDI-TOF	[250]
Conformational changes of $\alpha$ -La induced by ethanol studied by limited proteolysis	HPLC-ESI-IT; HPLC-QTOF	[251]
Identification of $\beta$ -casein peptides under gastroanalogous conditions	MALDI-TOF (postsources decay)	[252]
Changes of susceptibility of genetic variants of $\beta$ -Lg to trypsin	HPLC-QqQ	[140]
Degradation of $\alpha_{s1}$ -CN f(1–23) by bacterial amino- and endopeptidases	MALDI-TOF	[253]
Specificity of peptidases from <i>Lactobacillus helveticus</i>	MALDI-TOF (reflectron)	[254]
Identification of aggregating peptides in a whey protein hydrolysate	HPLC-IT	[255,256]
Specificity of cathepsin B on caseins	PD-TOF	[257]
Identification of aggregating peptides in $\alpha$ -La hydrolysates	HPLC-Q; MALDI-TOF	[258]
Release of albutensins from bovine and human serum albumin	HPLC-ESI-QqQ	[194]
Binding of pentanal- and lysine-containing peptides	MALDI-TOF/TOF	[259]
Identification of peptides in milk with different somatic cell counts	MALDI-TOF/TOF	[260]
Peptide profiling in milk produced by cows with subclinical mastitis	MALDI-TOF/TOF	[261]
Pattern of casein breakdown by native enzymes in human milk	HPLC-ESI-Q; ESI-QTOF	[262]

*Abbreviations:*  $\beta$ -Lg,  $\beta$ -lactoglobulin;  $\alpha$ -La,  $\alpha$ -lactalbumin; CN, casein; CMP, casein macropeptide; BSA, bovine serum albumin; IMAC, immobilized metal affinity chromatography; HILIC, hydrophilic interaction liquid chromatography; PD, plasma desorption; MALDI, matrix-assisted laser desorption/ionization-time-of-flight; ESI, electrospray; API, atmospheric pressure ionization; TOF, time-of-flight; IT, ion trap; QqQ, triple-quadrupole; QTOF, quadrupole-time-of-flight.



by techniques, such as HPLC–mass spectrometry or HPLC–tandem mass spectrometry [263]. Furthermore, immunological techniques, such as competitive ELISA and radioimmunoassay, are still widely employed for peptide quantification. Methods based on mass spectrometry demand extensive validation to meet the defined criteria, such as accuracy, precision, recovery, selectivity, stability, and robustness. Special attention should be directed to matrix effects, because they can suppress ionization, thus misleading the calculations [264]. On the other hand, the addition of an internal standard can improve accuracy and aid in determining the deviations in the analytical process [265].

The antihypertensive activity of ACE-inhibitory peptides has been shown to be highly dependent on the peptide dosage [266], and therefore, quantification of these peptides in functional foods is essential to ensure the activity of the final product. Several methods based on HPLC coupled with mass spectrometry have recently been reported to quantify antihypertensive peptides in protein hydrolysates or fermented products. Curtis et al. [267] developed a straightforward, quantitative method for measuring an antihypertensive peptide in bonito muscle hydrolysate, using one step of solid-phase extraction followed by quantification using HPLC–tandem mass spectrometry with a quadrupole-TOF mass spectrometer. Van Platerink et al. [268] developed a method on a triple-quadrupole instrument for the quantification of 17 ACE-inhibitory peptides, including IPP, VPP, and HLPLP, in plasma samples from human volunteers who previously consumed peptide-enriched drinks. The limit of the detection was below 0.01 ng/mL, and the limit of the quantification was between 0.05 and 0.2 ng/mL. The antihypertensive peptide LHLPLP was quantified in the fermented milk products by HPLC–tandem mass spectrometry with an ion-trap instrument [269]. The determination was based on the peak area of the most-abundant product ions from the fragmentation of the molecular ion of LHLPLP, and did not require internal standard. The use of mass spectrometry or tandem mass spectrometry produced very clean chromatograms for this peptide, with a negligible contribution from the fermented milk background. Lately, this method was applied to study the transepithelial transport of the peptide LHLPLP using Caco-2 cells [270]. Recently, Geerlings et al. [271] quantified the caprine ACE-inhibitory sequences TGIPN, SLPQ, and SQPK from a goat milk hydrolysate. Peptides were quantified by mass spectrometry using calibration curves prepared with synthetic peptides, but they did not report any validation criteria for this method.

The quantitative determination of two antihypertensive peptides, IPP and VPP, has been achieved by using different mass spectrometric approaches. Matsuura et al. [272] described an HPLC–mass spectrometry approach to quantify these peptides in a casein hydrolysate, using the peptide APP as an internal standard. The method required a previous solid-phase extraction stage as a cleanup procedure, and showed reproducibility between 3.9% and 4.1%, linearity in the range from 0 to 48 µg/mL, and good accuracy. Recently, Bütikofer et al. [273] employed HPLC with subsequent triple mass spectrometry (MS<sup>3</sup>) procedure for the quantitative determination of VPP and IPP in the water-soluble extracts of several traditional cheeses. Quantification of VPP and IPP was carried out in a linear ion-trap mass spectrometer with the sum of the most intense ions in the MS<sup>3</sup> experiments. The use of PPPP as an internal standard for quantification substantially improved the repeatability of the method. The limit of determination was 0.22 mg/kg for VPP and 0.03 mg/kg for IPP. The repeatability and recovery obtained showed that this method is suitable for the detection of IPP and VPP in cheese.

The CMP is a polypeptide of 64 amino acid residues, derived from the C-terminal part of bovine κ-casein. It is a complex mixture of nonglycosylated and diversely glycosylated forms. Mollé and Leonil [274], using HPLC–mass spectrometry, reported several reliable conditions to enable unequivocal determination of aglyco-CMP variant A, aglyco-CMP variant B, and total

CMP. A high degree of selectivity was obtained using multiple reactions monitoring the detection, and the limit of quantification was 10 pmol within the standard curve range of 10–1000 pmol.

Few attempts have been made to quantify the milk peptides in the biological fluids, using mass spectrometry. Kuwata et al. [275] evaluated the *in vivo* generation of lactoferricin after ingestion of bovine lactoferrin by surface-enhanced laser desorption/ionization (SELDI). SELDI was used in the affinity mass spectrometry operational mode to detect and quantify lactoferricin directly from unfractionated gastric contents. The recovery of the method was almost 100% and the amount of lactoferricin found in the gastric contents was  $16.9 \pm 2.7 \mu\text{g/mL}$ .

### 3.4 Future Prospects

This chapter summarized the main recent contributions and potentialities of different analytical techniques to identify and characterize milk peptides in milk and different dairy products. In the near future, traditional techniques for analyzing milk peptides, such as HPLC and CE, will continue to grow through the miniaturization of the components (microbore and narrow-bore columns), and techniques for peptide separations on microchips will progress, especially for proteomic applications. The coupling of microfluidic chips with mass spectrometry is probably one of the future developments that will be applied in the analysis of milk peptides. Although it is likely that 2D-PAGE techniques will still be used in the proteomic analysis of milk proteins and peptides, an increase in the application of liquid 2D-separations prior to detection by conventional techniques or mass spectrometry is expected, which will improve the identification of minor peptides in complex mixtures. By looking at the performance of recent mass spectrometers with increasing sensitivity, mass accuracy, and resolving power, one can envision that within the next few years important breakthroughs will result from the study of milk peptides that will expand the current knowledge on, for instance, allergens and bioactive peptides. Theoretical predictions and simulations are already considered as an emerging tool in peptide science. In this respect, the growing trend of computer-aided methods, such as databases for protein identification, interpretation of spectra, or simulation of protein hydrolysis is expected to continue in the future.

### Acknowledgments

This work was financially supported by projects Consolider-Ingenio 2010, CSD2007-0063, AGL2007-65035, AGL2008-1740 from the Spanish Ministry of Education and Science (MEC), and S-505/AGR/0153-01 from the Autonomous Community of Madrid.

### References

1. MJ Sousa, Y Ardö, PLH McSweeney. Advances in the study of proteolysis during cheese ripening. *Int Dairy J* 11: 327–345, 2001.
2. A Kilara, D Panyam. Peptides from milk proteins and their properties. *Crit Rev Food Sci Nutr* 43: 607–623, 2003.
3. R Hartmann, H Meisel. Food-derived peptides with biological activity: From research to food applications. *Curr Opin Biotechnol* 18: 163–169, 2007.
4. P Minkiewicz, J Dziuba, M Darewicz, A Iwaniak, M Dziuba, D Nałecz. Food peptidomics. *Food Technol Biotechnol* 46: 1–10, 2008.

5. D González de Llano, T Herraiz, MC Polo. Peptides. In: L M L Nollet, ed. *Handbook of Food Analysis. Physical Characterization and Nutrient Analysis*. Marcel Dekker, Inc., New York, pp. 125–166.
6. G Taborda, E Molina, I Martínez-Castro, M Ramos, L Amigo. Composition of the water-soluble fraction of different cheeses. *J Agric Food Chem* 51: 270–276, 2003.
7. A Vernile, TP Beresford, G Spano, S Massa, PF Fox. Chemical studies of Pecorino Sicilianof cheese throughout ripening. *Milchwissenschaft* 62: 280–284, 2007.
8. AA Hayaloglu, C Cakmakci, EY Brechany, KC Deegan, PLH McSweeney. Microbiology, biochemistry, and volatile composition of Tolum cheese ripened in goats's skin or plastic bags. *J Dairy Sci* 90: 1102–1121, 2007.
9. J Sorensen, C Benfeldt. Comparison of ripening characteristics of Danbo cheeses from two dairies. *Int Dairy J* 11: 355–362, 2001.
10. V Fallico, PLH McSweeney, KJ Siebert, J Horne, S Carpino, G Licitra. Chemometric analysis of proteolysis during ripening of Ragusano cheese. *J Dairy Sci* 87: 3138–3152, 2004.
11. L Costabel, MS Pualetti, E Hynes. Proteolysis in Mozzarella cheeses manufactured by different industrial processes. *J Dairy Sci* 90: 2103–2112, 2007.
12. MC Katsiari, E Alichanidis, LP Voutsinas, IG Roussis. Proteolysis in reduced sodium Kefalograviera cheese made by partial replacement of NaCl with KCl. *Food Chem* 73: 31–43, 2001.
13. GA Sihufe, SE Zorrilla, AC Rubiolo. Secondary proteolysis of Fynbo cheese salted with NaCl/KCl brine and ripened at various temperatures. *Food Chem* 96: 297–303, 2006.
14. JM Somers, AL Kelly. Contribution of plasmin to primary proteolysis during ripening of cheese: Effect of milk heat treatment and cheese cooking temperature. *Lait* 82: 181–191, 2002.
15. C Benfeldt, Sorensen J. Heat treatment of cheese milk: Effect on proteolysis during cheese ripening. *Int Dairy J* 11: 567–574, 2001.
16. J Hesari, MR Ehsani, MAE Mosavi, PLH McSweeney. Proteolysis in ultra-filtered and conventional Iranian white cheese during ripening. *Int J Dairy Technol* 60: 211–220, 2007.
17. C Benfeldt. Ultrafiltration of cheese milk: Effect on plasmin activity and proteolysis during cheese ripening. *Int Dairy J* 16: 600–608, 2006.
18. MG Hayes, JC Oliveira, PLH McSweeney, AL Kelly. Thermal inactivation of chymosin during cheese manufacture. *J Dairy Res* 69: 269–279, 2002.
19. MA Bustamante, M Virto, M Aramburu, LJR Barrón, FL Pérez-Elortondo, M Albisu, M de Renobales. Lamb rennet paste in ovine cheese (Idiazabal) manufacture. Proteolysis and relationship between analytical and sensory parameters. *Int Dairy J* 13: 547–557.
20. S Agboola, S Chen, J Zhao. Formation of bitter peptides during ripening of ovine milk cheese made with different coagulants. *Lait* 84: 567–578, 2004.
21. R Rossano, P Piraino, A D'Ambrosio, OF O'Connell, N Ungaro, PLH McSweeney, P Riccio. Proteolysis in miniature Cheddar-type cheeses manufactured using extracts from the crustacean *Munida* as coagulant. *J Biotechnol* 120: 220–227, 2005.
22. L Tejada, A Abellán, JM Cayuela, A Martínez-Cacha, J Fernández-Salguero. Proteolysis in goats' milk cheese made with calf rennet and plant coagulant. *Int Dairy J* 18: 139–146, 2008.
23. JM Poveda, MJ Sousa, L Cabezas, PLH McSweeney. Preliminary observations on proteolysis in Manchego cheese made with a defined-strain starter culture and adjunct starter (*Lactobacillus plantarum*) or a commercial starter. *Int Dairy J* 13: 169–178, 2003.
24. M Antonsson, G Molin, Y Ardö. Proteolysis of the semi-hard cheese Herrgård made at different dairies. Exploratory study. *Milchwissenschaft* 58: 145–148, 2003.
25. A Michaelidou, MC Katsiari, LP Voutsinas, A Polychroniadou, E Alichanidis. Effect of multiple-species starters on peptide profile and free amino acids in low-fat Kefalograviera-type cheese. *Food Chem* 104: 800–807, 2007.
26. VK Upadhayay, T Huppertz, AL Kelly, PLH McSweeney. Use of high pressure treatment to attenuate starter bacteria for use as adjuncts for Cheddar cheese manufacture. *Innov Food Sci Emerg Technol* 8: 485–492, 2007.

27. EP Feeney, TP Guinee, PF Fox. Effect of pH and calcium concentration on proteolysis in Mozzarella cheese. *J Dairy Sci* 85: 1646–1654, 2002.
28. AA Hayaloglu, M Guven, PF Fox, PLH McSweeney. Influence of starters on chemical, biochemical and sensory changes in Turkish White-brined cheese during ripening. *J Dairy Sci* 88: 3460–3474, 2005.
29. BS Oommen, DJ McMahon, CJ Oberg, JR Broadbent, M Strickland. Proteolytic specificity of *Lactobacillus delbureckii* subsp bulgaricus influences functional properties of Mozzarella cheese. *J Dairy Sci* 85: 2750–2758, 2002.
30. P Morales, P Gaya, M Núñez. Casein degradation and peptide formation in cheeses made with *Micrococcus* sp INIA 528 milk cultures and high enzymatic activity. *Milchwissenschaft* 61: 40–44, 2006.
31. S Garde, J Tomillo, P Gaya, M Medina, M Núñez. Proteolysis in Hispánico cheese manufactured using a mesophilic starter, a thermophilic starter and bacteriocin-producing *Lactococcus lactis* subsp. Lactis INIA 415 adjunct culture. *J Agric Food Sci* 50: 3479–3485, 2002.
32. S Garde, P Gaya, E Fernández-García, M Medina, M Núñez. Proteolysis, volatile compounds, and sensory evaluation in Hispánico cheese manufactured with the addition of a thermophilic adjunct culture, nisin and calcium alginate-nisin microparticles. *J Dairy Sci* 86: 3038–3047, 2003.
33. M Ávila, S Garde, P Gaya, M Medina, M Núñez. Effect of high-pressure treatment and a bacteriocin-producing lactic culture on the proteolysis, texture and taste of Hispánico cheese. *J Dairy Sci* 89: 2882–2893, 2006.
34. VK Upadhayay, MJ Sousa, P Ravn, H Israelsen. AL Kelly, PLH McSweeney. Use of exogenous streptokinase to accelerate proteolysis in Cheddar cheese during ripening. *Lait* 84: 527–538, 2004.
35. J Saldo, PLH McSweeney, E Sendra, A L Kelly, B Guamis. Proteolysis in caprine milk cheese treated by high pressure to accelerate cheese ripening. *Int Dairy J* 12: 35–44, 2002.
36. M Larsson, M Zakora, P Dejmek, Y Ardö. Primary proteolysis studied in a cast cheese made from microfiltered milk. *Int Dairy J* 16: 623–632, 2006.
37. Y Ardö, H Libaek, KR Kristiansen, M Zakora, J Otte. Identification of large phosphopeptides from beta-casein that characteristically accumulate during ripening of the semi-hard cheese Herrgård. *Int Dairy J* 17: 513–524, 2007.
38. SM Albillos, MD Busto, M Pérez-Mateos, N Ortega. Analysis by capillary electrophoresis of the proteolytic activity of a *Bacillus subtilis* neutral protease on bovine caseins. *Int Dairy J* 17: 1195–1200, 2007.
39. SM Albillos, MD Busto, M Pérez-Mateos, N Ortega. Chemometrical analysis of capillary electrophoresis casein fractions for predicting ripening times of milk mixture cheese. *J Agric Food Chem* 53: 6094–6099, 2005.
40. SM Albillos, MD Busto, M Pérez-Mateos, N Ortega. Prediction of the ripening times of ewe's milk cheese by multivariate regression analysis of capillary electrophoresis casein fractions. *J Agric Food Chem* 54: 8281–8287, 2006.
41. RM Barros, FX Malcata. Molecular characterization of peptides released from  $\beta$ -lactoglobulin and  $\alpha$ -lactalbumin via cardosins A and B. *J Dairy Sci* 89: 483–494, 2006.
42. H Lindmark-Mansson, A Timgren, G Alden, M Paulsson. Two-dimensional gel electrophoresis of proteins and peptides in bovine milk. *Int Dairy J* 15: 111–121, 2005.
43. E Molina, M Ramos, L Amigo. Characterisation of the casein fraction of Iberico cheese by electrophoretic techniques. *J Sci Food Agric* 82: 1240–1245, 2002.
44. M Strickland, ME Johnson, JR Broadbent. Qualitative and quantitative analysis of proteins and peptides in milk products by capillary electrophoresis. *Electrophoresis* 22: 1510–1517, 2001.
45. I Recio, M Ramos, R López-Fandiño. Capillary electrophoresis for the analysis of food proteins of animal origin. *Electrophoresis* 22: 1489–1502, 2001.
46. C Combes, E Paterson, R Amado. Isolation and identification of low-molecular weight peptides from Emmentaler cheese. *J Food Sci* 67: 553–559, 2002.
47. PE Groleau, R Jiménez-Flóres, SF Gauthier, Y Pouliot. Fractionation of  $\beta$ -lactoglobulin tryptic peptides by ampholyte-free isoelectric focusing. *J Agric Food Chem* 50: 578–583, 2002.

48. R Koka, BC Weimer. Investigation of the ability of a purified protease from *Pseudomonas fluorescens* RO98 to hydrolyse bitter peptides from cheese. *Int Dairy J* 10: 75–79, 2000.
49. LB Roseiro, JA Gómez-Ruíz, M García-Risco, E Molina. Vegetable coagulant (*Cynara cardunculus*) use evidenced by capillary electrophoresis permits PDO Serpa cheese authentication. *Lait* 83: 343–350, 2003.
50. B Miralles, L Amigo, M Ramos, I Recio. Analysing para-kappa-casein and related peptides as indicators of milk proteolysis. *Milchwissenschaft* 58: 412–415, 2003.
51. MR García-Risco, M Villamiel, R López-Fandiño. Effect of homogenisation on protein distribution and proteolysis during storage of indirectly heated UHT milk. *Lait* 82: 589–599, 2002.
52. MR García-Risco, I Recio, E Molina, R López-Fandiño. Plasmin activity in pressurized milk. *J Dairy Sci* 86: 728–734, 2003.
53. S Sentellas, J Saurina. Chemometrics in capillary electrophoresis. Part B: Methods of analysis. *J Sep Sci* 26: 1395–1402, 2003.
54. RR Roesch, M Corredig. Production of buttermilk hydrolysates and their characterization. *Milchwissenschaft* 57: 376–380, 2002.
55. L Zhao, Z Wang, SY Xu. Preparation of casein phosphorylated peptides and casein non-phosphorylated peptides using alcalase. *Eur Food Res Technol* 225: 579–584, 2007.
56. C van der Ven, H Gruppen, DBA de Bont, AGL Voragen. Correlations between biochemical characteristics and foam-forming and -stabilizing ability of whey and casein hydrolysates. *J Agric Food Chem* 50: 2938–2946, 2002.
57. J Flanagan, RJ FitzGerald. Physicochemical and nitrogen solubility properties of *Bacillus proteinase* hydrolysates of sodium caseinate incubated with transglutaminase pre- and post-hydrolysis. *J Agric Food Chem* 50: 5429–5436, 2002.
58. C van der Ven, H Gruppen, DBA de Bont, AGL Voragen. Reversed phase and size exclusion chromatography of milk protein hydrolysates: Relation between elution from reversed phase column and apparent molecular weight distribution. *Int Dairy J* 11: 83–92, 2001.
59. CJ Coker, RA Crawford, KA Johnson, H, Singh, LK Creamer. Towards the classification of cheese variety and maturity on the basis of statistical analysis of proteolysis data—A review. *Int Dairy J* 15: 631–643, 2005.
60. P Piraino, E Parente, PL McSweeney. Processing of chromatographic data for chemometric analysis of peptide profiles from cheese extracts: A novel approach. *J Agric Food Chem* 52: 6904–6911, 2004.
61. C Durrieu, P Degraeve, S Chappaz, A Martial-Gros. Immunomodulating effects of water soluble extracts of traditional French Alps cheeses on a human T-lymphocyte cell line. *Int Dairy J* 16: 1505–1514, 2006.
62. M Albenzio, MR Corbo, SU Rehman, PF Fox, M De Angelis, A Corsetti, A Sevi, M Gobbetti. Microbiological and biochemical characteristics of Canestrato Pugliese cheese made from raw milk, pasteurised milk or by heating the curd in hot whey. *Int J Food Microbiol* 67: 35–48, 2001.
63. L Pillonel, B Albrecht, R Badertscher, U Butikofer, JF Chamba, R Tabacchi, JO Bosset. Analytical methods for the determination of the geographic origin of Emmental cheese. Parameters of proteolysis and rheology. *Italian J Food Sci* 15: 49–62, 2003.
64. E Hynes, JC Ogier, A Delacroix-Buchet A. Proteolysis during ripening of miniature washed-curd cheeses manufactured with different strains of starter bacteria and a *Lactobacillus plantarum* adjunct culture. *Int Dairy J* 11: 587–597, 2001.
65. M Pescuma, EM Hebert, F Mozzi, G Font de Valdez. Hydrolysis of whey proteins by *Lactobacillus acidophilus*, *Streptococcus thermophilus* and *Lactobacillus delbrueckii* ssp bulgaricus grown in a chemically defined medium. *J Appl Bacteriol* 103: 1738–1746, 2007.
66. CJ Oberg, JR Broadbent, M Strickland, DJ McMahon. Diversity in specificity of the extracellular proteinases in *Lactobacillus helveticus* and *Lactobacillus delbrueckii* subsp. Bulgaricus. *Lett Appl Microbiol* 34: 455–460, 2002.

67. JR Broadbent, M Barnes, C Brennand, M Strickland, K Houck, ME Johnson, JL Steele. Contribution of *Lactococcus lactis* cell envelope proteinase specificity to peptide accumulation and bitterness in reduced-fat Cheddar cheese. *Appl Environ Microbiol* 68: 1778–1785, 2002.
68. CJ Pillidge, VL Crow, T Coolbear, JR Reid. Exchanging lactocepin plasmids in lactococcal starters to study bitterness development in Gouda cheese: A preliminary investigation. *Int Dairy J* 13: 345–354, 2003.
69. R Boutoru, M Aziza, A Amrane. Enhanced proteolytic activities of *Geotrichum candidum* and *Penicillium camemberti* in mixed culture. *Enzyme Microb Technol* 39: 325–331, 2006.
70. P Sarantinopoulos, G Kalantzopoulos, E Tsakalidou. Effect of *Enterococcus faecium* on microbiological, physicochemical and sensory characteristics of Greek Feta cheese. *Int J Food Microbiol* 76: 93–105, 2002.
71. AS Egito, JM Girardet, LE Laguna, C Poirson, D Molle, L Miclo, G Humbert, JL Gaillard. Milk-clotting activity of enzyme extracts from sunflower and albizia seeds and specific hydrolysis of bovine kappa-casein. *Int Dairy J* 17: 816–825, 2007.
72. MC Katsiari, E Alichanidis, LP Voutsinas, IG Roussis. Proteolysis in reduced sodium Kefalograviera cheese made by partial replacement of NaCl with KCl. *Food Chem* 73: 31–43, 2001.
73. H Mallatou, EC Pappa, VA Boumba. Proteolysis in Teleme cheese made from ewe's, goat's or a mixture of ewes' and goats' milk. *Int Dairy J*, 14: 977–987, 2004.
74. HK Mayer. Bitterness in processed cheese caused by an overdose of a specific emulsifying agent? *Int Dairy J* 11: 533–542, 2001.
75. V Fallico, PLH McSweeney, J Horne, C Pediliggieri, JA Hannon, S Carpino, G Licitra. Evaluation of bitterness in Ragusano cheese. *J Dairy Sci* 88: 1288–1300, 2005.
76. P. Morales, P Gaya, M Medina, M Nuñez. Hydrophilic and hydrophobic peptides produced in cheese by wild *Lactococcus lactis* strains. *Lett Appl Microbiol* 35: 518–522, 2002.
77. A Picón, B de Torres, P Gaya, M Nuñez. Cheesemaking with a *Lactococcus lactis* strain expressing a mutant oligopeptide binding protein as starter results in a different peptide profile. *Int J Food Microbiol* 104: 299–307, 2005.
78. AH Pripp, S Skeie, T Isaksson, GI Borge, T Sorhaug. Multivariate modelling of relationships between proteolysis and sensory quality of Prast cheese. *Int Dairy J* 16: 225–235, 2006.
79. V Fallico, L Tuminello, C Pediliggieri, J Horne, S Carpino, G Licitra. Proteolysis and microstructure of Piacentinu Ennese cheese made using different farm technologies. *J Dairy Sci* 89: 37–48, 2006.
80. ER Hynes, L Aparo, MC Candiotti. Influence of residual milk-clotting enzyme on  $\alpha_{S1}$  casein hydrolysis during ripening of Reggianito Argentino cheese. *J Dairy Sci* 87: 565–673, 2004.
81. N Datta, HC Deeth. Diagnosing the cause of proteolysis in UHT milk. *Lebensm Wiss Technol* 36: 173–182, 2003.
82. S Haryani, N Datta, AJ Elliott, HC Deeth. Production of proteinases by psychrotrophic bacteria in raw milk stored at low temperature. *Aust J Dairy Technol* 58: 15–20, 2003.
83. TX Le, N Datta, HC Deeth. Sensitive HPLC method for measuring bacterial proteolysis and proteinase activity in UHT milk. *Food Res Int* 39: 823–830, 2006.
84. I De Noni, L Pellegrino, S Cattaneo, P Resmini. HPLC of proteose peptones for evaluating ageing of packaged pasteurized milk. *Int Dairy J* 17: 12–19, 2007.
85. SB Kim, IS Seo, MA Khan, KS Ki, WS Lee, HJ Lee, HS Shin, HS Kim. Enzyme hydrolysis of heated whey: Iron binding ability of peptides an antigenic protein fractions. *J Dairy Sci* 90: 4033–4042, 2007.
86. IMPLVO Ferreira, R Eca, O Pinho, P Tavares, A Pereira, AC Roque. Development and validation of an HPLC/UV method for quantification of bioactive peptides in fermented milks. *J Liq Chromatogr Relat Technol* 30: 13–16, 2007.
87. CG Papadimitriou, A Vafapolou-Mastrojiannaki, SV Silva, AM Gomes, FX Malcata, E Alichanidis. Identification of peptides in traditional and probiotic sheep milk yoghurt with angiotensin I-converting enzyme (ACE)-inhibitory activity. *Food Chem* 105: 647–656, 2007.

88. I Tzvetkova, M Dalgarrondo, S Danova, I Illiev, I Ivanova, JM Chovert, T Haertle. Hydrolysis of major dairy proteins by lactic acid bacteria from Bulgarian yogurts. *J Food Biochem* 31: 680–702, 2007.
89. XL Zhu, T Matsui, K Watanabe, K Shiraishi, T Ueki, K Matsumoto. Simultaneous determination of antiotensin I-converting enzyme inhibitory peptides in tryptic casein hydrolysate by high-performance liquid chromatography combined with a replicate heart-cut column-switching technique. *J Agric Food Chem* 55: 8367–8371, 2007.
90. R López-Fandiño, J Otte, J van Camp. Physiological, chemical and technological aspects of milk-protein-derived peptides with antihypertensive and ACE-inhibitory activity. *Int Dairy J* 16: 1277–1293, 2006.
91. J Amiot, L Germain, S Turgeon, M Lemay, C Ory-Salam C, FA Auger. Peptides from milk protein hydrolysates to improve the growth of human keratinocytes in culture. *Int Dairy J* 14: 619–626, 2004.
92. JA Gómez-Ruiz, M Ramos, I Recio. Angiotensin converting enzyme-inhibitory activity of peptides isolated from Manchego cheese. Stability under simulated gastrointestinal digestion. *Int Dairy J* 14: 1075–1080, 2004.
93. S Roufik, SF Gauthier, SL Turgeon. In vitro digestibility of bioactive peptides derived from bovine beta-lactoglobulin. *Int Dairy J* 16: 294–302, 2006.
94. S Roufik, SF Gauthier, SL Turgeon. Physicochemical characterization and in vitro digestibility of beta-lactoglobulin/beta Lg f142–148 complexes. *Int Dairy J* 17: 471–480, 2007.
95. J Dziuba, D Nalecz, P Minkiewicz, B Dziuba. Identification and determination of milk and soybean protein preparations using enzymatic hydrolysis followed by chromatography and chemometrical data analysis. *Anal Chim Acta* 521: 17–24, 2004.
96. K El-Zahar, M Sitohy, Y Choiset, F Metro, T Haertle, JM Chobert. Peptic hydrolysis of ovine beta-lactoglobulin and alpha-lactalbumin—Exceptional susceptibility of native ovine beta-lactoglobulin to pepsinolysis. *Int Dairy J*, 15: 17–27, 2005.
97. LK Creamer, HC Nilsson, MA Paulsson, CJ Coker, JP Hill, R Jiménez-Flórez. Effect of genetic variation on the tryptic hydrolysis of bovine  $\beta$ -lactoglobulin A, B or C. *J Dairy Sci* 87: 4023–4032, 2004.
98. F Bonomi, A Fiocchi, H Frokiaer, A Gaiaschi, S Iametti, C Poesi, P Rasmussen, P Restani, P Rovere. Reduction of immunoreactivity of bovine  $\beta$ -lactoglobulin upon combined physical and proteolytic treatment. *J Dairy Res* 70: 51–59, 2003.
99. R Chicón, J Belloque, I Recio, R. López-Fandiño. Tryptic hydrolysis of  $\beta$ -lactoglobulin as influenced by high hydrostatic pressure. *J Dairy Res* 73: 121–128, 2006a.
100. R Chicón, R López-Fandiño, A Quirós, J Belloque. Changes in chymotrypsin hydrolysis of  $\beta$ -lactoglobulin A induced by high hydrostatic pressure. *J Agric Food Chem* 54: 2333–2341, 2006b.
101. R Chicón, R López-Fandiño, E Alonso, J Belloque. Proteolytic pattern, antigenicity and serum IgE binding of  $\beta$ -lactoglobulin hydrolysates obtained by pepsin and high pressure treatments. *J Dairy Sci* 91: 928–938, 2008.
102. I Maier, VM Okun, F Pittner, W Lindner. Changes in peptide digestibility of bovine  $\beta$ -lactoglobulin as a result of food processing studied by capillary electrophoresis and immunochemical methods. *J Chromatogr B* 841: 160–167, 2006.
103. R Chicón, J Belloque, E Alonso, R López-Fandiño. Immunoreactivity and digestibility of high-pressure-treated whey proteins. *Int Dairy J* 18: 367–376, 2008.
104. ON Donkor, A Henriksson, TK Singh, T Vasiljevic, NP Shah. ACE-inhibitory activity of probiotic yoghurt. *Int Dairy J* 17: 1321–1331, 2007.
105. J Otte, SMA Shalaby, M Zakora, MS Nielsen. Fractionation and identification of ACE-inhibitory peptides from alpha-lactalbumin and beta-casein produced by thermolysin-catalysed hydrolysis. *Int Dairy J* 17: 1460–1472, 2007.
106. MC Robert, A Razaname, M Mutter, MA Juillerat. Peptides derived from sodium caseinate hydrolysates produced by *Lactobacillus helveticus* NCC 2765. *J Agric Food Chem* 52: 6923–6931, 2004.

107. P Hemstrom, K Irgum. Hydrophobic interaction chromatography. *J. Sep Sci* 29: 1784–1821, 2006.
108. H Schlichtherle-Cerny, M Affolter, C Cerny. Hydrophobic interaction liquid chromatography coupled to electrospray mass spectrometry of small polar compounds in food analysis. *Anal Chem* 75: 2349–2354, 2003.
109. C van der Ven, S Muresan, H Gruppen, DBA de Bont, KB Merck, AGJ Voragen. FTIR spectra of whey and casein hydrolysates in relation to their functional properties. *J Agric Food Chem* 50: 6943–6950, 2002.
110. HO Kim, ECY Li-Chan. Application of Fourier transform Raman spectroscopy for prediction of bitterness of peptides. *Appl Spectrosc* 60: 1297–1306, 2006.
111. ECY Li-Chan. Vibrational spectroscopy applied to the study of milk proteins. *Lait* 87: 443–458, 2007.
112. CM Andersen, G Mortensen. Fluorescence spectroscopy: A rapid tool for analysing dairy products. *J Agric Food Chem* 56: 720–729, 2008.
113. S Roufik, SF Gauthier, E Dofour, SL Turgeon. Interactions between bovine  $\beta$ -lactoglobulin A and various bioactive peptides as studied by front-face fluorescence spectroscopy. *J Agric Food Chem* 54: 4962–4969, 2006.
114. CMS Barbosa, HA Morais, FM Delvivo, HS Mansur, MC Oliveira, MPC Silvestre. Papain hydrolysates of casein: Molecular weight profile and encapsulation in lipospheres. *J Sci Food Agric* 84: 1891–1900, 2004.
115. L Monaci, V Tregoat, AJ van Hengel, E Anklam. Milk allergens, their characteristics and their detection in food. *Eur Food Res Technol* 223: 149–179, 2006.
116. G Docena, P Rozenfeld, R Fernández, CA Fossati. Evaluation of the residual antigenicity and allergenicity of cow's milk substitutes by in vitro tests. *Allergy* 57: 83–91, 2002.
117. B Wroblewska, M Kamarac, R Amarowicz, A Szymkiewicz, A Troszynska, E Kubicka. Immunoreactive properties of peptide fractions of cow whey milk proteins after enzymatic hydrolysis. *Int J Food Sci Technol* 39: 839–850, 2004.
118. SC Cheison, Z Wang, SY Xu. Preparation of whey protein hydrolysates using a single and two-stage enzymatic membrane reactor and their immunological and antioxidant properties: Characterization by multivariate data analysis. *J Agric Food Chem* 55: 3896–3904, 2007.
119. A Puerta, JC Díez-masa, M de Frutos. Immunochromatographic determination of  $\beta$ -lactoglobulin and its antigenic peptides in hypoallergenic formulas. *Int Dairy J* 16: 406–414, 2006.
120. L Stepaniak, L Jedrychowski, B Wroblewska, T Sorhaug. Immunoreactivity and inhibition of angiotensin converting enzyme and lactococcal oligopeptidase by peptides from cheese. *Ital J Food Sci* 13: 373–381, 2001.
121. DJ Walsh, H Bernard, BA Murray, J MacDonald, AK Pentzien, GA Wright, JM Wal, AD Struthers, H Meisel, RJ FitzGerald. In vitro generation and stability of the lactokin  $\beta$ -lactoglobulin fragment (142–148). *J Dairy Sci* 87: 3845–3857, 2004.
122. M Kinter, NE Sherman. *Protein sequencing and Identification Using Tandem Mass Spectrometry*. Wiley-Interscience Series on Mass Spectrometry. DM Desiderio and NMM Nibbering, Series Eds. John Wiley & Sons, Inc., New York, 2000.
123. B Domon, R Aebersold. Mass spectrometry and protein analysis. *Science* 14: 212–217, 2006.
124. CS Lane. Mass spectrometry-based proteomics in the life sciences. *Cell Mol Life Sci* 62: 848–869, 2005.
125. AI Nesvizhskii, O Vitek, R Aebersold. Analysis and validation of proteomic data generated by tandem mass spectrometry. *Nat Methods* 4: 787–797, 2007.
126. P Ferranti. Mass spectrometric approach for the analysis of food proteins. *Eur J Mass Spectrom* 10: 349–358, 2004.
127. M Carbonaro. Proteomics: Present and future in food quality evaluation. *Trends Food Sci Technol* 15: 209–216, 2004.
128. R O'Donnell, JW Holland, HC Deeth, P Allewood. Milk proteomics. *Int Dairy J* 14: 1013–1023, 2004.
129. PA Guy, F Fenaille. Contribution of mass spectrometry to assess quality of milk-based products. *Mass Spectrom Rev* 25: 290–326, 2006.



130. MA Manso, J Léonil, G Jan, V Gagnaire. Application of proteomics to the characterisation of milk and dairy products. *Int Dairy J* 15: 845–855, 2005.
131. P Ferranti, R Pizzano, G Garro, S Caira, L Chianese, F Addeo. Mass spectrometry-based procedure for the identification of ovine casein heterogeneity. *J Dairy Res* 68: 35–51, 2001.
132. P Roncada, A Gaviraghi, S Liberatori, B Canas, L Bini, GF Greppi. Identification of caseins in goat milk. *Proteomics* 2: 723–726, 2002.
133. V Cunsolo, F Galliano, V Muccilli, R Saletti, D Marletta, S Bordonaro, S Foti. Detection and characterization by high-performance liquid chromatography and mass spectrometry of a goat  $\beta$ -casein associated with a CSN2 null allele. *Rapid Commun Mass Spectrum* 19: 2943–2949, 2005.
134. V Cunsolo, V Muccilli, R Saletti, D Marletta, S Foti. Detection and characterization by high-performance liquid chromatography and mass spectrometry of two truncated goat  $\alpha_{s2}$ -caseins. *Rapid Commun Mass Spectrum* 20: 1061–1070, 2006.
135. V Cunsolo, A Costa, R Saletti, V Muccilli, S Foti. Detection and sequence determination of a new variant  $\beta$ -lactoglobulin II from donkey. *Rapid Commun Mass Spectrum* 21: 1438–1446, 2007.
136. GH Talbo, D Suckau, M Malkoski, E Reynolds. MALDI-PSD-MS analysis of the phosphorylation sites of caseinomacropptide. *Peptides* 22: 1093–1098, 2001.
137. G Mamone, S Caira, G Garro, A Nicolai, P Ferranti, G Picariello, A Malorni, L Chianese, F Addeo. Casein phosphoproteome: Identification of phosphoproteins by combined mass spectrometry and two-dimensional gel electrophoresis. *Electrophoresis* 24: 2824–2837, 2003.
138. S Claverol, O Burlet-Schiltz, JE Gairin, B Monsarrat. Characterization of protein variants and post-translational modifications: ESI-MS analyses of intact proteins eluted from polyacrylamide gels. *Mol Cell Proteomics* 2: 483–493, 2003.
139. JW Holland, HC Deeth, PF Alewood. Proteomic analysis of  $\kappa$ -casein micro-heterogeneity. *Proteomics* 4: 743–752, 2004.
140. LK Creamer, A Bienvenue, H Nilsson, M Paulsson, M Van Wanroij, EK Lowe, SG Anema, MJ Boland, R Jiménez-Flores. Heat-induced redistribution of disulfide bonds in milk proteins. 1 Bovine  $\beta$ -lactoglobulin. *J Agric Food Chem* 52: 7660–7668, 2004.
141. JW Holland, HC Deeth, P Alewood. Resolution and characterisation of multiple isoforms of ovine  $\kappa$ -casein by 2-DE following a reversible cysteine-tagging enrichment strategy. *Proteomics* 6: 3087–3095, 2006.
142. W Chen, PJ Lee, M Stapels, JC Gebler. The use of mass spectrometry to determine location and extent of N-glycosylation on folate binding protein from bovine milk. *Rapid Commun Mass Spectrum* 20: 313–316, 2006.
143. A Amoresano, G Chiappetta, P Pucci, M D’Ischia, G Marino. Bidimensional tandem mass spectrometry for selective identification of nitration sites in proteins. *Anal Chem* 19: 2109–2117, 2007.
144. D Mollé, F Morgan, S Bouhallab, J Léonil. Selective detection of lactolated peptides in hydrolysates by liquid chromatography/electrospray tandem mass spectroscopy. *Anal Biochem* 259: 152–161, 1998.
145. LF Marvin, V Parisod, LB Fay, PA Guy. Characterization of lactosylated proteins of infant formula powders using two-dimensional gel electrophoresis and nano-electrospray mass spectrometry. *Electrophoresis* 23: 2505–2512, 2002.
146. YD Livney, DG Dalglish. Specificity of disulfide bond formation during thermal aggregation in solutions of  $\beta$ -lactoglobulin B and  $\kappa$ -casein A. *J Agric Food Chem* 52: 5527–5532, 2004.
147. JJ Kehoe, A Brodkorb, D Mollé, E Yokoyama, MH Famelart, S Bouhallab, ER Morris, T Croguenec. Determination of exposed sulfhydryl groups in heated  $\beta$ -lactoglobulin a using IAEDANS and mass spectrometry. *J Agric Food Chem* 55: 7107–7113, 2007.
148. M Yamada, K Murakami, JC Wallingford, Y Yuki. Identification of low-abundance proteins of bovine colostrum and mature milk using two-dimensional electrophoresis followed by microsequencing and mass spectrometry. *Electrophoresis* 23: 1153–1160, 2002.
149. A Panchaud, M Kussmann, M Affolter. Rapid enrichment of bioactive milk proteins and iterative, consolidated protein identification by multidimensional protein identification technology. *Proteomics* 5: 3836–3846, 2005.

150. BY Fong, CS Norris, KP Palmano. Fractionation of bovine whey proteins and characterisation by proteomic techniques. *Int Dairy J* 18: 23–46, 2008.
151. J Charlwood, S Hanrahan, R Tyldesley, J Langridge, M Dwek, P Camilleri. Use of proteomic methodology for the characterization of human milk fat globular membrane proteins. *Anal Biochem* 301: 314–324, 2002.
152. TA Reinhardt, D Lippolis. Bovine milk fat globule membrane proteome. *J Dairy Res* 73: 406–416, 2006.
153. BY Fong, CS Norris, AKH MacGibbon. Protein and lipid composition of bovine milk-fat-globule membrane. *Int Dairy J* 17: 275–288, 2007.
154. TA Reinhardt, JD Lippolis. Developmental changes in the milk fat globule membrane proteome during the transition from colostrums to milk. *J Dairy Sci* 91: 2307–2318, 2008.
155. R Baeker, S Habel, K Schlatterer, B Schlatterer. Lipocalin-type prostaglandin D synthase in milk: A new biomarker for bovine mastitis. *Prostaglandins Other Lipid Mediat* 67: 75–88, 2002.
156. A Napoli, D Aiello, L Di Donna, H Prendushi, G Sindona. Exploitation of endogenous protease activity in raw mastitic milk by MALDI-TOF. *Anal Chem* 79: 5941–5948, 2007.
157. G Pohlentz, S Kölbl, J Peter-Katalinic. High sequence coverage by in-capillary proteolysis of native proteins and simultaneous analysis of the resulting peptides by nano-electrospray ionization-mass spectrometry and tandem mass spectrometry. *Proteomics* 5: 1758–1763, 2005.
158. FJ Moreno, I Recio, A Olano y R López-Fandiño. Chromatographic characterization of ovine  $\kappa$ -casein macropeptide. *J Dairy Res* 67: 349–359, 2000.
159. FJ Moreno, I Recio, A Olano, R López-Fandiño. Heterogeneity of caprine  $\kappa$ -casein macropeptide. *J Dairy Res* 68: 197–208, 2001.
160. JM Girardet, L Miclo, S Florent, D Mollé, JL Gaillard. Determination of the phosphorylation level and deamidation susceptibility of equine  $\beta$ -casein. *Proteomics* 6: 3707–3717, 2006.
161. M Cuccurullo, G Schlosser, G Cacace, L Malorni, G Pocsfalvi. Identification of phosphoproteins and determination of phosphorylation sites by zirconium dioxide enrichment and SELDI-MS/MS. *J Mass Spectrom* 42: 1069–1078, 2007.
162. M Adamczyk, JC Gebler, K Shreder, J Wu. Identification of unknown residue 55 in bovine folate binding protein: Fingerprint matching and sequencing of a doubly tagged peptide fragment by ion trap mass spectrometry. *Rapid Commun Mass Spectrom* 17: 1504–1506, 2003.
163. YD Livney, AL Schwan, DG Dalglish. A study of  $\beta$ -casein tertiary structure by intramolecular cross-linking and mass spectrometry. *J Dairy Sci* 87: 3638–3647, 2004.
164. EK Lowe, SG Anema, A Bienvenue, MJ Boland, LK Creamer, R Jiménez-Flores. Heat-induced redistribution of disulfide bonds in milk proteins. 2. Disulfide bonding patterns between bovine  $\beta$ -lactoglobulin and  $\kappa$ -casein. *J Agric Food Chem* 52: 7669–7680, 2004.
165. M Kussmann, M Affolter, K Nagy, B Holst, LB Fay. Mass spectrometry in nutrition: Understanding dietary health effects at the molecular level. *Mass Spectrom Rev* 26: 727–750, 2007.
166. MM Contreras, I López-Expósito, B Hernández-Ledesma, M Ramos, I Recio. Application of mass spectrometry to the characterization and quantification of food-derived bioactive peptides. *J AOAC Int*, 91: 981–994, 2008.
167. T Rokka, EL Syvaöja, J Tuominen, H Korhonen. Release of bioactive peptides by enzymatic proteolysis of *Lactobacillus GG* fermented UHT milk. *Milchwissenschaft* 52: 675–678, 1997.
168. M Gobbetti, P Ferranti, E Smacchi, F Goffredi, F Addeo. Production of angiotensin-I-converting-enzyme-inhibitory peptides in fermented milks started by *Lactobacillus delbrueckii* subsp. *bulgaricus* SS1 and *Lactococcus lactis* subsp. *cremoris* FT4. *Appl Environ Microbiol* 66: 3898–3904, 2000.
169. T Saito, T Nakamura, H Kitazawa, Y Kawai, T Itoh. Isolation and structural analysis of antihypertensive peptides that exist naturally in Gouda Cheese. *J Dairy Sci* 83: 1434–1440, 2000.
170. P Ferranti, F Barone, L Chianese, F Addeo, A Scaloni, L Pellegrino, R Pierpaolo. Phosphopeptides from Grana Padano cheese: Nature, origin and changes during ripening. *J Dairy Res* 64: 601–615, 1997.
171. P Ferranti, E Iolli, F Barone, A Malorni, G Garro, P Laezza, L Chianese, F Migliaccio, V Stingo, F Addeo. Combined high resolution chromatographic techniques (FPLC and HPLC) and mass spectrometry-based identification of peptides and proteins in Grana Padano cheese. *Lait* 77: 683–697, 1997.

172. F Addeo, L Chianese, A Salzano, R Sacchi, U Cappuccio, P Ferranti, A Malorni. Characterization of the 12% trichloroacetic acid-insoluble oligopeptides of Parmigiano-Reggiano cheese. *J Dairy Res* 59: 401–411, 1992.
173. F Addeo, L Chianese, R Sacchi, SS Musso, P Ferranti, A Malorni. Characterization of the oligopeptides of Parmigiano-Reggiano cheese soluble in 120 g trichloroacetic acid/L. *J Dairy Res* 61: 365–374, 1994.
174. L Chianese, S Caira, P Ferranti, P Laezza, A Malorni, G Mucchetti, G Garro, F Addeo. The oligopeptides of sweet and acid cheese whey. *Lait* 77: 699–715, 1997.
175. F Roudot-Algaron, D Le Bars, L Kerhoas, J Einhorn, JC Gripon. Phosphopeptides from Comté Cheese: Nature and Origin. *J Food Sci* 59: 544–547, 1994.
176. M Murakami, H Tonouchi, R Takahashi, H Kitazawa, Y Kawai, H Negishi, T Saito. Structural analysis of a new anti-hypertensive peptide ( $\beta$ -Lactosin B) isolated from a commercial whey product. *J Dairy Res* 87: 1967–1974, 2004.
177. K Suetsuna, H Ukeda, H Ochi. Isolation and characterization of free radical scavenging activities peptides derived from casein. *J Nutr Biochem* 11: 128–131, 2000.
178. C Matar, J Goulet.  $\beta$ -Casomorphin 4 from milk fermented by a mutant of *Lactobacillus helveticus*. *Int Dairy J* 6: 383–397, 1996.
179. A Pihlanto-Leppälä, T Rokka, H Korhonen. Angiotensin I converting enzyme inhibitory peptides derived from bovine milk proteins. *Int Dairy J* 8: 325–331, 1998.
180. MC Robert, A Razaname, M Mutter, MA Juillerat. Identification of angiotensin-I-converting enzyme inhibitory peptides derived from sodium caseinate hydrolysates produced by *Lactobacillus helveticus* NCC 2765. *J Agric Food Chem* 52: 6923–6931, 2004.
181. M Hayes, C Stanton, H Slattery, O O’Sullivan, C Hill, GF Fitzgerald, RP Ross. Casein fermentate of *Lactobacillus animalis* DPC 6134 contains a range of novel propeptide angiotensin-converting enzyme inhibitors. *Appl Environ Microbiol* 73: 4658–4667, 2007.
182. A Quirós, M Ramos, B Muguerza, MA Delgado, M Miguel, A Aleixandre, I Recio. Identification of novel antihypertensive peptides in milk fermented with *Enterococcus faecalis*. *Int Dairy J* 17: 33–41, 2007.
183. M Miguel, I Recio, M Ramos, MA Delgado, MA Aleixandre. Antihypertensive effect of peptides obtained from *Enterococcus faecalis*-fermented milk in rats. *J Dairy Sci* 89: 3352–3359, 2006.
184. S Didelot, S Bordenave-Juchereau, E Rosenfeld, I Fruitier-Arnaudin, J-M Piot, F Sannier. Preparation of angiotensin-I-converting enzyme inhibitory hydrolysates from unsupplemented caprine whey fermentation by various cheese microflora. *Int Dairy J* 16: 976–983, 2006.
185. A Quirós, B Hernández-Ledesma, M Ramos, L Amigo, I Recio. Angiotensin-converting enzyme inhibitory activity of peptides derived from caprine kefir. *J Dairy Sci* 88: 3480–3487, 2005.
186. JA Gómez-Ruiz, M Ramos, I Recio. Angiotensin-converting enzyme-inhibitory peptides in Manchego cheeses manufactured with different starter cultures. *Int Dairy J* 12: 697–706, 2002.
187. JA Gómez-Ruiz, M Ramos, I Recio. Identification and formation of angiotensin-converting enzyme-inhibitory peptides in Manchego cheese by high-performance liquid chromatography–tandem mass spectrometry. *J Chromatogr A* 1054: 269–277, 2004.
188. JA Gómez-Ruiz, G Taborda, L Amigo, I Recio, M Ramos. Identification of ACE-inhibitory peptides in different Spanish cheeses by tandem mass spectrometry. *Eur Food Res Technol* 223: 595–601, 2006.
189. CG Rizzello, I Losito, M Gobbetti, T Carbonara, MD De Bari, PG Zambonin. Identification of peptides in antimicrobial fractions of cheese extracts by electrospray ionization ion trap mass spectrometry coupled to a two-dimensional liquid chromatographic separation. *J Dairy Sci* 88: 2348–2360, 2005.
190. I Losito, T Carbonara, MD De Bari, M Gobbetti, F Palmesano, CG Rizzello, PG Zambonin. Identification of peptides in antimicrobial fractions of cheese extracts by electrospray ionization ion trap mass spectrometry coupled to a two-dimensional liquid chromatographic separation. *Rapid Commun Mass Spectrom* 20: 447–455, 2006.

191. S Bouhallab, D Mollé, J Léonil. Continuous hydrolysis of  $\beta$ -casein in a membrane reactor: Preparation of a bioactive peptide. *Biotechnol. Lett.* 15: 697–702, 1993.
192. J Tauzin, L Miclo, J-L Gaillar. Angiotensin-I-converting enzyme inhibitory peptides from tryptic hydrolysate of bovine  $\alpha_{s2}$ -casein. *FEBS Lett* 531: 369–374, 2002.
193. J Tauzin, L Miclo, S Roth, D Mollé, J-L Gaillar. Tryptic hydrolysis of bovine  $\alpha_{s2}$ -casein: Identification and release kinetics of peptides. *Int Dairy J* 13: 15–27, 2003.
194. I De Noni, R Floris. Specific release of Albutensins from bovine and human serum albumin. *Int Dairy J* 17: 504–512, 2007.
195. MA Manso, R López-Fandino. Angiotensin I converting enzyme-inhibitory activity of bovine, ovine, and caprine kappa-casein macropeptides and their tryptic hydrolysates. *J Food Prot* 66: 1686–1692, 2003.
196. J-M Chobert, K El-Zahar, M Sitohy, M Dalgalarondo, F Métro, Y Choiset, T Haertlé. Angiotensin I-converting-enzyme (ACE)-inhibitory activity of tryptic peptides of ovine  $\beta$ -lactoglobulin and of milk yoghurts obtained by using different starters. *Lait* 85: 141–152, 2005.
197. RS Annan, MJ Huddleston, R Verma, RJ Deshaies, SA Carr. A multidimensional electrospray MS-based approach to phosphopeptide mapping. *Anal Chem* 73: 393–404, 2001.
198. SA Carr, MJ Huddleston, RS Annan. Selective detection and sequencing of phosphopeptides at the femtomole level by mass spectrometry. *Anal Biochem* 239: 180–192, 1996.
199. KB McCann, BJ Shiell, WP Michalski, A Lee, J Wan, H Roginski, MJ Coventry. Isolation and characterisation of antibacterial peptides derived from the f(164–207) region of bovine  $\alpha_{s2}$ -casein. *Int Dairy J* 15: 133–143, 2005.
200. KB McCann, BJ Shiell, WP Michalski, A Lee, J Wan, H Roginski, MJ Coventry. Isolation and characterisation of a novel antibacterial peptide from bovine  $\alpha_{s1}$ -casein. *Int Dairy J* 16: 316–323, 2006.
201. I López-Expósito, JA Gómez-Ruiz, L Amigo, I Recio. Identification of antibacterial peptides from ovine  $\alpha_{s2}$ -casein. *Int Dairy J* 16: 1072–1080, 2006.
202. I López-Expósito, A Quirós, L Amigo, I Recio. Casein hydrolysates as a source of antimicrobial, anti-oxidant and antihypertensive peptides. *Lait* 87: 241–249, 2007.
203. I López-Expósito, F Minervini, L Amigo, I Recio. Identification of antibacterial peptides from bovine kappa-casein. *J Food Prot* 69: 2992–2997, 2006.
204. DA Dionysius, JM Milne. Antibacterial peptides of bovine lactoferrin: Purification and characterisation. *J Dairy Sci* 80: 667–674, 1997.
205. I Recio, S Visser. Identification of two distinct antibacterial domains within the sequence of bovine  $\alpha_{s2}$ -casein. *Biochim Biophys Acta* 1428: 314–326, 1999.
206. J Otte, SM Shalaby, M Zakora, AH Pripp, A Sayed, A El-Shabrawy. Angiotensin-converting enzyme inhibitory activity of milk protein hydrolysates: Effect of substrate, enzyme and time of hydrolysis. *Int Dairy J* 17: 488–503, 2007.
207. B Hernández-Ledesma, A Dávalos, B Bartolomé, L Amigo. Preparation of antioxidant enzymatic hydrolysates from  $\alpha$ -lactalbumin and  $\beta$ -lactoglobulin. Identification of active peptides by HPLC–MS/MS. *J Agric Food Chem* 53: 588–593, 2005.
208. CJ Van Platerink, MJ Hans-Gerd, J Haverkamp. Development of an at-line method for the identification of angiotensin-I inhibiting peptides in protein hydrolysates. *J Chromatogr B* 846: 147–154, 2007.
209. JA Gómez-Ruiz, M Ramos, I Recio. Identification of novel angiotensin-converting enzyme-inhibitory peptides from ovine milk proteins by CE-MS and chromatographic techniques. *Electrophoresis* 28: 4202–4211, 2007.
210. B Hernández-Ledesma, A Quirós, L Amigo, I Recio. Identification of bioactive peptides after digestion of human milk and infant formula with pepsin and pancreatin. *Int Dairy J* 17: 42–49, 2007.
211. E Miquel, JA Gómez, A Alegría, R Barberá, R Farré, I Recio. Identification of casein phosphopeptides released after simulated digestion of milk-based infant formulas. *J Agric Food Chem* 53: 3426–3433, 2005.

212. E Miquel, A Alegría, R Barberá, R Farré. Identification of novel phosphopeptides after simulated digestion of  $\alpha_{s2}$ -casein by tandem mass spectrometry. *Food Sci Technol Int* 12: 531–537, 2006.
213. E Miquel, JA Gómez, A Alegría, R Barberá, R Farré, I Recio. Identification of casein phosphopeptides in  $\beta$ -casein and commercial hydrolysed casein by mass spectrometry. *Food Sci Technol Int* 12: 379–384, 2006.
214. E Miquel, JA Gómez, A Alegría, R Barberá, R Farré, I Recio. Identification of casein phosphopeptides after simulated gastrointestinal digestion by tandem mass spectrometry. *Eur Food Res Technol* 222: 48–53, 2006.
215. E Miquel, A Alegría, R Barberá, R Farré. Speciation analysis of calcium, iron, and zinc in casein phosphopeptide fractions from toddler milk-based formula by anion exchange and reversed-phase high-performance liquid chromatography–mass spectrometry/flame atomic-absorption spectroscopy. *Anal Bioanal Chem* 381: 1082–1088, 2005.
216. M Malkoski, SG Dashper, NM O'Brien-Simpson, GH Talbo, M Macris, KJ Cross, E Reynolds. Kappacin, a novel antibacterial peptide from bovine milk. *Antimicrob Agents Chem* 45: 2309–2315, 2001.
217. M Hayes, RP Ross, GF Fitzgerald, C Hill, C Stanton. Casein-derived antimicrobial peptides generated by *Lactobacillus acidophilus* DPC6026. *Appl Environ Microbiol* 72: 2260–2264, 2006.
218. F Minervini, F Algaron, CG Rizzello, PF Fox, V Monnet, M Gobetti. Angiotensin I-converting-enzyme-inhibitory and antibacterial peptides from *Lactobacillus helveticus* PR4 proteinase-hydrolyzed caseins of milk from six species. *Appl Environ Microbiol* 69: 5297–5305, 2003.
219. NJ Adamson, EC Reynolds. Relationships between degree of casein hydrolysis and phosphopeptide release. *J Dairy Res* 64: 505–514, 1997.
220. KH Ellegard, C Gammelgard-Larsen, ES Sorensen, S Fedosov. Process scale chromatographic isolation, characterization and identification of tryptic bioactive casein phosphopeptides—Proteins. *Int Dairy J* 9: 639–652, 1999.
221. CY Lo, WY Chen, CT Chen, YC Chen. Rapid enrichment of phosphopeptides from tryptic digests of proteins using iron oxide nanocomposites of magnetic particles coated with zirconia as the concentrating probes. *J Proteome Res* 6: 887–893, 2007.
222. Y Wang, W Chen, J Wu, Y Guo, X Xia. Highly efficient and selective enrichment of phosphopeptides using porous anodic alumina membrane for MALDI-TOF MS analysis. *J Am Soc Mass Spectrom* 18: 1387–1395, 2007.
223. W Zhou, BA Merrick, MG Khaledi, KB Tomer. Detection and sequencing of phosphopeptides affinity bound to immobilized metal ion beads by matrix-assisted laser desorption/ionization mass spectrometry. *J Am Soc Mass Spectrom* 11: 273–282, 2000.
224. MR Larsen, TE Thingholm, ON Jensen, P Roepstorff, TJD Jorgensen. Highly selective enrichment of phosphorylated peptides from peptide mixtures using titanium dioxide microcolumns. *Mol Cell Proteomics* 4: 873–886, 2005.
225. CT Chen, YC Chen.  $\text{Fe}_3\text{O}_4/\text{TiO}_2$  core/shell nanoparticles as affinity probes for the analysis of phosphopeptides using  $\text{TiO}_2$  surface-assisted laser desorption/ionization mass spectrometry. *Anal Chem* 77: 5912–5919, 2005.
226. KL Bennet, A Stensballe, AV Podtelejnikov, M Moniatte, ON Jensen. Phosphopeptide detection and sequencing by matrix-assisted laser desorption/ionization quadrupole time-of-flight tandem mass spectrometry *J Mass Spectrom* 37: 179–190, 2002.
227. C Liepke, HD Zucht, WG Forssmann, LJ Ständker. Purification of novel peptide antibiotics from human milk. *Chromatography B* 752: 369–377, 2001.
228. JCK Chan, ECY Li-Chan. Production of lactoferricin and other cationic peptides from food grade lactoferrin with various iron saturation levels. *J Agric Food Chem* 55: 493–501, 2007.
229. S Bouhallab, N Ait Oukhatar, D Mollé, G Henry, J-L Maubois, P Arhan, DLJ Bouglé. Sensitivity of beta-casein phosphopeptide-iron complex to digestive enzymes in ligated segment of rat duodenum. *Nutr Biochem* 10: 723–727, 1999.
230. B Hernández-Ledesma, B Miralles, L Amigo, M Ramos, I Recio. Identification of antioxidant and ACE-inhibitory peptides in fermented milk. *J Sci Food Agric* 85: 1041–1048, 2005.

231. B Hernández-Ledesma, I Recio, M Ramos, L Amigo. Preparation of ovine and caprine  $\beta$ -lactoglobulin hydrolysates with ACE-inhibitory activity. Identification of ACE-inhibitory peptides from caprine  $\beta$ -lactoglobulin hydrolysed with thermolysin. *Int Dairy J* 12: 805–812, 2002.
232. B Hernández-Ledesma, M Ramos, I Recio, L Amigo. Effect of  $\beta$ -lactoglobulin hydrolysis with thermolysin under denaturing temperatures on the release of bioactive peptides. *J Chromatogr A* 1116: 31–37, 2006.
233. V Vermeirssen, B Deplancke, KA Tappenden, J Van Camp, HR Gaskins, W Verstraete. Intestinal transport of the lactokinin Ala-Leu-Pro-Met-His-Ile-Arg through a Caco-2 Bbe monolayer. *J Pept Sci* 8: 95–100, 2002.
234. CS Raska, CE Parker, Z Dominski, WF Marzluff, GL Glish, RM Pope, CH Borchers. Direct MALDI-MS/MS of phosphopeptides affinity-bound to immobilized metal ion affinity chromatography beads. *Anal Chem* 74: 3429–3433, 2002.
235. JR Broadbent, M Strickland, BC Weimer, ME Johnson, JL Steele. Peptide accumulation and bitterness in Cheddar cheese made using single-strain *Lactococcus lactis* starters with distinct proteinase specificities. *J Dairy Sci* 81: 327–337, 1998.
236. AM Gouldsworthy, J Leaver, JM Banks. Application of a mass spectrometry sequencing technique for identifying peptides present in Cheddar cheese. *Int Dairy J* 6: 781–790, 1996.
237. E Soeryapranata, JR Powers, HH Hill, WF Siems, K Al-Saad, JM Weller. Matrix-assisted laser desorption/ionization time-of-flight mass spectrometry method for the quantification of  $\beta$ -casein fragment (f193–209). *J Food Sci* 67: 534–538, 2002.
238. E Soeryapranata, J Powers, F Fajarrini, K Weller, H Hill, W Siems. Relationship between MALDI-TOF analysis of  $\beta$ -CN f193–209 concentration and sensory evaluation of bitterness intensity of aged Cheddar cheese. *J Agric Food Chem* 50: 4900–4905, 2002.
239. E Soeryapranata, J Powers, K Weller, H Hill, W Siems. Differentiation of intracellular peptidases of starter and adjunct cultures using matrix-assisted laser desorption/ionization time-of-flight mass spectrometry. *Lebens Wissens Tech* 37: 17–22, 2004.
240. M Lund, Y Ardö. Purification and identification of water-soluble phosphopeptides from cheese using Fe(III) affinity chromatography and mass spectrometry. *J Agric Food Chem* 52: 6616–6622, 2004.
241. I Alli, M Okoniewska, BF Gibss, Y Konishi. Identification of peptides in Cheddar cheese by electrospray ionization mass spectrometry. *Int Dairy J* 8: 643–649, 1998.
242. N Sommerer, C Salles, D Prome, JC Prome, JL le Quere. Isolation of oligopeptides from the water-soluble extract of goat cheese and their identification by mass spectrometry. *J Agric Food Chem* 49: 402–408, 2001.
243. P Piraino, VK Upadhyay, R Rossano, P Riccio, E Parente, AL Kelly, PLH McSweeney. Use of mass spectrometry to characterize proteolysis in cheese. *Food Chem* 101: 964–972, 2007.
244. T Jiang, LJ Chen, L Xue, LS Chen. Study on milk-clotting mechanism of rennet-like enzyme from glutinous rice wine: Proteolytic property and the cleavage site on kappa-casein. *J Dairy Sci* 90: 3126–3133, 2007.
245. JA Gómez-Ruiz, G Tabora, L Amigo, I Recio, M Ramos, E Molina. Sensory and mass spectrometric analysis of the peptidic fraction lower than one thousand Daltons in Manchego cheese. *J Dairy Sci* 90: 4966–4973, 2007.
246. D Weber, P Raymond, S Bne-Rejeb, B Lau. Development of a liquid chromatography–tandem mass spectrometry method using capillary liquid chromatography and nanoelectrospray ionization–quadrupole time-of-flight hybrid mass spectrometer for the detection of milk allergens. *J Agric Food Chem* 54: 1604–1610, 2006.
247. M Zeece, T Huppertz, A Kelly. Effect of high-pressure treatment on in-vitro digestibility of  $\beta$ -lactoglobulin. *Innov Food Sci Emerg Technol* 9: 62–69, 2008.
248. TK Dalsgaard, JH Nielsen, LB Larsen. Proteolysis of milk proteins lactosylated in model systems. *Mol Nutr Food Res* 51: 404–414, 2007.
249. A Vanhooren, D De Vriendt, B Devreese, A Chedad, A Sterling, H Van Dael, J Van Beeumen, I Hanssens. Selectivity of tryptophan residues in mediating photolysis of disulfide bridges in goat  $\alpha$ -lactalbumin. *Biochemistry* 45: 2085–2093, 2006.

250. RM Vilela, LC Lands, HM Chan, B Azadi, S Kubow. High hydrostatic pressure enhances whey protein digestibility to generate whey peptides that improve glutathione status in CFTR-deficient lung epithelial cells. *Mol Nutr Food Res* 50: 1013–1029, 2006.
251. Z Wehbi, MD Pérez, M Dalgarrondo, L Sánchez, M Calvo, JM Chobert, T Haertlé. Study of ethanol-induced conformational changes of holo and apo  $\alpha$ -lactalbumin by spectroscopy and limited proteolysis. *Mol Nutr Food Res* 50: 34–43, 2006.
252. CEH Schmelzer, R Schops, R Ulbrich-Hofmann, RHH Neubert, K Raith. Mass spectrometric characterization of peptides by peptic cleavage of bovine beta-casein. *J Chromatogr A* 1055: 87–92, 2004.
253. E Soeryapranata, JR Powers, G Unlu. Degradation of  $\alpha$ -CN f1–23 by aminopeptidase N and endopeptidases E, O, O<sub>2</sub> and O<sub>3</sub> of *Lactobacillus helveticus* WSU19 under cheese ripening conditions. *Int Dairy J* 18: 178–186, 2008.
254. E Soeryapranata, JR Powers, G Unlu. Cloning and characterization of debittering peptidases, PepE, PepO, PepO<sub>2</sub>, PepO<sub>3</sub>, and PepN, of *Lactobacillus helveticus* WSU19. *Int Dairy J* 17: 1096–1106, 2007.
255. N Creusot, H Gruppen. Hydrolysis of whey protein isolate with *Bacillus licheniformis* protease: Fractionation and identification of aggregating peptides. *J Agric Food Chem* 55: 9241–9250, 2007.
256. N Creusot, H Gruppen. Protein–peptide interactions in mixtures of whey peptides and whey proteins. *J Agric Food Chem* 55: 2474–2481, 2007.
257. T Considine, A Healy, AL Kelly, PLH McSweeney. Hydrolysis of bovine caseins by cathepsin B, a cysteine proteinase indigenous to milk. *Int Dairy J* 14: 117–124, 2004.
258. J Otte, R Ipsen, AM Ladefoged, J Sorensen. Protease-induced aggregation of bovine alpha-lactalbumin: Identification of the primary associating fragment. *J Dairy Res* 71: 88–96, 2004.
259. TK Dalsgaard, JH Nielsen, LB Larsen. Characterization of reaction products formed in a model reaction between pentanal and lysine-containing oligopeptides. *J Agric Food Chem* 54: 6367–6373, 2006.
260. A Wedholm, HS Moller, H Lindmark-Mansson, MD Rasmussen, A Andren, LD Larsen. Identification of peptides in milk as a result of proteolysis at different levels of somatic cell counts using LC MALDI MS/MS detection. *J Dairy Res* 75: 76–83, 2008.
261. A Napoli, D Aiello, L Di Donna, H Prendushi, G Sindona. Exploitation of endogenous protease activity in raw mastitic milk by MALDI-TOF/TOF. *Anal Chem* 79: 5941–5948, 2007.
262. P Ferranti, MV Traisci, G Picariello, A Nasi, V Boschi, M Siervo, C Falconi, L Chianese, F Addeo. Casein proteolysis in human milk: Tracing the formation of potential bioactive peptides. *J Dairy Res* 71: 74–87, 2004.
263. C Tamvakopoulos. Mass spectrometry for the quantification of bioactive peptides in biological fluids. *Mass Spectrom Rev* 26: 389–402, 2007.
264. H John. Liquid chromatography–mass spectrometry in peptide drug discovery and development. *Anal Bioanal Chem* 381: 51–53, 2005.
265. J Harald, M Walden, S Schäfer, S Genz, WG Forssmann. Analytical procedures for quantification of peptides in pharmaceutical research by liquid chromatography–mass spectrometry. *Anal Bioanal Chem* 378: 883–897, 2004.
266. S Mizuno, K Matsuura, T Gotou, S Nishimura, O Kajimoto, M Yabune, Y Kajimoto, N Yamamoto. Antihypertensive effect of casein hydrolysate in a placebo-controlled study in subjects with high-normal blood pressure and mild hypertension. *Br J Nutr* 94: 84–91, 2005.
267. JM Curtis, D Dennis, DS Waddell, T MacGillivray, HS Ewart. Determination of angiotensin-converting enzyme inhibitory peptide Leu-Lys-Pro-Asn-Met (LKP<sub>1</sub>PM) in bonito muscle hydrolysates by LC–MS/MS. *J Agric Food Chem* 50: 3919–3925, 2002.
268. CJ Van Platerink, H-GM Janssen, R Horsten, J Haverkamp. Quantification of ACE inhibiting peptides in human plasma using high performance liquid chromatography–mass spectrometry. *J Chromatogr B* 830: 151–157, 2006.

269. A Quirós, M Ramos, B Muguerza, MA Delgado, PJ Martín-Alvarez, A Aleixandre, I Recio. Determination of antihypertensive peptide LHLPLP in fermented milk by HPLC–MS/MS. *J Dairy Sci* 89: 4527–4535, 2006.
270. A Quirós, A Dávalos, MA Lasunción, M Ramos, I Recio. Bioavailability of the antihypertensive peptide LHLPLP. Transepithelial flux of HLPLP. *Int Dairy J* 18: 279–286, 2008.
271. A Geerlings, IC Villar, F Hidalgo Zarco, M Sánchez, R Vera, A Zafra Gómez. Identification and characterization of novel angiotensin-converting enzyme inhibitors obtained from goat milk. *J Dairy Sci* 89: 3326–3335, 2006.
272. K Matsuura, S Mizuno, S Nishimura, T Gotou, N Yamamoto. Quantitative analysis of the antihypertensive peptides Val-Pro-Pro and Ile-Pro-Pro in casein hydrolysate using an *Aspergillus oryzae* protease: An LC–MS method. *Milchwissenschaft* 60: 24–27, 2005.
273. U Bütikofer, J Meyer, R Sieber, D Wechsler. Quantification of the angiotensin-converting enzyme-inhibiting tripeptides Val-Pro-Pro and Ile-Pro-Pro in hard, semi-hard and soft cheeses. *Int Dairy J* 17: 968–975, 2007.
274. D Mollé, J Leonil. Quantitative determination of bovine  $\kappa$ -casein macropeptide in dairy products by liquid chromatography/electrospray coupled to mass spectrometry (LC-ESI/MS) and liquid chromatography/electrospray coupled to tandem mass spectrometry (LC-ESI/MS/MS). *Int Dairy J* 15: 419–428, 2005.
275. H Kuwata, T-T Yip, CL Yip, M Tomita, W Hutchens. Bactericidal domain of Lactoferrin: Detection, quantitation, and characterization of lactoferricin in serum by SELDI affinity mass spectrometry. *Biochem Biophys Res Commun* 245: 764–773, 1998.





# Chapter 4

---

## Milk Proteins

---

Jerzy Dziuba, Piotr Minkiewicz, Małgorzata Darewicz,  
and Bartłomiej Dziuba

### CONTENTS

4.1	Introduction.....	80
4.2	Molecular Properties of Caseins.....	80
4.3	Molecular Properties of Whey Proteins.....	86
4.4	Functional Properties of Milk Proteins .....	88
4.5	Changes in the Structure and Properties of Milk Proteins during Processing and Storage .....	90
4.6	Characteristics of Major Bovine Milk Proteins Using HPLC Online with UV Spectroscopy.....	92
4.6.1	Derivative UV Spectroscopy—General Characteristics of the Method.....	92
4.6.2	Prefractionation of Milk Proteins .....	92
4.6.3	High-Performance Liquid Chromatography—Application to Milk Protein Analysis.....	93
4.6.4	Strategies of Protein Identification Based on the Derivatives of UV Spectra.....	93
4.6.4.1	Identification Based on the Parameters Characterizing the Shape of the UV-Spectrum Derivatives.....	93
4.6.4.2	Identification via the Libraries of UV-Spectrum Derivatives .....	95
4.6.5	Example of the Application of HPLC Online with UV Spectroscopy.....	96
4.7	Electrophoretic Methods for Milk Protein Analysis .....	98
4.7.1	One-Dimensional Polyacrylamide Gel Electrophoresis.....	98
4.7.2	Two-Dimensional Electrophoresis.....	99
4.7.3	Capillary Electrophoresis.....	99

4.8 Other Methods.....	100
Acknowledgment.....	100
References.....	100

## 4.1 Introduction

In the living world, many protein systems are formed through the association of monomeric subunits. Such associated molecules have a fixed structure and comprise several identical or different subunits. Milk possesses a protein system constituted by two major families of proteins: caseins (insoluble) and whey proteins (soluble). Whey proteins are globular molecules with a substantial content of  $\alpha$ -helix motifs, in which acidic/basic and hydrophobic/hydrophilic amino acids are distributed in a fairly balanced way along their polypeptide chains [1]. When compared with the conventional globular proteins such as whey, caseins have a unique structure [2]. The characteristic feature of caseins is their amphiphilicity. This special trait is observed in the structure of the principal caseins that comprise fragments of protein molecules possessing both hydrophilic and hydrophobic properties. In milk, caseins occur mostly in the form of porous, spherical, and large-sized molecules referred to as casein micelles. Micellar casein differs from many other protein systems with respect to at least two aspects. First, although micelles are large and have a fixed structure, they are characterized by significant variability. The smallest micelles with a diameter of around 25 nm have approximately 450 monomeric subunits, while the largest micelles with a diameter greater than 150 nm may contain more than 10,000 monomeric subunits [3]. Second, even such a large number of monomeric subunits aggregate in an orderly manner, forming micelles from the four main, nonidentical monomeric subunits— $\alpha_{s1}$ ,  $\alpha_{s2}$ ,  $\beta$ , and  $\kappa$ -caseins.

The properties of micellar casein and whey proteins largely determine the behavior of milk during processing, such as pasteurization, sterilization, condensation, or curdling during cheese production. All of these behavior patterns relate to the structure of the milk proteins and to the possible changes in its structure during processing. Therefore, an understanding of the structure of milk proteins and the changes it undergoes under processing conditions is important for the dairy-processing industry and food analyses.

This chapter presents information on the terminology, structure, and properties of milk proteins, their chromatographic and spectral characteristics, and the resulting strategies for the determination and identification of milk proteins.

## 4.2 Molecular Properties of Caseins

Milk caseins of the genus *Bos* were originally defined by the American Dairy Science Association Committee on the Nomenclature, Classification, and Methodology of Milk Proteins [4] as the phosphoproteins that precipitate from raw skimmed milk by acidification to pH 4.6 at 20°C. The Committee differentiated caseins according to their relative electrophoretic mobility in alkaline polyacrylamide or starch gels containing urea with or without mercaptoethanol. Based on electrophoretic separation and an evaluation of amino acid sequence homology, caseins have been classified into the following families:  $\alpha_{s1}$ ,  $\alpha_{s2}$ ,  $\beta$ , and  $\kappa$ -caseins.

The  $\alpha_{s1}$ -CN family, whose constituents make up to 40% of all casein fractions in bovine milk, comprises one primary and one secondary component. Both the proteins are made of single polypeptide chains with the same amino acid sequence, but with different degrees of phosphorylation [5–7]. This secondary component contains the ninth, additional phosphoserine residue 41 [8–10]. The reference protein for this family is  $\alpha_{s1}$ -CN B-8P, whose polypeptide chain contains 199 amino

MKLLILTCLVAVALARPKHPIKHQGLPQEVLNENLLRFFVAPFPEVFGKEKVNELSKD  
 IGSESTEDQAMEDIKQMEAESISSSEEIVPNSVSEQKHIQKEDVPSERYLGYLEQLRLK  
 KYKVPQLEIVPNSAEERLHSMKEGIHAQQKEPMIGVNQELAYFYPELFRQFYQLDAY  
 PSGAWYYVPLGTQYTDAPSFSDIPNPIGSENSEKTTMPLW

**Figure 4.1** Amino acid sequence of  $\alpha_{s1}$ -casein B (entry name and accession number in Swiss Prot database—<http://www.expasy.org> are CASA1\_BOVIN and P02662, respectively; BIOPEP—<http://www.uwm.edu.pl/biochemia> ID 1087). Amino acid sequence is given according to Mercier et al. [6]. Signal peptide (residues 1–15) is underlined. Mature protein contains residues 16–214 (199 residues). Phosphorylation sites according to Mercier [7], Bai et al. [9], and Imanishi et al. [10], are indicated as bold.

acid residues. The primary structure of this genetic variant is presented in Figure 4.1. Till date, seven genetic variants have been identified:  $\alpha_{s1}$ -CN, A, B, C, D, E, F, G, and H [5,6,8,11–14]. The differences between those genetic variants result from the deletion or the genetically controlled substitution of the amino acids (Table 4.1).

The secondary structure of  $\alpha_{s1}$ -CN has been examined by various methods, including CD spectroscopy, Raman spectroscopy, and predictive algorithms, using sequence information [2]. However, the three-dimensional (3D) structure of  $\alpha_{s1}$ -CN cannot be determined, because the protein does not form crystals. Nevertheless, its tertiary structure has been predicted using a combination of predicted secondary structures, adjusted to conform to the amount of global secondary structures determined experimentally, with molecular-modeling computations based on energy minimization [15]. The model of  $\alpha_{s1}$ -CN can be imagined as “a knight ready to deliver a blow.” “The sword” is formed by the N-terminal region (amino acid residues 26–89). An analysis of the shape of this molecule shows that the hydrophobic N-terminal region is separated from the highly hydrophobic C-terminal region by a hydrophilic region containing seven out of eight phosphate residues attached to the serine residues. The molecule of  $\alpha_{s1}$ -CN displays a strong tendency of self-association. The degree of association is dependent on the ionic strength: tetramers are formed below 0.1 M salt concentration, octamers are formed in the range of 0.1–0.4 M, and  $\alpha_{s1}$ -CN loses its solubility (is salted out) at an ionic strength higher than 0.5 M.

The  $\alpha_{s2}$ -CN family represents a more disparate group than the  $\alpha_{s1}$ -CN family. Its components account for up to 10% of all the casein fractions in bovine milk, and are represented by two major and several minor components [16–19]. The reference protein for the  $\alpha_{s2}$ -CN family is  $\alpha_{s2}$ -CN A-11P, a single-chain polypeptide with an internal disulfide bond. It consists of 207 amino acid residues. The primary structure of  $\alpha_{s2}$ -CN A is shown in Figure 4.2. Four genetic variants of  $\alpha_{s2}$ -CN are known, A, B, C, and D (Table 4.1).

The  $\alpha_{s2}$ -CN is the most hydrophilic of all the caseins owing to the presence of three clusters of anionic groups composed of phosphoserine and glutamyl residues. The primary structure of this casein (Figure 4.2) can be represented by four domains: an N-terminal hydrophilic domain with anionic clusters, a central hydrophobic domain followed by another hydrophilic domain with anionic clusters, and finally, a C-terminal positively charged hydrophobic domain [2]. This structure is related to the ionic strength [4]. The association appears to be strongest around an ionic strength of 0.2 M, with dissociation occurring at lower and higher salt concentrations. The number of anionic clusters and the hydrophilic nature are reflected in the calcium-binding properties of  $\alpha_{s2}$ -CN. This protein is more sensitive to  $\text{Ca}^{2+}$  than  $\alpha_{s1}$ -CN, and precipitates in the presence of 2 mM  $\text{Ca}^{2+}$ , while  $\alpha_{s1}$ -CN precipitates in the presence of 6 mM  $\text{Ca}^{2+}$ .

**Table 4.1 Differences in the Amino Acids Sequences in the Genetic Variants of Milk Proteins**

Position of Amino Acids in Protein	Genetic Variant										Refs.	
	A	B	C	D	E	F	G	H				
$\alpha_{s1}$ -CN (199)												[4-6,10-14]
14-26	-	+	+	+	+t	+	+	+				
53	Ala	Ala	Ala	ThrP	Ala	Ala	Ala	Ala				
51-58	+	+	+	+	+	+	+	-				
59	Gln	Gln	Gln	Gln	Lys	Gln	Gln	Gln				
66	SerP	SerP	SerP	SerP	SerP	Leu	SerP	SerP				
192	Glu	Glu	Gly	Glu	Gly	Glu	Glu	Glu				
$\alpha_{s2}$ -CN (207)	A	B*	C	D								[16-19]
33	Glu		Gly	Glu								
47	Ala		Thr	Ala								
51-59	+		+	-								
130	Thr		Ile	Thr								
$\beta$ -CN (209)	A <sup>1</sup>	A <sup>2</sup>	A <sup>3</sup>	B	C	D	E	F	G	H <sup>1</sup>	H <sup>2</sup>	I
18	SerP	SerP	SerP	SerP	SerP	Lys	SerP	SerP	SerP	SerP	SerP	SerP
25	Arg	Arg	Arg	Arg	Arg	Arg	Arg	Arg	Arg	Cys	Arg	Arg

35	SerP	SerP	SerP	Ser	SerP	SerP	SerP	SerP	SerP	SerP	SerP	SerP	SerP	SerP	SerP	SerP	SerP	
36	Glu	Glu	Glu	Glu	Glu	Glu	Lys	Glu	Glu	Glu	Glu	Glu	Glu	Glu	Glu	Glu	Glu	
37	Glu	Glu	Glu	Lys	Glu	Glu	Glu	Lys	Glu	Glu	Glu	Glu	Glu	Glu	Glu	Glu	Glu	
67	His	Pro	Pro	His	Pro	Pro	Pro	His	Pro	His	His	His	Pro	Pro	Pro	Pro	Pro	
72	Gln	Gln	Gln	Gln	Gln	Gln	Gln	Gln	Gln	Gln	Gln	Gln	Gln	Gln	Gln	Gln	Gln	
88	Leu	Leu	Leu	Leu	Leu	Leu	Leu	Leu	Leu	Leu	Leu	Leu	Leu	Leu	Leu	Leu	Leu	
93	Met	Met	Met	Met	Met	Met	Met	Met	Met	Met	Met	Met	Met	Met	Met	Met	Met	
106	Gln	His	His	His	His	His	His	His	His	His	His	His	His	His	His	His	His	
122	Ser	Ser	Ser	Ser	Ser	Ser	Ser	Ser	Ser	Ser	Ser	Ser	Ser	Ser	Ser	Ser	Ser	
137/138	Leu/Pro	Leu/Pro	Leu/Pro	Leu/Pro	Leu/Pro	Leu/Pro	Leu/Pro	Leu/Pro	Leu/Pro	Leu/Pro	Leu/Pro	Leu/Pro	Leu/Pro	Leu/Pro	Leu/Pro	Leu/Pro	Leu/Pro	
152	Pro	Pro	Pro	Pro	Pro	Pro	Pro	Pro	Pro	Pro	Pro	Pro	Pro	Pro	Pro	Pro	Pro	
κ-CN (169)	A	B	C	E	F <sup>1</sup>	F <sup>2</sup>	G <sup>1</sup>	G <sup>2</sup>	H	I	J							[10,29,31, 156–159]
10	Arg	Arg	Arg	Arg	Arg	His	Arg	Arg	Arg	Arg	Arg	Arg	Arg	Arg	Arg	Arg	Arg	
97	Arg	Arg	His	Arg	Arg	Arg	Cys	Arg	Arg	Arg	Arg	Arg	Arg	Arg	Arg	Arg	Arg	
104	Ser	Ser	Ser	Ser	Ser	Ser	Ser	Ser	Ser	Ser	Ser	Ser	Ser	Ser	Ser	Ser	Ser	
136	Thr	Ile	Thr	Thr	Thr	Ile	Ile	Thr	Ile	Thr	Thr	Thr	Thr	Thr	Thr	Thr	Ile	
148	Asp	Ala	Asp	Asp	Val	Ala	Ala	Ala	Ala	Ala	Ala	Ala	Ala	Ala	Ala	Ala	Ala	
155	Ser	Ser	Gly	Ser	Ser	Ser	Ser	Ser	Ser	Ser	Ser	Ser	Ser	Ser	Ser	Ser	Ser	
β-LG (162)	A	B	C	D	E	F	G	H	I	J								[38,40,41]

(continued)

**Table 4.1 (continued) Differences in the Amino Acids Sequences in the Genetic Variants of Milk Proteins**

Position of Amino Acids in Protein	Genetic Variant													Refs.
	Glu	Glu	Gln	Glu	Glu	Glu	Glu	Glu	Pro	Ile	Gln	Gly	Glu	
45	Glu	Pro	Ile	Gln	Gly	Lys	Ile	Glu	Pro	Ile	Gln	Gly	Glu	Glu
50	Pro	Ile	Gln	His	Gly	Lys	Ile	Glu	Pro	Ile	Gln	Gly	Pro	Pro
56	Ile	Gln	Asp	Lys	Ile	Gln	His	Gly	Lys	Ile	Gln	Gly	Pro	Leu
59	Gln	Asp	Lys	Ile	Gln	His	Gly	Lys	Ile	Gln	Gln	Gly	Pro	Gln
64	Asp	Lys	Ile	Gln	His	Gly	Lys	Ile	Glu	Pro	Ile	Gln	Gly	Gly
70	Lys	Ile	Gln	His	Gly	Lys	Ile	Glu	Pro	Ile	Gln	Gly	Lys	Lys
78	Ile	Gln	Asp	Lys	Ile	Gln	His	Gly	Lys	Ile	Gln	Gly	Pro	Ile
108	Glu	Pro	Ile	Gln	His	Gly	Lys	Ile	Glu	Pro	Ile	Gln	Gly	Glu
118	Val	Pro	Ile	Gln	His	Gly	Lys	Ile	Glu	Pro	Ile	Gln	Gly	Glu
126	Pro	Ile	Gln	His	Gly	Lys	Ile	Glu	Pro	Ile	Gln	Gly	Pro	Ala
129	Asp	Ile	Gln	His	Gly	Lys	Ile	Glu	Pro	Ile	Gln	Gly	Pro	Ala
158	Asp	Ile	Gln	His	Gly	Lys	Ile	Glu	Pro	Ile	Gln	Gly	Pro	Ala
α-LA (123)	A	B	C											
10	Gln	Arg	Arg											

\* Sequence not determined; -, absent; +, present.

[1,45,160]

MKFFIFTCLLAVALAKNTMEHVSSSEESIISQETYKQEKMAINPSKENLCSTFCKEVV  
 RNANEEEYSIGSSSESAEVATEEVKITVDDKHYYQKALNEINQFYQKFPQYLYQYQ  
 PIVLNPWDQVKRNAVPITPTLNREQLSTSEENSKKTVDMESTEVFTKTKLTEEEKNR  
 LNFLKKISQRYQKQFALPQYLYKTVYQHQAAMKWPQPKTKVIPYVRYL

**Figure 4.2** Amino acid sequence of  $\alpha_{s2}$ -casein A (entry name and accession number in Swiss Prot database—<http://www.expasy.org> are CASA2\_BOVIN and P02663, respectively; BIOPEP—<http://www.uwm.edu.pl/biochemia> ID 1090). Amino acid sequence is given according to Bri-gnon et al. [17]. Signal peptide (residues 1–15) is underlined. Mature protein contains residues 16–222 (207 residues). Phosphorylation sites, according to Mercier [7], Bai et al. [9], and Imani-shi et al. [10], are indicated as bold.

The  $\beta$ -CN family, which constitutes up to 45% of the caseins of bovine milk, is completely complex because of the action of the native milk protease, plasmin [8]. Plasmin cleavage leads to the formation of  $\gamma_1$ -,  $\gamma_2$ -, and  $\gamma_3$ -CN, which are actually fragments of  $\beta$ -CN consisting of residues 29–209, 106–209, and 108–209 in mature protein. In addition, polypeptides previously called proteose-peptone components 5, 8-fast, and 8-slow, are fragments of  $\beta$ -CN, which represent residues 1–105 or 1–107, 1–28, and 29–105, respectively. The reference protein for this family is  $\beta$ -CN A<sup>2</sup>-5P. A single polypeptide chain of this protein contains 209 amino acid residues that are not inclusive of the cysteine residues. The  $\beta$ -CN, variant A<sup>2</sup> amino acid sequence is presented in Figure 4.3 [20,21]. To date, 12 genetic variants [8,22–27] have been identified:  $\beta$ -CN, A<sup>1</sup>, A<sup>2</sup>, A<sup>3</sup>, B, C, D, E, F, G, H<sup>1</sup>, H<sup>2</sup>, and I (Table 4.1).

The  $\beta$ -CN is the most hydrophobic of the investigated caseins. The molecule of  $\beta$ -CN presents a high contrast in its sequence; one-tenth of the amino acids at the N-terminus of the protein contain one-third of the total charge, while one-tenth of 75% of the residues at the C-terminus constitute the hydrophobic amino acids. The  $\beta$ -CN molecule model has a crab-like structure with two large, twisted hydrophilic arms [28]. Although  $\beta$ -casein seems to have a more cohesive structure than  $\kappa$ -casein, it is asymmetrical. The molecule's shape can be generally described as an ellipsoid with a 2:1 axis ratio. One terminus (C-terminal end) comprises a strongly hydrophobic domain, while the other (N-terminal end) is strongly hydrophilic. In isolated systems,  $\beta$ -casein aggregates, forming “micelles” at a degree of association = 20 (five connected tetramers) at room temperature.

MKVLLIACLVALALARELEELNVPGEIVESLSSSEESITRINKKIEKFQSEEQQQTEDEL  
 QDKIHPEAQTQSLVYFPFGPIPNSLPQNIPPLTQTPVVVPPFLQPEVMGVSKVKEAMAP  
 KHKEMFPFKYPVEPFTESQSLTLTDVENLHLPLLLQSWMHQPHQPLPPTVMFPQSV  
 LLSQSKVLVPPQKAVPYPQRDMPIQAFLLYQEPVLGPVVRGPFPIIV

**Figure 4.3** Amino acid sequence of  $\beta$ -casein A<sup>2</sup> (Entry name and accession number in Swiss Prot database—<http://www.expasy.org> are CASB\_BOVIN and P02666, respectively; BIOPEP—<http://www.uwm.edu.pl/biochemia> ID 1098). Amino acid sequence is given according to Gros-claude et al. [30]. Signal peptide (residues 1–15) is underlined. Mature protein contains residues 16–222 (207 residues). Phosphorylation sites, according to Mercier [7], Wu et al. [27], and Imanishi et al. [10], are indicated as bold.



MMKSEFLVVTILALTLPLFLGAQEQNQEQPIRCEKDERFFSDKIAYIPIQYVLSRYPY  
 GLNYYQKQKPVALINNQFLPYPYAKPAAVRSPAQLQWQVLSNTVPAKSCQAQPTT  
 MARHHPHLSFMAIPPKKNQDKTEIPTINTIASGEPTSTPTTEAVESTVATLESPEVIE  
 SPPEINTVQVTST

**Figure 4.4** Amino acid sequence of  $\kappa$ -casein A (entry name and accession number in Swiss Prot database—<http://www.expasy.org> are CASK\_BOVIN and P02668, respectively; BIOPEP—<http://www.uwm.edu.pl/biochemia> ID 1117). Amino acid sequence is given according to Grosclaude et al. [30] and Mercier et al. [31]. Signal peptide (residues 1–21) is underlined. Mature protein contains residues 22–190 (169 residues). Phosphorylation sites, according to Mercier [7], are indicated as bold. Glycosylation sites, according to Kanamori et al. [33] and Pisano et al. [34], are bold and underlined.

The  $\kappa$ -CN family consists of a major carbohydrate-free component and a minimum of six minor components. The six minor components represent varying degrees of phosphorylation and glycosylation [4]. Its components account for up to 15% of all the casein fractions in the bovine milk.

The primary structure of the reference protein of the  $\kappa$ -CN family is the major carbohydrate-free component of  $\kappa$ -CN A-1P [29–31]. Figure 4.4 presents the sequence of the genetic variant,  $\kappa$ -CN A. The mature protein consists of 169 amino acid residues, with a formula molecular weight of 19.037 kDa. The  $\kappa$ -CN is the only casein that is soluble in the presence of calcium ions. The susceptibility of various caseins to precipitation in the presence of calcium ions increases with the number of phosphate residues. The  $\kappa$ -CN contains one phosphate residue, which explains its solubility in the presence of calcium ions. Furthermore,  $\kappa$ -CN molecules may associate with  $\alpha_{s1}$ -,  $\alpha_{s2}$ -, and  $\beta$ -CN molecules, protecting them from precipitation in the presence of calcium ions and forming permanent colloidal molecules [32].

Among all the caseins, only the minor  $\kappa$ -CN components are glycosylated [33,34]. Their saccharide residues with monosaccharide, disaccharide, trisaccharide, and tetrasaccharide structure are formed as a result of posttranslational glycosylation, and may contain *N*-acetyl neuraminic acid (NeuAc), galactose (Gal), and *N*-acetyl galactosamine (GalNAc). Trisaccharides and tetrasaccharides are the dominant oligomeric forms [35]. The saccharide residues are connected to the polypeptide chain mainly by Thr 133 as well as Thr 131 and 133.

A 3D model of  $\kappa$ -casein can be imagined as a “horse with a rider” [36]. The N-terminal region represents the horse and the C-terminal region represents the rider. Long, distinct legs are located in the “horse region” of the molecule model. During the action of chymosin (EC 3.4.23.4), the “rider region” is released. This part of the protein molecule, named macropeptide (residues 106–169), contains glycosidic threonine residues and phosphorylated residues of serine and/or threonine. The  $\kappa$ -casein contains cysteine residues (in the “horse region”) that can form intra- and intermolecular disulfide bonds [37]. The isolated  $\kappa$ -casein forms the dimer to octamer systems.

### 4.3 Molecular Properties of Whey Proteins

Whey proteins are a group of milk proteins that remain in the milk serum or whey after precipitation of CN at pH 4.6 and 20°C. Whey proteins account for about 20% of the total proteins contained in milk. These are globular molecules with a substantial content of  $\alpha$ -helix motifs, in which acidic/basic and hydrophobic/hydrophilic amino acids are distributed in a fairly balanced

manner along the polypeptide chains [1]. The major whey proteins are  $\beta$ -lactoglobulin ( $\beta$ -LG) and  $\alpha$ -lactalbumin ( $\alpha$ -LA). Other whey proteins are bovine serum albumin (BSA), immunoglobulins (IG), bovine lactoferrin (BLF), and lactoperoxidase (LP), together with other minor components.

The  $\beta$ -LG is the major protein in whey. This protein has several genetic variants (Table 4.1) [8,38–41], of which A and B occur very frequently in most of the cattle breeds [42]. The reference protein for the  $\beta$ -LG family,  $\beta$ -LG B, consists of 162 amino acid residues, with a molecular weight of 18,277 Da [8,43]. The primary sequence is shown in Figure 4.5. It is composed mainly of  $\beta$ -sheet motifs, and its quaternary structure depends on the medium pH. At pH values between 7 and 5.2,  $\beta$ -LG exists as a stable dimer, with a molecular weight of ca. 36,700 Da. In the environment of pH 3 and above 8,  $\beta$ -LG occurs as a monomer, and at pH values between 5.2 and 3.5, it occurs as an octamer with a molecular weight of ca. 140,000 Da [1].

The  $\alpha$ -LA is quantitatively the second most important protein in whey, and it is fully synthesized in the mammary gland. Within the Golgi apparatus of the mammary epithelial cells,  $\alpha$ -LA interacts with the ubiquitously expressed enzyme  $\beta$ -1,4-galactosyltransferase (EC 2.4.1.22), allowing the formation of lactose from glucose and uridine diphosphate (UDP)-galactose. Furthermore,  $\alpha$ -LA acts as a coenzyme for the biosynthesis of lactose [44].

Bovine milk contains  $\alpha$ -LA at a concentration of ca. 1.2–1.5 g/L [4]. Three genetic variants of this protein have already been identified—A, B, and C [1]. The B variant is the reference protein for the family, and contains 123 amino acid residues, with a molecular weight of 14.175 kDa [45]. Its sequence is presented in Figure 4.6. The native  $\alpha$ -LA consists of two domains: a large  $\alpha$ -helical domain and a small  $\beta$ -sheet domain, which are connected by a calcium-binding loop. The  $\alpha$ -helical domain is composed of three major  $\alpha$ -helices and two short  $3_{10}$  helices. The small domain is composed of a series of loops, a small three-stranded antiparallel  $\beta$ -pleated sheet, and a short  $3_{10}$  helix. Its globular structure is stabilized by four disulfide bonds, at pH values in the range of 5.4–9.0 [46].

The BSA is not synthesized in the mammary gland, but appears in the milk, following passive leakage from the blood stream. It has a principal role in the transport, metabolism, and distribution of ligands [47]. The BSA represents about 8% of the total whey proteins. A single-chain polypeptide of BSA contains 582 amino acid residues, leading to a molecular weight of 66.399 kDa. It also possesses 17 intermolecular disulfide bridges and one thiol group. Heat-induced gelation of BSA at pH 6.5 is initiated by an intermolecular thiol–disulfide interchange [48].

The IG fraction accounts for about 6% of the total whey proteins, and constitutes a complex of proteins produced by B-lymphocytes. These proteins are present in the serum and the physiological fluids of all mammals, and play an important immunological function (especially in colostrum) [1].

MKCLLLALALTCGAQALIVTQTMKGLDIQKVAGTWYSLAMAASDISLLDAQSAPLR  
VYVELKPTPEGDLEILLQKWENGECAQKKIIAEKTKIPAVFKIDALNENKVLVLDTDY  
KKYLLFCMENSAPPEQSLACQCLVRTPEVDDEALEKFDKALKALPMHIRLSFNPTQL  
EEQCHI

**Figure 4.5** Amino acid sequence of  $\beta$ -LG B (entry name and accession number in Swiss Prot database—<http://www.expasy.org> are LACB\_BOVIN and P02754, respectively; BIOPEP—<http://www.uwm.edu.pl/biochemia> ID 1116). Amino acid sequence is given according to Braunitzer et al. [43]. Signal peptide (residues 1–16) is underlined. Mature protein contains residues 17–178 (162 residues).

MMSFVSLLLVGLFHATQAEQLTKCEVFRELKDLKGYGGVSLPEWVCTTFHTSGYDT  
 QAIVQNNDSTEYGLFQINNKIWCKDDQNPSSNICNISCDKFLDDDLTDDIMCVKKIL  
 DKVGINYWLAHKALCSEKLDQWLCEKL

**Figure 4.6** Amino acid sequence of  $\alpha$ -LA B (entry name and accession number in Swiss Prot database—<http://www.expasy.org> are LALBA\_BOVIN and P00711, respectively; BIOPEP—<http://www.uwm.edu.pl/biochemia> ID 1115). Amino acid sequence is given according to Brew et al. [45]. Signal peptide (residues 1–19) is underlined. Mature protein contains residues 20–142 (123 residues).

Other minor components of whey proteins account for up to 3% of the total whey protein content, and display different types of biological activity.

## 4.4 Functional Properties of Milk Proteins

Solubility is a primary functional property of the milk proteins [49]. According to Kinsella [50], protein solubility is the physicochemical characteristic, on which other functional properties depend. Solubility determines the use of protein in food processing, providing valuable information about the method for the production of protein preparations, as well as influencing the emulsifying and foaming properties of the proteins [51,52]. Solubility is mostly dependent on the structure and properties of a solvent, temperature, and pH of the environment, as well on the presence of  $\text{Ca}^{2+}$  (or other charge ions) ions and interactions with other chemical components [51,53]. The loss in solubility because of food processing under drastic conditions is often indicative of the denaturation degree of a protein [54,55]. The results of many studies show that the enzymatic hydrolysis improves the solubility of milk proteins [56,57]. Grufferty and Fox [58] hydrolyzed micellar casein with alkaline milk proteinase, and observed an increase in the soluble nitrogen, owing to the production of peptides with a good surface activity. Abert and Kneifel [59] observed that an increase in the degree of acid casein hydrolysis resulted in an increase in the nitrogen solubility index. Furthermore, the applicability of milk proteins is observed to increase substantially, if their good solubility is preserved. This characteristic is of particular importance in acidic environments, as it makes it possible to use proteins as additives to juices and beverages without the risk of coagulation.

Solubility plays a key role in the development of emulsifying and foaming properties [49,52]. It has been found that hardly soluble proteins generally have poor emulsifying properties [60]. Caseins are an excellent emulsifier as they easily unfold at the interfaces [61]. This property results from the uniquely flexible structure of caseins, containing a few secondary structure components, and practically devoid of tertiary structure components [62–64]. Caseins are generally assumed to be “naturally denatured” proteins [65].  $\beta$ -Casein is the most effective stabilizer among the milk proteins, as it decreases the surface tension to the greatest degree [66].  $\beta$ -Casein-like proteins show good emulsifying and foaming properties, because they rapidly decrease the surface tension at the oil/air–water interface [67]. The capacity of the milk proteins to reduce the surface tension decreases in the following order:  $\beta$ -casein  $>$   $\alpha_{s1}$ - $\kappa$ - $\beta$ -LG  $>$   $\alpha$ -LA  $>$  serum albumin [60,68]. The emulsifying properties may improve on limited protein denaturation, which does not drastically decrease the solubility, but is associated with an increase in the surface hydrophobicity [69]. It has been found that an ideal foam-forming protein should have high surface

hydrophobicity, good solubility, and a low total charge at the pH value of the food product, and its polypeptide chain should relatively easily unfold [52,70]. Enzymatic hydrolysis and chemical modifications can be used to alter protein emulsifying/foaming properties [56,64,66,71,72]. The enzymatic hydrolysis of caseins partially improves the emulsifying and foaming properties [56,73]. It is possible to obtain peptides of different characteristics under conditions of  $\beta$ -casein hydrolysis by plasmin, and the separation and purification of hydrolysate fractions [63]. It was found that despite its good solubility, the hydrophilic peptide ( $\beta$ -CN 1–28) showed poor ability to decrease the surface tension and low capacity for steric interactions, which implicates its unsatisfactory emulsifying and foaming properties. A distinct separation of the hydrophobic and hydrophilic areas in the amphiphilic peptides ( $\beta$ -CN 1/28–105/107), together with good solubility and relatively high-molecular weight could be one of the reasons for their best emulsion-forming ability. Only hydrophobic peptides ( $\beta$ -CN 106/108/114–209) form stable foams. Component 3 of proteose–peptone was reported to have good-foaming properties [74]. Patel [75] hydrolyzed caseins and identified three  $\beta$ -casein peptides: 101–145, 107–145, and 107–135. The decrease in the foam-forming ability was observed at 10% DH when compared with 5% DH. Whey proteins have excellent foaming properties. The stability of the foam formed by the solution of whey proteins ( $\alpha$ -LA and  $\beta$ -LG) can increase upon the factors causing an “opening” of their globular structure and exposition of SH residues present in these proteins. Furthermore, partial denaturation of  $\beta$ -LG during homogenization can improve its foaming properties [76]. A relationship between emulsion-forming and emulsion-stabilizing properties, and the presence of secondary structure in the synthetic peptides in solution has been suggested [77,78]. Various authors [62,66,79] postulated a relationship between the contribution of amphiphilic  $\alpha$ -helix structure and the emulsifying properties of casein peptides, as well as a relationship between the surface load and the emulsion-stabilizing properties of casein fractions.

Multiple regression was applied to describe the relationships between the ability of proteins and peptides to form and stabilize foam/emulsion, and their solubility and retention time (chromatographic analysis) or spectroscopic parameters (analysis of UV spectra) [80]. An example of an equation for which the coefficients of multiple correlations were found to be statistically significant ( $p < 0.05$ ) has been presented. This equation describes the interrelation between the ability of the proteins and peptides to form foam ( $F_0^a$ ) and their solubility ( $S_0$ ) and retention time ( $t_R$ ):

$$F_0^a = 105.4843 - 0.9379 \times S_0 + 0.5216 \times t_R \quad (4.1)$$

The ability of milk proteins to form a gel is useful in milk processing [81,82]. A two-step protein gelation model was proposed: an initiation step involving the unfolding of the protein, followed by the aggregation process resulting in gel formation [83]. Milk gels are usually irreversible and are formed on enzymatic reaction, heat-induced reaction, interaction with divalent cations ( $\text{Ca}^{2+}$ ), or reactions of more complex mechanisms [76,84,85]. The effect of protein gelation depends on protein concentration, temperature, pH, ionic strength, etc. [53,86]. Generally, the higher the protein concentration, the stronger is the gel produced. For  $\beta$ -LG, the gel strength at pH 6.6 is observed to be much higher than that at pH 4 or 5, and the optimum gel strength is observed at 200 mM NaCl [87,88]. In cheese production, the first stage is to obtain casein gel owing to the integrated action of enzymes (chymosin or rennet preparations) and calcium [89]. During the storage of condensed milk or ultrahigh temperature (UHT) milk, the appearance of milk protein gel is the factor limiting the product stability [90].

## 4.5 Changes in the Structure and Properties of Milk Proteins during Processing and Storage

The changes in the protein structure occurring during milk processing can be reversible or irreversible. Only reversible changes are important for the development of the final properties of the protein product. A reversible change may turn irreversible after the introduction of other components into the protein system. Irreversible changes in the physical character in the protein structure are quite often combined with the changes in the chemical character (covalent interactions). Irreversible changes in the protein structure, as induced by a change in pH or temperature, result from the unfolding of polypeptide chains and their subsequent interaction [91].

Milk processing and the production of most dairy products require heat treatment at a certain stage [76]. As a result, thermal denaturation of the milk proteins is observed [92,93]. Among the milk proteins, whey proteins are most susceptible to thermal denaturation [92,94]. Their resistance to increased temperatures can be ordered as follows:  $\alpha$ -LA >  $\beta$ -LG > serum albumin > IG. For example, heat treatment of milk at 70°C for 30 min causes irreversible denaturation of about 90% IG, 50% serum albumin, 30%  $\beta$ -LG, and only 5%  $\alpha$ -LA. A comparison of the different types of heat treatment indicates that the amount of denatured whey proteins is 62%–68% for the indirect (membrane) UHT method (145°C, 3s), 51%–54% for the direct (nonmembrane) UHT method (142°C, 3s), 30%–36% for the HTST method (90°C, 30s), and 20%–30% for batch pasteurization (63°C, 30 min). The environmental factors, including pH, Ca<sup>2+</sup> concentration, and carbohydrate concentration, affect the thermal denaturation of whey proteins [95]. The action of these factors is different in whey than in milk. In whey, at neutral or higher pH, thiol–disulfide exchange may occur between the thiol group of  $\beta$ -LG exposed owing to chain unfolding, and disulfide groups in  $\alpha$ -LA and serum albumin [96]. Thus, large molecular weight complexes are formed. In these conditions, noncovalent interactions between unfolded polypeptide chains dominate. These interactions are so strong that large complexes are formed and the protein precipitates. In acid whey (pH < 3.7), whey proteins are resistant to the action of factors causing their aggregation [97]. This results from an increased electrostatic repulsion and the inability to induce thiol–disulfide exchange. At these pH values,  $\alpha$ -LA is the least-stable whey protein, as it occurs as an apoform, i.e., an unfolded polypeptide chain. The addition of carbohydrates, e.g., saccharose, lactose, and different monosaccharides to whey or whey-protein concentrates stabilizes the proteins against heat precipitation, primarily allowing preferential hydration of its native or modified (unfolded) structure.

It is often stated that caseins are extremely thermostable, but this only refers to their resistance to heat precipitation. In fact, the micelle structure is quite sensitive to changes in the environmental conditions that often lead to irreversible structural changes. For example, the dissociation of  $\beta$ -casein from the micelle at a low temperature is connected with a considerable increase in  $\gamma$ -casein concentration. The dissociated  $\beta$ -casein monomers are more susceptible to proteolysis by milk proteases than  $\beta$ -casein formed in the micellar structure [98–100].

The heat treatment of milk leads to the interaction of denatured whey proteins with the micelle structure [101]. The interaction occurs mainly between the unfolded  $\beta$ -LG and  $\kappa$ -casein, and probably mostly results from thiol–disulfide exchange [102], and  $\alpha$ -LA is also involved in this interaction. The heat-induced interactions between  $\kappa$ -casein,  $\beta$ -LG, and  $\alpha$ -LA in milk are of surface character [103]. This is indicated by observations of the interaction between immobilized  $\beta$ -LG and  $\kappa$ -casein on the micelle surface. This surface interaction has also been evidenced by the method for reversible immobilization and immunohistochemical location. As a result of this

interaction, the micelles turn to be more resistant to heat-induced coagulation and less susceptible to gelification during storage.

The heat treatment of milk, particularly by the UHT method, causes changes in the micelle-size distribution and a decrease in the solubility of caseins [98,100]. An increase is observed in both the size and number of large micelles and small particles (submicelles), which do not undergo sedimentation on centrifugation at a high speed ( $100,000 \times g$ ). The increase in the micelle size is caused by the surface interaction between denatured whey proteins, while small casein particles are formed owing to the dissociation of submicelles, because of the change in their interactions with calcium phosphate.

More extreme processing and storage conditions can be the reason for the important covalent changes in the protein structure. The most important changes resulting from the action of elevated temperature and/or alkaline pH include the racemization of amino acid residues, the cross-linking of polypeptide chains, and the modification of amino acid residues (mostly lysine) owing to Maillard-type reactions with carbohydrates [71,76]. The susceptibility of amino acids to racemization is dependent on the sequence of amino acids in the polypeptide chains. For milk proteins, the susceptibility of amino acids to racemization can be presented in the following decreasing order: Cys, Ser, Asp > Thr, Met, Phe > Glu, Tyr, Lys, Ala > Val, Leu, Ile, Pro [93]. Racemization leads to the formation of dehydroalanyl protein. Such a protein is formed through the  $\beta$ -elimination reaction of the disulfide group in the cysteine residues, the phosphate group in the phosphoserine residues, or the OH group in the serine residues. The reaction of cysteine residues is probably the most important in whey proteins, while the  $\beta$ -elimination of phosphoserine residues is probably the main source of dehydroalanyl residues in caseins. These residues are quite reactive and form lysinoalanyl and lanthionyl cross-links during the addition reaction of vinyl type with the  $\epsilon$ -amino group of lysine or the SH group of cysteine, respectively. It seems that the amino acid residues undergo quicker racemization in caseins than in whey proteins.

The high content of lactose and lysine residues in milk and milk proteins, respectively, is responsible for Maillard reactions [64,71,76]. Potentially, each carbonyl group, e.g., in aldehydes derived from the oxidation of unsaturated fatty acids, can react with lysine; however, lactose and lactulose are most reactive. During thermal processes, some lactose undergo the transformation into lactulose, and the degree of this transformation indicates the range of heat processing of milk. The average lactulose concentration in different dairy products is as follows: 10–51 mg/100 cm<sup>3</sup> for UHT milk, 87–137 mg/100 cm<sup>3</sup> for bottled sterilized milk, and 17 mg/100 cm<sup>3</sup> for spray-dried milk powder [104]. The presence of lactulose in formulas is thought to be beneficial, because of its stimulating effect on *Bifidobacterium bifidum* growth. Both lactulozyllysine and fructozyllysine have been identified in processed dairy products. In pasteurized milk and UHT milk, the concentration of these compounds is within the detection limits; however, their amounts can considerably increase during the storage of UHT milk. For example, 6-month storage of UHT milk decreases the amount of available lysine by 5% at 4°C and by 14% at 37°C. The loss in the amount of available lysine can reach 45% in powders stored for 4 years at 20°C.

Milk gelation causes important outcomes in the products subjected to UHT treatment [103]. Disulfide bonds contribute to the formation of  $\alpha$ -LA- $\beta$ -LG- $\kappa$ -casein complexes in the casein micelles [96,103], while the sulfhydryl groups play an important role in heat-induced reactions:  $\kappa$ -casein-denatured whey proteins. The formation of milk-protein gel is dependent on the number of available sulfhydryl groups. Heating of skim milk below 70°C does not change the amount of available sulfhydryl groups, while heating at 80°C or above increases the availability of these groups. It has been shown that two types of whey proteins–casein aggregates are formed during

heating. The first one is formed owing to disulfide bonds and the second is the conglomerate of the aggregates linked together via calcium bridges.

## **4.6 Characteristics of Major Bovine Milk Proteins Using HPLC Online with UV Spectroscopy**

### **4.6.1 Derivative UV Spectroscopy—General Characteristics of the Method**

Derivative spectroscopy has been designed to overcome the problem of high similarity of zero-order UV–Vis spectra. This method is applied for the qualitative and quantitative analysis of many groups of chemical compounds containing chromophores, i.e., groups containing conjugated double bonds [105–107]. Early applications of the derivative spectroscopy included investigations into the structural changes of the proteins. During the last 25 years, derivative spectroscopy has been applied online with high-performance liquid chromatography (HPLC) as a tool for the identification of separated substances [108]. The spectra obtained using diode-array detectors (DADs) have been processed numerically to calculate derivatives. To date, the second derivative of the spectra has been most commonly used for the identification of proteins and peptides.

The calculation of spectrum derivatives enhances the resolution and thus the possibility of discrimination between compounds if zero-order spectra are too similar to each other. In the case of peak purity estimation, derivative spectra allow one to overcome two major problems pointed out by Papadoyannis and Gika [109]: high similarity of the spectra of main component, and impurity content too low to be detectable using zero-order spectra.

However, the application of the derivatives of UV–Vis spectra may pose certain problems. The shape of the derivative of a spectrum may strongly depend on the program and computational procedure [107,108,110]. For instance, it is a well-known fact that the second derivatives of the UV spectra of proteins have a minimum at a wavelength of  $283 \pm 2$  nm, corresponding to tyrosine absorbance [108,111–113], although there are published results of the identification of milk proteins based on the second spectra derivatives having no minimum at this wavelength [114]. Owing to this fact, it is recommended either to compare the derivatives of the spectra obtained under the same conditions and with the use of the same program and calculation procedure, or to make sure that the changes in the protocol are not reflected in the changes in the spectra [108].

### **4.6.2 Prefractionation of Milk Proteins**

Caseins are the milk-protein fractions that precipitate at pH 4.6 [4]. Precipitation by adjusting the pH to isoelectric point is a commonly used method for the isolation of this milk protein fraction. The following sequence may be recommended to avoid coprecipitation of caseins with major whey proteins: pH adjustment to the value of 4.6, equilibration taking 2 h, centrifugation, dissolving by pH adjustment to 6.6, repeated precipitation at pH 4.6, equilibration, and centrifugation [115]. Ammonium acetate may be used for buffer preparation, as this salt is volatile and may be almost completely removed during lyophilization of the protein sample. Isoelectric casein obtained using such protocol does not contain whey proteins unless they are covalently bound, e.g., owing to milk heating, but it may contain polypeptides originating from plasmin action [115]. Such casein may be not pure enough to be subjected to analysis using the most-sensitive methods, such as mass

spectrometry or nuclear magnetic resonance. Reversed-phase HPLC (RP-HPLC) appears to be the most-efficient method for further purification and fractionation of caseins. Samples of caseins for RP-HPLC may be dissolved in the presence of urea [116].

Whey proteins can be precipitated using ethanol via the protocols designed for the isolation of peptide fraction from cheese [117,118]. Ethanol is not as toxic as trichloroacetic acid (TCA) or phosphotungstic acid (PTA) used previously for this purpose. In contrast to these two compounds, ethanol may be removed from the solutions by evaporation in vacuo prior to lyophilization. The use of 70% ethanol allows complete recovery of  $\alpha$ -LA and  $\beta$ -LG from the supernatant after isoelectric precipitation of caseins. The resulting solution may contain peptides and other low-molecular weight compounds [117,118].

### 4.6.3 High-Performance Liquid Chromatography—Application to Milk Protein Analysis

The RP-HPLC utilizing solvents containing acetonitrile, water, and trifluoroacetic acid is now the most commonly used method of milk protein separation for analytical purposes. The order of major bovine milk proteins is as follows:  $\kappa$ -casein,  $\alpha_{s2}$ -casein,  $\alpha_{s1}$ -casein,  $\beta$ -casein,  $\alpha$ -LA, and  $\beta$ -LG [111,114,116,119]. The RP-HPLC allows the separation of the genetic variants of milk proteins [116] as well as their quantitative analysis [114]. The possibility of separating individual proteins depends on the sample preparation protocol. For instance, caseins should be reduced prior to separation, owing to the fact that  $\kappa$ - and  $\alpha_{s2}$ -fractions form oligomers with different retention times. On the other hand,  $\alpha$ -LA and  $\beta$ -LG in samples, which do not contain caseins, are better separated without reduction.

### 4.6.4 Strategies of Protein Identification Based on the Derivatives of UV Spectra

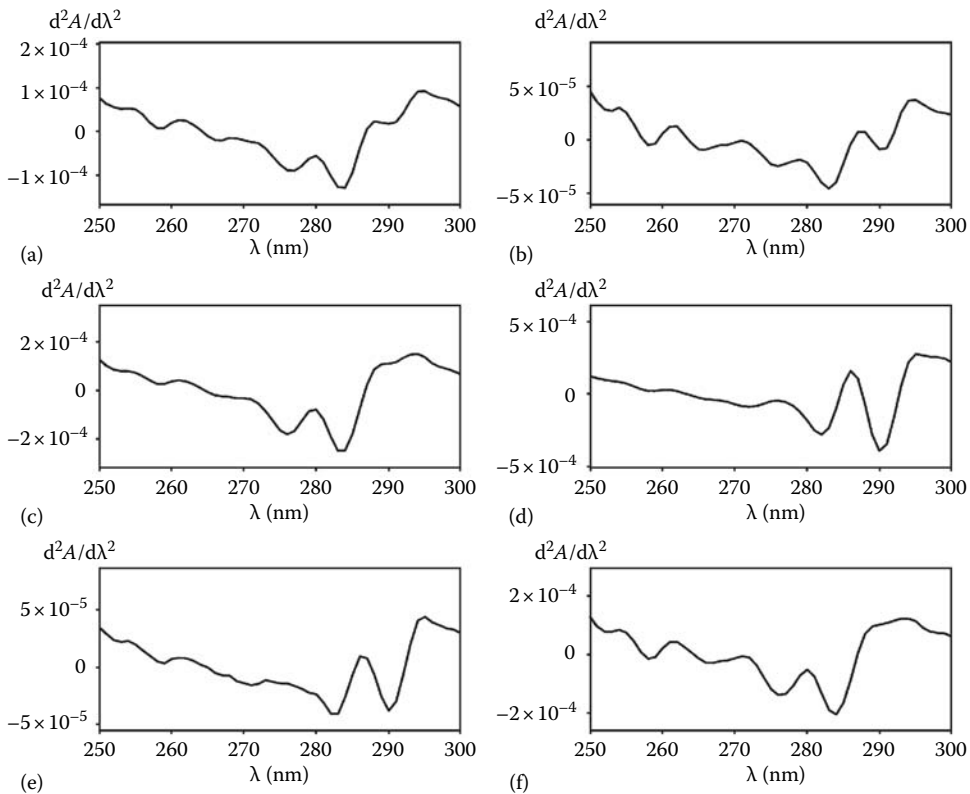
#### 4.6.4.1 Identification Based on the Parameters Characterizing the Shape of the UV-Spectrum Derivatives

The parameters describing the shape of the UV-spectrum derivatives used for the identification of milk proteins are presented in Table 4.2. The second derivatives of UV spectra of major bovine milk proteins, most commonly used for the identification of milk proteins, are presented in Figure 4.7. The shape of the derivative spectra depends mainly on the molar ratio between tryptophan and tyrosine (Trp/Tyr ratio). This ratio may be calculated based on the amino acid sequence of the proteins or protein fragments, available in the protein sequence databases, such as UniProt. The ProtParam program, available through the UniProt Web site <http://www.expasy.org> [120], may be useful for this purpose. Proteins with a high Trp/Tyr ratio, such as  $\alpha$ -LA and  $\beta$ -LG (Figure 4.7d and e, respectively), possess a deep minimum of the second derivative at  $\lambda = 290 \pm 2$  nm. Proteins with a low Trp/Tyr ratio, such as  $\alpha_s$ -casein,  $\kappa$ -casein, or serum albumin (Figure 4.7a, c, and f, respectively), produce the second derivatives of UV spectra with minor or no minimum at this wavelength. Proteins with a low Trp/Tyr ratio also have a relatively deep minimum in the second derivatives of UV spectra at  $\lambda = 276 \pm 2$  nm. A wavelength between 270 and 300 nm is recommended for the identification of proteins on the basis of the second and fourth derivatives of UV spectra [111]. All the equations presented in Table 4.2 utilize the minima and maxima within this range. The shape of a spectrum derivative at lower wavelengths strongly depends on the protein



**Table 4.2 Examples Used for the Description of the Shape of UV-Spectra Derivatives and Similarity between Standard and Query Spectra**

Equation	Symbols	Comments	Ref.
$X = \frac{(d^2 A/d\lambda^2)_{280} - (d^2 A/d\lambda^2)_{276}}{(d^2 A/d\lambda^2)_{288} - (d^2 A/d\lambda^2)_{283}} \quad (4.2)$	<p>A, absorbance; <math>\lambda</math>, wavelength; <math>d^2A/d\lambda^2</math>, second derivative of absorbance at given wavelength</p>	<p>Parameters describing the shape of the second derivatives of UV spectra</p>	[111]
$Y = \frac{(d^2 A/d\lambda^2)_{295} - (d^2 A/d\lambda^2)_{290}}{(d^2 A/d\lambda^2)_{288} - (d^2 A/d\lambda^2)_{283}} \quad (4.3)$			
$Z = \frac{(d^4 A/d\lambda^4)_{284} - (d^4 A/d\lambda^4)_{280}}{(d^4 A/d\lambda^4)_{291} - (d^4 A/d\lambda^4)_{288}} \quad (4.4)$	<p><math>d^4A/d\lambda^4</math>, fourth derivative of absorbance at given wavelength</p>	<p>Parameters describing the shape of the fourth derivatives of UV spectra</p>	[111]
$T = \frac{(d^4 A/d\lambda^4)_{291} - (d^4 A/d\lambda^4)_{295}}{(d^4 A/d\lambda^4)_{291} - (d^4 A/d\lambda^4)_{288}} \quad (4.5)$			
$\text{Trp/Tyr} = -0.0687Y^3 + 0.1538Y^2 + 0.2033Y + 0.0482 \quad (4.6)$	<p>Y is calculated according to Equation 4.2</p>	<p>Equation for the calculation of tryptophan/tyrosine ratio on the basis of second derivatives of UV spectra</p>	[161]
$A = \frac{(d^2 A/d\lambda^2)_{280} - (d^2 A/d\lambda^2)_{283}}{A_{220}} \quad (4.7)$	<p>Symbols are the same as in Equations 4.1 and 4.2</p>	<p>Parameters including the derivative spectra and absorbance value of zero-order spectra</p>	[121]
$A = \frac{(d^2 A/d\lambda^2)_{280} - (d^2 A/d\lambda^2)_{283}}{A_{220}} \quad (4.8)$			
$SI = \frac{\sum_j d^m A_j/d\lambda^m(\lambda_j)/d^m A_2/d\lambda^m(\lambda_j)}{\sum_j \sqrt{[d^m A_1/d\lambda^m(\lambda_j)]^2 + [d^m A_2/d\lambda^m(\lambda_j)]^2}} \quad (4.9)$	<p>SI, similarity index; <math>A_1</math>, <math>A_2</math>, absorbance at wavelength <math>\lambda_j</math> of standard and query spectra, respectively; <math>d^m A/d\lambda^m</math>, <math>m</math>th derivative of spectrum; <math>m = 0</math> (for zero-order spectra); 1, 2, 3, 4, etc.</p>	<p>Measure of similarity between the two spectra or derivatives of the spectra</p>	[162]



**Figure 4.7** Second derivatives of UV spectra of major bovine milk proteins. Spectra obtained as described by Dziuba et al. [111]. Protein standards from Sigma were used. (a)  $\alpha_s$ -casein; (b)  $\beta$ -casein; (c)  $\kappa$ -casein; (d)  $\alpha$ -LA; (e)  $\beta$ -LG; (f) BSA.

concentration. Equation 4.8 (Table 4.2) permits the calculation of the Trp/Tyr ratio in proteins involving the second derivatives of spectra. It was designed based on the results obtained using the Class Vp 5.03 program (Shimadzu). The application of other programs [100,113,114] leads to different equations from those presented here. The set of parameters with absorbance at 220 or 240 nm (Equations 4.7 and 4.8 in Table 4.2) enables to include the absorbance of peptide bonds. Absorbance at 220 nm provides an approximately horizontal baseline obtained using solvents containing acetonitrile, water, and trifluoroacetic acid in a volume ratio of 100:900:1 (solvent A) and 900:100:0.7 (solvent B) [116]. Absorbance at a wavelength of 240 nm fulfills the Lambert–Beer law at higher concentrations, than that at 220 nm [121]. Proteins may be identified if there is a statistically significant difference between the values of the parameters describing the shape of their spectra or spectrum derivatives [108,111].

#### 4.6.4.2 Identification via the Libraries of UV-Spectrum Derivatives

Another option is the identification of compounds by comparing their spectra (query spectra) with the spectra from the libraries (standard spectra). The similarity index (SI) of the spectra or

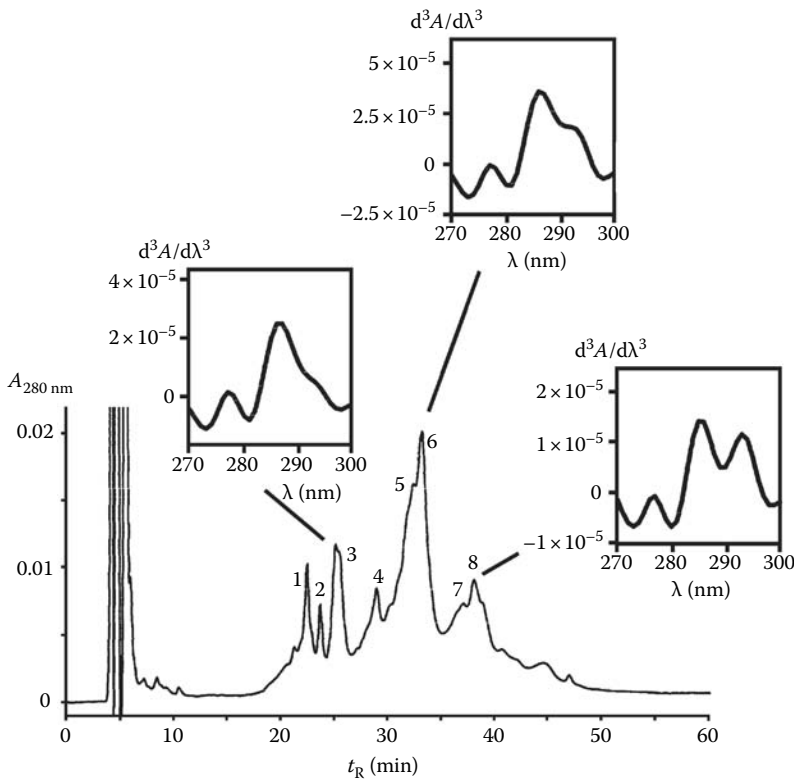
spectrum derivatives, calculated according to Equation 4.9 (Table 4.2), is one of the measures of similarity between the two spectra. Other measures are spectral difference [109] or match angle [122]. According to our results, the third derivatives of the spectra are the best tool for protein identification among all the derivatives of UV spectra. They provide the highest values of the parameters characterizing the performance of qualitative analysis methods [123], i.e., specificity, sensitivity, positive predictive values, and negative predictive values, as well as the highest values of the parameters measuring the statistical significance of the difference between the highest SI and the first and second spectrum in the library, if the computer program arranges the standard spectra from the highest to the lowest SI to the query spectrum [108]. The spectra of proteins with a similar Trp/Tyr ratio, such as the spectra of  $\alpha_{s2}$ - and  $\alpha_{s1}$ -caseins, may be difficult to discriminate. However, the identification of proteins based on the derivatives of UV spectra may fail if the concentration is too low. Absorbance at 280 nm may serve as a criterion for the applicability of the identification based on UV-spectrum derivatives. When absorbance drops below 0.02, the SI decreases and the standard deviation increases. However, the identification of  $\alpha$ -LA was impossible when the absorbance at 280 nm decreased below 0.004 [124]. Another factor affecting the shape of the spectra is the protein structure. The  $\kappa$ -casein forms aggregates composed of chains connected via disulfide bonds. The UV spectra of such aggregates differ from those of the reduced protein (single chains). This may probably be owing to the changes in the solvent accessibility of aromatic amino acid residues or light scattering, caused by the aggregation [108]. On the other hand, only a minor difference was observed between the spectra of reduced and nonreduced  $\alpha$ -LA, although for the isolated proteins, this difference was statistically significant when the absorbance at 280 nm exceeded 0.02.

Identification via a spectral library (Equation 4.8 in Table 4.2) has one major advantage over that involving the parameters characterizing the shape of the spectra (Equations 4.2 through 4.8 in Table 4.2)—it may be performed via the built-in computational procedure in the commercially available program, acquiring and processing chromatographic and spectral data. Therefore, such identification is much faster. However, it requires high-quality standards of proteins to construct a spectral library.

#### **4.6.5 Example of the Application of HPLC Online with UV Spectroscopy**

An example of a chromatogram of sodium caseinate obtained from bovine milk with the representative third derivatives of UV spectra is presented in Figure 4.8. The results of the identification of particular fractions are summarized in Table 4.3. The chromatogram was obtained via RP-HPLC with the use of a solvent system containing acetonitrile, water, and trifluoroacetic acid. The sample was reduced prior to chromatography.

The selection of spectra-characterizing parameters is the first step in the identification procedure. In the case of bovine milk products, the use of a spectral library (Equation 4.9 in Table 4.2) appears to be the best option (owing to the shortest time required for the calculations). The standards of major bovine milk proteins are commercially available and may serve for library construction as well as for the identification of factors affecting the quality of spectra (such as the influence of protein concentration or changes in the computational procedure). The available standards enable one to evaluate procedure performance according to the commonly used criteria [123]. If no such standards are available, then the parameters describing the shape of a spectrum should be chosen.



**Figure 4.8** Chromatogram of sodium caseinate obtained using RP-HPLC method as described by Dziuba et al. [111]. Identification of peaks 1–8 is presented in Table 4.3. Third derivatives of spectra of peak 3 (identified as  $\kappa$ -casein), peak 6 (identified as  $\alpha_s$ -casein), and peak 8 (identified as  $\beta$ -casein) are presented.

The absorbance at 280 nm of the fractions labeled 1–8 was observed within the range of 0.007–0.02. It is possible to identify the proteins from these fractions, although the highest quality of spectra requires absorbance of at least 0.02 [124]. The peaks preceding fraction 1 (except for the so-called injection peak in the first part of the chromatogram, containing buffer components) and following fraction 8 had very low absorbance values (below 0.004) to be identified based on UV spectra, and hence, the third derivatives of UV spectra were chosen.

The order of the retention times of proteins (Table 4.3) is as follows:  $\kappa$ -casein;  $\alpha_s$ -casein;  $\beta$ -casein, which is in agreement with the literature data. Among the third derivatives of the UV spectra presented in Figure 4.8, the spectrum derivative of fraction 3 is the representative of the peaks identified as  $\kappa$ -casein, the spectrum derivative of fraction 6 is the characteristic of  $\alpha_s$ -casein, and the spectrum derivative of fraction 8 is typical of fractions identified as  $\beta$ -casein. The main difference among them is that the third derivative of  $\beta$ -casein spectrum has a minimum at  $288 \pm 2$  nm and a maximum at  $292 \pm 2$  nm. The third derivatives of the spectra of proteins with lower Trp/Tyr ratio have only shoulders within this range. Therefore, it is impossible to discriminate  $\alpha_{s2}$ -casein and  $\alpha_{s1}$ -casein spectra. The SI values presented in Table 4.3 are usually comparable with those obtained previously in an experiment involving  $\alpha$ -LA as a model protein within the same range of

**Table 4.3 Identification of Fractions Indicated in Figure 4.8 on the Basis of Third Derivatives of UV Spectra**

Fraction No.	$t_R$ (min)	Protein	SI <sup>a</sup>
1	22.3	$\kappa$ -CN	0.995
2	23.6	$\kappa$ -CN	0.993
3	25.0	$\kappa$ -CN	0.985
4	28.8	$\alpha_s$ -CN	0.988
5	32.2	$\alpha_s$ -CN	0.997
6	33.0	$\alpha_s$ -CN	0.998
7	36.8	$\beta$ -CN	0.980
8	37.9	$\beta$ -CN	0.985

<sup>a</sup> SI, similarity indices between third derivatives of standard spectra and the third derivatives of query spectra within the range between 270 and 300 nm.

absorbance [124]. However, the baseline separation of the fractions could not be achieved, which caused a decrease in the SI owing to the contamination of the fractions by the preceding or following ones. The highest value of SI to the third derivative of the standard spectrum was achieved for fraction 6 with the highest absorbance.

## 4.7 Electrophoretic Methods for Milk Protein Analysis

### 4.7.1 One-Dimensional Polyacrylamide Gel Electrophoresis

The most commonly used electrophoretic method used for milk protein analysis is the sodium dodecyl sulfate-polyacrylamide gel electrophoresis (SDS-PAGE) protocol described by Laemmli [125]. Separation occurs in the presence of SDS as a detergent and compound containing the thiol groups, used for protein reduction. In these conditions, the proteins are unfolded and their electrophoretic mobility depends on the molecular mass (so-called molecular sieving phenomenon). Increase in the molecular mass leads to decrease in the mobility [126,127]. This method is used for the identification of milk proteins as well as their fragments [128]. The SDS-PAGE followed by densitometry may also be applied for the quantitation of major milk proteins [129].

Application of SDS-PAGE for the identification of milk proteins as well as their high-molecular weight fragments is recommended, which compares their electrophoretic mobility with the mobility of the standards whose identity and purity are proven by other methods, such as mass spectrometry. Protocols for the direct molecular mass determination using SDS-PAGE are available [126,127]; however, this method sometimes fails. Phosphorylated N-terminal  $\beta$ -casein fragments may serve as an example of polypeptides revealing apparent molecular mass measured using SDS-PAGE, which is observed to be much higher than the actual molecular mass (e.g., measured by mass spectrometry) [130,131]. This phenomenon often occurs for acidic, hydrophilic proteins [132], and its mechanism remains unknown till date.

Alkaline (native) PAGE, acid PAGE, or SDS-PAGE without reduction is applied in the studies on aggregation of milk proteins via disulfide bonds [133–137]. The first two methods do not measure the molecular mass, although they are able to separate the aggregates from the proteins in the monomeric form. Anema and Lloyd [138] recommended native PAGE to investigate the fate of individual proteins during thermal denaturation, although this method is too laborious to routinely measure the denaturation range, when compared with the determination of whey protein nitrogen index (WNPI) or reactive sulfhydryl groups (RSH).

### 4.7.2 Two-Dimensional Electrophoresis

The commonly used two-dimensional (2D) electrophoresis method is isoelectric focusing (IEF) followed by SDS-PAGE, first introduced by O'Farrell [139]. The IEF followed by SDS-PAGE is the standard separation method used in proteomic studies.

Another 2D electrophoretic method is the application of alkaline PAGE or SDS-PAGE without reduction as a first dimension. The classic SDS-PAGE in the presence of reducing agent is applied as a second dimension. This method is applied in studies targeted on identification of thermally induced complexes of milk proteins. Using PAGE without reduction allows separation of proteins aggregates. The second dimension serves for the identification of proteins that are components of these aggregates [134,137,140]. The results obtained using this technique were reviewed by de la Fuente et al. [141].

### 4.7.3 Capillary Electrophoresis

Capillary electrophoresis (CE) is currently one of the most commonly used techniques in food analysis [142–144]. This technique is applied for the qualitative and quantitative analysis of all the groups of food components. The major advantage of CE when compared with HPLC is the use of very low amount of chemicals. On the other hand, CE, in contrast to chromatography, cannot be extended to preparative scale, providing sample for further investigations. The CE includes numerous methods of separation, e.g., capillary zone electrophoresis (CZE) based on differences in the electrophoretic mobility (depending on charge and size of the compounds) and electroosmotic flow; micellar electrokinetic chromatography (MEKC) based on hydrophobic interactions, ion interactions, electrophoretic mobility, and electroosmotic flow; and gel electrophoresis in the presence of SDS (SDS-CE) based on molecular sieving or capillary isoelectric focusing (CIEF) based on the differences in  $pI$  [142]. Capillary electrophoretic methods are the common methods applied for the analysis of proteins, e.g., from milk [145–147]. UV detection, fluorescence, or mass spectrometry, are the principal detection methods used in protein analysis [145–147]. Current trends in CE development also include multidimensional hyphenated techniques, including HPLC and CE [147,148] and miniaturization (so-called lab-on-chip techniques) [147,149].

Recent examples of application of CE in milk protein analysis include determination of added caseinate in cheese by CZE and CIEF, determination of individual proteins in cheese whey by CZE, monitoring of  $\beta$ -LG hydrolysis in sour milk and acidophilous milk, determination of trace amounts of this protein in infant formulas by CZE, determination of changes in  $\alpha$ -LA and  $\beta$ -LG in heated milk by CE on chip, characterization of caseins lactosylation using CZE-MS, detection of milk of various species in mixtures, or studies on dependences between product history as well as technology applied for the production and composition of proteins fractions [147].

## 4.8 Other Methods

Kjeldahl method involving titration of ammonia obtained from the conversion of nitrogen-containing compounds by reaction with sulfuric(VI) acid is the principal method of protein determination, recommended by national and international standards [150–152]. The protein content is calculated using the conversion factor, depending on its nitrogen content. However, accurate conversion factor is still under discussion [150–154]. The major problem is the occurrence of various nonprotein nitrogen, including, e.g., short peptides, free amino acids, nucleosides, nucleotides, urea, and other low-molecular weight components. Nonprotein-nitrogen content is determined as a fraction soluble in TCA or PTA solutions. For fast analysis, arbitrary nonprotein-nitrogen content is considered. Recently, data from HPLC and mass spectrometry have been utilized for the convention-factor calculation [152].

Prevention of allergy to milk proteins requires specific methods capable of detecting and determining very low amount of milk proteins in the products [155]. Methods based on immunoassays, such as sandwich enzyme-linked immunosorbent assay (S-ELISA), competitive ELISA (C-ELISA), biosensors based on antibodies, or immunoelectrophoresis are widely used. However, the ELISA techniques appear to be most sensitive, to date.

## Acknowledgment

This work was supported by the funds of UWM within the project 522-0712-809.

## References

1. Madureira, A.R. et al., Bovine whey proteins—Overview on their main biological properties, *Food Res. Int.*, 40, 197, 2007.
2. Swaisgood, H.E., Chemistry of caseins, in *Advanced Dairy Chemistry, Vol. 1. Proteins*, Fox, P.F., Ed., Elsevier Applied Science, New York, 1992, 63.
3. Waugh, D.F., Formation and structure of micelles, in *Milk Proteins: Chemistry and Molecular Biology*, McKenzie, H.A., Ed., Academic Press, New York, 1971, 4.
4. Farrell, H.M., Jr. et al., Nomenclature of the proteins of cows' milk—Sixth revision, *J. Dairy Sci.*, 87, 1641, 2004.
5. Grosclaude, F. and Ribadeau-Dumas, B., Structure primaire de la caseine  $\alpha_{s1}$  et de la caseine  $\beta$ -bovine, *Eur. J. Biochem.*, 40, 323, 1973.
6. Mercier, J.-C., Grosclaude, F., and Ribadeau-Dumas, B., Structure primaire de la caseine  $\alpha_{s1}$  bovine. Sequence complete, *Eur. J. Biochem.*, 4, 27, 1971.
7. Mercier, J.-C., Phosphorylation of caseins. Present evidence for an amino acid triplet code post-translationally recognized by specific kinases, *Biochimie*, 63, 1, 1981.
8. Eigel, W.N. et al., Nomenclature of protein of cow's milk: Fifth revision, *J. Dairy Sci.*, 67, 1599, 1984.
9. Bai, F., Liu, S., and Witzmann, F.A., Data submitted to SwissProt, 2005.
10. Imanishi, S.Y. et al., Reference-facilitated phosphoproteomics: Fast and reliable phosphopeptide validation by  $\mu$ LC-ESI-Q-TOF MS/MS, *Mol. Cell. Proteomics*, 6, 1380, 2007.
11. Erhardt, G., A new  $\alpha_{s1}$ -casein allele in bovine milk and its occurrence in different breeds, *Anim. Genet.*, 24, 65, 1993.
12. Mahè, M.F. et al., Genetic polymorphism of milk proteins in African *Bos taurus* and *Bos indicus* populations characterization of variants  $\alpha_{s1}$ -Cn H and  $\kappa$ -Cn J, *Génét. Sév. Evol.*, 31, 239, 1999.
13. Mariani, P. et al., Effects of the  $\alpha_{s1}$ -CN G allele on the percentage distribution of caseins  $\alpha_{s1}$ -,  $\alpha_{s2}$ -,  $\beta$ -, and  $\kappa$ - in Italian Brown cows, *Ind. Latte*, 31, 3, 1995.

14. Mercier, J.-C., Grosclaude, F., and Ribadeau-Dumas, B., Primary structure of alpha casein and of bovine beta casein. Correction. *Eur. J. Biochem.*, 40, 323, 1973.
15. Kumosinski, T.F., Brown, E.M., and Farrell, H.M. Jr., Predicted energy-minimized  $\alpha_{s1}$ -casein working model, *Proceedings of the 205th National Meeting American Chemical Society*, Denver, CO, 368, 1994.
16. Bouniol, C., Printz, C., and Mercier, J.-C., Bovine  $\alpha_{s1}$ -casein D is generated by exon skipping, *Gene*, 128, 289, 1993.
17. Brignon, G. et al., Complete amino acid sequence of bovine alphaS2-casein, *FEBS Lett.*, 76, 274, 1977.
18. Grosclaude, F., A genetic and biochemical analysis of a polymorphism of bovine alpha S2-casein, *J. Dairy Res.*, 46, 211, 1979.
19. Mahè, M.F. and Grosclaude F., Polymorphisme de la caseine  $\alpha_{s2}$  des bovines: Characterization du variant C du yak (*Bos grunnius*), *Ann. Genet. Sel. Anim.*, 14, 401, 1982.
20. Carles, C., Huet, J.-C., and Ribadeau-Dumas, B., KA new strategy for primary structure determination of proteins: Application to  $\beta$ -casein, *FEBS Lett.*, 229, 265, 1988.
21. Ribadeau-Dumas B. et al., Structure primaire de la caseine beta bovine, *Eur. J. Biochem.*, 25, 505, 1972.
22. Dong, C. and Ng-Kwai-Hang, K.F., Characterization of a non-electrophoretic genetic variant of  $\beta$ -casein by peptide mapping and mass spectrometric analysis, *Int. Dairy J.*, 8, 967, 1998.
23. Han, S.K., Shin, Y.C., and Byun, H.D., Biochemical, molecular and physiological characterization of a new  $\beta$ -casein variant detected in Korean cattle, *Anim. Genet.*, 31, 49, 2000.
24. Senocq, D.D. et al., A new bovine  $\beta$ -casein genetic variant characterized by a Met93>Leu93 substitution in the sequence A<sup>2</sup>, *Lait*, 82, 171, 2002.
25. Swaisgood, H.E., Chemistry of milk proteins, in *Developments in Dairy Chemistry*, Fox, P.F., Ed., Applied Science Publishers, London, U.K., 1982, 1.
26. Visser, S. et al., Identification of a new genetic variant of bovine  $\beta$ -casein by reversed-phase high-performance liquid chromatography and mass spectrometric analysis, *J. Chromatogr. A*, 711, 141, 1995.
27. Wu, S.L. et al., Extended range proteomic analysis (ERPA): A new and sensitive LC-MS platform for high sequence coverage of complex proteins with extensive post-translational modification-comprehensive analysis of beta-casein and epidermal growth factor receptor (EGFR), *J. Proteome Res.*, 4, 1155, 2005.
28. Kumosinski, T.F., Brown, E.M., and Farrell, H.M. Jr., Three-dimensional molecular modeling of bovine caseins: Energy minimized  $\beta$ -casein structure, *J. Dairy Sci.*, 76, 931, 1993.
29. Alexander, L.J.A.F. et al., Isolation and characterization of the bovine  $\kappa$ -casein gene, *Eur. J. Biochem.*, 178, 395, 1988.
30. Grosclaude, F. et al., Localization of amino acid substitutions differentiating the A and B variants of  $\kappa$ -casein in cattle, *Ann. Génét. Sél. Anim.*, 4, 515, 1972.
31. Mercier, J.-C., Brignon, G., and Ribadeau-Dumas, B., Structure primaire de la caseine kappa B bovine. Sequence complete, *Eur. J. Biochem.*, 35, 222, 1973.
32. Horne, D.S., Casein micelle structure: Models and muddles, *Curr. Opin. Colloid Interface Sci.*, 11, 148, 2006.
33. Kanamori, M. et al., Presence of O-glycosidic linkage through serine residue in  $\kappa$ -casein component from bovine mature milk, *J. Nutr. Sci. Vitaminol.*, 27, 231, 1981.
34. Pisano, A. et al., Characterization of O-linked glycosylation motifs in the glycopeptide domain of bovine  $\kappa$ -casein, *Glycobiology*, 4, 837, 1994.
35. Saito, T. and Itoh, T., Variation and distributions of O-glycosidically linked sugar chains in bovine  $\kappa$ -casein, *J. Dairy Sci.*, 75, 1768, 1992.
36. Kumosinski, T.F., Brown, E.M., and Farrell, H.M. Jr., Three-dimensional molecular modeling of bovine caseins: A refined energy-minimized  $\kappa$ -casein structure, *J. Dairy Sci.*, 76, 2507, 1993.



37. Farrell, H.M. Jr., Wickham, E.D., and Groves, M.L., Environmental influence on purified  $\kappa$ -casein: Disulfide interactions, *J. Dairy Sci.*, 81, 2974, 1998.
38. Brignon, G. and Ribadeau-Dumas B., Localization of the Glu-Gln substitution differentiating B and D genetic variants in the peptide chain of bovine beta lactoglobulin, *FEBS Lett.*, 33, 73, 1973.
39. Conti, A.L. et al., Bovine  $\beta$ -lactoglobulin H: Isolation by preparative isoelectric focusing in immobilized pH gradients and preliminary characterization, *J. Biochem. Biophys. Methods*, 16, 205, 1988.
40. Godovac-Zimmermann, J. et al., Isolation and rapid sequence characterization of two novel bovine  $\beta$ -lactoglobulins I and J, *J. Protein Chem.*, 15, 743, 1996.
41. Godovac-Zimmermann, J. et al., Genetic variants of bovine beta-lactoglobulin. A novel wild-type beta-lactoglobulin W and its primary sequence, *Biol. Chem. Hoppe-Seyler*, 371, 255, 1990.
42. Jakob, E. and Puhán, Z., Technological properties of milk as influenced by genetic polymorphism of milk proteins—A review, *Int. Dairy J.*, 2, 157, 1992.
43. Braunitzer, G. et al., The sequence of beta-lactoglobulin, *Hoppe-Seyler's Z. Physiol. Chem.*, 354, 867, 1973.
44. Kuhn, N.J., Carrick, D.T., and Wilde, C.J., Lactose synthesis: Possibilities of regulation, *J. Dairy Sci.*, 63, 328, 1980.
45. Brew, K. et al., The complete amino acid sequence of bovine  $\alpha$ -lactoalbumin, *J. Biol. Chem.*, 245, 4570, 1970.
46. Permyakov, E.A. and Berliner, L.J.,  $\alpha$ -Lactalbumin: Structure and function, *FEBS Lett.*, 473, 269, 2000.
47. Carter, D.C. and Ho, J.X., Structure of serum albumin, *Adv. Protein Chem.*, 45, 153, 1994.
48. de Wit, J.N., Nutritional and functional characteristics of whey proteins in food products, *J. Dairy Sci.*, 81, 597, 1998.
49. Kilara, A. and Panyam, D. Peptides from milk proteins and their properties, *Crit. Rev. Food Sci. Nutr.*, 43, 607, 2003.
50. Kinsella, J.E., Physical properties of food and milk components, research needs to expand uses, *J. Dairy Sci.*, 70, 2419, 1987.
51. Dalgleish, D.G., Food emulsions—Their structures and structure-forming properties, *Food Hydrocoll.*, 20, 415, 2006.
52. Damodaran, S., Protein-stabilized foams and emulsions, in *Food Proteins and Their Applications*, Damodaran, S. and Paraf, A., Eds., Marcel Dekker Inc., New York, 1997, 57.
53. Kiosseoglou, V., Egg yolk protein gels and emulsions, *Curr. Opin. Colloid Interface Sci.*, 8, 365, 2003.
54. Pomerantz, Y., New and novel foods, in *Functional Properties of Food Components*, Taylor, S.L., Ed., Academic Press Inc., London, U.K., 1991.
55. Schein, C., Solubility as a function of protein structure and solvent components, *Biotechnology*, 8, 308, 1990.
56. Panyam, D. and Kilara, A., Enhancing the functionality of food proteins by enzymatic modification, *Trends Food Sci. Technol.*, 7, 120, 1996.
57. Tunçtürk, Y. and Zorba, Ö., The effects of enzymatic hydrolysis of casein on apparent yield stress and some emulsion properties, *Food Hydrocoll.*, 20, 475, 2006.
58. Grufferty, M.B. and Fox, P.F., Milk alkaline proteinase, *J. Dairy Res.*, 55, 609, 1988.
59. Abert, T. and Kneifel, W., Physicochemical and functional properties of protein hydrolysates as obtained by treatment with different enzymes, in *Protein of Fat Globule Modification by Heat Treatment, Homogenization and Other Technological Means for High Quality Dairy Products*, International Dairy Federation Special Issue No. 9303, Int. Dairy Fed., Brussels, Belgium, 1992, 125.
60. Dickinson, E., Caseins in emulsions: Interfacial properties and interactions, *Int. Dairy J.*, 9, 305, 1999.
61. Wong, D.W.S., Camirand, W.M., and Pavlath, A.E., Structures and functionalities of milk proteins, *Crit. Rev. Food Sci. Nutr.*, 36, 807, 1996.

62. Darewicz, M., Dziuba, J., and Caessens, P.W.J.R., Effect of enzymatic hydrolysis on emulsifying and foaming properties of milk proteins. A review, *Pol. J. Food Nutr. Sci.*, 9/50 (1), 3, 2000.
63. Darewicz, M. et al., Dephosphorylation-induced structural changes in  $\beta$ -casein and its amphiphilic fragment in relation to emulsion properties, *Biochimie*, 82, 191, 2000.
64. Darewicz, M. and Dziuba, J., The effect of glycosylation on emulsifying and structural properties of bovine  $\beta$ -casein, *Nahrung/Food*, 45, 15, 2001.
65. Holt, C. and Sawyer, L., Caseins as rheomorphic proteins: Interpretation of primary and secondary structures of the  $\alpha_{s1}$ -,  $\beta$ - and  $\kappa$ -caseins, *J. Chem. Soc. Faraday Trans.*, 89, 2683, 1993.
66. Darewicz, M., Dziuba, J., and Dziuba, M., Functional properties and biological activities of bovine casein proteins and peptides, *Pol. J. Food Nutr. Sci.*, 15/56 S11, 79, 2006.
67. Dauphas, S., The supramolecular organization of  $\beta$ -casein: Effect on interfacial properties, *Food Hydrocoll.*, 19, 387, 2005.
68. Klemaszewski, J.L., Das K.P., and Kinsella, J.E., Formation and coalescence stability of emulsions stabilized by different milk proteins, *J. Food Sci.*, 57, 366, 1992.
69. Walstra, P. and De Roos, A.L., Proteins at air–water and oil–water interfaces: Static and dynamic aspects, *Food Rev. Int.*, 9, 503, 1993.
70. Clarkson, J.R., Ciu, Z.F., and Darton, R.C., Effect of solution conditions on protein damage in foam, *Biochem. Eng. J.*, 4, 107, 2000.
71. Chobert, J.M., Milk protein modification to improve functional and biological properties, *Adv. Food Nutr. Res.*, 47, 1, 2003.
72. Walsh, D.J., Russell, K., and FitzGerald, R.J., Stabilisation of sodium caseinate hydrolysate foams, *Food Res. Int.*, 41, 43, 2008.
73. Chobert, J.M. et al., Recent advances in enzymatic modifications of food proteins for improving their functional properties, *Nahrung*, 40, 177, 1996.
74. Innocente, N., Comparin, D., and Corradini C., Proteose–peptone whey fraction as emulsifier in ice-cream preparation, *Int. Dairy J.*, 12, 69, 2002.
75. Patel, G.C., Structure and foaming properties of peptides isolated from casein hydrolysates, PhD thesis, The Pennsylvania State University, University Park, PA, 1994.
76. Augustin, M.A. and Udabage, P., Influence of processing on functionality of milk and dairy proteins, *Adv. Food Nutr. Res.*, 53, 1, 2007.
77. Kang, J.H. et al., The relationship between biophysical activity and the secondary structure of synthetic peptides from the pulmonary surfactant protein SP-B, *Biochem. Mol. Biol. Int.*, 40, 617, 1996.
78. Sheehan, D., Carey, K., and O’Sullivan, S., Design of emulsification peptides, in *Advances in Food and Nutrition Research*, Taylor, S.L., Ed., Academic Press, New York, 1998, 93.
79. Darewicz, M. and Dziuba, J., Formation and stabilization of emulsion with A<sup>1</sup>, A<sup>2</sup> and B  $\beta$ -casein genetic variants, *Eur. Food Res. Technol.*, 226, 147, 2007.
80. Darewicz, M. and Dziuba, J., Advanced statistical methods as a new tool for data analysis in food and nutrition science, *Acta Sci. Pol. Technol. Aliment.*, 4 (1), 19, 2005.
81. Bryant, C.M. and McClements, D.J., Molecular basis of protein functionality with special consideration of cold-set gels derived from heat-denatured whey, *Trends Food Sci. Technol.*, 9, 143, 1998.
82. Lucey, J.A., Johnson, M.E., and Horne, D.S., Invited review: Perspectives on the basis of the rheology and texture properties of cheese, *J. Dairy Sci.*, 86, 2725, 2003.
83. Foegeding, E.A. et al., Advances in modifying and understanding whey protein functionality, *Trends Food Sci. Technol.*, 13, 151, 2002.
84. Glibowski, P., Mleko, S., and Wesołowska-Trojanowska, M., Gelation of single heated vs. double heated whey protein isolate, *Int. Dairy J.*, 16, 1113, 2006.
85. Guyomarc’h, F. et al., Role of the soluble and micelle-bound heat-induced protein aggregates on network formation in acid skim milk gels, *J. Agric. Food Chem.*, 51, 7743, 2003.
86. Mleko, S., High-pH gelation of whey protein isolate, *Int. J. Food Sci. Technol.*, 36, 331, 2001.

87. Mulvihill, D.M., Production, functional properties and utilization of milk protein products, in *Advanced Dairy Chemistry, Vol. 1. Proteins*, Fox, P.F., Ed., Elsevier Applied Science, London, 1992, 369.
88. Mulvihill, D.M. and Kinsella J.E., Gelation of  $\beta$ -lactoglobulin: Effects of sodium chloride and calcium on the rheological and structural properties of gels, *J Food Sci.*, 53, 231, 1988.
89. Esteves, C.L.C., Lucey, J.A., and Pires, E.M.V., Mathematical modelling of the formation of rennet-induced gels by plant coagulants and chymosin, *J. Dairy Res.*, 68, 499, 2001.
90. Topçu, A., Numanoglu, E., and Saldamli, J., Proteolysis and storage stability of UHT milk produced in Turkey, *Int. Dairy J.*, 16, 633, 2006.
91. Singh, H. and Creamer, L.K., Heat stability of milk, in *Advanced Dairy Chemistry, Vol. 1. Proteins*, Fox P.F., Ed., Elsevier Science Publishers, New York, 1992, 621.
92. Mango, A.E., Chaveron, H., and Abena, A.A., Whey protein concentrates added in a beverage and their thermal denaturation studied by liquid phase chromatography, *Biotechnology* 6, 64, 2007.
93. Manji, B. and Kakuda, Y., The role of protein denaturation, extent of proteolysis, and storage temperature on the mechanism of age gelation in a model system, *J. Dairy Sci.*, 71, 1455, 1988.
94. Tolkach, A., Steinle, S., and Kulozik, U., Optimization of thermal pretreatment conditions for the separation of native  $\alpha$ -lactalbumin from whey protein concentrates by means of selective denaturation of  $\beta$ -lactoglobulin, *J. Food Sci.*, 70, E557, 2005.
95. Kinekawa, Y.-I., Goto, S., and Kitabatake, N., Development and manufacture of process whey protein, *Nippon Shokuhin Kagaku Kogaku Kaishi*, 44, 599, 1997.
96. Alting, A.C. et al., Number of thiol groups rather than the size of the aggregates determines the hardness of cold set whey protein gels, *Food Hydrocoll.*, 17, 469, 2003.
97. Hambling, S.G., Mcalpine, A.S., and Sawyer, L.,  $\beta$ -Lactoglobulin, in *Advanced Dairy Chemistry. Vol. 1. Proteins*, Fox, P.F., Ed., Elsevier Science, London, 1992, 141.
98. Dziuba, J. and Muzińska, B., An effect of the low temperature induced possesses of the dissociation-association on the molecular state of casein, *Milchwissenschaft*, 53, 551, 1998.
99. Dziuba, J. and Muzińska, B., Effect of cold storage of milk on functional properties of casein, *Pol. J. Food Nutr., Sci.*, 7/48, 485, 1998.
100. Singh, H. and Fox, P.F., Heat-induced changes in casein, *Bull. IDF*, 238, 24, 1989.
101. Anema, S.G. and Li, Y., Effect of pH on the association of denatured whey proteins with casein micelles in heated reconstituted skim milk, *J. Agric. Food Chem.*, 51, 1640, 2003.
102. Hill, A.R., The  $\beta$ -lactoglobulin- $\kappa$ -complex, *Can. Inst. Food Sci. Technol. J.*, 22, 120, 1989.
103. Corredig, M. and Dalgleish, D.G., Effect of temperature and pH on the interactions of whey proteins with casein micelles in skim milk, *Food Res. Int.*, 29, 49, 1996.
104. Efigenia, M., Poroa, B., and Maraes-Santos, T., Effect of heat treatment on the nutritional quality of milk proteins, *Int. Dairy J.*, 7, 609, 1997.
105. Kuś, S., Marczenko, Z., and Obarski, N., Derivative UV-vis spectroscopy in analytical chemistry, *Chem. Anal.*, 41, 899, 1996.
106. Bosch Ojeda, C. and Sanchez Rojas, F., Recent developments in derivative ultraviolet/visible absorption spectrophotometry, *Anal. Chim. Acta*, 518, 1, 2004.
107. Karpińska, J., Derivative spectrophotometry—Recent applications and directions of developments, *Talanta*, 64, 801, 2004.
108. Minkiewicz, P. et al., Application of high-performance liquid chromatography on-line with ultraviolet/visible spectroscopy in food science, *Pol. J. Food Nutr. Sci.*, 15/56 SI1, 145, 2006.
109. Papadoyannis, I.N. and Gika, H.G., Peak purity determination with a diode array detector, *J. Liq. Chromatogr. Relat. Technol.*, 27, 1069, 2004.
110. Luo, J. et al., Properties of Savitzky-Golay digital differentiators, *Digit. Signal Process.*, 15, 122, 2005.
111. Dziuba, J. et al., Reversed-phase high-performance liquid chromatography on-line with the second and fourth derivative ultraviolet spectroscopy as a tool for identification of milk proteins, *Anal. Chim. Acta*, 449, 243, 2001.

112. Perrin, E. et al., Rapid determination of the ratios of three aromatic residues in peptides by reversed-phase high performance liquid chromatography with a high resolution photodiode-array detector, *J. Chromatogr. B*, 664, 267, 1995.
113. Zhao, Q. et al., Reversed-phase high-performance liquid chromatography coupled with second order derivative spectroscopy for the quantitation of aromatic amino acids in peptides: Application to hemorphins, *J. Chromatogr. A*, 723, 35, 1996.
114. Bordin, G. et al., Identification and quantification of major bovine milk proteins by liquid chromatography, *J. Chromatogr. A*, 928, 63, 2001.
115. Minkiewicz, P. et al., Identification of peptides obtained via hydrolysis of bovine casein by chymosin using HPLC and mass spectrometry, *Milchwissenschaft*, 55, 14, 2000.
116. Visser, S., Slangen, C.J., and Rollema, H.S., Phenotyping of bovine milk proteins by reversed-phase high-performance liquid chromatography, *J. Chromatogr.*, 548, 361, 1991.
117. Rohm, H. et al., Comparison of ethanol and trichloroacetic acid fractionation for measurement of proteolysis in Emmental cheese, *Int. Dairy J.*, 6, 1069, 1996.
118. Poveda, J.M. et al., Preliminary observations on proteolysis in Manchego cheese made with a defined strain starter culture and adjunct starter (*Lactobacillus plantarum*) or a commercial starter, *Int. Dairy J.*, 14, 169, 2003.
119. Léonil, J.D. et al., Analysis of major bovine milk proteins by on-line high-performance liquid chromatography and electrospray-ionization mass spectrometry, *Lait*, 75, 193, 1995.
120. Gasteiger, E., Protein identification and analysis tools on the ExPASy server, in *The Proteomics Protocols Handbook*, Walker, J.M., Eds., Humana Press Inc., Totowa, NY, 2005, 571.
121. Darewicz, M. et al., Reversed-phase high-performance liquid chromatography on-line with second derivative ultraviolet spectroscopy as a tool for the identification of  $\beta$ -casein, *Milchwissenschaft*, 60, 14, 2005.
122. Young, P.M. and Gorenstein, M.V., Tryptic mapping by reversed-phase HPLC with photodiode-array detection incorporating the spectral-contrast technique, *LC-GC Int. Magn. Sep. Sci.*, 12, 832, 1994.
123. Ellison, S.L.R. and Fearn, T., Characterising the performance of qualitative analytical methods, *Trends Anal. Chem.*, 24, 468, 2005.
124. Minkiewicz, P. et al., Bovine  $\alpha$ -lactalbumin identification based on chemometrical analysis of the third derivatives of ultraviolet spectra obtained after separation by reversed-phase high-performance liquid chromatography, *Pol. J. Natl. Sci.*, 20, 433, 2006.
125. Laemmli, U.K., Cleavage of structural proteins during the assembly of the head of bacteriophage T4, *Nature*, 249, 680, 1970.
126. Shapiro, A.L., Viñuela, E. and Maizel, J.V. Jr., Molecular weight estimation of polypeptide chains by electrophoresis in SDS-polyacrylamide gels, *Biochem. Biophys. Res. Commun.*, 30, 815, 1967.
127. Swank, R.T. and Munkers, K.D., Molecular weight analysis of oligopeptides by electrophoresis in polyacrylamide gel with sodium dodecyl sulfate, *Anal. Biochem.*, 39, 462, 1971.
128. Ribadeau-Dumas, B. and Grappin, R., Milk protein analysis, *Lait*, 69, 377, 1989.
129. Dziuba, J. and Mioduszevska, H., Quantitative analysis of milk proteins by SDS-PAGE, *Pol. J. Food Nutr. Sci.*, 6/47 (1), 91, 1997.
130. Dziuba, J. et al., Application of SDS-polyacrylamide gel electrophoresis and reversed-phase-high-performance liquid chromatography on-line with the second and fourth derivatives UV spectroscopy in identification of  $\beta$ -casein and its peptide fractions, *Milchwissenschaft*, 57, 497, 2002.
131. Jolivet, P. et al., Plasmin digestion of bovine  $\beta$ -casein dephosphorylated with one protein phosphatase type 2A purified from *Yarrowia lipolytica*, *Lait*, 80, 517, 2000.
132. Chiou, S.H. and Wu, S.H., Evaluation of commonly used electrophoretic methods for the analysis of proteins and peptides and their application to biotechnology, *Anal. Chim. Acta*, 393, 47, 1999.
133. Calvo, M.M., Leaver, J. and Banks, J.M., Influence of other whey proteins on the heat-induced aggregation of  $\alpha$ -lactalbumin, *Int. Dairy J.*, 3, 719, 1993.
134. Manderson, G.A., Hardman, M.J., and Creamer L.K., Effect of heat treatment on the conformation and aggregation of  $\beta$ -lactoglobulin A, B and C, *J. Agric. Food Chem.*, 46, 5052, 1998.

135. Schokker, E.P. et al., Heat-induced aggregation of  $\beta$ -lactoglobulin AB at pH 2.5 as influenced by ionic strength and protein concentration, *Int. Dairy J.*, 10, 233, 2000.
136. Surroca, Y., Haverkamp, J., and Heck, A.J.R., Towards the understanding of molecular mechanisms in the early stages of heat-induced aggregation of  $\beta$ -lactoglobulin, *J. Chromatogr. A*, 970, 295, 2002.
137. Hong, Y.H. and Creamer, L.K., Changed protein structures of bovine  $\beta$ -lactoglobulin B and  $\alpha$ -lactalbumin as a consequence of heat treatment, *Int. Dairy J.*, 12, 345, 2002.
138. Anema, S.G. and Lloyd, R.J., Analysis of whey protein denaturation: A comparative study of alternative methods, *Milchwissenschaft*, 54, 206, 1999.
139. O'Farrell, P.H., High resolution two-dimensional electrophoresis of proteins, *J. Biol. Chem.*, 250, 4007, 1975.
140. Havea, P. et al., Electrophoretic characterization of protein products formed during heat treatment of whey protein concentrate solutions, *J. Dairy Res.*, 65, 79, 1998.
141. de la Fuente, M.A., Singh, H., and Hemar, Y., Recent advances in the characterisation of heat-induced aggregates and intermediates of whey proteins, *Trends Food Sci. Technol.*, 13, 262, 2002.
142. Michaelsen, S. and Sørensen, H., High performance capillary electrophoresis: Principles, present possibilities and future potentialities in studies of low and high molecular weight charged and uncharged biomolecules, *Pol. J. Food Nutr. Sci.*, 3/44 (1), 5, 1994.
143. Frazier, R.A. and Papadopoulou, A., Recent advances in the application of capillary electrophoresis for food analysis, *Electrophoresis*, 24, 4095, 2003.
144. García-Cañas, V. and Cifuentes, A., Recent advances in the application of capillary electromigration methods for food analysis, *Electrophoresis*, 29, 294, 2008.
145. Recio, I., Ramos, M., and López-Fandiño, R., Capillary electrophoresis for the analysis of food proteins of animal origin—Review, *Electrophoresis*, 22, 1489, 2001.
146. Bean, S.R. and Lookhart, G.L., High performance capillary electrophoresis of meat, dairy and cereal proteins, *Electrophoresis*, 22, 4207, 2001.
147. Dolník, V., Capillary electrophoresis of proteins 2005–2007, *Electrophoresis*, 29, 143, 2008.
148. Stroink, T. et al., On-line multidimensional liquid chromatography and capillary electrophoresis systems for peptides and proteins, *J. Chromatogr. B*, 817, 49, 2005.
149. Peng, Y. et al., Recent innovations in protein separation on microchips by electrophoretic methods, *Electrophoresis*, 29, 157, 2008.
150. Karman, A.H. and van Boekel, M.A.J.S., Evaluation of the Kjeldahl factor for conversion of the nitrogen content of milk and milk product to protein content, *Neth. Milk Dairy J.*, 40, 315, 1986.
151. Rouch, D.A., Roupas, P., and Roginski, H., True protein value of milk and dairy products, *Aust. J. Dairy Technol.*, 61, 37, 2006.
152. Rouch, D.A. et al., Determination of a nitrogen conversion factor for protein content in Cheddar cheese, *Int. Dairy J.*, 18, 216, 2008.
153. van Boekel, M.A.J.S. and Ribadeau-Dumas, B., Addendum to the evaluation of the Kjeldahl factor for conversion of the nitrogen content of milk and milk products to protein content, *Neth. Milk Dairy J.*, 41, 281, 1987.
154. Salo-Väänänen, P.P. and Koivistoinen, P.E., Determination of proteins in foods: Comparison of net protein and crude protein ( $N \times 6.25$ ) values, *Food Chem.*, 57, 27, 1996.
155. Monaci, L. et al., Milk allergens; their characteristics and their detection in food: A review. *Eur. Food Res. Technol.*, 223, 149, 2006.
156. Erhardt, G., Detection of a new  $\kappa$ -casein variant in the milk of Pinzgauer cattle, *Anim. Genet.*, 27, 105, 1996.
157. Miranda, G.P. et al., Biochemical characterization of the bovine genetic kappa-casein C and E variants, *Anim. Genet.*, 4, 27, 1993.
158. Prinzenberg, E.M., Krause, I., and Erhardt, G., SCCP analysis of the bovine CSN3 locus discriminates six alleles corresponding to known protein variants (A, B, C, E, F, G) and three new DNA polymorphism (H, I, A<sup>1</sup>), *Anim. Biotechnol.*, 10, 49, 1999.

159. Sulimova, et al., Analysis of DNA polymorphisms of clustered genes in cattle: Casein genes and genes of the major histocompatibility complex (BoLA), *Tsitol. I. Genetika*, 26, 18, 1992.
160. Bleck, G.T. and Bremel, R.D., Correlation of the  $\alpha$ -lactalbumin (+15) polymorphism to milk production and milk composition of Holsteins, *J. Dairy Sci.*, 76, 2292, 1993.
161. Dziuba, J. et al., Application of ultraviolet spectroscopy to discriminate wheat  $\alpha/\beta$ - and  $\gamma$ -gliadins separated with high-performance liquid chromatography—A short report, *Pol. J. Food Nutr. Sci.*, 57, 191, 2007.
162. Minkiewicz, P., Dziuba, J., and Nałęcz, D., Application of derivatives of UV spectra and similarity indices to identification of milk proteins separated using reversed-phase high performance liquid chromatography, *Polimery*, 48, 106, 2003.



# Chapter 5

---

# Proteomics

---

Stefano Sforza, Valeria Cavatorta, and Rosangela Marchelli

## CONTENTS

5.1	Introduction.....	109
5.2	Sample Preparation .....	111
5.2.1	Sample Clean-Up, Preparation, and Storage for 2D Electrophoresis .....	111
5.2.2	Sample Clean-Up, Preparation, and Storage for LC and CE Analyses .....	113
5.3	Separation Techniques in Proteomics and Peptidomics.....	113
5.3.1	Two-Dimensional Polyacrylamide Gel Electrophoresis .....	113
5.3.2	Capillary Electrophoresis .....	118
5.3.3	High-Pressure Liquid Chromatography .....	120
5.4	Identification Techniques in Proteomics and Peptidomics .....	124
5.4.1	Identification by Non-MS-Based Techniques.....	124
5.4.2	Identification by MALDI-MS.....	125
5.4.3	Identification by ESI-MS .....	127
5.5	Conclusions and Future Perspectives.....	132
	References.....	132
	Further Readings .....	137

## 5.1 Introduction

The advent of “-omics” techniques has marked a turning point in the fields of chemistry, biology, and medicine. Beginning from the progenitor term “genomics” (the study of the “genome”), numerous terms ending with “-omics” have started to appear in the scientific literature, resulting in tenths of “-omics” technologies, till date. The original meaning of the word “genome” (gene + chromosome) has been totally forgotten: the “-ome” suffix now implies the concept of totality



(i.e., proteome: the total protein complement of a genome [1]; peptidome: the total content of peptides, etc.). Thus, proteomics can be considered as the study of the proteome, i.e., the total proteins expressed by a given tissue/cell/organism at a given time under specified conditions. The concept implied in the word is that, unlike the standard methods for studying proteins, the technologies used in proteomics are able to give a comprehensive vision of the protein pattern (what it is often called “a bird’s eye”) and, at the same time, the possibility to focus on one (or more) protein of interest, to be studied in details.

Today, the workhorse of proteomics is undoubtedly the two-dimensional polyacrylamide gel electrophoresis (2D-PAGE) [2], coupled to soft mass spectrometric techniques, mainly matrix-assisted laser desorption ionization time-of-flight (MALDI-TOF) [3]. The 2D-PAGE is used to improve the spatial resolution among the protein spots, which is essential for complex protein mixtures. After a first electrophoretic run along one dimension ( $x$ -axis), the proteins are distributed along a strip that constitutes the starting line for a second electrophoretic run along an orthogonal dimension ( $y$ -axis). Usually, the first run is performed by isoelectric focusing (IEF)-PAGE on strips characterized by gradients of pH, and gives information on the isoelectric point (pI) of proteins, while the second run requires sodium dodecylsulfate (SDS). An alternative to SDS-PAGE is urea-PAGE, which separates the proteins according to their charge/mass ratio. Sometimes, for selected applications, capillary electrophoresis (CE) is also used, although its resolving power and its sensitivity generally gives lower performances, when compared with its planar counterpart. As far as high-pressure liquid chromatography (HPLC) is concerned, although this technique can be useful for addressing one or few proteins at the same time, it is generally less adequate for simultaneously studying hundreds of high-molecular weight (MW) proteins; however, it is very efficient for low-MW compounds (i.e., peptides).

The 2D-PAGE has the ability to resolve a complex mixture of hundred proteins, while mass spectrometry (MS) identifies them. The method usually applied for protein identification is the “peptide mass fingerprint” (PMF) of a purified spot, cut from the gel. This method is based on the enzymatic (usually tryptic) digestion of a protein separated on the gel to generate a mixture of peptides: their molecular masses are unique for every given protein, which, on comparison with a protein database, can be easily identified. Thus, the method essentially relies on the combination of two incomplete sets of information (a list of molecular masses and a huge database) to generate a positive hit. Although many problems can arise with this approach, such as post-translational modifications, which alter the molecular masses, the obvious fact that not all the existing proteins are present in the databases, and the repeated reports stating that most of the proteins in a given proteome may go largely undetected with these techniques [4], nevertheless these technologies are currently the most efficient for studying many proteins at the same time.

The main proteomic applications reported in dairy research concern the characterization of milk proteome and lactic acid bacteria (LAB) proteomes. Proteomic techniques provide the ideal way to identify proteins according to their molecular mass and/or their net charge. Thus characterization of milk proteome allows the identification of genetic variants, post-translational modifications, proteome composition at different lactation stages, as well as the modifications induced by technological treatments such as proteolytic cleavages. The proteome of LAB [5], in particular those mostly used in food industry, can give important information on the protein expressed by different strains of microorganisms under different conditions, allowing to predict the technological performance of a strain of potential industrial interest or, for instance, its ability to adapt to stressful growth conditions [6].

Moreover, a particular application of proteomics in dairy products can be considered the study of low- and high-MW peptides in milk-derived products, in particular cheeses. If the technologies

used allow simultaneous separation and identification of many low-MW peptides, then the techniques are known as peptidomics. Food peptidomics is very important in cheeses, where the peptide fractions, generated by the enzymatic hydrolysis of caseins, are usually quite abundant and typically related to the microflora present in these foods, the ingredients, and the technologies utilized. Moreover, the composition of the peptide fractions evolves during the ageing period, generating a peptidome that continuously changes with time. Again, the ability to identify and possibly quantify hundreds of different peptides in a complex mixture relies on the analytical technologies chosen for this purpose. For low-MW peptides (<10 kDa), the resolving power of 2D gel electrophoresis is usually too low, and in this case, HPLC or CE can be used as the separating techniques, coupled to electrospray ionization-mass spectrometry (ESI-MS) for the purpose of identification.

To efficiently apply these separation and identification techniques to dairy products, previous optimal sample preparations are required. Optimized procedures and appropriate separation techniques must be selected for every particular matrix. In fact, proteins in milk are dispersed within the other macronutrients (lipids and sugars) and micronutrients (vitamins, mineral salts, etc.), and are generally distributed in two phases, in an aqueous medium that also includes fat globule emulsions. In this heterogeneous system, proteins are distributed in a wide range of concentrations: the major milk proteins are caseins ( $\alpha_{S1}$ -,  $\beta$ -,  $\alpha_{S2}$ -, and  $\kappa$ -CN) that are organized in micelles via ionic bonds between phosphate groups and calcium ions, which account for nearly 80% of the total proteins in milk, and whey proteins, mainly  $\beta$ -lactoglobulin ( $\beta$ -Lg) and  $\alpha$ -lactalbumin ( $\alpha$ -La). Other milk proteins (soluble in water) are bovine serum albumin (BSA), immunoglobulins (including IgG1, IgG2, IgA, IgM), lactoferrin, lactoperoxidase, and numerous other enzymes including proteases, protease activators, nucleases, glycosidases, etc., present at very low concentrations. In addition, cell membranes and their associated membrane-bound enzymes must be taken into account. Milk proteins also show a high variability with regard to molecular dimensions and isoelectric points. Finally, as milk is used for human nutrition under different forms (cooked, fermented, etc.), several technologically induced transformations of these proteins must be considered. Given all these variables, the target of clear-cut resolution and reproducible detection of all the possible proteins in dairy products is a difficult task.

The methods presented in this chapter will be divided into different sections, according to the different problems encountered by applying proteomics methodologies: sample preparation, separation of proteins and peptides, and identification. Only those methods having a real “-omics” approach, i.e., explicitly aimed at considering the totality of proteins and peptides in a given sample, will be considered in this chapter.

## 5.2 Sample Preparation

### 5.2.1 Sample Clean-Up, Preparation, and Storage for 2D Electrophoresis

To accurately prepare the dairy sample for 2D electrophoresis (2-DE), sample clean-up must be carried out in order to remove specific contaminants (fats and highly abundant proteins may interfere with the detection of less abundant proteins), dialysis at appropriated MW cut-off, and desalting techniques.

Milk caseins can be easily detected as the most abundant proteins. However, as a strong centrifugation of raw milk may remove part of  $\alpha_s$ -caseins, leaving  $\beta$ -caseins unaffected,

defatting by centrifugation must be carried out for a short duration or with light centrifugal force [7]: usually, centrifugation at 4°C at 2000×g for 30 min is sufficient, whereas centrifugation at 8500×g for 15 min at 4° may be excessive, if caseins are the object of the study. Skimmed milk can then be directly diluted with a rehydration buffer containing urea and thiourea (protein denaturants), 3-[(3-cholamidopropyl)dimethylammonio]-1-propanesulfonate (CHAPS, zwitterionic detergent used in protein solubilization), isoelectric focussing (IEF) carrier ampholytes, dithiothreitol (reducing agent), and bromophenol blue (running indicator), and can directly be applied to immobilized pH-gradient (IPG) strips [8,9]. Generally, protein loads on strips are 20–40 µg and after loading, they can be stored at –20°C. Salt concentration must be kept low, as in 2-DE a high content of salts affects the pH gradient, not allowing IPG to reach the equilibrium in the focusing step, leading to nonfocalized spots. This is usually not a problem with milk, owing to its low salt content, whereas for cheeses, that have a high salt concentration, a desalting step must be performed. For example, a cheddar cheese water-soluble extract was desalted and concentrated by dialysis with a molecular cut-off of 3 kDa [10]. In another case, an Emmental cheese sample obtained by hydraulic pressing (Emmental “juice”) was desalted by size-exclusion chromatography [11]. With the latter method, different fractions of the extract can also be obtained, allowing further simplification of the 2D maps on the gel at different MW ranges.

When only caseins are studied (and their high-MW proteolytic products in cheeses), they can also be obtained by precipitation from homogenized cheese in water, by adding 1 M HCl at pH 4.6, followed by centrifugation at 4500×g for 20 min. The casein precipitate is washed thrice with acidic water (pH 4.6) and dichloromethane, and subsequently lyophilized [12]. A desalted protein extract for 2-DE can also be obtained by precipitating proteins with cold acetone, in combination with trichloroacetic acid at a final concentration of 10%, followed by filtration on 0.45 µm filters to clarify the samples.

When whey proteins and peptides are to be studied, fats and part of the caseins can be easily removed from milk by strong centrifugation at 8500×g for 15 min, and can be completely removed by precipitation at pH 4.6 [13]. The whey fraction is mainly represented by β-Lg A, β-Lg B, BSA, α-La, and IgG. The whey proteins extracted can be stored in the IEF stock solution containing urea, dithiothreitol, Triton X-100 (surfactant), IEF carrier ampholytes (pI, 3–10), and bromophenol, in Milli-Q water. This solution is suitable for IPG strip analysis. An ultrafiltration step may be added to this protocol to obtain the milk peptide fraction that can be stored at –20°C.

When low-abundance proteins are to be studied, centrifugation, ultrafiltration, and specific immunoabsorption have to be used to concentrate and select the proteins of interest before 2-DE [14]. In some cases, a very specific removal of the most abundant proteins is necessary and it can be obtained by specifically capturing α<sub>S1</sub>- and β-casein from milk. As α<sub>S1</sub>- and β-casein do not contain cysteines, it is possible to biotinylate the protein mixture with a biotinylating agent that specifically reacts with the cysteine residues, followed by avidin capture. In this way, all the biotinylated proteins can be captured, excluding α<sub>S1</sub>- and β-casein, and can then be regenerated by debiotinylation. By applying this method, it was possible to detect almost 20 forms of κ-caseins at very low concentrations [15]. The β-casein and bovine IgG can also be totally removed from the mixture by using Sepharose columns derivatized with specific antibodies [16].

For studying the proteome of LAB or non-LAB used in fermented dairy products, the strains are purchased or isolated from the dairy source and cultured using specific broth-culturing methods. *Streptococcus thermophilus* cells are isolated from milk, grown on adapted media, and in the exponential phase, washed with sterile ice-cold Tris–HCl containing protease inhibitors, disrupted and centrifuged at 3000×g for 15 min at 4°C to eliminate the intact cells, and centrifuged at 150,000×g for 60 min at 4°C, to collect the cytosolic proteins in the supernatant and the

membrane proteins in the pellets [17]. Analogous sample preparation can, in principle, be used for studying other LAB proteome.

### 5.2.2 *Sample Clean-Up, Preparation, and Storage for LC and CE Analyses*

The dairy sample should be accurately prepared to be analyzed by chromatographic techniques, usually employed for the study of low-MW proteins and peptides (MW < 10 kDa). High-MW proteins and fats are considered as contaminants for the electrophoretic techniques, whereas salts do not generally interfere during these analyses. Therefore, fractionation techniques are needed to remove the high-MW proteins and skimming is always necessary. Thus, low-MW proteins and peptides are extracted in aqueous buffers and separated by selective precipitation and/or ultrafiltration [18]. Many precipitation methods are available [19]: usually whey proteins are extracted from the samples after precipitation of caseins at pH 4.6 by the addition of acetic acid and centrifugation of the supernatant at 3000×g for 30 min. After defatting by extraction with ethyl ether, the aqueous phase is filtered through polyvinylidene fluoride (PVDF) filters and diluted with HPLC-grade water before analysis by liquid chromatography (LC)/ESI-MS. Cheese samples can be homogenized in Milli-Q water and subsequently extracted using a slightly modified extraction method developed in 1982 [20]: grated cheese was mixed with distilled water at a ratio of 1:2 (w/v), homogenized for 5 min at -20°C, and then centrifuged at 3000×g for 30 min at 5°C, to precipitate the insoluble material. The supernatant was subsequently filtered through glass wool and filter paper. The homogenate of grated cheese in water can sometimes be stirred for 1 h at 40°C to maximize the extraction, and subsequently centrifuged at 5°C [21]. Again, selective precipitation of caseins and/or large hydrophobic peptides can be achieved at pH 4.6 or by the addition of 70% ethanol.

Ultrafiltration is largely used, both for desalting and MW selection, but this technique also allows to recover two fractions, the retentate (ideally, MW > nominal cut-off) and the filtrate (ideally, MW < nominal cut-off). These devices are largely used for improving the extracts previously obtained [22].

Less frequently, a preliminary chromatographic separation is utilized: preliminary cation-exchange LC can be useful in case of analysis by CE [23]; anion-exchange LC can be used to fractionate the extract [24], as well as gel-filtration chromatography [25]. Phosphopeptides from cheese can be isolated from the water-soluble cheese extract by cation-exchange chromatography followed by Fe(III) metal-affinity chromatography [21]. In the case of very rich extracts and when the maximum resolution is required, three sequential steps may be used: (1) size-exclusion chromatography (HPLC-grade water); (2) anion-exchange chromatography (phosphate buffer gradient); and (3) semipreparative reverse-phase high-performance liquid chromatography (RP-HPLC, water/acetonitrile gradient) [26].

To study the industrial concentrated dairy products, such as infant-formula milk powders, chemical defatting by a liquid/liquid extraction with a mixture CHCl<sub>3</sub>/MeOH (2:1, v:v) and two chromatographic steps (gel filtration and size exclusion) are necessary before LC-MS analysis [27].

## 5.3 Separation Techniques in Proteomics and Peptidomics

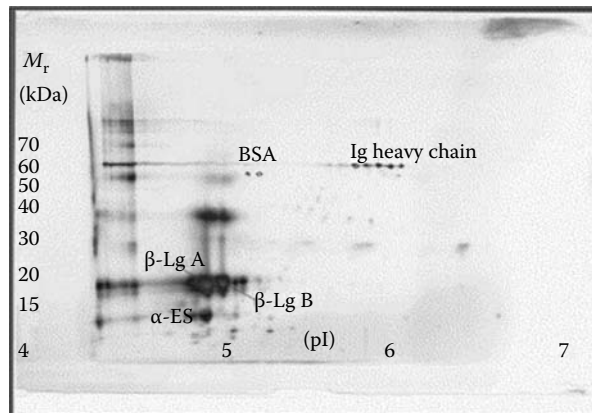
### 5.3.1 *Two-Dimensional Polyacrylamide Gel Electrophoresis*

The 2D-PAGE is an excellent method for the separation of proteins from complex mixtures, such as those present in the dairy products. However, there are significant drawbacks: low-abundance

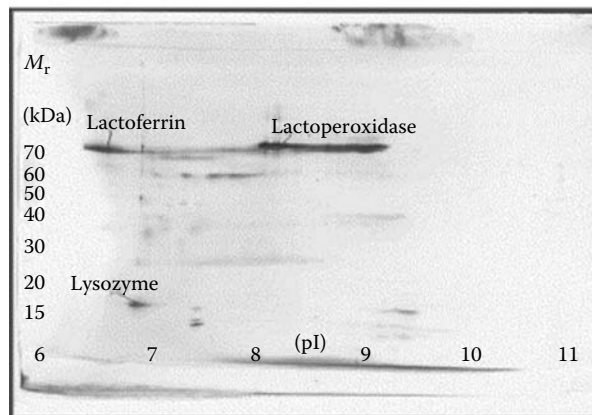
proteins are sometimes not detectable in the presence of high-abundance proteins, and very basic or very acidic proteins are seldom separated.

Given the MWs and the isoelectric points (pIs) of the main dairy proteins, 2-DE is generally performed by using IEF strips with a pH gradient of 3–10, and (precast) polyacrylamide gels could separate the proteins with MWs from 12 to 90 kDa. However, a first-dimension separation with a narrower pH range is often suggested, as the pI values of caseins and the main whey proteins remain in the pH range of 4–6 [13] (Figure 5.1).

A procedure for the 2D-PAGE of milk proteins was first optimized in the late 1980s [7]. According to this procedure, gels for IEF-PAGE were homemade by polymerizing acrylamide



(a)



(b)

**Figure 5.1** 2D-PAGE of individual whey proteins. The gels show MWs and pI of individual whey proteins: (a)  $\beta$ -Lg A and B,  $\alpha$ -La, BSA, and IgG separated using IPG strip at pH 4–7 (linear pH gradient) in the first dimension, and ExcelGel SDS 2D homogeneous 12.5% in the second dimension. (b) Lactoferrin, lactoperoxidase, and lysozyme separated using IPG strip at pH 6–11 (linear pH gradient) in the first dimension, and ExcelGel SDS 2D homogeneous 12.5% in the second dimension. Apparent MW ( $M_r$ , logarithmic scale) and pI are indicated on the vertical and horizontal axis, respectively. (From Lindmark-Mansson, H. et al., *Int. Dairy J.*, 15, 111, 2005.)

in the presence of urea, a nonionic surfactant, and an ampholyte mixture at various percentages, to obtain different pH ranges. The protein solutions extracted from milk were loaded onto the gels for IEF, and focused. The second-dimension SDS-PAGE was performed on homemade 12% polyacrylamide gels in the presence of SDS. After gel-staining with Coomassie Blue, the most abundant milk proteins (caseins,  $\beta$ -Lg,  $\alpha$ -La, and BSA) were clearly visible. Quite interestingly,  $\alpha_s$ -caseins migrate less in the second dimension than  $\beta$ -caseins, apparently indicating a higher MW, which instead is known to be lower, suggesting an anomalous SDS binding to the proteins. The complexity of the caseins spots, differing for their pI, may be accounted for by the micro-heterogeneity of caseins.

Higher resolution in the first dimension, which allowed the detection of many casein forms, was achieved on homemade gels by using high field strengths [28]. In this way, it was possible to separate nonbovine caseins characterized by the presence of different polymorphisms [29]. However, the modern 2D-PAGE makes use of IPG strips that allow obtaining a very high resolution in the first dimension. The power of IPG strips for obtaining high-resolution gels in a narrow pH range has been demonstrated by 2D-PAGE analysis of commercial bovine milk. According to this procedure, two different IEF-PAGE strips were used, one in the 3–10 pH range and the other in the 6–11 pH range. In particular, the latter allowed obtaining a better spot resolution for basic proteins, a poorly studied group in milk proteome. The SDS-PAGE analysis was performed by using 15% SDS-precast gels. After Coomassie Blue staining, about 50 spots could be identified in the former case and 20 in the latter, which were associated with different isoforms of caseins, lactoglobulins, and lactalbumins [30]. The first map gave a general picture of the protein content, in which most spots were observed at acidic pH with a MW around 30–40 kDa, tentatively assigned to  $\alpha_{s1}$ -,  $\alpha_{s2}$ -, and  $\beta$ -casein as well as to their modified forms. On the other hand, only a limited number of spots were present at higher pH in the second map.

A 2D-PAGE performed on bulk whole milk proteins from a single cow, separated in the first dimension with a 24 cm, pH 4–7 IPG strips, and in the second dimension by using 14% SDS-PAGE allowed the detection of many casein isoforms and, in particular, of 10  $\kappa$ -casein isoforms [15]. Furthermore, major whey proteins were also observed.

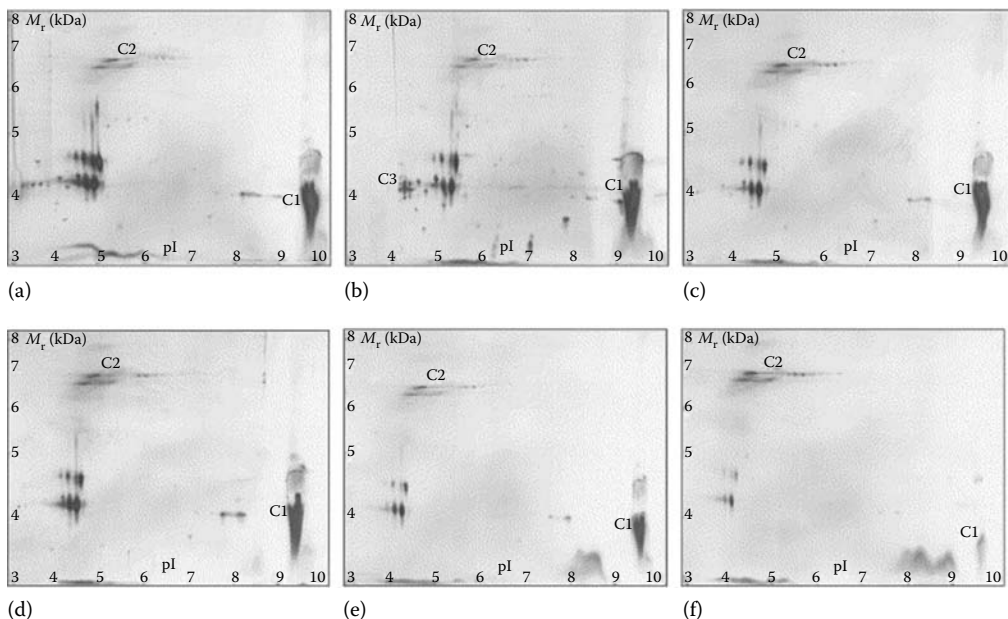
Successful modifications of the standard techniques were used to achieve a better resolution. A procedure based on orthogonal physical properties connected to negative net charge and pI, allowed obtaining a more efficient separation of components belonging to the same family, as opposed to the classical 2D gel combining pI and molecular mass. As a typical example, the phosphoproteome of ovine milk, including many variants of caseins, was extensively characterized by this type of 2-DE [31]. Casein phosphorylation is very important for calcium binding and micelle formation, and therefore it is relevant to study the phosphorylation changes of caseins. The 2D separation was carried out by combining the 1D discontinuous polyacrylamide gel electrophoresis (Disc-PAGE) from the first dimension, with IEF on the thin-layer polyacrylamide gel (PAGIF) in the orthogonal dimension. A strip of unstained gel of the first dimension was excised along the direction of the first run, equilibrated in a solution containing ampholine (pH 3.5–8), and laid in the acidic region of the prefocused gel parallel to the cathode. Under the voltage applied, proteins were transferred from the PAGE onto the IEF gel. In this way, a highly efficient separation was achieved, allowing the separation of the single caseins (including nonallelic, differently phosphorylated, and glycosylated forms) in multiple spots differing for their phosphorylation degree.

Improvement of 2D-PAGE sensitivity and/or resolution mainly relies on the techniques used for preparing the samples mentioned earlier. For example, selective absorption and removal of the most abundant proteins sheds light on the minor proteic components of milk: almost 30 low-abundance proteins were identified in bovine colostrum and mature milk [16], by using

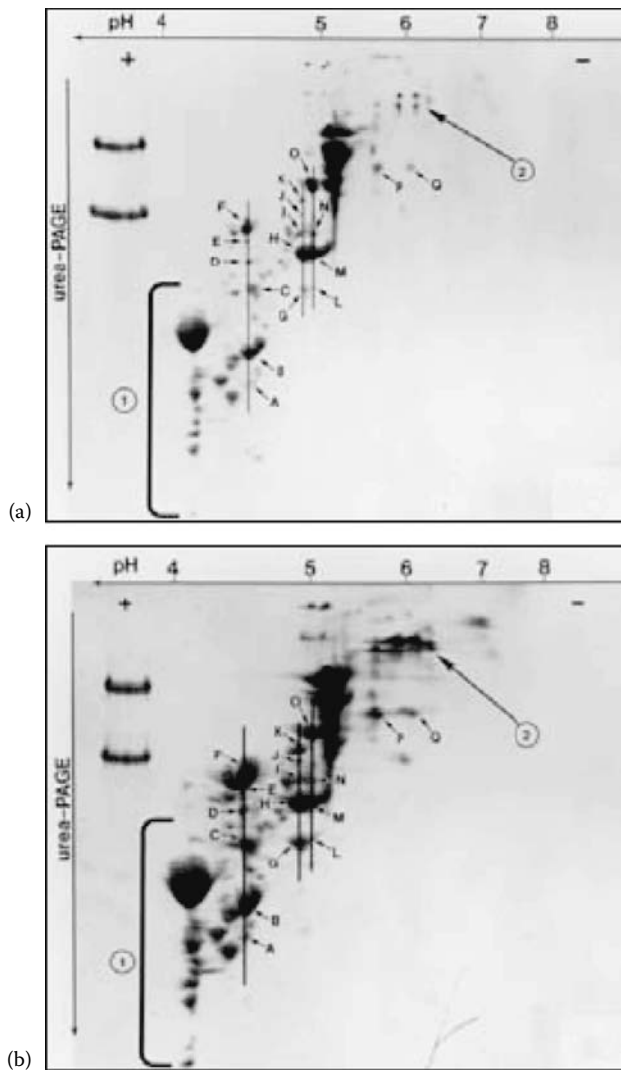
very specific clean-up methods (immunoabsorbent columns), IPGs with nonlinear (NL) gradient between pH 3 and 10, and second dimension 10%–20% SDS-PAGE. In another case, prefractionation by IEF using a Rotofor in a pH gradient of 3–10 of skimmed milk proteins yielded 20 fractions that were subsequently singularly analyzed by urea-PAGE and SDS-PAGE [32], allowing a better resolution.

Furthermore, high-MW peptides, naturally present in milk, are of major importance for the dairy industry because of their functional properties, can be investigated by 2D-PAGE. The nitrogen fractions between 3 and 8 kDa can be analyzed after IEF focusing, by using homogeneous gels with increased thickness of the separation zone (15% of the total gel thickness) for the SDS-PAGE, demonstrating that gel separation can also be used for nitrogen components below 10 kDa [13]. The peptides extracted from the samples of colostrum from the first to the sixth milking postpartum are reported in Figure 5.2, where it is evident that their number decreases markedly postpartum. Thus, this technique is very useful for studying protein and peptide variations in connection with heat treatments, storage, and lactation.

A good alternative for improving resolution of low-MW peptides is represented by urea-PAGE in the second dimension. This technique was applied successfully to monitor proteolysis in cheese during ripening, thus demonstrating its full feasibility for separating the proteolytic fractions in different types of Cheddar cheeses (Figure 5.3) [10,12].



**Figure 5.2** 2-DE of peptides in permeate samples from ultrafiltered colostrum. The gels show MWs and isoelectric points (pI) of permeate samples of colostrums: (a) first milking; (b) second milking; (c) third milking; (d) fourth milking; (e) fifth milking; and (f) sixth milking postpartum. The samples were separated using IPG strip at pH 3–10 (linear pH gradient) in the first dimension, and ExcelGel SDS 2D homogeneous 15% in the second dimension. Apparent MW (logarithmic scale) and pI are indicated on the vertical and horizontal axes, respectively. (From Lindmark-Mansson, H. et al., *Int. Dairy J.*, 15, 111, 2005.)



**Figure 5.3** Two-dimensional (IEF followed by urea-PAGE) gel electrophoretograms of (a) full-fat and (b) reduced-fat Cheddar cheeses ripened at 8°C for 6 months. (From Chin, H.W. and Rosenberg, M., *J. Food Sci.*, 63, 423, 1998.)

Another interesting field related to dairy foods is the application of proteomic techniques to LAB, widely used in the food industry. The most important goal of the proteomic approach with regard to these organisms is mainly to obtain reference 2D-PAGE maps of the bacterial proteomes, to have a full characterization of the strains for a better understanding about their survival, resistance against bacteriophages, effects on the taste of the products, and acidification ability. However, in contrast to milk, bacterial proteomes are hugely complex, and only a small fraction of the total expressed proteins can be expected to be visualized by 2D gels. *S. thermophilus* is a LAB widely used for the production of fermented dairy products. The 2-DE protein profile allowed the



detection of about 270 spots after silver staining [33]. Moreover, a reference gel of *Lactococcus lactis* allowed the visualization of 450 silver-stained spots on 2D-PAGE, after focalization on a pH gradient of 4–7 [34]. Comparison with the complete theoretical proteome as detected by the genome sequencing of the bacterium (2310 possible proteins), evidenced that only a small fraction of the proteins can be visualized by standard 2D-PAGE, and in particular, high- and low-MW proteins cannot be observed simultaneously with this technique.

### 5.3.2 *Capillary Electrophoresis*

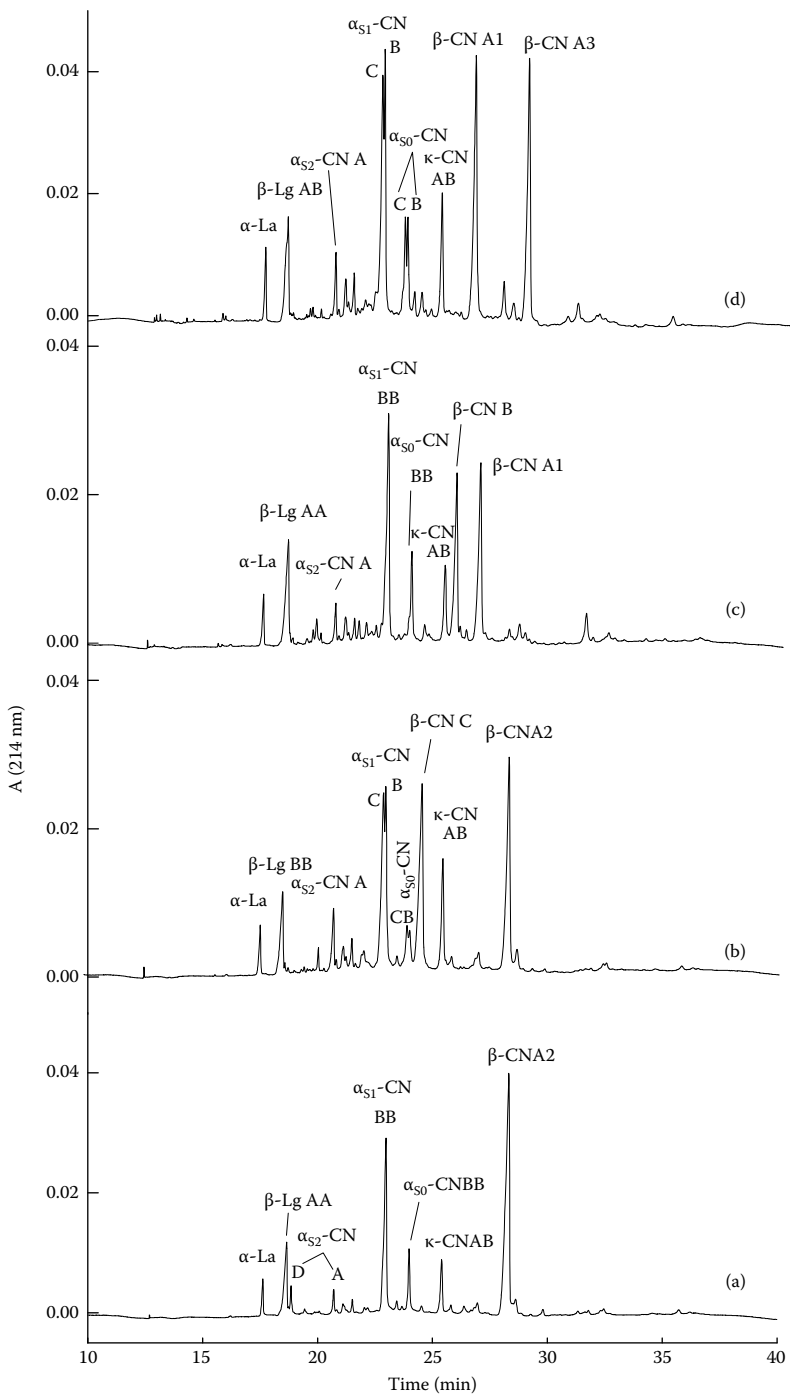
CE can be considered as a good alternative to 2D-PAGE for the analysis of the most abundant milk proteins, which can be exploited for the quality control of dairy products. When compared with HPLC, which is most efficient for low-MW peptides, and 2D-PAGE, which is at its best for high-MW compounds, CE allows the simultaneous analysis of nitrogen components of any size, although at a lower sensitivity than 2D-PAGE. In fact, the possibility of obtaining reliable quantitative data with high sensitivity and peak identification still remains problematic in CE, hampering its widespread use. Nevertheless, when compared with HPLC, CE provides the advantage of requiring only very small amounts of protein/peptide (down to the nanogram level).

The determination of milk proteins by capillary zone electrophoresis (CZE) can be strongly affected by the absorption of solutes on the capillary wall, requiring the use of hydrophilic coated capillaries. The effects of pH, ionic strength of the running electrolyte and polymeric additives were studied to obtain separations of cows', goats', and sheeps' milk proteins as well as heat-damaged caseins. The most abundant milk proteins were separated in an untreated fused-silica capillary, using phosphate buffer at pH 7.0, 4 M urea, or a highly concentrated borate buffer at pH 10.0. Better results were obtained by using a hydrophilic coated capillary and a low phosphate buffer at pH 2.5 in the presence of 6 M urea, which disrupts the casein micelles, a reducing agent, and methylhydroxyethylcellulose [35]. Thus, a complete separation of the whey proteins and caseins, including some variants of ovine and bovine caseins, was obtained.

Alternatively, the main whey proteins ( $\alpha$ -La,  $\beta$ -Lg A and B variants, BSA, IgG) can be resolved at pH 9.2, with a borate buffer and the use of a chemically deactivated capillary ("silanized") in the presence of organic modifiers, for preventing adsorption on the wall. Although the method has some restrictions owing to the genetic variability of the milk samples and to the heat-lability of whey proteins, it can be used for determining the presence of cows' milk in products labeled as "pure water-buffalo milk" [36].

Moreover, denaturation of whey proteins is a good marker for the evaluation of the thermal treatment of milk. Whey proteins in cows' milk, subjected to different heat treatments (pasteurization, UHT), were analyzed by both CE and HPLC [37]: it is generally accepted that the latter provides a better reproducibility than CE.

Genetic variants of caseins from different species may be analyzed by CE on a hydrophilic coated fused-silica capillary column by using a low pH buffer containing urea, after collecting the fractions from a cation-exchange FPLC separation [23]. The identification of different genetic variants in whole cows', ewes', and goats' milk can be carried out with UV detection at 214 nm by sample spiking. Excellent separation of protein variants with different charges at pH 3 can be achieved (different degrees of phosphorylation or variants that differ only in a single amino acid with a different charge). Figure 5.4 shows the capillary electropherograms of four individual whole bovine milk samples containing different variants of  $\beta$ -Lg,  $\alpha_{S1}$ -CN,  $\alpha_{S2}$ -CN, and  $\beta$ -CN. Mutations leading to amino acid deletion occur only in  $\alpha_{S1}$ -CN A and  $\alpha_{S2}$ -CN D (Figure 5.4a). Five genetic variants of  $\beta$ -CN were



**Figure 5.4** Capillary electropherograms of four whole individual bovine milk samples: the different casein variants can be separately detected. The description of a–d electropherograms is reported in the text. (From Recio, I. et al., *J. Chromatogr. A*, 768, 47, 1997.)

identified: the  $\beta$ -CN C presented a shorter migration time (Figure 5.4b) than  $\beta$ -CN B (Figure 5.4c), owing to the substitution of two amino acids, Glu and Arg, with Lys and Ser, respectively. It was possible to detect proteins with different degrees of phosphorylation owing to the post-translational modifications, up to  $\alpha_{s1}$ -CN(9P), and  $\alpha_{s1}$ -CN(8P) (Figure 5.4d). However, when the variants do not involve a change in the net charge of the protein at pH 3.0, they cannot be separated.

The method was improved by performing the separation with a citric acid–citrate–urea buffer at pH 2.3 containing 4.8 M urea, which allowed complete separation of  $\beta$ -Lg and *para*- $\kappa$ -casein [38]. The improved method was also applied to the analysis of the protein fraction of a processed cheese. The two methods are compared in Figure 5.5: under the new conditions, denatured  $\beta$ -Lg was well-resolved from *para*- $\kappa$ -CN, which could be quantified more easily (Figure 5.5b).

Essentially, the same method can be applied for the separation of ovine  $\kappa$ -casein isoforms [39]. A CZE method recently published makes use of a fused-silica deactivated capillary for determining the protein concentrations and phosphorylation states of  $\alpha$ -La,  $\beta$ -Lg,  $\alpha_{s2}$ -casein,  $\alpha_{s1}$ -casein,  $\kappa$ -casein, and  $\beta$ -casein in milk [40]. This method allows the separation of isoforms of  $\alpha_{s2}$ -casein containing 10, 11, or 12 phosphate groups, and the isoforms of  $\alpha_{s1}$ -casein containing eight or nine phosphate groups. Furthermore, the more common  $\kappa$ -casein variants can also be separated. The method allows determining the variation of the relative concentration of the main milk proteins and the phosphorylation states of caseins among individual cows.

Although the number of proteins that can be separately detected by CE is usually lower than that obtained by 2D-PAGE, and although the sensitivity limits the applications only to the most abundant proteins in milk, this technique can be particularly useful for monitoring process-induced protein modifications and milk authenticity. Storage conditions [41] or the presence of cows' milk in non-bovine milks [42,43] can be determined by whey protein analysis. A CE/MS method [44] has been proposed for the detection of protein lactosylation, to assess the degree of thermal treatment of milk.

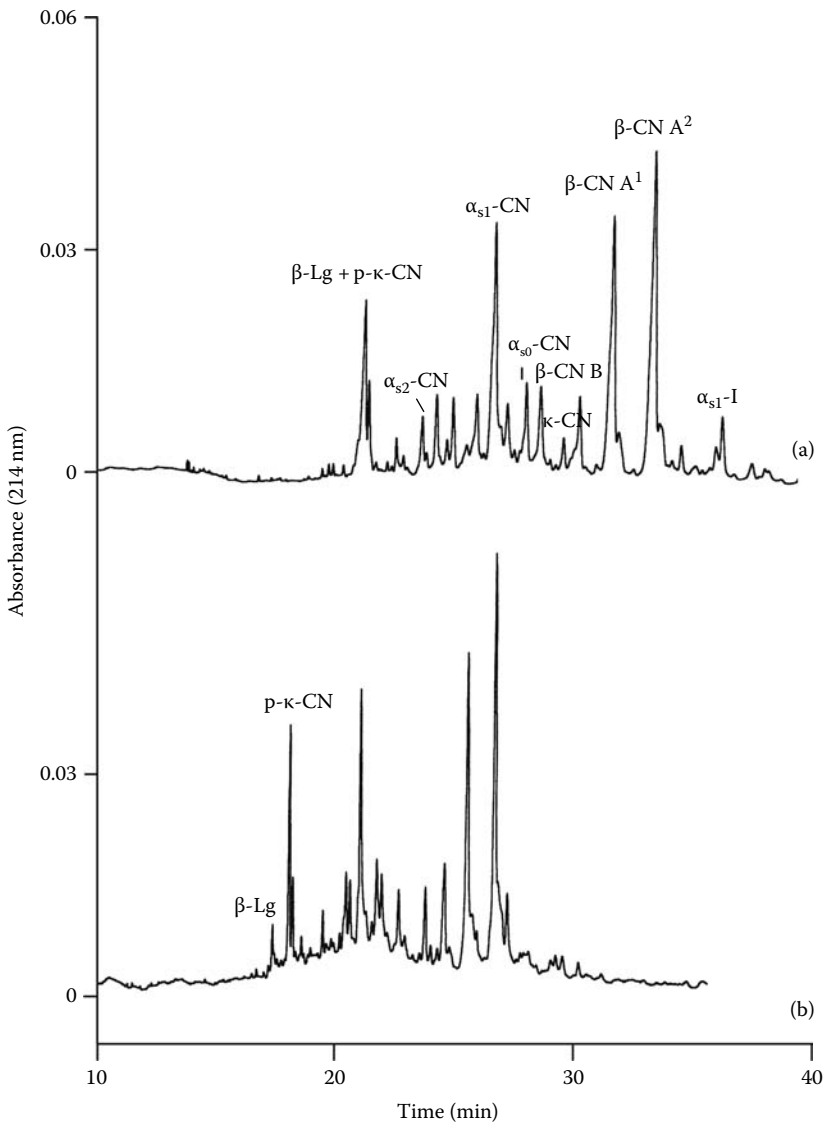
More sophisticated capillary electrophoretic methods, such as micellar electrokinetic chromatography, can also be used for milk-protein separations [45]. Using micellar electrokinetic capillary chromatography with borate–SDS buffer, it was possible to simultaneously separate caseins, peptides, several free amino acids, and small aromatic molecules, allowing the detection of phosphate-soluble Cheddar cheese fractions [46].

Proteolytic peptides in dairy products were also successfully analyzed by using CE. By using a buffer containing citrate/phosphate (pH 3.3), 4 M urea, and a polymeric additive in a coated capillary, qualitative and quantitative analysis of proteins and peptides in milk, cheese, and whey products was achieved, whereas separation in a citrate/phosphate buffer (pH 2.8) and a bare silica capillary turned out to be well-suited for the analysis of small, casein-derived peptides in aqueous cheese extracts [47].

Recently, the major peptides produced by the hydrolysis of water-buffalo casein with plasmin have been characterized by CE and MS, and compared with their bovine homolog. A novel breakdown product arising from the hydrolysis of water-buffalo P-caseins, obtained by the presence of a plasmin-sensitive Lys bond at position 68 was identified, which was not present in bovine  $\beta$ -casein. On the basis of this evidence, an improved procedure for the differentiation of bovine and water-buffalo products was established [48].

### 5.3.3 *High-Pressure Liquid Chromatography*

Although HPLC techniques can be used to separate proteins, their use in proteomic applications for the direct analysis of intact proteins in complex mixtures is extremely rare. The main problem is concerned with the identification of proteins, as several techniques widely used for protein separation



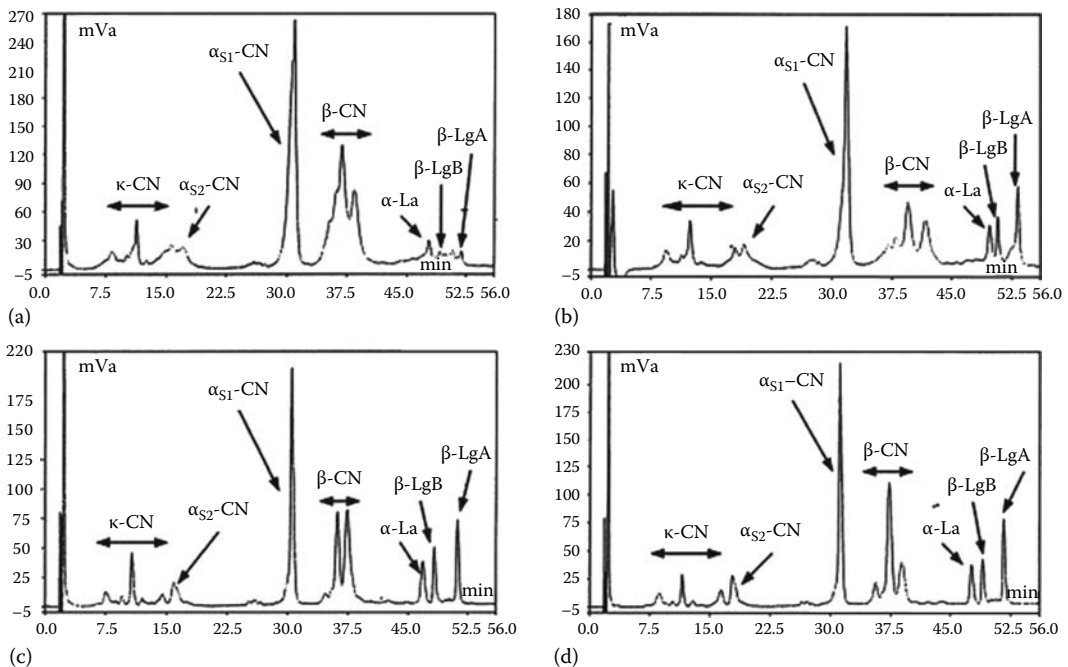
**Figure 5.5** Electropherograms of a processed cheese analyzed with an electrophoresis buffer containing: (a) 6 M urea and 0.19 M citric acid–20 mM sodium citrate, pH 3.0; (b) 4.8 M urea and 0.48 M citric acid–13.6 mM sodium citrate, pH 2.3; separation voltage 25 kV. (From Miralles, B. et al., *J. Chromatogr. A*, 915, 225, 2001.)

(such as ion-exchange and hydrophobic interaction chromatographies) cannot be easily associated with mass spectrometric detection owing to the high salt content. On the other hand, gel permeation does not ensure a sufficient resolution of complex protein mixtures. Finally, standard reversed-phase (RP) LC, which can be easily interfaced with MS, often does not provide an efficient separation of complex protein mixtures, besides the fact that ESI-MS sensitivity is low for high-MW proteins. Thus, protein determination by HPLC is limited to the analysis of the major milk proteins.

One of the early investigations that used HPLC for separating *para*-caseinate and whey proteins from skimmed milk was carried out on a  $C_8$  column, by using water/acetonitrile gradients with 0.1% trifluoroacetic acid [49]. The method, easily interfaced with an ESI-MS detector, allowed the separation and detection of caseins and whey-protein variants according to their molecular masses. The RP-HPLC analysis was performed after milk dissolution in a buffer containing urea (6M) and a reducing agent (e.g., mercaptoethanol or dithiothreitol) to disrupt the micelles and improve the separation. As the analyte signal may be suppressed under these conditions during the ESI process, the eluent was bypassed from the electrospray source following sample injection until urea and dithiothreitol were eluted.

A pre-purification of the samples by gel permeation improved the resolution of the proteins, allowing to distinguish protein variants as well. This approach, in combination with  $C_{18}$  or  $C_4$  columns, has been used for the analysis of ovine [50] and caprine milk proteins [51,52]. Moreover, an optimized method performed on a  $C_4$  column was able to separate the major milk proteins without a pre-purification step [53]. A chromatogram showing the separation of a mixture of standard milk proteins is shown in Figure 5.6. Such a method can be used for the rapid assessment of the quality of several types of commercial and raw bovine milks.

Substitution of trifluoroacetic acid with formic acid in the eluent is particularly advisable to avoid ion-suppression effects in ESI-MS, specifically of  $\alpha$ -La, which is particularly sensitive to trifluoroacetic acid-induced suppression [54].



**Figure 5.6** RP chromatographic profiles of several types of commercial and raw bovine milks: (a) milk powder; (b) half-skimmed UHT milk; (c) half-skimmed pasteurized milk; and (d) raw milk. (From Bordin, G. et al., *J. Chromatogr. A*, 928, 63, 2001.)

Furthermore, ion-exchange HPLC can be applied for the analysis of milk proteins [55], although the high salt content in the eluent prevents the interfacing of mass spectrometers, somewhat limiting its utility.

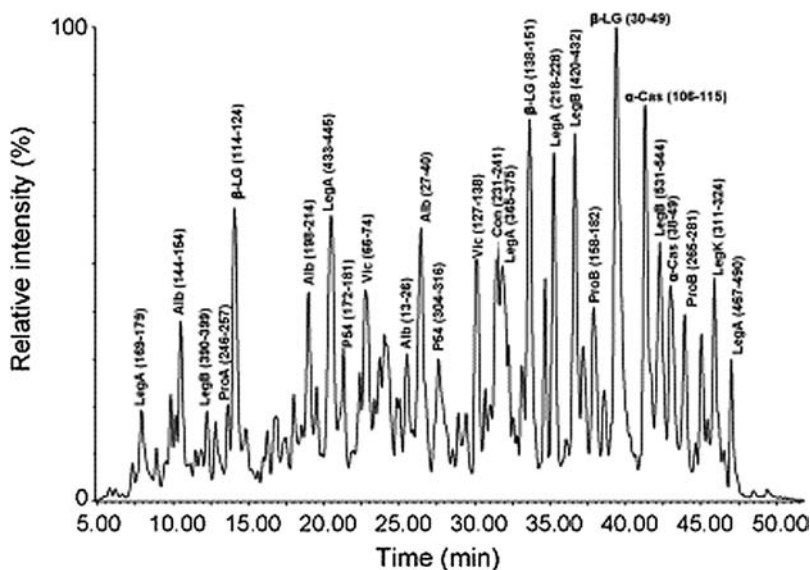
HPLC is also very useful for the determination of small peptides. In this case, the standard conditions commonly used in RP-HPLC (a water/organic eluent mixture with an acidic modifier) are also optimal for ESI-MS interfacing, thus allowing the hyphenation of the techniques. Moreover, the resolving power of RP-HPLC for smaller peptides is usually very high, perfectly complementing the low resolution of low-MW compounds usually obtained by 2D-PAGE. Lastly, the possibility to directly interface the HPLC eluate with an electrospray source allows performing a rapid characterization of peptides by MS: thus, it is also possible to extract reliable information on peptide mixtures not completely separated by chromatography, as the molecules of interest, even if superimposed, can be selectively analyzed by mass spectrometric techniques. Peptide analysis by HPLC has been applied to dairy proteomics mostly concerning two different aspects: analysis of the tryptic digests obtained from milk proteins and analysis of the peptides arising from the natural proteolysis occurring in dairy products, mainly cheeses.

Bovine skimmed milk, whey, and milk fat globule membrane proteins can be digested with trypsin, and the tryptic peptides can be separated on a standard  $C_{18}$  column by using water/acetonitrile mixtures with 0.5% acetic acid as eluents [56]. HPLC coupled to MS can be used to evaluate milk adulteration through the analysis of milk proteome. NanoLC/ESI-tandem mass spectrometry (MS/MS) has been used to detect plant proteins in adulterated skimmed milk powder (SMP), which is an illegal practice and which cannot be easily detected by the official CZE method [57]: after an additional enrichment step based on a borate treatment for the reliable detection of low-level plant proteins, tryptic digestion of the entire protein fraction from the adulterated SMP allowed the detection of many peptides originating from the major seed proteins of soy (glycinin, conglycin) and pea (legumin, vicilin), along with those arising from milk proteins that could be identified by MS/MS analysis (Figure 5.7).

Indeed, the most important field of application of HPLC analysis of peptides has been in peptidomic applications, directed to the study of the peptide pattern in dairy products, particularly in fermented milk cheeses. Although separation of such complex mixtures usually yields very complex chromatograms in standard RP-HPLC ( $C_{18}$  columns with acidified water/acetonitrile mixtures as eluents), the use of mass spectrometric detection allows to gain information even on low resolved chromatographic peaks.

Several examples of analyses of proteolytic peptides of Parmigiano-Reggiano cheese, both the acid-insoluble [58] and acid-soluble [59] fractions, have been reported: by interfacing with ESI-MS, it was possible to identify the molecular mass of a number of peptides. After purification of the selected fractions, also performed by RP-HPLC, peptides were identified by Edman sequencing and compared with the known casein sequences. The RP-HPLC analysis of peptides may provide valuable information about the proteolysis and the ripening time of cheese [60].

To improve the separation, several methods to pre-purify the peptide fractions before the RP-HPLC analysis were developed. The water-soluble extract of cheeses were fractionated by diafiltration using 10 kDa cut-off membranes: the diafiltrate retentate was further separated by ion-exchange chromatography on DEAE-cellulose with a linear NaCl gradient at pH 8.6, and by FPLC [61,62]. Alternatively, after diafiltration with 10 kDa nominal MW cut-off membranes, the permeate was resolved into fractions by gel-permeation chromatography on Sephadex G-25 [63]. Peptides were isolated by RP-HPLC and characterized by N-terminal amino acid sequencing and MS. The use of formic acid (50 mM) as the gel-permeation eluent gives a different fractionation of



**Figure 5.7** Chromatogram of the borate pellet from an adulterated skimmed milk powder. Five microliters of tryptic digest from 2.5 mg of adulterated milk powder, were injected for each LC–MS run. Assigned peaks correspond to peptides (with sequence numbering between the brackets) from  $\beta$ -lactoglobulin ( $\beta$ -Lg),  $\alpha$ -casein ( $\alpha$ -Cas), glycinin (G1, G2, G4),  $\beta$ -conglycinin (Con $\alpha$  and Con $\beta$ ), lipoxygenase (Lip1-3), legumin (LegA, LegB, LegK), albumin (Alb), provicilin (ProA and ProB), P54 protein (P54), vicilin (Vic), and convicilin (Con). (From Luykx, D.M.A.M. et al., *J. Chromatogr. A*, 1164, 189, 2007.)

the cheese peptides than that obtained with distilled water, which is particularly evident in the separation of low-MW peptides [64]. Trifluoroacetic acid in the eluent can be substituted by formic acid without the loss of separative efficiency, with the advantage of being more ESI-MS compatible [65].

## 5.4 Identification Techniques in Proteomics and Peptidomics

### 5.4.1 Identification by Non-MS-Based Techniques

The identification of proteins in a given proteome mainly relies on MS to achieve partial or total sequence information on the separated proteins. However, for some selected applications in dairy studies, it is possible to use different methods, in particular, immunoblotting and UV detection.

Caseins can be visualized by immunospecific detection with  $\beta$ -casein antiserum [66] or polyclonal antibodies against  $\alpha_{s1}$ -casein [67], while  $\alpha$ -La and  $\beta$ -Lg bands can analogously be identified on a 1D or 2D gel [68]. Such techniques can be useful for the rapid detection of many strictly related isoforms of the same protein, but they do not provide indications, in the presence of multiple reactive bands, about the chemical nature of the isoforms. Identification of allergens in the milk proteome can be loosely associated with this group of identification techniques, as it relies on the specific reactivity of some protein bands with antibodies (human IgE) [8] or specific mono- or polyclonal antibodies [69]. In any case, the true molecular identity of the allergen must subsequently be assessed by MS.

Detection by UV spectroscopy can be employed for caseins and whey proteins as well as derived peptides owing to the presence of aromatic amino acids (Phe, Tyr, Trp) in their structures [60]. However, the peaks can be identified and quantified only when authentic specimens of proteins are available [23].

#### 5.4.2 Identification by MALDI-MS

MALDI-MS is usually employed after gel separations to assess the protein identity. The most commonly utilized method is the peptide mass fingerprint (PMF) [70]. According to this method, the stained band (or spot) is cut from the gel, the protein is destained (each staining method has its peculiar destaining procedure), and digested with specific enzymes (usually trypsin). Subsequently, the derived peptides are extracted (usually, by an acidified mixture of acetonitrile and water) and prepared for MALDI analysis. This step usually includes a concentration-desalting step. Finally, the molecular masses of the tryptic peptides are determined by MALDI-MS. By software processing of the spectrum, the list of the (exact) masses of the derived peptides is obtained. A protein database [71] performs the simulation of the digestion on the available proteins, compares the theoretical MWs with the obtained mass list, and the most-likely identification of the protein corresponding to the originally stained band is indicated. The matching score and the percentage of coverage are the values that should be primarily taken into account for a good assignment. Great accuracy in measurements is obviously an essential requirement for the correct matching of the peptides with the protein.

In a typical procedure, the 2D spots stained with Coomassie Brilliant Blue G-250 are manually excised with a clean scalpel, placed in an Eppendorf tube, and washed twice with 50  $\mu\text{L}$  water. Each gel piece is completely destained by immersion into a solution of 50 mM  $\text{NH}_4\text{HCO}_3$  in 50% (v:v) aqueous acetonitrile. The destained spot is then dehydrated by immersion into acetonitrile, and dried under vacuum after acetonitrile removal. The dried gel piece is then covered with 30  $\mu\text{L}$  of 50 mM  $\text{NH}_4\text{HCO}_3$  (about 5  $\mu\text{L}/\text{mm}^3$ ) containing 12 ng/ $\mu\text{L}$  of trypsin maintained in an ice-cold tube. After 45 min, the supernatant is removed and incubated overnight at 37°C. The resulting tryptic digest is extracted in 40  $\mu\text{L}$  of an acetonitrile/5% formic acid solution (1:1, v:v), and then concentrated to one-tenth in a vacuum centrifuge for the mass spectrometric analysis. The tryptic-digest solution (1  $\mu\text{L}$  opportunely desalted) from each extracted spot is loaded on a stainless-steel MALDI plate along with 1  $\mu\text{L}$  of the MALDI matrix solution ( $\alpha$ -cyano-4-hydroxycinnamic acid, 10 mg in 1 mL of 50% acetonitrile/50% water, or 3,4-dihydroxybenzoic acid, 10 mg in 1 mL of water). Mass spectrum acquisition can be performed both in the negative and positive mode by applying an external mass calibration with low-mass peptide standards [31], and preferably with internal standards also (typical trypsin autolysis peaks can be used for this purpose).

An alternative destaining method can include the immersion of the gel in 1% (v/v) acetic acid, until a low background is achieved. After tryptic digestion at 37°C for 16 h in gel, the tryptic peptides can be analyzed by MALDI-MS [16]. The PMF of in-gel tryptic digests by MALDI MS (with  $\alpha$ -cyano-4-hydroxycinnamic acid as the matrix) can determine the modifications of milk proteins in a milk powder [72].

Basic proteins with low molecular masses (<12 kDa), which are commonly present in milk samples, are usually difficult to identify. However, by this method, it was possible to resolve the multiple forms of caseins from whole milk, from both bovine [30] as well as other mammals [73]. In this case, MALDI-MS can also be utilized in the linear mode, using sinapinic acid as matrix, to reveal a large tryptic peptide (mass > 5990 Da) derived from the C-terminus of  $\kappa$ -casein that



contains all the known sites of genetic variants, phosphorylation, and glycosylation [15]. Genetic variants containing one or two phosphate groups as well as glycoforms containing a single acidic tetrasaccharide can be distinguished using mass data alone.

PMF is also a key point as far as LAB-proteome identification is concerned. A reference map of alkaline lactococcal proteins was made by using 2-DE of the extracts obtained from the exponentially growing cells [74]. In the first dimension, IPG spanning from pH 6 to 12 and from 9 to 12 was used, with *N,N*-dimethylacrylamide as monomer, whereas standard SDS-PAGE was applied for the second dimension. Protein identification by PMF with MALDI-TOF enabled the identification of 153 proteins, products of 85 different genes. Ribosomal proteins with unknown functions represented the largest groups of identified proteins. The cell-free extract of the *Lactobacillus helveticus* strain ITG LH1 was analyzed by 2D-PAGE, using IPG dry strips (pH 4–7), followed by protein digestion with trypsin, analysis by MALDI-TOF-MS, and subsequent database searches using PMF [75]. Among the most abundant proteins, seven peptidases were also found, namely the two general aminopeptidases (PepN, PepC), three dipeptidases (PepDA, PepV, PepQ), and two endopeptidases (PepO, PepO3), all of them corresponding to the catalytic classes of metallo- or cysteine-peptidases. Several stress proteins and other enzymes involved in bacterial metabolism were also identified. In the most recent approaches to bacterial proteomes, wider pictures have been obtained by combining PMF MALDI-based methodologies with MS/MS structural determination by ESI instruments. Examples have been reported for the study of *Bifidobacterium longum* [76] and *S. thermophilus* [17].

As an alternative to PMF, after 2D-PAGE, the intact protein can be extracted by passive elution (the gel spot is cut, crushed, and the protein is extracted with 50% formic acid, 25% acetonitrile, 15% isopropanol, and 10% water in an ultrasonic bath). The extracted protein can be directly analyzed by MALDI-TOF, thus allowing the evaluation of protein modifications (hence, milk quality) after milk lyophilization [72].

Finally, and quite interestingly, MALDI-TOF can also be exploited as a stand-alone technique, not only in combination with gel separation of proteins, to obtain a quick picture of milk proteome. The MALDI analysis of milk proteins has been shown to be useful to investigate the thermal damage undergone by milk proteins during pasteurization and sterilization industrial processes [77], to characterize milk from different breeds of cows and different mammals [78], to characterize water-buffalo mozzarella cheese with respect to bovine mozzarella cheese [79], to identify adulteration in water-buffalo mozzarella and ewe cheese with other milks [80], and to determine the percentage of bovine milk fraudulently added to ewe milk in the production of marketed ewe cheese [81].

These examples are based on the comparison of the protein profiles obtained by MALDI in different samples. Sinapinic acid in saturated solution of acidified water:acetonitrile is used as the matrix, and the instrument is often used in the linear mode. In this kind of studies, a calibration curve is often required, for example, for determining the percentage of bovine milk added to ewe milk.

MALDI-MS has also been used to study the peptide fraction of cheeses: in these cases, given the lower MW of peptides, MALDI-TOF is usually utilized in the reflector mode. As far as the MALDI matrix is concerned,  $\alpha$ -cyano-4-hydroxycinnamic acid in 50% (v/v) acetonitrile/water containing 0.5% trifluoroacetic acid is suitable for detecting the peptides present in the pH 4.6-soluble and 70% ethanol-soluble fraction of several cheeses. If a very accurate molecular mass determination is achieved, then the identity of peptides is easily assessed, and thus, it is possible to recognize the nature of the enzymes that generated them, according to their known casein cleavage specificities: chymosin, plasmin, and enzymes from starter, nonstarter, or secondary microflora in caseins. This approach, combined with multivariate statistical analysis for data handling, allowed the identification of the proteolytic pattern of different cheeses [82].

### 5.4.3 Identification by ESI-MS

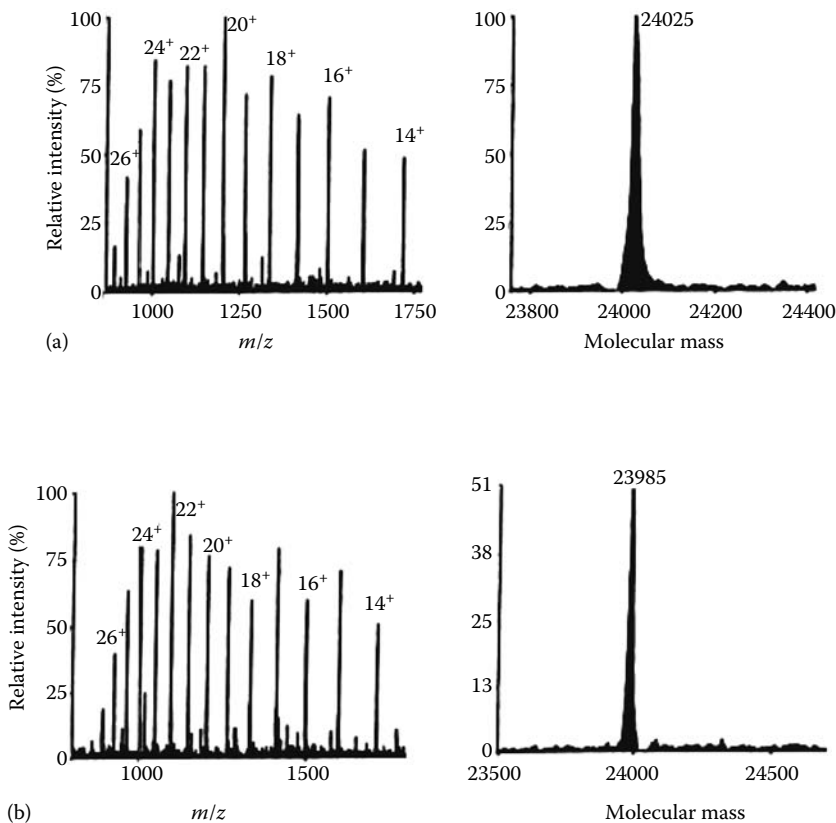
ESI-MS is largely utilized in dairy food proteomic characterization. In particular, ESI-MS linked to HPLC allows examining all the major bovine milk proteins, including caseins ( $\alpha_{S1}$ -,  $\alpha_{S2}$ -,  $\beta$ -, and  $\kappa$ -caseins) and whey proteins ( $\alpha$ -La,  $\beta$ -Lg, BSA).

ESI-MS is useful to study the complex protein systems associated with genetic polymorphisms, post-translational changes (phosphorylation and glycosylation), and multiple isoforms [49,50] (Figure 5.8).

In particular, LC/ESI-MS also allows the analysis of the native and lactosylated forms of the major whey proteins in commercial bovine milk samples of different brands subjected to different thermal treatments (pasteurization and UHT), to be used as markers for the thermal history of milk [54,83].

Using HPLC-ESI-MS, it was possible to quantify goats' milk adulteration in cows' milk by monitoring the major whey proteins, making use of a calibration curve obtained by considering the ratio between  $\beta$ -Lg variant B +  $\beta$ -Lg variant A (from cows' milk) and the total lactoglobulins in cows' and goats' milk [84].

The ESI-MS can also be used for monitoring the charge-state distribution (CSD) of milk proteins, which is related to their conformation. As a significant example, the effects of different



**Figure 5.8** ESI-MS spectra (left) and reconstructed spectra (right) of  $\beta$ -CN variants A1 (a) and A2 (b) after RP-HPLC separation. (From Léonil, J. et al., *Lait*, 75, 193, 1995.)

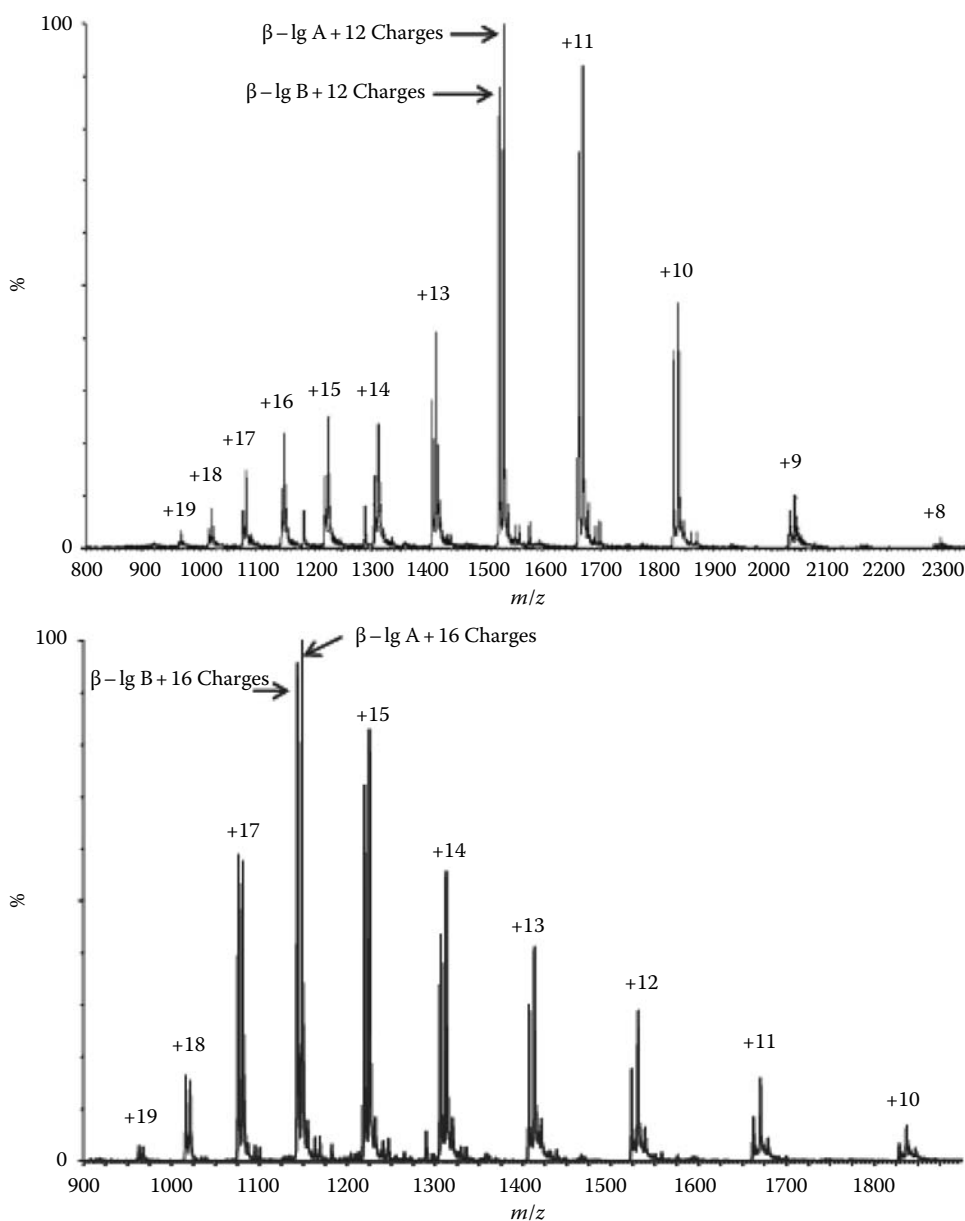
high-pressure (HP) treatments (pressures ranging between 450 and 650 MPa) on  $\beta$ -Lg and  $\alpha$ -La, and on two commercial whey-protein isolates have been examined by ESI-MS: HP treatment resulted in substantial changes in the CSD of pure lactoglobulin, ascribable to the exposure of side-chains of buried amino acids to solvent, whereas the CSD of pure lactalbumin was largely insensitive to HP treatment [85] (Figure 5.9).

In any case, ESI-MS, either coupled to LC or used alone, is at its best in the analysis of small peptides, such as those deriving from tryptic digestion. In the last generation instruments, sensitivity has been largely improved, allowing the analysis of samples in the femtomolar range, in particular, when the *nano*ESI geometry is used: now, the performances of these ESI instruments are often comparable with those obtained by MALDI, traditionally, the most sensitive technique. Moreover, MS/MS experiments, aimed at sequencing the peptides derived from the enzymatic digestion of the protein of a 2D gel spot, are usually made simpler by using ESI (usually by a Q-TOF analyzer), rather than by MALDI (TOF-TOF analyzer), and have lower interferences (in MALDI, Coomassie or matrix clusters can make the measurements more difficult). The exact mass determination provided by the last generation of ESI-MS instruments has become an invaluable tool for the rapid identification of peptides arising from tryptic digests even in very complicated mixtures.

For example, nanoESI-MS/MS analysis can be applied for the identification of casein components and definition of the phosphorylated sites in casein spots isolated by 2D-PAGE. This methodology ensured identification of more than 30 phosphorylated proteins, 5  $\beta$ -, 15  $\alpha_{S1}$ -, 10  $\alpha_{S2}$ -, and 4  $\kappa$ -casein components, including nonallelic, differently phosphorylated, and glycosylated forms [31]. In the already-cited detection of plant proteins in adulterated SMP by nanoLC/ESI-MS/MS [57], a Q-TOF mass spectrometer was set in the positive mode using ESI with a NanoLockSpray source, by using a standard peptide as lock mass delivered from a syringe pump to the NanoLockSpray source. The LC/MS was performed with the Q-TOF operating in either MS mode or MS/MS mode for data-dependent acquisition of MS/MS peptide fragmentation spectra. Processing and searching of the MS/MS data sets was performed by using both commercial and freely available softwares. An ESI-MS/MS technique with a nano source and a Q-TOF analyzer was used to characterize and localize up to 10 lactosylation sites in  $\alpha$ -Lg and  $\alpha_{S2}$ -casein. The  $\beta$ -Lac, with five lactosylated peptides, can be an interesting protein marker for milk powder to detect chemical modifications induced by processing/storage conditions [27]. In addition, low-abundance proteins of bovine colostrum and mature milk could be identified by using 2-DE and MS/MS analysis performed with a Q-TOF hybrid tandem mass spectrometer, equipped with a nanospray source [16].

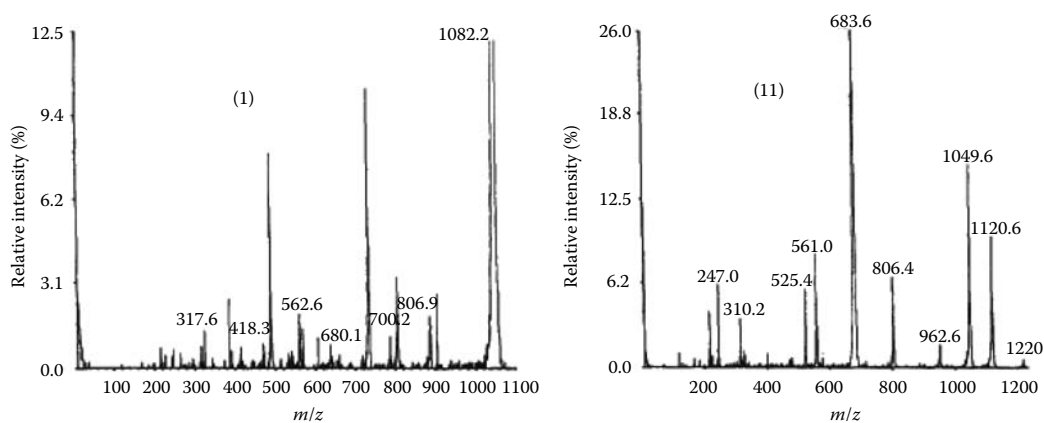
Obviously, LC/ESI-MS can also be used to study the complex mixtures of peptides naturally present in dairy foods, such as the peptidic fractions of cheeses. In a typical example, extracts of defatted mild, medium, and sharp Cheddar cheeses were analyzed by RP-HPLC for peptides, followed by ESI-MS analysis for MW determination, and MS/MS for amino acid sequence determination. The combination of MW and amino acid sequence can be subsequently used for peptide identification. Peptides can be compared with the known sequences of casein peptides, to obtain information on cleavage sites occurring during fermentation. Using these techniques, 13 peptides from  $\alpha_{S1}$ -casein, 7 from  $\beta$ -casein, and 5 from  $\kappa$ -casein were identified [86] (Figure 5.10).

In an even more striking example, 91 peptides were identified by ESI-MS/MS in Emmental cheese, 51 arising from  $\alpha_{S1}$ -casein and 28 from  $\beta$ -caseins [87]. The identification of the cleavage sites can allow the correlation of the released peptides to the proteolytic systems potentially involved during cheese manufacture. Also, peptides from goats' cheeses have been analyzed by MS/MS [26]. In another case, 107 different peptides derived from  $\alpha_{S1}$ -,  $\alpha_{S2}$ -, and  $\beta$ -casein were identified by LC/ESI-MS/MS in different fractions of Manchego cheeses, correlating their taste characteristics (umami and bitter) to their amino acidic composition and sequences [88].



**Figure 5.9** ESI-MS profiles of the relative CSD of  $\beta$ -lactoglobulin A and B genetic variants before (top) and after (down) pressure treatment at 450 MPa. (From Alvarez, P.A. et al., *Int. Dairy J.*, 17, 881, 2007.)

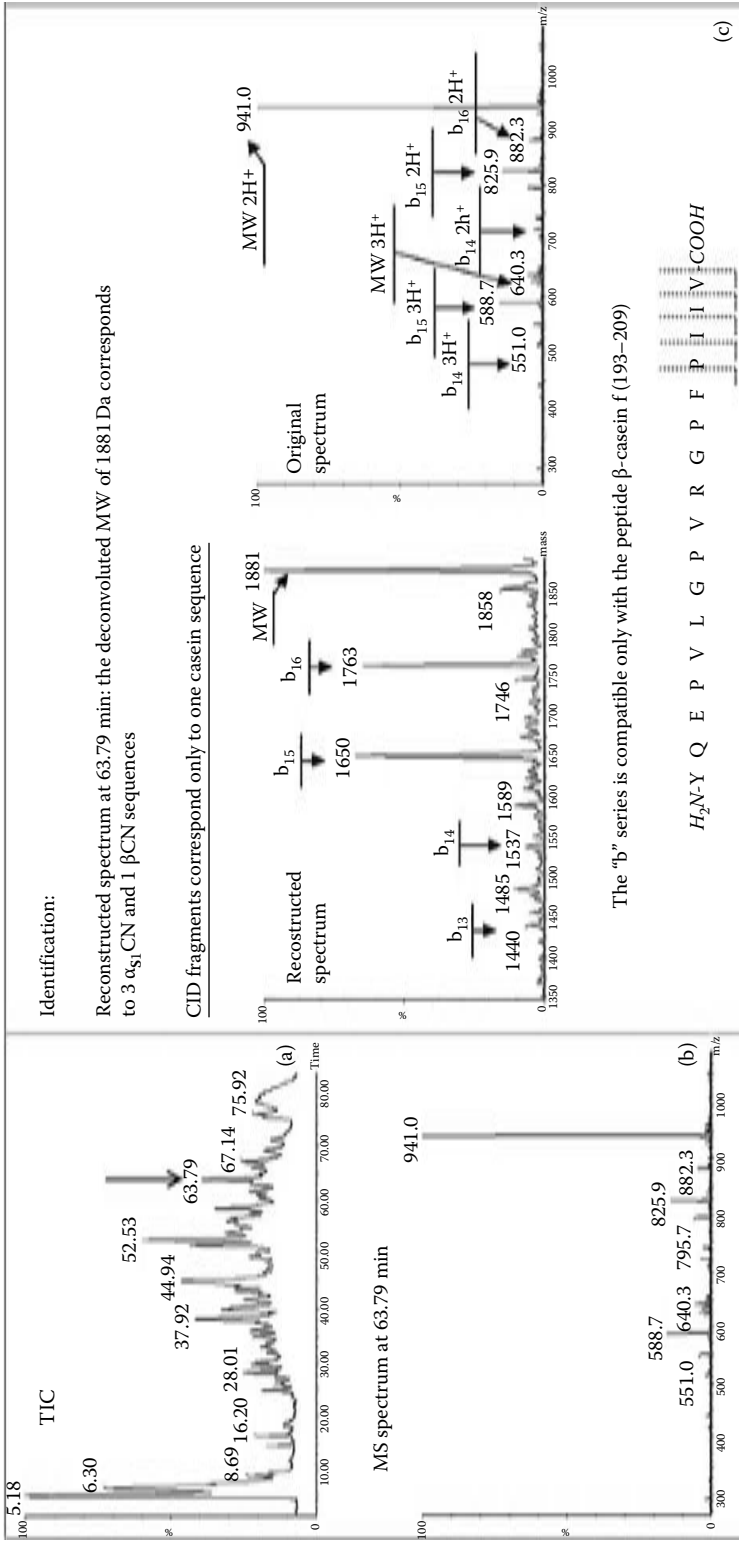
Furthermore, phosphopeptides, previously concentrated by affinity chromatography [21], could be identified by using LC coupled to an ion-trap (IT) ESI-MS/MS. For large peptides, MS/MS data may be insufficient for a clear-cut identification, but by a clever combination of MS/MS experiments with partial Edman sequencing, it is possible to provide sufficient ground for the sequence assessment [24].



**Figure 5.10** ESI-MS/MS spectra of two peptides having MW=1052 (left, MS/MS spectrum obtained by fragmentation of the singly charged molecular ion) and 1366 (right, MS/MS spectrum obtained by fragmentation of the doubly charged molecular ion). (From Alli, I. et al., *Int. Dairy J.*, 8, 643, 1998.)

The power of IT-MS, with the possibility to perform  $MS^n$  experiments, allows peptide identification in particularly difficult situations. For example, ESI-IT-MS coupled to a 2D liquid chromatographic separation was applied to the identification of peptides in antimicrobial fractions of the aqueous extracts of nine Italian cheeses. Active fractions were analyzed by HPLC/ESI-IT- $MS^n$ , with  $n$  up to 3. Peptide identification was subsequently performed starting from a conventional proteomic approach based on MS/MS analysis, followed by database searching. In many cases, this strategy had to be integrated by a careful correlation between spectral information and predicted peptide fragmentation, to reach unambiguous identifications. When even this integrated approach failed,  $MS^3$  measurements provided conclusive information on the amino acid sequence of some peptides, through fragmentation of side groups along the peptide chain. As a result, 45 peptides, all obtained from the hydrolysis of milk caseins, were identified in nine antimicrobial fractions of aqueous extracts obtained from five out of nine cheeses considered [89].

A different approach for the identification of proteolytic peptides in cheese, alternative to the use of ESI-MS/MS methodologies, has been also proposed, based on simple LC/ESI-MS single-stage mass spectrometers. The approach is based on the identification of the mean MW of the most abundant peptides eluted from an RP-HPLC column, acquired in full-scan mode. A simple software subsequently compares the identified MWs with all the hypothetical MWs of all the peptides of every possible length, which could be formed by all caseins (whose sequences are known), by assuming the cleavages in every possible position. This procedure narrows the possibilities to few peptides. By comparing the expected fragments of these few peptides with the few fragments obtained by in-source fragmentation, a clear-cut identification of these peptides can be obtained. This procedure has the advantages of being very fast, requiring only one LC/ESI-MS run for the identification of several peptides, and using simple low-cost MS instrumentation (Figure 5.11). By this methodology, many peptides have been identified in Grana Padano [65] and Parmigiano-Reggiano cheeses [90], some of them never previously reported. Moreover, peptides were also



**Figure 5.11** Example of the procedure used for peptide identification by using a single stage ESI-MS spectrometer: (a) from the total ion chromatogram (TIC) of an LC/ESI-MS analysis, the mass spectrum of one peptide at Rt 63.79 is obtained; (b) the reconstructed mass spectrum indicates a molecular mass of 1881 Da; (c) all the possible fragments coming from the caseins which have that molecular mass can then be calculated (3  $\alpha_{s1}$ -casein and 1  $\beta$ -casein fragments); the partial fragmentation pattern clearly visible both in the original and the reconstructed spectrum is compatible with only one of these sequences, the peptide  $\beta$ -CNf (193–209). (Adapted from Sforza, S. et al., *J. Agric. Food Chem.*, 51, 2130, 2003.)

easily semiquantified by using a suitable internal standard (a dipeptide not present in the samples), allowing the comparison of the peptide content in cheese samples of different ages. In a recent application of the same method, cows' casein-derived peptides were used as markers of adulteration in sheep-milk cheeses [91].

## 5.5 Conclusions and Future Perspectives

The proteomic techniques have enormously expanded in the last few years, touching many fields in science. Applications to food science, such as those reviewed in this chapter for dairy products, have been quite limited till date, but undoubtedly, they will follow an expansive trend in the forthcoming years. It is reasonable to expect that what is now being developed for biomedical proteomics will also find its application in food proteomics.

In particular, high-throughput techniques, such as those based on the enzymatic digestion of the entire proteome followed by LC/MS/MS analysis or those based on protein microarrays, can be expected to find increasing applications. Although these techniques are not optimal for characterizing very complex proteomes, they have the main advantage of being fast and chromatography-based rather than gel-based, thus eliminating the variability potentially present in all the gel analysis, particularly as far as the quantitative determination is concerned.

Also, quantitative determination of proteins and, in particular, the relative quantifications used in all the studies concerning comparative proteomics, is an issue which probably will be studied with more advanced techniques than those applied today. The crude band-intensity comparison in different gels will probably be substituted, as in biomedicine, by more sophisticated and more accurate techniques, such as differential fluorimetry or stable isotope-based methods.

Many important developments will appear from the application of proteomics to dairy sciences, which is currently quite limited. Till date, various studies have been concentrating mainly on the basic knowledge: what are the proteins or peptides present in milk, dairy products, or LAB. This knowledge can now be applied to improve the existing technologies, for example, selecting bacteria with increased expression of proteins of interest, such as those involved in industrial processes or stress response. Proteomic characterization has the potential to become a standard analysis to be performed in dairy sciences in the near future, capable of providing an enormous informative evaluation about the dairy products and the best way to improve them.

## References

1. Wasinger, V.C.; Cordwell, S.J.; Cerpa-Poljak, A.; Yan, J.X.; Gooley, A.A.; Wilkins, M.R.; Duncan, M.W.; Harris, R.; Williams, K.L.; Humphery-Smith, I. Progress with gene-product mapping of the Mollicutes—*Mycoplasma-genitalium*. *Electrophoresis*, **1995**, *16*, 1090–1094.
2. Celis, J.E.; Østergaard, M.; Jensen, N.A.; Gromova, I.; Rasmussen, H.H.; Gromov, P. Human and mouse proteomic databases: Novel resources in the protein universe. *FEBS Lett.*, **1998**, *430*, 64–72.
3. Westermeier, R.; Naven, T. *Proteomics in Practice—A Laboratory Manual of Proteome Analysis*. Wiley-VCH: Weinheim, 2002.
4. Yang, Y.; Thannhauser, T.W.; Li, L.; Zhang, S. Development of an integrated approach for evaluation of 2-D gel image analysis: Impact of multiple proteins in single spots on comparative proteomics in conventional 2-D gel/MALDI workflow. *Electrophoresis*, **2007**, *28*, 2080–2094.
5. Mills, D.A. The lactic acid bacteria genome project. *J. Food Sci.*, **2004**, *69*, M28–M30.

6. van de Guchte, M.; Serror, P.; Chervaux, C.; Smokvina, T.; Ehrlich, S.D.; Maguin, E. Stress responses in lactic acid bacteria. *Antonie van Leeuwenhoek*, **2002**, *82*, 187–216.
7. Holt, D.L.; Zeece, M.G. Two-dimensional electrophoresis of bovine milk proteins. *J. Dairy Sci.*, **1988**, *71*, 2044–2050.
8. Natale, M.; Bisson, C.; Monti, G.; Peltran, A.; Perono Garoffo, L.; Valentini, S.; Fabris, C.; Bertino, E.; Coscia, A.; Conti, A. Cow's milk allergens identification by two dimensional immunoblotting and mass spectrometry. *Mol. Nutr. Food Res.*, **2004**, *48*, 363–369.
9. Oh-Ishi, M.; Maeda, T. Separation techniques for high-molecular-mass proteins. *J. Chromatogr. B*, **2002**, *771*, 49–66.
10. Chin, H.W.; Rosenberg, M. Monitoring proteolysis during cheddar cheese ripening using two-dimensional gel electrophoresis. *J. Food Sci.*, **1998**, *63*, 423–428.
11. Gagnaire, V.; Piot, M.; Camier, B.; Vissers, J.P.C.; Jan, G.; Léonil, J. Survey of bacterial proteins released in cheese: A proteomic approach. *Int. J. Food Microbiol.*, **2004**, *94*, 185–201.
12. Molina, E.; Ramos, M.; Amigo, L. Characterisation of the casein fraction of Ibérico cheese by electrophoretic techniques. *J. Sci. Food Agric.*, **2002**, *82*, 1240–1245.
13. Lindmårk-Mansson, H.; Timgren, A.; Aldén, G.; Paulsson, M. Two-dimensional gel electrophoresis of proteins and peptides in bovine milk. *Int. Dairy J.*, **2005**, *15*, 111–121.
14. Murakami, K.; Lagarde, M.; Yuki, Y. Identification of minor proteins of human colostrum and mature milk by two dimensional electrophoresis. *Electrophoresis*, **1998**, *19*, 2521–2527.
15. Holland, J.W.; Deeth, H.C.; Alewood, P.F. Proteomic analysis of  $\kappa$ -casein micro-heterogeneity. *Proteomics*, **2006**, *6*, 3087–3095.
16. Yamada, M.; Murakami, K.; Wallingford, J.C.; Yuki, Y. Identification of low-abundance proteins of bovine colostrum and mature milk using two-dimensional electrophoresis followed by microsequencing and mass spectrometry. *Electrophoresis*, **2002**, *23*, 1153–1160.
17. Salzano, A.M.; Arena, S.; Renzone, G.; D'Ambrosio, C.; Rullo, R.; Bruschi, M.; Ledda, L.; et al. A widespread picture of the *Streptococcus thermophilus* proteome by cell lysate fractionation and gel-based/gel-free approaches. *Proteomics*, **2007**, *7*, 1420–1433.
18. Sousa, M.J.; Ardö, Y.; McSweeney, P.L.H. Advances in the study of proteolysis during cheese ripening. *Int. Dairy J.*, **2001**, *11*, 327–345.
19. Igarashi, Y. Separation of caseins by chemical procedures. *Int. Dairy J.*, **1999**, *9*, 377–378.
20. Kuchroo, C.N.; Fox, P.F. Soluble nitrogen in Cheddar cheese: Comparison of extraction procedures. *Milchwissenschaft*, **1982**, *37*, 331–335.
21. Lund, M.; Ardö, Y. Purification and identification of water-soluble phosphopeptides from cheese using Fe(III) affinity chromatography and mass spectrometry. *J. Agric. Food Chem.*, **2004**, *52*, 6616–6622.
22. Schmelzer, C.E.H.; Schöps, R.; Ulbrich-Hofmann, R.; Neubert, R.H.H.; Raith, K. Mass spectrometric characterization of peptides derived by peptic cleavage of bovine  $\beta$ -casein. *J. Chromatogr. A*, **2004**, *1055*, 87–92.
23. Recio, I.; Perez-Rodriguez, M.L.; Ramos, M.; Amigo, L. Capillary electrophoretic analysis of genetic variants of milk proteins from different species. *J. Chromatogr. A*, **1997**, *768*, 47–56.
24. Ardö, Y.; Lilbæk, H.; Kristiansen, K.R.; Zakora, M.; Otte, J. Identification of large phosphopeptides from  $\beta$ -casein that characteristically accumulate during ripening of the semi-hard cheese Herrgård. *Int. Dairy J.*, **2007**, *17*, 513–524.
25. Combes, C.; Paterson, E.; Amado, R. Isolation and identification of low-molecular-weight peptides from Emmentaler cheese. *J. Food Sci.*, **2002**, *67*, 553–559.
26. Sommerer, N.; Salles, C.; Promé, D.; Promé, J.C.; Le Quere, J.L. Isolation of oligopeptides from the water-soluble extract of goat cheese and their identification by mass spectrometry. *J. Agric. Food Chem.*, **2001**, *49*, 402–408.
27. Marvin, L.F.; Parisod, V.; Fay, L.B.; Guy, P.A. Characterization of lactosylated proteins of infant formula powders using two-dimensional gel electrophoresis and nanoelectrospray mass spectrometry. *Electrophoresis*, **2002**, *23*, 2505–2512.



28. Zeece, M.G.; Holt, D.L.; Wehling, R.L.; Liewen, M.B.; Bush, L.R. High-resolution two-dimensional electrophoresis of bovine caseins. *J. Agric. Food Chem.*, **1989**, *37*, 378–383.
29. Tutta, C.; Curioni, A.; Peruffo, A.D.B. A 2-dimensional electrophoretic method for the study of caprine alpha-S1-casein and alpha-S2-casein polymorphism. *J. Dairy Res.*, **1991**, *58*, 247–250.
30. Galvani, M.; Hamdan, M.; Righetti, P.G. Two-dimensional gel electrophoresis/matrix-assisted laser desorption/ionisation mass spectrometry of commercial bovine milk. *Rapid Commun. Mass Spectrom.*, **2001**, *15*, 258–264.
31. Mamone, G.; Caira, S.; Garro, G.; Nicolai, A.; Ferranti, P.; Picariello, G.; Malorni, A.; Chianese, L.; Addeo, F. Casein phosphoproteome: Identification of phosphoproteins by combined mass spectrometry and two-dimensional gel electrophoresis. *Electrophoresis*, **2003**, *24*, 2824–2837.
32. Kim, Y.H.; Jimenez-Flores, R. Two-dimensional analysis of skim milk proteins using preparative isoelectric focusing followed by polyacrylamide gel electrophoresis. *J. Food Biochem.*, **1992**, *16*, 307–312.
33. Perrin, C.; González-Márquez, H.; Gaillard, J.L.; Bracquart, P.; Guimont, C. Reference map of soluble proteins from *Streptococcus thermophilus* by two-dimensional electrophoresis. *Electrophoresis*, **2000**, *21*, 949–955.
34. Anglade, P.; Demey, E.; Labas, V.; Le Caer, J.P.; Chich, J.F. Towards a proteomic map of *Lactococcus lactis* NCDO 763. *Electrophoresis*, **2000**, *21*, 2546–2549.
35. de Jong, N.; Visser, S.; Olieman, C. Determination of milk proteins by capillary electrophoresis. *J. Chromatogr. A*, **1993**, *652*, 207–213.
36. Cartoni, G.P.; Coccioli, F.; Jasionowska, R.; Masci, M. Determination of cow milk in buffalo milk and mozzarella cheese by capillary electrophoresis of the whey protein fractions. *Ital. J. Food Sci.*, **1998**, *10*, 127–135.
37. Recio, I.; Amigo, L.; López-Fandiño, R. Assessment of the quality of dairy products by capillary electrophoresis of milk proteins. *J. Chromatogr. B*, **1997**, *697*, 231–242.
39. Miralles, B.; Rothbauer, V.; Manso, M.A.; Amigo, L.; Krause, I.; Ramos, M. Improved method for the simultaneous determination of whey proteins, caseins and *para*-kappa-casein in milk and dairy products by capillary electrophoresis. *J. Chromatogr. A*, **2001**, *915*, 225–230.
39. Ferranti, P.; Pizzano, R.; Garro, G.; Caira, S.; Chianese, L.; Addeo, F. Mass spectrometry-based procedure for the identification of ovine casein heterogeneity. *Int. Dairy Res.*, **2001**, *68*, 35–51.
40. Heck, J.M.L.; Olieman, C.; Schennink, A.; van Valenberg, H.J.F.; Visker, M.H.P.W.; Meuldijk, R.C.R.; van Hooijdonk, A.C.M. Estimation of variation in concentration, phosphorylation and genetic polymorphism of milk proteins using capillary zone electrophoresis. *Int. Dairy J.*, **2008**, *18*, 548–555.
41. De Block, J.; Merchiers, M.; van Renterghem, R. Capillary electrophoresis of the whey protein fraction of milk powders. A possible method for monitoring storage conditions. *Int. Dairy J.*, **1998**, *8*, 787–792.
42. Cartoni, G.; Coccioli, F.; Jasionowska, R.; Masci, M. Determination of cows' milk in goats' milk and cheese by capillary electrophoresis of the whey protein fractions. *J. Chromatogr. A*, **1999**, *846*, 135–141.
43. Herrero-Martínez, J.M.; Simó-Alfonso, E.F.; Ramis-Ramos, G.; Gelfi, C.; Righetti, P.G. Determination of cow's milk in non-bovine and mixed cheeses by capillary electrophoresis of whey proteins in acidic isoelectric buffers. *J. Chromatogr. A*, **2000**, *878*, 261–271.
44. Steffan, W.; Balzer, H.H.; Lippert, F.; Sambor, B.C.; Bradbury, A.G.W.; Henle, T. Characterization of casein lactosylation by capillary electrophoresis and mass spectrometry. *Eur. Food Res. Technol.*, **2006**, *222*, 467–471.
45. Fairise, J.F.; Cayot, P. New ultrarapid method for the separation of milk proteins by capillary electrophoresis. *J. Agric. Food Chem.*, **1998**, *46*, 2628–2633.
46. Strickland, M.; Weimer, B.C.; Broadbent, J.R. Capillary electrophoresis of Cheddar cheese. *J. Chromatogr. A*, **1996**, *731*, 305–313.
47. Strickland, M.; Johnson, M.E.; Broadbent, J.R. Qualitative and quantitative analysis of proteins and peptides in milk products by capillary electrophoresis. *Electrophoresis*, **2001**, *22*, 1510–1517.

48. Somma, A.; Ferranti, P.; Addeo, F.; Mauriello, R.; Chianese, L. Peptidomic approach based on combined capillary isoelectric focusing and mass spectrometry for the characterization of the plasmin primary products from bovine and water buffalo beta-casein. *J. Chromatogr. A*, **2008**, *1192*, 294–300.
49. Léonil, J.; Mollé, D.; Gaucheron, F.; Arpino, P.; Guénot, P.; Maubois, J.L. Analysis of major bovine-milk proteins by online high-performance liquid-chromatography and electrospray-ionization mass-spectrometry. *Lait*, **1995**, *75*, 193–210.
50. Trujillo, A.J.; Casals, I.; Guamis, B. Analysis of major ovine milk proteins by reversed-phase high-performance liquid chromatography and flow injection analysis with electrospray ionization mass spectrometry. *J. Chromatogr. A*, **2000**, *870*, 371–380.
51. Trujillo, A.J.; Casals, I.; Guamis, B. Analysis of major caprine milk proteins by reverse-phase high-performance liquid chromatography and electrospray ionization-mass spectrometry. *J. Dairy Sci.*, **2000**, *83*, 11–19.
52. Moatsou, G.; Moschopoulou, E.; Mollé, D.; Gagnaire, V.; Kandarakis, I.; Léonil, J. Comparative study of the protein fraction of goat milk from the Indigenous Greek breed and from international breeds. *Food Chem.*, **2008**, *106*, 509–520.
53. Bordin, G.; Cordeiro Raposo, F.; de la Calle, B.; Rodriguez, A.R. Identification and quantification of major bovine milk proteins by liquid chromatography. *J. Chromatogr. A*, **2001**, *928*, 63–76.
54. Losito, I.; Carbonara, T.; Monaci, L.; Palmisano, F. Evaluation of the thermal history of bovine milk from the lactosylation of whey proteins: An investigation by liquid chromatography–electrospray ionization mass spectrometry. *Anal. Bioanal. Chem.*, **2007**, *389*, 2065–2074.
55. Franzen, M.; Pabst, K.; Schultecoerne, H.; Gravert, H.O. Quantitative chromatographic-separation of milk-proteins. *Milchwissenschaft-Milk Sci. Int.*, **1995**, *50*, 483–488.
56. Smolenski, G.; Haines, S.; Kwan, F.Y.S.; Bond, J.; Farr, V.; Davis, S.R.; Stelwagen, K.; Wheeler, T.T. Characterization of host defence proteins in milk using a proteomic approach. *J. Proteome Res.*, **2007**, *6*, 207–215.
57. Luykx, D.M.A.M.; Cordewener, J.H.G.; Ferranti, P.; Frankhuizen, R.; Bremer, M.G.E.G.; Hooijerink, H.; America, A.H.P. Identification of plant proteins in adulterated skimmed milk powder by high-performance liquid chromatography–mass spectrometry. *J. Chromatogr. A*, **2007**, *1164*, 189–197.
58. Addeo, F.; Chianese, L.; Salzano, A.; Sacchi, R.; Cappuccio, U.; Ferranti, P.; Malorni, A. Characterization of the 12% trichloroacetic acid-insoluble oligopeptides of Parmigiano Reggiano cheese. *J. Dairy Res.*, **1992**, *59*, 401–411.
59. Addeo, F.; Chianese, L.; Sacchi, R.; Spagna Musso, S.; Ferranti, P.; Malorni, A. Characterization of the oligopeptides Parmigiano Reggiano cheese soluble in 120 g trichloroacetic acid/l. *J. Dairy Res.*, **1994**, *61*, 365–374.
60. De Llano, D.G.; Polo, M.C.; Ramos, M. Study of proteolysis in artisanal cheeses: High-performance liquid-chromatography of peptides. *J. Dairy Sci.*, **1995**, *78*, 1018–1024.
61. Singh, T.K.; Fox, P.F.; Healy, A. Water-soluble peptides in cheddar cheese—Isolation and identification of peptides in the diafiltration retentate of the water-soluble fraction. *J. Dairy Res.*, **1995**, *62*, 629–640.
62. Ferranti, P.; Itolli, E.; Barone, F.; Malorni, A.; Garro, G.; Laezza, P.; Chianese, L.; Migliaccio, F.; Stingo, V.; Addeo, F. Combined high resolution chromatographic techniques (FPLC and HPLC) and mass spectrometry-based identification of peptides and proteins in Grana Padano Cheese. *Lait*, **1997**, *77*, 683–697.
63. Fernández, M.; Singh, T.K.; Fox, P.F. Isolation and identification of peptides from the diafiltration permeate of the water-soluble fraction of cheddar cheese. *J. Agric. Food Chem.*, **1998**, *46*, 4512–4517.
64. Fernández, M.; Fox, P.F. Fractionation of low molecular mass peptides in cheese. *Milchwissenschaft-Milk Sci. Int.*, **1998**, *53*, 25–28.
65. Sforza, S.; Ferroni, L.; Galaverna, G.; Dossena, A.; Marchelli, R. Extraction, semi-quantification, and fast on-line identification of oligopeptides in Grana Padano cheese by HPLC-MS. *J. Agric. Food Chem.*, **2003**, *51*, 2130–2135.

66. Chianese, L.; Mauriello, R.; Moio, L.; Intorcchia, N.; Addeo, F. Determination of ovine casein heterogeneity using gel-electrophoresis and immunochemical techniques. *J. Dairy Res.*, **1992**, *59*, 39–47.
67. Chianese, L.; Garro, G.; Mauriello, R.; Laezza, P.; Ferranti, P.; Addeo, F. Occurrence of five alpha(s1)-casein variants in ovine milk. *J. Dairy Res.*, **1996**, *63*, 49–59.
68. Lopez-Galvez, G.; Juarez, M.; Ramos, M. 2-Dimensional electrophoresis and immunoblotting for the study of ovine whey-protein polymorphism. *J. Dairy Res.*, **1995**, *62*, 311–320.
69. Pizzano, R.; Nicolai, M.A.; Padovano, P.; Ferranti, P.; Barone, F. Immunochemical evaluation of bovine  $\beta$ -casein and its 1-28 phosphopeptide in cheese during ripening. *J. Agric. Food Chem.*, **2000**, *48*, 4555–4560.
70. Pappin, D.J.; Hojrup, P.; Bleasby, A.J. Rapid identification of proteins by peptide-mass fingerprinting. *Curr. Biol.*, **1993**, *3*, 327–332. Erratum in *Curr. Biol.*, **1993**, *3*, 487.
71. Some internet-available programs: MASCOT (<http://www.matrixscience.com>), MS-Fit (<http://prospector.ucsf.edu>), ALDENTE (<http://au.expasy.org/tools/aldente/>), ProFound (<http://prowl.rockefeller.edu/prowl-cgi/profound.exe>).
72. Galvani, M.; Hamdan, M.; Righetti, P.G. Two-dimensional gel electrophoresis/matrix assisted laser desorption/ionisation mass spectrometry of a milk powder. *Rapid Commun. Mass Spectrom.*, **2000**, *14*, 1889–1897.
73. Roncada, P.; Gaviraghi, A.; Liberatori, S.; Canas, B.; Bini, L.; Greppi, G.F. Identification of caseins in goat milk. *Proteomics*, **2002**, *2*, 723–726.
74. Drews, O.; Reil, G.; Parlar, H.; Görg, A. Setting up standards and a reference map for the alkaline proteome of the Gram-positive bacterium *Lactococcus lactis*. *Proteomics*, **2004**, *4*, 1293–1304.
75. Manso, M.A.; Léonil, J.; Piot, M.; Gagnaire, V. Isolation and characterisation of a *Lactobacillus helveticus* ITG LH1 peptidase-rich sub-proteome. *Int. J. Food Microbiol.*, **2005**, *105*, 119–129.
76. Yuan, J.; Zhu, L.; Liu, X.K.; Zhang, Y.; Ying, T.Y.; Wang, B.; Wang, J.J.; et al. A proteome reference map and proteomic analysis of *Bifidobacterium longum* NCC2705. *Mol. Cell. Proteomics*, **2006**, *5*, 1105–1118.
77. Marsilio, R.; Catinella, S.; Seraglia, R.; Traldi, P. Matrix-assisted laser-desorption ionization mass-spectrometry for the rapid evaluation of thermal-damage in milk. *Rapid Commun. Mass Spectrom.*, **1995**, *9*, 550–552.
78. Catinella, S.; Traldi, P.; Pinelli, C.; Dallaturca, E.; Marsilio, R. Matrix-assisted laser desorption/ionization mass spectrometry in milk science. *Rapid Commun. Mass Spectrom.*, **1996**, *10*, 1629–1637.
79. Angeletti, R.; Gioacchini, A.M.; Seraglia, R.; Piro, R.; Traldi, P. The potential of matrix-assisted laser desorption/ionization mass spectrometry in the quality control of water buffalo mozzarella cheese. *J. Mass Spectrom.*, **1998**, *33*, 525–531.
80. Cozzolino, R.; Passalacqua, S.; Salemi, S.; Garozzo, D. Identification of adulteration in water buffalo mozzarella and in ewe cheese by using whey proteins as biomarkers and matrix-assisted laser desorption/ionization mass spectrometry. *J. Mass Spectrom.*, **2002**, *37*, 985–991.
81. Fanton, C.; Delogu, G.; Maccioni, E.; Podda, G.; Seraglia, R.; Traldi, P. Matrix-assisted laser desorption/ionization mass spectrometry in the dairy industry 2. The protein fingerprint of ewe cheese and its application to detection of adulteration by bovine milk. *Rapid Commun. Mass Spectrom.*, **1998**, *12*, 1569–1573.
82. Piraino, P.; Upadhyay, V.K.; Rossano, R.; Riccio, P.; Parente, E.; Kelly, A.L.; McSweeney, P.L.H. Use of mass spectrometry to characterize proteolysis in cheese. *Food Chem.*, **2007**, *101*, 964–972.
83. Monaci, L.; Van Hengel, A.J. Effect of heat treatment on the detection of intact bovine  $\alpha$ -lactoglobulins by LC mass spectrometry. *J. Agric. Food Chem.*, **2007**, *55*, 2985–2992.
84. Chen, R.K.; Chang, L.W.; Chung, Y.Y.; Lee, M.H.; Ling, Y.C. Quantification of cow milk adulteration in goat milk using high-performance liquid chromatography with electrospray ionization mass spectrometry. *Rapid Commun. Mass Spectrom.*, **2004**, *18*, 1167–1171.
85. Alvarez, P.A.; Ramaswamy, H.S.; Ismail, A.A. Effect of high-pressure treatment on the electrospray ionization mass spectrometry (ESI-MS) profiles of whey proteins. *Int. Dairy J.*, **2007**, *17*, 881–888.
86. Alli, I.; Okoniewska, M.; Gibbs, B.F.; Konishi, Y. Identification of peptides in Cheddar cheese by electrospray ionization mass spectrometry. *Int. Dairy J.*, **1998**, *8*, 643–649.

87. Gagnaire, V.; Mollé, D.; Herrouin, M.; Léonil, J. Peptides identified during Emmental cheese ripening: Origin and proteolytic systems involved. *J. Agric. Food Chem.*, **2001**, *49*, 4402–4413.
88. Gómez-Ruiz, J.A.; Tabora, G.; Amigo, L.; Ramos, M.; Molina, E. Sensory and mass spectrometric analysis of the peptidic fraction lower than one thousand daltons in Manchego cheese. *J. Dairy Sci.*, **2007**, *90*, 4966–4973.
89. Losito, L.; Carbonara, T.; De Bari, M.D.; Gobetti, M.; Palmisano, F.; Rizzello, C.G.; Zambonin, P.G. Identification of peptides in antimicrobial fractions of cheese extracts by electrospray ionization ion trap mass spectrometry coupled to a two-dimensional liquid chromatographic separation. *Rapid Commun. Mass Spectrom.*, **2006**, *20*, 447–455.
90. Sforza, S.; Galaverna, G.; Neviani, E.; Pinelli, C.; Dossena, A.; Marchelli, R. Study of the oligopeptide fraction in Grana Padano and Parmigiano-Reggiano cheeses by liquid chromatography–electrospray ionisation mass spectrometry. *Eur. J. Mass Spectrom.*, **2004**, *10*, 421–427.
91. Sforza, S.; Aquino, G.; Cavatorta, V.; Galaverna, G.; Mucchetti, G.; Dossena, A.; Marchelli, R. Proteolytic oligopeptides as molecular markers for the presence of cows' milk in fresh cheeses derived from sheep milk. *Int. Dairy J.*, **2008**, *18*, 1072–1076.

## Further Readings

- Champomier-Vergès, M.C.; Maguin, E.; Mistou, M.Y.; Anglade, P.; Chich, J.F. Lactic acid bacteria and proteomics: Current knowledge and perspectives. *J. Chromatogr. B*, **2002**, *771*, 329–342.
- Guy, P.A.; Fenaille, F. Contribution of mass spectrometry to assess quality of milk-based products. *Mass Spectrom. Rev.*, **2006**, *25*, 290–326.
- Manso, M.A.; Léonil, J.; Jan, G.; Gagnaire, V. Application of proteomics to the characterization of milk and dairy products. *Int. Dairy J.*, **2005**, *15*, 845–855.
- O'Donnell, R.; Holland, J.W.; Deeth, H.C.; Alewood, P. Milk Proteomics. *Int. Dairy J.*, **2004**, *14*, 1013–1023.



## Chapter 6

---

# Carbohydrates

---

Nieves Corzo, Agustín Olano, and Isabel Martínez-Castro

### CONTENTS

6.1	Introduction.....	139
6.2	Methods for the Quantitation of Carbohydrates in Milk.....	140
6.2.1	Classical Methods.....	141
6.2.2	Infrared Spectroscopic Methods.....	143
6.2.3	Enzymatic Methods.....	143
6.2.4	Flow-Injection Analysis.....	145
6.2.5	Chromatographic Methods.....	145
6.2.5.1	Planar Chromatography.....	146
6.2.5.2	Gas Chromatography.....	147
6.2.5.3	High-Performance Liquid Chromatography.....	150
6.2.6	Capillary Electrophoresis.....	160
6.2.6.1	Capillary Electrophoresis Modes.....	160
6.2.6.2	Applications.....	160
6.2.7	Mass Spectrometry.....	161
6.2.8	Nuclear Magnetic Resonance Spectroscopy.....	162
	References.....	162

### 6.1 Introduction

The carbohydrate fraction of milk comprises a complex mixture of mono-, di-, and oligosaccharides of which lactose, 4-*O*- $\beta$ -D-galactopyranosyl-D-glucose, is the major constituent in most mammalian species with the exception of some marsupials, marine mammals, several species of bears, giant panda, and minks [1]. These milks usually contain greater amounts of free oligosaccharides other than lactose whose composition varies among different mammalian species [2].

The lactose content of cow's milk is in the range of 4.4%–5.2%, averaging 4.8% of anhydrous lactose. This usually amounts to 50%–52% of the total solids of skimmed milk [3]. Other free carbohydrates found in milk, but at low concentrations, include glucose, galactose, amino sugars, sugar phosphates, neutral and acid oligosaccharides, and nucleotide sugars. As lactose is the main carbohydrate in commercial milk, its determination is a basic indicator for quality control and detection of abnormal milk, such as the lower concentrations of lactose in mastitic milk.

During heat treatment of milk, lactose is partially transformed into lactulose (4-*O*- $\beta$ -D-galactopyranosyl-D-fructose) that may in turn be degraded to form galactose, tagatose, and saccharinic acids. On the other hand, lactulose may also get isomerized to form epilactose (4-*O*- $\beta$ -D-galactopyranosyl-D-mannose) [4–7]. Except galactose, these carbohydrates are absent in raw milk, and their determination has been proposed for the distinction between different types of processed milks, as the lactulose and galactose content increases with the severity of the heating process, whereas epilactose [4,5] and tagatose [6] are only present in sterilized milks.

The amount and composition of milk oligosaccharides differ not only among the mammalian species, but also during the course of lactation. Human milk and colostrum contain more than 80 different oligosaccharides that constitute over 20% of the total milk carbohydrate [8], and some of them are thought to be biologically active as it has been suggested that they may play a role in the local intestinal immune system of the breast-fed infants [9]. Bovine colostrum has a relatively high content of these constituents when compared with mature cow's milk that contains only trace amounts. Thus, the colostrum is considered as a suitable raw material for the large-scale preparation of milk oligosaccharides to be used as the functional ingredients in the food industry. Although the oligosaccharides content in goat's milk is significantly lower when compared with the mature human milk, it is four to five times higher than that measured in cow's milk, and hence, goat's milk is considered as an attractive natural source of oligosaccharides in human nutrition [10].

During the production of functional fermented milks, oligosaccharides are produced in variable amounts mainly depending on the strains used [11–13], and hence, the functional properties of fermented milks may not only be owing to its probiotic contents, but also owing to the presence of oligosaccharides. Galactooligosaccharides (GOS) are produced from lactose by glycosyl transfer of one or more D-galactosyl units onto the D-galactose moiety of lactose, catalyzed by  $\beta$ -galactosidase [14]. The linkage between the D-galactose units and components formed depends on the enzyme origin and the conditions in which transgalactosylation reaction occurred [15,16]. Although the presence of these oligosaccharides improves the probiotic effect of fermented milks, there are limited data on the oligosaccharide content in commercial samples [11].

Some cheeses are almost lactose-free, because during the manufacturing process, most of the lactose is removed with the whey, and the remaining lactose in the cheese is gradually consumed in the fermentation process. However, in fresh cheeses and those made by coagulating fresh milk or cream with rennet or an acid, lactose remains unchanged, and therefore, these products may contain appreciable amounts of lactose. As most of the strains ferment only the glucose moiety of lactose, galactose remains in the curd. Both galactose and lactose may influence the characteristics of the cheeses, and hence, its contents need to be controlled [17–19]. Determination of lactose may also be useful for evaluating grated-cheese adulteration with whey solids [20].

## 6.2 Methods for the Quantitation of Carbohydrates in Milk

The determination of lactose in dairy products is important and a number of methods are available since many years, such as gravimetric, polarimetric, and colorimetric methods. Most of

the traditional methods are time consuming, as the quantitative determination of lactose can be performed only in the soluble serum samples obtained after prior removal of fat and protein fractions. Moreover, differentiation among the large number of carbohydrates present in dairy products is impossible. Therefore, there is a considerable incentive to improve the chemical and instrumental methods of analysis for the rapid determination of lactose as well as for a detailed analysis of the complex carbohydrate fraction present in the dairy products.

### 6.2.1 Classical Methods

A considerable number of methods for the determination of carbohydrates in milk have been developed, including gravimetric, polarimetric, or spectrophotometric analysis (Table 6.1). Early methods of lactose analysis in milk are based on the determination of lactose by difference, an indirect method in which lactose is calculated by subtracting the protein, fat, and ash contents of a sample from the total solids content [8]. Polarimetric methods are based on the measurement of the specific rotation of lactose in a defatted and deproteinized milk filtrate [21]. On the other hand, gravimetric methods are based on the reduction of copper sulfate to cuprous oxide precipitated by the addition of potassium hydroxide in the presence of aldoses and ketoses; after weighing the cuprous oxide formed, the lactose content is calculated using empirical tables that allow the conversion of the cuprous oxide formed in terms of lactose [21].

The Lane–Eynon method is based on the reaction of lactose with the Soxhlet modification of Fehling solution, consisting in a mixture of copper sulfate and alkaline tartrate solution. By boiling the mixed Soxhlet reagent with successive additions of the reducing carbohydrate solution,  $\text{Cu}_2\text{O}$  is formed and the blue color of cupric tartrate tends to disappear. When only faintest perceptible blue remains, some drops of methylene blue solution is added and titration is completed by small additions of the lactose solution [22].

The chloramine-T method consists of the reduction of chloramine-T (sodium *N*-chloro-*p*-toluenesulfonamide) by the lactose in milk previously defatted and deproteinized, and the excess of chloramine-T reacts with the acidified potassium iodide that is oxidized to iodine. The iodine released is then determined by titration with sodium thiosulfate [23].

Quantitative determination of lactose in dairy products by means of anthrone (9-oxo anthracene) includes maceration of the sample with water, and after blending, the addition of sulfuric acid solution of anthrone, heating of the mixture, and color measurement with a colorimeter using a 580 filter. This method can be easily adapted to cheese, whole milk, skimmed milk, and nonfat milk solids [24].

With phenol and sulfuric acid, lactose forms a violet-brown color whose intensity can be measured at 480 nm. The amount of lactose present is determined by comparison with a calibration curve using a spectrophotometer [25]. In alkaline media, lactose forms a yellow color with potassium ferricyanide that can be measured at 420 nm [25].

Lactose also reduces the 3,5-dinitrosalicylic acid to the orange-red 3-amino-5-nitro-salicylic acid, and its intensity can be measured at 570 nm [25].

These methods are based on the assumption that lactose is the only reducing carbohydrate present in milk; this may cause a problem of accuracy, mainly in some dairy products, such as fermented milks and cheeses with appreciable amounts of monosaccharides, as well as in human milks and milks of mammalian species containing high levels of oligosaccharides [26]. This problem was partially addressed by optimizing the methylamine–sodium sulfite reaction, so that it formed chromophore with lactose, but not with glucose or galactose [8]. In a complementary



**Table 6.1 Classical Methods of Analysis**

<i>Analyte</i>	<i>Reagents</i>	<i>Detection</i>	<i>Ref.</i>
Lactose	Copper sulfate	Gravimetry	[21]
	Potassium hydroxide		
Lactose	Acid-mercuric nitrate	Polarimetry	[21]
	Mercuric iodide		
Lactose	Copper sulfate	Titration	[22]
	Alkaline tartrate		
	Methylene blue		
Lactose	Chloramine-T	Titration	[23]
	Potassium iodide		
	Sodium thiosulfate		
Lactose	Anthrone	Colorimetry at 580 nm	[24]
	Sulfuric acid		
Lactose	Phenol	Spectrophotometry at 480 nm	[25]
	Sulfuric acid		
Lactose	Methylamine	Spectrophotometry at 540 nm	[8]
	Sodium sulfite		
Lactose	Alkaline potassium ferricyanide	Spectrophotometry at 420 nm	[25]
Lactose	Methylamine–sodium sulfite	Spectrophotometry at 540 nm	[27]
	Glycine–sodium hydroxide		
Lactose	3,5-Dinitrosalicylic acid	Colorimetry at 570 nm	[25]
Lactulose	Potassium hypoiodite	Spectrophotometry at 540 nm	[28]
	Methylamine hydrochloride		
	Sodium hydroxide		
	Sodium sulfite		
Lactulose	Periodate	Spectrophotometry at 427 nm	[29]
	Anthrone–acetic acid		
	Phosphoric acid–ethanol		
Lactulose	Sulfuric acid	Spectrophotometry at 330 nm	[30]

approach, ammonium molybdate was reacted with the sample under conditions that allowed the formation of chromophores with glucose and galactose, but gave no color with lactose [27].

Colorimetric methods for the determination of lactulose in milk-based products are limited owing to the presence of lactose, which is also a reducing disaccharide. Adachi [28] used the reaction of methylamine with lactulose, which involves a preliminary step to eliminate lactose by oxidation with periodate to form aldonic acid, followed by its removal by ion-exchangers. Later, a keto-specific method based on an anthrone–acetic acid–phosphoric acid–ethanol reagent that allowed the estimation of lactulose in lactose–lactulose mixtures was reported [29], but it was not sufficiently specific, as anthrone reacted with 5-hydroxymethylfurfural. A method based on the fact that ketoses are decomposed far more easily than aldoses by the action of mineral acids, which produces an intense red or violet coloration, where the color appears relatively slowly and is less intense in the case of aldoses, allowed the determination of a minimum of 10 mg/100 mL concentration of lactulose in milk and dairy products [30]. The reddish-brown color produced on heating the protein-free filtrate of milk in 6.4 N sulfuric acid was measured at 330 nm.

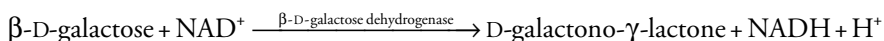
### 6.2.2 Infrared Spectroscopic Methods

These methods are based on the absorbance of infrared energy by the hydroxyl groups (OH) of lactose molecules. Lactose analysis in the mid-infrared (MIR) spectroscopy is performed at  $1042\text{ cm}^{-1}$  ( $9.610\text{ }\mu\text{m}$ ) [31]. Early instruments were entirely filter-based, which used pairs (sample and reference) of optical filters to select a band of wavelengths for the measurement of fat, protein, and lactose. More recent equipments based on Fourier transform infrared (FTIR) spectroscopy use an interferometer to produce the complete spectra information within the MIR region and provide extensive computing and data manipulation capabilities [32].

Furthermore, the use of short-wave near-infrared (NIR) wavelengths from 700 to 1100 nm for quantitative analysis of fat, protein, and lactose in milk have also been studied. In this spectral region, sample pretreatment such as homogenization is not needed and spectral data are obtained faster. Moreover, a silicon detector generally used in this region, is not as expensive either [33]. Today, a number of commercial milk analyzers are designed for fast and cost-effective determination of fat, protein, and lactose in milk samples.

### 6.2.3 Enzymatic Methods

A considerable number of enzymatic methods to determine lactose have been reported. They have the common reaction of enzymatic hydrolysis of lactose to glucose and galactose, followed by the enzymatic determination of one of the liberated monosaccharides. The difference in the monosaccharide content before and after hydrolysis represents the amount of lactose in the sample. The most common enzymatic method to measure galactose is based on its oxidation by  $\beta$ -galactose dehydrogenase to galacturonic acid in the presence of nicotinamide-adenine dinucleotide (NAD) that is reduced to NADH, as described by the following reaction:



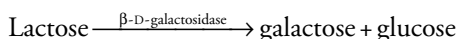
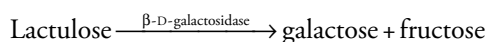
The absorbance of NADH at 340 nm is calculated as the difference between the readings before and after the addition of the enzyme, galactose dehydrogenase [34,35]. Although this UV method is specific and accurate, as the measurements of NADH require reading in the UV range, replacement of NAD by thio-NAD and measurement in the visible range at 405 or 415 nm can be also used. This modification allows the simultaneous determination of D-galactose concentrations in several samples using microplate-readers, rather than UV spectrophotometers [36]. A chromogenic enzymatic method using a microassay format is based on the actions of lactase and glucose oxidase (GOD) in a buffered solution of iodide, molybdate, and polyvinyl alcohol. Hydrogen peroxide is produced and measured by its molybdate-catalyzed reaction with iodide to produce iodine, which forms a colored complex with polyvinyl alcohol [37].

Furthermore, lactose biosensors based on immobilized enzymes with electrochemical detection have also been reported. Some of them are based on the enzymatic hydrolysis of lactose into galactose and glucose, followed by the GOD-catalyzed conversion of glucose to gluconate and hydrogen peroxide. The measurement of hydrogen peroxide produced may be achieved through different ways, such as by using a Pt electrode [38] or oxidation of 5-aminosalicylic acid and further reduction using a glassy carbon electrode [39].

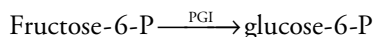
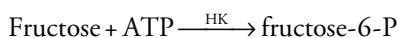
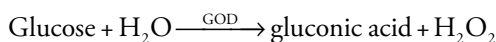
Recently, quantitative determination of lactose in milk using a wireless multienzyme biosensor has been reported [40]. Lactase, GOD, and catalase were co-immobilized onto a magnetoelastic ribbon-like sensor that was previously coated with a layer of a pH-sensitive polymer. The enzymatic lactose hydrolysis produces glucose that is oxidized to gluconic acid, resulting in the pH-responsive polymer-shrinking that causes a shift in the frequency, which is linearly proportional to the lactose concentration.

Furthermore, a lactose biosensor based on a newly discovered cellobiose dehydrogenase from white rot fungi *Trametes villosa* and *Phanerochaete sordida*, which catalyzes the oxidation of lactose and strictly prevents the monosaccharides from the catalytic reaction, has also shown a great potential for the applications in the dairy industry [41].

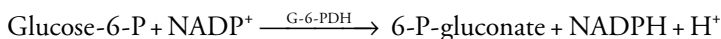
Enzymatic determination of lactulose is based on its hydrolysis in the presence of lactase to give galactose and fructose. The amount of released fructose is stoichiometric with the amount of lactulose:



As lactose is present in milk in significantly higher amounts than lactulose, the glucose obtained after hydrolysis would interfere with the determination of fructose. Therefore, the glucose is oxidized using GOD to gluconic acid, and subsequently, fructose is phosphorylated by means of adenosine triphosphate (ATP) in the presence of hexokinase (HK) to yield fructose-6-phosphate that is isomerized to glucose-6-phosphate in the presence of the enzyme phosphoglucose-isomerase (PGI):



The glucose-6-phosphate is oxidized using NADP<sup>+</sup> in the presence of glucose-6-phosphate dehydrogenase (G-6-PDH) to obtain 6-phosphogluconate and NADPH:



The absorbance of NADPH is subsequently measured at 340 nm, and is observed to be proportional to the fructose and lactulose content [42].

An enzymatic spectrophotometric assay for the determination of lactulose involves the enzymatic hydrolysis of lactulose and successive treatment of fructose with fructose dehydrogenase in the presence of 3-(4,5-dimethylthiazol-2-yl)-2,5-diphenyltetrazolium bromide and 5-methylphenazinium methyl sulfate, to produce a colored compound that can be detected at 570 nm [43]. A differential pH technique for the determination of lactose and lactulose in milk samples based on changes in the pH owing to enzymatic reactions has also been reported [44]. Lactose was determined by measuring the pH change owing to the reaction of glucose and ATP in the presence of HK before and after treatment of the sample with  $\beta$ -galactosidase. For lactulose determination, the sample was treated with a mixture of  $\beta$ -galactosidase and glucokinase in the presence of ATP. After 3 h, the pH change was measured, HK was added, and the pH change was monitored for 4 h to observe the D-fructose-6-phosphate formation. The most commonly used enzymatic methods are presented in Table 6.2.

#### 6.2.4 Flow-Injection Analysis

Flow-injection analysis (FIA) has been widely used for the determination of carbohydrates in dairy products. It is based on the reproducible injection of samples into a flowing stream of a carrier or reagent solution to the detector while the desired reactions take place. The detector response (absorbance, fluorescence, mass spectra, etc.) yields a calibration curve quantifying the target analyte. Spectrophotometric determination of lactose based on the development of carmine color when lactose reacts with alkaline methylamine using FIA, allows up to forty samples to be analyzed per hour, and lactose concentrations as low as 0.6 mg/mL can be readily detected [45]. Flow-injection technique is well suited for automation of assays based on the enzymatic reactions, and has been successfully applied to the analysis of mono- and disaccharides in milk. Figure 6.1 shows a biosensor composed of the immobilized enzymes,  $\beta$ -galactosidase and GOD, integrated into an FIA system that allows measurement of lactose online in less than 3 min [46]. Ion-exchange polyelectrolytes have been used for the development of glucose and lactose biosensors with high enzyme stability. These biosensors coupled to a flow-injection system allow faster determination of glucose and lactose in milk with high sensitivity and low detection limits [47].

Flow-injection systems have also been used for the determination of lactulose. Consequently, an automated flow analysis method was developed to allow in-line hydrolysis of lactulose by soluble  $\beta$ -galactosidase, and separation of the analyte from the milk matrix by a dialysis unit. The quantity of fructose was determined by using immobilized fructose dehydrogenase and potassium ferricyanide as mediator. The reduced mediator was reoxidized at a screen-printed Pt-electrode [48].

#### 6.2.5 Chromatographic Methods

The simultaneous determination of the different carbohydrates present in dairy products may be achieved by a considerable number of chromatographic methods, including planar chromatography,

**Table 6.2 Enzymatic Methods of Analysis**

Analyte	Enzymatic Medium	Detection System	Refs.
Lactose and galactose	$\beta$ -Galactosidase	Spectrophotometry at 340 nm	[34,35]
	$\beta$ -Galactose dehydrogenase		
	NAD <sup>a</sup>		
Lactose and galactose	$\beta$ -Galactosidase	Spectrophotometry at 415 nm	[36]
	$\beta$ -Galactose dehydrogenase		
	thio-NAD		
Lactose and glucose	$\beta$ -Galactosidase, GOD	Scanning microtitre plate autoreader at 490 nm	[37]
	Iodide, molybdate, polyvinyl alcohol		
Lactose	$\beta$ -Galactosidase and GOD	H <sub>2</sub> O <sub>2</sub> Ag-AgCl electrode	[38]
Lactose	$\beta$ -Galactosidase, GOD, peroxidase, and 5-aminosalicylic acid	Glassy carbon, Pt, and saturated calomel electrodes	[39]
Lactulose	$\beta$ -Galactosidase, GOD, ATP, HK, PGI, <sup>b</sup> NADP, <sup>c</sup> and G-6-PDH <sup>d</sup>	Spectrophotometry at 340 nm	[42]
Lactulose	$\beta$ -Galactosidase, fructose dehydrogenase, MMT, <sup>e</sup> and PMS <sup>f</sup>	Spectrophotometry at 570 nm	[43]
Lactose and lactulose	$\beta$ -Galactosidase, glucokinase, HK, ATP	Differential pH analyzer	[44]

<sup>a</sup> Nicotinamide adenine dinucleotide.

<sup>b</sup> Phosphoglucose isomerase.

<sup>c</sup> Nicotinamide adenine dinucleotide phosphate.

<sup>d</sup> Glucose-6-phosphate dehydrogenase.

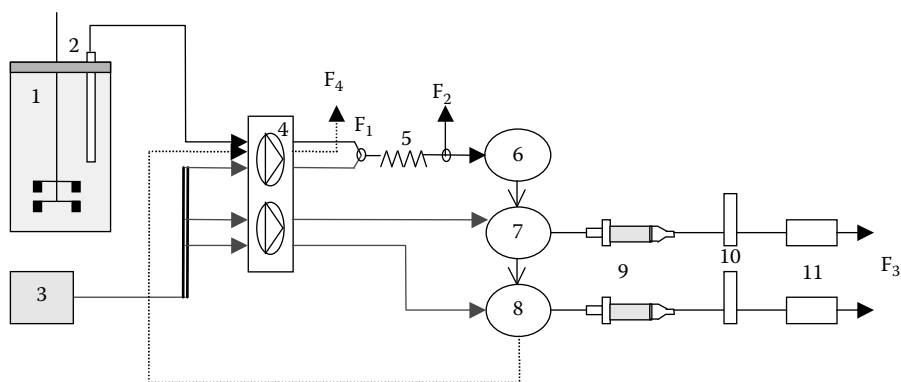
<sup>e</sup> 3-(4,5-Dimethylthiazol-2-yl)-2,5-diphenyltetrazolium bromide.

<sup>f</sup> 5-Methylphenazinium-methyl sulfate.

gas chromatography (GC), and high-performance liquid chromatography (HPLC). These techniques not only provide quantitative information about every analyte in a mixture, but can also be coupled to spectroscopic instruments to obtain structural information. For convenience, prior to the analysis, the carbohydrates are isolated from the insoluble materials such as lipids and proteins, by dialysis [49], centrifugation [50], or precipitation with methanol [51].

### 6.2.5.1 Planar Chromatography

It includes both paper and thin-layer chromatography (TLC). These techniques are low-cost, easy to perform, and simultaneously display the overall components present in the sample, in the chromatogram.



**Figure 6.1** Online FIA measurement system for lactose. (1) Bioreactor, (2) microfiltration membrane, (3) carrier solution, (4) peristaltic pumps, (5) mixer, (6) selection valve, (7 and 8) injection mixers, (9) lactose and glucose biosensors, (10) oxygen electrodes, and (11) amplifiers. (Reprinted from Ferreira, L.S. et al., *Brazil. J. Chem. Eng.*, 21, 307, 2004. With permission.)

#### 6.2.5.1.1 Paper Chromatography

It was one of the earlier chromatographic techniques for carbohydrate analysis, but currently, it is scarcely used. In this technique, mixtures of water and alcohols have been used as eluent in both ascending [52] and descending [53] modes with spray reagents based on anthrone or amine mixtures; the latter has been used for the determination of lactulose in infant formulas.

#### 6.2.5.1.2 Thin-Layer Chromatography

Thin-layer plates have replaced paper, particularly to save time. Silica-gel plates, that basically retain the solutes by adsorption, are impregnated with inorganic salts to introduce new interaction mechanisms and modulate the separation of carbohydrates through complex formation. Boric acid, sodium acetate, and sodium bisulfite have been used for this purpose. Elution has been carried out with aqueous mixtures of alcohols (methanol, ethanol, and isopropanol) or less-polar solvents (acetonitrile, ethyl acetate) [54,55]. The introduction of high-performance thin-layer chromatography (HPTLC) has improved both resolution and quantitative measurements [56], and has also allowed coupling with mass spectrometry (MS). For example, native milk oligosaccharides were separated on  $10 \times 10$  silica-gel plates developed in *n*-butanol/acetic/water (110/45/45) and matrix-assisted laser-desorption ionization with time-of-flight (MALDI-TOF) analyzer was selected as the MS technique. Glycerol was used as the matrix, with an infrared laser for MALDI and an orthogonal TOF for achieving high mass accuracy, allowing a straightforward method with a detection limit of  $\sim 10$  pmol of individual compounds [57].

#### 6.2.5.2 Gas Chromatography

Since its introduction over 60 years ago, GC has been widely used for the analysis of milk carbohydrates. This technique is rapid, easy to automatize, and has a moderate cost. It is also easy

to couple this technique with several spectroscopic techniques, and the MS detector is the most popular technique coupled for obtaining structural information about the analytes.

### 6.2.5.2.1 Derivatization

Prior to GC analysis, a necessary step is to convert the carbohydrates in the volatile derivatives [58,59]. In general, all the active hydrogens should be replaced by apolar groups, such as methyl or trimethylsilyl (TMS) to obtain the corresponding ethers; it is also possible to esterify the hydroxyls to obtain acetates or trifluoroacetates. It is necessary to keep in mind that reducing sugars in solution exist in five tautomeric forms, and thus, the corresponding five derivatives are obtained, giving a high number of chromatographic peaks; these can make the analysis difficult if the number of carbohydrates present is too high. Monosaccharides in milk have been silylated mainly using three reagent types: hexamethyldisilazane (HMDS) + trimethylchlorosilane (TMCS) in pyridine [49], trimethylsilyl imidazole (TMSI), or TMSI dissolved in pyridine [50]. Troyano et al. [6] used very mild reaction conditions to quantitatively silylate the ketoses. This method was also applied to measure the free acetyl-aminosugars in milk [60]. For the determination of the monosaccharide composition of glycoproteins, they are released by treatment with acids such as HF or HCl before they are converted to volatile derivatives [61].

To reduce the number of derivative peaks, another approach is sometimes used: the carbonyl group can be reduced to give an alditol which is a single molecule and hence, will produce a single peak. However, a serious drawback of this approach is that ketoses are transformed into two different isomeric alditols; for example, glucose is converted to sorbitol and mannose to mannitol, whilst fructose gives a mixture of sorbitol and mannitol. Nevertheless, an interesting alternative is to transform the free carbonyl groups into its oximes: the hemiacetal ring is opened, the anomeric center disappears, and two compounds (the *E*- and *Z*-isomers) are produced for every reducing sugar, which are rather stable and easy to silylate. In this way, only two chromatographic peaks are produced for every sugar. A common method (two steps in one pot) is to add hydroxylamine chloride in pyridine (2.5%); the formed oximes are then silylated with HMDS and trifluoroacetic acid. After the reaction, the samples are centrifuged and 1  $\mu$ L of the supernatant is injected into the GC injection port [62,63].

Investigation with the capillary columns requires the use of an internal standard: perseitol, and in particular, methyl- $\alpha$ -galactoside and phenyl- $\beta$ -glucoside, have been widely used for this purpose. The three products fulfill the usual requirements for an internal standard: they are not present in milk, are stable, and are silylated similarly to analytes, displaying an adequate chromatographic response.

In spite of the derivatization step, GC enables high resolution, high sensitivity, and good reproducibility.

### 6.2.5.2.2 Chromatographic Conditions

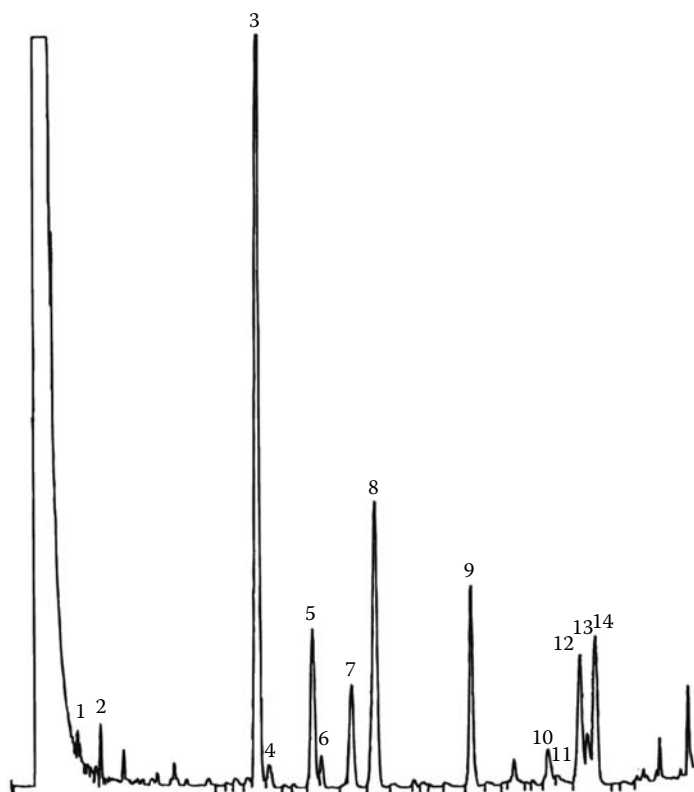
The initial analyses were carried out with packed columns, and their efficiency was low, but adequate to separate the few sugars examined at that time [49]. A micropacked column (2% OV-17 on desilanzed 120/140 Volaspher A-2 in a 3 m  $\times$  1.0 mm i.d. stainless-steel tube) was proposed to improve the analysis of lactulose [51]. At present, the most used columns are those of fused-silica capillary, coated with different stationary phases based on silicones (methyl, phenyl, and cyanopropyl), whose dimensions are usually 20–30 m of length, 0.2–0.33 mm i.d., and 0.2–0.5  $\mu$ m

of film thickness. Several stationary phases with very different polarities have been assayed to separate new carbohydrates formed during heating of milk, such as tagatose [6] and 3-deoxypentulose [64] (Figure 6.2).

As dairy products usually contain mono-, di-, and oligosaccharides, temperature programming is often convenient. The most common programs start at 180°C–200°C to elute the monosaccharides, and then are programmed (sometimes with multistep ramps) until 270°C–290°C to elute lactose. These methods are adequate for most commercial dairy products that do not contain appreciable amounts of oligosaccharides or when their determination is not required. Fortified milk containing maltodextrins (up to maltoheptaose) has been analyzed by GC using a short capillary column (8 m × 0.25 mm × 0.25 μm) coated with CPSil-5CB with a multistep programming temperature starting at 130°C and finishing at 360°C, using TMS oximes as derivatives [65].

### 6.2.5.2.3 Detectors

The most widely used GC detector for carbohydrate analysis is the flame ionization detector (FID): it has no dead-volume, is robust, very sensitive, and has a very wide linear dynamic range.



**Figure 6.2** GC chromatograms of TMS ethers of free monosaccharides in a sterilized milk sample. Peaks: 1 and 2, 2-deoxypentulose; 3, internal standard; 4, 5, and 8, galactose; 6, tagatose; 7 and 9, glucose; 10 and 11, *N*-acetylgalactosamine; 12 and 13, *N*-acetylglucosamine; and 14, *myo*-inositol. (From Troyano, E. et al., *J. Agric. Food Chem.*, 44, 815, 1996. With permission.)



The GC is occasionally coupled with a mass spectrometric detector for identification purposes. Commercial mass detectors for GC are tabletop equipments: the system of choice is electronic impact (EI) with quadrupole analyzer. Identification is easily carried out, as the mass spectra of all TMS derivatives of the monosaccharides and disaccharides present in milk have been published, and most of them can be obtained from the spectral libraries (Wiley and NIST). As the mass spectra of isomers are very similar, the combination of spectral data with elution order or retention indices (from the literature or from the standards) is recommended.

#### 6.2.5.2.4 Applications

The first report on GC–MS analysis of sugars in milk and dairy products was published by Reineccius et al. [49]. Milk was dialyzed and freeze dried, then silylated and analyzed by GC and GC–MS. Galactose, glucose, and lactose could be determined in milk, cream, and cheeses. Slight modifications of this method were used for the quantitative measurements of lactulose [66] and epilactose [7] in heated milks. The introduction of capillary columns helped in the identification of tagatose [6] and 3-deoxypentulose [64], which were found in heated milks, owing to thermal treatments.

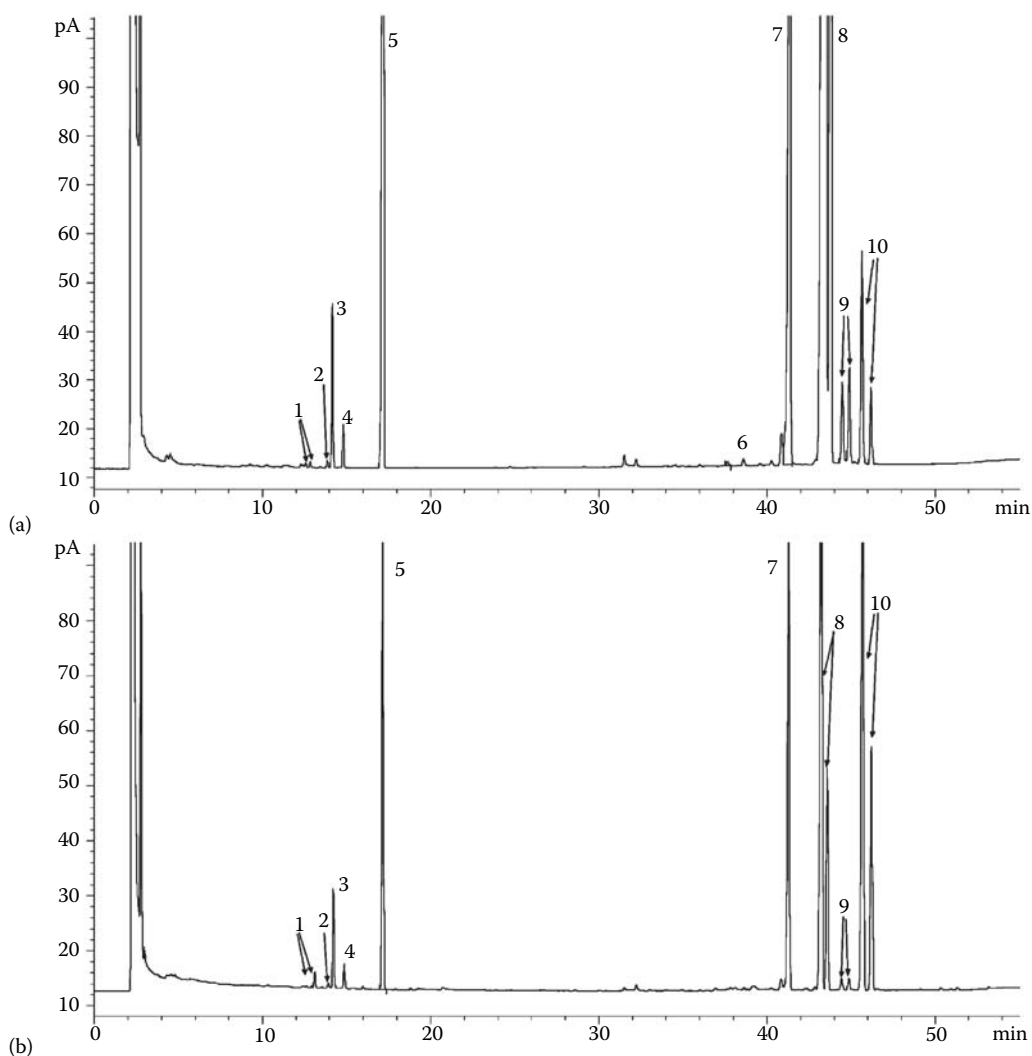
Minor carbohydrates in milk have been also reported by GC, such as *myo*-inositol and traces of *scyllo*-inositol [67], *N*-acetylaminohexoses [60], and sialic acids [61]. Some specific methods have been designed to determine the minute amounts of lactulose in pasteurized milks [68]; the improvements rely on the equilibration of the samples in *N,N*-dimethylformamide to obtain a constant anomeric composition, and the use of a cross-linked stationary phase, (poly-(50% diphenyl/50% dimethylsiloxane)), that allows the separation of sucrose from lactulose and lactose peaks, obtaining a suitable quantification of lactulose in samples, such as condensed and chocolate-based milks, which contain a high concentration of sucrose. Figure 6.3 shows the analysis of a complex mixture of sugars in an infant formula.

Representative methods for the GC analysis of carbohydrates in dairy products are presented in Table 6.3.

#### 6.2.5.3 High-Performance Liquid Chromatography

The HPLC was developed more than 30 years ago, but still remains as one of the most extensively used techniques. It has been widely employed for the separation of a large variety of carbohydrates in foods, as it is particularly advantageous in terms of speed and simplicity of sample preparation. It is possible to inject the sample without a prior derivatization, and obtain a high-resolved chromatogram in a short period of time [72].

The HPLC allows direct detection of carbohydrates, as they can absorb at low-wavelength UV region. However, a detection below 200 nm requires the use of high-grade and expensive reagents, and has low sensitivity and selectivity. The most common sugars-detection system after HPLC separation is the refractive index; however, the response of this detector is very poor and nonspecific, and the elution of carbohydrates must be in isocratic regimen. Therefore, considerable research effort has been directed to design detectors with improved sensitivity and alternative detection systems, such as light-scattering detectors that are semi universal mass detectors providing better sensitivity and baseline stability, and electrochemical detectors [72,73].



**Figure 6.3** GC profiles of TMS oximes of carbohydrates of (a) standard solution and (b) infant formula. Peaks: 1, fructose; 2, galactose; 3, glucose; 4, galactose + glucose; 5 and 7, internal standards; 6, sucrose; 8, lactose; 9, maltulose; and 10, lactose. (From Morales, V. et al., *J. Agric. Food Chem.*, 52, 6732, 2004. With permission.)

#### 6.2.5.3.1 High-Performance Liquid Chromatography Types and Applications

Among the various available chromatographic modes of operation, such as anion or cation exchange, hydrophilic interaction, size exclusion, and reverse phase, the reverse-phase and resin-based systems are the most used in carbohydrate analysis [74,75].

In reverse-phase partition chromatography, separation is based on the principle of hydrophobic interactions resulting from the repulsive forces among a relatively polar solvent, the relatively nonpolar analyte, and the nonpolar stationary phase. Alkylated and aminoalkylated silica gels are

Table 6.3 Some Applications of GC Analysis of Carbohydrates in Dairy Products

<i>Product</i>	<i>Analytes</i>	<i>Internal Standard</i>	<i>Derivatives (Reagents)</i>	<i>Column</i>	<i>Operating Conditions</i>	<i>Ref.</i>
Milks, chocolate milk, sour cream, buttermilk, cheese	Galactose, glucose, lactose	N-Acetyl-glucosamine	TMS ethers (HMDS+DMCS)	1.83 m × 3.2 mm 5% SE-30 on Chromosorb-G	130°C until 270°C at 6°C/min. Coupling to MS	[49]
Human and cow's milk	Myo-inositol and scyl/o-inositol	Triphenyl methane	TMS ethers (TMSI + TMCS)	2 m × 3 mm 5% Ucon LB + 5% SE-30	185°C isothermal	[67]
Pasteurized, ultrahigh temperature (UHT), sterilized and infant milks	Lactulose and lactose	None	TMS ethers (TMSI)	3 m × 3.2 mm 3% OV-17 on Chromosorb W-HP	240°C isothermal	[66]
Cheddar cheese	Galactose, glucose, and lactose	Myo-inositol	TMS ethers (HMDS+DMCS)	3.84 m × 2 mm) 3% OV-1 on Supelcoport	180°C for 7 min, then 6°C/min until 310°C	[69]
Milk of various species	Myo-inositol	Ribitol	TMS ethers (HMDS+DMCS)	1.83 m × 3 mm SE-52 on Gas Chrom Q	100°C for 10 min, then 6°C/min	[70]
Commercial milks	Galactose, lactulose, epilactose, lactose	Phenyl-β-glucoside	TMS ethers (TMSI)	3 m × 1 mm 2% OV-17 in Volaspher A-2	200°C for 2 min, then 15°C/min until 270°C	[50]

Pasteurized, UHT, and sterilized milks	Galactose, glucose, <i>myo</i> -inositol, tagatose, and 2-deoxypentulose	Methyl- $\alpha$ -galactoside	TMS ethers (TMSI/TMCS)	18 m $\times$ 0.22 mm $\times$ 1.0 $\mu$ m with AT-1000	180°C isothermal confirmation by MS	[64]
Pasteurized, dried, UHT, and sterilized milks	Galactose, glucose, <i>myo</i> -inositol, tagatose, 2-deoxypentulose, <i>N</i> -acetyl-glucosamine, and <i>N</i> -acetyl-galactosamine	Methyl- $\alpha$ -galactoside	TMS ethers (TMSI/TMCS)	10 m $\times$ 0.2 mm $\times$ 0.33 $\mu$ m with HP-1	175°C for 17 min, then 5°C/min until 195°C	[60]
$\kappa$ -Casein macropeptides from cow, ewe, and goat's milk	<i>N</i> -Acetyl-neuraminic, <i>N</i> -glycolyl-neuraminic acids, galactose, and galactosamine	<i>Myo</i> -inositol	TMS ethers (TMSI/TMCS)	25 m $\times$ 0.25 mm $\times$ 0.25 $\mu$ m with methyl silicone	180°C for 2 min, then 2°C/min to 200° held 10 min and 20°C/min until 270°C	[61]
Infant formulas	Fructose, galactose, glucose, sucrose, lactose, maltulose, maltose	<i>Myo</i> -inositol for monosaccharides and trehalose for disaccharides	TMS oximes (hydroxylamine chloride + TMSI + TMCS)	25 m $\times$ 0.25 mm $\times$ 0.25 $\mu$ m with OV-101	180°C–280°C at 2°C/min, held for 1 min, then to 300°C at 10°C/min	[71]
Pasteurized, UHT, sterilized powder, and condensed milks	Lactulose, lactose, and sucrose	Phenyl- $\beta$ -glucoside	TMS ethers (TMSI)	30 m $\times$ 0.32 mm $\times$ 0.5 $\mu$ m with SPB™ -17	235°C for 9.5 min then 20°C/min until 270°C	[68]

most frequently used as stationary phase in combination with aqueous methanol or aqueous acetonitrile as mobile phase, and the separation is carried out by hydrophobic and polar interactions and partition [76]. The use of a high percentage of an organic modifier (e.g., acetonitrile) in the eluent can limit the solubility of the carbohydrates. Furthermore, the use of amino-phases has a noticeable drawback related to the tendency of glycosamine formation with reducing sugars [77].

Bonded silica-gel columns (amino, cyano) are capable of resolving sucrose and lactose, but not glucose and galactose. Therefore, they are not adequate for the analysis of sugars in fermented dairy products containing these monosaccharides [78,79]. Some studies on carbohydrates in dairy products using this mode of chromatography are listed in Table 6.4.

Ion-exchange chromatography (IEC) has almost universally replaced the traditional adsorption chromatography based on charcoal–celite mixtures developed in the early 1950s, which was capable of separating series of oligosaccharides up to a degree of polymerization (DP) of 8–10, using ethanol or butanol gradients in water as eluent [85]. Carbohydrates are separated on the basis of differences in the net charge using two types of ion-exchanger: anionic and cationic, where the compounds are negatively and positively charged, respectively. The most commonly encountered ion-exchange materials are cross-linked polymers of styrene and divinyl benzene with strong cation- or anion-exchanging attached groups [86].

Several methods based on cationic-exchange HPLC chromatography have been optimized to analyze carbohydrates in a number of dairy products, using different stationary and mobile phases, such as Aminex with calcium as counterion, and Sugar Pak (Table 6.5). An important

**Table 6.4 RP-HPLC Methods to Analyze Carbohydrates on Dairy Products**

<i>Dairy Product</i>	<i>Analytes</i>	<i>Column</i>	<i>Mobile Phase Composition and Elution Mode</i>	<i>Ref.</i>
Ice cream, ice milk, plain yoghurt, blueberry yoghurt	Lactose, sucrose, maltose, fructose, glucose	μ-Bondapak	Acetonitrile:water 80:20 (isocratic)	[80]
Chocolate, whole, and skimmed milk	Lactose	Micropack Si-10	Acetonitrile:water 80:20 (isocratic)	[81]
Differentiation of heated milks (UHT and sterilized)	Lactose, lactulose	Bounded aminocarbohydrates (30°C)	Acetonitrile:water (80:20) (isocratic)	[82]
Infant formulas	Glucose, galactose, sucrose, maltose, lactose <sup>a</sup>	Spherisorb NH <sub>2</sub>	Acetonitrile/HCl 0.01 M (84:16) (isocratic)	[83]
Infant formulae, formulae for pregnant women	Fructose, sucrose, lactulose, lactose	Tracer carbohydrates (25°C)	Acetonitrile:water (75:25) (isocratic)	[84]

*Note:* Detection, refractive index.

<sup>a</sup> Simultaneous organic acids (uric and orotic acids) analysis (UV detection at 280 nm).

**Table 6.5 Cationic-Exchange HPLC Methods to Analyze Carbohydrates in Dairy Products**

<i>Dairy Product</i>	<i>Analytes</i>	<i>Column (Cationic Exchange)</i>	<i>Mobile Phase Composition</i>	<i>Ref.</i>
Strawberry yogurt; plain yogurt; buttermilk milk; dried acid, and sweet whey	Lactose, glucose, galactose	Aminex HPX-87 (calcium form; 80°C)	Water	[74]
Lactose-reduced milk	Lactose, glucose, galactose	Aminex HPX-87 (calcium form; 80°C)	Water	[87]
Flavored yogurt	Sucrose, lactose, glucose, galactose, fructose	Sugar Pak (85°C–90°C)	Water	[78]
Cheddar cheese	Lactose, glucose, galactose <sup>a</sup>	Aminex HPX-87H (H <sup>+</sup> form; 80°C)	0.009 N H <sub>2</sub> SO <sub>4</sub>	[88]
Infant formulas	Glucose, lactose, lactulose	Aminex HPX-87P (calcium form; 85°C)	Water	[89]
Milk; whey	Lactose	Sugar Pak (90°C)	Water	[90]
Direct and indirect UHT milk	Lactulose	Aminex HPX-87P (75°C)	Water	[91]
Ovine milk, ovine yoghurts with different fat content	Lactose, galactose, and organic acids: lactic, citric, pyruvic	Aminex HPX-87H (35°C)	5 mM H <sub>2</sub> SO <sub>4</sub>	[92]

*Note:* Detection, refractive index; elution mode, isocratic.

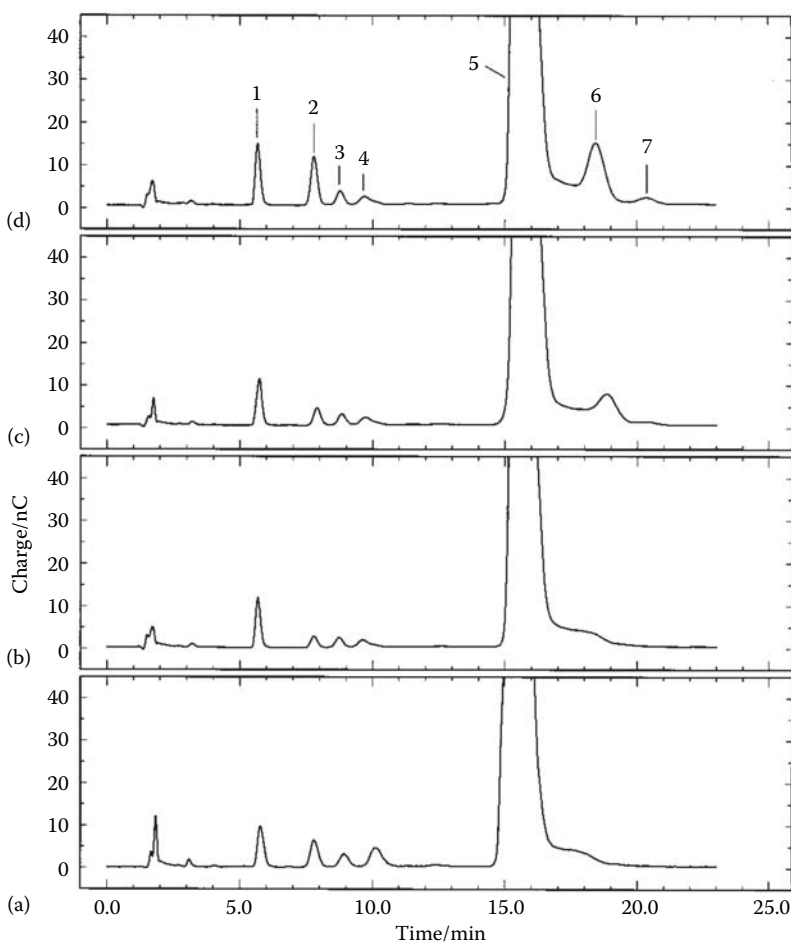
<sup>a</sup> Simultaneous organic acids analysis (UV detection at 220 or 285 nm).

difference between the resin and bonded-phase columns is that the former requires elevated operating temperature. Furthermore, Aminex-type columns may be used successfully for the monosaccharides and oligosaccharides separations, but are not very useful for the separation of disaccharides (sucrose and lactose) [72,78]. Sugar Pak-type columns have produced acceptable resolution of sucrose, lactose, glucose, galactose, and fructose, without any interference owing to other components, such as organic acids, in fermented dairy products [78].

High-performance anion-exchange chromatography (HPAEC) coupled with pulsed amperometric detection (PAD) is an alternative analytical technique that provides very high sensitivity and good resolution for nonderivatized carbohydrates [93]. It was developed at the beginning of 1980s, and permits a direct quantification of nonderivatized carbohydrates at picomole levels with minimal sample preparation and cleanup. The separation of carbohydrates and the order of elution is based on the differences in their  $pK_a$  values. At high pH, the carbohydrates are at least partially ionized, have a net negative charge, and therefore, can be separated by anion-exchange

mechanisms. The columns are packed with poly(styrene-divinylbenzene)-based stationary phases functionalized with alkyl quaternary ammonium groups [77].

The main problem of HPAEC-PAD is the possible coelution of closely related carbohydrates, as they have very similar retention times. Cataldi et al. [94] optimized a robust, rapid, and sensitive HPAEC-PAD method using 10–12 mM NaOH modified with 1–2 mM barium acetate, which allows the separation and quantitative determination of lactulose and lactose along with other carbohydrates in heated milks. The different chromatographic profiles of carbohydrates corresponding to raw, pasteurized, UHT, and in-container sterilized milks are presented in Figure 6.4. Table 6.6 shows the different optimized HPAEC-PAD methods to analyze carbohydrates in dairy products. Despite the complexity of milk and the large concentration imbalances between lactose and minor carbohydrates, Cataldi et al. [97] established



**Figure 6.4** HPAEC-PAD chromatograms of (a) raw cow's milk, (b) pasteurized milk, (c) UHT milk, and (d) in-container sterilized milk. All the samples were diluted 100 times with pure water. Peak identification: 1, IS; 2, galactose; 3, glucose; 4, GalNAc; 5, lactose; 6, lactulose; and 7, epilactose. (From Cataldi, T.R.I. et al., *Anal. Chem.*, 71, 4919, 1999. With permission.)

Table 6.6 HPAEC-PAD Methods to Analyze Carbohydrates in Dairy Products

<i>Dairy Product</i>	<i>Analytes</i>	<i>Column (HPAEC-PAD)</i>	<i>Mobile Phase Composition and Elution Mode</i>	<i>Detection</i>	<i>Ref.</i>
Different types of hard and fresh soft cheeses	Glucose, galactose, lactose	Dionex AS6A column with AG6A guard column	Water/NaOH (gradient)	PAD	[95]
Infant formula, fruit yogurt	Galactose, glucose, saccharose, fructose, lactose; Maltodextrins G2-G7	CarboPak PA1 column and CarboPak PA1 guard column	Water/NaOH/NaOAC (gradient)	PAD	[79]
Parmesan cheese	Galactose	CarboPak PA1 column and CarboPak PA1 guard column	NaOH (isocratic)	PED	[18]
Different types of commercial cheeses	Lactose	Dionex PA1 ion exchange column	NaOH/NaOAC (gradient)	PAD	[90]
Powder infant formulas (characterization)	Glucose, fructose, lactose, sucrose, maltose	CarboPak PA1 column and CarboPak PA1 guard column	150 mM NaOH/150 mM NaOH/600 mM NaOAC (gradient)	PED	[96]
Commercial milks with different thermal treatments	Galactose, glucose, N-acetylglucosamine, lactose, lactulose, epilactose	CarboPak PA1 column and CarboPak PA1 guard column	10 mM NaOH/2 mM Ba(OAC) <sub>2</sub> (isocratic)	PAD	[94]
Raw milk from different species: buffalo, cow, goat, and sheep; mozzarella cheese, whey	Galactose, glucose, N-acetylglucosamine, Lactose	CarboPak PA1 column and CarboPak PA1 guard column	10 mM NaOH/1 mM Ba(OAC) <sub>2</sub> (isocratic)	PAD	[97]

*Note:* Detection. PAD, pulsed amperometric detection; work electrode, Au; reference electrode, Ag/AgCl; PED, integrated amperometric detection; work electrode, Au; reference electrode, Ag/AgCl.



elution conditions that allow the quantification of minor milk sugars by HPAEC-PAD with high sensitivity.

Human milk contains a large variety of oligosaccharides with the potential to modulate the gut flora, affect different gastrointestinal activities, and influence inflammatory processes [98]. Oligosaccharide analysis is very difficult not only owing to the low and variable (depending on the lactational stage) content of oligosaccharides, but also owing to the complexity of their structures. Therefore, it is necessary to have appropriate and powerful analytical methods and equipments, such as HPAEC-PAD and CE, which allow the detection of very low level of these oligosaccharides (at picomole and femtomole concentrations, respectively) [99].

The HPAEC-PAD provides high-resolution separations of neutral and charged oligosaccharides differing in branch length, linkage composition, and positional isomerism [100]. Twenty oligosaccharides (acidic and neutral) and *N*-acetylneuraminic acid were determined by HPAEC-PAD in a crude human-milk oligosaccharide fraction, obtained by gel-permeation chromatography [101]. Furthermore, neutral oligosaccharides (GOS) derived from lactose hydrolysis using different  $\beta$ -galactosidases have been identified and quantified by HPAEC-PAD [15,102,103]. Galactobioses ( $\beta$  1–3 and 1–6) allolactose, 6' galactosyl-lactose, and 3' galactosyl-lactose were detected in enzymatic lactose hydrolyzates (Figure 6.5). In addition, two novel trisaccharides obtained by enzymatic transglycosylation of lactulose were isolated and characterized as 6' galactosyl-lactulose and 1 galactosyl-lactulose [104,105].

### 6.2.5.3.2 High-Performance Liquid Chromatography–Mass Spectrometry

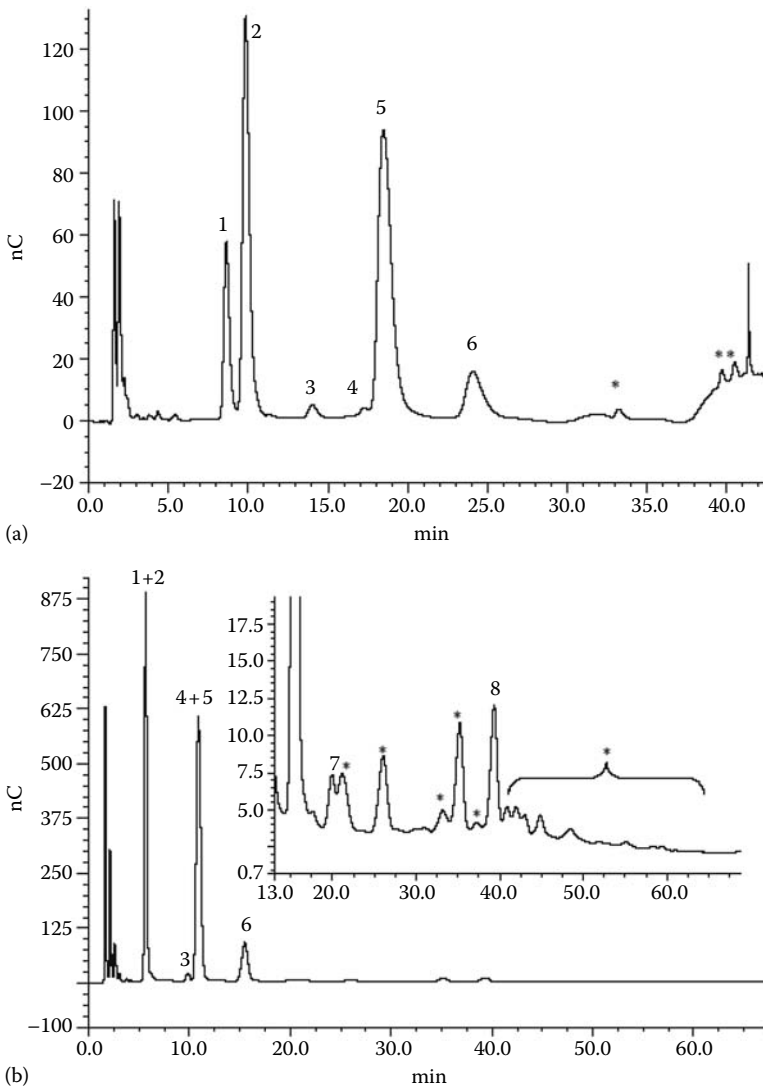
An inherent disadvantage of HPLC is that very limited structure information can be derived from the retention times of carbohydrates. Coupling of HPLC with MS (HPLC–MS) represents a straightforward approach to obtain valuable information on the composition of oligosaccharides [75].

Over the last decades, the MS has developed into one of the most important techniques for analyzing organic molecules. Oligosaccharides samples, in their native states or as different derivatives, have been analyzed by MS using a large variety of instruments [106].

**6.2.5.3.2.1 Oligosaccharides**—A method using nano-reverse-phase HPLC (*n*-RP-HPLC) with UV detection and online coupling electrospray ionization (ESI) MS and off-line MALDI-TOF MS, has been optimized to separate and identify free oligosaccharides from human milk. For the analysis, the sample was submitted to a simple cleanup for deproteinization and defatting, before derivatization of oligosaccharides, and major human milk oligosaccharides were detected (fucosyl-lactose, lacto-*N*-tetraose, lacto-*N*-fucopentaose, lacto-*N*-difucohexaose) [75].

Although HPAEC-PAD is the most widely used technique for the separation and identification of oligosaccharides, the use of mobile phase containing sodium hydroxide and sodium acetate makes the coupling with a mass spectrometer unfeasible. Online desalting of eluent could be an alternative to solve this problem, and accordingly, Martinez-Ferez et al. [10] quantified a large number and variety of neutral and acidic oligosaccharides in goat's milk, describing 15 new structures, by HPAEC-PAD, and characterized them by fast bombardment mass spectrometry (FAB-MS). The oligosaccharides content in goat's milk was observed to be higher than those found in bovine and ovine milk.

The HPLC–MS method, in which the carbohydrates are first separated by HPLC on the graphitized carbon columns using aqueous acetonitrile and then identified by MS, is used for the



**Figure 6.5** HPAEC-PAD chromatograms of GOS production during enzymatic hydrolysis of lactose (285 mg/mL) with Pectinex Ultra SP-L (16 U/mL) after 7 h at 60°C and pH 6.5: Peaks: 1, galactose; 2, glucose; 3, galactobiose; 4, allolactose; 5, lactose; 6, 6' galactosyl-lactose; 7, 3 galactosyl glucose; 8, 3' galactosyl-lactose; and HRTGOS: high retention time GOS. (From Cardelle-Cobas, A. et al., *J. Sci. Food Agric.*, 88, 954, 2008. With permission.)

analysis of milk oligosaccharides. Fucosylated and sialylated oligosaccharides isolated from lipids and proteins of human milk have been analyzed by a combination of techniques, including microchip liquid chromatography mass spectrometry (HPLC-Chip/MS) and matrix-assisted laser desorption/ionization Fourier transform ion cyclotron resonance mass spectrometry (MALDI-FT ICR MS) [107]. Furthermore, Broberg [106] using graphitized columns, analyzed human milk oligosaccharides, derivatized by reductive amination with *N,N*-dimethylation, by HPLC-ESI

ion-trap mass spectrometry (ESI-ITMS). The MS/MS operation of the mass spectrometer allowed the differentiation of isomeric milk oligosaccharides. These online coupling methods allow the detection at femtomole level.

## 6.2.6 *Capillary Electrophoresis*

Capillary electrophoresis (CE) is a powerful microanalytical technique based on the electrophoretic separation in narrow capillaries. The high speed of analysis, the minute amounts of analyte required, and the high resolution make CE an attractive method to separate a wide range of charged and uncharged compounds, including substances of food interest [108].

### 6.2.6.1 *Capillary Electrophoresis Modes*

The CE has emerged as an alternative to current analytical techniques for carbohydrates. However, carbohydrates present high ionization constants ( $pK_a$  values of 12 or higher) and therefore, do not carry electrical charges at neutral pH. This, along with the fact that carbohydrates do not absorb UV light above 200 nm, hinders its analysis by CE. To overcome both the problems, different procedures have been developed, such as derivatization with direct detection using chromophore- and fluorescent-probe carriers of electrical charges, to facilitate detection via UV-VIS absorbance or laser-induced fluorescence (LIF). A large variety of derivatization reagents have been suggested for carbohydrate analysis [109,110]; however, although derivatization methods lead to improved sensitivity and resolution, several drawbacks are often encountered, such as difficult control problems owing to a different reactivity of derivatizing reagent for analytes, formation of several adducts, etc. [111].

An alternative methodology that allows CE analysis of underivatized carbohydrates has also been developed. This includes the use of high-alkaline electrolyte, to ionize the carbohydrates and make them suitable for indirect UV detection, using chromophore compounds and modifiers (background electrolyte, BGE) to reverse the direction of electroosmotic flow inside the capillary and promote the comigration of the analytes [93,100,112,113].

Ionization of carbohydrates at high pH values also allows the CE analysis with electrochemical detection using gold or copper electrodes [114,115]. Complexation of alternate hydroxyl groups with borate, and electrochemical and amperometric detection is another alternative for CE analysis of carbohydrates without derivatization [116].

### 6.2.6.2 *Applications*

The different optimized CE methods to analyze carbohydrates in different types of dairy products are shown in Table 6.7. Major sialylated acidic oligosaccharides, including structural isomers, of pooled human milk have been quantified using a sensitive and highly reproducible high-performance capillary electrophoresis (HPCE)-UV detection method [118]. In addition, GOS derived from lactose hydrolysis with different types of  $\beta$ -galactosidases have been quantified by CE and UV detections [102,119]. The coupling of CE-MS can provide important advantages in food analysis, because of the combination of the high separation capabilities of CE and the powerful identification and confirmation abilities of MS, although there are other very well-assessed chromatographic techniques.

**Table 6.7 CE Methods to Analyze Carbohydrates in Dairy Products**

<i>Product</i>	<i>Analytes</i>	<i>Background Electrolyte</i>	<i>Detection Method</i>	<i>Ref.</i>
<b>Without Derivatization</b>				
Fresh milk; dairy products	Sucrose, glucose, fructose, lactose	1-Naphthylacetic acid (NAA)	Indirect UV: 222 nm	[111]
Yogurt	Lactose sucrose	Cetyltrimethylammonium hydroxide (CTAH) and 2,6 pyridinedicarboxylic acid (PDC)	Indirect UV: 350 nm	[93]
Yogurt, different varieties of cheese	Lactose	Hexadecyltrimethyl ammonium bromide (CTAB)	Indirect UV: 230 nm	[112]
Powdered milk, skimmed milk ready to drink milk with chocolate, natural, and flavored yogurts	Galactose, glucose, fructose, lactose, sucrose	Hexadecyltrimethylammonium bromide (CTAB) (electrolyte: NaOH; chromophore: sorbate ion)	Indirect UV	[113]
Sugar-free milk powder (free and full cream)	Lactose	—	Electrochemical detection	[114]
<b>With Derivatization</b>				
Infant milk; powder milk	Lactose	Sodium tetraborate or boric acid	<i>p</i> -Nitroaniline (PNA) (derivatizing agent), UV 406 nm (light-emitting diode, LED)	[117]

### 6.2.7 Mass Spectrometry

The MS is a technique that produces a mass spectrum by converting the analytes of a sample into rapidly moving gaseous ions, and resolving the ions on the basis of their mass-to-charge ( $m/e$  or  $m/z$ ) ratios. In addition to its use as a detector in chromatography, several techniques for direct analysis of oligosaccharides have been introduced.

Perhaps, MALDI (in different modes and couplings) is the most popular among them. In MALDI, sample molecules and a special matrix are codeposited on a laser target. The matrix absorbs the laser energy and promotes the ionization of the sample. This ionization mode usually works with a TOF analyzer. The MALDI-TOF spectrum gives information about the molecular weight of the polymer, their units, as well as the finer structural details.

The analysis of milk oligosaccharides is difficult, as besides their complexity, they contain labile fucosylated and sialylated components. Therefore, a number of different matrices have been assayed to control the ion stability and the extent of fragmentation, and different parameters, such as sets of layers in the matrices, additives, ion modes, etc., have been proposed [120].

Structural elucidation can also be performed through ESI with an ion-trap detector, which is capable of performing successive fragmentations on selected ion fragments (MS/MS or MS<sup>n</sup>) after off-line separation using different techniques. The fragmentation spectra of negative ions provide information on linkage types and branching position, including details about fucose residues [121]. More sophisticated couplings, such as MALDI-TOF/TOF-MS/MS have shown new fragmentation pathways, and provided the possibility of mapping the present linkage positions [122].

### 6.2.8 Nuclear Magnetic Resonance Spectroscopy

Nuclear magnetic resonance (NMR) spectroscopy allows the direct analysis of milk components without sample preparation. The large signal from water at 4.65 ppm is suppressed in the <sup>1</sup>H NMR spectrum, and the quantitative determination of lactose is achieved by measurement of the intensity of the 3.40–3.90 ppm signals owing to lactose [123].

One of the most useful application of NMR in dairy products is the structural and conformational characterization of oligosaccharides from milk and colostrum of different species. Monosaccharide composition, chain length, and linkage type have a major influence on the biological activity of these compounds; hence, the characterization of milk oligosaccharides by NMR techniques has been a topic of interest since many years.

Prior to analysis, oligosaccharides have to be extracted from the sample and the analysis can be achieved by either <sup>1</sup>H or <sup>13</sup>C spectra. Although one-dimensional (1D) NMR spectra are generally used, the two-dimensional (2D) techniques have also been applied [124,125].

Currently, more than ninety milk oligosaccharides have been identified. The NMR studies have shown that they may be constituted by neutral compounds (galactose, *N*-acetylglucosamine, and often fucose linked to a lactose core), or may also contain *N*-acetyl-neuraminic acid [26]. Furthermore, the structure of oligosaccharides originated during enzymatic hydrolysis of lactose and lactulose have also been determined. They mainly consist of a mixture of di- and trisaccharides, and trace amounts of higher oligosaccharides [15,105].

The <sup>1</sup>H NMR spectroscopy combined with electrospray mass spectrometry (ESMS) has also been used to determine the structures of various nonfucosylated and fucosylated neutral oligosaccharides from human milk [126].

## References

1. Urashima, T. et al. Characterization of oligosaccharides in milk of a mink, *Mustela vison*, *Comp. Biochem. Physiol. A.*, 142, 461, 2005.
2. Uemura, Y. et al. Structural determination of oligosaccharides in the milk of an Asian elephant (*Elephas maximus*), *Comp. Biochem. Physiol. A.*, 145, 468, 2006.
3. Nickerson, T.A. Lactose, in: *Fundamentals in Dairy Chemistry*, 2nd edn., Webb, B.H., Johnson, A.H., and Alford, J.A., eds., Avi Publishing Co., Westport, CT, 1974, Chapter 6.
4. Olano, A., Calvo, M.M., and Corzo, N. Changes in the carbohydrate fraction of milk during heating processes, *Food Chem.*, 31, 259, 1989.

5. Calvo, M.M. and Olano, A. Formation of galactose during heat treatment of milk and model systems, *J. Dairy Res.*, 56, 737, 1989.
6. Troyano, E. et al. Gas chromatographic analysis of free monosaccharides in milk, *Chromatographia*, 32, 379, 1991.
7. Martínez-Castro, I. and Olano, A. Influence of thermal processing on carbohydrate composition of milk, formation of epilactose, *Milchwissenschaft*, 35, 5, 1980.
8. Newburg, D.S. and Neubauer, S.H. Carbohydrates in milks: Analysis, quantities, and significance, in: *Handbook of Milk Composition*, Jensen, R.G., ed., Academic Press, San Diego, CA, 1995, Chapter 4.
9. Gnoth, M. et al. Human milk oligosaccharides are minimally digested in vitro, *J. Nutrition*, 130, 3014, 2000.
10. Martínez-Ferez, A. et al. Goat's milk as a natural source of lactose-derived oligosaccharides: Isolation by membrane technology, *Int. Dairy J.*, 16, 173, 2006.
11. Joung, H.K. and Cheong, W.J. Simultaneous quantitative determination of mono-, di-, tri-, tetra-, and pentasaccharides in yogurt products by a simple HPLC system with a refractive index detector, *Bull. Korean Chem. Soc.*, 22, 123, 2001.
12. Lamoureux, L., Roy, D., and Gauthier, S.F. Production of oligosaccharides in yogurt containing Bifidobacteria and yogurt cultures, *J. Dairy Sci.*, 85, 1058, 2002.
13. Yadav, H., Jain, S., and Sinha, P.R. Formation of oligosaccharides in skim milk fermented with mixed dahi cultures, *Lactococcus lactis* ssp. *diacetylactis* and probiotic strains of lactobacilli, *J. Dairy Res.*, 74, 1, 2007.
14. Mahoney, R.R. Galactosyl-oligosaccharide formation during lactose hydrolysis: A review, *Food Chem.*, 63, 147, 1998.
15. Martínez-Villaluenga, C. et al. Optimization of conditions for galactooligosaccharide synthesis during lactose hydrolysis by  $\beta$ -galactosidase from *Kluyveromyces lactis* (Lactozym 3000 L HP G), *Food Chem.*, 107, 258, 2007.
16. Boon, M.A., Janssen, A.E.M., and Van't Riet, K. Effect of temperature and enzyme origin on the enzymatic synthesis of oligosaccharides, *Enzyme Microb. Technol.*, 26, 271, 2000.
17. Mukherjee, K.K. and Hutkins, R.W. Isolation of galactose-fermenting thermophilic cultures and their use in the manufacture of low browning mozzarella cheese, *J. Dairy Sci.*, 77, 2839, 1994.
18. Gopal, P.K. and Richardson, R.K. A rapid and sensitive method for estimation of galactose in parmesan cheese, *Int. Dairy J.*, 6, 399, 1996.
19. Blais, B.W. and Vaillhen, C. A novel enzymatic microassay for the determination of lactose in grated parmesan cheese, *Food Control*, 6, 215, 1995.
20. Pollman, R.M. Detection of adulteration in grated cheese by calcium, phosphorus, magnesium and lactose indices, *J. Assoc. Off. Anal. Chem.*, 47, 1062, 1984.
21. AOAC. Lactose, in: *Official Methods of Analysis*, 15th edn., Helrich, K., ed., Association of Official Analytical Chemists, Washington, DC, 1990, 810.
22. AOAC. Lactose. Lane-Eynon general volumetric method, in: *Official Methods of Analysis*, 12th edn., Horwitz, W., ed., Association of Official Analytical Chemists, Washington, DC, 1975, 576.
23. Determination of the lactose content of milk, IDF Standard 28 A, 1974.
24. Fagen, H.J., Sibbach, E., and Hussong, R.V. The use of anthrone for the quantitative estimation of lactose in dairy products, *J. Dairy Sci.*, 37, 10, 1954.
25. Popescu, M., Zglimbea, L., and Bragarea, S. A comparative study of the colorimetric methods for lactose determination, *Rev. Roum. Chim.*, 39, 1001, 1994.
26. Nakamura, T. and Urashima, T. The milk oligosaccharides of domestic farm animals, *Trends Glycosci. Glycotechnol.*, 16, 135, 2004.
27. Nickerson, T.A., Vujicic, I.F., and Lin, A.Y. Colorimetric estimation of lactose and its hydrolytic products, *J. Dairy Sci.*, 59, 386, 1976.
28. Adachi, S. Spectrophotometric determination of lactulose with methylamine, *Anal Chem.*, 37, 896, 1965.

29. Zagrodzki, S., Kulagowska, A., and Kroj, B.W. Lactulose assay in dairy products, *Qual. Plant. Mater. Veg.*, 16, 102, 1968.
30. Adhikari, A.K., Sahai, D., and Mathur, O.N. A rapid spectrophotometric method for quantitative determination of lactulose in heated milk and milk products, *Lait*, 71, 555, 1991
31. AOAC. Lactose. Infrared milk analysis, in: *Official Methods of Analysis*, 18th edn., Horwitz, W., ed., Association of Official Analytical Chemists, Washington, DC, 3, 25, 2005.
32. Linch, J.M. et al. Precalibration evaluation procedures for mid-infrared milk analyzers, *J. Dairy Sci.*, 89, 2761, 2006.
33. Sasic, S. and Ozaki, Y., Short-wave near-infrared spectroscopy of biological fluids. 1. Quantitative analysis of fat, protein and lactose in raw milk by partial least-squares regression and band assignment, *Anal. Chem.*, 73, 64, 2001.
34. Coffey, R.G. and Reithel, F.J. An enzymic determination of lactose, *Anal. Biochem.*, 32, 229, 1969.
35. Lynch, J.M. and Barbano, D. Determination of the lactose content of fluid milk by spectrophotometric enzymatic analysis using weight additions and path length adjustment: Collaborative study, *J. AOAC Intern.*, 90, 196, 2007.
36. Shapiro, F., Shamay, A., and Silanikove, N. Determination of lactose and D-galactose using thio-NAD<sup>+</sup> instead of NAD<sup>+</sup>, *Int. Dairy J.*, 12, 667, 2002.
37. Blais, B.W. and Vailhen, C. A novel enzymatic microassay for the determination of lactose in grated parmesan cheese, *Food Control.*, 6, 215, 1995.
38. Jäger, A. and Bilitewski, U. Screen-printed enzyme electrode for the determination of lactose, *Analyst*, 125, 1285, 2000.
39. Eshkenazi, I., Maltz, E., and Zion, B. A three-cascade-enzymes biosensor to determine lactose concentration in raw milk, *J. Dairy Sci.*, 83, 1939, 2000.
40. Yang, W.Y. et al. Detection of lactose in milk samples using a wireless multi-enzyme biosensor, *Sens. Lett.*, 5, 405, 2007.
41. Stoica, L. et al. Third-generation biosensor for lactose based on newly discovered cellobiose dehydrogenase, *Anal. Chem.*, 78, 393, 2006.
42. Milk. Determination of lactulose content. Enzymatic method, *International IDF Standard*, 175, 1995.
43. Amine, A. et al. A new enzymatic spectrophotometric assay for the determination of lactulose in milk, *Anal. Chim. Acta*, 406, 217, 2000.
44. Luzzana, M. et al. Milk lactose and lactulose determination by the differential pH technique, *Lait*, 83, 409, 2003.
45. Narinesingh, D. et al. Improved spectrophotometric determination of lactose in milk using flow-injection analysis, *Anal. Chim. Acta*, 258, 141, 1992.
46. Ferreira, L.S. et al. A lactose FIA-biosensor system for monitoring and process control, *Brazil. J. Chem. Eng.*, 21, 307, 2004.
47. Lukacheva, L.V. et al. Determination of glucose and lactose in food products with the use of biosensors based on Berlin blue, *J. Anal. Chem.*, 62, 388, 2007.
48. Mayer, M. et al. Automated determination of lactulose in milk using an enzyme reactor and flow analysis with integrated dialysis, *Anal. Chim. Acta*, 324, 37, 1996.
49. Reineccius, G.A., Kavanagh, T.E., and Keeney, P.G. Identification and quantitation of free neutral carbohydrates in milk products by gas-liquid chromatography and mass spectrometry, *J. Dairy Sci.*, 53, 1018, 1970.
50. Sanz, M.L. and Martínez-Castro I. Recent developments in sample preparation for chromatographic analysis of carbohydrates, *J. Chromatogr. A*, 1153, 74, 2007.
51. Olano, A., Calvo, M.M., and Reglero, G. Analysis of free carbohydrates in milk using micropacked columns, *Chromatographia*, 21, 538, 1986.
52. Toba, T. and Adachi, S. Specific color-reaction for detection of 1,2-linked reducing disaccharides on paper and thin-layer chromatograms, *J. Chromatogr. A*, 154, 110, 1978.

53. Bernhart, F.W. et al. Lactulose in modified milk products for infant nutrition, *J. Dairy Sci.*, 48, 399, 1965.
54. Siegenthaler, U. and Titter, W. Eine rasche DC-Methode zum Nachweis von Mono- und Disacchariden in Milchlischgetraenken und Joghurt, *Mitteilungen Geb. Lebensm. Hyg.*, 68, 448, 1977.
55. Martínez-Castro, I. and Olano, A. Ready detection of small amounts of lactulose in dairy products by thin-layer chromatography, *Chromatographia*, 14, 621, 1981.
56. Bosch-Reig, F. et al. Separation and identification of sugars and maltodextrines by TLC: Application to biological fluids and human milk, *Talanta*, 39, 1493, 1992.
57. Dreisewerd, K. et al. Analysis of native milk oligosaccharides directly from thin-layer chromatography plates by matrix-assisted laser desorption/ionization orthogonal-time-of-flight mass spectrometry with a glycerol matrix, *J. Am. Soc. Mass Spectrom.*, 17, 139, 2006.
58. Knapp, D.R. *Handbook of Analytical Derivatization Reactions*, Wiley & Sons, Inc., New York, 1979, Chapter 13.
59. Rojas-Escudero, E. et al. Optimization of carbohydrate silylation for gas chromatography, *J. Chromatogr. A*, 1027, 117, 2004.
60. Troyano, E. et al. Monosaccharides and myo-inositol in commercial milks, *J. Agric. Food Chem.*, 44, 815, 1996.
61. Moreno, F.J. et al. Analysis of monosaccharides in bovine, caprine, and ovine K-casein macropeptide by gas chromatography, *Chromatographia*, 53, 525, 2001.
62. Adachi, S. and Yamaji, A. The determination of lactose in milk: A comparison of gas-liquid chromatography with the Lane & Eynon method, *J. Dairy Res.*, 45, 127, 1978.
63. García-Baños, J.L., Olano, A., and Corzo, N. Determination of mono- and disaccharide content of enteral formulations by gas chromatography, *Chromatographia*, 52, 221, 2000.
64. Troyano, E. et al. Isolation and characterization of 3-deoxypentulose and its determination in heated milk, *J. Dairy Res.*, 59, 507, 1992.
65. Montilla, A. et al. Determination of oligosaccharides by conventional high-resolution gas chromatography, *Chromatographia*, 63, 453, 2006.
66. Martínez-Castro, I. and Olano, A. Determinación de lactulosa en leches comerciales, *Rev. Esp. Lechería*, 110, 213, 1978.
67. Ogasa, K., Kuboyama, M., and Kiyosawa, I. Content of free and bound inositol in human and cows milk, *J. Nutr. Sci. Vitaminol.*, 21, 129, 1975.
68. Montilla, A., Moreno, F.J., and Olano, A. A reliable gas capillary chromatographic determination of lactulose in dairy samples, *Chromatographia*, 62, 311, 2005.
69. Harvey, C.D., Jenness, R., and Morris, H.A. Gas chromatographic quantitation of sugars and non-volatile water-soluble organic acids in commercial Cheddar cheese, *J. Dairy Sci.*, 64, 1648, 1981.
70. Byun, S.M. and Jenness, R. Estimation of free myo-inositol in milks of various species and its source in milk of rats (*Rattus norvegicus*), *J. Dairy Sci.*, 65, 531, 1982.
71. Morales, V., Olano, A., and Corzo, N. Ratio of maltose to maltulose and furosine as quality parameters for infant formula, *J. Agric. Food Chem.*, 52, 6732, 2004.
72. Folkes, D.J. and Crane, L. Determination of carbohydrates, in: *HPLC in Food Analysis*, Macrae, R., ed., Academic Press, San Diego, CA, 1988, Chapter 3.
73. Wei, Y. and Ding, M.Y. Analysis of carbohydrates in drinks by high-performance liquid chromatography with a dynamically modified amino column and evaporative light scattering detection, *J. Chromatogr. A*, 904, 113, 2000.
74. Richmond, M.L. et al. Separation of carbohydrates in dairy products by high performance liquid chromatography, *J. Dairy Sci.*, 65, 1394, 1982.
75. Schmid, D. et al. Nano-HPLC-mass spectrometry and MEKC for the analysis of oligosaccharides from human milk, *Biomed. Chromatogr.*, 16, 151, 2002.
76. Honda, S. High-performance liquid chromatography of mono- and oligosaccharides, *Anal. Chem.*, 140, 1, 1984.



77. Cataldi, T.R.I., Campa, C., and Benedetto, G.E. De. Carbohydrate analysis by high performance anion-exchange chromatography with pulsed amperometric detection: The potential is still growing, *Fresen. J. Anal. Chem.*, 368, 739, 2000.
78. Vidal-Valverde, C., Martin-Villa, C., and Herranz, J. Determination of soluble carbohydrates in yogurts by high performance liquid chromatography, *J. Dairy Sci.*, 67, 759, 1984.
79. Van Riel, J. and Olieman, C. Selectivity control in the anion-exchange chromatographic determination of saccharides in dairy products using pulsed amperometric detection, *Carbohydr. Res.*, 215, 39, 1991.
80. Hurst, W.J., Martin, R.A. Jr., and Zoumas, B.L. Application of HPLC to characterization of individual carbohydrates in foods, *J. Food Sci.*, 44, 892, 1979.
81. West, L.G. and Llorente, M.A. High performance liquid chromatographic determination of lactose in milk, *J. Assoc. Off. Anal. Chem.*, 64, 805, 1981.
82. Calvo, M.M. et al. Estudio comparativo de la determinación de lactulosa en leche mediante cromatografía de gases y cromatografía de líquidos, *Rev. Esp. Lechería*, 16, 11, 1987.
83. Ferreira, I.M.P.L.V.O., Gomes, A.M.P., and Ferreira, M.A., Determination of sugars and some other compounds in infant formulae, follow-up milks and human milk by HPLC-UV/RI, *Carbohydr. Polym.*, 37, 225, 1998.
84. Chávez-Servin, J.L., Castollote, A.I., and López-Sabater, M.C. Analysis of mono-and disaccharides in milk-based formulae by high performance liquid chromatography with refractive index detection, *J. Chromatogr. A*, 1043, 211, 2004.
85. Kennedy, J.F., and Pagliuca, G. Oligosaccharides, in: *Carbohydrate Analysis. A Practical Approach* (The Practical Approach Series), Chaplin, M.F. and Kennedy, J.F., eds., Oxford University Press, New York, 1994, Chapter 2.
86. Macrae, R. Applications of HPLC to food analysis, in: *HPLC in Food Analysis*. Macrae, R., ed., Academic Press, San Diego, CA, 1988, Chapter 2.
87. Pirisino, J.F. High performance liquid chromatographic determination of lactose, glucose and galactose in lactose-reduced milk, *J. Food Sci.*, 48, 742, 1983.
88. Bouzas, J. et al. Simultaneous determination of sugars and organic acids in Cheddar cheese by high performance liquid chromatography, *J. Food Sci.*, 56, 276, 1991.
89. Scott, F.W. and Hatina, G. HPLC determination of sugars, starch and oligosaccharides in infant formula using resin-based fixed-ion columns, *J. Food Sci.*, 53, 264, 1988.
90. Mullin, W.J. and Emmons, D.B., Determination of organic acids and sugars in cheese, milk and whey by high performance liquid chromatography, *Food Res. Int.*, 30, 147, 1997.
91. Elliot, J. et al. Heat-induced changes in UHT milks. Part 1, *Austr. J. Dairy Technol.*, 58, 3, 2003.
92. Kaminarides, S., Stamou, P., and Massouras, T. Comparison of the characteristics of set type yoghurt made from ovine milk of different fat content, *Int. J. Food Sci. Technol.*, 42, 1019, 2007.
93. Soga, T. and Serwe, M. Determination of carbohydrates in food samples by capillary electrophoresis with indirect UV detection, *Food Chem.*, 69, 339, 2000.
94. Cataldi, T.R.I., Angelotti, M., and Bufo, S.A. Method development for the quantitative determination of lactulose in heat-treated milks by HPAEC-with pulsed amperometric detection, *Anal. Chem.*, 71, 4919, 1999.
95. Pollman, R.M. Ion chromatographic determination of lactose, galactose and dextrose in grated cheese used pulsed amperometric detection, *J. Assoc. Off. Anal. Chem.*, 72, 425, 1989; Oligosaccharides from human milk, *Biomed. Chromatogr.*, 16, 151, 2002.
96. Kaine, L.A. and Wolnik, K.A. Detection of counterfeit and relabeled infant formulas by high-pH anion-exchange chromatography-pulsed amperometric detection for the determination of sugar profiles, *J. Chromatogr. A.*, 804, 279, 1998.
97. Cataldi, T.R.I., Angelotti, M., and Bianco, G., Determination of mono- and disaccharides in milk and milk products by high performance anion-exchange chromatography with pulsed amperometric detection, *Anal. Chim. Acta*, 485, 43, 2003.
98. Kunz, C. and Rudloff, S. Health promoting aspects of milk oligosaccharides, *Int. Dairy J.*, 16, 1341, 2006.

99. Mehra, R. and Kelly, P. Milk oligosaccharides: Structural and technological aspects, *Int. Dairy J.*, 16, 1334, 2006.
100. Corradini, C. et al. High-performance anion-exchange chromatography coupled with pulsed amperometric detection and capillary zone electrophoresis with indirect ultraviolet detection as powerful tools to evaluate prebiotic properties of fructooligosaccharides and inulin, *J. Chromatogr. A*, 1054, 165, 2004.
101. Thurl, S., Müller-Werner, B., and Sawatzki, G. Quantification of individual oligosaccharide compounds from human milk using high pH anion exchange chromatography, *Anal. Biochem.*, 235, 202, 1996.
102. Splechtina, B. et al. Production of prebiotic galacto-oligosaccharides from lactose using  $\beta$ -galactosidases from *Lactobacillus reuteri*, *J. Agric. Food Chem.*, 54, 4999, 2006.
103. Cardelle-Cobas, A. et al. Study of galacto-oligosaccharides formation from lactose using Pectinex-Ultra SP-L, *J. Sci. Food Agric.*, 88, 954, 2008.
104. Cardelle-Cobas, A. et al. Synthesis of oligosaccharides derived from lactulose and Pectinex Ultra SP-L, *J. Agric. Food Chem.*, 56, 3328, 2008.
105. Martínez-Villaluenga, C. et al. Enzymatic synthesis and identification of two trisaccharides produced from lactulose by transgalactosylation, *J. Agric. Food Chem.*, 56, 557, 2008.
106. Broberg, A. High-performance liquid chromatography/electrospray ionization ion-trap mass spectrometry for analysis of oligosaccharides derivatized by reductive amination and N, N-dimethylation, *Carbohydr. Res.*, 342, 1462, 2007.
107. Ninonuevo, M.R. et al. A strategy for annotating the human milk glycome, *J. Agric. Food Chem.*, 54, 7471, 2006.
108. Corradini, C. and Cavazza, A. Application of capillary zone electrophoresis (CZE) and micellar electrokinetic chromatography (MEKC) in food analysis, *Ital. J. Food Sci.*, 10, 299, 1998.
109. Cortacero-Ramirez, S. et al. Analysis of carbohydrates in beverages by capillary electrophoresis with precolumn derivatization and UV, *Food Chem.*, 87, 471, 2004.
110. Campa, C. et al. Overview on advances in capillary electrophoresis-mass spectrometry of carbohydrates: A tabulated review, *Electrophoresis*, 27, 2027, 2006.
111. Lee, Y.H. and Lin, T.I. Determination of carbohydrates by high-performance capillary electrophoresis with indirect absorbance detection, *J. Chromatogr. B*, 681, 87, 1996.
112. Izco, J.M., Tormo, M., and Jiménez-Flores, R. Rapid simultaneous determination of organic acids, free amino acids and lactose in cheese by capillary electrophoresis, *J. Dairy Sci.*, 85, 2122, 2002.
113. Jager, A.V., Tonin, F.G., and Tavares, M.F.M. Comparative evaluation of extraction procedures and method validation for determination of carbohydrates in cereals and dairy products by capillary electrophoresis, *J. Sep. Sci.*, 30, 586, 2007.
114. Zhang, X., Cao, Y., and Ye, J. Determination of lactose in sugar-free milk powder by capillary electrophoresis with electrochemical detection, *Food Chem.*, 385, 2001.
115. Cifuentes, A. Recent advances in the application of capillary electromigration methods for food analysis, *Electrophoresis*, 27, 283, 2006.
116. Cheung, R.H.F., Marriot, P.J., and Small, D.M. CE methods applied to the analysis of micronutrients in foods, *Electrophoresis*, 28, 3390, 2007.
117. Momenbeik, F. et al. Sensitive determination of carbohydrates labelled with *p*-nitroaniline by capillary electrophoresis with photometric detection using a 406 nm light-emitting diode, *Electrophoresis*, 27, 4039, 2006.
118. Shen, Z., Warren, Ch.D., and Newburg, D.S. High-performance capillary electrophoresis of sialylated oligosaccharides of human milk, *Anal. Biochem.*, 279, 37, 2000.
119. Petzelbauer, I. et al. Development of an ultra-high-temperature process for the enzymatic hydrolysis of lactose. II. Oligosaccharide formation by two thermostable  $\beta$ -glycosidases, *Biotechnol. Bioeng.*, 69, 140, 2000.
120. Pfenninger, A. et al. Matrix optimization for matrix-assisted laser desorption/ionization mass spectrometry of oligosaccharides from human milk, *J. Mass Spectrom.*, 34, 98, 1999.

121. Pfenninger, A. et al. Structural analysis of underivatized neutral human milk oligosaccharides in the negative ion mode by nano-electrospray MSn (Part 1: Methodology), *J. Am. Soc. Mass Spectrom.*, 13, 1331, 2002.
122. Spina, E. et al. New fragmentation mechanisms in matrix-assisted laser desorption/ionization time-of-flight/time-of-flight tandem mass spectrometry of carbohydrates, *Rapid Commun. Mass Spectrom.*, 18, 392, 2004.
123. Hu, F., Furihata, K., Kato, Y., and Tanokura, M. Non-destructive quantification of organic compounds in whole milk without pretreatment by two-dimensional NMR spectroscopy, *J. Agric. Food Chem.*, 55, 4307, 2007.
124. Urashima, T. et al. Studies of the neutral trisaccharides of goat (*Capra hircus*) colostrum and of the one- and two-dimensional  $^1\text{H}$  and  $^{13}\text{C}$  NMR spectra of 6'-acetylglucosaminylactose, *Carbohydr. Res.*, 262, 173, 1994.
125. Martin-Pastor, M. and Bush, C.A. Conformational studies of human milk oligosaccharides using  $^1\text{H}$ - $^{13}\text{C}$  one-bond NMR residual dipolar couplings, *Biochemistry*, 39, 4674, 2000.
126. Kogelberg, H. et al. Determination by electrospray mass spectrometry and  $^1\text{H}$ -NMR spectroscopy of primary structures of various fucosylated neutral oligosaccharides based on the iso-lacto-N-octose core, *Eur. J. Biochem.*, 271, 1172–1186, 2004.

## Chapter 7

---

# Triacylglycerols in Dairy Foods

---

Javier Fontecha, Manuela Juárez, and Miguel Angel de la Fuente

### CONTENTS

7.1	Introduction .....	169
7.2	Gas Chromatography-Based Analysis.....	171
7.2.1	Separation of TAG Classes According to Carbon Number.....	171
7.2.2	Separation of Molecular Species of TAGs.....	173
7.3	High-Performance Liquid Chromatographic Analysis.....	177
7.3.1	Detection Systems .....	177
7.3.2	Determination of Molecular Species of TAGs .....	178
7.3.2.1	Fractionation Methods .....	179
7.4	Supercritical Fluid Chromatography .....	180
7.5	Positional Distribution of the FAs in TAGs.....	180
7.6	Final Considerations .....	182
	References.....	182

### 7.1 Introduction

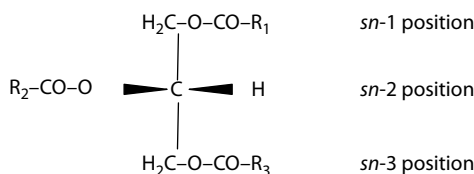
Lipids are among the most important constituents of milk for economic and nutritional reasons and because of the physical and sensory attributes that they give to dairy products. Triacylglycerols (TAGs) are the principal class, accounting for 97%–98% of all the lipids in milk, with minor contributions by diacylglycerols, monoacylglycerols, free fatty acids, sterols, phospholipids, and

fat-soluble vitamins. TAG composition is extremely complex due to the many different fatty acids (FAs) that can be esterified in the three positions on the L-glycerol molecule (Figure 7.1). Although almost 400 different FAs have been identified in milk fat [1,2], varying in concentration depending on a range of factors, such as lactation stage, diet, and the animals themselves, only about 14 are present at concentrations above 1% (see Chapter 10). Considering these 14 FAs alone yields 2744 potential positional isomers ( $n^3$ ), if FA position in TAGs is entirely random. Disregarding FA position on the TAG molecule still yields 560 compositionally different TAGs [ $n(n + 1)(n + 2)/6$ ], taking into account those in which all the FAs are different and combinations in which the same FA occurs at multiple positions.

Additionally, each TAG species may be separated into regiospecific and stereospecific isomers by determining the exact position of the three FAs on the glycerol backbone. The carbon atoms on the glycerol portion are numbered 1–3 (Figure 7.1). A Fischer projection of a natural L-glycerol derivative shows the secondary hydroxyl group to the left of C-2. The carbon atom above this is then C-1, the one below is C-3, and the stereospecific number (*sn*) designated in front of the name of the compound. A single molecular species is identified by listing the *sn*-1, *sn*-2, and *sn*-3 positions in order. The term regiospecific analysis will be used to refer to methods that do not discriminate between the *sn*-1 and *sn*-3 positions on a TAG, and the term stereospecific analysis will be reserved for methods that enable the composition to be determined at all the three positions.

The TAG profile in milk fat spans a broad range of molecular weights (from acyl carbon 26–54) arising from the large differences in chain length of the constituent FAs (from C4 to C20). In the TAG composition of bovine milk, TAGs with 36–40 acyl carbons and 46–52 acyl carbons prevail [2]. The TAG profile differs from the milks of other ruminants, primarily goat's milk, in which the C40–C44 TAGs predominate [3]. The range of carbon number (CN) values is considerable, indicating that there can be significant variation in the TAG composition both over the course of the dairying season and between geographical regions. TAG properties depend on the FA combination making up the molecule. Both the FA composition and the positional distribution of the three FAs on the glycerol backbone of the TAG are a product of the mechanism of milk fat biosynthesis. The FA and TAG structures are important in determining a TAG's relative digestibility and the nutritional effects of the TAGs and individual FAs. In addition, physical properties such as crystallization and melting point, which have an important effect on the texture and taste of milk fat products, cannot be explained completely on the basis of the properties of the individual FAs but rather also depend on the properties of each TAG in its entirety. The wide range of possible TAGs in dairy fat is constrained somewhat by consistent biosynthesis, which causes the distribution of the FAs among the positions to be far from random.

Owing to its complexity, milk TAG determinations pose a special challenge for analytical chemists. The overall TAG composition can readily be determined by gas chromatography (GC), and this method has been used with packed and short capillary columns to separate the TAGs



**Figure 7.1** Stereospecific numbering (*sn*) convention for TAGs based on the Fischer projection of L-glycerol.

according to their CNs and can also be employed to detect foreign fats in milk fat. In this respect, the European Union (EU) has developed strict standards of identity for butter and has established that this dairy product must be produced exclusively from milk or cream [4,5]. In any case, it should be noted that GC alone, while convenient, only separates TAGs into groups having similar molecular weights but does not provide information on the individual TAGs. Combined or hyphenated chromatographic techniques are therefore indispensable to identify and quantify individual molecular species of TAGs. These include thin layer chromatography (TLC) and high-performance liquid chromatography (HPLC) with Ag<sup>+</sup> as the prefraction stage followed by supercritical fluid chromatography (SFC), GC using long capillary columns, and reverse-phase HPLC (RP-HPLC) with mass spectrometric (MS) detection. These methods, along with nonspecific or specific hydrolysis procedures, provide better knowledge of the positional distribution of the FAs within the TAG molecules. This chapter reviews the developments in analytical techniques for studying TAGs in milk fat.

## 7.2 Gas Chromatography-Based Analysis

The first studies aimed at characterizing the TAGs in milk fat were carried out using GC with short (0.5–0.8 m) columns packed with thermostable nonpolar dimethyl polysiloxane-type stationary phases (OV-1, OV-101, and SE-30) and flame ionization detection (FID). Separations of TAGs were based solely on vapor pressure differences, which are correlated with the molecular masses of the components [6]. The introduction of capillary columns ushered in a new stage in the GC analysis of milk fat TAGs. These columns achieve better separation efficiencies along with longer lifetimes of the chemically bonded stationary phases. Today, fused silica capillary columns protected by a coating of temperature-resistant polyimide are widely used.

### 7.2.1 Separation of TAG Classes According to Carbon Number

Most current analytical approaches to authenticity issues involving milk fat constituents are based primarily on GC separation [7–12]. Although milk fat TAG composition is affected by differences in diet depending on the season and region, GC determination of classes of milk fat into groups having identical numbers of acyl-C atoms (C24–C54) is a more effective criterion for determining milk fat origin than FA composition.

On the basis of an idea originally developed by Timms [13], a mathematical transform was applied to stabilize natural variability in the TAG profile of bovine milk fat. Using 76 Australian milk fat samples, pure milk fat was characterized by an equation that included terms for the percentage content of the C40, C42, and C44 TAGs, and the method was capable of detecting levels of foreign fat as low as 5% [13]. Subsequently, more comprehensive and accurate studies carried out by Precht [14–17] applying multiple regression analysis to 755 samples of pure milk and samples of animal and vegetable fats modified the equation, increasing the sensitivity of the procedure to the presence of different foreign fats in milk fat. The limit of detection varied according to the source of the added fat but was generally <5%. Alternative computational models (artificial neural networks, principal component regression, and partial least squares regression) were equally effective in detecting low levels of adulteration [18–21]. The method based on these equations has been officially accepted by the EU [22] for the determination of the purity of milk fat, and limits are given to assess the presence of different foreign fats. The applicability of the method has been corroborated for Belgian butter [23] and Italian milk fat [24] and by another report using butter

samples from various EU member states [18]. More recently, representative collections of milk fat samples from New Zealand and South Africa have been fully identified as pure unadulterated milk fat as well [25]. On the basis of all these results, the TAG method for assessing authenticity can be assumed to be applicable globally.

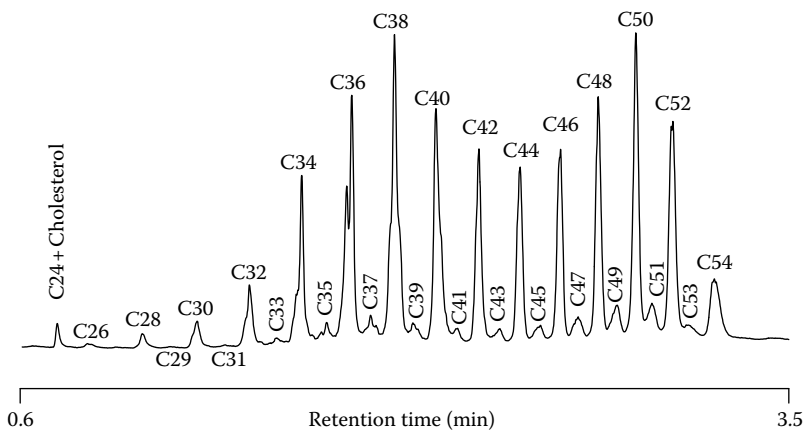
Although the official EU method for determining the purity of milk fat is based on TAG analysis using packed column GC, the original EU regulation [22] and its revised versions [4,5,26] also make provision for capillary columns as an alternative technique, on the condition that the same results are obtained. Short capillary columns (2.5–5 m) yield profiles comparable with those obtained with packed columns, with a single peak for each group of TAGs having the same CN, facilitating integration and quantification when compared with the higher resolution and separation of each group of TAGs into multiple peaks achieved using long capillary columns suitable for other purposes (see below) but not for simple quality control analysis [27]. Work on assessing the authenticity of milk fat using GC with short capillary columns (shorter than 5 m) has been reported by different authors [27–33]. This large volume of work has ensued as a result of the development of better columns with high stationary phase thermal stability and selectivity. Additionally, short capillary column analysis reduces analysis time (10–15 min) and consumes less carrier gas than packed columns while providing similar levels of accuracy, especially for TAGs with high CN (i.e., C54). Nevertheless, there has been some controversy concerning quantitative aspects of TAG profiling of milk fat by short capillary column GC, although capillary column GC was equivalent to packed column GC in terms of analytical precision, and all the samples tested fulfilled the purity criteria (*S*-values) in both cases, Ulberth et al. [33] observed that *S*-values obtained by capillary column GC differed somewhat from those obtained using packed column GC and that the differences exceeded the reproducibility limits laid down by the EU regulations. A later study [31] checked the method by testing the purity of 50 widely varying samples of milk fat in accordance with EU rules and found that the differences in the *S*-values obtained from packed and capillary column data did not exceed the reproducibility limits stipulated by EU regulations for any of the samples. However, to guarantee comparable results, they recommended rechecking by each laboratory wishing to use capillary column GC instead of packed column GC to monitor milk fat purity.

More recently, a fast method of separating milk fat TAGs (C24–C54) using a short nonpolar capillary column (4 m prepared from a commercially available 15 m DB-5HT column) took less than 4 min [34] (Figure 7.2). The experimental results confirmed that this column, too, could be used in place of packed columns to detect foreign fat in milk fat.

Because of the differences in the TAG profiles for milk fat from different species already referred to above, the equations put forward under EU regulations are not suitable for monitoring caprine or ovine milk fat. Accordingly, new multiple regression equations for detecting foreign fats in caprine and ovine milk fat have been proposed based on the TAG composition of caprine and ovine milk fat [3,35]. Fontecha et al. [3] applied these mathematical equations to determine admixtures of dairy fats in goat's milk. However, it did not attain a particularly low detection limit.

The proposed equations have been applied to cheeses with low levels of lipolysis, with good results [36]. However, high lipolysis levels pose a problem, because lipases are stereospecific and can thus alter the proportions of esterified acids and hence of the TAGs [37,38]. The results reported by Fontecha et al. [38] suggested that the regression equations can be useful in detecting foreign fats in cheeses that undergo high levels of lipolysis, but only if they are applied early in ripening.

The injection method is critical in quantitative GC analysis of milk fat TAGs, because samples consist of mixtures of TAGs ranging widely in volatility and relatively high temperatures are



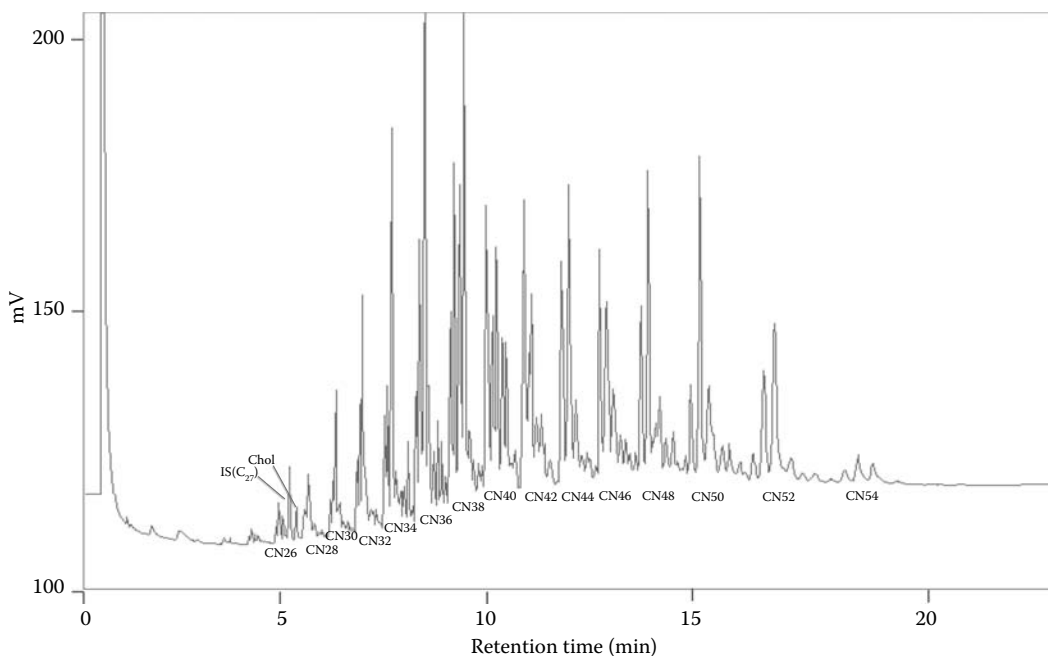
**Figure 7.2** Gas-liquid chromatogram of pure milk fat analyzed by GC on a short nonpolar open-tubular capillary column (4.0 m × 0.25 mm i.d., film thickness 0.10 μm). Number of carbon atoms of the triacylglycerides is indicated for each peak. (From Destailats, F. et al., *J. Chromatogr. A.*, 1131, 227, 2006. With permission.)

required for complete vaporization. Conventional hot split injection is by far the least suitable technique, in that it could result in TAG discrimination and decomposition. On-column injection has been the approach most commonly used to reduce these undesirable effects [27,29–33,39]. Programmed temperature vaporizer (PTV) injection has also been successfully tested [32,40–42].

### 7.2.2 Separation of Molecular Species of TAGs

There is a great deal of interest in the molecular species of TAGs present in dairy fats because of their influence on processing aspects (melting point, crystallization behavior, etc.), physiology (biosynthesis), and nutrition (action of lipolytic enzymes). However, these species are difficult to determine quantitatively and qualitatively in milk. Long capillary columns (25–30 m) have improved TAG resolution, and more thermostable, nonpolar stationary phases have enhanced separations of the components of different TAG classes having the same CNs in samples that did not undergo prefractionation [27]. However, to improve resolution within a given TAG class having the same CN, high capillary column efficiency needs to be coupled with stationary phase selectivity. Better separation efficiency of milk fat TAGs has been achieved using capillary columns coated with more polar polysiloxane phases containing a high proportion of phenyl groups (50%–65%). Temperature-resistant columns have greatly enhanced resolving power and allow some individual TAG species to be determined. Separations on these columns are performed according to acyl CN, and within each acyl CN group according to the degree of unsaturation (Figure 7.3). Nevertheless, despite the advantages afforded by these columns with respect to short columns, the longer analysis times (30–45 min) and the high temperatures (up to 350°C) to which the high boiling point TAGs are subjected result in lower precision and accuracy in the determinations [27,32]. Furthermore, none of these analyses yields definitive quantification of individual TAGs, inasmuch as each peak still contains different unresolved molecular species [8,43,44].





**Figure 7.3** Gas chromatographic profile of triacylglycerides in ovine milk fat separated using a 25 m capillary column. Number of carbon atoms of the triglycerides is indicated for each peak group. (From Fontecha, J. et al., *Int. Dairy J.*, 15, 1217, 2005. With permission.)

As previously mentioned, the use of supplementary methods before GC has allowed complex mixtures like milk fat TAGs to be separated into simpler fractions (Table 7.1). With time,  $\text{Ag}^+$  chromatography has become an important method of fractionating and characterizing lipids. The principle underlying this chromatographic technique is that silver ions interact reversibly with the  $\pi$  electrons of double bonds (*cis* more strongly than *trans*) to form polar complexes, and the greater the number of double bonds in a molecule, the stronger the complex formed, and the longer it is retained. In chromatographic systems, complex formation is transient, and complexes are in kinetic equilibrium with the native olefin. Dobson et al. [45] and Christie [46] have published fairly comprehensive listings of applications of  $\text{Ag}^+$  chromatography in analyzing the TAGs in a variety of substrates.  $\text{Ag}^+$ -TLC has been widely used for dairy fat and is still a preferred method of fractionating TAGs at some laboratories [47–50], but  $\text{Ag}^+$  liquid chromatography offers many advantages and has also gained acceptance.

Lund [47] used  $\text{Ag}^+$ -TLC to separate milk fat into three fractions (saturated TAGs, monounsaturated TAGs, and the remaining TAGs), and Myher et al. [48] were able to separate a distillate of milk fat into six bands according to chain length, number of double bonds, and geometric configuration (*cis*- and *trans*-monoenoic TAGs). Fraga et al. [49] fractionated milk fat into the same number of bands, i.e., a group comprising two bands of trisaturated TAGs, another group consisting of two bands of monounsaturated TAGs (in both groups the band with the lower  $R_f$  contained a TAG containing butyric acid), a fifth band of diunsaturated TAGs, and a sixth band of tri and polyunsaturated TAGs. Fontecha et al. [50] used  $\text{Ag}^+$ -TLC to separate goat's milk fat into four

**Table 7.1 Chromatographic Methods Used to Fractionate and Analyze Milk Fat Triacylglycerides Described in the Literature**

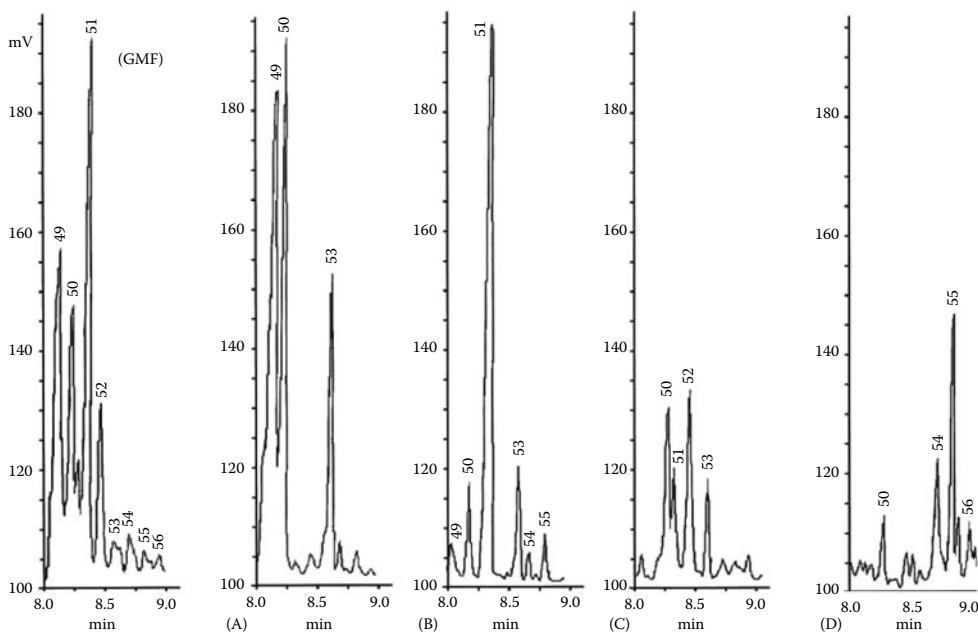
<i>Fractionation Technique</i>	<i>Chromatographic Technique</i>	<i>Detector</i>	<i>Refs.</i>
TLC	RP-HPLC	UV	[97]
	RP-HPLC	MS	[88]
	GC	FID	[47]
Ag <sup>+</sup> -TLC	GC	MS	[48–50]
	RP-HPLC	LSD	[76,83]
	RP-HPLC	UV	[76]
	RP-HPLC	MS	[65,79]
Ag <sup>+</sup> -HPLC	RP-HPLC	MS	[84,85,90,94]
	RP-HPLC	LSD	[78,80,81]
Ag <sup>+</sup> -SPE	GC	MS	[51–54]
RP-HPLC	GC	FID	[69,70,99,100]
	Ag <sup>+</sup> -HPLC	MS	[89]
SGC	NP-HPLC	MS	[95]
	GC	MS	[54]
GPC	RP-HPLC	MS	[88]

Ag<sup>+</sup>-HPLC, silver ion high-performance liquid chromatography; Ag<sup>+</sup>-SPE, silver ion solid-phase extraction chromatography; Ag<sup>+</sup>-TLC, silver ion thin layer chromatography; FID, flame ionization detector; GC, gas chromatography; GPC, gel permeation chromatography; LSD, light scattering detector; MS, mass spectrometry; NP-HPLC, normal phase high-performance liquid chromatography; RP-HPLC, reverse phase high-performance liquid chromatography; SGC, short flash chromatography grade silica gel column; TLC, thin layer chromatography; UV, ultraviolet.

primary fractions. Each of the fractions was then analyzed by GC. Figure 7.4 depicts partial chromatograms of the C36 TAG class in whole goat's milk fat and the four TLC fractions.

The TAGs in butter oil can also be separated into saturated, monoene, diene, and triene fractions on a *p*-propylbenzene sulfonic acid solid-phase extraction column loaded with Ag<sup>+</sup> [51–54]. This method shortened analysis times and facilitated separation of the TAGs by molecular weight, particularly important in the case of milk fat in view of the broad range of molecular sizes present. This column affords a useful alternative to Ag<sup>+</sup>-TLC for separating milk fat TAGs and yields relatively pure TAG fractions for further analysis by GC [55,56].

Replacing FID detection with MS detection in GC has become an essential tool for qualitative analysis of milk fat TAGs. TAGs can be identified on the basis of the MS spectrograms of the components making up the ionized overall molecule and of the ionized fragments of the molecule, the sum of which is practically unique for each chemical compound. Using capillary GC with



**Figure 7.4** Partial gas chromatograms of triacylglycerides (CN 36 zone) of goat's milk fat (GMF) and the  $\text{Ag}^+$ -TLC fractions: A, saturated (C6 and longer FAs); B, saturated (C4 and longer FAs); C, monounsaturated; D, polyunsaturated. Peak numbers are the most abundant TAGs identified by MS: 49, 8,12,16; 50, 6,14,16; 51, 4,16,16; 52: 4,14,18; 53, 4,15,18/4,16,17; 54, 4,16:1,16:1; 55, 4,14:1,18:2. (From Fontecha, J. et al., *Int. Dairy J.*, 10, 119, 2000. With permission.)

MS, Evershed [57] determined some molecular species of cow's milk fat TAGs and Fontecha et al. [58] reported the identity of the major TAGs in ovine milk fat. However, a TAG prefractionation technique is a requisite first step to provide a solid basis for further qualitative MS analysis of the molecular species of TAGs in butterfat. Major and some minor molecular species of TAGs have been identified from electron impact (EI) GC-MS analytical data for milk fat fractions separated by  $\text{Ag}^+$ -TLC [48–50] or on a solid-phase extraction column loaded with  $\text{Ag}^+$  [52,53].

Murata and Takahashi [59] and Murata [60] reported the first quantification of TAGs in milk fat by GC-EI-MS using a nonpolar GC column. However, mass spectral studies suffer from difficulties associated with the accurate quantification of the different types of TAGs. The sensitivity of MS differs with the degree of unsaturation of the TAGs, and fully saturated TAGs tend to display a lower molecular ion response than unsaturated TAGs [2]. Furthermore, the size of molecular and fragment ions and even regioisomerism can have a significant effect on relative ion yields, and hence on the empirical correction factor used in quantifying TAGs. A quantitative GC-EI-MS method for determining TAG molecular species using molar correction factors for  $[\text{M-RCOO}]^+$  ions was recently developed [54]. The method enabled quantification of 139 individual TAG species from butterfat, including several regioisomers of short-chain TAGs, and provided an alternative for elucidating the nutritional and processing properties of mixtures of TAGs containing relatively saturated FAs.

Comparative characterizations of milk fat, lard, and beef tallow TAGs have been achieved using matrix-assisted laser desorption/ionization-time-of-flight (MALDI-TOF) MS after fractionation by TLC and FA analysis by long capillary column GC [61], with good identification

of the signature TAGs for each animal fat. The data provide insight into molecular differences in animal fat, but the potential of MALDI-TOF for rapid milk fat profiling seems to insufficiently support measuring small changes in short-chain TAGs.

## 7.3 High-Performance Liquid Chromatographic Analysis

HPLC is one of the most widely used methods for TAG analysis in different foodstuffs [43,44,46,62]. Because milk fat is so complex, developing efficient methods of HPLC analysis has required improvement and optimization of the chromatographic system components (solvents, elution gradients, detector type, and column characteristics). Normal phase HPLC (NP-HPLC), RP-HPLC, and silver ion HPLC ( $\text{Ag}^+$ -HPLC) modes have all been used appropriately, with the latter two being the most effective for analyzing complex mixtures of TAGs.

RP-HPLC of TAGs is performed on nonpolar stationary phases using almost exclusively columns packed with silica gel chemically bonded with octadecyl groups. The solvent system (usually mixtures of acetonitrile with acetone or methanol) should be more polar than the stationary phase, which reverses the elution order of the solutes. The elution order of TAGs in RP-HPLC is based on the combined effect of chain length and the degree of unsaturation of the FA moieties, i.e., each double bond is equivalent to about two methylene groups in its effect on the retention properties. The term equivalent carbon number (ECN) was introduced for this reason [63] and was defined as  $\text{ECN} = \text{CN} - 2\text{DB}$ , where CN is the total carbon number and DB is the total number of double bonds in the TAG molecule. Within a sample of TAGs having the same ECN, the elution order is first of all those TAG molecules containing polyunsaturated fatty acids (PUFAs), followed by those containing monounsaturated FAs, and lastly those containing saturated FAs. Furthermore, there is greater retention of TAGs containing short-chain FAs on the columns [64–66]. The main difficulty with this type of approach when analyzing complex mixtures to separate TAGs is that TAG species with the same ECN value, known as “critical pairs,” coelute on columns filled with a packing with a 10  $\mu\text{m}$  particle size and cannot be resolved. Development of column stationary phases with 3–5  $\mu\text{m}$  particle size packing improved the separation of ECN critical pairs [67]. Their new retention properties were expressed more specific as theoretical carbon number (TCN) determined experimentally for each fatty acyl moiety on the TAG moiety.

In RP-HPLC, the mobile phase has a main effect on the separation of TAGs through competition between the mobile phase and the TAGs for the stationary phase and the increase or decrease in TAG solubility in the mobile phase, which can enhance or retard their separation. The most widely employed solvent system is a mixture of acetonitrile and acetone. Acetone improves the separation of critical pairs of TAGs, and acetonitrile is able to interact with the  $\pi$  electrons of unsaturated FAs, thereby exerting an effect on the separation of unsaturated species. Combining different eluting solvents (acetone, acetonitrile, benzene, dichloromethane, ethanol, hexane, iso-octane, isopropanol, methanol, etc.) could be suitable for separation, but the choice of mobile phase depends mainly on the solvents' aptness for the detection mode.

### 7.3.1 Detection Systems

The choice of detection system has proved to be of great importance in milk fat analysis. Refraction index (RI), ultraviolet (UV), and MS detectors were the first detectors used for HPLC analysis of dairy TAGs [68]. RI detection was widely used at first [69–73], but certain difficulties arise against its use, e.g., the differing response to saturated and unsaturated compounds, low sensitivity, and

its unsuitability for gradient elution. UV detection [74,75] does allow the use of gradients and has been used to detect TAG molecules containing FAs with conjugated double bonds that absorb at selective wavelengths [76]. However, UV detection is incompatible with mobile phases that contain acetone, which absorbs in the same regions of the spectrum where TAGs absorb. For such cases, the use of hexane, *n*-propanol, ethanol, and other solvents as the mobile phase has been proposed [62]. FID detection has been tried by way of an alternative [77], but light scattering (LS) detection could be a more suitable option [66,76,78–83], since it can be operated with gradients and at the same time allows all organic solvents to be used as the mobile phase.

As previously mentioned in the section dealing with GC, MS is the most suitable detection system for qualitative analysis and thus for identifying different TAG species. The efficient separations achieved using HPLC and the structural information provided by MS suggest that HPLC-MS has considerable potential for elucidating the composition of dairy fat. Chemical ionization (CI)-based methods are the most widely employed MS procedures for ionizing and characterizing the molecular fragments of milk fat TAGs separated by HPLC. Using RP-HPLC with both positive and negative CI detection, Kuksis et al. [64] were able to analyze the TAGs present in some butter oil fractions. Chloroform attachment negative ion CI produced  $[M + Cl]^-$  ions, which enabled the molecular mass of each TAG species to be determined. Analysis of the same fractions by positive CI yielded both protonated molecular ions and diacylglycerol ions, allowing the FAs present in each TAG to be determined. Molecular species of milk fat TAGs were identified with this method [64]. In subsequent work [65,79,84,85], this ionization method has been a key factor in characterizing numerous species of milk fat TAGs.

HPLC in association with atmospheric pressure CI (APCI)-MS has also been shown to be a powerful tool for TAG analysis [86,87], and this approach has been very useful in elucidating the structure of cow's milk [88] and donkey's milk [89,90] TAGs. APCI-MS of TAGs typically yields protonated molecular ions  $[M + H]^+$ , diacylglycerol ions resulting from loss of a fatty acyl moiety, and the FAs themselves in the form of acylium ions. Whereas protonated molecular ion abundance is low in highly saturated TAG species, the diacylglycerol ions enable the FAs in the *sn*-2 position to be differentiated from those in the *sn*-1 and *sn*-3 positions.

Tandem MS is another detection method used to analyze milk fat TAGs on HPLC systems. In this method, an initial positive or negative ionization step is followed by a subsequent step to ionize the fragments resulting from the first step. The initial fragmentation products are used to determine the CNs and the double bonds of the FAs making up the TAGs, while the second fragmentation can yield mass spectra helpful in determining the regioisomers. Applying this method to human milk fat [91–93] revealed palmitic acid to be the most abundant FA in the *sn*-2 position and the 18:1–16:0–18:1 to be the most important TAG quantitatively (10% of the total TAGs). Similarly, tandem MS has also been used successfully to identify minor TAGs with branched-chain FAs or odd-numbered carbon FAs in cow's milk [66,94]. Still, this ionization method is not entirely problem-free. Studies using tandem MS in which diacylglycerol ions and FA ions are formed from TAG ions have shown that the diacylglycerol ions were not representative of the expected random distribution of diacylglycerols but rather contained more of the FAs at the *sn*-2 position [91,95]. In other words, cleavage of FAs from the *sn*-2 position was less than that from the *sn*-1 and *sn*-3 positions.

### 7.3.2 *Determination of Molecular Species of TAGs*

HPLC has not been used for quality control and milk fat authenticity studies like GC but has been employed to study changes in the TAG profile due to such factors as seasonality and diet [71–73]. TAGs have been tentatively identified based on the TCN and relative retention times. However,

none of these studies using a single HPLC column was able to reliably determine individual TAGs, because most of the chromatographic peaks contained a number of TAG species. Barrón et al. [74] used two HPLC columns connected in series and GC to determine the FA composition of the resulting fractions. These authors [74] identified 116 TAG molecular components of milk fats from different ruminant species. Later, up to 181 TAG species were identified using LS detection and deconvolution software for determining different molecular components in each chromatographic peak [82].

### 7.3.2.1 Fractionation Methods

As already discussed in the section on GC, most of the procedures that have been put forward for determining individual TAG species in dairy fat have been based on prefractionation of samples followed by HPLC determination (Table 7.1). TLC was one of the first methods tested. This method separated the milk fat TAGs into distinct bands according to TAG CN. Each of these fractions was then analyzed by HPLC [76,83,88,96,97]. Gas permeation chromatography (GPC) to separate milk fat TAG fractions prior to HPLC analysis has also been reported [88]. Separation was observed to take place by polarity rather than by molecular size, suggesting that the mode of separation was more similar to RP-HPLC than to true size-exclusion chromatography.

While Ag<sup>+</sup>-TLC has been used [65,76,79,83], Ag<sup>+</sup>-HPLC columns have ultimately carried the day as a prefractionation method [78,80,81,84,85,90,94]. Stable Ag<sup>+</sup> columns for HPLC in which the silver ions are linked, via ionic bonds, to phenylsulfonic acid moieties bound to a silica matrix are commercially available (ChromSpher Lipids™, Chrompack, Middelburg, the Netherlands). These Ag<sup>+</sup>-HPLC columns have well-defined chemical properties, and since most chromatographic conditions (temperature, mobile phase composition, and flow rate) can be very precisely controlled, reproducible data can be obtained. Trisaturated species elute first, followed by disaturated-monoenoic species and saturated-dimonoenoic species, as expected. Indeed, not only the usual fractions with saturated and *cis*-monoenoic residues, but also those with *trans* double bonds could be separated on these columns. These Ag<sup>+</sup>-HPLC columns were used by Adlof [98] and have since been applied extensively to separate the TAGs in dairy fats.

Ag<sup>+</sup>-HPLC followed by RP-HPLC with MS detection proved to be an effective tool for characterizing the TAGs in milk fat [84,85,90,94]. Successful fractionation by Ag<sup>+</sup>-HPLC of TAGs with configurations differing in one FA is significant, because afterwards geometric (*cis* and *trans*) isomers are not differentiable by MS. Using this method, Laakso and Kallio [84] were able to discriminate between TAGs with two saturated FAs and one monounsaturated FA differing only in the geometric configuration of this last-mentioned FA. They found a higher proportion of *cis* FAs on TAG molecules containing short-chain FAs. This was attributed to steric hindrance produced by esterification of long-chain FAs on molecules that already contained a *trans* FA. A similar analytical approach subsequently developed by Kallio et al. [85] added more information about the location of *cis* and *trans* FAs at the primary and the secondary positions of TAGs. Their results suggest that the *sn*-position of *cis*- and *trans*-monoenoic FAs depends on the two other FAs present on the molecule. Such study [85] suggests that *cis*- and *trans*-FAs are processed in milk fat biosynthesis with other FAs affecting the regiospecific position of the monoenoic C18 FAs.

Prefractionation by RP-HPLC followed by GC analysis of the fractions thus obtained is another method that has yielded abundant information on the molecular structure of milk fat TAGs (Table 7.1). Maniongui et al. [99] and Gresti et al. [100] carried out a comprehensive study combining these two procedures to determine the proportions of 223 individual TAGs composed

of the 14 major FAs that made up 80% of the total in bovine milk fat. This work was of decisive importance in proving the nonrandom distribution of FAs in the TAGs of dairy fats.

## 7.4 Supercritical Fluid Chromatography

In SFC, a gas compressed above its critical temperature and pressure is used as the mobile phase to elute analytes from a chromatographic column. Supercritical fluids are characterized by low viscosities and high diffusivities, thereby shorting solute retention times. A further potential advantage of this technique is that universal FID can be employed for quantification provided that pure carbon dioxide is used as the mobile phase. Buchgraber et al. [44] reviewed SFC analysis of TAGs and concluded that even long-chain high-molecular-mass TAGs can be eluted at moderate temperatures (<150°C), thus eliminating the problem of thermal degradation usually associated with high-temperature GC of TAGs.

Despite the large body of work addressing instrumental optimization, to date application of this method of analysis to milk fat TAGs has been minor compared with that of other chromatographic procedures, even though the results appear to be comparable with those obtained using GC. TAGs with the same CNs have been separated on short (5 m), nonpolar capillary columns, the odd-number carbon peaks eluting just after the even-number carbon peaks [101,102]. Using capillary columns with polar stationary phases, Manninen et al. [103] was able to improve the separations so that they also took into account the degree of unsaturation of the TAG molecules.

FID was the usual detection mode, but MS has also been employed. Combining SFC separation on slightly polar capillary columns with EI-MS detection, Kallio et al. [102] determined the proportion of TAGs with differing degrees of unsaturation in each of the peaks eluting with the same CN. Later, capillary SFC combined with APCI was used to identify milk fat TAGs [104]. Ionization was accomplished by pumping ammonia vapor in methanol into the ionization chamber, which resulted in the formation of abundant  $[M + 18]^+$  and  $[M-R\text{COO}]^+$  TAG ions, which respectively defined the molecular weight and the FA constituents of the TAGs. In addition to identifying the major chromatographic peaks for molecules with 26–54 acyl carbons, minor peaks for TAGs with an odd number of acyl carbons were separated and identified.

## 7.5 Positional Distribution of the FAs in TAGs

The distribution of FAs on the backbones of TAG molecules is nonrandom and affects the melting point and hardness as well as the digestibility of ruminant milk fat. The nutritional characteristics of milk are determined, in part, by TAG structure. However, determination of the positional distribution of FAs in individual TAGs is extremely difficult and time-consuming, requiring a method capable of differentiating both the TAGs and also the positions of the FAs on the glycerol backbone. The literature contains some excellent reviews dealing with this topic and setting out details of the analytical methods employed and their application to different natural fats [43,46,105,106]. This chapter will make reference only to those applications that have been used for milk fat analysis.

Initial studies of milk fat TAGs were based on enzymatic methods, in particular using pancreatic lipase, which hydrolyzes the *sn*-1 and *sn*-3 positions on the TAG molecule without distinction. The simplest approach to regiospecific analysis comprises hydrolyzing the TAGs using pancreatic

lipase followed by isolating the 2-monoacyl glycerols and analyzing the FAs attached to the *sn*-2 position by GC. The mean composition of each FA in the *sn*-1 and *sn*-3 positions can be calculated from its concentrations in the intact TAGs and in the *sn*-2 position on the basis of the relationship (all values expressed in mol%):

$$[\text{positions 1 and 3}] = (3 \times [\text{triacylglycerol}] - [\text{position 2}]) / 2$$

This method has traditionally been used to analyze the FAs esterified in the *sn*-2 position [107,108] and has also been an extremely helpful tool in characterizing enzymatically modified butterfat TAGs [109–112]. Applying various chromatographic techniques (TLC, GC, and HPLC) in combination with enzymatic analysis has also yielded valuable information. By applying enzymatic methods to TAG fractions isolated by RP-HPLC, Kermasha et al. [113] found higher abundance of certain FAs (C14, C16, and C18) at the *sn*-2 position in butterfat. This method allowed various interesterified dairy fats to be characterized [114,115]. GC and <sup>1</sup>H-NMR spectroscopy has also been used to determine the positional distribution of butyryl groups in milk fat TAGs, and integration of the characteristic NMR signals has been used to elucidate natural and interesterified butter oil mixtures [116].

Chemical methods that offer an alternative to pancreatic lipase for regiospecific analysis of TAGs have also been developed. For this, TAGs are reacted with ethyl magnesium bromide (Grignard reagent), releasing FAs and forming all possible glycerides (di- and monoacylglycerols), provided that the reaction is not allowed to run to completion. The reaction time must be controlled to achieve roughly 50% hydrolysis. The various reaction products can be isolated by TLC on layers of silica gel G impregnated with boric acid [46].

There are two options for stereospecific analysis of milk fat TAGs: separating the enantiomeric derivatives of the partial diacylglycerides (3,5-dinitrophenylurethane [DNPU] derivatives) formed with an achiral reagent by HPLC with a chiral stationary phase or separating the diastereomeric derivatives of the partial diacylglycerides formed with a chiral reagent by HPLC with an achiral stationary phase.

Chiral substances may be applied on HPLC column stationary phases to separate *sn*-1,2, *sn*-1,3, and *sn*-2,3-diacylglycerides previously formed by partial hydrolysis of the TAGs on incubation with Grignard reagent as mentioned previously. Chiral-phase HPLC has been used to determine the positional distribution of butyric acid from DNPU derivatized diacylglycerols and corroborated that this FA was present almost exclusively in the *sn*-3 position in bovine milk fat [117]. More recently, a very similar analytical approach undertaken by Valeille and Martin [118] confirmed that *cis*-9 *trans*-11 C18:2, an FA with potentially healthy properties, is predominantly located in the external position on dairy fat TAGs and that it is mainly acylated in the *sn*-3 position. This positioning is highly favorable for complete release in free form, which is most likely relevant from the standpoint of bioavailability and biological activity. However, it needs to be borne in mind that this analytical procedure is long and laborious and calls for expensive chiral stationary phase HPLC columns.

As an alternative to HPLC with chiral phase columns, Christie et al. [119] and Christie [56] proposed derivatizing *sn*-1,2, *sn*-2,3, and *sn*-1,3 diglycerides with a chiral reagent to yield chiral diastereomeric derivatives resolvable on silica columns by adsorption HPLC. Although they succeeded in resolving the chiral enantiomers present in simple natural fats, they were unable to completely separate the pure peaks in more complex fats like dairy fat. The *sn*-1,2 and *sn*-2,3 diglyceride derivatives separated in different peaks, but each peak still contained several diastereomeric derivatives.



Some work has discussed the potential ability of MS to differentiate TAG regioisomers, and some of this information has been referred to in previous sections. However, numerous studies using GC or HPLC with positive and negative CI-MS [48,79,64,75], capillary SFC-APCI-MS [104], GC-EI-MS [51], HPLC-tandem MS [66,94], and HPLC-APCI-MS [88–90] have failed to disclose direct evidence of the presence of stereoisomers in dairy fats. Kalo et al. [95] used NP-HPLC with positive ion tandem MS to obtain quantitative information on the stereoisomers in milk fat fractions containing low molecular weight TAGs. Although the FAs in the *sn*-1 and *sn*-3 positions could not be differentiated, the overall distribution of butterfat FAs calculated from direct MS measurements was consistent with the results of indirect determinations based on stereospecific analysis of total butterfat.

## 7.6 Final Considerations

Advances in chromatographic techniques have made it much easier to determine many of the components of the fat fraction in milk while making it possible to address formerly intractable analytical problems. Thus, for quality control purposes, GC analysis of TAGs by CN using short capillary columns would appear to be a wholly reliable procedure.

Combining fractionation methods like Ag<sup>+</sup>-TLC and Ag<sup>+</sup>-HPLC with GC or RP-HPLC with MS has enabled large numbers of molecular species of TAGs to be identified and quantified. In addition, stereospecific and chemical methods have also been used to increase our knowledge of the distribution of FAs on the TAG molecules. Nevertheless, because of the complex nature of this milk component, further work is needed with a view to simplify analytical procedures generally and those aimed at elucidating the distribution of FAs on TAG molecules in particular.

## References

1. Jensen, R.G., The composition of bovine milk lipids: January 1995 to December 2000, *J. Dairy Sci.*, 85, 295, 2002.
2. MacGibbon, A.K.H. and Taylor, M.W., Composition and structure of bovine milk lipids, in *Advanced Dairy Chemistry*, 3rd edition, Fox, P.F. and McSweeney, P.L.H. (eds.), Springer, New York, 2006, p. 1.
3. Fontecha, J. et al. Triglyceride analysis by GC in assessment of authenticity of goat's milk fat, *JAOCS*, 75, 1893, 1998.
4. EU, Methods for the analysis and quality evaluation of milk and milk products. Commission Regulation (EC) No. 213/2001 of 9 January. *Off. J. Eur. Commun.*, L37, 42–99, 2001.
5. EU, Methods for the analysis and the evaluation of the quality of milk and dairy products. Commission Regulation (EC) No. 273/2008 of 5 March, *Off. J. Eur. Commun.*, L88, 1–115, 2008.
6. Precht, D., Gas chromatography of triacylglycerols and other lipids on packed columns, in *Handbook of Chromatography: Analysis of Lipids*, Muakherjee, K.D. and Weber, N. (eds.), CRC Press, Boca Raton, FL, 1993, p. 123.
7. Lipp, M., Review of methods for the analysis of triglycerides in milk fat: Application for studies of milk quality and adulteration, *Food Chem.*, 54, 213, 1995.
8. De la Fuente, M.A. and Juárez, M., Application of chromatographic techniques to the study of triglycerides and sterols of milk fat, *Food Sci. Tech. Int.*, 52, 103, 1999.
9. De la Fuente, M.A. and Juárez, M., Authenticity assessment of dairy products, *Crit. Rev. Food Sci. Nutr.*, 45, 563, 2005.
10. Ulberth, F. and Buchgraber, M., Authenticity of fats and oils, *Eur. J. Lipid Sci. Tech.*, 102, 687, 2000.

11. Kamm, W. et al., Authenticity of fats and oils, *Food Rev. Int.*, 17, 249, 2001.
12. Jee, M., Milk fat and other animal fats, in *Oils and Fat Authentication*, Jee, M. (ed.), Blackwell Publishing, Oxford, U.K., 2002, p. 115.
13. Timms, R.E., Detection and quantification of non-milk fat in mixtures of milk and non-milk fats, *J. Dairy Res.*, 47, 295, 1980.
14. Precht, D., Control of milk fat purity by gas chromatographic triglyceride analysis, *Kieler Milch-wirtschaft. Forschungber.*, 43, 219, 1991.
15. Precht, D., Detection of adulterated milk fat by fatty acid and triglyceride analysis, *Fett Wissens. Tech.*, 93, 538, 1991.
16. Precht, D., Detection of foreign fat in milk fat I. Qualitative detection by triacylglycerol formulae, *Z. Lebensm. Unters. Forsch.*, 194, 1, 1992.
17. Precht, D., Detection of foreign fat in milk fat II. Quantitative evaluation of foreign fat mixtures, *Z. Lebensm. Unters. Forsch.*, 194, 107, 1992.
18. Lipp, M., Comparison of PLS, PCR, and MLR for the quantitative determination of foreign oils and fats in butter fats of several European countries by their triglyceride composition, *Z. Lebensm. Unters. Forsch.*, 202, 193, 1996.
19. Lipp, M., Determination of the adulteration of butter fat by its triglyceride composition obtained by GC. A comparison of the suitability of PLS and neural networks, *Food Chem.*, 55, 3389, 1996.
20. Collomb, M., Spahni, M., and Buehler, T., Analysis of triglycerides. II Validation of a multilinear regression method for the determination of foreign fats in milk fat, *Mitt. Geb. Lebensm. Unters. Hyg.*, 89, 75, 1998.
21. Collomb, M. et al., Analysis of triglycerides. III Comparison of methods of MLR, PLS and PCA regression for the determination of foreign fats in milk fat using capillary GC, *Mitt. Geb. Lebensm. Unters. Hyg.*, 89, 617, 1998.
22. EU, Detailed rules for intervention on the market in butter and cream. Commission Regulation (EEC) No. 454/95 of 28 February, *Off. J. Eur. Commun.*, L46:1:30, 1995.
23. Van Renterghem, R., The triglyceride composition of Belgian butter in view of EU controls on milk fat purity, *Milchwissenschaft*, 52, 79, 1997.
24. Contarini, G. and Battelli, G., Application of EU method for the evaluation of the purity milkfat: Experiences and suggestions, *Riv. Ital. Sostan. Grasse*, 74, 527, 1997.
25. Molkentin, J., Detection of foreign fat in milk fat from different continents by triacylglycerol analysis, *Eur. J. Lipid Sci. Tech.*, 109, 505, 2007.
26. EU, Detailed rules for the application of Council Regulation (EC) No. 1255/1999 as regards intervention on the market in butter and cream. Commission Regulation (EC) No. 2771/99 of 16 December, *Off. J. Eur. Commun.*, L333, 23–26, 1999.
27. Molkentin, J. and Precht, D., Comparison of packed and capillary columns for quantitative gas chromatography of triglycerides in milk fat, *Chromatographia*, 39, 265, 1994.
28. Lercker, G. et al., Milk fat. Gas chromatographic analysis of triglycerides in assessment of authenticity of butter, *Sci. Tec. Latt.-Caseario*, 43, 95, 1992.
29. Contarini, G. et al., Valutazione della genuinità del burro mediante analisi di trigliceridi ed acidi grassi, *Riv. Ital. Sostan. Grasse*, 70, 491, 1993.
30. Molkentin, J. and Precht, D., Entwicklung einer praezisen kapillar-GC-Methode zur schnellen Triglyceridanalytik von Milchfetten, *Fett Wissens. Tech.*, 97, 43, 1995.
31. Molkentin, J. and Precht, D., Equivalence of packed and capillary GC columns for detection of foreign fat in butter by use of the triglyceride formula method, *Chromatographia*, 52, 791, 2000.
32. Lozada, L. et al., Considerations of the quantitative aspect of the determination of milkfat triglycerides with split PTV and on-column injection, *J. High Res. Chromatogr.*, 18, 771, 1995.
33. Ulberth, F., Gabernig, R., and Roubicek, D., Gas chromatographic triglyceride profiling of milk fat: comparison of packed and short metal capillary column, *Z. Lebensm. Unters. Forsch.*, 206, 21, 1998.
34. Destailats, F. et al., Authenticity of milk fat by fast analysis of triacylglycerols. Application to the detection of partially hydrogenated vegetable oils, *J. Chromatogr. A*, 1131, 227, 2006.

35. Goudjil, J. et al., Triglyceride composition of ewe's milk fat. Detection of foreign fats, *JAOCS*, 80, 219, 2003.
36. Fontecha, J. et al., Triacylglycerol composition of protected designation of origin cheeses during ripening. Authenticity of milk fat, *J. Dairy Sci.*, 89, 882, 2006.
37. Battelli, G. and Pellegrino L., Detection of non-dairy fat by gas chromatography of triglycerides, *Ital. J. Food Sci.*, 6, 407, 1994.
38. Fontecha, J. et al., Changes in the triacylglycerol composition of cheeses with high lipolysis levels during ripening. Milk fat authenticity, *Int. Dairy J.*, 16, 1498, 2006.
39. Peña, A. et al., Triglyceride characterization of different Mexican cheeses by high temperature capillary gas chromatography, *J. High Resol. Chromatogr.*, 20, 572, 1997.
40. Hinshaw, J. and Seferovic, W., Analysis of triglycerides by capillary gas chromatography with programmed-temperature injection, *J. High Resol. Chromatogr.*, 9, 731, 1986.
41. Alonso, L., Capillary gas chromatography of some triglycerides in cheese using programmed-temperature injection, *Chromatographia*, 35, 649, 1993.
42. Banfi, S. et al., Programmable temperature vaporizer (PTV) applied to the triglyceride analysis of milk fat, *J. High Res. Chromatogr.*, 22, 93, 1999.
43. Andrikopoulos, N.K., Chromatographic and spectroscopic methods in the analysis of triacylglycerol species and regiospecific isomers of oils and fats, *Crit. Rev. Food Sci. Nutr.*, 42, 473, 2002.
44. Buchgraber, M. et al., Triacylglycerol profiling by using chromatographic techniques, *Eur. J. Lipid Sci. Tech.*, 106, 621, 2004.
45. Dobson, G., Christie, W.W., and Nikolova-Damyanova, B., Silver ion chromatography of lipids and fatty acids, *J. Chromatogr. B*, 671, 197, 1995.
46. Christie, W.W., *Lipid Analysis*, 3rd edition, The Oily Press, Bridgwater, U.K., 2003.
47. Lund, P., Analysis of butterfat triglycerides by capillary gas chromatography, *Milchwissenschaft*, 43, 159, 1988.
48. Myher, J.J. et al., Identification of the more complex triacylglycerols in bovine milk fat by gas chromatography-mass spectrometry using polar capillary columns, *J. Chromatogr.*, 452, 93, 1988.
49. Fraga, M.J. et al., Silver ion adsorption-TLC and capillary-GC in the study of composition of milk fat triglycerides, *J. Agric. Food Chem.*, 46, 1836, 1998.
50. Fontecha, J. et al., Composition of goat's milk fat triglycerides analysed by silver ion adsorption-TLC and GC-MS, *Int. Dairy J.*, 10, 119, 2000.
51. Kalo, P. and Kemppinen, A., Mass spectrometric identification of triacylglycerols of enzymatically modified butterfat separated on a polarizable phenylmethylsilicone column, *JAOCS*, 70, 1209, 1993.
52. Kemppinen, A. and Kalo, P., Fractionation of the triacylglycerols of lipase-modified butter oil, *JAOCS*, 70, 1203, 1993.
53. Kemppinen, A. and Kalo, P., Analysis of *sn*-1 (3) and *sn*-2-short chain acyl isomers of triacylglycerols in butteroil by gas-liquid chromatography, *JAOCS*, 75, 91, 1998.
54. Kemppinen, A. and Kalo, P., Quantification of triacylglycerols in butterfat by gas chromatography-electron impact mass spectrometry using molar correction factors for  $[M-R\text{COO}]^+$  ions, *J. Chromatogr. A*, 1134, 260, 2006.
55. Christie, W.W., Silver ion chromatography of triacylglycerols on solid phase extraction columns packed with a bonded sulphonic acid phase, *J. Chromatogr.*, 454, 273, 1988.
56. Christie, W.W., Silver ion and chiral chromatography in the analysis of triacylglycerols, *Prog. Lipid Res.*, 33, 9, 1994.
57. Evershed, R.P., High-resolution triacylglycerol mixture analysis using high-temperature gas chromatography mass spectrometry with a polarizable stationary phase, negative ion chemical ionization, and mass-resolved chromatography, *J. Am. Soc. Mass Spectrom.*, 7, 350, 1996.
58. Fontecha, J. et al., Identity of the major triacylglycerols in ovine milk fat, *Int. Dairy J.*, 15, 1217, 2005.
59. Murata, T. and Takahashi, S., Analysis of triglyceride mixtures by gas-chromatography-mass-spectrometry, *Anal. Chem.*, 45, 1816, 1970.

60. Murata, T., Analysis of triglycerides by gas chromatography chemical ionization mass-spectrometry, *Anal. Chem.*, 45, 1816, 1977.
61. Picariello, G., Sacchi, R., and Addeo, F., One-step characterization of triacylglycerols from animal fat by MALDI-TOF MS, *Eur. J. Lipid Sci. Tech.*, 109, 511, 2007.
62. Ruiz-Gutiérrez, V. and Barrón, L.J.R., Methods for the analysis of triacylglycerols, *J. Chromatogr. B*, 671, 133, 1995.
63. Plattner, R.D., Spencer, G.F., and Kleiman, R., Triglyceride separation by RP-HPLC, *JAOCS*, 54, 511, 1977.
64. Kuksis, A., Marai, L., and Myher J.J., Reversed-phase liquid chromatography of complex mixtures of natural triacylglycerols with chloride-attachment negative chemical ionization, *J. Chromatogr.*, 588, 73, 1991.
65. Marai, L., Kuksis, A., and Myher J.J., Reversed-phase liquid chromatography-mass spectrometry of the uncommon triacylglycerol structures generated by randomization of butteroil, *J. Chromatogr.*, 672, 87, 1994.
66. Spanos, G.A. et al., High-performance liquid chromatography with light-scattering detection and desorption chemical-ionization tandem mass spectrometry of milk fat triacylglycerols, *Lipids*, 30, 85, 1995.
67. El-Hamdy, A. and Perkins, E., HPLC of natural triglyceride mixtures: Critical pair separation, *JAOCS*, 58, 867, 1981.
68. Robinson, J.L. and Macrae, R., Comparison of detection systems for the HPLC analysis of complex triglyceride mixtures, *J. Chromatogr.*, 303, 386, 1984.
69. Weber, K., Schulte, E., and Thier, H.P., Trennung der Triglyceride von Kuhmilch und Humanmilch durch HPLC und Untersuchung der Fraktionen durch GC, *Fett Wissens. Tech.*, 9, 341, 1988.
70. Weber, K., Schulte, E., and Thier H.P., Die Zusammensetzung der Triglyceride von Kuhmilch und Humanmilch, *Fett Wissens. Tech.*, 10, 389, 1988.
71. Bornaz, S., Novak, G., and Parmentier M., Seasonal and regional variation in triglyceride composition of French butterfat, *JAOCS*, 69, 1131, 1992.
72. Dotson, K.D. et al., High-performance liquid chromatography of human milk triacylglycerols and gas chromatography of component fatty acids, *Lipids*, 27, 933, 1992.
73. Hinrichs, U., Heinemann U., and Kessler, H.G., Differences in the composition of triglycerides in summer and winter milk fat, *Milchwissenschaft*, 47, 495, 1992.
74. Barrón, L.J.R., Hierro M.T.G., and Santa-María G., HPLC and GLC analysis of the triglyceride composition of bovine, ovine and caprine milkfat, *J. Dairy Res.*, 57, 517, 1990.
75. Barrón, L.J.R. and Santa-María, G., Aplicación de la cromatografía de alta eficacia al análisis de grasas y aceites de origen animal y vegetal, *Rev. Agroquím. Tecnol. Alim.*, 31, 66, 1990.
76. Robinson, N. and MacGibbon, A.K.H., Determination of the conjugated linoleic acid containing triacylglycerols in New Zealand milk fat, *Lipids*, 35, 789, 2000.
77. Nurmela, K.V.V. and Satama L.T., Quantitative analysis of triglycerides by high-performance liquid chromatography using non-linear gradient elution and flame ionization detection, *J. Chromatogr.*, 435, 139, 1988.
78. Laakso, P.H., Nurmela K.V.V., and Hømer, D.R., Composition of the triacylglycerols of butterfat and its fractions obtained by industrial melt crystallization process, *J. Agric. Food Chem.*, 40, 2472, 1992.
79. Myher, J.J., Kuksis, A., and Marai L., Identification of the less common isologous short-chain triacylglycerols in the most volatile 2.5% molecular distillate of butter oil, *JAOCS*, 70, 1183, 1993.
80. Brühl, L., Schulte, E., and Thier, H.P., Fraktionierung der Triglyceride von Muttermilch durch HPLC an einer Silberionsaeule und an RP-18-Material mit dem Lichtstredetektor, *Fett Wissens. Tech.*, 95, 370, 1993.
81. Brühl, L., Schulte, E., and Thier, H.P., Zusammensetzung und Aufbau der Triglyceride von Muttermilch und einiger Rohstoffe für Säuglingsnahrung, *Fett Wissens. Tech.*, 96, 147, 1994.
82. Ruiz-Sala, P. et al., Triglyceride composition of ewe, cow, and goat milk fat, *JAOCS*, 73, 283, 1996.

83. Robinson, N. and MacGibbon, A.K.H., The composition of New Zealand milk fat triacylglycerols by reverse-phase high performance liquid chromatography, *JAOCS*, 75, 993, 1998.
84. Laakso, P. and Kallio H., Triacylglycerols of winter butterfat containing configurational isomers of monoenoic fatty acyl residues I. Disaturated monoenoic triacylglycerols, *JAOCS*, 70, 1161, 1993.
85. Kallio, H. et al., The regiospecific position of 18:1 *cis* and *trans* monoenoic fatty acids in milk fat triacylglycerols, *JAOCS*, 83, 407, 2006.
86. Byrdwell, W.C. and Emken, E.A., Analysis of triglycerides using atmospheric-pressure chemical ionization mass spectrometry, *Lipids*, 30, 173, 1995.
87. Rezanka, T. and Sigler, K., The use of atmospheric pressure chemical ionization mass spectrometry with high performance liquid chromatography and other separation techniques for identification of triacylglycerols, *Curr. Anal. Chem.*, 3, 252, 2007.
88. Mottram, H.R. and Evershed, R.P., Elucidation of the composition of bovine milk fat triacylglycerols using high-performance liquid chromatography-atmospheric pressure chemical ionization mass spectrometry, *J. Chromatogr. A*, 926, 239, 2001.
89. Dugo, P. et al., Determination of triacylglycerols in donkey milk by using high performance liquid chromatography coupled with atmospheric pressure chemical ionization mass spectrometry, *J. Sep. Sci.*, 28, 1023, 2005.
90. Dugo, P. et al., Separation of triacylglycerols in a complex lipidic matrix by using comprehensive two-dimensional liquid chromatography coupled with atmospheric pressure chemical ionization mass spectrometric detection, *J. Sep. Sci.*, 29, 1146, 2006.
91. Currie, G.J. and Kallio, H., Triacylglycerols of human milk: Rapid analysis by ammonia negative in tandem mass spectrometry, *Lipids*, 28, 217, 1993.
92. Kallio, H. and Rua, P., Distribution of the major fatty-acids of human-milk between *sn*-2 and *sn*-1,3 positions of triacylglycerols, *JAOCS*, 71, 985, 1994.
93. Kurvinen, J.P., Sjoval, O., and Kallio, H., Molecular weight and regioisomeric structure of triacylglycerols in some common human milk substitutes, *JAOCS*, 79, 13, 2002.
94. Laakso, P. and Kallio, H., Triacylglycerols of winter butterfat containing configurational isomers of monoenoic fatty acyl residues II. Saturated dimonoenoic triacylglycerols, *JAOCS*, 70, 1173, 1993.
95. Kalo, P. et al., Regiospecific determination of short-chain triacylglycerols in butterfat by normal-phase HPLC with on-line electrospray-tandem mass spectrometry, *Lipids*, 39, 915, 2004.
96. Banks, W. et al., Fractionation of hydrogenated milk fat using thin layer chromatography, *J. Sci. Food Agric.*, 48, 495, 1989.
97. Steele, W. and Banks, W., Triglyceride distribution in hydrogenated milk fat and its effects on separation by thin layer chromatography, *Milchwissenschaft*, 49, 372, 1994.
98. Adlof, R.D., Analysis of triacylglycerol positional isomers by silver ion HPLC, *J. High Res. Chromatogr.*, 18, 105, 1995.
99. Maniongui, C. et al., Determination of bovine butterfat triacylglycerols by reversed-phase liquid chromatography and gas chromatography, *J. Chromatogr.*, 543, 81, 1991.
100. Gresti, J. et al., Composition of molecular species of triacylglycerols in bovine milk fat, *J. Dairy Sci.*, 76, 1850, 1993.
101. Huopalahti, R. et al., Preliminary studies on triacylglycerols of fats and oils by capillary SFC, *J. High Res. Chromatogr.*, 11, 899, 1988.
102. Kallio, H. et al., Analysis of butter fat triacylglycerols by supercritical fluid chromatography/electron impact mass spectrometry, *Anal. Chem.*, 61, 698, 1989.
103. Manninen, P., Laakso, P., and Kallio, H., Method for characterization of triacylglycerols and fat-soluble vitamins in edible oils and fats by supercritical fluid chromatography, *JAOCS*, 72, 1001, 1995.
104. Laakso, P. and Manninen, P., Identification of milk fat triacylglycerols by capillary supercritical fluid chromatography atmospheric pressure chemical ionization mass spectrometry, *Lipids*, 32, 1285, 1997.

105. Ruiz-Gutiérrez, V. and Barrón, L.J.R., Análisis estereoespecífico de los triacil-*sn*-gliceroles de las grasas naturales por métodos enzimáticos y cromatografía líquida de alta eficacia, *Grasas Aceites*, 46, 376, 1995.
106. Laakso, P., Analysis of triacylglycerols-approaching the molecular composition of natural mixtures, *Food Rev. Int.*, 12, 199, 1996.
107. DePeters et al., Fatty acid and triglyceride composition of milk fat from lactating Holstein cows in response to supplemental canola oil, *J. Dairy Sci.*, 84, 929, 2001.
108. Mistry, D.H., DePeters, E.J., and Medrano, J.F., Comparative composition of total and *sn*-2 fatty acids in bovine and ovine milk fat, *Lait*, 82, 255, 2002.
109. Kalo, P., Huotari, H., and Antila, M., *Pseudomonas fluorescens* lipase-catalysed interesterification of butter fat, *Fett Wissens. Tech.*, 91, 276, 1989.
110. Kalo P., Huotari, H., and Antila M., Chemical composition of butter fat interesterified with *Pseudomonas fluorescens* lipase at various temperatures, *Meijeritieteellinen-Aikakauskirja*, 47, 29, 1989.
111. Kalo, P., Huotari, H., and Antila, M., *Pseudomonas fluorescens* lipase-catalysed interesterification of butter fat in the absence of a solvent, *Milchwissenschaft*, 91, 281, 1990.
112. Christensen, T.C. and Hølmer, G., Lipase catalyzed acyl-exchange reactions of butter oil. Synthesis of a human milk fat substitute for infant formulas. *Milchwissenschaft*, 48, 543, 1993.
113. Kermasha, S. et al., Determination of the positional distribution of fatty acids in butterfat triacylglycerols, *JAACS*, 70, 169, 1993.
114. Safari, M. and Kermasha, S., Interesterification of butterfat by commercial microbial lipases in a cosurfactant-free microemulsion system, *JAACS*, 71, 969, 1994.
115. Safari, M. et al., Interesterification of butterfat by lipase from *Rhizopus niveus* in reverse micellar systems, *Biosci. Biotech. Biochem.*, 58, 1553, 1994.
116. Kalo, P., Kemppinen, A., and Kilpeläinen, I., Determination of positional distribution of butyryl groups in milkfat triacylglycerols, triacylglycerols mixtures, and isolated positional isomers of triacylglycerols by gas chromatography and <sup>1</sup>H nuclear magnetic resonance spectroscopy, *Lipids*, 31, 331, 1996.
117. Itabashi, Y., Myher, J.J., and Kuksis A., Determination of positional distribution of short-chain fatty acids in bovine milk fat on chiral columns, *JAACS*, 70, 1177, 1993.
118. Vaille, K. and Martin, J.C., Complete stereospecific determination of conjugated linoleic acids in triacylglycerol of milk fat, *Reprod. Nutr. Dev.*, 44, 459, 2004.
119. Christie, W.W. et al., Stereospecific analysis of triacyl-*sn*-glycerols via resolution of diastereomeric diacylglycerol derivatives by high-performance liquid chromatography on silica, *JAACS*, 68, 695, 1991.



## Chapter 8

---

# Dairy Polar Lipids

---

Roeland Rombaut and Koen Dewettinck

### CONTENTS

8.1	Introduction.....	189
8.1.1	Polar Lipids in Dairy Products.....	189
8.1.2	Location of Dairy Polar Lipids.....	192
8.1.3	Polar Lipid Content of Dairy Products .....	192
8.2	Sample Preparation.....	193
8.2.1	Extraction.....	193
8.2.2	Fractionation of Dairy Polar Lipids .....	195
8.3	Polar Lipid Analysis .....	199
8.3.1	Total Phospholipid Content .....	199
8.3.2	Total Sphingolipid Content .....	200
8.3.3	Thin-Layer Chromatography .....	200
8.3.4	High-Performance Liquid Chromatography .....	202
8.3.4.1	Separation of Polar Lipid Classes .....	202
8.3.4.2	HPLC Detectors for Polar Lipid Analysis.....	204
8.3.5	<sup>31</sup> Phosphorous Nuclear Magnetic Resonance .....	204
	Abbreviations.....	205
	References.....	206

## 8.1 Introduction

### 8.1.1 Polar Lipids in Dairy Products [1–5]

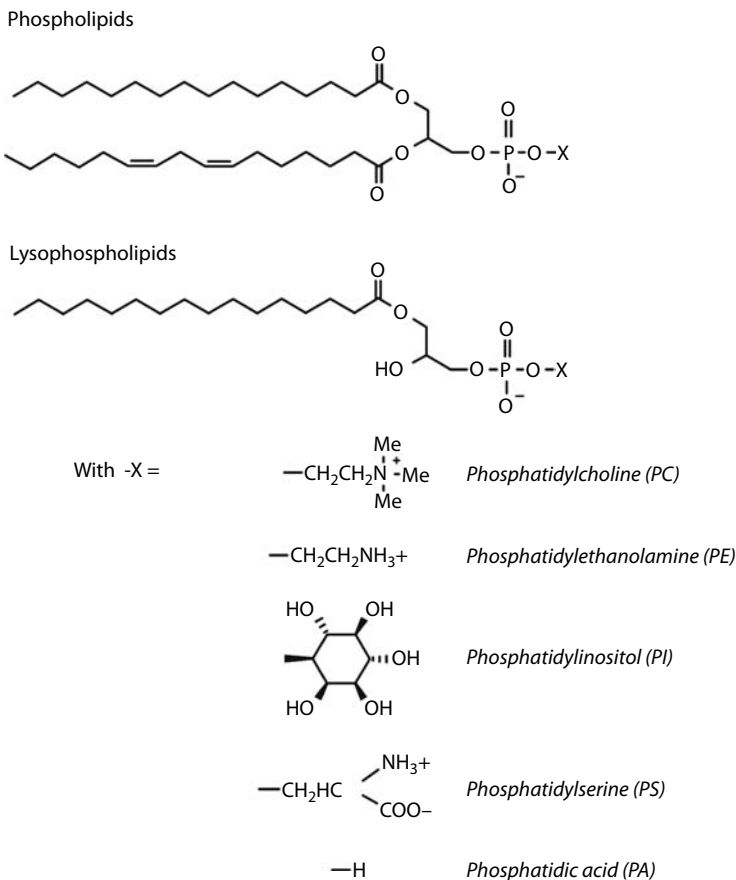
The polar lipids in dairy products comprise phospho- and sphingolipids, which are amphiphilic molecules with a hydrophobic tail and a hydrophilic head group. As not all the sphingolipids in



dairy products possess an organophosphate group, the term dairy polar lipids is preferred over dairy phospholipids to denote the group of phospho- and sphingolipids present in dairy products.

The first group of polar lipids in milk is the “glycerophospholipids.” They consist of a glycerol molecule to which two fatty acids are bound on position sn-1 and sn-2. To the third hydroxyl group of glycerol, a phosphate residue with different organic residues (choline, serine, ethanolamine, etc.) may be linked. Lysophospholipids are similar in structure, but contain only one acyl group, predominantly situated at the sn-1 position. The head group remains similar. The major glycerophospholipids in dairy products, namely phosphatidylethanolamine (PE), phosphatidylcholine (PC), phosphatidylserine (PS), phosphatidylinositol (PI), and phosphatidic acid (PA) are represented in Figure 8.1.

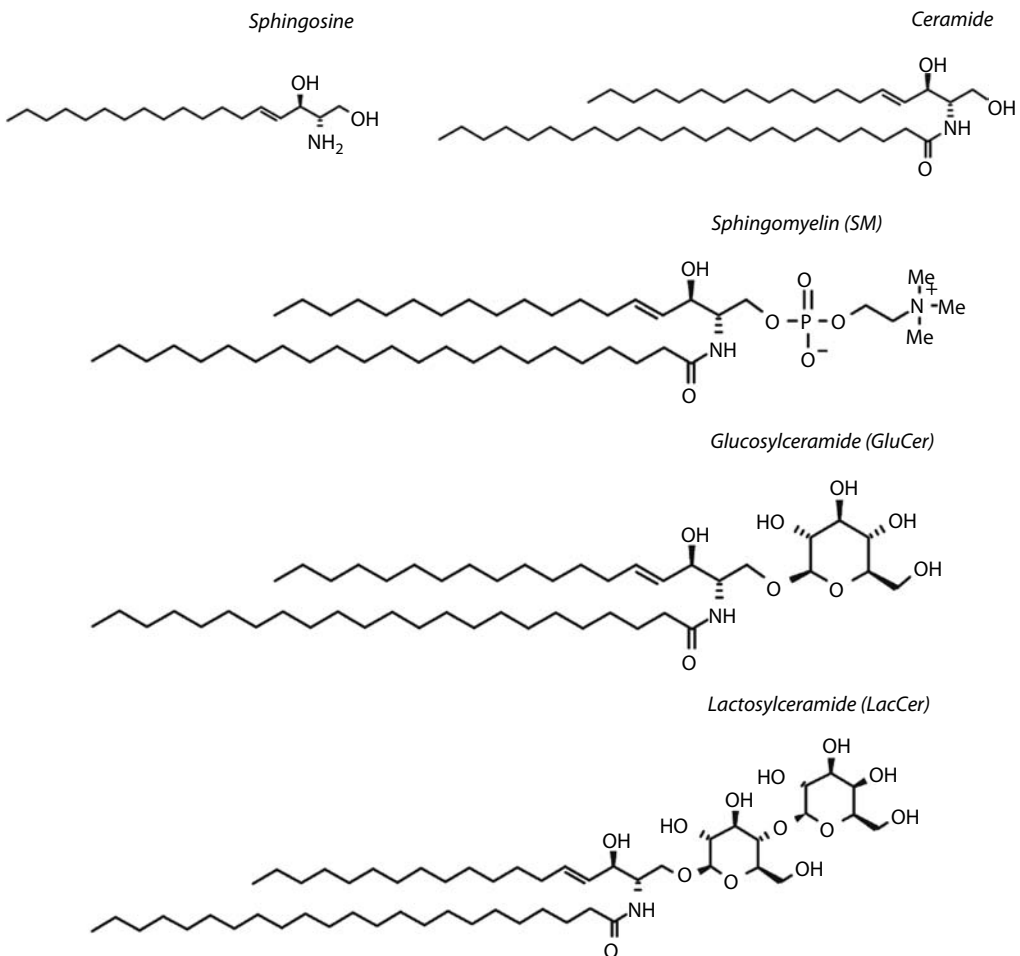
The second group is the “sphingolipids,” whose characteristic structural unit consists of a sphingoid base, which is a long-chain (12–22 carbon atoms) aliphatic amine, containing two or three hydroxyl groups. Sphingosine (d18:1) is the most prevalent sphingoid base in milk, containing 18



**Figure 8.1** Molecular structure of the major glycerophospholipids in dairy products. The fatty-acid residues are taken arbitrarily. (From Rombaut, R., *Enrichment of nutritionally advantageous milk fat globule membrane fragments present in dairy effluents*, PhD dissertation, Ghent University, Gent, 2006. With permission.)

carbon atoms, two hydroxyl groups, and one double bond. A ceramide is formed when the amino group of this sphingoid base is linked to a saturated fatty acid. Furthermore, odd-numbered (e.g., C23:0) acyl chains can be found [6]. On this ceramide unit, an organophosphate group can be bound to form a sphingophospholipid (e.g., phosphocholine in the case of sphingomyelin [SM]) or to a sugar residue to form the sphingoglycolipids (glycosylceramides). Monoglycosylceramides, like glucosylceramide or galactosylceramide, are often referred to as cerebrosides. Finally, gangliosides are highly complex oligoglycosylceramides, containing one or more sialic acid groups in addition to glucose, galactose, and galactosamine. The major sphingolipids in dairy products, glucosylceramide (GluCer), lactosylceramide (LacCer), and SM, are represented in Figure 8.2.

## Sphingolipids



**Figure 8.2** Molecular structure of the major sphingolipids in dairy products. Acyl residues are taken arbitrarily. (From Rombaut, R., Enrichment of nutritionally advantageous milk fat globule membrane fragments present in dairy effluents, PhD dissertation, Ghent University, Gent, 2006. With permission.)

In milk, the glycerophospholipids are more unsaturated than the triglyceride fraction of milk. The short- and midchain fatty acids (C4–C14), which are typical for milk fat, are virtually absent in the phospholipid fraction of milk. In particular, PE is highly unsaturated, followed by PI and PS. PC is rather saturated when compared with the other glycerophospholipids. The fatty-acid pattern of SM is very uncommon. Although long-chain fatty acids occur, nearly all of them are saturated ( $\approx 97\%$ ). In addition, the occurrence of C23:0 ( $>17\%$ ) is remarkable [6].

In the last decade, milk polar lipids have gained attention for their presumed beneficial nutritional properties. In particular, sphingolipids and their metabolites, ceramide, sphingosine, and sphingosine phosphate, have been found to be highly active and are linked to age-related diseases, blood coagulation, immunity, and inflammatory responses [7–10]. Sphingolipids and their metabolites have been shown to exhibit a profound downregulating effect on intestinal inflammation and the development of colon cancer, and could as such be an important mediator in the prevention of bowel-related diseases [4,11,12]. Sphingolipids are also found to significantly lower the cholesterol absorption in rats (up to 85.5% reduction) [13]. This dose-dependent decrease was found to be higher for milk SM than SM from other sources [14,15]. Following sphingolipids, other dairy polar lipids are also believed to exert a certain positive health effect [16–18].

### **8.1.2 Location of Dairy Polar Lipids**

Major part of the polar lipids in dairy products is arranged in the membranous mono- or bilayered structures. During the secretion of milk fat in the secretory cells of the mammary gland, the milk fat globule is enveloped by a monolayer and a bilayer of polar lipids, thereby stabilizing the fat globule in the continuous phase of the milk, and preventing it from enzymatic degradation by lipases [5,19]. This milk fat globule membrane (MFGM) is a highly complex biological membrane, consisting of polar lipids, specific MFGM-proteins, cholesterol, and traces of mono-, di-, and triglycerides [20]. As such, in raw, unhomogenized milk, the majority of the milk polar lipids is situated in the MFGM surrounding the fat globule. The remaining polar lipids can be recovered in the sedimentable lipid fraction upon ultracentrifugation of milk (sometimes denoted as the plasma-membrane fraction) and consist of cellular debris and membrane material of the secretory cell, leukocytes, bacteria, and damaged MFGM-fragments [21]. After milk secretion and milking, compositional and structural changes in the MFGM occur, and the membrane material is shed into the skimmed milk phase. Factors like (mechanical) agitation, temperature, age, bacteriological quality, stage of lactation, and season can influence these changes [22]. Upon processing of milk, the MFGM is ruptured and the filamentous MFGM-fragments are recovered in the aqueous process stream like whey (cheese production), buttermilk (butter production), and butter or cream serum (butter oil production) [23–25].

### **8.1.3 Polar Lipid Content of Dairy Products**

The polar lipid content of raw milk is reported between 9.4 and 35.5 mg/100 g. The major milk phospholipids are PE (19.8%–42.0%), PC (19.2%–37.3%), PS (1.9%–10.5%), and PI (0.6%–11.8%). The major milk sphingolipids are GluCer (2.1%–5.0%, w/w), LacCer (LacCer) (2.8%–6.7%, w/w), and SM (18.0%–34.1%, w/w) [5]. Lysophospholipids and PA are normally not present in dairy products. Their occurrence is attributed to enzymatic activity of phospholipases, caused by excessive storage and bad sample preparation. Newburg and Chaturvedi [2] investigated the detailed glycosphingolipid composition of bovine milk. They reported values of 0.67 mg GluCer

and 1.71 mg LacCer/100 g of raw milk. Different gangliosides are present in bovine milk; however, some of them are present only in trace amounts. The ganglioside content of bovine milk, of which monosialoganglioside 3 (GM<sub>3</sub>) and disialoganglioside 3 (GD<sub>3</sub>) are the major ones, varies between 0.14 and 1.10 mg/100 mL [26,27]. For more details on structure, naming, function, and occurrence of milk gangliosides, the reviews of Jensen [28] and Rueda et al. [29] can be referred.

In Table 8.1, the polar lipid content is given for the basic dairy products. For a more detailed list, the work of Rombaut et al. [5,25,30] can be referred. From this table, it can be clearly noticed that huge differences in the polar lipid content on product, dry matter, and fat base can occur among different products. The increased content of polar lipids on a fat base in products like buttermilk and whey is owing to the preferential migration of MFGM fragments toward aqueous products during processing, as discussed earlier [25].

## 8.2 Sample Preparation

### 8.2.1 Extraction

Prior to the analysis, the polar lipids should be liberated from their matrix. As discussed earlier, dairy polar lipids are embedded in a biological membrane, bound tightly to membrane-specific proteins and polysaccharides. Moreover, in milk and dairy products, these polar lipids generally comprise 0.1%–1.5% of the total dry matter [30], which consists mainly of lactose, protein, triglycerides, and minerals. All these, together with the amphiphilic character of the polar lipids, make it quite difficult to completely extract the polar lipids out of a dairy product matrix. The ideal solvent to extract should be sufficiently polar to break down any polar lipid–protein bounds, without coextracting the proteins or without causing any chemical breakdown of the polar lipids. Polar lipids are generally more prone to hydrolysis and oxidation than the triglyceride fraction of the dairy products. The official methods for fat determination of dairy products by gravimetric difference after extraction, using a mixture of diethylether, petroleum ether, ethanol, and ammonia (Mojonnier method; ISO 1211) or hydrochloric acid (SBR method, ISO 5543), or a reflux of hexane after destruction with hydrochloric acid (Weibull-Berntrop method, ISO 8261) are not suitable, as they induce hydrolysis of polar lipids, with the formation of free fatty acids and lysophospholipids [31]. For suitable polar lipid extraction, an organic apolar solvent like hexane, chloroform, or dichloromethane should be mixed with a polar solvent, preferably an alcohol, like isopropanol or methanol, to break down the polar lipid–protein interactions.

Most extraction methods using mixtures of chloroform and methanol are derived from traditional total fat extraction procedures, like those of Folch et al. [32] or Bligh and Dyer [33]. Folch-based methods are typically biphasic, i.e., in a separatory funnel an upper and lower phase is obtained. The latter is the chloroform phase, containing the polar lipids. If desired, the upper phase, containing the sample, can be re-extracted with fresh solvent. After separation, the lower phases are pooled and the solvent is evaporated. Bligh and Dyer-based methods are typically monophasic, i.e., during extraction, two-phase separation does not occur. The sample is filtered or centrifuged off from the solvent. The solvent is then allowed to stand to separate into two phases, or is evaporated under vacuum. Owing to the toxicity of the chloroform/methanol mixture, Hara and Radin developed and evaluated alternative solvent systems like hexane/isopropanol [34]. The extraction yield of brain material was comparable with chloroform/methanol-based methods. The method was quicker, monophasic, and the solvents were cheaper and less toxic. Furthermore, the extract was completely clear. Turbid extracts can occur with chloroform/methanol-based

**Table 8.1 Mean Values ( $n = 2$ ) of Polar Lipid Content of Basic Dairy Products**

Product	Polar Lipids			Polar Lipid Species (% of Total Polar Lipids)							
	mg/100 g	g/100 g DM	g/100 g fat	PE	PS	PI	PC	GluCer	LacCer	SM	
Raw milk	29.4	0.23	0.7	42.0	6.7	4.8	19.1	2.7	6.7	17.9	
Skimmed milk (UHT)	12.8	0.14	10.7	38.2	9.9	5.5	19.6	1.8	8.3	16.7	
Cream (40% fat)	138.9	0.31	0.4	40.0	8.2	8.2	20.7	3.7	5.3	13.9	
Butter	141.0	0.17	0.2	37.6	8.2	4.3	20.9	3.6	8.1	17.2	
Buttermilk-sweet	91.8	1.15	21.8	42.9	8.6	8.9	19.1	1.6	6.1	12.8	
Quarg (skimmed)	32.4	0.25	24.7	39.1	5.9	3.9	18.7	2.6	10.4	19.4	
Whey (Mozzarella)	19.1	0.29	6.2	40.6	9.3	4.6	19.1	2.3	8.5	15.7	

Source: Adapted from Rombaut, R. et al., *J. Food Comp. Analysis*, 20, 308, 2007. With permission. Analyses were done by HPLC-ELSD.

methods, owing to protein coextraction. The latter can be removed from the organic phase by washing with water or salt buffers, or by removal of contaminants by gel permeation chromatography [31,35]. Another major drawback of the use of the original chloroform/methanol-based methods described earlier is that during the extraction of low-fat dairy products, stable emulsions can be formed at the interphase, which do not separate even upon centrifugation [35,36]. In Table 8.2, an overview of the different extraction procedures of dairy products is given.

Theodet and Gandemer [36] evaluated the SBR method, the Röse-Gottlieb method, the Folch method, a modified Folch method adapted for the extraction of (human) milk [37], and a hexane/isopropanol method [31] for the extraction of Emmenthal whey. They found that only the SBR extraction method resulted in a lower polar lipid yield, when compared with the other methods. However, no difference in the relative polar lipid species were noted among the different methods, except for the SBR method, where almost all the polar lipids were hydrolyzed, producing troublesome chromatograms upon high-pressure liquid chromatography (HPLC) analysis. Vaghela and Kilara [35] carried out a similar evaluation of different extractions of 75% whey-protein concentrates. However, only the total lipid yields were evaluated, without the determination of the polar lipid yield.

In the last decade, new techniques for the total lipid analysis, like extraction with supercritical carbon dioxide ( $\text{SCO}_2$ ) or pressurized solvents [38] have emerged. These techniques were mainly developed to minimize the use of toxic solvents, decrease the analysis time, and increase the versatility during extraction. The recovery of (polar) lipids during  $\text{SCO}_2$ -extraction has been shown to be far lower than 100%, even with the use of a polar modifier like ethanol [39]. Therefore, this methodology may not be applicable for analytical purposes. However, preparative applications of  $\text{SCO}_2$  for the isolation, fractionation, and purification of polar lipids from soy flakes [40,41] or buttermilk-derived fractions [42] have been applied successfully, with different recoveries in function of temperature, pressure, and ethanol concentration. Here, the major advantage is that no solvent residues remain in the final extract.

## 8.2.2 Fractionation of Dairy Polar Lipids

Dairy products can often contain high proportions of triglycerides, which make it advisable in some cases to further fractionate the crude lipid extract into different lipid classes, prior to analysis. First, the polar lipids can be easily separated from the crude lipid extract by solvent partitioning. Galanos and Kapoulas [43] found that the polar lipids of milk fat can be completely recovered in the ethanol fraction upon partitioning between ethanol/water (87/13) and petroleum ether. A variant of this methodology was described by Hartman [44]. However, these methods are labor intensive and high solvent volumes are required to obtain high recoveries. Therefore, these methods are more suitable as a first concentration step [45] or for preparative purification, where complete recoveries are not envisaged. Using a similar methodology, Baummy et al. [46] succeeded in obtaining a final polar lipid fraction from cheese whey with a purity of 77% dairy polar lipids. Here, after evaporation of the extraction solvent, cold acetone was added to the extract, in which polar lipids are not soluble, and brown lumps were formed, which then could be easily separated by filtration and centrifugation techniques.

Another technique for lipid fractionation is the use of column chromatography. In this technique, the crude lipid extract is redissolved in the correct solvent and is brought on a self-packed open glass column, or small prepacked solid-phase extraction (SPE) columns or cartridges, which can be pressurized or put under vacuum on one side to increase the elution speed. By discontinuous addition of solvents with different strengths, different lipid classes can be separately collected in different fractions. The drawbacks of these methods are that they are time-consuming

**Table 8.2 Comparison of Different Polar Lipid Extraction Methods Frequently Used for the Extraction of Dairy Products**

Name	Matrix	Test Portion	Extraction Steps	Reference
Bligh and Dyer	Fish	100 g (containing 80 g water)	1. 300 mL chloroform/methanol (1/2)	[33]
			2. 200 mL water/chloroform (1/1)	
			3. Filtration, separation into two phases, and recuperation of lower phase	
Vaghela (modified Bligh and Dyer)	Whey protein concentrate 75%	3 g of powder dissolved in 2.4 g water	1. 35 mL of chloroform/methanol (1/1)	[35]
			2. Centrifugation and recuperation of upper phase I	
			3. Re-extraction of the pellet with 35 mL of chloroform/methanol (2/1)	
			4. Centrifugation and recuperation of upper phase II	
Folch	Animal tissue	1 g	1. 20 mL of chloroform/methanol (2/1)	[32]
			2. Filtering	
			3. 2 × 0.2 mL W for washing and recuperation of lower phase	
Clark (modified Folch)	Human milk	10 mL	1. 90 mL of chloroform/methanol (2/1)	[37]
			2. Recuperation of lower phase I	
			3. Re-extraction of upper phase with 75 mL of chloroform/methanol (4/1)	
			4. Recuperation of lower phase II	
Hara and Radin	Rat brain	1 g	1. 18 mL of hexane/isopropanol (3/2)	[34]
			2. Filtering	
			3. 3 × 2 mL of hexane/isopropanol (3/2) for tissue/filter rinsing	
Wolff (modified Hara and Radin)	Emmenthal cheese	3 g	1. 40 mL of hexane/isopropanol (3/2)	[31]
			2. Slurry on celite column	
			3. 140 mL of hexane/isopropanol (3/2) to rinse the celite column	

(especially self-packed open columns), the lipid material often remains on the column resulting in low recoveries, and often there is an overlap of different lipid classes in different fractions collected, resulting in low and variable recoveries and thus, erroneous results. Therefore, the use of an internal standard that is added to the sample before the extraction and fractionation is recommended. This internal standard should be chemically inert, should be absent in dairy products, should not interfere with other compounds during analysis, but should have a high resemblance to polar lipids, such as phosphatidylmethylethanolamine, which elutes between PI and PS upon normal phase separation [47]. In Table 8.3, some methods which have shown to work with dairy products in our laboratory are given. The first three methods given in Table 8.4 are normal-phase separations, where a polar packing is used and the neutral lipid fraction is obtained first, followed by the glycolipids and polar lipids, upon increasing solvent polarity. Thus, the relatively pure lipid fractions (90%–98%) can be obtained. With a silica packing, even polar lipid classes can be separated, albeit after some trial-and-error, as the results can differ between batches of silica. Roughly, the polar lipid fractions tend to elute in the following order with chloroform/methanol mixtures

**Table 8.3 Examples of SPE Procedures for the Enrichment of Polar Lipids out of a Crude Lipid Extract**

<i>Column Type</i>	<i>Mobile Phase</i>	<i>Fraction Obtained</i>	<i>Matrix</i>	<i>Reference</i>
Silica gel	Chloroform	Neutral lipids	Oil	[45]
	Acetone	Glycolipids		
	Methanol	Polar lipids		
Sep-Pak silica cartridge	Hexane/ diethylether (1/1)	Neutral lipids	Human milk	[74]
	Methanol	Polar lipids		
	Chloroform/ methanol/ water (3/5/2)	Polar lipids		
Aminopropyl SPE column	Chloroform/2- propanol (2/1)	Neutral lipids	Whey protein concentrate	[35]
	Acetic acid/ diethylether (2/98)	Fatty acids		
	Methanol	Polar lipids		
C <sub>8</sub> SPE column	Methanol	Polar lipids	Egg powder	[48]
	Chloroform/ methanol (3/2)	Polar lipids		
	Chloroform	Polar lipids		

The mentioned solvent ratios are volumetric.



**Table 8.4 HPLC Methods for the Separation of Polar Lipid Extract of Dairy Samples**

<i>Stationary Phase</i>	<i>Mobile Phase</i>	<i>Reported Polar Lipids in Order of Increasing Retention</i>	<i>Total Run Time (min)</i>	<i>Detector</i>	<i>References</i>
Silica (Lichrospher Si60, 5 μm, 250 × 4.6 mm)	A. Chloroform	PE, PI, PS, PC, SM	25	ELSD (Sedere Sedex 45)	[61]
	B. Methanol/ammonia (27%)/chloroform (92/7/1)				
Silica (Inertsil, 5 μm, 250 × 2.1 mm)	A. Chloroform/methanol (80/20)	Cerebroside, PI, PE, PS, PC, SM, LPC	36	ELSD (Varex ELSDII)	[62]
	B. Chloroform/methanol/water/ammonia (20%) (60/34/6/0.25)				
Silica (Zorbax Rx-SIL, 5 μm, 250 × 4.6 mm)	A. Chloroform/methanol/ammonia (30%) (80/19.5/0.5)	PE, PI, PS, PC, SM	40	ELSD (Sedere Sedex 75)	[60]
	B. Chloroform/methanol/ammonia (30%)/water (60/34/0.5/5.5)				
Silica (Prevail, 3 μm, 150 × 3.2 mm)	A. Chloroform/methanol/buffer (87.5/12/0.5)	GluCer, LacCer, PA, PE, PI, PS, PC, SM, LPC	21	ELSD (Alltech ELSD 2000)	[63]
	B. Chloroform/methanol/buffer (28/60/12)				
	Buffer: water with 1 M formic acid, pH adjusted to 3 with triethylamine				
Silica (Spherisorb, 3 μm, 100 × 5 mm)	A. Isooctane/tetrahydrofurane (99/1)	ceramide monohexoside, ceramide dihexoside, PE, PI, phosphatidyl-dimethylethanol-amine as internal standard, PS, PC, SM	30	ELSD (ACS 750/14)	[47,64]
	B. Isopropanol/chloroform (4/1)				
	C. Isopropanol/water (1/1)				
Polyvinylalcohol-silica (150 × 3 mm)	Quaternary gradient of	PI, PE, PS, PC, SM, LPC	30	ELSD (Polymer labs ELS 1000)	[65]
	A. Dichloromethane				
	B. Isopropanol				

**Table 8.4 (continued) HPLC Methods for the Separation of Polar Lipid Extract of Dairy Samples**

<i>Stationary Phase</i>	<i>Mobile Phase</i>	<i>Reported Polar Lipids in Order of Increasing Retention</i>	<i>Total Run Time (min)</i>	<i>Detector</i>	<i>References</i>
	C. 2,2,4-Trimethylpentane				
	D. Methanol				
	Solvents B, C, and D contain 7.2mM triethylamine and formic acid				

The mentioned solvent ratios are volumetric.

as eluting solvents: PA (95/5, v/v), PE and PS (80/20, v/v), PC and PI (50/50, v/v), and SPH and lysophosphatidylcholine (LPC) (pure methanol) [45]. The fourth method described in Table 8.3 is a reversed-phase method, where polar lipids are eluted first [48]. The collected polar lipid fraction still contains 20%–30% of nonpolar lipid material; however, about 93% of the sample's nonpolar lipid material remains in the column, and the polar lipid recoveries are over 97%, making this method ideally suitable for a quick enrichment of polar lipids prior to the analysis. For a more in-depth review on the fractionation of (polar) lipids, the work of Christie [1] and Vanhoutte et al. [3] can be referred.

## 8.3 Polar Lipid Analysis

### 8.3.1 Total Phospholipid Content

The classical method for measuring the total phospholipid content is by direct determination of phosphorus in the polar lipid extract. The organic phosphorus is first converted to inorganic phosphate by dry ashing or acid digestion, after which, it is further converted to colored complexes, whose intensity is proportional to the concentration of phosphorus. By means of a spectrophotometer, phosphate standard solutions, and proper phosphorus/phospholipid conversion factor (depending on the food matrix), the phospholipid concentration can be determined. The method of Bartlett [49] is generally used for the determination of phosphorus after derivatization into phosphomolybdate complexes. Christie [1] proposed a method, based on the method of Bartlett, which can be used for phosphorus determination in oils or food extracts, and which uses reagents that can be stored for more than 1 month. For the analysis of total phospholipid content in dairy products, the method proposed by Hundrieser et al. [50] or its modification proposed by Ulberth [51] is recommended.

More advanced techniques like atomic absorption spectroscopy (AAS) [52], inductively coupled plasma-optical emission spectroscopy (ICP-OES) [53], and Fourier-transformed infrared spectroscopy [54,55] can be used for the determination of total phosphorus in oils or food extracts. The main advantages of these methods when compared with the classical spectrophotometric

methods are the time of analysis, the accuracy, the sensitivity, and the less use of chemicals. However, expensive equipment is necessary to carry out these methods.

The dairy products contain large amounts of inorganic and organic phosphorous, mainly in the casein fraction, and not in the phospholipid fraction. During the extraction of milk polar lipids, traces of milk proteins can be coextracted, resulting in a serious overestimation of the total phospholipids in the extract. Therefore, the extraction solvents should be washed thoroughly, or the extracts should be fractionated prior to analysis. The methods for the total phospholipid determination do not give any information about the individual phospholipids. GluCer and LacCer, the two sphingolipids which can count up to 10% of the polar lipid fraction in the dairy products, do not contain phosphorous, and hence, may not be analyzed when measuring the total phospholipids. Therefore, the above-mentioned methods for total phospholipid determination are less applicable to dairy products, but can give valuable information when used correctly.

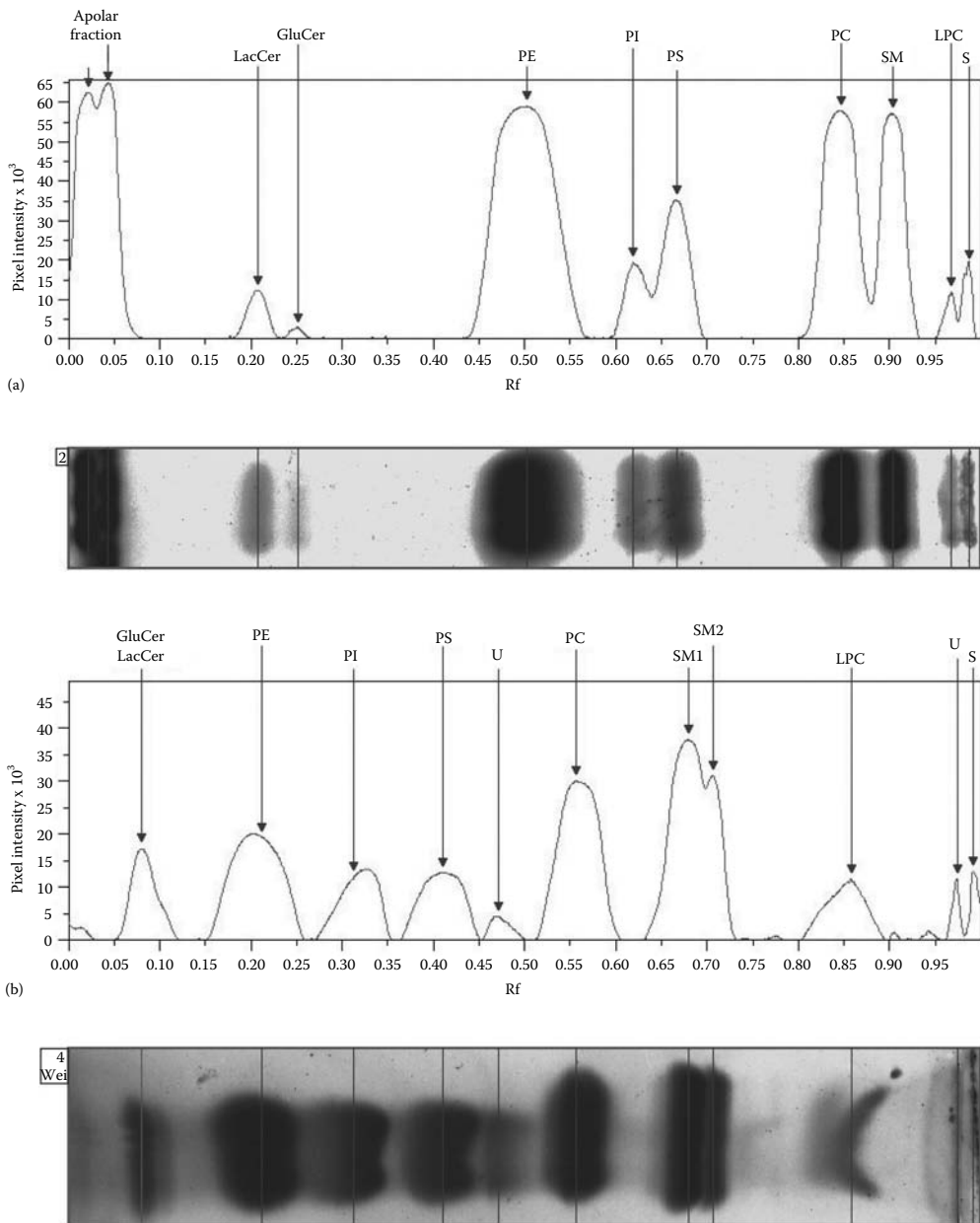
### **8.3.2 Total Sphingolipid Content**

Merrill et al. [56] developed a method for the quantification of free sphingosine in liver, which was adopted by Ahn and Schroeder [57] to measure the total sphingolipids in dairy products (i.e., SM, cerebroside, ganglioside, sphingosine, and ceramide). After extraction, the extract was hydrolyzed by acid, which freed the sphingosine. This was further converted into *o*-phthalaldehyde derivatives that were consecutively analyzed by HPLC on a C18-column. The results observed were in line with other researches.

### **8.3.3 Thin-Layer Chromatography**

Although an old technique, thin-layer chromatography (TLC) is still often used, as it is cheap, quick, easy-to-use, versatile, and rather inexpensive when compared with other methods. For this technique, all types of mobile phases can be used in multiple dimensions, even those that are not compatible with HPLC. Several specific staining sprays exist, which allow the identification of unknown complex lipids. If a nondestructive visualization spray is used, then the bands can be scraped off, and can be used for further analysis. As such, in the case of a polar lipid mixture, highly detailed information about the individual polar lipids can be obtained. The plates can be scanned and analyzed with specific software, which can give, after standardization and calibration, a quantitative result. For quantification purposes by densitometric scanning, the method should however be scrupulously validated and standardized, because the staining intensity is time- and matrix-dependent, and saturation can occur very quickly, depending on the polar lipid species. Therefore, TLC is principally used for the qualitative and semiquantitative purposes. For a more general overview of TLC separation methods and selective spraying reagents, the work of Christie [1] and Vanhoutte et al. [3] can be referred.

The method published by Leray et al. [58] was found to be highly convenient for the separation of polar lipids of dairy origin. In this method, the polar lipids are separated on a plain polar silica plate with chloroform/ethanol/water/triethylamine (30/35/7/35, vol.). Only one development step is necessary to separate most of the polar lipid species, while most other methods use multiple running steps with different classes of solvents. As such, this decreases the analysis time tremendously, when compared with other methods. Rombaut [59] proposed a modification of the relative solvent composition of the above-mentioned method to increase the resolution. The result of this is shown in Figure 8.3. In this method, the apolar fraction (mono-, di-, and triglycerides, cholesterol, and



**Figure 8.3** Thin-layer chromatogram of acid buttermilk whey polar lipid extract. Bands were visualized with ammonium molybdate and copper sulfate in sulfuric acid. U, unknown and S, original spot. Individual bands from each lane were identified by comparison with a standard mixture, and the identity of GluCer, LacCer, and PI were cross-checked with a carbohydrate-specific visualization reagent (0.2% orcinol in concentrated sulfuric acid). (a) Developed with chloroform/ethanol/water/triethylamine (30:35:7:35, vol), as described by Leray et al. [58]. (b) Developed with chloroform/ethanol/water/triethylamine (40:50:10:35, vol), as proposed by Rombaut [59]. (From Rombaut, R., Enrichment of nutritionally advantageous milk fat globule membrane fragments present in dairy effluents, PhD dissertation, Ghent University, Gent, 2006. With permission.)

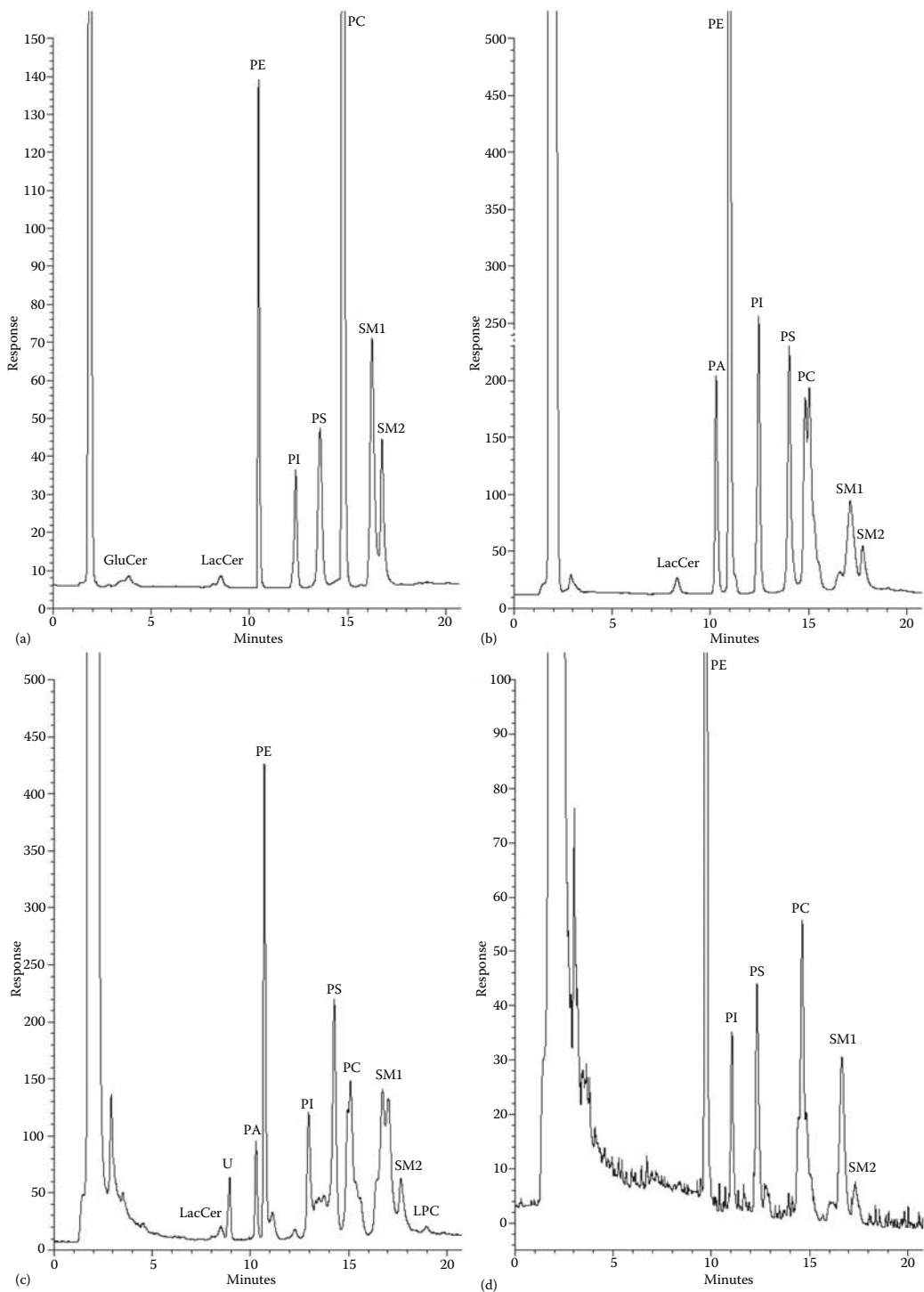
free fatty acids) completely migrates toward the end of the plate, and GluCer, LacCer, PE, PS, PI, PC, and SM are completely resolved.

### **8.3.4 High-Performance Liquid Chromatography**

#### **8.3.4.1 Separation of Polar Lipid Classes**

The principle of HPLC is quite similar to that of TLC, but HPLC outperforms TLC on its separation power (resolution), accuracy, and precision. For the analysis of polar lipids, the extract is separated on a polar column (mostly silica or diol-modified silica) using a mobile phase with increasing polarity gradient. Each peak represents a single polar lipid class, however, representing numerous molecules with different fatty-acid residues. If a nondestructive detector is used or a split is mounted between the column and the detector, then these polar lipid classes can be collected and separated individually on an apolar column (typically C18-modified silica) to resolve the individual polar lipid species according to their fatty-acid composition. The latter technique is however beyond the scope of this work, and has been reviewed by Christie [1].

Numerous HPLC methods have been published for the separation of lecithin samples. However, they contain neither sphingolipids nor PS, and are therefore, less applicable to dairy products. On the other hand, methods developed for the separation of extracts of animal or human tissue can be possibly adapted to dairy sample extracts, as polar lipid classes in both the product groups are quite similar. In Table 8.4, the HPLC methods for the separation of dairy polar lipid extracts are given. Most of these methods use a plain silica column and a binary gradient of chloroform/methanol/water/ammonia as mobile phase [60–62]. Although this solvent system produces an excellent separation of all the polar lipid classes, the presence of ammonia results in a rapid decrease in the separation power upon consecutive injection of samples, as silica is soluble in aqueous environments at a  $\text{pH} > 7$ , and the column is destroyed. A modification of this method was published by Rombaut et al. [63]. In their method, a gradient of chloroform, methanol, and an aqueous formic acid–triethylamine buffer at  $\text{pH} 3$  is used. GluCer, LacCer, PE, PI, PS, PC, and SM were completely separated in less than 21 min, including column regeneration, while column life was extended to over 1500 runs. Even difficult matrices like butter polar lipids were separated acceptably, without any fractionation or purification step, prior to injection. This is illustrated in Figure 8.4, where chromatograms of a standard mixture and four different dairy products are given. Christie et al. [47,64] proposed a ternary gradient of isooctane, tetrahydrofuran, isopropanol, chloroform, and water for the separation of milk polar lipids. In their technique, synthetic dipalmitoyl PE was used as an internal standard. Although separation of all the polar lipids was obtained in less than 20 min, the complex ternary gradient required advanced equipment and premixing of all the solvents. This method was easily adapted to other matrices like rat liver, heart, plasma, and erythrocytes [64]. Fagan and Wijesundera [65] proposed a method in which simple lipids were removed online prior to analysis: the polar lipids were first concentrated on a guard column, and by means of a dual injection system, were further separated on an analytical column. They used a complex gradient of dichloromethane, isopropanol, 2,2,4-trimethylpentane, and methanol. All the solvents, except dichloromethane, contained 7.2 mM triethylamine and formic acid in combination with a polyvinylalcohol column (PVA-SIL). This type of column has a uniform surface of hydroxyl groups derived from polymerized vinyl alcohol, which allows constant phase activity with apolar and polar solvents. As such, this column may certainly replace unbonded silica or diol-modified columns to a certain extent, as new methods are further developed.



**Figure 8.4** HPLC chromatograms using ELSD of (a) polar lipid standards, (b) acid whey, (c) Gouda cheese, and (d) Butter. U, unknown. (From Rombaut, R. et al., *J. Dairy Sci.*, 88, 482, 2005. With permission.)

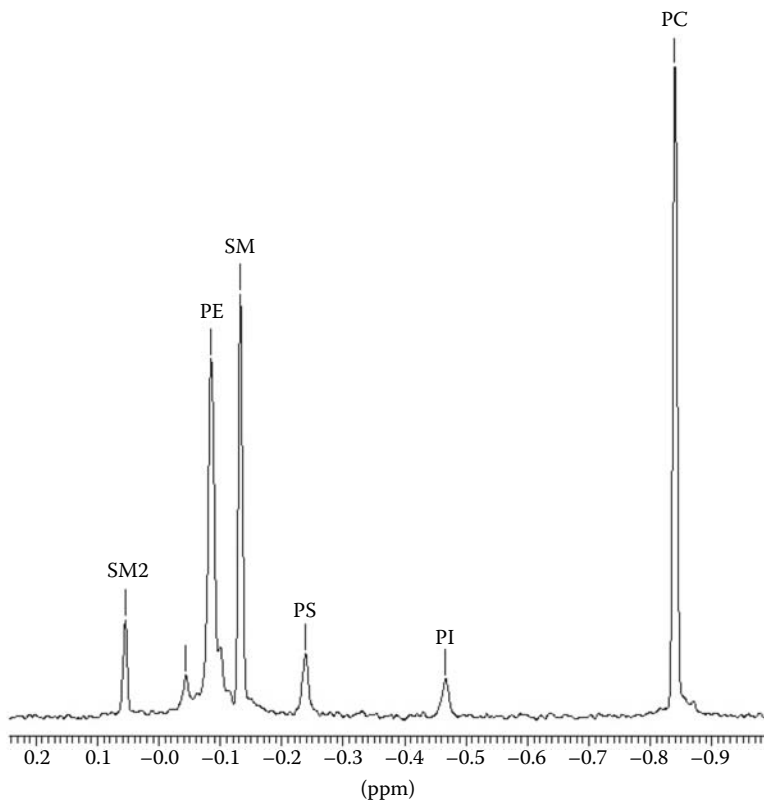
### 8.3.4.2 HPLC Detectors for Polar Lipid Analysis

The evaporative light-scattering detector (ELSD) has gradually replaced the ultraviolet (UV), fluorescence, and refractive index (RI) detectors in the analysis of (polar) lipids [66]. The UV and fluorescence detectors are highly dependent on the unsaturation and oxidation degree of the fatty-acid moieties of each polar lipid class. Therefore, its response can vary widely, and extensive calibration with identical standard material as the polar lipid extract is indispensable. Moreover, only a limited number of solvent systems are compatible with the UV detector, as they should be UV-transparent. Similarly, RI detection is not advisable, as it is not compatible with gradient elution, and not very sensitive; hence, a preconcentration step of the extract is necessary. With ELS detection, the mobile phase and analyte is atomized in a heated tube, where the solvent evaporates, and the analyte droplets that must be less volatile than the mobile phase, scatter a laser beam mounted at the end of the tube. This scattering is converted to a signal by a photomultiplier, and is primarily dependent on the mass of the analyte. This system offers many advantages: it is compatible with a broad range of solvents, has a stable baseline even with gradient elution, and if the working conditions (i.e., nebulizer gas flow and temperature) are maintained, highly reproducible results can be obtained. A drawback of the ELSD is that its response is sigmoidal in function of the injected concentration [67]. However, a broad linear working range can be defined [63]. Although the ELSD is believed to be a uniform mass-sensitive detector, the response of each polar lipid class still differs; hence, it is necessary to set up calibration curves for each polar lipid. Rombaut et al. investigated the dependency of the ELSD output on nebulizer gas flow and temperature by means of a response-surface experimental design [63]. For all the polar lipid classes, the response was highly dependent on the flow of the nebulizer gas, decreasing sharply with the increasing flow. As such, the optimal nebulization gas flow was found at 1.4 L/min. The effect of temperature was less pronounced and varied on the type of polar lipid, but was nevertheless, significant for all the polar lipids investigated [63]. The principle and applications of the ELSD are extensively discussed elsewhere [66,68,69].

Recently, a new type of HPLC mass-sensitive detector, a charged aerosol detector (CAD), was developed. In this technique, the effluent from the column is nebulized, the aerosol particles are charged, and the current from the charged aerosol flux is measured. When compared with the ELSD, this detector is claimed to be more sensitive, produces more uniform response, and has a higher reproductive results. However, the initial results on polar lipid analysis did not show a spectacular improvement when compared with the latest ELSD models [70].

### 8.3.5 <sup>31</sup>P Phosphorous Nuclear Magnetic Resonance

Nowadays, <sup>31</sup>P phosphorous nuclear magnetic resonance (<sup>31</sup>P-NMR) is gaining popularity for absolute quantification of phospholipids in food matrices like dairy products, as it has many advantages when compared with other methods. Sample preparation is limited, as nonphosphorous contaminants are not detected. No physical separation of the sample is performed, because the chemical shift of the phosphorous atom is dependent on its molecular environment, and unique shifts are obtained for each phospholipid class. Furthermore, the peak areas are directly proportional to the phosphorous concentration, making <sup>31</sup>P-NMR an absolute technique [71–73]. In Figure 8.5, a <sup>31</sup>P-NMR spectrum of milk phospholipids is given. In the last decade, more powerful machines and analysis software have been introduced, thereby strongly increasing the resolution power, even in such a way that a phospholipid class can be split up into saturated/saturated, saturated/unsaturated, and unsaturated/unsaturated peaks. However, the disadvantages



**Figure 8.5**  $^{31}\text{P}$ -NMR spectrum of milk phospholipids on a Bruker 300 MHz Avance 1 spectrometer equipped with a BBI probe. Milk phospholipid extract was redissolved in  $\text{CDCl}_3/\text{MeOH}/\text{aqueous Cs-EDTA 1 mM, pH 8 (1/1/1)}$ . (Courtesy of Dr. Bernd Diehl, Spectral Service, Cologne, Germany. With permission.)

of this technique are the high investment cost, the need of skilled operators, and the restriction to phosphorous-containing lipids. Therefore, to our opinion, this technique will rather remain a method for research and reference validation and certification, rather than a routine analysis method for quality control purposes.

## Abbreviations

ELSD	evaporative light-scattering detector
GluCer	glucosylceramide
HPLC	high-performance liquid chromatography
LacCer	lactosylceramide
LPC	lysophosphatidylcholine
MFGM	milk fat globule membrane
NMR	nuclear magnetic resonance
PA	phosphatidic acid



PC	phosphatidylcholine
PE	phosphatidylethanolamine
PI	phosphatidylinositol
PS	phosphatidylserine
SM	sphingomyelin
SCO <sub>2</sub>	supercritical carbon dioxide
TLC	thin-layer chromatography

## References

- Christie, W. W., *Lipid Analysis. Isolation, Separation, Identification and Structural Analysis of Lipids*, 3rd edn., PJ Barnes & Associates, Bridgwater, England, 2003.
- Newburg, D. S. and Chaturvedi, P., Neutral glycolipids of human and bovine-milk, *Lipids*, 27, 923, 1992.
- Vanhoutte, B., Rombaut, R., Van Der Meeren, P., and Dewettinck, K., Phospholipids, in *Handbook of Food Analysis*, 2nd edn., Nollet, L. M. L., Ed., Marcel Dekker, New York, 2004, Chapter 12.
- Vesper, H., Schmelz, E. M., Nikolova-Karakashian, M. N., Dillehay, D. L., Lynch, D. V., and Merrill, A. H., Sphingolipids in food and the emerging importance of sphingolipids to nutrition, *J. Nutr.*, 129, 1239, 1999.
- Rombaut, R. and Dewettinck, K., Properties, analysis and purification of milk polar lipids, *Int. Dairy J.*, 16, 1362, 2006.
- Bitman, J. and Wood, D. L., Changes in milk-fat phospholipids during lactation, *J. Dairy Sci.*, 73, 1208, 1990.
- Cinque, B., Di Marzio, L., Centi, C., Di Rocco, C., Riccardi, C., and Cifone, M. G., Sphingolipids and the immune system, *Pharmacol. Res.*, 47, 421, 2003.
- Colombaioni, L. and Garcia-Gil, M., Sphingolipid metabolites in neural signalling and function, *Brain Res. Rev.*, 46, 328, 2004.
- Deguchi, H., Yegneswaran, S., and Griffin, J. H., Sphingolipids as bioactive regulators of thrombin generation, *J. Biol. Chem.*, 279, 12036, 2004.
- Pettus, B. J., Chalfant, C. E., and Hannun, Y. A., Sphingolipids in inflammation: Roles and implications, *Curr. Mol. Med.*, 4, 405, 2004.
- Lemonnier, L. A., Dillehay, D. L., Vespremi, M. J., Abrams, J., Brody, E., and Schmelz, E. M., Sphingomyelin in the suppression of colon tumors: Prevention versus intervention, *Arch. Biochem. Biophys.*, 419, 129, 2003.
- Schmelz, E. M., Dillehay, D. L., Webb, S. K., Reiter, A., Adams, J., and Merrill, A. H., Sphingomyelin consumption suppresses aberrant colonic crypt foci and increases the proportion of adenomas versus adenocarcinomas in CF1 mice treated with 1,2-dimethylhydrazine: Implications for dietary sphingolipids and colon carcinogenesis, *Cancer Res.*, 56, 4936, 1996.
- Eckhardt, E. R. M., Wang, D. Q. H., Donovan, J. M., and Carey, M. C., Dietary sphingomyelin suppresses intestinal cholesterol absorption by decreasing thermodynamic activity of cholesterol monomers, *Gastroenterology*, 122, 948, 2002.
- Noh, S. K. and Koo, S. I., Egg sphingomyelin lowers the lymphatic absorption of cholesterol and alpha-tocopherol in rats, *J. Nutr.*, 133, 3571, 2003.
- Noh, S. K. and Koo, S. I., Milk sphingomyelin is more effective than egg sphingomyelin in inhibiting intestinal absorption of cholesterol and fat in rats, *J. Nutr.*, 134, 2611, 2004.
- Pepeu, G., Pepeu, I. M., and Amaducci, L., A review of phosphatidylserine pharmacological and clinical effects. Is phosphatidylserine a drug for the ageing brain? *Pharmacol. Res.*, 33, 73, 1996.
- Kidd, P. M., Phospholipids: Versatile nutraceutical ingredients for functional foods, *Funct. Foods Nutraceut.*, 12, 30, 2002.

18. Blusztajn, J. K., Developmental neuroscience—Choline, a vital amine, *Science*, 281, 794, 1998.
19. Danthine, S., Blecker, C., Paquot, M., Innocente, N., and Deroanne, C., Progress in milk fat globule membrane research: A review, *Lait*, 80, 209, 2000.
20. Walstra, P., Wouters, J. T. M., and Geurts, T. J., *Dairy Science and Technology*, 2nd edn., CRC Press, Boca Raton, FL, 2006.
21. Keenan, T. W., Mather, I. H., and Dylewski, D. P., Physical equilibria: The lipid phase, in *Fundamentals of Dairy Chemistry*, Wong, N. P., Ed., Aspen Publishers Inc., Gaithersburg, MD, 1999, Chapter 10.
22. Evers, J. M., The milkfat globule membrane—Compositional and structural changes post secretion by the mammary secretory cell, *Int. Dairy J.*, 14, 661, 2004.
23. Corredig, M. and Dalgleish, D. G., Isolates from industrial buttermilk: Emulsifying properties of materials derived from the milk fat globule membrane, *J. Agric. Food Chem.*, 45, 4595, 1997.
24. Michalski, M. C., Michel, F., Sainmont, D., and Briard, V., Apparent zeta-potential as a tool to assess mechanical damages to the milk fat globule membrane, *Colloids Surf. B*, 23, 23, 2002.
25. Rombaut, R., Van Camp, J. V., and Dewettinck, K., Phospho- and sphingolipid distribution during processing of milk, butter and whey, *Int. J. Food Sci. Technol.*, 41, 435, 2006.
26. Laegreid, A., Otnaess, A. B. K., and Fuglesang, J., Human and bovine milk—Comparison of ganglioside composition and enterotoxin-inhibitory activity, *Pediatr. Res.*, 20, 416, 1986.
27. Pan, X. L. and Izumi, T., Variation of the ganglioside compositions of human milk, cow's milk and infant formulas, *Early Hum. Dev.*, 57, 25, 2000.
28. Jensen, R. G., The composition of bovine milk lipids: January 1995 to December 2000, *J. Dairy Sci.*, 85, 295, 2002.
29. Rueda, R., Maldonado, J., Narbona, E., and Gil, A., Neonatal dietary gangliosides, *Early Hum. Dev.*, 53, S135–S147, 1998.
30. Rombaut, R., Dewettinck, K., and Van Camp, J., Phospho- and sphingolipid content of selected dairy products as determined by HPLC coupled to an evaporative light scattering detector (HPLC–ELSD), *J. Food Compos. Anal.*, 20, 308, 2007.
31. Wolff, R. L. and Casterarossignol, A. F. M., Evaluation of a new method for the extraction of fat from Emmentaler type cheese, *Rev. Fr. Corps Gras*, 34, 123, 1987.
32. Folch, J., Lees, M., and Stanley, H. S., A simple method for the isolation and purification of total lipids from animal tissues, *J. Biol. Chem.*, 226, 497, 1956.
33. Bligh, E. G. and Dyer, W. J., A rapid method of total lipid extraction and purification, *Can. J. Biochem. Phys.*, 37, 911, 1959.
34. Hara, A. and Radin, N. S., Lipid extraction of tissues with a low-toxicity solvent, *Anal. Biochem.*, 90, 420, 1978.
35. Vaghela, M. N. and Kilara, A., A rapid method for extraction of total lipids from whey-protein concentrates and separation of lipid classes with solid-phase extraction, *J. Am. Oil Chem. Soc.*, 72, 1117, 1995.
36. Theodet, C. and Gandemer, G., Comparison of 5 methods for lipid extraction from whey and its by-products, *Lait*, 71, 41, 1991.
37. Clark, R. M., Ferris, A. M., Fey, M., Brown, P. B., Hundrieser, K. E., and Jensen, R. G., Changes in the lipids of human-milk from 2 to 16 weeks postpartum, *J. Pediatr. Gastr. Nutr.*, 1, 311, 1982.
38. Richardson, R. K., Determination of fat in dairy products using pressurized solvent extraction, *J. AOAC Int.*, 84, 1522, 2001.
39. Mendes, R. L., Reis, A. D., and Palavra, A. F., Supercritical CO<sub>2</sub> extraction of gamma-linolenic acid and other lipids from *Arthrospira (Spirulina) maxima*: Comparison with organic solvent extraction, *Food Chem.*, 99, 57, 2006.
40. Montanari, L., King, J. W., List, G. R., and RENNICK, K. A., Selective extraction of phospholipid mixtures by supercritical carbon dioxide and cosolvents, *J. Food Sci.*, 61, 1230–1233, 1996.
41. Montanari, L., Fantozzi, P., Snyder, J. M., and King, J. W., Selective extraction of phospholipids from soybeans with supercritical carbon dioxide and ethanol, *J. Supercrit. Fluid*, 14, 87, 1999.

42. Astaire, J. C., Ward, R., German, J. B., and Jimenez-Flores, R., Concentration of polar MFGM lipids from buttermilk by microfiltration and supercritical fluid extraction, *J. Dairy Sci.*, 86, 2297, 2003.
43. Galanos, G. and Kapoulas, V., Isolation of polar lipids from triglyceride mixtures, *J. Lipid Res.*, 3, 134, 1962.
44. Hartman, L., Comparison of two methods for the separation of polar from nonpolar lipids, *J. Lipid Res.*, 8, 285, 1967.
45. Christie, W. W., Chromatographic analysis of phospholipids, *Z. Lebensm. Unters. Forsch.*, 181, 171, 1985.
46. Baummy, J. J., Gestin, L., Fauquant, J., Boyaval, E., and Maubois, J. L., Technologies de purification des phospholipides du lactosérum, *Process*, 1047, 29, 1990.
47. Christie, W. W., Noble, R. C., and Davies, G., Phospholipids in milk and dairy products, *J. Soc. Dairy Technol.*, 40, 10, 1987.
48. Caboni, M. F., Menotta, S., and Lercker, G., Separation and analysis of phospholipids in different foods with a light-scattering detector, *J. Am. Oil Chem. Soc.*, 73, 1561, 1996.
49. Bartlett, G. R., Phosphorus assay in column chromatography, *J. Biol. Chem.*, 234, 466, 1959.
50. Hundrieser, K. E., Clark, R. M., and Jensen, R. G., Total phospholipid analysis in human milk without acid digestion, *Am. J. Clin. Nutr.*, 41, 988, 1985.
51. Ulberth, F., A simple and rapid method for the quantification of phospholipids in skim milk butter-milk powder, *Z. Lebensm. Unters. Forsch.*, 190, 432, 1990.
52. Hendrikse, P. W. and Dieffenbacher, A., Determination of phosphorus in oils and fats by direct graphite-furnace atomic-absorption spectrometry—Results of a collaborative study and the standardized method, *Pure Appl. Chem.*, 63, 1192, 1991.
53. Benzo, Z., Murillo, M., Marcano, E., Gomez, C., Garaboto, A., and Espinoza, A., Determination of phosphorus in edible oils by inductively coupled plasma-atomic emission spectrometry and oil-in-water emulsion of sample introduction, *J. Am. Oil Chem. Soc.*, 77, 997, 2000.
54. Nzai, J. M. and Proctor, A., Determination of phospholipids in vegetable oil by Fourier transform infrared spectroscopy, *J. Am. Oil Chem. Soc.*, 75, 1281, 1998.
55. Nzai, J. M. and Proctor, A., Soy lecithin phospholipid determination by Fourier transform infrared spectroscopy and the acid digest arseno-molybdate method: A comparative study, *J. Am. Oil Chem. Soc.*, 76, 61, 1999.
56. Merrill, A. H., Wang, E., Mullins, R. E., Jamison, W. C. L., Nimkar, S., and Liotta, D. C., Quantitation of free sphingosine in liver by high-performance liquid-chromatography, *Anal. Biochem.*, 171, 373, 1988.
57. Ahn, E. H. and Schroeder, J. J., Bioactive sphingolipids are constituents of soy and dairy products, *J. Food Sci.*, 67, 522, 2002.
58. Leray, C., Pelletier, X., Hemmendinger, S., and Cazenave, J. P., Thin-layer chromatography of human-platelet phospholipids with fatty-acid analysis, *J. Chromatogr. B*, 420, 411, 1987.
59. Rombaut, R., Enrichment of nutritionally advantageous milk fat globule membrane fragments present in dairy effluents, PhD dissertation, Ghent University, Gent, Belgium, 2006.
60. Avalli, A. and Contarini, G., Determination of phospholipids in dairy products by SPE/HPLU/ELSD, *J. Chromatogr. A*, 1071, 185, 2005.
61. Surel, O., Ducruet, V., Famelart, M. H., and Lamberet, G., Quantification of lipids in low fat content dairy-products with light-scattering detector, *Analysis*, 23, 31, 1995.
62. Vaghela, M. N. and Kilara, A., Quantitative analysis of phospholipids from whey protein concentrates by high performance liquid chromatography with a narrow-bore column and an evaporative light scattering detector, *J. Am. Oil Chem. Soc.*, 72, 729, 1995.
63. Rombaut, R., Camp, J. V., and Dewettinck, K., Analysis of phospho- and sphingolipids in dairy products by a new HPLC method, *J. Dairy Sci.*, 88, 482, 2005.
64. Christie, W. W., Rapid separation and quantification of lipid classes by high performance liquid chromatography and mass (light-scattering) detection, *J. Lipid Res.*, 26, 507, 1985.

65. Fagan, P. and Wijesundera, C., Liquid chromatographic analysis of milk phospholipids with on-line pre-concentration, *J. Chromatogr. A*, 1054, 241, 2004.
66. Christie, W. W., Detectors for high performance liquid chromatography of lipids with special reference to evaporative light-scattering detection, in *Advances in Lipid Methodology-One*, Christie, W. W., Ed., The Oily Press, Ayr, U.K., 239–271, 1992.
67. Vandermeeren, P., Vanderdeelen, J., and Baert, L., Simulation of the mass response of the evaporative light-scattering detector, *Anal. Chem.*, 64, 1056, 1992.
68. Koropchak, J. A., Magnusson, L. E., Heybroek, M., Sadain, S., Yang, X. H., and Anisimov, M. P., Fundamental aspects of aerosol-based light-scattering detectors for separations, *Adv Chromatogr.*, 40, 275, 2000.
69. Onken, J. and Berger, R. G., Evaporative light scattering detector (ELSD) for the analysis in food chemistry, *Dtsch. Lebensmitt. Rundsch.*, 94, 287, 1998.
70. Moreau, R. A., The analysis of lipids via HPLC with a charged aerosol detector, *Lipids*, 41, 727, 2006.
71. Glonek, T., P-31 nuclear magnetic resonance phospholipid analysis of anionic-enriched lecithins, *J. Am. Oil Chem. Soc.*, 75, 569, 1998.
72. Meneses, P. and Glonek, T., High-resolution P-31 NMR of extracted phospholipids, *J. Lipid Res.*, 29, 679, 1988.
73. Murgia, S., Mele, S., and Monduzzi, M., Quantitative characterization of phospholipids in milk fat via P-31 NMR using a monophasic solvent mixture, *Lipids*, 38, 585, 2003.
74. Bitman, J., Wood, D. L., Hamosh, M., Hamosh, P., and Mehta, N. R., Comparison of the lipid composition of breast milk from mothers of term and preterm infants, *Am. J. Clin. Nutr.*, 38, 300, 1983.



## Chapter 9

---

# Fatty Acids

---

Miguel Angel de la Fuente and Manuela Juárez

### CONTENTS

9.1	Introduction.....	211
9.2	Preparation of Fatty Acid Derivatives.....	212
9.3	Gas Chromatographic Analysis of Fatty Acids .....	213
9.4	Isolation and Fractionation of Fatty Acids.....	217
9.5	Silver Ion HPLC of CLA.....	219
9.6	Determination of Free Fatty Acids .....	221
9.7	Identification of Fatty Acid Structure.....	222
9.8	Final Remarks.....	225
	References.....	225

### 9.1 Introduction

Few biological lipids surpass dairy fat in the complexity of their fatty acid (FA) composition. Milk fat is regarded as one of the most complex naturally occurring fats and oils, because of the large number of FAs and the variety of molecular structures they encompass. Using a combination of chromatographic and spectroscopic techniques, researchers have identified approximately 400 FAs in milk fat. Jensen [1] compiled a listing of various types of FAs. The vast majority of these acids are present in extremely small quantities (<0.01% of the total FAs). However, there are about 14 FAs that are at or above concentrations of 1.0% in ruminants. Most of the FAs (>95%) are esterified in glycerides, mainly triacylglycerols (TAGs), with very minor amounts present in the phospholipids or in free form (free fatty acids, FFAs).

Milk FA composition affects flavor, nutritional properties, and physical functionality and consequently influences the suitability of milk for food applications. The FA profile of milk fat can

readily be altered through animal nutrition, genetic selection, and variations in seasonal factors. The most important factors influencing milk fat composition are feed and farm practices along with certain postfarm treatments, such as fractionation.

The saturated FAs present in significant quantities in milk fat are molecules consisting of unbranched hydrocarbon chains varying in length from 4 to 20 carbon atoms. These FAs account for approximately 60%–75% of the total. Quantitatively, the most important saturated FA is 16:0, which accounts for about 20%–30% of the total, while two other FAs, 14:0 and 18:0, reach values in the region of 10%–15%. Short-chain FAs (4:0 to 8:0) and, to a lesser extent, medium-chain FAs (10:0 to 12:0) lower the melting points of TAGs, and hence their presence helps keep milk fat liquid at physiological temperatures. Among the minor saturated FAs are branched-chain and odd-numbered carbon FAs. Monomethyl branched-chain FAs can be quite plentiful, making up about 2.5% of the total FAs, principally in goat's milk fat.

The *cis*-monoenoic acid content of ruminant milk is about 20%–25%. Oleic acid (*cis*-9 18:1) is the main acid of such type, making up around 20% of the total, while the proportions of the other *cis*-18:1 isomers are lower. There are also relatively small but significant contributions from other *cis*-monounsaturated acids, namely 10:1, 12:1, 14:1, 16:1, and 17:1 (less than 2%). *Cis*-polyenoic acids comprise linoleic acid (*cis*-9 *cis*-12 18:2) and  $\alpha$ -linolenic acid (*cis*-9 *cis*-12 *cis*-15 18:3) almost exclusively, the former in a proportion of about 2% and the latter in a proportion of about 0.5%. The concentration of *trans*-18:1 varies considerably, from about 1% to 6%, well below the level present in hydrogenated fats. Vaccenic acid (VA, *trans*-11 18:1) is the most important *trans* isomer, accounting for about 60% of the total *trans* C18:1. Precht and Molkentin [2] identified a number of *trans*-octadecadienoic acids in milk fat that contained one or two *trans* double bonds. Most of these acids are present in small amounts, less than 1%, with *trans*-11 *cis*-15 and *cis*-9 *trans*-11 exhibiting considerable variations in mean concentration. The *cis*-9 *trans*-11 isomer is the principal conjugated linoleic acid (CLA) and makes up about 70%–90% of the total CLA. The generic name CLA is a collective term including all octadecadienoic acids (18:2) having a conjugated double-bond system in the 7–9, 8–10, 9–11, 10–12, 11–13, 12–14, and 13–15 positions and a *cis*–*cis*, *cis*–*trans*, *trans*–*cis*, or *trans*–*trans* geometric configuration. These FAs, mainly *cis*-9 *trans*-11, are of particular interest because of their influence on human health, and dairy products are the richest common source of CLA in foodstuffs.

Because it is so complex, analysis of milk FAs is a challenging task and one of the most important analytical fields for scientists working on the physiological aspects of milk fat production and modification. No single method is currently capable of resolving all the FAs in dairy products. There is a long-standing tradition of using gas chromatography (GC) as an analytical method to assess the adulteration of milk fat based on the composition of the major FAs [3,4]. In the past 15 years, however, the analysis of minor FAs in ruminant milk has taken on new importance, because of their nutritional significance. This chapter describes the most frequently used methods for analyzing these compounds in milk and dairy products. The key steps in elucidating the FA profile of milk are forming derivatives and then separating the FAs using chromatography. Identification of the molecular structure of the FAs by mass spectrometry (MS) has been gaining importance in recent years.

## 9.2 Preparation of Fatty Acid Derivatives

Conventional analysis of lipid FAs has entailed derivatization to form less polar and more volatile compounds. Preparation of volatile derivatives is often a preliminary step carried out before analyzing the FA profile using GC. The most widely employed procedure involves converting the

FAs into methyl esters (fatty acid methyl esters, FAMES). Dairy lipid methylation can be carried out in either an acidic or a basic medium. Acid-catalyzed methylation ( $\text{BF}_3$ ,  $\text{HCl}$ , or  $\text{H}_2\text{SO}_4$  in methanol) converts all the known FA classes present in glycerides, phospholipids, and FFAs into FAMES.  $\text{BF}_3$  in methanol has commonly been used as a transesterification catalyst, in particular as a means of quickly esterifying dairy products rich in FFAs [5]. However, this reagent has a limited shelf life, even when refrigerated, and using old or too highly concentrated solutions often results in artifacts and appreciable losses of polyunsaturated fatty acids (PUFAs). Furthermore, as a rule, acid-catalyzed methods result in extensive isomerization of conjugated dienes and thus yield allylic methoxy artifacts [6] that may interfere with chromatographic analysis. Moreover, increasing the temperature or incubation time during methylation produces more artifacts [7].

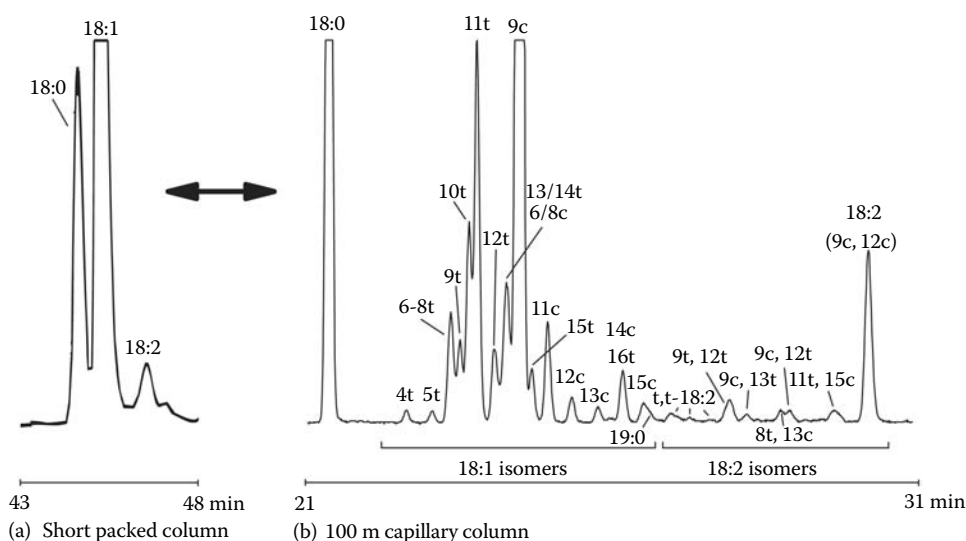
Base-catalyzed methylation methods using  $\text{NaOCH}_3$  or  $\text{KOH}$  in methanol at room temperature are considered most reliable for determining the FA profile of milk fat. FAs from glycerides are very quickly transesterified in anhydrous methanol in the presence of a base catalyst. Additionally, these reagents cause no isomerization and produce no methoxy artifacts [5]. Nevertheless, phospholipids and FFAs are not normally esterified, and care must be taken to exclude water from the reaction medium. An aqueous medium may contribute to hydrolysis of the TAGs, thus preventing FAME formation. International Standard ISO 15884-IDF 182:2002 [8] specifies a method for preparing FAMES by base-catalyzed methanolysis of the glycerides in dairy fat based on the procedure of Christopherson and Glass [9]. After reaction, the mixture is neutralized by adding crystalline  $\text{NaHSO}_4$  to avoid saponification of the preformed esters. The method is not suitable for analyzing partially lipolyzed fat (>1 mmol FFA/100 g fat). For such cases, the standard includes an Annex that sets out an alternative procedure based on acid-catalyzed transesterification employing  $\text{H}_2\text{SO}_4$  in methanol as catalyst in mild conditions.

Quantitative difficulties may arise when preparing FAMES from the great variety of FA classes present in dairy products. Because short-chain FAMES are highly volatile, quantitative recovery of these FAMES from the reaction medium can be difficult. In addition, short-chain and some medium-chain FAMES require correction factors, because they do not have any quantitative flame ionization detector (FID) response. For all these reasons, longer-chain alcohols have been used as an alternative to form such derivatives as FA isopropyl and butyl esters [5,10,11]. Substituting the methyl group with an ethyl, propyl, or butyl group can progressively improve the flame ionization efficiency of the FA esters [12]. Wolff [13] demonstrated that esters of C3-alcohols have conversion factors close to 1, independently of acid chain length, and hence that there was no need to apply correction factors to transform percentage peak area into FA percentage weight when butyl or propyl esters were used. Furthermore, short-chain FA isopropyl esters, less volatile than FAMES, were readily separated from the solvent front by GC.

### 9.3 Gas Chromatographic Analysis of Fatty Acids

GC is by far the most commonly used method of analyzing milk fat FAs. GC has gained widespread favor due to its versatility, high sensitivity, and relatively low cost. GC combined with an FID is routinely employed to quantify derivatized FAs from dairy fat. Column selectivity and separation efficiency have increased markedly in recent years with the advent of wall-coated open tubular (WCOT) capillary columns, which have in many cases made the original packed GC columns obsolete (Figure 9.1). International Standard ISO 15855-IDF 184:2002 [14] describes a procedure for determining the FA composition of milk fat and fats obtained from dairy products based on the separation and determination of FAMES by capillary gas liquid chromatography.





**Figure 9.1** Partial gas–liquid chromatograms of FAMES derived from a bovine milk sample on different column types. (a) Packed column: 2 m, 15% DEGS; initial temperature 50°C; temperature was raised at 4°C/min to 180°C; carrier gas: N<sub>2</sub>; (b) capillary column: 100 m, CP-Sil 88 (Chrompack, Middelburg, the Netherlands, 100% cyanopropyl polysiloxane), 172°C isothermal; carrier gas: H<sub>2</sub>. (From Precht, D. et al., *Lipids*, 36, 213, 2001. With permission.)

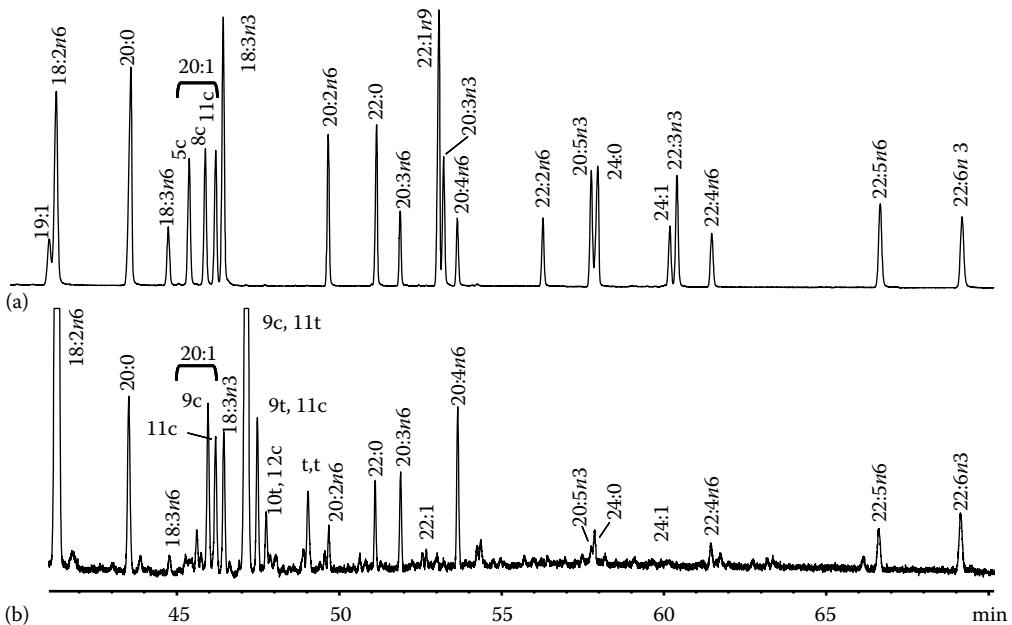
Capillary columns are very narrow (0.1–0.3 mm internal diameter) and typically 25–100 m long. They consist of fused silica reinforced by a flexible external polymeric coating and a thin internal coating of a bonded liquid phase. The thickness of the liquid phase has a marked impact on retention time: the thicker the film, the longer the retention time, but the greater the column capacity. FAs travel down the column with the carrier gas (He, H<sub>2</sub>, or N<sub>2</sub>) and diffuse into the liquid phase to varying degrees according to their equilibrium constant, thus being separated. In dairy fats, quantification of individual FAMES is usually carried out by reference to milk fat with known or certified FA composition. CRM 164 from the European Community Bureau of Reference in Brussels (Belgium) is the preferred material. FAs present in dairy fats in very small amounts, e.g., 9:0, 13:0, and 19:0, are also commonly used as internal standards.

Although someone new to the method may be tempted to purchase columns 100 m long to obtain the maximum possible resolution, excellent results can be achieved with 25 and 50 m long columns during routine milk fat analysis in which it suffices to quantify only the most important FAMES. One advantage of shorter columns is that analysis times can be appreciably shortened, allowing more samples to be processed in a given amount of time. There have been reports in the literature [15] of short analysis times (20–25 min) for milk FA profile determinations, but such analyses may only be of practical value in special circumstances, because the time needed to process the data may be much longer than the GC run times.

The liquid phases in use for GC analysis of FAMES in dairy fats are generally polyesters with differing polarities. In these columns, unsaturated components are eluted after the saturated FAs of the same chain length. These phases are much better suited to FA analysis, in that they allow clear separations of esters having the same chain length with zero to six double bonds. Polyesters can be classified according to their polarity, and in current practice only two main types need be considered, namely, low-to-medium-polarity polyesters, e.g., Carbowax-type phases (differing proportions of

polyethylene glycol esters) or Silar 5CP phases (silicone, 50% phenyl, 50% cyanopropyl), and high-polarity phases, such as CP-Sil 88, BPX70, and SP 2560 (100% cyanopropyl polysiloxane). Changing the polarity of a polyester phase does not change the elution order of different components in a given chain-length group, but it can affect elution order relative to components having other chain lengths. With low- to-medium-polarity phases, all the unsaturated C18 FAs elute from the column before any of the C20 components. Difficulties involving overlapping components of different chain lengths can thus be eliminated by using polyester liquid phases of this kind. The highest polarity columns resolution, especially of positional or geometric isomers, is substantially improved. Their principal disadvantage is some overlap between FAs of different chain lengths (Figure 9.2), and the nature and extent of the problem can be rather sensitive to column temperature. The inherent resolution is such that there may be few problems of actual overlap between major components, but there can be a multiplicity of peaks for dairy fat, giving rise to identification problems. Difficulties in resolving several families of FAs in milk fat using GC may be encountered, for instance, when separating the different 16:1 isomers from the 17-carbon branched-chain FAs, when discriminating between *trans*- and *cis*-monoenoic FAs, and when attempting to resolve the different CLA isomers.

Separation of the different FA regions on chromatograms of milk fats was evaluated using a 60 m Supelcowax 10 column and a 100 m CP-Sil 88 column [16] for comparison. The Supelcowax 10 column was shown to yield better resolution of the saturated short-chain FAs and their monounsaturated fatty acid (MUFA) analogs and was able to separate the  $\alpha$ -linolenic and 20:1 isomers completely. In contrast, the CP-Sil 88 column provided better resolution of the CLA isomers, MUFAs, previously isolated *trans* and *cis* isomer fractions, and PUFAs. A 100 m long highly polar capillary GC column would appear to be required to analyze milk FAs, whereas

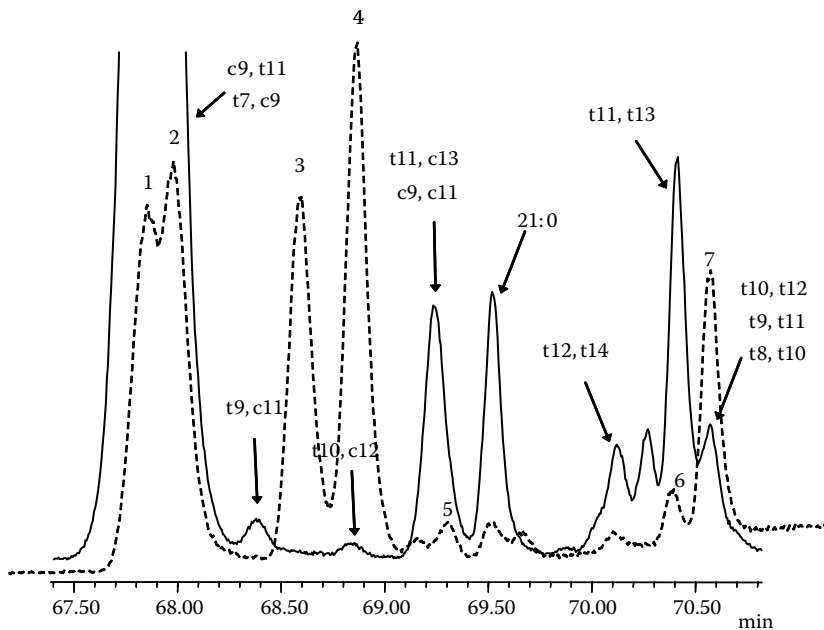


**Figure 9.2** Partial gas chromatogram of the 18:2 ( $n - 6$ ) to 22:6 ( $n - 3$ ) FAMEs using a 100 m CP-Sil 88 capillary column,  $H_2$  as carrier, and a typical temperature program from 45°C to 215°C. (a) FAME standard #463 from *Nu-Chek* (b) total milk FAMEs from cows fed a diet containing fish meal. (From Kramer, J.K.G. et al., *Lipids*, 37, 823, 2002. With permission.)

a 60 m Supelcowax 10 capillary column can at best serve as a complementary GC column, mainly because of the different separation characteristics ensuing from its intermediate polarity.

*Trans* 18:1 positional isomers were eluted in the order of double-bond progression along the carbon chain from carboxyl using 100 m high-polarity polyester columns [13,17–21]. Depending on column type, *trans* isomers up to VA or 13–14 have lower retention times than oleic acid. A first group of *trans* 18:1 FAs, including the *trans*-6–8, *trans*-9, *trans*-10, and *trans*-11 isomers, appeared relatively well resolved before the oleic acid peak. The *trans*-6–8 isomers were not resolved. A second group, including the *trans*-12 through *trans*-15 isomers, eluted with oleic acid and other *cis*-18:1 isomers (*cis*-6 through *cis*-11). Nonetheless, direct GC analysis on the 100 m polar CP-Sil 88 column clearly results in the overlap of *cis* and *trans* isomers (Figure 9.1). Indeed, many overlapping *trans* 18:1, *cis* 18:1, and *cis/trans* 18:2 isomers are only partially resolved at best, and furthermore, overlap of *trans* 16:1 with C17 branched-chain FAs and C18 FAs with C19, C20, and C21 FAs using the highly polar stationary phases that have become popular for FAME analysis of milk has also been reported. In the past few years, 200 m capillary columns of intermediate polarity have become available [21], yielding some improved separations of the 18:1 isomer region. However, using such columns requires higher head pressures, and the joint between the two 100 m columns is prone to leak.

Using 100 m cyanopropyl polysiloxane capillary columns, the CLA region of the GC chromatogram represents a challenge, even though this area is relatively free of other FAs except for 21:0 [22,23]. The elution order of the CLA isomers on these columns is all the *cis–trans* and *trans–cis* isomers, followed by all the *cis–cis* isomers, and finally all the *trans–trans* isomers (Figure 9.3).



**Figure 9.3** Partial GC–MS chromatograms depicting the profiles of CLA methyl esters from processed cheese fat (solid line) and a standard mixture from *Nu-Chek* (dotted line). CLA isomers in the standard mixture: 1, *cis*-9 *trans*-11; 2, *trans*-8 *cis*-10; 3, *cis*-11 *trans*-13; 4, *trans*-10 *cis*-12; 5, *cis*-9 *cis*-11; 6, *trans*-11 *trans*-13; 7, *trans*-8 *trans*-10 + *trans*-9 *trans*-11 + *trans*-10 *trans*-12. c, *cis*; t, *trans*. (From Luna, P. et al., *J. Agric. Food Chem.*, 53, 2690, 2005. With permission.)

There are about 20 different CLA isomers in natural milk fat, and many of them are not resolved on the columns tested. The *cis-trans* and *trans-cis* isomers overlap with some *cis-cis* isomers, and some *trans-trans* isomers coelute. Additionally, most of these separations are distinctly visible only when the relative concentrations of the different isomers are similar. Whenever the relative concentrations are uneven, a number of CLA isomers will be masked by the predominant isomers. For example, the *trans-7 cis-9* 18:2 isomer, the second most abundant CLA isomer in dairy fat, coelutes with the *cis-9 trans-11* isomer in GC. Some CLA isomers therefore have to be resolved by other chromatographic techniques.

Changing the GC operating conditions (column inlet pressure, oven temperature, sample load, and injection volume) can offer an alternative method of resolving overlapping peaks. Kramer et al. [24] analyzed different milk fats using a 100 m polar CP-Sil 88 column and performing two separations using isothermal temperature programs at 175°C and 150°C. By combining the results of these two separate GC analyses following fractionation, it was possible to determine most of the geometric and positional isomers of the 16:1, 18:1, 20:1, 18:2, and 18:3 FAs present in milk fat. Only few minor FAs could not be resolved, notably CLA isomers that still required further separation using other methods.

In recent years, comprehensive two-dimensional (2D) GC (GC × GC) has proven to be a powerful separation method for many types of complex samples, such as milk FAs. This procedure is a multidimensional separation technique in which the initial sample is separated on two GC columns with different separation mechanisms connected in series by a modulator [25]. The modulator acts both as a collection zone and as a fast re-injection device, resulting in a series of sharp pulses eluting from the 2D column for each peak entering the cryomodulator from the one-dimensional (1D) column. The GC × GC method offers high separation efficiency and enhanced sensitivity, thanks to concentrative modulation. Identification of compounds is more reliable than in traditional GC, since discrimination is based on two different separation principles. Usually, the first column is nonpolar, and the separation is based mainly on the different volatilities of the analytes, while the second column is polar or semipolar and the analytes are separated on the basis of polarity. GC × GC is also a good method for analyzing samples like milk fat, in which components are present in very different concentrations. Hyötyläinen et al. [26] applied this method to milk fat using four column combinations. The best results were obtained by a nonpolar–polar set with a narrow-bore Carbowax column as the second column, which improved separation of the FAs when compared with conventional 1D GC. Owing to the modulation, relatively dilute samples could be used, and major and minor components in the sample could be analyzed in a single run. New combinations of columns have also improved the overall separation of FAMES when compared with 1D GC, and the well-ordered structure of the compounds in a GC × GC contour plot facilitates identification and classification of known and unknown compounds in different milk fats [27]. Nevertheless, further research is needed to achieve increased separation of a number of specific peak pairs such as *trans* and *cis* 18:1 isomers.

## 9.4 Isolation and Fractionation of Fatty Acids

Although data from 25 to 100 m polar capillary columns should be accurate enough for many applications, including food labeling and quality control work, if greater resolution is required, GC analysis must be used in conjunction with another separation technique, particularly silver-ion ( $\text{Ag}^+$ ) chromatography, i.e., thin-layer chromatography (TLC), high-performance liquid chromatography (HPLC), or solid phase extraction (SPE).

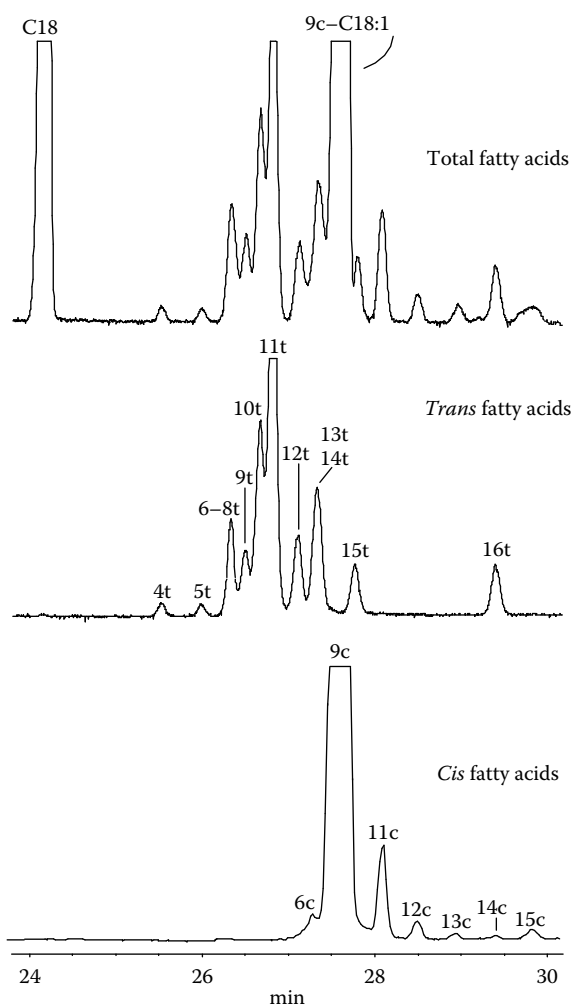
Over time, Ag<sup>+</sup> chromatography has developed into an important method of fractionating and characterizing lipids. The principle underlying this chromatographic technique is that silver ions interact reversibly with the  $\pi$  electrons of double bonds (*cis* more strongly than *trans*) to form polar complexes; the greater the number of double bonds in a molecule, the stronger the complex formed and the longer it is retained. In chromatographic systems, complex formation is transient, and complexes are in kinetic equilibrium with the native olefin. Christie [28] presented a fairly comprehensive listing of applications of Ag<sup>+</sup> chromatography (TLC and HPLC) in lipids analysis using a variety of substrates. Ag<sup>+</sup>-TLC has been used widely for milk fats and is still favored for FA fractionation by some laboratories [17,19–21,29–31], but HPLC and SPE have many advantages and are gaining acceptance.

Ag<sup>+</sup>-TLC can be carried out on glass plates or plastic sheets carrying a layer of silica gel impregnated with AgNO<sub>3</sub>. In most cases, the TLC plates are dipped in a 5%–20% AgNO<sub>3</sub> solution in acetonitrile or water, then dried and activated at 100°C–110°C and developed in saturated tanks at room temperature in hexane–diethyl ether or petroleum ether–diethyl ether [19,28,32]. During migration on TLC plates, the FAMES retention depends mainly on the geometric conformation of the ethylenic bonds, as well as on the degree of unsaturation. Proper elution conditions allow for distinct spots as a function of unsaturation. Monoenoic, dienoic, and polyenoic FAs can be separated in this way. In operating conditions for monoenoic *trans* FA analysis, Ag<sup>+</sup>-TLC of a milk fat FAME sample has led to the formation of four main spots corresponding to PUFAs, *cis*-monoenoic FAs, *trans*-monoenoic FAs, and saturated FAs. Following separation, FAMES on a TLC plate can be visualized under UV light after spraying with 2',7'-dichlorofluorescein in methanol. On completion of TLC runs, the silica gel can be scraped off the plate and the FAMES extracted with organic solvents for GC analysis.

If samples are analyzed by GC before and after the Ag<sup>+</sup>-TLC separation (Figure 9.4), quantities of *trans* acids in the mixture can be determined using an internal standard. The simplest way to determine the FA profile, including the *trans* monounsaturated group, is to collect the bands for the saturated and *trans*-monoenoic FAMES and then analyze them by GC. The proportion of *trans* MUFAs can be determined by comparison with the analysis of the total sample [28,29]. On the whole, despite certain differences in published protocols, Ag<sup>+</sup>-TLC fractionation is the least expensive and easiest to use method, since it requires only ordinary laboratory equipment. However, certain researchers have deemed the methodology to be time-consuming and labor-intensive, and the technique cannot be automated.

Several attempts have been made to adapt Ag<sup>+</sup>-TLC to HPLC, the main problem being to achieve a stable and reproducible stationary phase with a controlled Ag<sup>+</sup> content and a reasonable working life. An Ag<sup>+</sup> column for liquid chromatography was first developed by Christie [33], who added Ag<sup>+</sup> to a commercially available Nucleosil 5SA column. A decade later, stable Ag<sup>+</sup> columns for HPLC in which the Ag<sup>+</sup> are joined via ionic bonds to phenylsulfonic acid moieties bound to a silica matrix had become commercially available (*ChromoSpher 5 Lipid*, Varian, Middelburg, the Netherlands).

GC combined with prefractionation by Ag<sup>+</sup>-SPE [24] or preparative Ag<sup>+</sup>-HPLC [34,35] has been shown to be a good alternative to Ag<sup>+</sup>-TLC to isolate specific groups of FAs in milk fat. Kramer et al. [24] applied total FAMES from different milks onto Ag<sup>+</sup>-SPE cartridges and eluted with hexane containing increasing amounts of acetone, finding that 99:1 (v/v) eluted saturated FAs, 96:4 (v/v) eluted monounsaturated *trans*-FAMES, 90:10 (v/v) eluted monounsaturated *cis*-FAMES, and 0:100 (v/v) eluted dienoic FAMES. Lastly, trienoic FAMES were eluted with 6% (v/v) acetonitrile in acetone. All fractions were dried and reconstituted in hexane for analysis by GC. The Ag<sup>+</sup>-SPE method proved to be easier than Ag<sup>+</sup>-TLC and yielded better resolution of FAs in different regions of the GC chromatogram (Figure 9.5).



**Figure 9.4** Partial chromatograms of C18 and total C18:1 FAMES (unfractionated milk fat) and profile of the *trans*-octadecenoic and *cis*-octadecenoic acid methyl esters isolated by argentation TLC. Analysis on a 100m CP-Sil 88 capillary column (175°C, H<sub>2</sub> pressure 160 kPa). (From Precht, D. and Molkentin, J., *Int. Dairy J.*, 6, 791, 1996. With permission.)

## 9.5 Silver Ion HPLC of CLA

The use of Ag<sup>+</sup>-HPLC to complement GC in the assay of CLA was first reported by Sehat et al. [36]. This method was based on the work of Adlof [37], who used an acetonitrile:hexane elution system. The system used for isocratic separations of CLA FAME was equipped with commercial *ChromSpher 5 Lipids* columns, the mobile phase being 0.1% (v/v) acetonitrile in hexane. CLA isomers are selectively detected by their characteristic UV absorbance at 233 nm, and isomer identities in HPLC chromatograms are based on coinjections of known reference materials obtained from commercial sources or synthesized. The Ag<sup>+</sup>-HPLC profile has been shown to separate the different *trans-trans* compounds followed by a chromatographic elution zone containing the *cis/trans* (*cis-trans* plus *trans-cis*) isomers (Figure 9.6). Although these geometric isomers are not

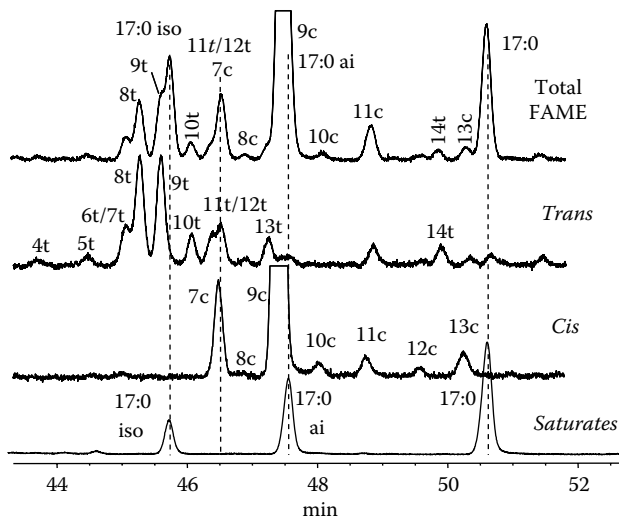


Figure 9.5 Partial gas chromatograms of milk fat separated using a GC program at 150°C depicting the 16:1 FA isomers. The total milk FAMES were compared with the *trans*, *cis*, and saturated FA fractions isolated from total milk fat FAMES using Ag<sup>+</sup>-SPE columns. (From Kramer, J.K.G. et al., *Lipids*, 43, 259, 2008. With permission.)

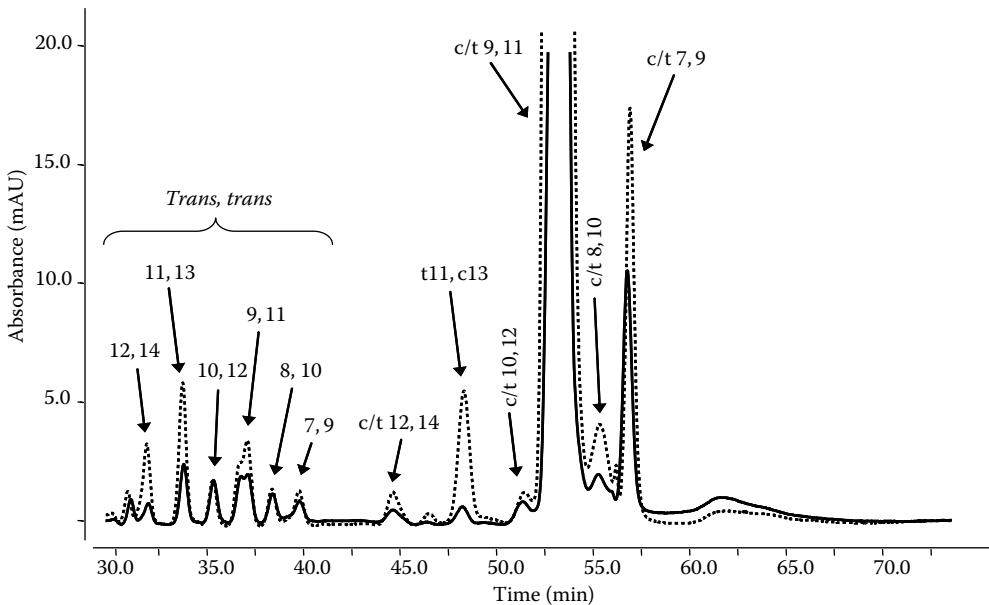


Figure 9.6 Silver-ion HPLC chromatograms (three columns in series and UV detection at 233 nm) of bulk milk fat from goats fed a reference diet (solid line) and a diet supplemented with whole linseed (1.85% dry matter) and sunflower oil (0.81% dry matter) for 3 months. AU, arbitrary unit; *c*, *cis*; *t*, *trans*. (From Luna, P. et al., *J. Dairy Sci.*, 91, 20, 2008. With permission.)

resolved, species differing in positional double bonds elute separately. Operating from one to six Ag<sup>+</sup>-HPLC columns in series progressively improved the resolution of the methyl esters of CLA isomeric mixtures from natural and commercial products but increases time and cost of analysis [38,39]. Ag<sup>+</sup>-HPLC have been widely used in separating CLA isomers in dairy fats [20,21] and, in combination with GC with different detectors, was able to identify the presence of *trans-7 cis-9* isomer in milk fat [40].

## 9.6 Determination of Free Fatty Acids

The FFA content is very low in microbiologically high-quality milk but can be sizeable in some dairy products. Quantification of FFAs in cheese, for instance, is important, owing to the impact of some of these compounds on organoleptic properties [41]. Typically, cheeses with more than 3000 mg FFA/kg have a characteristic lipolytic aroma/ flavor, with lipolysis playing a major role in ripening. Furthermore, FFAs are precursors for a wide range of flavor components (ketones, aldehydes, lactones, etc.). Several helpful reviews [41–44] do provide useful information on FFA composition and describe analytical methods for dairy products in detail. Additionally, a recent fairly comprehensive listing of chromatographic applications for analyzing FFAs in milk products was presented by Kilcawley [45]. The present section will place particular emphasis on those methods that the authors have found to be particularly useful, and is therefore much less comprehensive in its coverage of the literature.

Determining the FFAs in dairy products is quite complicated, because FFAs generally represent less than 1% of total milk lipids, which consist primarily of TAGs. Good separation of FFAs and TAGs mainly depends on avoiding hydrolysis of the latter during fractionation. The most frequently described methods of analysis of FFAs in dairy foods involve separation of the FFAs from the bulk of the TAGs by stirring with anion-exchange resins, which retain the FFAs [46–48]; fractionation on different types of liquid chromatography columns that adsorb the FFAs followed by elution [49–54]; or one-step preparation of methyl esters of both FFAs and glycerides (in separate phases) using tetramethylammonium hydroxide (TMAH) as catalyst [53,55–57]. In this last-mentioned method, FFAs and TAGs are not separated prior to derivatization, thus facilitating the analysis of large numbers of samples.

Once separated from the rest of the dairy lipids, FFAs can be derivatized (see Section 9.2) or analyzed directly in free form by GC. To decrease analysis time, certain researchers [50,58,59] have proposed injecting the FFAs on GC columns without derivatization. However, FFAs could be adsorbed and retained on the stationary phase, giving rise to tailed peaks and poor separations. What is more, the retained FFAs could then elute during subsequent injections, resulting in erroneous determinations. Deeth et al. [49] and Contarini et al. [58] employed columns packed with a stationary phase specially prepared for FFAs (free fatty acid phase, FFAP). Using FFAP avoids retention of the FFAs on the column, but this stationary phase is not able to discriminate between unsaturated and saturated FFAs like *cis-9* 18:1 and 18:0.

Although GC is the most popular means of FFA determination, several advantages inherent to HPLC could make it useful, mainly for quantifying short-chain FFAs. Most of the procedures described in the literature are based on the use of reverse-phase (RP) HPLC columns and UV or fluorescence detectors. Reed et al. [60] derivatized the FFAs in butter samples by converting them to *p*-bromophenacyl (PBP) esters. These derivatives improved the sensitivity of the UV detector, but two chromatographic runs were required to quantify all the FFAs because of



problems involving coelution of some medium- and long-chain FFAs. Complete resolution of PBP esters of saturated and unsaturated FFAs with an acyl chain length of C4:0 to C18:0 was accomplished by gradient elution while holding RP column temperature at 10°C [61]. Further development of the PBP derivative technique was undertaken by García et al. [62], who used a water/methanol/acetonitrile gradient to achieve faster separation of all the FFAs. Kilcawley et al. [63] also used these derivatives to quantify the short-chain FFAs in different types of cheese. Alternatively, Miwa and Yamamoto [64] developed an HPLC method based on the reaction of the FFAs with 2-nitrophenylhydrazine hydrochloride. The FFAs, derivatized to their hydrazide form, were separated into two groups by a simple solvent extraction, short- and long-chain FFAs, and analyzed on an RP column with detection at 400 nm. Fluorescence-oriented derivatization coupled with HPLC has also been well documented and used to analyze the FFAs in dairy samples [65–67].

## 9.7 Identification of Fatty Acid Structure

Identification of the FAs in milk fat is also challenging and is usually based solely on comparisons of GC retention times. GC with FID is a standard analytical tool for FA analysis and can provide useful information about the number of mixture components, retention times, and elution sequence. However, FID traces do not provide structural information. Furthermore, owing to the limited availability of standards and the occurrence of overlapping peaks, identifications tend to be tentative at best.

Milk fat contains a multiplicity of small quantities of positional and geometric isomers of unsaturated FAs. GC identification of these FAs is based mainly on GC–MS rather than on GC–FID data. Excellent and comprehensive overviews [28,68] have dealt with this subject, and readers can find more details in those publications. Updated information on different aspects of this field is also available from the Mylnefield Lipid Analysis Unit at the Scottish Crop Research Institute ([www.lipid.co.uk](http://www.lipid.co.uk)).

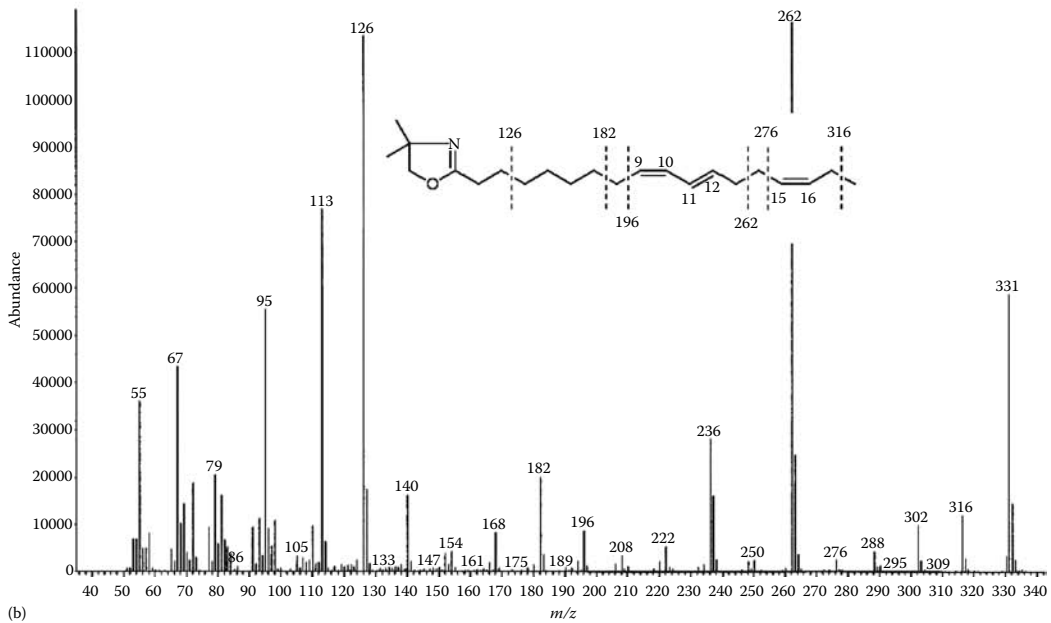
In MS detectors based on electronic impact ionization (EII), the various ionic species generated are separated according to mass (mass/charge ratio,  $m/z$ ) in a magnetic field, and a spectrum is obtained that in effect is a bar diagram showing the masses of the ions and their abundance relative to the most abundant ion, assigned a value of 100%. Methyl esters are generally regarded as being unsuitable for pinpointing the position of double bonds or other centers of unsaturation in an FA, because a charged aliphatic chain produces an indeterminate number of fragments and double-bond migration during electron impact MS. To obtain more relevant information on FA structure, the carboxyl group has to be derivatized with a nitrogen-containing reagent, since the nitrogen atom rather than the alkyl chain carries the charge during MS, which minimizes the ionization and migration of double bonds. The first useful nitrogen-containing derivatives, pyrrolidides, were described more than 30 years ago. However, most analysts now prefer either picolinyl ester or 4,4-dimethyloxazoline (DMOX) derivatives [32,68]. Reviews of the FA mass spectral fragmentation properties of picolinyl ester and DMOX derivatives have been published by Harvey [69] and Spitzer [70], respectively. DMOX derivatives are readily prepared by a simple reaction, are only slightly less volatile than FAMES, and can be subjected to GC analysis on polar stationary phases under comparable conditions, yielding equivalent resolution. Picolinyl esters require column temperatures about 50°C higher than FAMES, initially meaning that they had to be separated on nonpolar phases, which gave relatively poor resolution. However, the

introduction of new polar phases that are stable at high column temperatures (see Section 9.3) has greatly lessened the problem of GC resolution of picolinyl esters, and only very long-chain FAs tend to cause problems.

For FA identification, a basic instrument with EII would be capable of meeting most needs. In fact, structural characterization of some families of PUFAs, like CLA isomers, has been achieved by GC–EII–MS in combination with other chromatographic techniques [71]. Using GC–MS analysis of DMOX derivatives of some FAME fractions isolated by preparative Ag<sup>+</sup>-HPLC, it was possible to identify the position of the double bonds of the 13 conjugated isomers of arachidonic acid and 6 isomers of  $\alpha$ -linolenic acid in cheese fat [34]. More recently, Destailats et al. [72] and Plourde et al. [73] confirmed by GC–EII–MS of picolinyl esters and DMOX derivatives the presence of low quantities of rumelenic acid (*cis*-9 *trans*-11 *cis*-15 18:3), an intermediate generated during ruminal biohydrogenation of  $\alpha$ -linolenic acid (Figure 9.7), in milk fat.

Notwithstanding all the above positive features, GC–MS of nitrogen-containing derivatives has to be combined with other techniques if the FAs are to be identified in full, especially for purposes of determining *cis* or *trans* configuration. Furthermore, although geometric configuration can be inferred from chromatographic behavior, geometric isomers cannot be differentiated on the basis of their mass spectra. Acetonitrile covalent adduct chemical ionization tandem mass spectrometry (CACI–MS/MS) has been shown to be an alternative method for elucidating double-bond position and geometric configuration in methyl esters of unsaturated FAs [74]. The (1-methyleneimino)-1-ethenylium ion ( $m/z = 54$ ) generated by self-reaction of acetonitrile under mass spectrometer chemical ionization conditions reacts with unsaturated FAs to yield an  $[M + 54]^+$  ion. Collisionally activated dissociation of the  $[M + 54]^+$  ion yields two diagnostic ions produced by bond cleavage at specific locations on unsaturated FAs. In CLA molecules, these ions result from C–C cleavage at a position vinylic to either side of the conjugated diene unit, yielding an  $\alpha$  diagnostic ion containing the ester group and an  $\omega$  diagnostic ion containing the terminal methyl group. In CLA with mixed double-bond geometrical configurations, for steric reasons, the  $m/z = 54$  ion preferentially bonds across the *cis* double bond, giving rise to a higher abundance of the diagnostic ion in which C–C cleavage occurs vinylic to the original *trans* double bond. Subsequently, acquisition of CLA standards and publication of the mass spectra demonstrated that all the peaks in a milk fat sample had been properly assigned without standards by CACI–MS/MS [75]. Extension of this technique to other *trans* monoenes and to conjugated FAMES with three or more double bonds is an area of active research. The unusual *cis*-12 *cis*-15 18:2 and *cis*-9 *trans*-11 *cis*-15 18:3 FAs were unequivocally identified in ruminant fat by CACI–MS/MS [76], and this methodology has also elucidated the molecular structure (*cis*-9) of heptadecenoic acid (17:1) in milk [77].

Application of Fourier transform infrared (FTIR) spectroscopy can also be a useful tool in determining the total *trans* FA content of different fats and oils [78]. *Trans* ethylenic bonds display specific absorption in the infrared spectrum from 956 to 976  $\text{cm}^{-1}$ . However, IR-spectroscopy is inappropriate for studying individual *trans* FA isomers, since it does not furnish any information on the proportions of the different isomers or specific details on isomer type, such as chain length or the number and position of *trans* bonds. A combined method of GC–FTIR can be used to determine ethylenic bond geometry [79]. The advantage of this combined method is that it directly provides the IR spectrum of each FAME peak after chromatography. Nonetheless, this approach is quite expensive, is not widely employed, and requires technical expertise. This analytical method is still a procedure for research laboratories and does not appear to be particularly well suited for routine quality control laboratories.



**Figure 9.7** Mass spectra of the (a) picolinyl ester and (b) DMOX derivatives of *cis*-9 *trans*-11 and *cis*-15 18:3 acid obtained by GC–MS analysis of milk fat FAs. (From Destailats, F. et al., *J. Dairy Sci.*, 88, 3231, 2005. With permission.)

## 9.8 Final Remarks

Presently, there is no single standard procedure for determining all the FAs in milk fat. Long GC capillary columns are the main tool for elucidating the major FAs and a substantial portion of the minor FAs. Using such chromatographic methods as TLC and HPLC for fractionation is essential to separate certain groups of FAs, for instance, PUFAs and *trans* geometric isomers. Even then, mass detectors have to be used with GC systems to be able to elucidate the molecular structure of the minor FAs in milk fat. Despite the significant developments in the various chromatographic methods that have taken place in recent years, additional advances are needed for analysis of the minor components.

## References

1. Jensen, R.G., The composition of bovine milk lipids: January 1995 to December 2000, *J. Dairy Sci.*, 85, 295, 2002.
2. Precht, D. and Molquentin, J., *Trans*-geometrical and positional isomers of linoleic acid including conjugated linoleic acid (CLA) in German milk and vegetable fats, *Fett/Lipids*, 99, 319, 1997.
3. Juárez, M., Tests for fraudulent identification, in *Proceedings of the XXIII International Dairy Congress*, Montreal, Canada, 1990, p. 1285.
4. Collomb, M. and Spahni, M., Adulteration of dairy products. Review of analytical methods for the determination of vegetable and animal fats in butterfat, *Mitt. Geb. Lebensm. Unters. Hyg.*, 82, 615, 1991.
5. Kramer, J.K.G. et al., Evaluating acid and base catalysts in the methylation of milk and rumen fatty acids with special emphasis on conjugated dienes and total *trans* FAs, *Lipids*, 32, 1219, 1997.
6. Yamasaki, M. et al., A recommended esterification method for gas chromatographic measurement of conjugated linoleic acid, *JAOCs*, 76, 933, 1999.
7. Park, Y. et al., Comparison of methylation procedures for conjugated linoleic acid and artifact formation by commercial (trimethylsilyl) diazomethane, *J. Agric. Food Chem.*, 49, 1158, 2001.
8. ISO-IDF 2002, Milk fat-preparation of FA methyl esters, International Standard ISO 15884-IDF 182:2002.
9. Christopherson, S.W. and Glass, R.L., Preparation of milk fat methyl esters by alcoholysis in an essentially non-alcoholic solution, *J. Dairy Sci.*, 52, 1289, 1969.
10. Wolff, R.L. and Bayard, C.C., Improvement in the resolution of individual *trans*-18:1 isomers by capillary gas-liquid chromatography: Use of a 100-m CP-Sil 88 column, *JAOCs*, 72, 1197, 1995.
11. Wolff, R.L., Bayard, C.C., and Fabien R.J., Evaluation of sequential methods for the determination of butterfat fatty acid composition with emphasis on *trans*-18:1 acids. Application to the study of seasonal variations in French butters, *JAOCs*, 72, 1471, 1995.
12. Ulberth, F., Gabernig R.G., and Schrammel, F., Flame-ionization detector response to methyl, ethyl, propyl, and butyl esters of fatty acids, *JAOCs*, 76, 263, 1999.
13. Wolff, R.L., Contribution of *trans*-18/1 acids from dairy fat to European diets, *JAOCs*, 71, 277, 1994.
14. ISO-IDF 2002, Milk fat-determination of the FA composition by gas-chromatography, International Standard ISO 15885 IDF 184:2002 (E).
15. Moltó-Puigmartí, C., Castellote, A.I., and López-Sabater, M.C., Conjugated linoleic acid determination in human milk by fast-gas chromatography, *Anal. Chim. Acta*, 602, 122, 2007.
16. Kramer, J.K.G. et al., Evaluation of two GC columns (60-m SUPELLOWAX 10 and 100-m CP Sil 88) for analysis of milk fat with emphasis on CLA, 18:1, 18:2 and 18:3 isomers, and short- and long-chain FA, *Lipids*, 37, 823, 2002.
17. Precht, D. and Molquentin, J., Rapid analysis of the isomers of *trans*-octadecenoic acid in milk fat, *Int. Dairy J.*, 6, 791, 1996.

18. Precht, D. et al., Overestimates of oleic and linoleic acid contents in materials containing *trans* fatty acids and analyzed with short packed gas chromatographic columns, *Lipids*, 36, 213, 2001.
19. Ledoux, M., Laloux, L., and Wolff, R.L., Analytical methods for determination of *trans*-C18 fatty acid isomers in milk fat. A review, *Analisis*, 28, 402, 2000.
20. Cruz-Hernández, C. et al., Methods for analysis of conjugated linoleic acids and *trans*-18:1 isomers in dairy fats by using a combination of gas chromatography, silver-ion thin-layer chromatography/gas chromatography, and silver-ion liquid chromatography, *J. AOAC Int.*, 87, 545, 2004.
21. Cruz-Hernández, C. et al., Systematic analysis of *trans* and conjugated linoleic acids in the milk and meat of ruminants, in *Advances in Conjugated Linoleic Acid*, Vol. 3, Yurawecz, M.P., Kramer, J.K.G., Gudmundsen, O., Pariza, M.W., and Banni S., Eds., AOCS Press, Champaign, IL, 2006, p. 45.
22. Roach, J.A.G. et al., Chromatographic separation and identification of conjugated linoleic acid isomers, *Anal. Chim. Acta*, 465, 207, 2002.
23. De la Fuente, M.A., Luna, P., and Juárez, M., Chromatographic techniques to determine conjugated linoleic acid isomers, *Trends Anal. Chem.*, 25, 917, 2006.
24. Kramer, J.K.G. et al., Combining results of two separations partly achieves determination of all *cis* and *trans* 16:1, 18:1, 18:2 and 18:3 except CLA isomers of milk fat as demonstrated using Ag-ion SPE fractionation, *Lipids*, 43, 259, 2008.
25. Marriott, P. and Shellie, R., Principles and applications of comprehensive two-dimensional gas chromatography, *Trends Anal. Chem.*, 21, 573, 2002.
26. Hyötyläinen, T. et al., Comprehensive two-dimensional gas chromatography in the analysis of dietary fatty acids, *J. Sep. Sci.*, 27, 459, 2004.
27. Vlaeminck, B. et al., Comprehensive two-dimensional gas chromatography for the separation of fatty acids in milk, *Eur. J. Lipid Sci. Technol.*, 109, 757, 2007.
28. Christie, W.W., *Lipid Analysis. Isolation, Separation, Identification and Structural Analysis of Lipids*, 3rd edn., The Oily Press, Bridgewater, U.K., 2003.
29. Alonso, L. et al., Fatty acid composition of caprine milk: Major, branched-chain and *trans* fatty acids, *J. Dairy Sci.*, 82, 878, 1999.
30. Destailats, F. et al., Study of individual *trans*- and *cis*-16:1 isomers in cow, goat, and ewe cheese fats by gas-liquid chromatography with emphasis on the *trans*- $\Delta$ 3 isomer, *Lipids*, 35, 1027, 2000.
31. Golay, P.A. et al., Direct quantification of fatty acids in dairy powders with special emphasis on *trans* fatty acid content, *Food Chem.*, 101, 1115, 2006.
32. Ratnayake, W.M.N., Overview of methods for the determination of *trans* fatty acids by gas-chromatography, silver-ion thin-layer chromatography, silver-ion liquid chromatography, and gas chromatography/mass spectrometry, *J. AOAC Int.*, 87, 523, 2004.
33. Christie, W.W., A stable silver-loaded column for the separation of lipids by high-performance liquid chromatography, *J. High Resol. Chromatogr.*, 10, 148, 1987.
34. Winkler, K. and Steinhart, H., Identification of conjugated isomers of linolenic acid and arachidonic acid in cheese, *J. Sep. Sci.*, 24, 663, 2001.
35. Adlof, R.O., Separation of conjugated linoleic acid methyl esters by silver-ion high performance liquid chromatography in semi-preparative mode, *J. Chromatogr. A*, 1033, 369, 2004.
36. Sehat, N. et al., Silver-ion high-performance liquid chromatographic separation and identification of conjugated linoleic acid isomers, *Lipids*, 33, 217, 1998.
37. Adlof, R.O., Separation of fatty acid methyl esters and triacylglycerols by Ag-HPLC: Silver ion and normal phase contributions to retention, in *New Techniques and Application in Lipid Analysis*, McDonald, R.E. and Mossoba, M.M., Eds., AOCS Press, Champaign, IL, 1997, p. 256.
38. Sehat, N. et al., Improved separation of conjugated linoleic acid methyl esters by silver-ion high-performance liquid chromatography, *Lipids*, 34, 407, 1999.
39. Rickert, R. et al., Enhanced resolution of conjugated linoleic acid isomers by tandem-column silver-ion high performance liquid chromatography, *J. High Resol. Chromatogr.*, 22, 144, 1999.
40. Yurawecz, M.P. et al., A new linoleic acid isomer, 7 *trans*, 9 *cis*-octadecadienoic acid, in cow milk, cheese, beef and human milk and adipose tissue, *Lipids*, 33, 803, 1998.

41. Collins, Y.F., McSweeney, P.L.H., and Wilkinson, M.G., Lipolysis and free fatty acid catabolism in cheese: A review of current knowledge, *Int. Dairy J.*, 13, 841, 2003.
42. IDF, Determination of free fatty acids in milk and milk products, *Bull. Int. Dairy Fed.*, 265, 1, 1991.
43. De la Fuente, M.A. and Juárez, M., Review: Determination of free fatty acids in dairy products, *Rev. Esp. Cien. Tecnol. Alim.*, 33, 247, 1993.
44. Collomb, M. and Spahni, M., Review of the methods used for the determination of free fatty acids in milk and dairy products, *Lebensm. Wissens. Tech.*, 28, 355, 1995.
45. Kilcawley, K.N., High performance liquid chromatographic and gas chromatographic methods for lipid analysis, in *Advanced Dairy Chemistry*, 3rd edn., Fox, P.F. and McSweeney, P.L.H., Eds., Springer, New York, 2006, p. 675.
46. Needs, E.C. et al., A method for the quantitative determination of individual free fatty acids in milk by ion exchange resin adsorption and gas-liquid chromatography, *J. Dairy Res.*, 50, 321, 1983.
47. Spangelo, A. et al., Determination of individual free fatty-acids in milk by strong anion-exchange resin and gas-chromatography, *J. Dairy Sci.*, 69, 1787, 1986.
48. McNeill, G.P. and Connolly, J.F., A method for the quantification of individual free fatty acids in cheese: Application to ripening of Cheddar-type cheeses, *Irish J. Food Sci. Technol.*, 13, 119, 1989.
49. Deeth, H.C., Fitzgerald, C.H., and Snow, A.J., A gas chromatographic method for the quantitative determination of free fatty acids in milk and milk products, *NZ J. Dairy Sci. Technol.*, 18, 13, 1983.
50. De Jong, C. and Badings, H.T., Determination of free fatty acids in milk and cheese, *J. High Resol. Chromatogr.*, 13, 94, 1990.
51. Ha, J.K. and Lindsay, R.C., Method for the quantitative analysis of volatile free and total branched-chain fatty acids in cheese and milk fat, *J. Dairy Sci.*, 73, 1988, 1990.
52. De Jong, C., Palma, K., and Neeter, R., Simple preparation before capillary gas-chromatographic estimation of free fatty acids in fermented dairy products, *Neth. Milk Dairy J.*, 48, 151, 1994.
53. Chavarri, F. et al., Determination of free fatty acids in cheese: Comparison of two analytical methods, *J. Dairy Res.*, 64, 445, 1997.
54. Woo, A.H. and Lindsay, R.C., Rapid method for quantitative analysis of individual free fatty acids in Cheddar cheese, *J. Dairy Sci.*, 65, 1102, 1982.
55. Martínez-Castro, I., Alonso, L., and Juárez, M., Gas chromatographic analysis of free fatty acids and glycerides of milk fat using tetramethylammonium hydroxide as catalyst, *Chromatographia*, 21, 37, 1986.
56. Martín-Hernández, M.C. et al., Gas chromatographic method for determining free fatty acids in cheese, *Chromatographia*, 25, 87, 1988.
57. Juárez, M., De la Fuente, M.A., and Fontecha, J., Improved gas chromatographic method for the determination of the individual free fatty acids in cheese using a capillary column and a PTV injector, *Chromatographia*, 33, 351, 1992.
58. Contarini, G. et al., Metodiche analitiche e gas cromatografiche per la valutazione della frazione acidica libera nei prodotti lattiero-caseari, *Riv. Ital. Sostan. Grasse*, 66, 561, 1989.
59. Innocente, N. et al., A rapid method for the quantitative determination of short-chain free fatty acids from cheese, *J. Agric. Food Chem.*, 48, 3321, 2000.
60. Reed, A.W., Deeth, H.C., and Clegg, D.E., Liquid chromatographic method for quantitative determination of free fatty acids in butter, *JAOCs*, 67, 718, 1984.
61. Elliott, J.M., de Haan, B., and Parkin, K.L., An improved liquid chromatographic method for the quantitative determination of free fatty acids in milk products, *J. Dairy Sci.*, 72, 2478, 1989.
62. García, H.S. et al., Determination of the major free fatty acids in milkfat using a three-component mobile phase for HPLC analysis, *Milchwissenschaft*, 45, 757, 1990.
63. Kilcawley, K.N., Wilkinson, M.G., and Fox, P.F., A survey of lipolytic and glycolytic end-products in commercial Cheddar enzyme-modified cheese, *J. Dairy Sci.*, 84, 66, 2001.
64. Miwa, H. and Yamamoto, M., Liquid chromatographic determination of free and total fatty acids in milk and milk products as their 2-nitrophenylhydrazides, *J. Chromatogr.*, 523, 235, 1990.

65. Totsuka, S. et al., Determination of free fatty acid in milk or dairy products by HPLC, *Bunseki Kagaku*, 45, 927, 1996.
66. Lu, C.Y. et al., Simple and sensitive analysis of long-chain free fatty acids in milk by fluorogenic derivatization and high performance liquid chromatography, *J. Agric. Food Chem.*, 50, 71, 2002.
67. Nishimura, K., Suzuki, T., and Itabashi, Y., Determination of free fatty acids in milk and dairy products by reversed-phase HPLC with fluorescence detection, *J. Food Hyg. Soc. Japan*, 43, 230, 2002.
68. Christie, W.W., Gas chromatography–mass spectrometry methods for structural analysis of fatty acids, *Lipids*, 33, 343, 1998.
69. Harvey, D.J., Mass spectrometry of picolinyl and other nitrogen-containing derivatives of fatty acids, in *Advances in Lipid Methodology*, Christie, W.W., Ed., The Oily Press, Dundee, U.K., 1992, p. 19.
70. Spitzer, V., Structure analysis of fatty acids by gas chromatography–low resolution electron impact mass spectrometry of their 4,4 dimethylloxazoline derivatives—A review, *Prog. Lipid Res.*, 35, 387, 1997.
71. Dobson, G., Gas-chromatography–mass spectrometry of conjugated linoleic acid and metabolites, in *Advances in Conjugated Linoleic Acid Research*, Vol. 2, Sébédio, J.L., Christie, W.W., and Adlof, R., Eds., AOCS Press, Champaign, IL, 2006, p. 13.
72. Destailats, F. et al., Analysis of  $\alpha$ -linolenic acid biohydrogenation intermediates in milk fat with emphasis on conjugated linolenic acids, *J. Dairy Sci.*, 88, 3231, 2005.
73. Plourde, M. et al., Conjugated  $\alpha$ -linolenic acid isomers in bovine milk and muscle, *J. Dairy Sci.*, 90, 5269, 2007.
74. Brenna, J.T., Structural analysis of unsaturated fatty acid methyl ester isomers with acetonitrile covalent-adduct chemical ionization (CACI) tandem mass spectrometry, in *Lipid Analysis and Lipidomics*, Mossoba, M.M., Kramer, J.K.G., Brenna, J.T., and McDonald, R.E., Eds., AOCS Press, Champaign, IL, 2006, p. 157.
75. Michaud, A.L. and Brenna, J.T., Structural characterization of conjugated linoleic acid methyl esters with acetonitrile chemical ionization tandem mass spectrometry, in *Advances in Conjugated Linoleic Acid*, Vol. 3, Yurawecz, M.P., Kramer, J.K.G., Gudmundsen, O., Pariza, M.W., and Banni, S., Eds., AOCS Press, Champaign, IL, 2006, p. 119.
76. Alves, S.P. and Bessa, R.J.B., Identification of *cis*-12, *cis*-15 octadecadienoic acid and other minor polyenoic fatty acids in ruminant fat, *Eur. J. Lipid Sci. Technol.*, 109, 879, 2007.
77. Alves, S.P. et al., The nature of heptadecenoic acid in ruminant fats, *J. Dairy Sci.*, 89, 170, 2006.
78. Mossoba, M.M. et al., Overview of infrared methodologies for *trans* fat determination, *J. AOAC Int.*, 87, 540, 2004.
79. Azizian, H. and Kramer, J.K.G., Application of FT-NIR for rapid determination of the *trans* fatty acid composition in fats and oils, in *Lipid Analysis and Lipidomics*, Mossoba, M.M., Kramer, J.K.G., Brenna, J.T., and McDonald, R.E., Eds., AOCS Press, Champaign, IL, 2006, p. 303.
80. Luna, P., De la Fuente, M.A., and Juárez, M., Conjugated linoleic acid in processed cheeses during the manufacturing stages, *J. Agric. Food Chem.*, 53, 2690, 2005.
81. Luna, P. et al., Effect of a diet enriched in whole linseed and sunflower oil on goat milk fatty acid composition and conjugated linoleic acid isomer profile, *J. Dairy Sci.*, 91, 20, 2008.

# Chapter 10

---

# Cholesterol

---

Zehra Güler and Young W. Park

## CONTENTS

10.1	Introduction.....	230
10.2	Analytical Methods for the Determination of Cholesterol .....	231
10.2.1	Association of Official Analytical Chemists (AOAC) Method (Adapted from AOAC, 16th Edition, 1996; No. 994.10) .....	233
10.2.2	Federation Internationale de Laiterie – International Dairy Federation (FIL-IDF) Method (IDF Standard 159:1992).....	236
10.2.3	Capillary Gas Chromatographic Method with Direct Saponification.....	237
10.2.4	High-Performance Liquid Chromatography Method.....	239
10.2.4.1	Method 1.....	239
10.2.4.2	Method 2 .....	241
10.2.4.3	Method 3 .....	241
10.2.5	Fourier Transformed Infrared and Fourier Transformed Near-Infrared Methods.....	241
10.2.5.1	Fourier Transformed Infrared Method .....	241
10.2.5.2	Fourier Transformed Near-Infrared Method .....	242
10.2.6	Spectrometric (Colorimetric) Methods.....	242
10.2.6.1	Colorimetric Method 1 .....	242
10.2.6.2	Colorimetric Method 2 .....	243
10.2.6.3	Colorimetric Method 3 .....	244
10.2.7	Enzymatic Methods.....	244
10.2.7.1	Enzymatic Method 1 .....	244
10.2.7.2	Enzymatic Method Using Commercial Kit .....	245
10.2.8	Supercritical Fluid Chromatography.....	245



10.3	Evaluation of Different Extraction Methods for Analyzing Sterols in Dairy Products.....	247
10.3.1	Diethyl Ether .....	247
10.3.2	Roese Gottlieb .....	247
10.3.3	Schmid Bondzynski Ratzlaff.....	247
10.3.4	Chloroform/Methanol .....	247
10.3.5	Soxhlet.....	247
10.4	Comparison of Accuracy and Precision of the Different Methods in Cholesterol Assay .....	247
10.4.1	Cholesterol Recovery Studies by Paradkar and Irudayaraj.....	247
10.4.2	Comparison of GC, HPLC, and Spectrophotometric Methods.....	249
10.4.2.1	Spectrometric Analysis .....	249
10.4.2.2	Gas Chromatographic Method.....	249
10.4.2.3	HPLC Method.....	249
10.4.3	Comparison of Different Extraction/Colorimetric Procedures with GC Method.....	251
10.5	Weaknesses and Strengths of Analytical Methods of Cholesterol.....	253
10.6	Conclusions .....	254
	References.....	254

## 10.1 Introduction

Cholesterol is the principal mammalian sterol containing 27 carbon atoms with a combination of steroid and alcohol (Figure 10.1). The name cholesterol originates from the Greek: *chole-* (bile) and *stereos* (solid), and the chemical suffix *-ol* for an alcohol [1]. Cholesterol is required by all the mammalian cells for the proper functioning of cellular membranes [2]. Cholesterol is also a precursor of bile acids and steroidal hormones, such as progesterone, testosterone, estradiol, cortisol, and vitamin D [3].

Most of the cholesterols are synthesized by the body, and some are of dietary origin. All the 27 carbon atoms of cholesterol are derived from acetyl CoA through the 3-hydroxy-3-methylglutaryl-CoA

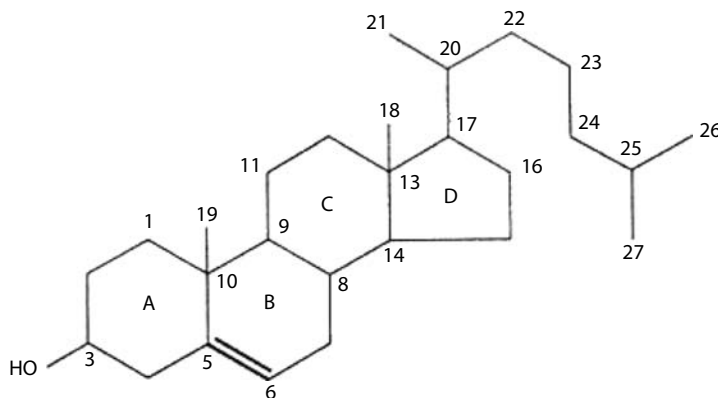


Figure 10.1 Cholesterol ( $C_{27}H_{46}O$ ) (molecular mass: 386.6).

(HMG-CoA) reductase pathway in many cells, including the liver [3,4]. Cholesterol ester synthesis also takes place in the mammary gland [5]. Cholesterol is more abundant in tissues having densely packed membranes, such as the liver, spinal cord, and brain.

The pathway of cholesterol biosynthesis may be generally divided into four stages [3]: (1) the formation of mevalonic acid from three molecules of acetyl CoA, (2) the biosynthesis of squalene from six molecules of mevalonic acid through a series of phosphorylated intermediates, (3) the biosynthesis of lanosterol from squalene via cyclization of 2,3-epoxysqualene, and (4) the modification of lanosterol to produce cholesterol.

Cholesterol is bound to one of the various lipoproteins, and transported into the circulatory system. The main types of lipoproteins are low-density lipoprotein (LDL) and high-density lipoprotein (HDL), and they carry the cholesterol from and to the liver [6,7]. Abnormally high cholesterol levels (hypercholesterolemia) and abnormal proportions of LDL and HDL are associated with cardiovascular disease through the development of atheroma in arteries (atherosclerosis) [8]. This disease process leads to myocardial infarction (heart attack), stroke, and peripheral vascular disease. As high LDL contributes to this process, it is termed as “bad cholesterol,” while high levels of HDL (“good cholesterol”) offer a degree of protection. The balance can be redressed with exercise, healthy diet, and medications [7,9].

Cholesterol contents of foods have been reported in numerous publications. The U.S. Department of Agriculture Handbook No. 8 (10 and later versions), *Composition of Foods: Raw, Processed, Prepared, Serves* as the basic reference on food composition. The cholesterol contents of various foods are listed in Table 10.1. Cholesterol occurs naturally in foods of animal origin. The highest concentrations are found in brain, liver, and egg yolk, but red meats, poultry (especially the skin), whole milk, and cheese make significant contributions to the diet [7].

Accurate determination of cholesterol in various foods is important for two reasons. First, the influence of diet on blood lipids and the health concern over the role of excess plasma cholesterol in atherosclerosis [11]. This is based on the fact that high-dietary cholesterol is directly related to the elevation in blood cholesterol, which in turn has shown to increase the incidence of coronary heart disease in humans [12,13]. This situation emphasizes the importance of the determination of cholesterol in foods of animal origin, including meat, eggs, milk, and their products.

Second, accurate cholesterol assays in foods are necessary for regulatory aspects of food labeling [14]. Nutrition plays an important role in determining the capacity of the body to adapt to stress and ward off diseases [15]. Knowledge of the nutrient composition, such as cholesterol contents, of foods is only one of the many factors involved in attaining optimum human nutrition [16].

## 10.2 Analytical Methods for the Determination of Cholesterol

Determination of sterols in dairy products may be focused on three main objectives, namely, measuring the total cholesterol content of the product to obtain the nutritional information, detecting the presence of vegetable fats, and quantitating specific phytosterols added as tracers to cream and butter [17].

Determination of sterols in dairy products including milk and cheese is more complex, because the analysis should be preceded by fat extraction [17]. Sterols are polycyclic alcohols having a secondary –OH group at position 3, and the presence of this group makes the sterols more polar than triglycerides. In addition, as cholesterol, both free (90%) and esterified, is one of the constituents of the fat globule membrane in milk fat [18], particular care is necessary during fat extraction from dairy products to recover the whole sterol fraction.

**Table 10.1 Cholesterol Contents of Foods**

<i>Food</i>	<i>Cholesterol (mg/100 g)</i>	<i>Food</i>	<i>Cholesterol (mg/100 g)</i>
Beef, raw	70	Kidney, raw	375
Butter	250	Lamb, raw	70
Cheese:		Lard and other:	
Cheddar	100	Animal fat	95
Cottage, creamed	15	Liver, raw	300
Cream	120	Lobster	200
Other (25–30% fat)	85	Margarine:	
Cheese, spread	65	All vegetable fat	0
Chicken, raw	60	Two-thirds animal	
Crab meat	125	Fat, one-third	
Egg, whole	550	Vegetable fat	65
Egg, white:	0	Milk:	
Fresh	1500	Fluid, whole	11
Frozen	1280	Dried, whole	85
Dried	2950	Mutton	65
Fish, steak, or fillet	0	Pork	70
Heart, raw	150	Shrimp	125
Ice cream	45	Veal	90

*Source:* Watt, B.K. and Merrill, A.L., *Composition of Foods—Raw, Processed, Prepared*, U.S. Department of Agriculture, Agriculture Handbook No. 8, December, 1963.

Most cholesterol assay methods are based on the initial lipid extraction, usually performed using diethyl ether or chloroform–methanol mixtures as solvents, followed by saponification of the polar fraction, and colorimetric, enzymatic, or instrumental quantification. Reported methods for cholesterol determination include gas chromatography–thin-layer chromatography (GC–TLC–FID) [19–21], GC–FID [22–24], gas chromatography/mass spectrometer (GC–MS) [25], high-performance liquid chromatography (HPLC) [14,20,21,26–28], colorimetric method [29–32], enzymatic method [33,34], and supercritical fluid chromatography (SFC) [35]. Mid-infrared (MIR) spectroscopy with Michaelson interferometry, known as Fourier transform infrared (FTIR) spectroscopy and Fourier transform near-infrared (FT-NIR) spectroscopy, have been used for the analysis of cholesterol in several foods [36–39]. Recently, molecularly imprinted solid-phase extraction technique has been used for cholesterol determination in cheese products [40]. A variety of methods may exist for the quantification of cholesterol in various foods. However,

consulting proper and most-recently updated analytical methodologies would be essential to adapt less laborious, less time consuming, more convenient, precise, and accurate methods for assaying cholesterol of dairy products.

### **10.2.1 Association of Official Analytical Chemists (AOAC) Method (Adapted from AOAC, 16th Edition, 1996; No. 994.10 [20])**

#### A. Principle

Lipid extract from a sample is saponified at high temperature (around 80°C) with ethanolic KOH solution. Toluene is used to extract unsaponifiable fraction containing cholesterol and other sterols. Sterols from the unsaponifiable fraction are derivatized to trimethylsilyl (TMS) ethers and their concentrations are quantified by GC.

#### B. Apparatus

- a. Magnetic stirrer-hot plate, equipped with variable speed and heat controls.
- b. Micropipettes capable of delivering 100 and 200  $\mu\text{L}$ ; metal body.
- c. Test tube mixer.
- d. Analytical balance capable of weighing up to 0.0001 g.
- e. Glassware—Erlenmeyer flasks, 125 and 250 mL; volumetric flasks and pipettes; graduated cylinders; separatory funnels, 500 mL.
- f. Rotary evaporator—with glass condenser flask between concentration flask and metal shaft.
- g. Centrifuge tubes of 15 mL size, Pyrex No. 13. Procedures for silanization of the centrifuge tubes are as follows: the tubes are filled with 10% hydrofluoric acid and left to stand for 10 min. Subsequently, the tubes are rinsed thoroughly with  $\text{H}_2\text{O}$ , and then with anhydrous methanol. The tubes are dried under stream of nitrogen. Then, the tubes are filled with 10% hexamethyl disilane (HMDS) in toluene and left to stand for 1 h. After that, the tubes are rinsed thoroughly with toluene, and then with anhydrous methanol. The tubes are dried at 100°C in an oven before use. Alternatively, commercial silinizing reagent may be used. Before each reuse, the tubes should be cleaned with  $\text{H}_2\text{O}$ , ethanol, hexane, and acetone, and dried at 100°C in an oven. The tubes can be reused without resilylation if strong alkali wash is avoided. However, the tubes should be resilanized at least every 6 months.
- h. GC—Equipped with FID, capillary column, split-mode, 25 m, 0.32 mm, and 0.17  $\mu\text{m}$  film thickness, cross-linked 5% phenyl-methyl silicone or methyl silicone gum, split inlet liner filled with 10% SP 2100 on 80–100 mesh Supelco packing, and 2 ramp oven temperature programming. Operating conditions: temperatures—injector, 250°C; detector, 300°C; column, 190°C; hold, 2 min; increase, 20°C/min to 230°C; hold, 3 min; increase, 40°C/min to 255°C; hold, 25 min. Flow rates: helium—column, ca. 2 mL/min; split vent, ca. 30 mL/min; purge vent, ca. 3 mL/min; auxiliary make-up gas, ca. 20 mL/min; hydrogen, ca. 35 mL/min; and air, ca. 280 mL/min.

#### C. Reagents

- a. HMDS.
- b. Dimethylformamide (DMF)—distilled in glass.
- c. Trimethylchlorosilane (TMCS).
- d. Toluene—distilled in glass.
- e. Sodium sulfate—anhydrous.

- f. Glass wool.
- g.  $5\alpha$ -Cholestane internal standard solution—0.1 mg/mL standard  $5\alpha$ -cholestane in *n*-heptane.
- h. Cholesterol standard—Make the stock and working solutions as follows: (1) Stock solution—2.0 mg/mL DMF. (2) Working solutions—Dilute stock solution with DMF to obtain six solutions at concentrations of 0.0025–0.2 mg/mL (i.e., 0.0025, 0.005, 0.01, 0.05, 0.1, and 0.2 mg/mL).
- i. 50%, 1 N and 0.5 N KOH solutions—(1) 50% KOH (w/w)—dissolve 500 g of KOH in 500 g of  $H_2O$ . (2) 1 N KOH—dissolve 56 g of KOH in ca. 800 mL of  $H_2O$  at low temperature and dilute to mark in 1 L volumetric flask. (3) 0.5 N KOH—dilute 1 part 1 N KOH solution with 1 part  $H_2O$ .

#### D. Saponification

Two to three grams of the test sample ( $W_1$ ) is accurately weighed to the nearest 0.001 g into 250 mL Erlenmeyer flask. The amount of sample should contain 1 g of fat or 5 g of  $H_2O$  (i.e., 1 g of pure oils, 1.5 g of salad dressings, and 5 g of substances with high moisture content). A magnetic stir bar is placed into the flask, and 40 mL of 95% ethanol and 8 mL of 50% KOH solution, C(i)(1) are added to the flask (*Note*: Portion of ethanol may be retained and used as rinse after KOH addition. This will help to prevent the ground-glass joints of the flask and condenser from freezing together).

The flask is put on the magnetic stirrer-hot plate, the condenser is attached, the stir-hot plate is turned on, and reflux  $70\pm 10$  min. Complete saponification can be ensured by occasional checking of the sample and any clumps should be dispersed with glass rod or by adding KOH solution to the sample while stirring.

While continuously stirring the solution, heating is stopped and 60 mL of 95% ethanol is added through the top of the condenser. (Caution: Add carefully to avoid spurting of alcohol from the top of the condenser.) The flask is removed from the condenser after 15 min, closed with a stopper, and the solution is cooled to room temperature. The sample is observed to remain stable for 24 h.

#### E. Extraction

About 100 mL of toluene ( $V_1$ ) is added to the saponified sample while stirring. The flask is stoppered and stirred for 30 s. The solution is poured into 500 mL separatory funnel without rinsing. Subsequently, 110 mL of 1 N KOH solution, C(i)(2), is added, and the funnel is shaken vigorously for 10 s. The layers are allowed to separate and the aqueous (lower) layer (will be turbid) is discarded. About 40 mL of 0.5 N KOH solution, C(i)(3), is added to the separatory funnel, and the funnel is inverted and the contents are gently swirled for 10 s. The aqueous (lower) layer is discarded.

About 40 mL of  $H_2O$  is added to wash the toluene layer, by gently rotating the separatory funnel. The layers are allowed to separate and the aqueous phase is discarded. The  $H_2O$  washes are repeated at least thrice, by shaking more vigorously each time. If emulsification occurs, small amount 95% ethanol is added, the contents of the funnel are swirled, the layers are let to separate, and  $H_2O$  washes are continued. The toluene layer should be crystal clear after the final wash.

The toluene layer is poured from the top of the separatory funnel through the glass funnel containing plug of glass wool and about 20 g of  $Na_2SO_4$  into 125 mL Erlenmeyer flask containing about 2 g of  $Na_2SO_4$ . The flasks are stoppered and the contents are swirled. The mixture was let to stand for 15 min. The sample extracts may remain stable for 24 h if tightly sealed.

About 25 mL of the extract ( $V_2$ ) is pipetted into 125 g flat-bottom boiling flask and the contents are evaporated to dryness on the rotary evaporator at  $40 \pm 3^\circ\text{C}$ . About 3 mL of acetone is added and the contents are evaporated to dryness again. The residue is dissolved in 3.0 mL of DMF ( $V_3$ ), C(b). The final concentration of cholesterol in DMF should be within the range of working standard solutions, C(h)(2).

*Note:* After quantitation by GC, if the test portion concentration falls outside the standard curve, then change the amount of toluene extract evaporated or volume of DMF used to dissolve the residue, or both, so that the final concentration of cholesterol in DMF falls within the range of the standards. If the sample contains little or no cholesterol, then 75 mL of toluene extract, dried and redissolved in 2 mL of DMF, is adequate to detect 1 mg of cholesterol/100 g in 1 g of the sample.

#### F. Derivatization

One milliliter (1.0 mL) of aliquots of working standard solutions, C(h)(2), and the test solution are pipetted into separate 15 mL centrifuge tubes, B(g). About 0.2 mL of HMDS, C(a), and 0.1 mL of TMCS, C(c), are added to each tube. The tubes are stoppered and shaken vigorously on the test-tube mixer or by hand for 30 s. The solution is left undisturbed for 15 min. Subsequently, 1.0 mL of  $5\alpha$ -cholestane internal standard solution, C(g), and 10 mL of  $\text{H}_2\text{O}$  are added to each tube. The tubes are stoppered, shaken vigorously for 30 s, and centrifuged for about 2 min.

Sufficient portion of heptane (upper) layer is transferred to the injection vial, but the aqueous layer should not be transferred. The standards and samples are derivatized and must be analyzed within 24 h.

#### G. GC analysis

One  $\mu\text{L}$  or other appropriate volume is injected into GC. The areas of  $5\alpha$ -cholestane and cholesterol peaks are determined using height–width measurement or digital integrator. (*Note:*  $5\alpha$ -Cholestane and cholesterol should elute in 11–13 and 16–18 min, respectively. If these retention times are not met, then the carrier gas flow and temperature should be adjusted.)

The cholesterol peak area is divided by the internal standard peak area to obtain the standard response ratio. Response ratios of four high standards (0.01–0.20 mg/mL) are plotted against the cholesterol concentrations. The standard response ratio plot should bracket the sample response ratio. If necessary, low standard curve (0.0025–0.05 mg/mL) is plotted for low-level test samples. The dilute high-level test sample should fall within the standard range.

The calculation for  $g$  of sample/mL derivatized is as follows:

$$g \text{ sample/mL derivatized} = (W_1/V_1)(V_2/V_3)$$

where

$W_1$  is the weight of the sample, g

$V_1$  is the volume of toluene used in extraction, 100 mL

$V_2$  is the aliquot of extract brought to dryness, 25 mL

$V_3$  is the volume of DMF used to dissolve residue, 3 mL

The cholesterol content in the test sample is calculated as follows [41]:

$$\begin{aligned} & \text{mg cholesterol/100 g test sample} \\ &= \left( \frac{\text{mg/mL cholesterol in sample from}}{\text{standard curve 100}} \right) / (\text{g sample/mL derivatized}) \end{aligned}$$

### 10.2.2 Federation Internationale de Laiterie – International Dairy Federation (FIL-IDF) Method (IDF Standard 159:1992) [19]

#### A. Principle

The principle of cholesterol assay method of IDF is similar to that of AOAC. However, the IDF method uses betulin as the suitable standard for unsaponifiable sterols, while AOAC uses 5 $\alpha$ -cholestane as the internal standard. Saponification with methanolic KOH and solvent extraction of the unsaponifiable matter by thin-layer chromatography are performed. Another difference is that the sterols are derivatized to silyl derivatives in IDF method, whereas they are derivatized to TMS ethers in AOAC method. The sterols are determined by gas–liquid chromatography.

#### B. Saponification

Using a pipette, a suitable volume of standard solution (e.g., 10 mL of standard solution containing 0.6 mg of betulin/mL di-isopropylether) and 100 mL of methanolic KOH (2 mol KOH/L methanol) are added to the test sample. It is fitted to the reflux condenser and boiled gently on the water bath for approximately 1 h. The extraction of the unsaponifiable matter is then performed using diethyl ether.

For the sterol separation from the unsaponifiable matter, TLC plates (20  $\times$  20 cm silica gel 60 F<sub>254</sub>), previously activated at 100°C for 30 min, are used. The sterol fraction is silylated with 0.2 mL of pyridine dried GR and 0.2 mL of Sylon BFT (BSTFA + TMCS, 99:1) at 70°C for 30 min. The silylating agents are then removed under N<sub>2</sub> flow.

#### C. Determination

*On-column injection (manual system):* The sterol fraction converted to silyl derivatives is dissolved in 10 mL of hexane, and 1  $\mu$ L of the solution is injected in a GC equipped with an FID. An HP5 (5% phenyl, 95% methylpolysiloxane) column, 30 m  $\times$  0.32 mm i.d.  $\times$  0.25  $\mu$ m of film thickness or fused silica SE54 (5% phenyl, 95% methylpolysiloxane) column, 25 m  $\times$  0.32 mm i.d.  $\times$  0.12  $\mu$ m of film thickness, is used under the following GC conditions: initial temperature of 60°C, maintained for 2 min, raised at a rate of 40°C/min to 250°C, maintained at this temperature for 15 min and then raised at a rate of 6°C/min to 320°C; detector temperature is 330°C; carrier gas used is H<sub>2</sub> at a flow of 2 mL/min. For sterol identification, standard solutions of phytosterols are analyzed under the same conditions to compare the retention times.

*Split injection (manual system):* The sterol fraction is dissolved in 0.3 mL of hexane. A HP5 or fused silica OV17 or equivalent (7% cyanopropyl, 7% phenyl, 85% methyl, and 1% vinylpolysiloxane) column, 25 m  $\times$  0.22 mm i.d.  $\times$  0.12  $\mu$ m of film thickness, are used in a GC equipped with an FID. The GC conditions adapted are: initial temperature of 280°C, maintained for 10 min, raised at a rate of 4°C/min to 310°C, maintained for 15 min. The carrier gas used is H<sub>2</sub> at 2 mL/min, the split ratio is 1:50, and the injector and detector temperature is set at 330°C.

*Response factor and calculation:* The response factor, cholesterol/betulin, must be calculated for the quantitative determination of cholesterol. A standard solution of cholesterol and betulin (1:1) is prepared by mixing 1 mL of the following solutions: cholesterol (1 mg/mL *n*-hexane) and betulin (1 mg/mL di-isopropyl ether). After evaporation, it is silylated, and then injected to a GC under the same conditions selected for the samples. The equations for the response factor and calculation are as follows:

$$R_{\text{col}} = \left[ \text{cholesterol concentration (mg/mL)} \right] \times \left[ \text{peak area of betulin} \right] \\ \times \left[ \text{peak area of cholesterol} \right] \times \left[ \text{betulin concentration (mg/mL)} \right]$$

Calculation:

$$\text{concentration} = \frac{m_{\text{bet}} \times A_{\text{chol}} \times R_{\text{col}} \times 100}{A_{\text{bet}} \times m_s}$$

where

$m_{\text{bet}}$  is the mass, in mg, of betulin added to the test portion

$A_{\text{col}}$  is the area of the cholesterol peak

$R_{\text{chol}}$  is the response factor of cholesterol

$A_{\text{bet}}$  is the area of the betulin peak

$m_s$  is the mass, ingredient, of the test sample

In this method, all the sterols (cholesterol, campesterol, stigmasterol,  $\beta$ -sterol, and betulin) are determined by GC method. The FIL-IDF method has an excellent accuracy, ranging from 99.3% to 105.9%.

### 10.2.3 Capillary Gas Chromatographic Method with Direct Saponification [24]

#### A. Equipment, apparatus, and materials required

The equipment, apparatus, and materials used for this method are as follows: a capillary column GC system equipped with an FID, an automatic sampler, and a chromatography data system are used. A temperature regulated water bath, a vortex mixer, a centrifuge, a magnetic stirrer plate, solvent dispensers, and sample preparation tubes (16 × 12.5 mm, with teflon-lined screw caps) are used. The reagents used include hexane, methanol, KOH, and cholesterol, with a GC-grade standard.

#### B. Preparation of saponification solution and cholesterol standards

For saponification solution, a 0.5 M methanolic KOH solution is prepared by dissolving 14 g of KOH in methanol on a magnetic stirrer plate and diluting to 500 mL volume with the solvent.

For cholesterol standards, the stock solution and working solution are prepared. The stock solution (2 mg/mL) is made by dissolving 20 mg of cholesterol in a flask containing 10 mL of hexane. The working solutions are prepared by appropriately diluting aliquots from the stock solution with hexane to obtain the solutions in the range of 10–80  $\mu\text{g/mL}$ .

#### C. Sample preparation

Directly saponified cholesterol extracts from the experimental samples are prepared as follows: a 0.2 g of experimental samples of the dairy products (milk, yogurt, butter, ice cream, or well-ground cheese) is accurately weighed in a sample preparation tube, to which 5 mL of methanolic KOH solution is also added. The tube is capped tightly, and its contents are vortexed for 15 s. The lower half of the tube is then immersed in an 80°C bath for 15 min, removing the tube every 5 min to vortex for 10 s. Several tubes could be handled conveniently by placing them in a wire basket. Following heating, the tube is cooled with tap water, 1 mL of water and 5 mL of hexane are added, and the contents are vortexed vigorously for 1 min and then centrifuged for 1 min at 2000 ×  $g$ . An aliquot of the upper phase is transferred into the autosampler vial for GC analysis.

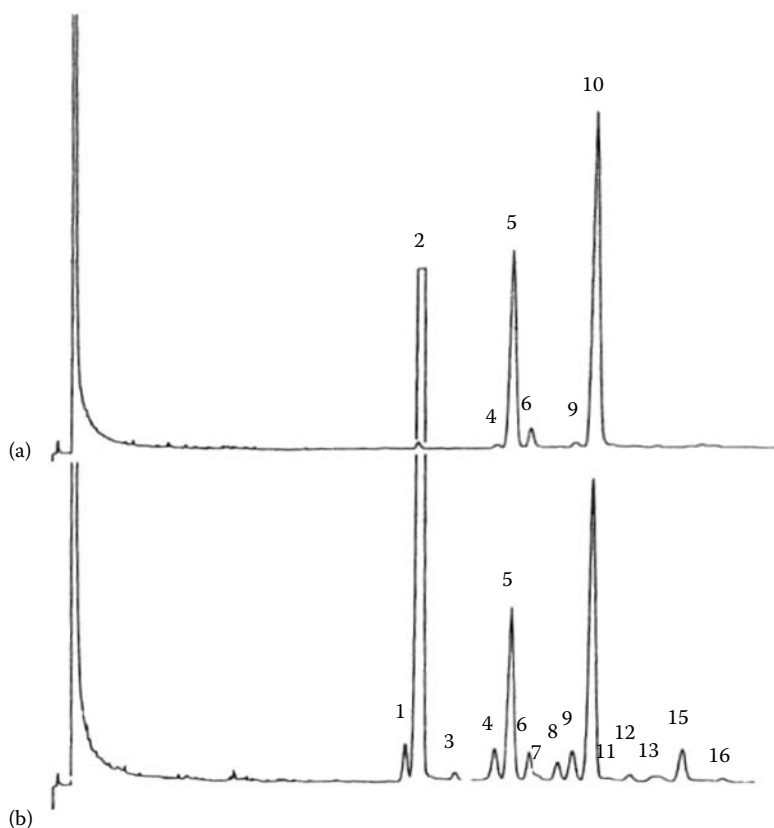


## D. GC conditions

The GC is equipped with a fused silica capillary column (15 m × 0.32 mm id × 1.0 μm film thickness) coated with SPB-1 and FID. The oven temperature is set at 285°C, injection port temperature at 300°C, and detector temperature at 300°C. The flow rates are 2 mL/min for helium, 30 mL/min for hydrogen, and 300 mL/min for air. The injection volume is 1 μL with a split ratio of 20:1. The typical chromatograms of GC elution profiles for sterol moieties of total steryl esters are shown in Figure 10.2 [42].

## E. Determination of cholesterol contents

The cholesterol calibration curve is constructed by injecting 1 μL of each standard working solution, and plotting the recorded peak area versus the corresponding mass of the analyte injected.



**Figure 10.2** GC elution profile of sterol moieties of total steryl esters. (a) Common dietary plant sterols. (b) Plasma steryl esters from a patient with phyto-sterolemia. Peak identification: 1, cholestanol; 2, cholesterol; 3, brassicasterol; 4, campestanol; 5, campesterol; 6, stigmasterol; 7, unknown; 8, 24-methylenecholesterol; 9, stigmasterol; 10, β-sitosterol; 11–14, unknown; 15, avenasterol; and 16, unknown. Operating conditions, Supelcowax 10 on flexible quartz capillary column (15 m × 0.32 mm i.d.); temperature, 250°C isothermal; carrier gas, H<sub>2</sub>, 5 psi inlet pressure; and sample, sterylacetates. (Adapted from Ong, C.P. et al., *J. Chromatogr.*, 515, 509, 1990; Wilson, R.H., *Trends Anal. Chem.*, 9, 127, 1990.)

The slope, intercept, and least-squared fit of the standard curve are computed. The data for the slope and intercept of the calibration curve are used to compute the mass of the analyte in the unknown sample extracts (1  $\mu\text{L}$ ) that are injected. The concentration,  $C$  (mg/100 g) of cholesterol in the analyzed samples is calculated according to the following equation:

$$C = M \times V \times 2.5$$

where

$M$  is the computed mass (nanograms) of the analyte in the injected extract (1  $\mu\text{L}$ )

$V$  is the dilution factor, if any, that was applied

The overall recovery and precision of this method is 98.6% and 1.4%, respectively. Fletouris et al. [24] reported the cholesterol contents of selected milk and milk products analyzed by capillary GC with direct saponification (Table 10.2).

## 10.2.4 High-Performance Liquid Chromatography Method

### 10.2.4.1 Method 1 [14]

#### A. Solvents and standards

The solvents needed are HPLC-grade hexane and isopropanol. Petroleum ether (bp 30°C–60°C) is used as received. The diethyl ether should not have ethanol preservative and must be peroxide free. The 2.0N methanolic KOH is prepared daily, and 10% NaCl (v/v) is prepared whenever needed. The liquid scintillation cocktail was purchased to ensure compatibility with the solvents in the evaluation method. The [ $4\text{-}^{14}\text{C}$ ] cholesterol (0.02 mCi/mL) is obtained, and the cholesterol standard is prepared at a concentration of 0.1  $\mu\text{g}/\mu\text{L}$  in HPLC mobile phase.

#### B. HPLC analysis

*HPLC system used:* The HPLC system used consists of the solvent delivery system, an injector, a C-18 column, and a variable wavelength detector at 205 nm. The HPLC mobile phase is hexane/IPA (99.9/0.1, v/v) flowing at 2.0 mL/min).

*Analytical procedure:* The following chemical and analytical procedures are performed for HPLC analysis: 1 g of milk powder (or 1 mL of liquid) is added to a 250 mL round bottom flask, and dispersed with methanol to prevent clumping. About 50 mL of freshly prepared 2.0N KOH/ $\text{CH}_3\text{OH}$  is added, and the sample is refluxed for 30 min. The solution is transferred while it is warm, to a 250 mL separatory funnel. The round bottom flask is washed with two 25 mL portions of water, and these also are added to the separatory funnel. This solution is cooled to room temperature, and 10 mL of 10% NaCl is added. The resulting solution is partitioned twice with two 100 mL portions of 1:1 diethyl ether/petroleum ether. The ether phases are collected, evaporated to dryness, and diluted to 50 mL with petroleum ether. Subsequently, 10 mL is withdrawn and run through a silica Sep-pak<sup>TM</sup>. The Sep-pak is washed with 10 mL of 7/93 (v/v) diethyl/petroleum ether, and the cholesterol containing fraction is eluted with 10 mL of 75/25 (v/v) diethyl/petroleum ether. The use of the Sep-pak alleviates the necessity for preextraction of the lipid, and allows the elimination of interfering compounds prior to analysis. Elimination of a preextraction step is a definite advantage. The cholesterol fraction is evaporated to dryness and brought to a volume in HPLC mobile phase. The precision and recovery of the method are 2.0%–2.8% and 99.0%–106.2%, respectively (Table 10.3).

**Table 10.2 Cholesterol Contents of Selected Milk and Milk Products**

Type of Product	Source of Product	Replicates	Cholesterol (mg/100g)	
			Mean	SD
Bovine milk	Greece	3	12.2	0.18
Yogurt from bovine milk	Greece	3	12.4	0.21
Strain yogurt from bovine milk	Greece	3	33.6	0.57
Ovine milk	Greece	3	21.7	0.32
Yogurt from ovine milk	Greece	3	30.1	0.54
Caprine milk	Greece	3	14.4	0.22
Butter	Greece	3	228.1	4.36
Ice cream	Greece	3	46.7	0.72
Anthotyros cheese	Greece	3	80.6	1.03
Dry myzithra cheese	Greece	3	106.8	2.01
Manouri cheese	Greece	3	143.3	2.62
Teleme cheese	Greece	3	61.9	1.11
Feta cheese	Greece	3	68.1	1.18
Teleme imitation cheese	Greece	3	8.3	0.20
Kaseri cheese	Greece	3	86.2	1.83
Kephalotyri cheese	Greece	3	85.7	1.41
Romano cheese	Italy	3	89.3	1.66
Provolone cheese	Italy	3	75.9	1.38
Mozzarella cheese	Italy	3	71.4	1.41
Cheddar cheese	England	3	101.2	2.12
Graviera cheese	Greece	3	97.9	1.85
Regato cheese	Ireland	3	85.6	1.07
Emmental cheese	Switzerland	3	85.7	1.32
Edam cheese	Holland	3	82.9	1.17
Gouda cheese	Holland	3	88.1	0.93
Parmesan cheese	Italy	3	92.6	1.56
Camembert cheese	France	3	73.8	1.52
Blue cheese	Denmark	3	92.1	2.18

Source: Adapted from Fletouris, D.J. et al., *J. Dairy Sci.*, 81, 2833, 1998.

**Table 10.3 Recovery of Cholesterol from a Whole Milk Powder by HPLC Method**

<i>Amount Added (mg)</i>	<i>Amount Recovered<sup>a</sup> (mg)</i>	<i>Percent Recovery (%)</i>
0	0.96	—
1.0	1.94	99.0
3.0	4.02	102.0
5.0	6.26	106.2

Source: Adapted from Hurst, W.J. et al., *J. Dairy Sci.*, 66, 2192, 1983.

<sup>a</sup>  $n = 2$ .

#### 10.2.4.2 Method 2 [26]

Butter samples are dissolved in 10 mL of 96% ethanol and then saponified with 2 mL of KOH (50%, w/v). The samples are extracted with 50 mL of hexane–diethyl ether (1:1, v/v). After drying by rotary evaporator, 10 mL of the mobile phase (7% 2-propanol in hexane) for HPLC analysis is added. This method, like the other HPLC method, does not allow the differentiation of phytosterols from cholesterol, because their peaks present the same retention time. Thereby, the procedure can be used to quantify cholesterol in products containing animal fats or to measure the total sterols in food containing animal and vegetable fat.

#### 10.2.4.3 Method 3 [27]

It is an improved HPLC method for the cholesterol determination in egg yolk. Egg yolk is first diluted. After saponification, cholesterol is extracted with DE and petroleum ether, and quantified by reverse-phase chromatography on a Zorbox ODS column (0.46 × 15 cm, 5–6f. L11 L) using a mobile phase of acetonitrile and 2-propanol (4:1) with a flow rate of 0.6 mL/min. The average recovery is 98.9%, and the detection limit is 0.02 mg/mL. However, no differences in the cholesterol concentration could be observed between egg yolk samples with and without saponification. Rapid and reproducible quantification of cholesterol in egg yolk can be achieved with this simplified method. A HPLC method without saponification can be used to determine the cholesterol content in egg yolk in a much more efficient and convenient manner.

### 10.2.5 Fourier Transformed Infrared and Fourier Transformed Near-Infrared Methods [37,38]

Cholesterol is estimated by FTIR and FT-NIR spectroscopic methods after a single-step extraction, instead of the conventional colorimetric method.

#### 10.2.5.1 Fourier Transformed Infrared Method

A spectrometer equipped with a deuterated triglycine sulfate (DTGS) detector is used for FTIR analysis. The sampling station is equipped with an overhead attenuated total reflectance (ATR) accessory comprising transfer optics within the chamber, through which infrared radiation is directed to a detachable ATR zinc selenide crystal, mounted in a shallow trough for sample containment.

The spectrum of pure chloroform is used as the reference or background, and pure cholesterol powder or cholesterol extract from milk products is dissolved in chloroform and used for FTIR analysis. Single beam spectra ( $4000\text{--}400\text{ cm}^{-1}$ ) of the samples are obtained, and corrected against the background spectrum of chloroform, to present the spectra in absorbance units at a resolution of  $16\text{ cm}^{-1}$ . The ATR crystal is carefully cleaned with pure chloroform to eliminate the presence of cholesterol residues between the measurements, and dried using nitrogen gas after each experiment to ensure a clean crystal surface to obtain the best possible sample spectra. The crystal is sealed with a lid to minimize the evaporation of solvents from the sample.

### 10.2.5.2 *Fourier Transformed Near-Infrared Method*

#### A. General principle

A spectrometer equipped with a DTGS detector is used for FT-NIR analysis. The sampling station is equipped with a transmission cell from Spectra-Tech (CT). The instrument uses white light as a source and the sample is read from a quartz cuvette. A total of 256 coadded scans are collected for each sample at a resolution of  $16\text{ cm}^{-1}$ . The spectra is collected in the range between  $2000$  and  $8000\text{ cm}^{-1}$ , corrected against the background spectrum of chloroform, and presented in absorbance units. The quartz cuvette is covered with a lid during spectra measurement, cleaned with pure chloroform after successive measurement, and dried using nitrogen gas to ensure the best possible sample spectra.

#### B. Preparation of calibration and validation models

Stock solution of  $2\text{ g}/100\text{ mL}$  is prepared by dissolving pure cholesterol powder in chloroform. This solution is further used to prepare standard cholesterol solutions with appropriate dilutions. The final concentration of cholesterol is observed to be in the range between  $0$  and  $20\text{ mg/mL}$ . The cholesterol-content range considered is observed to be consistent with the cholesterol content of the samples analyzed. Eleven different concentrations from the abovementioned range (with increments of  $2\text{ mg/mL}$ ) are used for calibration, and three are used for validation.

#### C. Analytical procedure

A  $1.5\text{--}2.5\text{ g}$  of homogenized food sample is placed in a test tube for further processing and preparation. The fat-rich food such as butter must be prepared for reduced weight as ca.  $0.2\text{ g}$ . About  $9\text{ mL}$  of ethanol and  $1\text{ mL}$  of KOH solution ( $50\text{ g}/100\text{ mL}$ ) are added and vortex mixed for  $20\text{ s}$ . The capped tube is then placed in a water bath at  $60^\circ\text{C}$ , saponified for  $1\text{ h}$ , and stirred continuously at  $200\text{ rpm}$ . After cooling to room temperature,  $5\text{ mL}$  of deionized water and  $10\text{ mL}$  of hexane are added, then vortex mixed for about  $2\text{ min}$ . The sample is then centrifuged for  $3\text{ min}$  at  $2000\text{ rpm}$ , and the upper hexane layer is pipetted into a clean tube. Another  $10\text{ mL}$  of hexane is added to the water phase, and then the extraction and the centrifugation steps are repeated. The combined hexane extract is then used for cholesterol assay. The hexane extract is evaporated to dryness and the sample is redissolved in  $5\text{ mL}$  of chloroform and used for FTIR and FT-NIR analysis.

## 10.2.6 *Spectrometric (Colorimetric) Methods*

### 10.2.6.1 *Colorimetric Method 1 [30]*

#### A. Chemicals and reagents

All the solvents must be reagent grade from commercial suppliers. Cholesterol standard is made to  $1\text{ mg/mL}$  in ethanol. *o*-Phthalaldehyde, a working solution with a concentration of  $50\text{ mg/dL}$  in

glacial acetic acid, is freshly prepared on the day of use. A stock solution of  $\text{FeCl}_3$  is prepared by dissolving 840 mg of  $\text{FeCl}_3 \cdot 6\text{H}_2\text{O}$  in 100 mL of glacial acetic acid. A working solution is prepared by making a 1:100 dilution of the stock solution, prepared 1 day prior to use and is observed to remain stable for several months.

#### B. Procedure

Lipids are extracted with chloroform–methanol, 2:1, and portions of the extract are taken for saponification and determination of total cholesterol by the *o*-phthalaldehyde method. Free cholesterol and cholesteryl esters are separated by TLC on prewashed silica gel G in a developing solvent of hexane–ethyl ether–glacial acetic acid (70:30:1).

In a typical cholesterol assay, 0.1 mL of plasma or serum, 0.3 mL of 33% (w/v) KOH, and 3 mL of 95% ethanol are placed in a glass-stoppered tube and mixed thoroughly. The tube is then stoppered and placed in a 60°C heating block for 15 min. After cooling the mixture, 10 mL of hexane is forcefully added to the tube to mix with the lower layer. About 3 mL of distilled water is added, and the tube is capped and shaken for 1 min to ensure complete mixing. A blank, a standard, and a sample of pooled plasma are saponified and extracted at the same time. Appropriate aliquots (usually 1 mL) of the hexane layer are pipetted in duplicate into the colorimeter tubes, and the solvent is evaporated under nitrogen. About 2 mL of the *o*-phthalaldehyde reagent is added to each tube, and the solution is thoroughly mixed to dissolve all the samples. About 10 min after the addition of the *o*-phthalaldehyde reagent, 1 mL of concentrated  $\text{H}_2\text{SO}_4$  is carefully added by allowing it to run down the inside of the tube; the solutions are immediately mixed on a tube vibrator. Absorbance is read at 550 nm between 10 and 90 min after the addition of concentrated  $\text{H}_2\text{SO}_4$ .

In the ferric chloride procedure, 1.5 mL of  $\text{FeCl}_3$  working solution is added to the tube containing the sample, and after thorough mixing, the solution is allowed to stand for 10 min. Then, 1 mL of concentrated  $\text{H}_2\text{SO}_4$  is added and the solution is mixed and placed in the dark. Absorbance at 560 nm is determined 45 min later. When the *o*-phthalaldehyde procedure is compared with the  $\text{FeCl}_3$  method, separate portions of the same hexane layer are taken for the assay by both color reactions.

### 10.2.6.2 Colorimetric Method 2 [31]

#### A. Apparatus and reagents

- Centrifuge tubes—15 mL, with Teflon-lined screw caps.
- Spectrophotometer—Spectronic 20, or its equivalent.
- o*-Phthalaldehyde reagent—Dissolve 50 mg in 100 mL of glacial acetic acid; prepare fresh daily.
- Cholesterol standard solution—Dissolve 0.1 mg of cholesterol/mL 95% ethanol.

#### B. Preparation of standard curve

Duplicate aliquots of 1.25, 1.00, 0.75, 0.50, and 0.25 mL of cholesterol standard solution are pipetted into small tubes. The solution is diluted to 3 mL with ethanol, saponified, and extracted with 5 mL of hexane as indicated under cholesterol assay. About 4 mL of hexane is removed, evaporated, and allowed to develop a color as indicated, to obtain absorbance measurements for 100, 80, 60, 40, and 20  $\mu\text{g}$  cholesterol, respectively. For absorbance measurements corresponding to 10 and 5  $\mu\text{g}$ , 0.25 mL of standard solution is used and the aliquots of 2 and 1 mL hexane are removed for color development.

### C. Cholesterol assay

Adequate dry or fluid sample (>10 µg cholesterol) is adequately measured in two separate tubes. About 3 mL of 95% ethanol and 2 mL of 50% KOH are added, and mixed thoroughly. The capped tube is placed in 60°C water bath for 15 min. After cooling, 5 mL of hexane is added and mixed thoroughly. About 3 mL of water is added, mixed, and centrifuged until hexane layer is clear. Then, the aliquot of hexane layer (10–100 µg cholesterol) is transferred to the test tube and the solvent is evaporated under nitrogen. Subsequently, 4 mL of *o*-phthalaldehyde reagent is added and mixed thoroughly to dissolve the sample. After 10 min, 2 mL of concentrated H<sub>2</sub>SO<sub>4</sub> is carefully added, allowing the acid to flow down the inner wall of the tube. The tube contents are mixed immediately and the absorbance are read at 550 nm against the reagent blank, 10–90 min after H<sub>2</sub>SO<sub>4</sub> addition. Using standard curve, the concentration of cholesterol in the sample is obtained.

## 10.2.6.3 Colorimetric Method 3 [29,32]

### A. Saponification

When the saponification step is included, a 3 mL aliquot of the lipid extract is freed of solvent using a nitrogen evaporator. The lipid residue is saponified at 80°C (using a waterbath-shaker) for either 15 or 60 min, with 10 mL 12% KOH in 90% ethanol which is prepared fresh each day. When the procedure variation of saponification with antioxidant protection is tested, pyrogallol (3% in the saponification mixture), propyl gallate (3%), or butylated hydroxytoluene (BHT; 12.5%) is incorporated into the saponification mixture. A 5 mL distilled water is added to the mixture after removal from the waterbath, and the solution is cooled to room temperature. The nonsaponifiables are extracted twice with 10 mL hexane each time.

### B. Cholesterol assay

A 4 mL aliquot of the hexane extract (equivalent to 0.03 g of meat) is freed of the solvent under nitrogen, and quantitated for cholesterol using a color reagent of glacial acetic acid–FeSO<sub>4</sub>–H<sub>2</sub>SO<sub>4</sub> [29]. The absorbance of the cooled, colored mixture is read at 490 nm against the reagent blank. To construct a standard curve, 0–200 µg of purified cholesterol is subjected to saponification and color-development steps. The resultant cholesterol concentrations in the final color assay tubes would be 0–40 µg.

For the procedure variation involving no saponification, a 0.6 mL of aliquot of the total lipid extract (equivalent to 0.03 g of meat) is reacted directly with the color reagent, with or without solvent removal. Likewise, the cholesterol standards (0–40 µg/tube) are directly submitted to the color development step to construct a standard curve.

Bohac et al. [32] tested the procedure variations which included: without saponification, (1) without solvent removal prior to color development step or (2) with solvent removal; with saponification for 15 min at 80°C, (3) without antioxidant protection or (4) with antioxidant protection; and with saponification for 60 min at 80°C, (5) without antioxidant protection, or (6) with antioxidant protection. The researchers found that the samples with a large percentage of unsaturated fatty acids yielded higher cholesterol values when lipid extracts were saponified without antioxidant protection than with it.

## 10.2.7 Enzymatic Methods

### 10.2.7.1 Enzymatic Method 1 [33,34]

The enzymatic method is based on the oxidation of free cholesterol to  $\Delta^4$ -cholestenone with the formation of hydrogen peroxide catalyzed by cholesterol oxidase [34]. The colored reaction is

the characteristic of the sterol nucleus, but not of cholesterol alone, whereby enzymatic method is preferred by more than 99% of the analysts [33]. To carry out the correct enzymatic assay, cholesteryl esters present in the lipid extract sample must be first hydrolyzed in the presence of cholesterol esterase, because cholesterol oxidase is only active on cholesterol in the free form. The  $H_2O_2$  formed by the oxidation of cholesterol, finally oxidizes a leukodye (such as triarylimidazole or the system aminophenazone–phenol) to a colored dye in the presence of peroxidase [34]. The density of the dye formed is observed to be proportional to the concentration of cholesterol, which is measured by absorption spectrophotometry.

Free and esterified cholesterol are liberated from their complexes with proteins in a lipid extract sample. However, cholesterol must be liberated from a plasma sample using a nonionic detergent, such as 3 mM sodium cholate in water [34].

Cholesterol concentration can be determined by using ready-to-use slides that are now commercially available. These slides are multilayered elements coated on polyester supports. Barium sulfate as the spreading layer contains a detergent (for plasma samples), cholesterol hydrolase, cholesterol oxidase, peroxidase, the leukodye, and buffered gelatin, respectively, from the top (deposit) to the bottom (support) [34]. Very little amount, such as 10  $\mu$ L drop of the lipid extract (or plasma), is deposited on the top of the slide. The reflectance spectrophotometry at 540 nm (with triarylimidazole as leukodye) is used to measure the density of the dye formed.

In case of the unavailability of such slides, dry mixtures of reagents are commercialized, which must be added with a known amount of distilled water before using. Such a solution (Boehringer) contains [34] the following:

In mmol/L: Tris buffer: 100, pH 7.7

Mg<sup>2+</sup>, 50; 4-amino-phenazone, 1; sodium cholate, phenol, 6; 3,4-dichlorophenol, 4

Fatty alcohol polyglycol ether, 0.6%

In international units/L: cholesterol esterase, 0.4; cholesterol oxidase, 0.25; peroxidase, 0.2

*Procedure for enzymatic method:* For cholesterol determination, 2 mL of Boehringer reagent solution is added to 0.02 mL of the lipid extract (cholesterol concentration <10 g/L) in a spectrophotometer cuvette (1 cm light path). The absorbance is measured after incubation of the mixture at 37°C for 5 min or at room temperature for 10 min. A reference or test cholesterol solution is generally provided to examine the linearity of the absorbance versus the cholesterol concentration.

Rather than using the peroxidase in measuring the hydrogen peroxide formed, the catalase as an enzyme can be used in the other method to form a yellow compound (lutidin) by coupling methyl aldehyde with acetylacetone [34]. The amount of hydrogen peroxide can also be assayed by determining the iodine formed from potassium iodide in the presence of molybdate.

### 10.2.7.2 Enzymatic Method Using Commercial Kit

A commercial test kit for cholesterol analysis can be used. For this purpose, fats or fatty foods are directly saponificated and then extracted by cyclohexane. After drying in a stream of nitrogen, it is redissolved in *n*-hexane and tested [25]. Colorimetric or enzymatic methods may overestimate the actual cholesterol content.

### 10.2.8 Supercritical Fluid Chromatography [34,35,43]

Owing to its high separation efficiency and its applicability to the thermally labile compounds, the applications of SFC have rapidly increased in the recent years [34]. In addition, owing to its



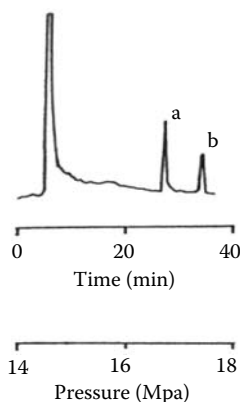
simplicity, efficiency, and selectivity, supercritical fluid extraction (SFE) has also attracted the interest of the researchers.

Carbon dioxide is frequently used as the mobile phase or as the extraction solvent, because of its inert properties in both SFC and SFE. As CO<sub>2</sub> is in a supercritical state at relatively low temperature and low pressure, it is a suitable choice of instrumentation. However, extraction using supercritical carbon dioxide avoids the use of dangerous or toxic organic solvents and the gas is easily removed by reducing the pressure [34].

The SFE method has been used for the extraction as well as SFC in the analysis of cholesterol in food or plasma samples. Ong et al. [35] applied SFE of cholesterol to egg yolk samples, using carbon dioxide at constant pressure (17.7 MPa) and constant temperature (45°C) with an extraction time of 1 h. The extraction efficiency was proven to be as high as with that of the conventional Soxhlet (SOX extraction procedure (~98%), and was less time-consuming (1 h instead of 7 h) [34,35].

Cholesteryl chloroacetate is added before the extraction as a selected internal standard to quantitate cholesterol in the egg yolk samples by SFE. The column used is an SE-52 fused silica capillary column (10 × 100 μm i.d., coating thickness of 0.45 μm) equipped with an FID, and the mobile phase is supercritical carbon dioxide [34,35]. The SFC was carried out isothermally at 85°C using pressure programming for carbon dioxide from 14 to 20 MPa over 60 min [35].

A typical chromatogram obtained from an extracted egg yolk sample is shown in Figure 10.3 [35]. A 0.2 g of egg yolk was used for the extraction, while 0.03 g of the internal standard was added. The two compounds were eluted between 20 and 40 min, and were clearly separated. Peak area reproducibility was within 2% retention reproducibility with 0.15% relative standard deviation. The high sensitivity of the method was demonstrated by the detection limits for both cholesterol and cholesteryl chloroacetate, which were 25 ppm at a signal-to-noise ratio of 3. Capillary SFE coupled to mass spectroscopy was also used for the quantification of cholesterol [43].



**Figure 10.3** SFC of cholesterol from egg yolk extracted by supercritical fluid extraction (SFE). Peak identifications: a, cholesterol; b, cholesteryl chloroacetate as an internal standard. Operating conditions: cholesterol SFE at a constant pressure of carbon dioxide (17.7 MPa) and at 45°C. SFC analysis: column, SE-52 fused silica capillary column (10 × 0.1 mm i.d., coating thickness of 0.45 μm); tapered restrictors rated nominally at 8 mL/min were connected at the column end for pressure reduction; injection valve, 1 μL loop; injection time, 1 s; runs performed isothermally at 85°C and a pressure programmed from 14 to 20 MPa in 60 min. (Adapted from Kuksis, A. et al., *Lipids*, 21, 371, 1986.)

## 10.3 Evaluation of Different Extraction Methods for Analyzing Sterols in Dairy Products

There are different extraction methods for assaying sterols including diethyl ether, Roese Gottlieb (RG), Schmid Bondzynski Ratzlaff (SBR), chloroform/methanol (CM), and SOX methods.

### 10.3.1 Diethyl Ether

Thirty grams of cheese sample, 30 g of anhydrous  $\text{Na}_2\text{SO}_4$ , and 100 mL of DE are mixed in a stomacher bag. The mixture is shook in a mechanical blender for 30 s, and the solvent phase is filtered through anhydrous  $\text{Na}_2\text{SO}_4$ . The extraction is replicated twice more, and the solvent is evaporated under vacuum.

### 10.3.2 Roese Gottlieb

Thirty grams of cheese sample, 15 mL of  $\text{NH}_3$  (25%, v/v), and 50 mL of ethanol (96%, v/v) are mixed. Three extractions are performed with a mixture of diethyl/petroleum ether (1:1) of 250, 150, and 150 mL, respectively. The solvent phase is filtered through anhydrous  $\text{Na}_2\text{SO}_4$  and evaporated under vacuum. This procedure is based on the IDF method used to evaluate the total fat content of milk [44].

### 10.3.3 Schmid Bondzynski Ratzlaff

This method applies the same procedure and reagents similar to the RG, except for  $\text{NH}_3$ , which is substituted by HCl (25%, v/v). This procedure is based on the method used to evaluate the total fat content of cheese [45].

### 10.3.4 Chloroform/Methanol

Thirty grams of cheese sample and 200 mL of CM (2:1) mixture are mixed and maintained under magnetic stirring for 2 h. After filtration, the solvent phase is washed twice with 90 mL of a KCl aqueous solution (0.9%) and 90 mL of distilled water, respectively, filtered through anhydrous  $\text{Na}_2\text{SO}_4$  and evaporated under vacuum [46].

### 10.3.5 Soxhlet

Thirty grams of cheese sample and 15 g of anhydrous  $\text{Na}_2\text{SO}_4$  are mixed and extracted with 250 mL of *n*-pentane for 6 h under reflux in a SOX extractor [47]. The solvent is then evaporated under vacuum.

## 10.4 Comparison of Accuracy and Precision of the Different Methods in Cholesterol Assay

### 10.4.1 Cholesterol Recovery Studies by Paradkar and Irudayaraj [37,38]

The validity and accuracy of the FTIR, FT-NIR, and spectrophotometric methods were conducted for the recovery studies by Paradkar and Irudayaraj [37,38]. Around 1, 5, and 10 mg/100 mL of pure cholesterol were artificially added to milk (3% fat), milk powder, mild Cheddar cheese, grated

cheese powder, yogurt, and butter, and then estimated for cholesterol contents by FTIR and FT-NIR spectroscopy and VIS-spectrophotometric methods. The results, expressed as percentage recovery, are shown in Table 10.4. Accuracy and precision of infrared spectrometric methods is observed to be much better than colorimetric method, but it is more reasonable than chromatographic methods.

**Table 10.4 Recovery (%) Study of Cholesterol Estimation with Phthalaldehyde (Conventional) and FTIR and FT-NIR Methods**

<i>Milk Products</i>	<i>Added Cholesterol (mg/100mL)</i>	<i>% Recovery Phthalaldehyde</i>	<i>FTIR</i>	<i>FT-NIR</i>
Milk	0	—	—	
	1	93.3	105.5	99.2
	5	104.0	102.6	95.6
	10	101.3	107.3	103.8
Yogurt	0	—	—	—
	1	97.8	96.8	88.4
	5	103.1	97.0	95.9
	10	101.4	101.6	101.4
Milk powder	0	—	—	—
	1	106.7	101.0	96.5
	5	101.3	109.4	102.9
	10	104.0	102.6	102.6
Cheddar cheese	0	—	—	—
	1	106.7	97.3	116.5
	5	96.0	110.1	108.0
	10	104.0	101.6	100.9
Cheese powder	0	—	—	—
	1	106.7	111.8	107.0
	5	101.3	94.8	105.1
	10	98.7	101.4	109.3
Butter	0	—	—	—
	1	106.7	114.3	107.5
	5	101.3	106.7	109.8
	10	106.7	108.0	100.6

Source: Adapted from Paradkar, M.M. and Irudayaraj, J.I., *Int. J. Dairy Technol.*, 55(3), 127, 2002; Paradkar, M.M. and Irudayaraj, J.I., *Int. J. Dairy Technol.*, 55(3), 133, 2002.

### 10.4.2 Comparison of GC, HPLC, and Spectrophotometric Methods [48]

Cholesterol determination methods were compared among GC, HPLC, and spectrometer procedures using different extraction methods [48]. The working solution containing 0.03, 0.15, 0.30, and 0.60 mg/mL of cholesterol (5- $\alpha$ -cholestan-3- $\beta$ -ol) was prepared from a stock solution (3 mg/mL). The working cholesterol standards; (a) saponified using 10 mL of ethanolic 2% KOH and 0.3 mL of pyrogallol solution and unsaponified matter is extracted with hexane [32], (b) saponified using 2% of ethanolic KOH and unsaponified matter is extracted with hexane [49], and (c) saponified using 2% of ethanolic KOH and unsaponified matter is extracted with petroleum ether, then washed with 0.5 N NaOH [50]. All the extracts were dried, and samples from each extraction method were analyzed using spectrophotometer, HPLC, and GC.

#### 10.4.2.1 Spectrometric Analysis

*Preparation of coloring reagent:* The stock reagent was prepared by dissolving 10 g of  $\text{FeCl}_3 \cdot 6\text{H}_2\text{O}$  in glacial acetic acid using a 100 mL volumetric flask. Prior to use, 1.0 mL of the stock reagent was transferred into a 100 mL flask and concentrated  $\text{H}_2\text{SO}_4$  was added to the volume.

*Color reaction:* The dried extracts obtained from different extraction methods were resuspended in 3 mL of glacial acetic acid, and 2 mL of  $\text{FeCl}_3$  coloring solution was added and the resultant color was read at 565 nm. The absorption was compared against an external cholesterol standard, and the cholesterol content was calculated using the following equation:

$$\text{cholesterol (mg/100 g)} = \frac{c \times 20 \times \text{DF} \times W}{4 \times 100}$$

where

$c$  = concentration of cholesterol (from standard curve)

DF = dilution factor

$W$  = weight of sample, g

#### 10.4.2.2 Gas Chromatographic Method

Prior to analyses, all the dried extracts were resuspended in 0.8 mL of petroleum ether. Analyses were performed on a GC with FID detector using a capillary column (0.25 mm  $\times$  25 m in length) coated with high-temperature phase 007-65HT. The GC conditions are as follows: injection volume, 1.0  $\mu\text{L}$ ; injector temperature, 300°C; detector temperature, 350°C; temperature programming: 65°C–200°C (40°C/min)–280°C (10°C/min); and carrier-gas flow rate (He) at 1.6 mL/min.

#### 10.4.2.3 HPLC Method

The dried extracts were resuspended in 0.8 mL of isopropanol. The isocratic analysis (50% acetonitrile: 50% isopropanol) was performed using C18 column (4.6 mm  $\times$  250 mm) on a HPLC system with UV-vis detector.

*Results and conclusions:* The sensitivities of the spectrophotometer, GC, and HPLC were tested using standard cholesterol solutions. The precision of each measuring apparatus are shown in Table 10.5. If variation coefficient (CV) is less than 5%, then the precision is considered to be

**Table 10.5 Sensitivity of Measuring Instruments**

<i>Instrument</i>	<i>Actual Amount (mg)</i>	<i>Precision Measured</i>	<i>CV (%)</i>
Spectrophotometer	0.27	0.203 ± 0.032	5.76
HPLC	0.27	0.263 ± 0.013	4.94
GC	0.27	0.202 ± 0.048	23.76

Source: Adapted from Osman, H. and Chin, Y.K., *Mal. J. Anal. Sci.*, 10(2), 205, 2006.

**Table 10.6 Recovery of Cholesterol (Spiked) from Oil Matrix**

<i>Methods</i>	<i>Actual Concentration (mg/mL)</i>	<i>Extracted Cholesterol<sup>a</sup></i>	<i>CV (%)</i>	<i>Recovery (%)</i>
<b>Spectrophotometer</b>				
Bohac [32]	0.30	0.26	6.66	86.67
B&J [49]	0.30	0.11	18.17	36.67
Queensland SE [50]	0.30	0.38	18.42	126.67
<b>HPLC</b>				
Bohac	0.30	0.29	7.50	96.67
B&J	0.30	0.22	9.10	73.33
Queensland SE	0.30	0.33	9.56	110.00
<b>GC</b>				
Bohac	0.30	0.25	28.57	83.33
B&J	0.30	0.18	51.23	60.00
Queensland SE	0.30	0.44	34.38	146.67

Source: Adapted from Osman, H. and Chin, Y.K., *Mal. J. Anal. Sci.*, 10(2), 205, 2006.

<sup>a</sup> Mean from eight extractions.

good, while if the CV is 10%, then the precision of the instrument is considered as fair. The recoveries of standard cholesterol using all the three methods are shown in Table 10.6. It is clear that the extraction method proposed by Bohac et al. [32] is superior to that of the other two. The recovered cholesterol is found to be very close to the amount of added cholesterol. The Queensland method [50] is always observed to produce higher values (overestimation). As a result, saponification of fat extracted using 10 mL of ethanolic 2% KOH and 0.3 mL of pyrogallol solution, and sample prepared by the extraction with 2 × 10 mL hexane of unsaponified matter [32] has revealed the highest sensitivity and accuracy in the determination of cholesterol by HPLC method. The results indicate that cholesterol content can be affected by the extraction and analytical methods.

### 10.4.3 Comparison of Different Extraction/Colorimetric Procedures with GC Method [51,52]

The cholesterol concentrations of 15 varieties of U.S. and imported commercial goat-milk cheeses were evaluated by different extraction and colorimetric determination procedures [51]. Two extraction methods: (1) developed by Folch et al. [53] and (2) RG, AOAC [54], and two colorimetric methods: (1) Searcy and Bergquist [29] and (2) Rudel and Morris [30] methods were compared for the study. The range of cholesterol levels in the experimental cheeses was 80–147 mg/100 g (wet basis). The imported variety containing garlic and herb additives had the highest cholesterol content among all the tested varieties, which might be attributed to the turbidity of the sample solution in the colorimetric procedures.

The colorimetric method using *o*-phthalaldehyde [54] was more consistent and had about 20% less variable than using FeSO<sub>4</sub>–acetic acid [29] as the color-developing agent in the cholesterol determination [51]. Some chemical compounds from the additives might be extracted into the lipid extract, which in turn can interfere with the chemical reaction in the colorimetric determination [55,56]. In addition, the original goat milk used for making the French cheese with garlic and herb might have higher levels of fat and cholesterol than the other varieties, owing to the differences in the animal, breed, diet, stage of lactation, and environmental and management conditions [57].

Cholesterol and fatty-acid concentrations among different species were compared using GC method (Table 10.7; Royal Society of Chemistry, 1989; 58). The respective cholesterol contents

**Table 10.7 Cholesterol and Fatty Acid Composition of Different Species Milks**

Species	Fatty Acids (g/100 g)			Cholesterol (mg/100 g)
	Saturated	Monounsaturated	Polyunsaturated	
<b>Cow Milk</b>				
Whole	2.4	1.1	0.1	14
Skim	0.1	Tr	Tr	2
Dried whole	16.5	7.6	0.8	120
Goat milk	2.3	0.8	0.1	10
Sheep milk	3.8	1.5	0.3	11
<b>Human Milk</b>				
Colostrum	1.1	1.1	0.3	31
Mature	1.8	1.6	0.5	16
Soya milk	0.3	0.4	1.1	0

Source: Adapted from Park, Y.W. and M.R. Guo., *Handbook of Milk of Non-Bovine Mammals*, Blackwell Publisher, Ames, Iowa and Oxford, England, pp. 59–106, 2006; Data taken and organized from Holland, B. et al., in *The Composition of Foods*, Royal Society of Chemistry, Ministry of Agriculture, Fisheries and Food, Cambridge, U.K., 1989.

of normal fluid goat, cow, sheep, and human milk were 10, 14, 11, and 16, indicating that goat milk has the lowest cholesterol content among these 4 species milk, which are consistent with the data in the USDA Agricultural Handbook No. 8-1 [59]. Human milk has the highest content of cholesterol among these four species milks, and its colostrum has 31 mg/100 g. Furthermore, the cow milk powder has substantially higher cholesterol (120 mg/100 g) as it is a dried and concentrated product. This cholesterol value of cow milk powder is essentially at the same level of that reported by Park [52] by the GC method. However, the cholesterol content assayed by the colorimetric method by the same author was almost double the concentrations of the data analyzed by GC method, as shown in Table 10.8. These results suggest that the colorimetric methods overestimate the cholesterol/sterol levels in the samples [52,55], whereby these methods are less precise and sensitive when compared with GC, HPLC, and other instrumental methods.

Contarini et al. [17] found that if sterols are evaluated in dairy products other than butter, particular care should be taken when extracting the fat. In case of whey cheese, the best results were obtained by using alkaline hydrolysis followed by extraction with diethyl and petroleum ether.

**Table 10.8 Comparison of Fat and Cholesterol Contents (Wet Basis) in Different Manufactured Goat Milk Products in the United States**

Goat Milk Products	Moisture (%)		Fat (%)		Cholesterol (mg/100 g)			
					Colorimetric		GC <sup>a</sup> [20]	
	$\bar{X}$	SD	$\bar{X}$	SD	$\bar{X}$	SD	$\bar{X}$	SD
Fluid milk	88.75	0.24	3.40	0.15	19.5	2.58	11.0	0.80
Evaporated milk	79.2	0.68	6.75	0.25	43.9	6.20	24.85	0.75
Powdered milk	5.93	0.26	27.9	0.19	236.5	21.0	119.5	7.50
<b>Cheese</b>								
Plain soft <sup>b</sup>	67.5	0.02	17.7	0.25	120.8	3.30	—	—
Monterey Jack	51.2	1.55	26.6	1.13	124.8	2.75	94.6	0.65
Cheddar <sup>c</sup>	36.6	0.11	32.8	0.51	210.0	—	99.4	5.74

Sources: Park, Y.W., *Small Rumin. Res.*, 37, 115, 2000; Adapted from Park, Y.W. and M.R. Guo., *Handbook of Milk of Non-Bovine Mammals*, Blackwell Publisher, Ames, Iowa, pp. 59–106, 2006.

Note:  $\bar{X}$ , mean; SD, standard deviation.

<sup>a</sup> Determined by GC method.

<sup>b</sup> Texas chevre is one of the plain soft goat-milk cheese variety. Cholesterol contents measured by GC method were not reported; Park [51].

<sup>c</sup> Cow milk Cheddar cheese; Lacroix et al. [55].

## 10.5 Weaknesses and Strengths of Analytical Methods of Cholesterol

Numerous and extensive researches have been reported on the quantification of the cholesterol contents in different food products. Earlier methods of cholesterol analysis rely heavily on the spectroscopic and gravimetric procedures. However, colorimetric or enzymatic methods may overestimate the actual cholesterol content. Chromatographic and infrared-chromatographic methods are more reliable, selective, and accurate, because interference from other sterols can be easily resolved. However, the data from various chromatographic techniques are very dependent on the extraction procedures and intensity of the saponification steps. Fat extraction is one of the most important steps in cholesterol determination. Therefore, a hydrolytic solvent can be used to obtain complete extraction of sterols from a complex matrix, like cheese. For example, ammonia is able to break the bonds, leading to a complete cholesterol extraction by diethyl ether–petroleum ether solvents. In complex dairy products like cheese, the best results are obtained by using alkaline hydrolysis followed by extraction with diethyl and petroleum ether.

Among these methods, infrared spectroscopic methods are simple, cost-effective, rapid (less than 5 min), nondestructive than the conventional method. These methods have the potential for routine analysis, if proper calibration and validation procedures with data acquisition protocols could be established. Infrared spectroscopic methods are successfully used for the rapid estimation of cholesterol in commercial dairy products, such as milk powder, cheese, grated cheese, and butter [37,38]. The primary advantages for this methods are: (1) NIR instruments are generally easy to operate and do not require skilled personnel; (2) NIR is fast and accurate and provides information on multiple parameters, such as moisture, protein, and fat in a few seconds, when compared with several hours taken by classical chemical methods; (3) there is minimal or no sample preparation required for NIR techniques; (4) NIR methods are very economical and do not require the use of chemicals, and hence, are environmentally safe; and (5) NIR can be used for solid and liquid analyses. On the other hand, infrared spectroscopic methods may not be suitable for foods with very low cholesterol content, like yoghurt, as the precision for these products is low.

However, the other sterols including cholesterol, brassicasterol,  $\Delta^7$  cholesterol, campesterol, stigmasterol,  $\beta$ -sitosterol, and  $\Delta^5$  avenasterol in milk fat and butterfat have not been determined by infrared spectroscopic, visible spectroscopic, HPLC, and GC methods with direct saponification. Phytosterols mentioned earlier are estimated only by GC–TLC–FID conventional method [19]. However, IDF method requires an initial extraction of total lipids, removal of solvents, saponification of cholesterol esters, exhaustive solvent extraction of nonsaponifiable material, repeated washings, concentration of the analyte, and suitable derivatization prior to GC analysis. These steps are both labor- as well as materials-intensive, and require hazardous reagents, whose procurement, recovery, and disposal costs are increasingly expensive. Therefore, this method is practically much tedious and time-consuming. According to this method, accurate determination of the cholesterol content of milk fat strictly depends on the evaluation of the correction factor for the internal standard, and this evaluation should be made at the same time as the sample analysis. The correction factor depends not only on the operating conditions (column and injection system), as expected, but also on the time, because the response of the detector may change day-to-day.

The GC method with direct saponification needs small sample size and is cost-effective than the method of the International Dairy Federation in terms of solvent requirements, costly materials, sample manipulation, and time for analyses. The sample preparation procedure is both rapid and simple, and automatic sampling can be exploited in extending the capacity for the analysis with unattended chromatographic operation.



On the whole, without depending on the saponification and unsaponification procedure, the chromatographic and infrared spectroscopic methods for cholesterol analysis in foods are much more efficient and convenient than the colorimetric methods, as they have shown much more accurate and precise results for analysis.

## 10.6 Conclusions

Accurate determination of cholesterol contents in dairy and other food products requires dependable and reproducible extraction and assaying procedures, and instruments. As the extraction, saponification, and quantification of cholesterol in different foods are complex, optimal procedures should be selected for different food products. Accurate determination of cholesterol contents in foods is very essential for the regulatory aspects of food labeling, especially because of the fact that cholesterol is involved in human health including coronary heart diseases, hypertension, atherosclerosis, stroke, diabetes, etc.

GC, HPLC, FTIR, and FT-NIR spectroscopy are used for successful estimation of cholesterol concentrations in different dairy products. However, other sterols as well as cholesterol are determined only by GC-TLC-FID method. Chromatographic methods (i.e., GC and HPLC) and FTIR, FT-NIR spectroscopy, have shown much more accurate and precise results than colorimetric methods. The research results have shown that colorimetric methods usually overestimate the cholesterol contents of foods and are less precise than the chromatographic and instrumental methods, mainly owing to the difficulties of measuring pure cholesterol in such a complexed chemical environment and reaction vessel, as well as the turbidity of the assaying solution during the analytical processes.

## References

1. Olson, R.E. Discovery of the lipoproteins, their role in fat transport and their significance as risk factors. *J. Nutr.*, 128 (2 Suppl): 439S–443S, 1998.
2. Billheimer, J.T. and Gillies, P.J. Intracellular cholesterol esterification. In: *Advances in Cholesterol Research*, M. Esfahani and J.B. Swaney, eds., The Telford Press, Caldwell, NJ, 1990, pp. 7–45.
3. Li, S. and Parish, E.J. The chemistry of waxes and sterols. In: *Food Lipids*, C.C. Akoh and D.B. Min, eds., Marcel Dekker Inc., New York, 1998, pp. 89–114.
4. Turley, S.D. and Dietschy, J.M. Cholesterol metabolism and excretion. In: *The Liver: Biology and Pathobiology*, I. Arios, H. Papper, D. Schacter, and D.A. Sharitz, eds., Raven, New York, NY, 1982, pp. 467–492.
5. Hawke, J.C. and Taylor, M.W. Influence of nutritional factors on the yield, composition and physical properties of milk fat. In: *Advanced Dairy Chemistry 2-Lipid*, P.F. Fox, ed., Chapman & Hall, London, U.K., 1995, pp. 37–77.
6. Patton, S. and Jensen, R.G. *Diomedical Aspects of Lactation*, Pergamon, Elmsford, NY, 1976.
7. NRC. Fats and other lipids. In: *Diet and Health*, US National Research Council. National Academy Press, Washington, DC, 1989, pp. 159–258.
8. Richard, E. and Ostlund, Jr. Phytosterols, cholesterol absorption and healthy diets. *Lipids*, 42: 41–45, 2007.
9. Isomaa, B., Almgren, P., and Tuomi, T. Cardiovascular morbidity and mortality associated with the metabolic syndrome. *Diabetes Care*, 24: 683–689, 2001.
10. Watt, B.K. and Merrill, A.L. *Composition of Foods—Raw, Processed, Prepared*, Agriculture Handbook No. 8, U.S. Department of Agriculture, Washington DC, December, 1963.

11. Jervell, A., Meyer, K., and Westlund, K. Coronary heart disease and serum cholesterol in males in different parts of Norway. *Acta Med. Scand.*, 177: 13, 1963.
12. Wilson, P.W., Castelli, W.P., and Kannel, W.B. Coronary risk prediction in adults (The Framingham Study). *Am. J. Cardiol.*, 59: 91G–94G, 1987.
13. Truswell, A.S. Evolution of dietary recommendations, goals and guidelines. *Am. J. Clin. Nutr.*, 45: 1060–1072, 1987.
14. Hurst, W.J., Aleo, M.D., and Martin, R.B. High performance liquid chromatographic analysis of cholesterol in milk. *J. Dairy Sci.*, 66: 2192–2194, 1983.
15. Krehl, W.A. A concept of optimal nutrition. *Am. J. Clin. Nutr.*, 4: 634–641, 1956.
16. Stewart, K.K. Nutrient analyses of food: A review and a strategy for the future. In: *Beltsville Symposia in Agricultural Research [4] Human Nutrition Research*. G.R. Beecher, ed., Allanheld, Osmun Publ., Totowa, NJ, 1981.
17. Contarini, G., Povolo, M., Bonfitto, E., and Berardi, S. Quantitative analysis of sterols in dairy products: Experiences and remarks. *Int. Dairy J.*, 12: 573–578, 2002.
18. Keenan, T.W. and Dylewski, D.P. Intracellular origin of milk lipid globules and the nature and structure of the milk globule membrane. In: *Advanced Dairy Chemistry, Lipids*, Vol. 2, P.F. Fox, ed., Chapman & Hall, London, 1995, pp. 89–130.
19. IDF. Provisional Standard 159: Milk and milk fat product—Determination of cholesterol content. International Dairy Federation, Brussels, 1992.
20. AOAC. *Official Methods of Analysis of AOAC International*, 16th edn., Association of Official Analytical Chemists, Washington, DC, 1996.
21. AOAC. *Official Methods of Analysis of AOAC International*, 17th edn., Association of Official Analytical Chemists, Gaithersburg, MD, 2005.
22. Alonso, L., Fontecha, J., Lozada, L., and Juarez, M. Determination of mixtures in vegetable oils and milk fat by analysis of sterol fraction by gas chromatography. *J. Am. Oil Chem. Soc.*, 74 (2): 131–135, 1997.
23. Wu, W., Lillard, D.A., and Akoh, C.C. Direct saponification: A simple and rapid method for determination of total cholesterol and fatty acid composition of aquatic foods. *J. Food Lipids*, 4: 97–107, 1997.
24. Fletouris, D.J., Botsoglou, N.A., Psomas, I.E., and Mantis, A.I. Rapid determination of cholesterol in milk and milk products by direct saponification and capillary gas chromatography. *J. Dairy Sci.*, 81: 2833–2840, 1998.
25. Ulberth, F. and Reich, H. Gas chromatographic determination of cholesterol in processed foods. *Food Chem.*, 43: 387–391, 1992.
26. Casiraghi, E., Lucisano, M., Pompei, C., and Dellea, C. Cholesterol determination in butter by high performance chromatography. *Milchwissenschaft* 49 (4): 194–196, 1994.
27. Zhang, R.Z., Li, L., Liu, S., Chen, R., and Rao, P.F. An improved method of cholesterol determination in egg yolk by HPLC. *J. Food Biochem.*, 23: 351–361, 1999.
28. Hojo, K., Hakamata, H., Ito, A., Kotani, A., Furukawa, C., Hosokawa, Y.Y., and Kusu, F. Determination of total cholesterol in serum by high-performance liquid chromatography with electrochemical detection. *J. Chromatogr. A*, 1166: 135–141, 2007.
29. Searcy, R.L. and Bergquist, L.M. A new color reaction for the quantitation of serum cholesterol. *Clin. Chim. Acta*, 5: 102, 1960.
30. Rudel, L.L. and Morris, M.D. Determination of cholesterol using o-phthalaldehyde. *J. Lipid Res.*, 14: 364–366, 1973.
31. Bachman, K.C., Lin, J-H., and Wilcox, C.J. Sensitive colorimetric determination of cholesterol in dairy products. *J. AOAC.*, 59: 1146–1149, 1976.
32. Bohac, E., Rhee, K.S., Cross, H.R., and Ono, K. Assessment of methodologies for colorimetric cholesterol assay of meat. *J. Food Sci.*, 53 (6): 1642–1693, 1988.
33. Trinder, P. Simple turbidimetric method for the determination of serum cholesterol. *Ann. Clin. Biochem.*, 6: 165, 1969.

34. Sempore, G.G. and Bezdard, J.A. Analysis of neutral lipids: Unsaponifiable matter. In: *Handbook of Food Analysis*, Vol. 1., L.M. Nolle, ed., Marcel Dekker, Inc., New York, 1996, pp. 491–506.
35. Ong, C.P., Lee, H.K., and Li, S.F.Y. Supercritical fluid extraction and chromatography of cholesterol in food samples. *J. Chromatogr.*, 515: 509–513, 1990.
36. Wilson, R.H. Fourier transform mid-infrared spectroscopy for food analysis. *Trends Anal. Chem.*, 9: 127–131, 1990.
37. Paradkar, M.M. and Irudayaraj, J.I. Determination of cholesterol in dairy using infrared techniques. FTIR spectroscopy. *Int. J. Dairy Technol.*, 55 (3): 127–132, 2002.
38. Paradkar, M.M. and Irudayaraj, J.I. Determination of cholesterol in dairy products by infrared techniques: 2. FT-NIR method. *Int. J. Dairy Technol.*, 55 (3): 133–138, 2002.
39. Hattab, N., Daghbouche, Y., Hattab, M., Piovetti, L., Garrigues, S., and Guardia, M. FTIR-determination of sterols from the red alga *Asparagopsis armata*: Comparative studies with HPLC. *Talanta*, 68: 1230–1235, 2006.
40. Puoci, F., Curcio, M., Cirillo, G., Iemma, F., Spizzirri, U.G., and Picci, N. Molecularly imprinted solid-phase extraction for cholesterol determination in cheese products. *Food Chem.*, 106: 836–842, 2008.
41. Klatt, L.V., Mitchell, B.A., and Smith, R.L. Cholesterol analysis in foods by direct saponification – gas-chromatographic method – collaborative study. *J. AOAC Int.*, 78 (1): 75–79, 1995.
42. Kuksis, A., Myher, J.J., Marai, L., Little, J.A., McArthur, R.G., and Roncari, D.A.K. Fatty-acid composition of individual plasma sterol esters in phytosterolemia and xanthomatosis. *Lipids*, 21: 371–377, 1986.
43. Porter, N.A., Dussault, P., Breyer, R.A., Kaplan, J., and Morelli, J. The resolution of racemic hydroperoxides—A chromatography-based separation of perketals derived from arachidonic, linoleic, and oleic-acid hydroperoxides. *Chem. Res. Toxicol.*, 3: 236–243, 1990.
44. IDF. Standard 1D: Milk—Determination of fat content (reference method). International Dairy Federation, Brussels, 1996.
45. IDF. Standard 5B: Cheese and processed cheese products—Determination of fat content—Gravimetric method (reference method). International Dairy Federation, Brussels, 1986.
46. Parks, O.W. Cholesterol esters of skim milk. *J. Dairy Sci.*, 63: 295–297, 1980.
47. IDF. Standard 172: Milk and milk products—Extraction methods for lipids and liposoluble compounds. International Dairy Federation, Brussels, 1995.
48. Osman, H. and Chin, Y.K. Comparative sensitivities of cholesterol analysis using GC, HPLC and spectrophotometric methods. *Mal. J. Anal. Sci.*, 10 (2): 205–210, 2006.
49. Beyer, R.S. and Jensen, L.S. Overestimation of cholesterol content of eggs. *J. Agric. Food Chem.*, 37: 917–920, 1989.
50. Queensland Health Science Institute. Method QSE-CAM-004, 1995.
51. Park, Y.W. Cholesterol contents of U.S. and imported goat milk cheeses as quantified by different colorimetric methods. *Small Rumin. Res.*, 32: 77–82, 1999.
52. Park, Y.W. Comparison of mineral and cholesterol composition of different commercial goat milk products manufactured in USA. *Small Rumin. Res.*, 37: 115–124, 2000.
53. Folch, J., Lees, M., and Stanley, G.H.S. A simple method for the isolation and purification of total lipids from animal tissues. *J. Biol. Chem.*, 226: 497, 1957.
54. AOAC. *Official Methods of Analysis*. 13th edn. No. 16.059. Association of Official Analytical Chemists, Washington, DC, 1980.
55. Lacroix, D.E., Mattingly, W.A., Wong, N.P., and Alford, J.A. Cholesterol, fat, and protein in dairy products. *J. Am. Diet. Assoc.*, 62:275, 1973.
56. Marshall, R.T. *Standard Methods for the Examination of Dairy Products*, American Public Health Association, Washington, DC, 1992, pp. 456–516.
57. Park, Y.W. and Chukwu, H.I. Trace mineral concentrations in goat milk from French-Alpine and Anglo-Nubian breeds during the first 5 months of lactation. *J. Food Comp. Anal.*, 2:161–169, 1989.

58. Park, Y.W. and Guo, M.R. Goat milk products: Processing technology, types and consumption trends. In: *Handbook of Milk of Non-Bovine Mammals*, Y.W. Park and G.F.W. Haenlein, eds., Blackwell Publ. Ames, Iowa, and Oxford, England, 2006, pp. 59–106.
59. Posati, L.P., and Orr, M.L. *Composition of Foods, Dairy and Egg Products. Raw, Processed, Prepared*, Agricultural Handbook No. 8-1. ARS, USDA, Washington, DC, 1976.
60. Holland, B., Unwin, I.D., and Buss, D.H. Milk products and eggs. In: *The Composition of Foods*, Royal Society of Chemistry. Ministry of Agriculture, Fisheries and Food, Cambridge, U.K., 1989.



# Chapter 11

---

## Organic Acids

---

Huimin Zhang and Lloyd E. Metzger

### CONTENTS

11.1	Organic Acids in Dairy Products.....	259
11.2	Analytical Methods.....	260
11.2.1	Analytical Methods for Individual Organic Acid .....	260
11.2.1.1	Titratable Acidity.....	260
11.2.1.2	Chemical “Wet” Methods .....	260
11.2.1.3	Enzymatic-Based Methods .....	261
11.2.2	Instrument-Based Methods.....	262
11.2.2.1	Gas Chromatographic Method.....	262
11.2.2.2	High-Performance Liquid Chromatography.....	264
11.2.2.3	Capillary Electrophoresis.....	270
11.2.2.4	Fourier Transform Infrared Spectroscopy.....	271
11.3	Conclusion Remarks .....	272
	References.....	272

### 11.1 Organic Acids in Dairy Products

Organic acids in dairy products originate from the growth of microorganisms [1–3], hydrolysis of milk fat [4–6], normal bovine biochemical metabolism such as the production of citric acid (CA), orotic acid (OA), hippuric acid (HA), and uric acid (UA) in milk [7,8], and direct addition as acidulants [9]. The roles organic acids play in dairy products include reducing pH, contributing to flavor attributes, inhibiting spoilage and pathogenic microorganisms, and indicating bacteriological quality [10–12].

Organic acids are compounds that are characterized by their carboxyl group ( $-\text{COOH}$ ) that dissociates into a proton and a conjugate base that endows them with their acidic property [13].

Organic acids are classified into aliphatic, alicyclic, aromatic, and heterocyclic according to their carbon chain type. They are also classified according to the substitution and the number of function groups (monocarboxylic, dicarboxylic, and tricarboxylic). The shortest carbon chain monocarboxylic aliphatic acids (C1:0–C4:0) are highly volatile liquids, whereas organic acids with five or more carbons are oily and slightly water-soluble liquids. The monocarboxylic acids with one to six carbons are frequently referred to as volatile free or short-chain fatty acids by dairy researchers [14–17]. Organic acids with di- and tricarboxyl groups include oxalic acid (OxA), succinic acid (SA), CA, and so on. The organic acids commonly found in dairy products are OA, CA, formic acid (FoA), SA, OxA, UA, pyruvic acid (PyA), acetic acid (AA), propionic acid (PrA), lactic acid (LA), butyric acids (BA), isovaleric acid (IVA), valeric acid (VA), HA, and fumaric acid (FuA) [2,3,7,8,18].

## 11.2 Analytical Methods

Over the years various analytical methods have been investigated and used in the determination of organic acids in dairy products, and ranged from simple colorimetric titration methods for total acidity to complex instrumental methods capable of measuring multiple organic acids in a sample. Overall these methods can be divided into two general categories: (1) techniques for analysis of individual organic acid and (2) techniques for quantification of multiple organic acids. Techniques for measuring individual organic acids in dairy products include titratable acidity (TA), chemical “wet” methods, and enzymatic methods. Techniques for measuring multiple organic acids utilize various instrumental techniques, including gas chromatography (GC), high-performance liquid chromatography (HPLC), capillary electrophoresis (CE), and Fourier transform infrared (FTIR) spectroscopy. One exception to this general classification is a rapid GC method that was developed to determine LA alone [19]. Each general category of analysis is presented in the following sections.

### 11.2.1 Analytical Methods for Individual Organic Acid

#### 11.2.1.1 Titratable Acidity

“Titratable acidity is defined as the amount of titrant needed to react stoichiometrically with lactic acid in milk [20].” In reality, TA is a measure of the total acidity in a food product [21]. Consequently, if there is a predominant acid in the product, TA is expressed as the amount of the predominant acid. TA is often used to monitor the acidity of dairy products since most dairy fermentations predominately produce LA. The basic procedure is that sodium hydroxide (0.1 N) solution is gradually added to milk or pretreated samples of other dairy products in the presence of phenolphthalein indicator [20,22]. The end point of the neutralization reaction between NaOH and LA is indicated by the color of the samples changing to a light pink. Though LA is normally the predominant organic acid, other acids in fermented products can also contribute to the total acidity.

#### 11.2.1.2 Chemical “Wet” Methods

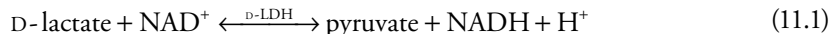
Individual organic acids in dairy products can be determined by chemical methods such as gravimetric-based methods or colorimetric-based methods [23]. Protocols are available for LA and CA.

The Official Methods of Analysis of AOAC International [20] described the chemical methods in the quantification of LA and CA of dairy products. Lactic acid in dairy products including various fluid milks, cream, ice cream, and butter is determined by a colorimetric procedure. In this method, LA is extracted from dairy samples with water and 0.5 M H<sub>2</sub>SO<sub>4</sub>, 20% phosphotungstic acid is added, and the aqueous mixture is filtered. The filtrate is extracted with ether in a liquid extractor and the ether is evaporated. Subsequently the residue is redissolved with diluted HCl, brought to a certain volume with water, and filtered through quantitative paper. The resulting filtrate is mixed with ferric salts (FeCl<sub>3</sub>) and the maximum absorbance of a yellow complex between LA and the ferric salt is recorded using a spectrophotometer. The concentration of LA in the samples is determined using a standard curve. Citric acid in milk can be analyzed with a gravimetric method that utilizes Pb(OAc)<sub>2</sub> to form a Pb salt precipitate. Although chemical “wet” methods are well established, they are rarely utilized because they are tedious, time-consuming, and labor-intensive.

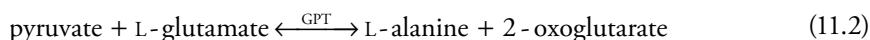
### 11.2.1.3 Enzymatic-Based Methods

Enzyme-based methods utilize a series of biochemical reactions carried out under the catalyzation of specific enzymes. As an example, the set of reactions utilized in an enzyme-based kit produced by Boehringer Mannheim/R-Biopharm to measure D-LA are described below [24].

In the presence of D-lactate dehydrogenase (D-LDH) enzyme, D-LA is oxidized to pyruvate and nicotinamide-adenine dinucleotide (NAD) is reduced to NADH:



Glutamate–pyruvate transaminase (GPT) subsequently catalyzes the reaction of pyruvate and L-glutamate, and the equilibrium is moved in favor of the production of NADH through the consumption of pyruvate:



The amount of NADH formed from the reactions is stoichiometric to the amount of D-LA. The determination is based on the formation of NADH measured by the increase in the UV absorbance at 340 nm. Hence, an UV spectrometer is a necessity for the completion of the analysis. The test kit contains seven bottles of chemical agents and several steps are needed. One distinct advantage of the kit for LA is that it can distinguish D- and L-LAs in dairy products by using D- or L-lactate dehydrogenase. This can be important for some LA fermentations, where the formation of one form of LA is preferred. The detection limit is 0.3 mg/L sample solution, and the linearity is from 0.3 mg/L to 0.35 g/L sample solution. The method is specific for LA and possible interference from other compounds in the samples can be recognized by using an internal standard as a control.

Boehringer Mannheim/R-Biopharm also produces kits to analyze AA, CA, D-3-hydroxybutyric, FoA, and SA in dairy products [25–29]. Water is used as the extraction solvent for all the above organic acids.

Another enzymatic method was developed by Marshall and Harmon in 1978 [12] to measure pyruvate content as a monitor of bacterial growth in Grade A milk. Pyruvate is converted to lactate by lactate dehydrogenase in the presence of NADH<sub>2</sub>, the reduction of NADH<sub>2</sub> concentration is



measured by UV absorbance at 340 nm. The analysis of pyruvate is performed using a Technicon Auto Analyzer® II, which is a commercially available instrument consisting of a set of modules connected in sequence to conduct an automated chemical analysis.

## **11.2.2 Instrument-Based Methods**

Prior to instrumental analysis, thin-layer chromatography [30] and paper chromatography [31] were investigated for the determination of short-chain organic acids (AA, PrA, and BA) in cheese samples. No further investigation and use of the two primary chromatographic methods in the following years suggest their inherent limitations, which are more labor-intensive, less reproducible, and quantifiable without the modern data system utilized in instrument-based methods [32]. Instrument-based methods were initially investigated in the 1950s and today they are routinely utilized for measuring the organic acids in dairy products. The various instrument-based methods utilized for the analysis of organic acids are discussed below.

### **11.2.2.1 Gas Chromatographic Method**

GC has emerged as the leading technique for the separation and analysis of volatile compounds [32]. The separation efficiency of chromatographic technique lies in the repeated distribution or partition of analytes between stationary and mobile phases [33]. In GC the mobile phase is a gas and the predominant stationary phase is a fused-silica capillary column. GC separates volatiles based on differences in their vapor pressures and solubility in the gas as well as the nature of the stationary phase. In general, the technique is rapid and relatively easy to perform. However, the limitation of GC is that the compounds analyzed must be volatile to be quantified by GC. Hence, for nonvolatile substances, a derivatization reaction is utilized to convert nonvolatile compounds into volatile compounds prior to sample injection. GC is a very common method to analyze free fatty acids (FFAs). A fraction of FFAs, short-chain carboxylic acids (C1:0–C6:0), belong to the organic acid category, which is why the GC method is discussed in this chapter. Overall, the short chains FFAs are stable and volatile enough for direct GC analysis without the need for derivatization [14].

In the GC detection of organic acids in dairy products, either flame ionization detector (FID) [5,14] or MS detection [34–36] or both detectors coupled together [37] are used. The use of MS detection usually involves the detection of other volatiles. Consequently, an FID is the preferred detector for the simple determination of organic acids.

Early investigations [16,38–40] highlight the two major limitations of the GC separation technique in the determination of volatile FFAs and water-soluble organic acids in dairy products. These limitations are that many important organic acids in dairy products such as LAs and PyAs are not volatile enough to be directly detected by GC and the shortest monocarboxylic acids (FoAs and AAs) are very volatile and subject to loss during sample preparation. The majority of published GC methods do not include FoA in their studies; only two earlier methods report measurement of FoAs [16,38].

#### **11.2.2.1.1 Sample Preparation for GC**

The most challenging aspect of FFAs sample preparation for GC analysis is the isolation of minor amounts of FFAs from a complex food matrix that contains an abundant amount of triacylglycerides (TAGs). The preparation method of De Jong and Badings [5] is now the commonly adapted

procedure for the quantification of FFAs in dairy products. In the method, FFAs are isolated from TAGs using an anion-exchange aminopropyl column and the underivatized FFAs are directly injected into the GC system for separation. To compensate for the loss of short-chain FFAs in the aqueous phase, an internal standard is used. The method gives a nearly 100% recovery of all the FFAs and the coefficient of variation for most FFA is less than 2%. This sample preparation method of De Jong and Badings [5] was compared with another method of Martin-Hwenandez et al. [41] in the study by Chavarri et al. [4]. In the method of Martin-Hwenandez et al. [41], FFAs were not isolated with TAGs and the mixture was treated with tetramethylammonium hydroxide to produce methyl ester derivatives. Consequently, fatty acids from the hydrolysis of TAGs mixed with the FFAs and distorted the results.

Other sample pretreatment methods for GC analysis of short-chain FFAs have also been investigated and compared. A dynamic headspace and a simultaneous distillation extraction (SDE) technique were compared by Barbieri et al. [34]. The recoveries of the volatile organic acids (AA, PrA, 2-methylpropanoic acid, and BA) were higher from the headspace pretreatment than the SDE technique, while SDE was more suitable for the relatively long-chain nonvolatile FFAs (C5:0–C8:0).

A derivatization pretreatment was investigated by Harvey et al. in 1981 [42] for GC analysis of a wide range of water-soluble, nonvolatile organic acids in Cheddar cheese. The organic acid filtrates were converted to methyl esters prior to GC analysis. However, the developed method only detected LA and SA in 12 commercial Cheddar cheese samples. The results are substantially different from those reported by the majority of publications, which used HPLC methods and found a much wider range of organic acids in Cheddar cheeses [2,3,10,42,44,]. The strong contrast leads to doubts about the accuracy and sensitivity of this derivatization procedure in the determination of organic acids using a GC-based method.

Recently, Cadwallader et al. [14] and Innocente et al. [17] provided a quick and cheap sample preparation method utilizing simple extraction with water. Efficient and reproducible extractions of short-chain carboxylic acids (C2:0–C6:0) were achieved based upon their moderate water solubility at pH 5–6. An internal standard was used to compensate for loss during sample preparation and to obtain accurate quantification. The underivatized acids were directly separated by GC. The recoveries were very good (99%–101%) and the precision was satisfactory (0.9%–4.8% coefficient of variation) [14]. The improved methods of Cadwallader et al. [14] and Innocente et al. [17] successfully address the low recovery of short-chain monocarboxylic acids, which is a major limitation of most published GC methods.

In summary, the preferred sample treatment for GC analysis of short-chain monocarboxylic acids is the method utilizing simple extraction with water. This approach does neither require derivatization nor a clean-up procedure to separate FFAs from TGs. The sample preparation is simple and quick and gives very good recovery and precision. Briefly, samples and added internal standard (2-ethylbutanoic acid) are extracted with deodorized water and the supernatant of the extract is acidified to pH ~2 using aqueous 10% (w/v) HCl [14]. After neutralization with NaOH to pH 5–6, diethyl ether is used to partition the acids, and then the diethyl ether is dried with sodium sulfate and the resulting extract is ready for GC analysis.

#### 11.2.2.1.2 Preferred Method for GC Analysis

For the analysis of short-chain volatile carboxylic acids (C2:0–C6:0) in dairy products, GC is a good choice and the GC procedure used by Cadwallader et al. [14] is recommended. The GC system is equipped with a fused-silica capillary column (15 m × 0.53 mm) coated with free fatty acid

phase (FFAP) and a FID. Helium is used as carrier gas at a constant flow of 5 mL/min. During the analysis, the oven temperature is raised from 35°C to 230°C and the initial and final temperatures were held for 3 and 30 min, respectively.

### 11.2.2.2 *High-Performance Liquid Chromatography*

The separation principles and theories of HPLC are similar to GC except that the mobile phase is liquid instead of gas [32]. The compounds do not need to be volatile to be separated by HPLC, but need to be dissolved in solvents or solutions. Because both the stationary phase and mobile phase of HPLC influence the separation and a variety of stationary phases (polar, nonpolar, ion-exchange, size exclusion, etc.) are available, the versatility of HPLC is much greater than GC. Since HPLC can analyze numerous organic acids in dairy products without derivatization, this technique avoids the tedious derivatization preparation and clean-up procedures utilized in GC methods as well as the time-consuming and toxic chemical disposal problems associated with chemical methods. A scan of recent literatures on the determination of organic acids in dairy products clearly reveals that HPLC is the most frequently used method. The HPLC separation techniques involving the quantification of organic acids are mainly ion-exchange, ion-exclusion, and reverse-phase chromatographies. Table 11.1 summarizes some published HPLC methods used for the quantification of organic acids in dairy products.

Ion-exchange chromatography exploits the readily ionizable nature of organic acids and separates them using an ion-exchange resin as a stationary phase [13,45]. Ion-exchange HPLC can also simultaneously analyze other compounds such as sugars and alcohols that are commonly present in dairy products.

Ion-exclusion chromatography refers to the exclusion phenomenon due to electrostatic repulsion forces, steric exclusion, and sorption processes that allow the rapid separation of electrolytes from nonelectrolytes [13,45]. It usually employs sulfonated polystyrene–divinylbenzene (SPD) cation resin as the stationary phase. In general, ion-exclusion HPLC is quite efficient and yields better-shape peaks as compared to other type of ion chromatography; however, its major disadvantage is that some neutral compounds such as sugars are retained by the cation resin. Consequently, samples must be pretreated (with anionic-exchange resin column) prior to injection into the HPLC.

The basic principle of reverse-phase HPLC (RP-HPLC) is that nonpolar stationary phases such as octadecyl silica allow the separation of relatively polar organic acid by using an aqueous phase at an appropriate pH to prevent their ionization [13]. The governing mechanism is hydrophobic interactions and less than 5% of an organic modifier such as acetonitrile is required for the elution of underivatized organic acids. As compared to ion chromatography, RP HPLC can achieve faster analysis and improved separation by optimization of various parameters and implementation of a gradient elution.

The common detectors used in HPLC determination of organic acids include refractive index (RI), ultraviolet–visible (UV–vis), and conductivity. UV–vis detection is most frequently used since the major organic acids can be detected at 206–220 nm. Conductivity detection is more sensitive and selective than UV-type detection, but it requires the use of a suppressing column to eliminate the eluent background conductivity. This inherent pitfall of conductivity detection prevents it from being a popular detector in food analysis. RI detection is flexible and versatile because it can also detect other components of interest such as carbohydrates and alcohols in dairy products in addition to some organic acids. The limitation of RI detection is that it requires isocratic elution. A common practice in the determination of organic acids and other

Table 11.1 HPLC Systems Used for the Determination of Organic Acids in Dairy Products

Compounds Determined	Column	Mobile Phase	Detector	Coelution Acids	Reference
FoA, AA, PrA, PyA, LA, SA, and pyro-glutamic acids	Aminex HPX-87H column (300 x 7.8 mm)	0.013 N H <sub>2</sub> SO <sub>4</sub> at 0.6 mL/min and 42°C	UV-variable wavelength detector set at 220 nm	PyA and SA not baseline separated	[51]
CA, OA, PyA, AA, and PrA	Aminex HPX-87H column (300 x 7.8 mm)	0.009 N H <sub>2</sub> SO <sub>4</sub> at 0.7 mL/min and 65°C	UV detector set at 214 nm	Not reported	[48]
CA, OA, PyA, LA, UA, FoA, AA, PrA, BA, and HA	Aminex HPX-87H column (300 x 7.8 mm)	0.009 N H <sub>2</sub> SO <sub>4</sub> at 0.7 mL/min and 65°C	Variable wavelength UV detector at 220 and 285 nm	CA and OA	[43]
CA, FoA, LA, and AA	Dionex Ion-Pac ICE-AS6 column (9 x 259 mm)	0.4 mM heptafluorobutyric acid at 1.0 mL/min	Pulsed amperometric detector	Not reported	[48]
FoA, AA, PrA, BA, VA, CA, OA, PyA, LA, OxA, and HA	Aminex HPX-87H column (300 x 7.8 mm)	0.013 N H <sub>2</sub> SO <sub>4</sub> at 0.8 mL/min and 65°C	UV detector set at 210 and 290 nm	CA and OA; UA and FoA	[3]
FoA, AA, CA, BA, Ora, PrA, PyA, LA, and UA	Aminex HPX-87H column (300 x 7.8 mm)	0.013 N H <sub>2</sub> SO <sub>4</sub> at 0.8 mL/min at 65°C	UV-variable wavelength detector set at 210 and 285 nm	CAs and OAs, UA and FoAs	[2]
PrA, LA, CA, SA, glutamic acid, and acetoin	Aminex HPX-87H column (300 x 7.8 mm)	10 mM H <sub>2</sub> SO <sub>4</sub> at 0.6 mL/min at 65°C	UV detector set at 210 and 290 nm	Acetoin and PrA	[11]

(continued)

Table 11.1 (continued) HPLC Systems Used for the Determination of Organic Acids in Dairy Products

<i>Compounds Determined</i>	<i>Column</i>	<i>Mobile Phase</i>	<i>Detector</i>	<i>Coelution Acids</i>	<i>Reference</i>
CA, OA, PyA, LA, AA, FoA, BA, IVA, HA, TA, SA, VA, and PrA	HC-75 ion-exclusion column (300 x 7.8 mm)	10 mM H <sub>2</sub> SO at 0.6 mL/min at 65°C	PhotoDiode Array detector at 210 and 280 nm	CA and OA	[47]
FoA, AA, PyA, PrA, UA, OA, CA, LA, and BA	Ultrasphereoctyl C8 (250 x 4.6 mm, 5 μm)	0.5% (w/v) (NH <sub>4</sub> ) <sub>2</sub> HPO <sub>4</sub> at pH 2.24 with H <sub>3</sub> PO <sub>4</sub> <sup>-</sup> 0.4% (v/v) acetonitrile at 1.2 mL/min	UV detector was set at 214 nm	Not reported	[6]
OA, CA, FoA, SA, OA, UA, PyA, AA, PrA, LA, and BA	Atlantis dC18 column (250 mm x 4.6 mm, 5 μm)	Solvent A: 1% NaH <sub>2</sub> PO <sub>4</sub> at pH 2.20; Solvent B: acetonitrile gradient elution at 1.2 mL/min	Two-channel UV detector set at 210 nm	Not reported	[52]

water-soluble compounds in dairy products is ion-exchange HPLC with UV detection coupled with RI detector [2,3,11]. The use of ion-exchange HPLC with this dual detection system is capable of quantifying 60 common carboxylic acids, sugars, and alcohols of general interest in food products in less than 45 min [46].

#### 11.2.2.2.1 Sample Extraction and Pretreatment for HPLC Analysis

Due to their water solubility, organic acids in dairy foods are typically extracted with aqueous solutions. The preparation steps for the majority of the sample preparation methods for HPLC include grinding/mixing, extraction, centrifugation, and filtration. A new, alternative, and rapid preparation method, microwave-assisted extraction (MAE), was recently developed [47] and has the potential for future use. Table 11.2 summarizes some of the published preparation methods.

Currently, pure water and four kinds of aqueous solutions have been used to extract organic acids from dairy products: (1) acetonitrile and water; (2) diluted barium hydroxide and zinc sulfate mixture solution; (3) diluted  $\text{H}_2\text{SO}_4$  aqueous solutions, and (4) a mixture of 0.5% (w/v)  $(\text{NH}_4)_2\text{HPO}_4$  adjusted to pH 2.24 with  $\text{H}_3\text{PO}_4$  and 0.4% (v/v) acetonitrile aqueous solution. Fernandez-Garcia and McGregor (1994) compared two kinds of solutions (acetonitrile and water in the ratio of 5:1 (v/v) and 0.01 N  $\text{H}_2\text{SO}_4$ ) to extract spiked organic acids in yoghurt. Satisfactory recoveries (>90%) of OA, LA, AA, and PrA were obtained with both methods, but the recoveries of CA, PyA, UA, BA, and HA from yoghurt were more satisfactory with 0.01 N  $\text{H}_2\text{SO}_4$  than with the mixture of water and acetonitrile. In this study, FoA had a very low recovery (42%–57%) even with the 0.01 N  $\text{H}_2\text{SO}_4$  extraction solution. The recoveries of organic acids extracted with diluted aqueous  $\text{H}_2\text{SO}_4$  solution (0.013 N) was again investigated by Zeppa et al. [3]. The overall recovery was comparable to the previous study [7,48], however, the recovery for FoA was much better (89.4%). The mixture of acetonitrile and water (5:1, v/v) was also studied by Marsili [49] to extract 10 organic acids (OA, CA, PyA, LA, UA, FoA, AA, PrA, BA, and HA) added in milk samples. Over 90% recoveries were found except for BA, which was 86%.

A solution of barium hydroxide (0.30 N) and zinc sulfate (0.28 N) was utilized to extract organic acids that were separated with ion-exchange HPLC with diluted  $\text{H}_2\text{SO}_4$  as the mobile phase [49]. Very similar recoveries for all acids were observed as compared to the extraction with a mixture of acetonitrile and water (5:1, v/v) [44]. Additionally, simple extraction with water has been reported to provide recoveries above 96% [50–52]. For the RP-HPLC procedure, a mixture of 0.5% (w/v)  $(\text{NH}_4)_2\text{HPO}_4$  adjusted to pH 2.24 with  $\text{H}_3\text{PO}_4$  and 0.4% (v/v) acetonitrile aqueous solution, has been employed as the extraction solution, and the recoveries for all organic acids was above 85% [6].

In general, the above studies indicate that the five different extraction agents yield satisfactory results and the preferred extraction solution depends on the type of HPLC performed. Ion chromatography HPLC usually uses diluted  $\text{H}_2\text{SO}_4$  solution as mobile phase and extraction solution, whereas for RP-HPLC, water or its corresponding mobile phase is used as an extraction solution.

The recently developed MAE technique provides an alternative preparation method. Thirteen organic acids in Greek cheeses and sheep milk yogurt have been subjected to MAE using 10 mM  $\text{H}_2\text{SO}_4$  aqueous solution [47]. Most organic acids (CA, OA, PyA, LA, AA, FoA, BA, IVA, HA) in cheese samples were reported to have recoveries greater than 92%, whereas, recoveries for TA, SA, VA, and PrA ranged from 67% to 78%. In yogurt the recoveries for all organic acids were above 88%, except for SA, HA, and VA which had recoveries of 53%, 78%, and 80%, respectively. The precision of the majority of the organic acids in both cheese and yogurt samples were very good (0.1%–5% relative standard deviation [RSD]). The study concluded that the MAE method was

Table 11.2 Summaries of Some Published Sample Preparation Methods

Reference	Extraction Agent	Mixing	Centrifugation	Filtration or Clean-Up	Recovery
[2]	0.0013 N H <sub>2</sub> SO <sub>4</sub> at 65°C	High-shear mixer-homogenizer	Centrifuge 7000×g for 10 min	Whatman #4 filter paper and Microcon centrifugal filter device	Not determined
[43]	0.0009 N H <sub>2</sub> SO <sub>4</sub> at room temperature	Beaker with magnetic stirrer for 1 h	Centrifuge 5000×g for 10 min	Whatman #1 filter paper and 0.20µm membrane filter	From 70% to 100%
[50]	Distilled water at 50°C	High-speed homogenizer for 5 min	None	0.45µm syringe filter	Mean recovery of LA 98.5%
[6]	0.5% (w/v) (NH <sub>4</sub> ) <sub>2</sub> HPO <sub>4</sub> at pH 2.24–0.4% (v/v) acetonitrile	Homogenizer	Centrifuge 7000×g for 5 min	Filter paper and 0.45µm membrane filter	Greater than 85.3% for all the acids
[3]	0.013 N H <sub>2</sub> SO <sub>4</sub>	Stomacher	Centrifuge 7000×g for 5 min	0.20µm syringe membrane filter	Greater than 84.6%
[52]	Water	High-shear blender for cheese, vortex for yoghurt	3000×g for yoghurt or cheese, 14,000×g for milk for 15 min	0.45µm syringe membrane filter	Close to 100%
[48]	0.30 N barium hydroxide and 0.28 N zinc sulfate	Blender	Centrifuge at 7000×g for 5 min	Whatman #40 filter paper and 0.45µm membrane filter	Not reported
[49]	0.30 N barium hydroxide and 0.28 N zinc sulfate	Osterizer blender	Centrifuge	Whatman #40 filter paper	Greater than 90% except BA (83%)
[51]	Distilled water	Blender	Centrifuge 5000×g	Supernatant was treated with anionic-exchange resin column	Greater than 96%
[47]	10 mM H <sub>2</sub> SO <sub>4</sub>	MAE: 60% of 1200 W maximum magnetron power, extraction at 70°C for 20 min			Good recoveries (>88%) for most acids

satisfactory and provided a rapid, simple, accurate procedure that allows for the simultaneous extraction of many samples. It took less than 2 h to complete the preparation of 14 samples.

#### 11.2.2.2.2 Ion-Exchange HPLC

Ion-exchange HPLC is the most frequently used and preferred method to simultaneously analyze organic acids and other water-soluble compounds in dairy products. As shown by Table 11.1, most ion-exchange HPLC methods employed dilute sulfuric acid solution as the mobile phase and an ion-exchange column to perform the separation. Most of these methods utilize a high operating temperature (55°C–65°C) and an isocratic elution. Coelution of some organic acids and overlapping peaks were the most frequently reported problems associated with the ion chromatography methods with UV detection.

Multiple UV wavelength absorptions are utilized to deal with the coelution problem. Coelution of CA and OA were observed by Bouzas et al. [43] and absorptions were recorded at two wavelengths 220 and 285 nm. In addition to the above coelution, UA and FoA were found to be coeluted [2,3]. In order to determine the concentrations of coeluting acids, the best absorbance wavelength was determined after obtaining the UV absorbance spectra of each coeluted acid. Uric and OAs had maximum absorption at 285 or 290 nm, whereas the highest absorbance peak for CA and FoA is achieved at 210 or 220 nm. CA and FoA had little absorption at the higher wavelengths (285 and 290 nm), thus, allowing for the direct quantification of UA and OA at these wavelengths and calculation of their concentrations from the response factor. The concentrations of CA and FoA were derived by the subtraction of the coelution peak areas. For example, the peak area corresponding to UA at 210 nm was calculated from its response factor at 210 nm and the amount calculated at 290 nm. Then, this area was subtracted from the whole peak area of UA and FoA at 210 nm based on the assumption that the resulting difference was the area corresponding to FoA. The following formula illustrates the calculation principles:

$$\text{uric acid concentration} = \text{peak area at 290 nm} / \text{response factor at 290 nm}$$

$$\text{formic acid concentration} = [PA_{210} - (C_{UA} \times RF_{UA210})] / RF_{FA210}$$

where

$PA_{210}$  = peak area of mix of the two compounds at 210 nm

$C_{UA}$  = concentration of UA evaluated at 290 nm

$RF_{UA210}$  = response factor for UA at 210 nm

$RF_{FA210}$  = response factor for FoA at 210 nm

Upreti et al. [2] applied the above principle but used a multiple regression approach to determine the concentrations of coeluting compounds and obtain the corresponding calculation equations.

#### 11.2.2.2.3 Ion-Exclusion HPLC

To separate organic acids, ion-exclusion HPLC systems use ion-exclusion-type columns such as an HC-75 ion-exclusion gel-type (styrene–divinylbenzene) copolymer (7.5% crosslinking) column (300 × 7.8 mm) [47] or ligand-exchange Rezex proton column [53]. The mobile phase is also a dilute sulfuric acid solution with isocratic elution at a relatively high temperature (65°C). The detection is also performed by an UV-type detector set at two wavelengths. Coelution



(CA and OA) and incomplete separation (AA and FuA) were also observed [47]. Additionally, the ion-exclusion HPLC cannot simultaneously analyze other compounds such as sugars and alcohols that are commonly present in dairy products. Hence, this type of ion chromatography is not in common use.

#### 11.2.2.2.4 Reverse-Phase HPLC

The reverse-phase type HPLC method was tested by Bevilacqua and Califano in 1989 [6] to quantify organic acids in dairy products including raw milk, yoghurt, and three varieties of cheese. As shown in Table 11.1, the separation was performed using an ultrasphereoctyl C8 column at room temperature and isocratic elution (1.2 mL/min). Good recoveries for the nine organic acids (from 85.3% to 93.3%) and repeatability (average RSD 7%) were achieved. In 2004, Tormo and Izco [52] also developed a RP-HPLC method that can simultaneously determine 11 organic acids that were metabolically important in dairy products. They include OxA, CA, FoA, SA, OA, UA, PyA, AA, PrA, LA, and BA. Separation was achieved at room temperature with a dC18 column and gradient elution at a flow rate of 1.5 mL/min. Using UV detection set at 210 nm, the method gave adequate separation of the 11 acids in less than 18 min, and the precision was good (RSD of six replications <5%) and the recoveries were close to 100%. However, unknown compounds were found on the chromatograms when dairy samples were analyzed. A clean-up procedure was also suggested to remove the possible matrix interferences and to prolong the column life.

The alternative RP HPLC method has the following advantages: column cost compared to ion-exchange, easier manipulation of the parameters to optimize the separation, the analysis is carried out at room temperature, which will prolong the life of column [52]. However, the requirement for an extra clean-up step to remove matrix interferences complicates the preparation and may be the reason why RP-HPLC is not as popular as ion-exchange HPLC.

#### 11.2.2.2.5 Preferred HPLC-Based Method

The mature and recommended HPLC separation method is ion-exchange (Aminex HPX-87H column, 300 × 7.8 mm) and UV detection set at two wavelengths, which is 210 or 220 nm and 285 or 290 nm. The mobile phase is diluted H<sub>2</sub>SO<sub>4</sub> aqueous solutions (0.009–0.013 N) with isocratic elution. The most commonly used sample preparation procedure involves homogenizing dairy samples and extracting with mobile phase, i.e., diluted sulfuric acid, followed by centrifugation and filtration through filter paper, syringe filter or a microcentrifugal filter device.

#### 11.2.2.3 Capillary Electrophoresis

Separation of analytes with electrophoresis is based on their differential rates of migration under the influence of an electric field [32]. CE has emerged as an appealing form of electrophoresis when fused-silica capillaries replaced planar surfaces because the small capillaries can remove the heat produced during electrophoresis more successfully. In addition, CE has become a popular complement to HPLC because method development in CE is more predictable than with HPLC. This occurs because the electrophoretic migration is simply driven by a voltage gradient in electrophoresis. The success of CE as an attractive separation technique is also attributed to its great potential for simple preparation and rapid quantification [18,54]. In addition, CE has the advantages of low solvent consumption (milliliters per day), no hazardous solvent, and low cost.

Nevertheless, CE methods also require chromatographic techniques in the operation and the very high voltages used pose a risk [32].

CE can be performed in different modes. Two modes, direct CE [18,55] and capillary zone electrophoresis (CZE) [54] have been investigated for the analysis of organic acids in dairy products. In general, an aqueous buffer solution, often referred to as run buffer or background electrolyte (BGE), is utilized and UV detection is typically employed.

Direct CE has been investigated for the determination of several of the organic acids that possess readily ionizable properties. Samples are extracted with water and subsequently acidified with 85% concentrated phosphoric acid to pH 4.6 [55] or simply extracted with 4.5 mM  $\text{H}_2\text{SO}_4$  [18]. The extracts are centrifuged, vacuum filtered, and degassed prior to analysis. The earlier CE method [55] provided rapid and complete separation of the organic acids (AA, PrA, isobutyric, BA, LA, and IVA) in standard solutions. However, other water-soluble substances from the cheese matrix interfered with the analysis of organic acids in the cheese. Consequently, an extensive clean-up procedure such as ion-exchange treatment or a derivatization step is required for this CE method. CZE, also referred to as free solution CE, was used for the separation of FFAs (C4:0–C24:0) [54]. Because of the nonpolarity of most fatty acids, the sample was extracted with *n*-pentane and organic solvent diethylbarbiturate that can dissolve fatty acids and is miscible with water was used as BGE with the pH adjusted to between 10 and 11, where FFAs can be fully ionized. But interference from other substances, coimmigration of FFAs on the electropherogram, and also the only inclusion of BA in the method restrain the application of CZE as a practical method.

Later on, Izco et al. [18] again investigated using CE technique and developed a method to simultaneously separate 11 organic acids in less than 18 min with their optimum conditions. Their CE system had a photodiode-array detector, two carousels, and utilized computer-based data collection software. The capillaries (75  $\mu\text{m}$  i.d.) are made from fused-silica and two BGEs, 4.4 mM potassium hydrogen phthalate (KHP) and 0.27 mM hexadecyltrimethylammonium bromide (CTAB) were used as running buffer. The separation was achieved at  $-20\text{ kV}$  and  $30^\circ\text{C}$  and the wavelength for indirect UV detection was set at 200 nm. However, coelution or coimmigration problems were observed. PrA and LA were not separated completely and PyA comigrated with AA. Additionally, the phosphate in milk appeared to be coimmigrated with FoA. Alternative solutions were suggested to deal with the coelution problem such as decreasing the pH of the running buffer and changing BGE.

In summary, the advantages of CE methods are short analysis time, simple sample preparation and chemical deposal, and low cost. However, the coimmigration and matrix interference problems pose a strong challenge to this technique. It may be a good choice in analysis of dairy samples with a simple organic acid profile. At this point, whether or not CE is a reliable and applicable technique in the detection of dairy products containing complex organic acids remains uncertain.

#### 11.2.2.4 Fourier Transform Infrared Spectroscopy

Infrared spectroscopy is an attractive technology for rapid, inexpensive, sensitive, and high-throughput analysis of food compounds and does not require special skills of the user [56]. The principle of FTIR is based on the interferometric measurement of radiation [57]. The spectrum obtained from FTIR instruments is detailed and often highly structured, and reflects the properties and composition of samples analyzed. The advances in FTIR instrumentation and the development of pattern recognition and multivariate techniques facilitate pulling information from the spectra related to compounds [56]. However, in comparison to other IR spectroscopy such as

mid-IR or near-IR, FTIR has few analytical applications [57]. The development of a rapid and simple screening tool for three organic acids (AA, PrA, and BA) in Swiss cheese was initiated by Koca et al. in 2007 [56]. In this method, two different sampling techniques were used: direct analysis of cheese slices and water-based extraction. The water-based extract was then adjusted to pH 4.0 with 85% concentrated phosphoric acid prior to analysis using FTIR spectroscopy. The spectrum of each pure organic acid was measured to obtain spectral information, from which prediction models using multivariate analysis were derived. For sample analysis, four spectra were obtained from independent cheese slices and two spectra from water-soluble extracts. Direct measurement of cheese slices was simple, but gave a higher standard error validation than the water-soluble extracts. Interference from fat and protein and heterogeneous composition in different parts of the Swiss cheese slices were reported. Water-based extraction improved the performance of prediction model by decreasing the interference from other compounds and improving the homogeneous property of the sample.

The FTIR method only included three organic acids in the analysis. Also, the establishment of prediction models requires multivariate analysis, and the preferred sample preparation procedure is similar to that of HPLC. Use of FTIR as a simple, rapid screening tool will require further development.

### 11.3 Conclusion Remarks

Organic acids play important roles in dairy products and various methods have been tested and used in their analyses. Some methods such as chemical, enzymatic, and TA are designed for the quantification of a single organic acid. While FTIR and CE methods may have potential use in the future for their simplicity and rapidness, HPLC and GC are the most widely utilized and applicable methods in the determination of organic acids in dairy products. For the analysis of short-chain volatile carboxylic acids (C2:0–C6:0) in dairy products, GC is a suitable method. The simple water extraction protocol and capillary GC with an FID is suggested. For the determination of a variety of water-soluble organic acids, HPLC-based methods are recommended. Extraction with diluted sulfuric acid and separation with an ion-exchange column with UV detection at two wavelengths is the most commonly chosen method.

### References

1. Langsrud, T. and G. W. Reinbold. Flavor development and microbiology of Swiss cheese—A review. *J. Milk Food Technol.* 36: 593–609, 1973.
2. Upreti, P., Mckey, L. L., and L. E. Metzger. Influence of calcium and phosphorus, lactose, and salt-to-moisture ratio on Cheddar cheese quality: Changes in residual sugars and water-soluble organic acids during ripening. *J. Dairy Sci.* 89: 429–443, 2006.
3. Zeppa, G., Conterno, L., and V. Gerbi. Determination of organic acids, sugars, diacetyl, and acetoin in cheese by high performance liquid chromatography. *J. Agric. Food Chem.* 49: 2722–2726, 2001.
4. Chavarri, F., Virto, M., Martin, C., Najera, A. I., Santisterban, A., Barron, L. J. R., and M. D. Renobales. Determination of free fatty acids in cheese: Comparison of two analytical methods. *J. Dairy Res.* 64: 445–452, 1997.
5. De Jong, C. and H. T. Badings. Determination of free fatty acids in milk and cheese procedures for extraction, clean up, and capillary gas chromatographic analysis. *J. High Resol. Chromatogr.* 13: 94–98, 1990.

6. Bevilacqua, A. E. and A. N. Califano. Determination of organic acids in dairy products by high performance liquid chromatography. *J. Food Sci.* 54: 1076–1078, 1989.
7. Fernandez-Garcia, E. and J. U. McGregor. Determination of organic acids during the fermentation and cold storage of yogurt. *J. Dairy Sci.* 77: 2934–2939, 1994.
8. Patton, S. The presence of hippuric acid in milk. *J. Dairy Sci.* 36: 943–947, 1953.
9. Farkye, N. Y. Acid-and Acid/Rennet-curd-cheese part C: Acid-heat coagulated cheeses. In *Cheese: Chemistry, Physics and Microbiology*, Vol. 2. *Major Cheese Group*. Elsevier Academic Press: Amsterdam 2004, pp. 343–366.
10. Collin Y. F., McSweeney, P. L. H., and M. G. Wilkinson. Lipolysis and free fatty acid catabolism in cheese: A review of current knowledge. *Int. Dairy J.* 13: 841–866, 2003.
11. Drake, S. L., Carunchia Whetstone, M. E., Drake, M. A., Courtney, P., Fligner, K., Jenkins, J., and C. Pruitt. Sources of umami taste in Cheddar and Swiss cheeses. *J. Food Sci.* 00: S1–S6, 2007.
12. Marshall, R. T. and C. C. Harmon. The automated pyruvate method as a quality test for Grade A milk. *J. Food Prot.* 41: 168–174, 1978.
13. Gomis, D. B. HPLC analysis of organic acids. In *Food Analysis by HPLC*, 2nd edn. Leo M. L. Nollet, ed., Marcel Dekker Inc.: New York, 2002, pp. 343–366.
14. Cadwallader, K. R., Singh, T. K., and J. P. Jerrell. Streamlined analysis of short-, medium- and long-chain free fatty acids in dairy products. In *Flavor of Dairy Products*. Cadwallader, K. R., Drake, M., and R. J. McGorin, eds., American Chemical Society: Washington, D.C., 2007, pp. 111–122.
15. Dulle, J. R. and P. A. Grieve. Volatile fatty acid production in cheddar cheese. *Aust. J. Dairy Technol.* 29: 120–123, 1974.
16. Hankinson, C. L., Harper, W. J., and Mikolajcik. A gas–liquid chromatographic method for volatile fatty acids in milk. *J. Dairy Sci.* 10: 1502–1509, 1957.
17. Innocente, N., Moret, S., Corradini, C., and L. S. Conte. A rapid method for the quantitative determination of short-chain free volatile fatty acids from cheese. *J. Agric. Food Chem.* 48: 3321–3323, 2000.
18. Izco, J. M., Tormo, M., and R. Jimenez-Flores. Development of a CE method to analyze organic acids in dairy products. *J. Agric. Food Chem.* 50: 1765–1773, 2002.
19. Gray, I. K. A rapid gas chromatographic method for the determination of lactic acid in whey. *N. Z. J. Dairy Sci. Technol.* 1: 54–56, 1976.
20. Wehr, H. M. and J. F. Frank. Chemical and physical methods. In *Standard Methods for the Examination of Dairy Products*, 17th edn. American Public Health Association: Washington, D.C., 2004, pp. 363–374.
21. Sadler, G. D. and P. A. Murphy. pH and titratable acidity. In *Food Analysis*, 3rd edn. Nielsen, S.S., ed., Kluwer Academic: New York, 2003, pp. 207–227.
22. AOAC. *Official Methods of Analysis of AOAC International*, 17th edn. Association of Official Analytical Chemists International: Gaithersburg, MD, 2000.
23. Lawrence, A. J. Determination of lactic acid in cream. *Aus. J. Dairy Technol.* 30: 14–15, 1975.
24. Anonymous. D-Lactic acid/L-lactic acid UV-method for the determination of D- and L-lactic acid in foodstuffs and other materials. *Boehringer Mannheim/R-Biopharm Enzymatic Bioanalysis Kit Instruction Sheet*. 2008.
25. Anonymous. Acetic acid UV-method for the determination of acetic acid in foodstuffs and other materials. *Boehringer Mannheim/R-Biopharm Enzymatic Bioanalysis Kit Instruction Sheet*. 2008.
26. Anonymous. Citric acid UV-method for the determination of citric acid in foodstuffs and other materials. *Boehringer Mannheim/R-Biopharm Enzymatic Bioanalysis Kit Instruction Sheet*. 2008.
27. Anonymous. D-3-Hydroxybutyric acid UV-method for the determination of D-3-hydroxybutyric acid in foodstuffs and other materials. *Boehringer Mannheim/R-Biopharm Enzymatic Bioanalysis Kit Instruction Sheet*. 2008.
28. Anonymous. Formic acid UV-method for the determination of formic acid in foodstuffs and other materials. *Boehringer Mannheim/R-Biopharm Enzymatic Bioanalysis Kit Instruction Sheet*. 2008.

29. Anonymous. Succinic acid UV-method for the determination of succinic acid in foodstuffs and other materials. *Boehringer Mannheim/R-Biopharm Enzymatic Bioanalysis Kit Instruction Sheet*. 2008.
30. Antonini, J. and J. Adda. Thin layer chromatography for the detection of propionic and butyric acids in Comte and Emmental cheese. *Ann. Technol. Agric.* 18: 139–142, 1969.
31. Lindqvist, B., Storgards, T., and M. B. Goransson. Determination of the volatile fatty acids in cheese by means of paper chromatography. *XIII Int. Dairy Congr.* 3: 1250–1253, 1953.
32. Miller, J. M. *Chromatography Concepts and Contrasts*, 2nd edn. Wiley-Interscience: Madison, NJ, 2005.
33. Yuwono, M. and G. Indrayanto. Gas chromatography. In *Ewing's Analytical Instrumentation Handbook*, 3rd edn. J. Cazes, ed., Marcel Dekker: New York, 2005, pp. 727–755.
34. Barbieri, G., Bolzoni, L., Careri, M., Mangia, A., Parolari, G., Spagnoli, S., and R. Virgili. Study of the volatile fraction of parmesan cheese. *J. Agric. Food Chem.* 42: 1170–1176, 1994.
35. Dirinck, P. and A. D. Winne. Flavor characterization and classification of cheese by gas chromatographic-mass spectrometric profiling. *J. Chromatogr. A* 847: 203–208, 1999.
36. Vangtal, A and E. G. Hammond. Correlation of flavor characteristics of Swiss-type cheeses with chemical parameters. *J. Dairy Sci.* 69: 2982–2993, 1986.
37. Valcro, E., Miranda, E., Sanz, J., and I. Martinze-Castro. Automatic thermal desorption in GC analysis of dairy product volatiles. *Chromatographia* 44: 59–64, 1997.
38. James, A. T. and A. J. P. Martin. Gas-liquid partition chromatography: The separation and identification of the methyl esters of saturated and unsaturated acids from formic acid to dodecanoic acid. *Biochem. J.* 63: 144–152, 1956.
39. Hawke, J. C. The fatty acids of butterfat and the volatiles acids formed on oxidation. *J. Dairy Res.* 24: 366–369, 1957.
40. Jennings, W. G. Application of gas-liquid partition chromatography to the study of volatile flavor compounds. *J. Dairy Sci.* 40: 271–279, 1957.
41. Martin-Hwenandez, M. C., Alonso, L., and M. Juarez. Gas chromatographic method for determining free fatty acids in cheese. *Chromatographia* 25: 87–90, 1988.
42. Harvey, C. D., Jenness, R., and Morris, H. A. Gas chromatographic quantitation of sugars and non-volatile water-soluble organic acids in commercial Cheddar cheese. *J. Dairy Sci.* 64: 1648–1654, 1981.
43. Bouzas, J., Kantt, C. A., Bodyfelt, F., and J. A. Torres. Simultaneous determination of sugars and organic acids in Cheddar cheese by high performance liquid chromatography. *J. Food Sci.* 55: 276–278, 1991.
44. Marsili, R. T., Ostapenko, H., Simmons, R. E., and D. E. Green. High performance liquid chromatographic determination of organic acids in dairy products. *J. Food Sci.* 46: 52–57, 1981.
45. Weiss, J. *Ion Chromatography*, 2nd edn. VCH, Weinheim: New York, 1995.
46. Doyon, G., Gaudreau, G., St.-Gelais, Beaulieu, Y., and C. J. Randall. *Can. Inst. Food Sci. Technol. J.* 24: 87–94, 1991.
47. Papadakis, E. N. and A. Polychroniadou. Application of a microwave-assisted extraction method for the extraction of organic acids from Greek cheese and sheep milk yoghurt and subsequent analysis by ion-exclusion liquid chromatography. *Int. Dairy J.* 15: 165–172, 2005.
48. McGregor, J. U. and C. H. White. Effect of enzyme treatment and ultrafiltration on the quality of lowfat Cheddar cheese. *J. Dairy Sci.* 73: 571–578, 1990.
49. Marsili, R. Monitoring chemical changes in Cheddar cheese during aging by high performance liquid chromatography and gas chromatography techniques. *J. Dairy Sci.* 68: 3155–3161, 1985.
50. Mullin, W. J. and D. B. Emmons. Determination of organic acids and sugars in cheese, milk, and whey by high performance liquid chromatography. *Food Res. Int.* 30: 147–151, 1997.
51. Panari, G. HPLC of organic acids: An approach to cheese analysis. *Milchwissenschaft* 41: 214–216, 1986.
52. Tormo M., and J. M. Izco. Alternative reversed-phase high-performance liquid chromatography method to analyze organic acids in dairy products. *J. Chromatogr. A* 1033: 305–310, 2004.

53. Kilcawley, K. N., Wilkinson, M. G., and P. F. Fox. Survey of lipolytic and glycolytic end-products in commercial Cheddar enzyme-modified cheese. *J. Dairy Sci.* 84: 66–73, 2001.
54. Buchberger, W. and K. Winna. Determination of free fatty acids by capillary zone electrophoresis. *Mikrochim. Acta* 122: 45–52, 1996.
55. Kleinhenz, J. P. and W. J. Harper. Comparison of direct capillary electrophoresis and capillary gas chromatographic methods for the analysis of lower molecular weight fatty acids in Swiss cheese. *Milchwissenschaft* 52: 200–204, 1997.
56. Koca, N., Rodriguez-Saona, L. E., Harper, W. J., and V. B. Alvarez. Application of Fourier transform infrared spectroscopy for monitoring free fatty acids in Swiss cheese. *J. Dairy Sci.* 90: 3596–3603, 2007.
57. Fredericks, P., Rintoul, L., and Coates, J. Vibrational Spectroscopy: Instrumentation for infrared and Raman Spectroscopy. In *Ewing's Analytical Instrumentation Handbook*, 3rd edn. Cazes, J., ed., Marcel Dekker: New York, 2005, pp. 163–235.



# Chapter 12

---

## Flavor Formation

---

Barbara d'Acampora Zellner, Paola Dugo,  
Giovanni Dugo, and Luigi Mondello

### CONTENTS

12.1	Brief Introduction to Dairy Flavor Formation.....	277
12.2	Flavor Formation in Milk.....	279
12.2.1	Milk Flavors Developed During Heat Treatment and Storage.....	279
12.2.2	Flavors Developed from the Autoxidation of Milk Lipids .....	280
12.2.3	Light-Induced Flavor Formation .....	281
12.2.4	Flavor Compounds Derived from Package Component Migration .....	281
12.3	Flavor Formation in Fermented Dairy Products: Cheese.....	282
12.3.1	Fermentation of Lactose and Conversion of Citrate.....	282
12.3.2	Proteolysis and Catabolism of Amino Acids.....	284
12.3.2.1	Metabolism of Branched-Chain Amino Acids.....	285
12.3.2.2	The Catabolism of Aromatic Amino Acids .....	285
12.3.2.3	Methionine and Its Catabolic Pathways .....	286
12.3.3	Lipolysis and Catabolism of Fatty Acids.....	286
12.4	Concluding Remarks .....	288
	References.....	288

### 12.1 Brief Introduction to Dairy Flavor Formation

It is widely acknowledged that milk and its derived products are characterized by a heterogeneous nature, comprising significant levels of lipids, proteins, and carbohydrates. In this respect, the classification of flavor compounds based on their polarity or volatility turns out to be a difficult task. In addition, as is well known, the flavor composition varies according to the state of the dairy



sample, so that raw milk presents a distinct flavor when compared to that of heated or processed milk, with different classes of compounds responsible for the characteristic flavor of distinct samples. Generally esters are responsible for the flavor of raw milk samples, while lactones and heterocyclic compounds for that of heat-treated and pasteurized milk. On the other hand, fermented dairy products, such as cheese and yogurt, are characterized by the presence of fatty acids [1].

It is mandatory to highlight that fermentation has a major impact on the organoleptic quality of milk-derived products. Traditionally, fermentation was primarily applied to improve and prolong shelf-life, since the growth of fermentative microorganisms typically results in the production of acids or alcohols that inhibits the growth of food pathogens or spoilage organisms preserving the food. Though the chemical transformation of components in dairy food raw materials, and the release of microbial metabolites contribute to the flavor, appearance, and texture. In dairy products, lactose, citrate, milk fat (lipids), and proteins are converted into a broad range of volatile and nonvolatile flavor compounds.

Three main pathways for the flavor formation of dairy products can be distinguished, i.e., glycolysis, proteolysis, and lipolysis [2,3] (see Figure 12.1). These processes may already generate final flavor compounds, though further reactions can occur yielding an even greater number of low-molecular weight components that essential to the overall odor of the product.

In general, flavors derived from lactose or citrate (glycolysis), such as lactic acid, acetaldehyde, and diacetyl (2,3-butanedione), are produced by the lactic flora. Lipids are also another source of a wide range of dairy flavors, and by means of lipolysis and oxidation are prone to cause hydrolytic and oxidative rancidity, respectively. In this manner, small amounts of  $\gamma$ - and  $\delta$ -hydroxy acids present in milk lipids can be readily converted to  $\gamma$ - and  $\delta$ -lactones; unsaturated fatty acids may hydrate to hydroxy acids, and then via oxidation produce  $\gamma$ - and  $\delta$ -lactones;  $\beta$ -oxidation, followed by decarboxylation, produces methyl ketones; and oxidation at double bonds can generate straight-chain aldehydes and ketones, which under reducing conditions may be converted to the corresponding alcohols. Moreover, protein-derived flavors also comprise a large amount of pathways; Strecker aldehydes, such as 2-methylpropanal, 2-methylbutanal, and 3-methylbutanal, can be synthesized via amino acids and, in turn, may produce their corresponding alcohols; and sulfur-containing compounds, such as hydrogen sulfide, methanethiol, and dimethyl disulfide (DMDS), can be derived from cysteine and methionine. In addition, other flavor origins have

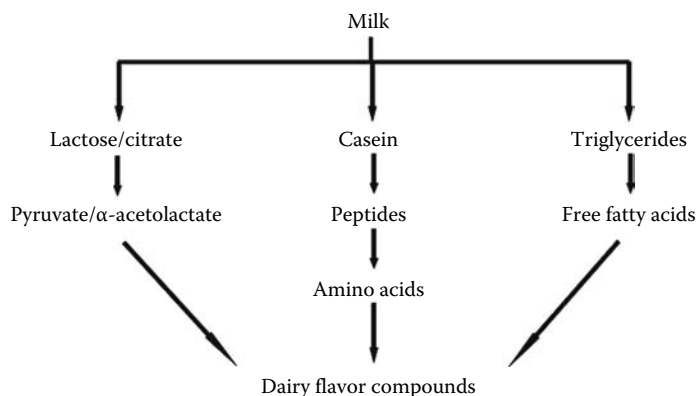


Figure 12.1 Dairy flavor formation pathways in fermented products.

been reported, such as compounds derived from lactose, without any interaction of the lactic flora, that are developed during heat treatment or that result from alkaline degradation of lactose or its components glucose and galactose, e.g., maltol [4] and 2-acetylfuran [5].

The flavor of cheeses is composed of a blend of compounds generated by all three pathways; the same is true for key-odor compounds. Cheddar [6] and Camembert [7] cheeses, for instance, have half of their potent odorants derived from lactose fermentation or citrate degradation, a very small amount produced by lipolysis, and the other half resulting from amino acid degradation (leucine and methionine).

Taking into consideration that flavor is the primary index of dairy food acceptance and is strictly related to product development and improvement, this chapter provides an overview of the dairy flavor formation pathways. Numerous dairy food flavors have been thoroughly studied, though demonstrating that even widely investigated metabolic pathways may continuously reveal new facets. In this chapter, flavor formation processes in milk and cheese will be dealt with more extensively.

## 12.2 Flavor Formation in Milk

Fresh, good quality milk is characterized by three features: a characteristic, subtle, and delicate flavor; a pleasant mouth-feel since it is an emulsion of fat globules dispersed in a colloidal aqueous solution; and a slightly sweet and salty taste due to the presence of lactose and salts. When compared to other dairy products, such as butter or cheese, the concentration of flavor compounds in fresh milk is very low.

It is widely accepted that the flavoring compounds in milk are products of the animals' metabolism, which is also influenced by the feed. As previously cited, another aspect to be considered is the sample's state, so that the flavor of raw milk is not identical to that of heated or processed milk. Esters are considered as responsible for the flavor of raw milk samples, while lactones and heterocyclic compounds for that of heat-treated and pasteurized milk [1].

Furthermore, almost all milk types and milk-derived products are submitted to heat treatments and storage over a period of time inducing flavor development. In addition, autoxidation of lipids, light exposure, and also packaging effects, may yield milk flavors. Moreover, considering that milk is composed of a multitude of compounds belonging to distinct chemical classes, several of these compounds can be precursors of flavor and off-flavor chemicals. The latter may be defined as an unpleasant odor or taste imparted to a food sample though internal deteriorative change [8].

### 12.2.1 Milk Flavors Developed During Heat Treatment and Storage

Flavor, most frequently off-flavor, development, during heat processes has been already thoroughly researched, and the formation of ketones, lactones, aldehydes, furans, alcohols, acids, and sulfur-containing compounds is widely accepted.

Ketones, such as diketones, cyclic ketones, and methyl ketones, formed in heat-processed milks, are considered as the major contributors to that of matrices cooked and stale flavors [9], while diketone compounds, diacetyl and 2,3-pentanedione, were described as significant contributors to the heated, burnt, and fermented notes elicited by heated milk [10]. With regards to diacetyl, its production is considered to be started by methyl glyoxal, generated by heating lactose, which then reacts with glycin or its derivatives forming diacetyl. Cyclic ketones, e.g., cyclopentanone and 2-methyl-tetrahydrofuran-3-one, are also considered as contributors to the heated, burnt, and fermented notes in heated milk [10].

Milk has been studied in depth by Moio et al. [11–13], who analyzed the matrix under distinct conditions. Analyses of raw bovine, ovine, caprine, and water buffalo milk samples demonstrated that dimethylsulfone, ethyl butanoate, ethyl hexanoate, heptanal, indole, nonanal, and 1-octen-3-ol are odor-active compounds common to all samples. Even though similarities between the distinct samples were found, the overall odor of each milk variety presented a different flavor profile, with ethyl butanoate and ethyl hexanoate as the most potent flavorants in cow, sheep, and goat milk, while water buffalo milk flavor was better characterized by nonanal and 1-octen-3-ol [11]. On the other hand, while investigating high-temperature/short-time (HTST) and ultrahigh temperature (UHT) pasteurized cow milk, dimethylsulfone and 2-heptanone were found to be the most potent odor-active compounds, instead of ethyl butanoate and ethyl hexanoate observed in raw cow milk. Both odorant couples, ethyl butanoate and ethyl hexanoate, and dimethylsulfone and 2-heptanone can be used as aroma quality indicators, for raw and heated milk, respectively [12].

Further compounds that are not detected in raw milk are furans, particularly furfural and hydroxymethylfurfural (HMF), the former eliciting an almond-like, sweet note, while the latter a fatty, musty, and waxy odor. Both are formed when milk is heated above 80°C by the browning of a lactose–casein mixture [14], i.e., the casein catalyzed degradation of lactose induced by heat.

The formation of aldehydes is also noteworthy during prolonged storage of casein, these compounds, particularly alkanal compounds and benzaldehyde, are responsible for an unpleasant stale off-flavor [15]. The production of alkanal compounds can be attributed to the oxidation of lipids bound by casein, while benzaldehyde can be formed by reactions occurring between phenylalanine and lactose [16,17]. Another class of compounds where formation of milk is induced by heat treatments is alcohol, most commonly represented by acetol and acetoin (3-hydroxy-2-butanone). The former is the product of carbohydrate degradation during nonenzymatic browning reactions [10], while the latter may be formed by the reduction of diacetyl [9]. Both the compounds are also detected in raw milk, and in increasing concentrations when heated above 90°C [10]. Heat treatments can also influence the profile of acids in milk; at temperatures superior to 100°C an increment may be observed in the concentrations of acetic, butyric, hexanoic, octanoic, and decanoic acids [10], contributing to the chemical and rancid flavor of heated milk.

Freshly secreted milk fat does not contain free lactones, but their precursors are present in bound form [18]. Indeed, small amounts of  $\delta$ -hydroxy alkanolic acids esterified to glycerol can be detected, which, upon hydrolysis during heating or storage, form a homologous series of saturated aliphatic  $\delta$ -lactones. The latter contribute positively to milk flavor eliciting a milky, fatty, and coconut-like note. Moreover, the cooked flavor, commonly observed in milk and derivative products is caused by hydrogen sulfide. This compound is a product of the oxidation of free sulfhydryl groups formed in the denaturation of  $\beta$ -lactoglobulin, the major whey protein of cow's milk [19].

Urbach investigated the effects of cold-storage on raw cow milk samples [20], reporting that carbonyls are reduced to the corresponding alcohols; among the most abundant ones were ethanol, 2-propanol, and 3-methylbutan-1-ol. After prolonged storage, these alcohols were partially esterified with volatile acids.

### **12.2.2 *Flavors Developed from the Autoxidation of Milk Lipids***

Milk flavors can also be developed as products of the autoxidation of lipids, rendering a food unpalatable due to a rancid or oxidized odor. In short, the nonenzymatic autocatalytic oxidation reaction of unsaturated fatty acids, most commonly polyunsaturated (oleic, linoleic, linolenic, and arachidonic acids), producing hydroperoxides, which often dismutate to secondary oxidation products, such as aldehydes, ketones, alcohols, acids, hydrocarbons, lactones, furans, and esters.

Aliphatic aldehydes are considered as the most important breakdown products of hydroperoxides, due to their major contribution to unpleasant flavors in food products. Moreover, aldehydes resulting from autoxidation may undergo other reactions, contributing further to the flavor of dairy products.

### 12.2.3 *Light-Induced Flavor Formation*

Light is known to induce metabolic reactions in dairy products, triggering the degradation of proteins or the oxidation of lipids, resulting in the formation of off-flavors. Furthermore, it is generally accepted that riboflavin plays a major role as photosensitizer in milk and milk-derived products [21]. Photosensitized oxidations produce hydroperoxides, which are prone to decompose forming free radicals, and these are responsible for autoxidation reactions and off-flavor developments. Riboflavin acts by means of two reaction modes. Type I occurs when a triplet riboflavin (electronic excited state with two unpaired electrons) is directly deactivated by the abstraction of an electron from a substrate, which is then oxidized. Subsequently, riboflavin can abstract a further electron, forming a reduced riboflavin or react with ground-state oxygen to generate a superoxide radical. Type I reaction may be exemplified by the photooxidation of lipids yielding alkanals and 2-enals, which are not present in autoxidized milk samples; while 2,4-dienals are only detected in autoxidized samples. According to Wishner [22], the oxidizing substrates in light-exposed milk are the monoene fatty acids of the triglycerides, while in spontaneously oxidized milk polyene fatty acids of the phospholipids are involved.

On the other hand, in type II reactions a triplet riboflavin is deactivated physically by oxygen, and a singlet-oxygen is formed. The latter reacts with the amino acid methionine, which then undergoes Strecker degradation forming aldehydes (e.g., methional) and sulfur-containing compounds (e.g., dimethyl sulfide). It is noteworthy that the broth and potato-like flavors produced when milk is exposed to light are mainly related to the presence of methional; though the understanding of the role of this compound in light-induced flavor is made difficult by its easy conversion to other sulfur compounds [23]. Samuelsson [24] reported that methionine in milk is converted to mercaptan, sulfides, and disulfides at pH 6.8 in the presence of light and oxygen.

### 12.2.4 *Flavor Compounds Derived from Package Component Migration*

Flavor formation may be triggered by substances transferred from the package into a dairy matrix (migrants), often monomers (e.g., ethylene glycol), residual reactants (e.g., catalyst residues), or degradation products (e.g., acetaldehyde). The migration of compounds may influence the sensory quality and acceptability of a food product. A commonly detected migrant is acetaldehyde, also known as a degradation product formed in the melting process of poly(ethylene terephthalate) (PET), which is a material that is increasingly used in milk packagings. Acetaldehyde has a pungent, ethereal odor, and is fruity and pleasant when diluted; it strongly decreases the acceptability of milk, while acting as the most important, volatile flavor compound in plain yogurt [25].

Even acetaldehyde concentrations of 10 mg/L exceed the human threshold values of 0.82 mg/L in milk, decreasing strongly the acceptability of milk. Freshly pasteurized milk contains about 10 ppb of acetaldehyde [3], which are most often detected in fermented products, e.g., yogurt at concentrations ranging from 5 to 40 mg/L [26]. Moreover, according to sensorial tests (triangle test performed by 25 panelists) no significant difference in the acetaldehyde threshold in milk of various fat contents could be observed, thresholds of 3939, 4020, and 4040 ppb were determined for

nonfat, low-fat, and whole milks, respectively, while chocolate-flavored milk showed a threshold of 10048 ppb [27]. This information assisted in the prediction of the influence of acetaldehyde migration on the flavor of milk products.

## 12.3 Flavor Formation in Fermented Dairy Products: Cheese

The compounds forming the subtle and delicate milk flavor blend are transformed, by means of fermentation, into other flavor compounds derived either from lactose fermentation and citrate conversion, protein degradation or amino acid catabolism, or lipid degradation. As a consequence, fermented milk-based products present complex, variety, and type-specific flavor profiles, presenting compounds that belong to several chemical classes, such as alcohols, aldehydes, ketones, esters, lactones, furans, nitrogen-containing compounds, as also pyrazines and sulfur-containing compounds, terpenes and their derivatives, aromatic compounds and free fatty acids (FFAs).

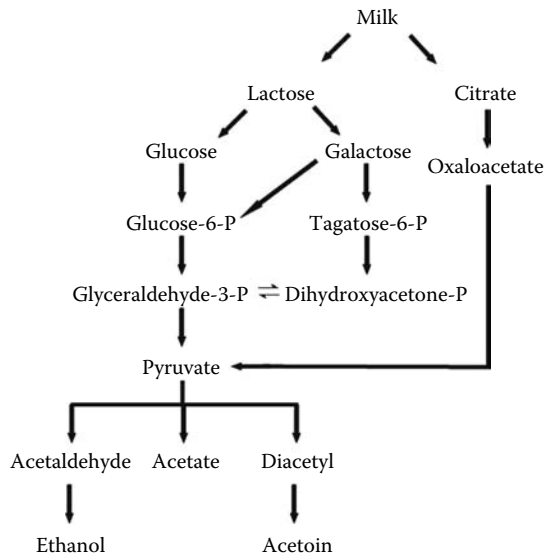
One of the most widely studied fermented products is cheese, which has more than 500 varieties [28]. Cheese manufacture consists on the addition of salt, an enzyme coagulant and a culture of a starter organism to milk, the latter is mainly represented by prokaryotes and is the principal source of enzymes involved in the biochemical processes [29]. Predominantly, lactic acid bacteria (LAB) are used as starters, comprising the homolactic (lactococci, streptococci, lactobacilli group I) and the heterofermentative genera (leuconostocci, lactobacilli group III). Within LAB a large strain-to-strain diversity can be observed in flavor formation; thousands of strains are known in the environment both in public and in private culture collections representing an important reservoir of natural diversity of phenotypes.

Additional cultures are also utilized, e.g., *Propionibacterium* in the manufacture of Swiss-cheeses, and, frequently, aerobic cultures in the production of surface-ripened cheeses, such as bacteria (*Brevibacterium*, *Arthrobacter*, and *Staphylococcus*), fungi (*Penicillium*), and yeasts (*Debaromyces*) [30]. Apart from these starter organisms, also lactobacilli originating from the milk environment might grow in dairy products, turning to be a source of enzymes involved in the formation of flavors. Nonstarter organisms (molds and surface bacterial flora) are also reported to be of relevance for flavor formation [31].

Furthermore, it is worthwhile to emphasize that even closely related bacterial strains may exhibit very different flavor-forming activities, due to the fact that (1) the genes encoding key enzymes for flavor formation is not produced by all the strains of a species; (2) different variants of a flavor-forming enzyme among strains may occur, leading to altered catalytic activities; and (3) the expression of many of the enzymes involved in flavor production is strongly subjected to regulation.

### 12.3.1 Fermentation of Lactose and Conversion of Citrate

Flavor formation during the manufacture of cheeses is initiated immediately after the addition of starter cultures to milk, also known as starter organisms. The widely utilized LAB are able to ferment lactose to lactic acid that on its own is the main flavor of several fresh cheeses. At first, lactose is hydrolyzed by starter cultures producing glucose and galactose. The former is then oxidized to pyruvate by the Emden-Meyerhof pathway of glycolysis, while the latter is converted by galactose-positive bacteria and leuconostocs through the Leloir pathway to glucose-6-phosphate, and to glyceraldehyde-6-phosphate by lactococci through the tagatose pathway (refer to Figure 12.2). The intermediate pyruvate can also be converted to various short-chain flavor compounds, such as diacetyl, acetoin, acetaldehyde, ethanol, and acetate. Diacetyl imparts a buttery, nutty flavor



**Figure 12.2 Biochemical pathways of lactose catabolism in milk.**

and is considered to be significant for the flavor of Camembert [7,32], Cheddar [33,34], Emmental [35], and cottage cheeses [36], while acetoin was considered to contribute to the flavors of Cheddar [34] and Mozzarella cheeses [11] with a sour milk-resembling odor. Moreover, acetaldehyde was described to impart a green note to Camembert [7,32] and Gruyère [37].

In addition, other starter organisms, such as heterofermentative starters, present the ability to ferment other noncarbohydrate substrates, such as citrate, producing acetaldehyde, ethanol, butan-1,2-diol, and diacetyl, yielding a more buttery flavor [36]. In citrate-utilizing LABs this substrate is initially cleaved to oxaloacetate and acetate by a citrate lyase. Moreover, in cultures of *Lactococcus* and *Leuconostoc* spp. oxaloacetate is decarboxylated to pyruvate. Two molecules of the latter are then condensed by an  $\alpha$ -acetolactate synthase, forming  $\alpha$ -acetolactate and carbon dioxide. The former is unstable, and its decarboxylation may be oxidative yielding diacetyl or non-oxidative forming acetoin, while the latter is responsible for the eye formation in some semihard cheeses [38]. It should be noted that the initial breakdown of citrate and the further conversion of the intermediate pyruvate into specific fermentation products can be regulated at different levels, according to the microorganism. As aforementioned, heterofermentative starters produce carbon dioxide that promotes an open texture. The use of *Propionibacterium freudenreichii* subsp. *shermanii*, which ferments lactose, producing propionic acid and carbon dioxide is also noteworthy; the former contributes to the characteristic flavor of Swiss-type cheese, while the latter is, as mentioned earlier, responsible for the eye formation in the cheese [39].

Nonstarter organisms may also ferment lactose producing a variety of compounds; the coliform fermentation generates formic acid, carbon dioxide, and hydrogen, the butyric fermentation leads to butan-1-ol, butyric acid, acetone, propan-2-ol, and carbon dioxide formation, and the ethanolic fermentation pathway generates ethanol and carbon dioxide. When the lactose supply is depleted, and pH, water acidity, and reducing potential are not optimal, surviving homofermentative starters may widen their range of fermentative activity. Moreover, the lactose depletion rate varies according to the cheese type; from 24 h in Swiss-type to 20 days in Cheddar cheese [40].

### 12.3.2 Proteolysis and Catabolism of Amino Acids

The important raw materials for cheese flavor generation include not only low-molecular weight compounds, as citrate and lactose, but also high-molecular weight proteins from which many of the most important flavor compounds are derived, especially in hard-type and semihard-type cheeses.

The proteolytic process is initiated by the conversion of casein to large peptides by proteases. Commonly, LAB strains produce a series of peptidases, which are able to further degrade large peptides to smaller oligopeptides and amino acids. These, on their own, contribute to the flavor promoting a sweet or brothy note. On the other hand, peptides with an undesired bitter taste may also accumulate to concentrations higher than their threshold, which may be removed by the addition of adjuncts able to reduce bitterness, the so-called debittering peptidases [41]. Furthermore, amino acid convertases trigger the formation of flavor compounds from amino acids, yielding various alcohols, aldehydes, acids, esters, and sulfur compounds.

In the past, proteolysis was considered as a rate-limiting process in the maturation of many cheeses, especially in semihard cheeses. However, it was demonstrated that enhancing the free amino acid release by intensifying peptidolysis by LAB [42] or adding free amino acids did not affect aroma formation in cheese [43], suggesting that the rate-limiting factor was not the release of free amino acids but their conversion to flavor compounds.

In general, proteolysis proceeds at a slower rate especially in cheeses that are low in moisture or have a rich salt content; both these characteristics are considered to control the maturation rate. In addition, the concentration of free amino acids was found to be closely linked to the maturity of cheeses, and was recognized as cheese flavor precursors. Amino acids are substrates for transamination, dehydrogenation, decarboxylation, and reduction, producing a wide variety of flavor compounds, or further precursors, such as amines and Strecker aldehydes (see Figure 12.3). The ability

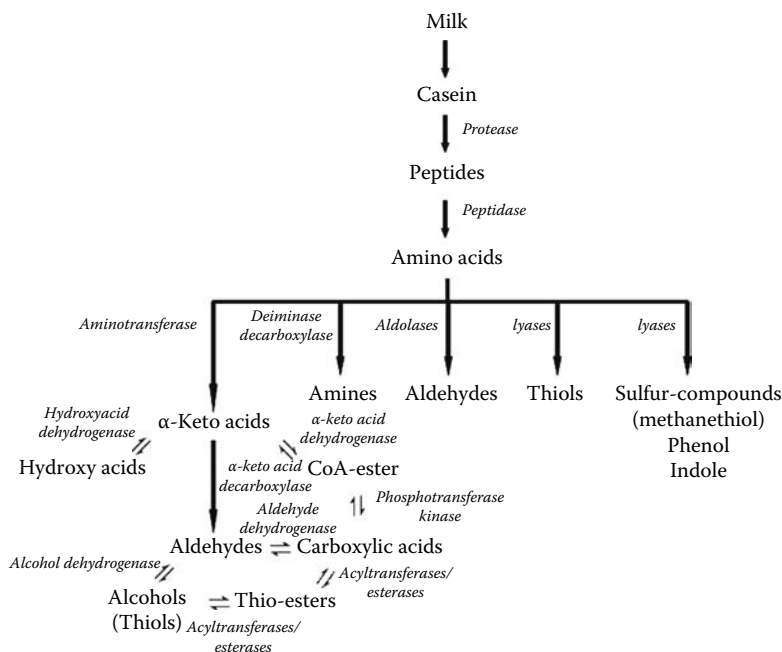


Figure 12.3 Overview of protein metabolic pathways involved in the flavor formation of fermented dairy products.

of microorganisms to generate flavor compounds from amino acids in cheese is considered to be highly dependent on strain; among the most common strains are LAB, coryneform bacteria, yeasts, and *Geotrichum candidum*, among others [44].

The study of the compounds responsible for the characteristic flavor of various cheeses demonstrated that amino acid degradation is a major process for flavor formation in cheese. Moreover, branched-chain amino acids (leucine, isoleucine, and valine), aromatic amino acids (phenylalanine, tyrosine, and tryptophan), and methionine are the major precursors of these aroma compounds [44]. In this respect, monitoring amino acid degradation during cheese ripening may be a reasonable approach to control flavor formation.

### 12.3.2.1 Metabolism of Branched-Chain Amino Acids

The catabolism of branched-chain amino acids is initiated by a transamination reaction catalyzed by amino acid aminotransferases [44]. This conversion pathway of amino acids is responsible for the transamination of leucine, isoleucine, and valine, forming  $\alpha$ -keto acids intermediates;  $\alpha$ -ketoisocaproate,  $\alpha$ -keto- $\beta$ -methyl valerate, and  $\alpha$ -ketoisovalerate, respectively. The conversion pathways of the branched-chain  $\alpha$ -keto acids, on the other hand, may involve three biochemical reactions: the oxidative decarboxylation to carboxylic acids, the decarboxylation to aldehydes, and the reduction to hydroxyacids. With the exception of hydroxyacids, all of these products present strong flavors. It has to be highlighted that the specificity of the aminotransferases may differ according to the microorganism.

The intermediate  $\alpha$ -ketoisocaproate, for instance, may be decarboxylated to 3-methylbutanal, which presents a fruity, pleasant odor at low concentrations, and green, malty, acrid, pungent odor at higher concentrations; 3-methylbutanal may undergo oxidation catalyzed by aldehyde dehydrogenases to isovaleric acid, which elicits rancid, cheesy, sweaty, and putrid notes that probably contribute to ripe cheese aroma; this is more prevalent in Camembert than in Cheddar, and is also detected in Swiss Gruyère cheese [45].

Similar reactions may also be observed for isoleucine and valine, both are decarboxylated producing the malty flavors 2-methylbutanal and 2-methylpropanal, respectively, which thereafter are oxidized to 2-methylbutyric acid and isobutyric acid. In general, fatty acids originated from branched-chain amino acids yield sweaty, rancid, fecal, putrid, and ester-resembling flavors [44]; the influence of these flavors on a cheese is based on the ratio of its concentration in that product to its threshold concentration in that same matrix. In addition, the conversion of the aldehydes produces the corresponding alcohols, 3-methyl butanol, 2-methyl butanol, and 2-methyl propanol, responsible for alcoholic and fruity flavors [46].

On the other hand, in Emmental cheese 3-methyl butanol is able to suppress the sweaty odor of butyric acid originated from lipolysis [47], and Cheddar cheese presents improved characteristics when flavor formation from branched-chain and aromatic amino acids is enhanced [48]. Besides, 3-methyl butanol also confers a pleasant odor to fresh cheese [49].

### 12.3.2.2 The Catabolism of Aromatic Amino Acids

The degradation of aromatic amino acids is initiated with a transamination step catalyzed by aminotransferases producing indole pyruvate, phenyl pyruvate, and *p*-hydroxy-phenyl pyruvate from tryptophan, phenylalanine, and tyrosine, respectively.

Elimination reactions catalyzed by amino acid lyases may also be observed when yeast, micrococci, and *Brevibacterium linens* are used. These lyases are able to cleave the side chain of tyrosine



and tryptophan, yielding in a single-step phenol and indole, respectively. Moreover, this pathway has not been detected in any LAB [50], though several of them are known to yield tyramine and tryptamine by means of enzymatic decarboxylation of tyrosine and tryptophan.

Generally, compounds derived from aromatic amino acids are responsible for the impact flavor of diverse cheeses; common flavor compounds are benzaldehyde (bitter almond resembling odor), phenyl acetaldehyde (honey-like, floral, rosy, violet-like note), phenyl ethanol (floral, rosy, violet-like odor), phenyl acetate (honey-like note), and phenyl propanoate (floral), while less pleasant notes are indole and skatole, both eliciting fecal putrid, musty odor at higher dilution, and *p*-cresol (phenolic, medicinal flavor). Phenyl acetaldehyde, for instance, is of importance for the impact flavor of Gruyère [37,51] and bovine Mozzarella cheeses [49], while phenyl ethanol apart from being one of the major volatile compounds identified in Camembert [52], is also commonly detected in soft smear cheeses [53] and was already identified in Gruyère cheese [37].

### 12.3.2.3 *Methionine and Its Catabolic Pathways*

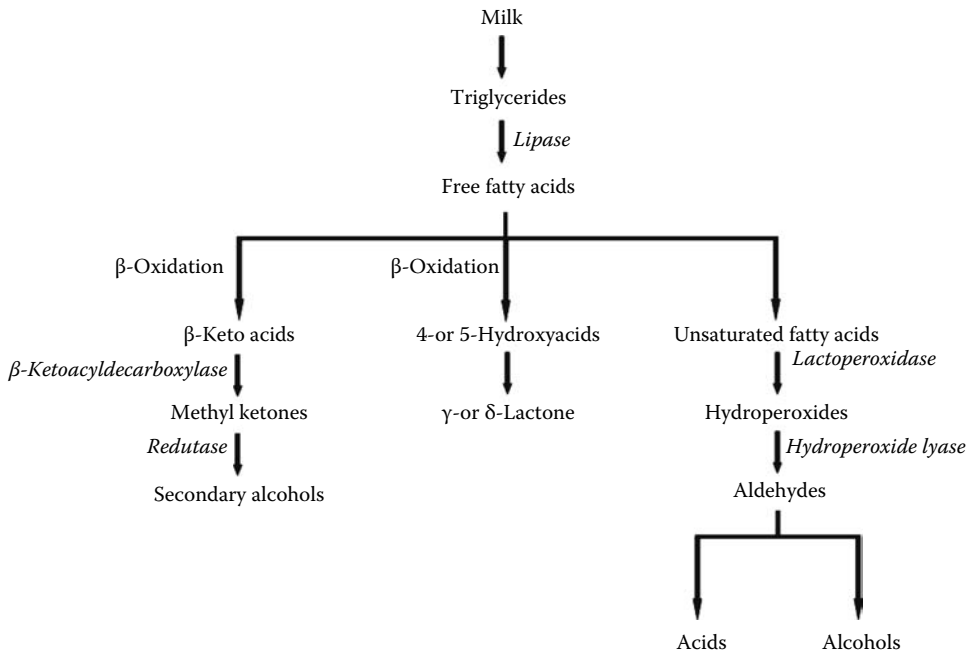
The methionine conversion to flavor compounds can proceed in different pathways. Elimination reactions (demethiolation) catalyzed by amino acid lyases yielding methanethiol can further be oxidized to DMDS and dimethyl trisulfide (DMTS). The latter is the major pathway for methionine degradation in some organisms, e.g., *B. linens*; while *Lactobacillus lactis* is capable of cleaving the side chain of methionine producing directly methanethiol. The enzymes involved in both elimination reactions are different; in *B. linens* it is the  $\gamma$ -liase, and in *L. lactis* the enzymes are not specific to methionine. A further catabolism pathway consists of the transamination catalyzed by aminotransferases and the resulting  $\alpha$ -keto acids are degraded to methanethiol via one or two (methional forming) additional reaction steps.

Methanethiol is considered as one of the responsible compounds for the characteristic flavor of Camembert [7,32] and Cheddar [33], and is also of relevance for the flavor of Gruyère cheeses [37,51]. Moreover, DMDS and DMTS were also found to contribute significantly to the flavor of the latter cheese [37], providing sulfurous and cabbage-like, sulfurous notes, respectively.

### 12.3.3 *Lipolysis and Catabolism of Fatty Acids*

Lipid degradation is an important biochemical process that occurs during cheese ripening. It is triggered by lipolytic enzymes, which are hydrolases able to cleave the ester linkage between a fatty acid and the glycerol core of the triacylglyceride (TAG), producing FFA, and monoacylglycerides and diacylglycerides. These enzymes may be classified as esterases or lipases, which are distinguished according to the length of the hydrolyzed acyl ester chain, the physicochemical nature of the substrate, and enzymatic kinetics. FFAs are not only flavor compounds by themselves, but also precursors of catabolic reactions, producing further flavor compounds, such as methyl ketones, esters and thioesters, lactones, aldehydes, and secondary alcohols, as outlined in Figure 12.4. It is worth noting that lipolysis is particularly important in soft cheeses, such as Camembert [54] and Blue cheeses [30], and especially short- and medium-chain FFAs present strong flavors that are generally considered as undesirable, but in some cheeses contribute directly to their flavors, as can be observed for Cheddar cheese [55].

In general, LAB contribute relatively little to lipolysis, but additional cultures, such as molds in surface-ripened cheeses, often exert high lipolytic activity [30], generating FFAs with 4–20 carbon atoms. The important products of the catabolism of FFAs are the methyl ketones cited earlier (alkan-2-ones), which are formed due to the action of mold lipases. The degradation of lipids by *Penicillium* spp., for instance, is started by the release of FFAs promoted by lipases, these FFA are



**Figure 12.4** Lipid catabolism pathways of some microorganisms utilized in the flavor formation of fermented dairy products.

then oxidized to  $\alpha$ -ketoacids, which are decarboxylated to alkan-2-ones, and the latter undergoes reduction yielding alkan-2-ol. Furthermore, mold cultures can also produce methyl ketones using ketoacids naturally occurring in milk at low concentrations as substrate or by the oxidation of monounsaturated fatty acids.

Methyl ketones are important flavor compounds, contributing particularly to the flavor of Blue cheese [56], with their concentration increasing until the 70th day of ripening, then decreasing substantially; similar was observed for Emmental cheese [57]. Studies performed on Camembert cheese led to the identification of 11 methyl ketones; out of these, especially, 2-nonanone (fatty, green note), 2-heptanone (fruity, fatty flavor), and 2-undecanone (herbaceous, fresh note) increased in concentration throughout the ripening process [52]. The ketone 2-heptanone has also been considered of importance for the flavor of Parmigiano Reggiano cheese, when present in concentrations above its sensory threshold [58], as also for Emmental [35] and natural and creamy Gorgonzola cheeses [59]. Another predominant methyl ketone in natural Gorgonzola [59] is also 2-nonanone. Besides, in full-fat Cheddar cheese, the concentrations of 2-heptanone, 2-nonanone, and 2-undecanone increased until about 3.5 months of ripening and then decreased, while in low-fat Cheddar types the concentration of methyl ketones are drastically lower [60].

Esters are further products of the fatty acid catabolism, and are formed by reactions between short- and medium-chain fatty acids with alcohols derived from lactose fermentation or from amino acid catabolism. A great variety of esters, imparting fruity flavors, were identified in diverse cheese types. Imhof and Bosset [31] investigated the flavor of Emmental cheese identifying 14 esters, and Meinhart and Schreier [61] detected 38 esters in Parmigiano Reggiano cheese, with ethyl ethanoate, ethyl octanoate, ethyl decanoate, and methyl hexanoate as the most abundant ones. Thioesters formed by the reaction of esters of short-chain fatty acids with methional imparted

the characteristic cheese-like aroma to Cheddar cheese [34], while *S*-methyl thioesters contribute with a characteristic strong flavor to various smear-ripened soft cheeses, such as Limburger and Havarti [62].

Lactones occur naturally in milk, and also in cheeses, but are not considered to be of great relevance to the flavor of cheeses. In Parmigiano Reggiano cheese, for instance, diverse lactones were detected,  $\delta$ -octalactone being the most significant molecule [61], while Camembert flavor comprised  $\gamma$ -decalactone,  $\delta$ -decalactone,  $\gamma$ -dodecalactone, and  $\delta$ -dodecalactone [63]. Moreover, the commonly detected  $\delta$ -decalactone is one of the most important lactones not only for the flavor of Camembert, as also for the one of Emmental [47] and Blue cheeses [63]. On the other hand, British farmhouse Cheddar cheese flavor is characterized by the presence of  $\delta$ -dodecalactone [64].

Aldehydes may also be detected in several cheese types, such as straight-chain aldehydes, specially *n*-nonanal, characterized by a green grassy odor in water buffalo Mozzarella cheese [49]. Most commonly aldehydes are transitory compounds, which rapidly reduce to primary alcohols or oxidize into the corresponding acids. In addition, the enzymatic reduction of methyl ketones may yield secondary alcohols; such as 2-propanol and 2-butanol in Cheddar cheese due to reduction of acetone and butanone, respectively [65], or 2-heptanol and 2-nonanol in mold-ripened cheeses, e.g., Camembert [52], Brie [66], and Blue cheeses [63].

## 12.4 Concluding Remarks

It is widely agreed that a single volatile compound does not elicit the characteristic flavor of a dairy product. Furthermore, it is important to outline that synergistic or suppressive effects of different flavors present in a dairy food matrix should be taken into consideration. The characteristic flavor of a cheese is defined by the so-called component balance theory [28], which is ruled by a wide range of parameters, such as cheese age, microflora, and biochemistry.

Dairy product development is nowadays directed toward new items with distinct flavors. In many cases, this requires the development of special starter cultures delivering specific flavor compounds in a selected product. It is worthwhile to highlight that the presence of starter cultures is not sufficient to explain flavor formation in raw milk cheeses and their selection has never been made with respect to the flavor criterion. Starter cultures metabolic pathways have been exploited to increase knowledge on dairy food flavor formation, and at present, diverse metabolic engineering strategies are reported providing solutions, such as metabolic interventions in *Lactococcus lactis* and other LAB improving the flavor of fermented foods. Several authors make reference to the use of tailor-made mixed cultures of known species of bacteria to provide specific dairy flavors.

Moreover, the further growing demand for new flavor compounds triggers the development and application of analytical methodologies, which are exhaustively described in Chapter 38. As is well known, the complexity of the samples that are analyzed typically mandates that some type of separation be achieved before the component analytes can be measured and characterized, in this respect the utilization of gas chromatography and mass spectrometry is widely diffused.

## References

1. Friedrich, J. E. and Acree, T. E., Gas chromatography olfactometry (GC/O) of dairy products, *Int. Dairy J.*, 8, 235, 1998.
2. Smit, G., Smit, B. A., and Engels, W. J. M., Flavour formation by lactic acid bacteria and biochemical flavour profiling of cheese products, *FEMS Microbiol. Rev.*, 29, 591, 2005.

3. Marilley, L. and Casey, M. G., Flavours of cheese products: Metabolic pathways, analytical tools and identification of producing strains, *Int. J. Food Microbiol.*, 90, 139, 2004.
4. Patton, S., The isolation of Maltol from heated skim milk, *J. Dairy Sci.*, 33, 102, 1950.
5. Patton, S., Studies of heated milk. III. Mode of formation of certain furan compounds, *J. Dairy Sci.*, 33, 904, 1950.
6. Christensen, K. R. and Reineccius, G. A., Aroma extract dilution analysis of aged Cheddar cheese, *J. Food Sci.*, 60, 218, 1995.
7. Kubíčková, J. and Grosch, W., Evaluation of potent odorants of Camembert cheese by dilution and concentration techniques, *Int. Dairy J.*, 7, 65, 1997.
8. Baigrie, B., Introduction, in *Taints and Off-Flavours in Food*, 1st edn., Baigrie, B., Ed., Woodhead Publishing Ltd., Cambridge, MA, 2003, Chapter 1.
9. Adda, J., Flavour of dairy products, in *Developments in Food Flavours*, 1st edn., Birch, G. G. and Lindley, M. G., Eds., Elsevier Applied Science, London, 1987, pp. 151–172.
10. Shibamoto, T., Flavor volatiles formed by heated milk, in *The Analysis and Control of Less Desirable Flavors in Foods and Beverages*, 1st edn., Charalambous, G., Ed., Academic Press, New York, 1980, pp. 241–265.
11. Moio, L. et al., Powerful odorants in bovine, ovine, caprine and water buffalo milk determined by means of gas chromatography–olfactometry, *J. Dairy Res.*, 60, 215, 1993.
12. Moio, L. et al., Detection of powerful odorants in heated milk by use of extract dilution sniffing analysis, *J. Dairy Res.*, 61, 385, 1994.
13. Moio, L. et al., Odorous constituents of ovine milk in relationship to diet, *J. Dairy Sci.*, 79, 1322, 1996.
14. Ferretti, A. and Flanagan, V. P., The lactose–casein (Maillard) browning system: Volatile components, *J. Agric. Food Chem.*, 19, 245, 1971.
15. Parks, O. W. and Patton, S., Volatile carbonyl compounds in stored dry whole milk, *J. Dairy Sci.*, 44, 1, 1961.
16. Ramshaw, E. H. and Dunstone, E. A., Volatile compounds associated with the off-flavour in stored casein, *J. Dairy Sci.*, 36, 215, 1969.
17. Rijnen, L. et al., Lactococcal aminotransferases AraT and BcaT are key enzymes for the formation of aroma compounds from amino acids in cheese, *Int. Dairy J.*, 13, 805, 2003.
18. Dimick, P. S., Walker, N. J., and Patton, S., Occurrence and biochemical origin of aliphatic lactones in milk fat—A review, *J. Agric. Food Chem.*, 17, 649, 1969.
19. Hutton, J. T. and Patton, S., The origin of sulfhydryl groups in milk proteins and their contribution to “cooked” flavor, *J. Dairy Sci.*, 35, 699, 1952.
20. Urbach, G., Headspace volatiles from cold-stored raw milk, *Aust. J. Dairy. Technol.*, 45, 80, 1990.
21. Bekbölet, M., Light effects on food, *J. Food Prot.*, 53, 430, 1990.
22. Wishner, L. A., Light-induced oxidations in milk, *J. Dairy Sci.*, 47, 216, 1964.
23. Allen, C. and Parks, O. W., Evidence for methional in skim milk exposed to sunlight, *J. Dairy Sci.*, 58, 1609, 1975.
24. Samuelsson, E. G., Model experiments on sunlight flavor in milk di- and tripeptides and methionine, *Int. Dairy Cong.*, A, 152, 1962.
25. Bills, D. D. et al., Effect of sucrose on the production of acetaldehyde and acids by yogurt culture bacteria, *J. Dairy Sci.*, 55, 1570, 1972.
26. Bodyfelt, F. W., Tobias, J., and Trout, G. M., *The Sensory Evaluation of Dairy Products*, Van Nostrand Reinhold, New York, 1988.
27. van Aardt, M. et al., Flavor threshold for acetaldehyde in milk, chocolate milk, and spring water using solid phase microextraction gas chromatography for quantification, *J. Agric. Food Chem.*, 49, 1377, 2001.
28. Singh, T. K., Drake, M. A., and Cadwallader, K. R., Flavor of Cheddar cheese: A chemical and sensory perspective, *Comp. Rev. Food Sci. Food Saf.*, 2, 165, 2003.
29. Hammes, W. P., Bacterial starter cultures in food production, *Food Biotechnol.*, 4, 383, 1990.

30. Molimard, P. and Spinnler, H. E., Compounds involved in the flavour of surface mold-ripened cheeses: Origins and properties, *J. Dairy Sci.*, 79, 169, 1996.
31. Imhof, B. and Bosset, J. O., Relationship between microorganisms and formation of aroma compounds in fermented dairy products, *Z. Lebensm. Unters. Forsch.*, 198, 267, 1994.
32. Kubičková, J. and Grosch, W., Evaluation of flavour compounds of Camembert cheese, *Int. Dairy J.*, 8, 11, 1998.
33. Milo, C. and Reineccius, A., Identification and quantification of potent odorants in regular-fat and low-fat mild Cheddar cheese, *J. Agric. Food Chem.*, 45, 3590, 1997.
34. Arora, G., Cormier, F., and Lee, B., Analysis of odor-active volatiles in Cheddar cheese headspace by multidimensional GC/MS/sniffing, *J. Agric. Food Chem.*, 43, 748, 1995.
35. Preininger, M., Rychlik, M., and Grosch, W., Potent odorants of the neutral volatile fraction of Swiss cheese (Emmentaler), in *Trends in Flavour Research*, 1st edn., Maarse, H. and van der Heij, D. G., Eds., Elsevier, Amsterdam, 1994, pp. 267–270.
36. Hugenholz, J., Citrate metabolism in lactic acid bacteria, *FEMS Microbiol. Rev.*, 12, 165, 1993.
37. Rychlik, M. and Bosset, J. O., Flavour and off-flavour compounds of Swiss Gruyère cheese. Evaluation of potent odorants, *Int. Dairy J.*, 11, 895, 2001.
38. Boumerdassi, H. et al., Effect of citrate on production of diacetyl and acetoin by *Lactococcus lactis* ssp. *lactis* CNRZ 483 cultivated in the presence of oxygen, *J. Dairy Sci.*, 80, 634, 1997.
39. Vangtal, A. and Hammond, G., Correlation of the flavour characteristics of Swiss-type cheeses with chemical parameters, *J. Dairy Sci.*, 69, 2982, 1986.
40. Laht, T. et al., Role of arginine in the development of secondary microflora in Swiss-type cheese, *Int. Dairy J.*, 12, 831, 2002.
41. Sridhar, V. R. et al., Identification of endopeptidase genes from the genomic sequence of *Lactobacillus helveticus* CNRZ32 and the role of these genes in hydrolysis of model bitter peptides, *Appl. Environ. Microbiol.*, 71, 3205, 2005.
42. Christensen, J. E., Johnson, M. E., and Steele, J. L., Production of Cheddar cheese using a *Lactococcus lactis* ssp. *cremoris* SK11 derivative with enhanced aminopeptidase activity, *Int. Dairy J.*, 5, 367, 1995.
43. Wallace, J. M. and Fox, P. F., Effect of adding free amino acids to Cheddar cheese curd on proteolysis, flavour and texture development, *Int. Dairy J.*, 7, 157, 1997.
44. Yvon, M. and Rijnen, L., Cheese flavour formation by amino acid catabolism, *Int. Dairy J.*, 11, 185, 2001.
45. Bosset, J. O., Collomb, M., and Sieber, R., The aroma composition of Swiss Gruyère cheese IV. The acidic volatile components and their changes in content during ripening, *Lebensm. Wissenschaft Technol.*, 26, 581, 1993.
46. Thierry, A. and Maillard, M. B., Production of cheese flavour compounds derived from amino acid catabolism by *Propionibacterium freudenreichii*, *Lait*, 82, 17, 2002.
47. Preininger, M., Warmke, R., and Grosch, W., Identification of the character impact flavour compounds of Swiss cheese by sensory studies of models, *Lebensm. Unters. Forsch.*, 202, 30, 1996.
48. Banks, J. M. et al., Enhancement of amino acid catabolism in Cheddar cheese using  $\alpha$ -ketoglutarate: Amino acid degradation in relation to volatile compounds and aroma character, *Int. Dairy J.*, 11, 235, 2001.
49. Moio, L. et al., Volatile flavour compounds of water buffalo Mozzarella cheese, *Ital. J. Food Sci.*, 5, 57, 1993.
50. Gummala, S. and Broadbent, J. R., Tryptophan catabolism by *Lactobacillus casei* and *Lactobacillus helveticus* cheese flavor adjuncts, *J. Dairy Sci.*, 82, 2070, 1999.
51. Rychlik, M. and Bosset, J. O., Flavour and off-flavour compounds of Swiss Gruyère cheese. Identification of key odorants by quantitative instrumental and sensory studies, *Int. Dairy J.*, 11, 903, 2001.
52. Dumont, J. P. et al., Etude des composés neutres volatils présents dans le Camembert, *Lait*, 538, 501, 1974.
53. Sablè, S. and Cottenceau, G., Current knowledge of soft cheeses flavor and related compounds, *J. Agric. Food Chem.*, 47, 4825, 1999.

54. Gripon, J. C., Mould-ripened cheeses, in *Cheese: Chemistry, Physics and Microbiology. 2. Major Cheese Groups*, 2nd edn., Fox, P. F., Ed., Elsevier, London, 1993, pp. 111–136.
55. Bills, D. D. and Day, E. A., Determination of the major free fatty acids of Cheddar cheese, *J. Dairy Sci.*, 47, 733, 1964.
56. Dartley, C. K. and Kinsella, J. E., Rate of formation of methyl ketones during Blue cheese ripening, *J. Agric. Food Chem.*, 19, 771, 1971.
57. Thierry, A., Maillard, M. B., and Le Quere, J. L., Dynamic headspace analysis of Emmental aqueous phase as a method to quantify changes in volatile flavour compounds during ripening, *Int. Dairy J.*, 9, 453, 1999.
58. Qian, M. and Reineccius, G., Potent aroma compounds in Parmigiano Reggiano cheese studied using a dynamic headspace (purge-trap) method, *Flavour Fragr. J.*, 18, 252, 2003.
59. Moio, L., Piombino, P., and Addeo, F., Odour-impact compounds in Gorgonzola cheese, *J. Dairy Res.*, 67, 273, 2000.
60. Dimos, A., Urbach, G. E., and Miller, A. J., Changes in flavour and volatiles of full-fat and reduced-fat Cheddar cheeses during maturation, *Int. Dairy J.*, 6, 981, 1996.
61. Meinhart, E. and Schreier, P., Study of flavour compounds from Parmigiano Reggiano cheese, *Milchwissenschaft*, 41, 689, 1986.
62. Lamberet, G., Auberger, B., and Bergere, J. L., Aptitude of cheese bacteria for volatile S-methyl thioester synthesis. II. Comparison of coryneform bacteria, Micrococcaceae and some lactic acid bacteria starters, *Appl. Microbiol. Biotechnol.*, 48, 393, 1997.
63. Gallois, A. and Langlois, D., New results in the volatile odorous compounds of French cheese, *Le Lait*, 70, 89, 1990.
64. Suriyaphan, O. et al., Characteristic aroma components of British Farmhouse Cheddar cheese, *J. Agric. Food Chem.*, 49, 1382, 2001.
65. Urbach, G., Relations between cheese flavour and chemical composition, *Int. Dairy J.*, 3, 389, 1993.
66. Karahadian, C., Josephson, D. B., and Lindsay, R. C., Contribution of *Penicillium* sp. to the flavors of Brie and Camembert cheese, *J. Dairy Sci.*, 68, 1865, 1985.



---

# TECHNOLOGICAL QUALITY

---







# Chapter 13

---

## Microstructure

---

Isabel Hernando, Isabel Pérez-Munuera,  
Amparo Quiles, and María-Angeles Lluch

### CONTENTS

13.1	Microstructure and Microscopy Techniques for Dairy Products .....	295
13.1.1	Main Microscopy Techniques .....	296
13.1.2	Protocols for the Different Microscopy Techniques .....	297
13.1.2.1	Scanning Electron Microscopy .....	297
13.1.2.2	Transmission Electron Microscopy .....	297
13.1.2.3	Light Microscopy .....	297
13.1.2.4	Cryo-Scanning Electron Microscopy .....	297
13.1.2.5	Confocal Laser Scanning Microscopy .....	297
13.2	Milk Microstructure .....	298
13.3	Dairy Products .....	299
13.3.1	Cheese .....	299
13.3.2	Other Dairy Products .....	302
13.3.2.1	Some Dairy Desserts .....	302
13.3.2.2	Cream and Butter .....	304
	References .....	305

### 13.1 Microstructure and Microscopy Techniques for Dairy Products

Milk lacks any tissue with a native structure. Its chemical components are mainly organized into casein micelles and fat globules dispersed in a watery liquid called whey or milk serum, which is its

principal component. The remaining chemical components such as salts, lactose, soluble proteins, etc., are dissolved in the whey.

As a result, the characteristic microstructure of dairy products is one where the chemical components are grouped into granules of casein (proteins), globules (fat), cells (gas or air), etc., dispersed in a continuous medium. The continuous medium can be an aqueous liquid (e.g., liquid yoghurt) or a solid matrix (e.g., a protein one, as in cheese) and can also contain other functional ingredients such as starch, hydrocolloids, or gelatin, among others (e.g., custards and creams).

### **13.1.1 Main Microscopy Techniques**

Different techniques have been used to study the microstructure of dairy foods in recent years. The main dairy food “proteins,” structured in casein micelles, and their interactions among each other and with other components of these foods can be studied using electron microscopy (EM). Two techniques that use electron beams as their source of illumination are transmission electron microscopy (TEM) and scanning electron microscopy (SEM). The TEM projects electrons through a very thin slice of the specimen and produces a two-dimensional (2D) image. TEM gives an image with high resolution (0.2–1 nm) and magnification (200–300,000×). The SEM uses an electron beam that scans the surface of the sample to generate secondary electrons that are then detected as a three-dimensional (3D) image. SEM gives intermediate resolution (3–4 nm) and magnification (20–100,000×). In both techniques, a primary fixation with aldehydes is carried out in order to observe the proteins as the main structural elements of the dairy food matrix [1].

Proteins can also be studied using light microscopy (LM), which uses visible light as its source of illumination. It has a resolution of 200–500 nm and produces a magnification of 4–1500×. Bright field observations after dyeing the proteins with appropriate dyes, such as blue toluidine, are helpful when examining these samples. Confocal scanning laser microscopy (CSLM) makes it possible to scan different depths of the sample and build up a 3D view. By CLSM, after staining with specific dyes, chemical interactions among proteins and other components cannot only be viewed two-dimensionally but also in three dimensions.

“Lipids” in milk are organized into fat globules. Some structural changes can occur in dairy products, and lipids are sometimes observed as free fat as a consequence of fat globule membrane degradation during processing. To study the structural stability of fat globules by EM, lipid particles must be fixed with glutaraldehyde and postfixed with osmium tetroxide. Staining with specific dyes such as red oil and observing using LM or CLSM makes it possible to distinguish these components and study their interactions with the other components of dairy foods during processing.

The formulations of some dairy products may include “polysaccharides.” Starch is often used as a thickening agent and its structure is usually studied by means of LM. Under polarized light, native starch granules show the typical “Maltese cross”; this disappears during gelatinization. The components of the starch granule (amylose and amylopectin) can be identified under bright field microscopy using Lugol as the dye. Other polysaccharides, such as gums and hydrocolloids, can also be identified using LM. CSLM, using the appropriate dyeing agents, allows the interactions between different hydrocolloids forming a system to be studied.

Lastly, the cryo-scanning electron microscopy (Cryo-SEM) technique can be used to study the different components in the structure of dairy foods. This technique is based on structural stabilization of food components through physical fixation (freezing at ultra low temperatures). The sample preparation is quick and easy and the technique allows the main structural components in dairy food, proteins, and lipids and their interactions with water to be observed.

## 13.1.2 Protocols for the Different Microscopy Techniques

### 13.1.2.1 Scanning Electron Microscopy

Samples (1–3 mm<sup>3</sup> cubes) are fixed with 2.5% glutaraldehyde (primary fixation) and 2% osmium tetroxide (secondary fixation) and dehydrated in a series of 10%, 20%, 40%, 60%, 80%, and 100% ethanol (ethanol/water, v/v), for 20 min in each. They are then rinsed in acetone and ultra-dehydrated with CO<sub>2</sub> by the critical point method (7.58 MPa bar, 31.5°C). Finally, the samples are coated with gold and observed in a SEM at 10–15 kV.

### 13.1.2.2 Transmission Electron Microscopy

Samples are cut into 1–3 mm<sup>3</sup> cubes, fixed (primary fixation with 2.5% glutaraldehyde and secondary fixation with 2% osmium tetroxide) and dehydrated with 30%, 50%, and 70% ethanol for 10 min. They are then embedded in a resin and the resulting blocks are cut in an ultramicrotome. The ultrathin sections obtained ( $\cong 100$  Å) are collected on copper grids and stained with 4% lead citrate to allow their observation in a transmission microscope at 100 kV.

### 13.1.2.3 Light Microscopy

There are different ways of preparing samples for LM observation, depending on the physical characteristics of the sample. Powder foods such as powdered milk can be observed directly, mounted in an appropriate dye solution. Fluid dairy foods are spread on the slide as translucent films. Lastly, solid foods can be prepared in semithin sections. If cryosections are to be obtained, samples can be quickly frozen and cut into 15–30  $\mu\text{m}$  thick sections in a refrigerated chamber at –20°C (cryocut), then collected on glass slides and stained. Sections can also be obtained after encasing the sample in a resin or wax. Resin-embedded samples are obtained following the same procedure as for TEM, but in this case using thin sections, 2–5  $\mu\text{m}$  thick, stained with the appropriate dye. Wax-embedded semithin sections (5–15  $\mu\text{m}$  thick) are prepared by fixing (ethanol 65%, 24 h), dehydrating through graded ethanol series, infiltrating with wax at 55°C, embedding in wax blocks, and sectioning in a microtome. Finally, these sections are dewaxed with solvents and stained before observation by LM.

### 13.1.2.4 Cryo-Scanning Electron Microscopy

Samples are immersed in slush nitrogen (–210°C) and transferred to a cold stage linked to a SEM operating at a temperature below –130°C. Samples are cryofractured at –180°C and etched at –80°C to –90°C. The observations in the microscope are carried out at 10–15 kV.

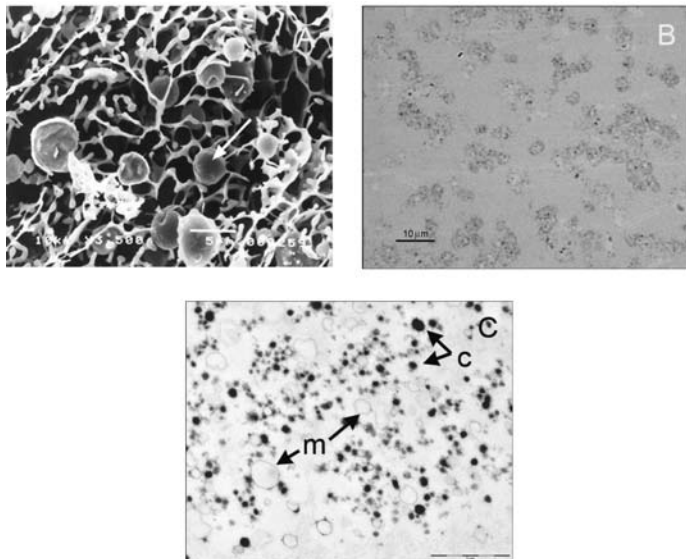
### 13.1.2.5 Confocal Laser Scanning Microscopy

Samples are usually prepared in the same way as for LM, but fluorescent probes are used as specific stains to label the different components in the dairy foods. Nile red, rhodamine, fluoroisothiocyanate (FITC), and fluorescein are some of the classic fluorophores with a wide application in CSLM. Herbert et al. [2] developed a multiple fluorescent labeling technique for proteins, lipids, and whey for CSLM in order to visualize simultaneously the different components of dairy products and to follow their evolution during milk coagulation.

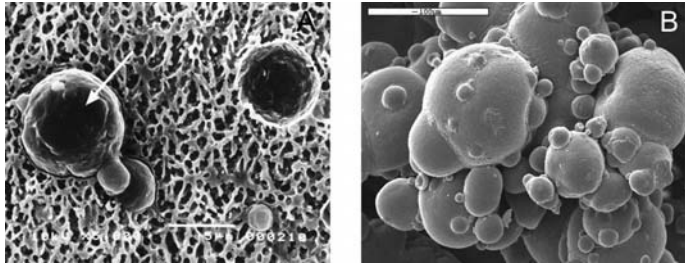
## 13.2 Milk Microstructure

Figure 13.1 shows the structure of “raw milk” examined by different microscopic techniques. Figure 13.1A, corresponding to the Cryo-SEM technique, shows a matrix composed of residual solids that is formed during the etching of the sample; this etching step is carried out in order to eliminate the superficial water that masks the underlying structures of the sample. The solids are mainly proteins: soluble proteins, such as lactoalbumin and lactoglobulin, and casein micelles. The structure of the casein micelle (about 100 nm in diameter) makes it roughly spherical. It is built of smaller units, called sub-micelles, which primarily contain casein and have a mixed composition ( $\alpha$ ,  $\beta$ , and  $\kappa$  caseins). Fat globules (diameter 1–5  $\mu\text{m}$ ) are also dispersed in the protein matrix [3]. In Figure 13.1B, obtained by LM, the casein micelles, the main structural components in milk, are stained with toluidine blue. TEM observations at higher magnification (Figure 13.1C) show the casein micelles fixed with glutaraldehyde and the fat globule membranes stained with osmium tetroxide.

Figure 13.2 shows some examples of processed milk observed by Cryo-SEM. The “ultrafiltered milk” (Figure 13.2A) shows a continuous concentrated network, mainly composed of not only casein micelles but also contain some individual fat globules (diameter 1–18  $\mu\text{m}$ ). The diameter of the fat globules is bigger than those observed in raw milk (diameter 1–5  $\mu\text{m}$ ); mechanical breakdown of the globule membrane takes place under high ultrafiltration pressures and the original fat droplets coalesce [3]. “Whole powdered milk” (Figure 13.2B) is composed of aggregated particles; this structure is generated during the thermal treatment, where water is eliminated during the atomization process. “Dried milk particles,” observed by SEM [4], widely ranged in diameter between several micrometers and several tens of micrometers, and had wrinkled exterior surfaces;



**Figure 13.1** Raw milk observed by Cryo-SEM (A), LM (B), and TEM (C). Arrow, fat globule; m, fat globule membrane; c, casein micelle. (From Lluch, M.A. et al., in *Chemical and Functional Properties of Food Lipids*, Sikorski, Z.E. (ed.), CRC Press, Boca Raton, FL, 2003, Chapter 2.)



**Figure 13.2** Ultrafiltered milk (A) and whole powdered milk (B) observed by Cryo-SEM. Arrow, fat globule. (From Lluch, M.A. et al., in *Chemical and Functional Properties of Food Lipids*, Sikorski, Z.E. (ed.), CRC Press, Boca Raton, FL, 2003, Chapter 2.)

many were hollow and porous. It was assumed that most pores were occupied by fat globules because the pores had approximately their corresponding diameters.

SEM micrographs of “concentrated milk” showed casein micelles that appeared to be granular with a rough surface as well as diffused material which was probably whey protein [5]. The effect of high hydrostatic pressure (HHP) on the concentrated milk was also studied by Velez-Ruiz et al. [5]; HHP led to the disintegration of the native protein of milk concentrates.

## 13.3 Dairy Products

### 13.3.1 Cheese

Instrumentation has developed rapidly since the 1940s to provide greater insight into cheese texture and structure. These include TEM, SEM, and CLSM in the late 1980s and atomic force microscopy (AFM), although the latter technique has not been largely applied to cheese structural studies [6].

“Cottage cheese” observed by SEM is shown in Figure 13.3. This type of cheese is made from milk serum heated to 95°C. The glutaraldehyde fixation allows the soluble proteins of milk to be coagulated and aggregated by heating so that it can be observed. The protein particles (diameter under 0.5 μm) appear not to be interacting chemically with each other, but some clusters can be observed [7].

The microstructure of “fresh cheese” fixed in glutaraldehyde and observed by SEM (Figure 13.4A) shows a continuous 3D protein network, with empty spaces which probably contain whey, air, or fat as in the original sample. Fixation in osmium tetroxide (Figure 13.4B) shows the distribution of fat in the cheese, organized into individual globules (1–3 μm in diameter).

When fresh cheese is studied using Cryo-SEM (Figure 13.4C), the continuity of the protein matrix can be observed, with the casein granules (0.2 μm in diameter) in contact with each other; the fat globules (1–5 μm in diameter), too, may be seen [8]. This technique also shows a 0.2 μm thick shell of protein deposited around the membrane of the fat globules. The shell avoids the fat migrating from the interior of the globules, which could explain why this cheese does not have an oily appearance. The empty spaces observed in this micrograph would have been occupied by air or water in the original fresh cheese.

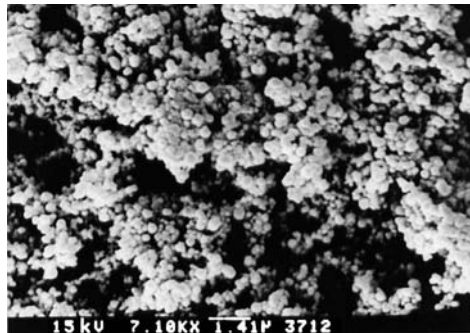


Figure 13.3 Cottage cheese observed by SEM. (From Pérez-Munuera, I. et al., *Food Sci. Technol. Int.*, 5(6), 515, 1999.)

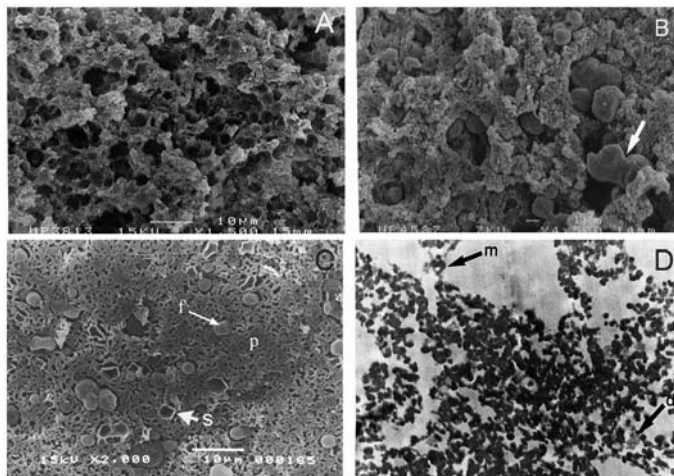
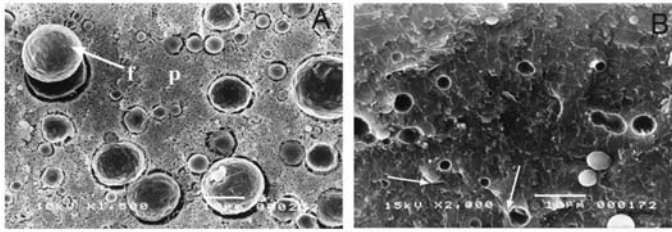


Figure 13.4 Fresh cheese observed by SEM (A, B), Cryo-SEM (C), and TEM (D). f, fat globules; p, protein matrix; s, shell of protein around fat globule membrane; m, fat globule membrane. (From Hernando, I. et al., *Food Sci. Technol. Int.*, 6(2), 151, 2000.)

TEM of ultrathin sections (Figure 13.4D) shows the individual casein granules and the interstitial spaces among them. This technique allows some fat globule membrane residues to be observed [8].

If fresh cheese is made with ultrafiltered milk (Figure 13.5A), a continuous network of protein with some occluded individual fat globules (1–18  $\mu\text{m}$  diameter) can be observed. During the manufacture of cheese, fat globules retain the size originated during the ultrafiltration process [3].

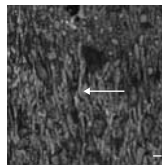


**Figure 13.5** Fresh cheese made with ultrafiltered milk (A) and fresh cheese made with pectin (B), observed by Cryo-SEM. f, fat globules; p, protein matrix; arrow, pectin interacting the protein matrix and the shell of protein around fat globule membrane. (From Lluch, M.A. et al., in *Chemical and Functional Properties of Food Lipids*, Sikorski, Z.E. (ed.), CRC Press, Boca Raton, FL, 2003, Chapter 2.)

Some hydrocolloids can be added to the dairy products in order to increase the yield during product manufacture or to avoid the syneresis phenomenon. In fresh cheese made with pectin (Figure 13.5B), the hydrocolloid is observed forming a network which interacts not only with the protein matrix, but also with the protein shell surrounding the fat globules [3].

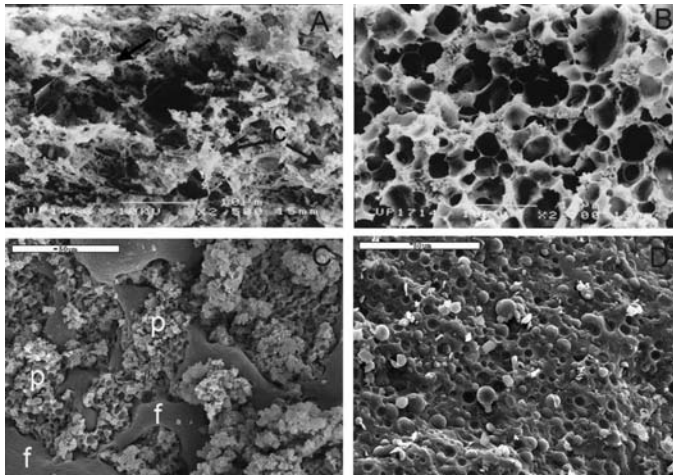
“Mozzarella cheese” is made by stretching under hot water to impart its typical melting characteristics. The elongation of protein fibers stained in green and aggregated fat globules and pools of fat in red can be seen by CSLM (Figure 13.6) [9].

Different microscopy techniques can be used to study food processes such as “cheese ripening.” When samples are fixed with glutaraldehyde and observed by SEM, the main changes in the protein structure can be studied. Figure 13.7A shows the microstructure of the curd at the beginning of the process, where the native globular character of the micelles in the granules may be seen [10]. While the ripening process progresses, the protein matrix of the cheese becomes more compact (Figure 13.7B). Fixation with osmium tetroxide shows that in ripened cheeses (Figure 13.7C), the fat appears free and in coalescence due to the breakdown of the protein shell surrounding the fat globule, an event that gives ripened cheeses an oily appearance. When the Cryo-SEM technique is used, the water can be studied interacting with the other components of the cheese. While in fresh cheeses (Figure 13.4C), the structure is composed of empty spaces that were occupied by water in the original sample, the ripened cheese (Figure 13.7D) shows a compact protein network which reflects the loss of water during the ripening process.



**Figure 13.6** Mozzarella cheese observed by CSLM. Arrow, protein matrix. Scale bar = 10  $\mu\text{m}$ . (From Rowney, M.K. et al., *Int. Dairy J.*, 14, 809, 2004.)





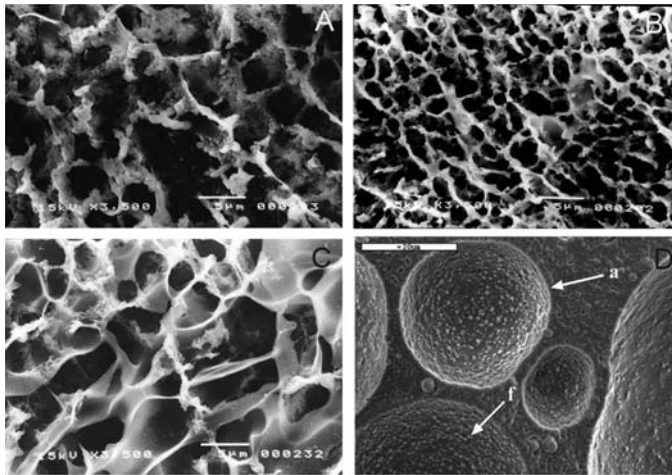
**Figure 13.7** Cheese ripening process. Curd microstructure observed by SEM (A), ripened cheese observed by SEM, glutaraldehyde fixation (B), ripened cheese observed by SEM, osmium tetroxide fixation (C), and ripened cheese observed by Cryo-SEM (D). c, casein micelles; f, fat; p, protein matrix. (From Lluch, M.A. et al., in *Chemical and Functional Properties of Food Proteins*, Sikorski, Z.E. (ed.), Technomic Publishing Co., Inc., Lancaster, PA, 2001, Chapter 2.)

## 13.3.2 Other Dairy Products

### 13.3.2.1 Some Dairy Desserts

Figure 13.8A, corresponding to “yoghurt” observed by Cryo-SEM, shows a 3D network of chains and clusters of casein granules retaining their globular shapes. The presence of skimmed-milk powder added to dairy products (Figure 13.8B) is characterized by more interconnected chains and smaller granules of casein micelles joined by thinner fibers than in the yoghurt (Figure 13.8A). The casein granules appear to be more extensively fused together and the protein network is clearly denser when milk solids are added than in the yoghurt. The addition of gelatin to a dairy product (Figure 13.8C) generates the formation of flat sheets or surfaces which interact with the casein matrix, enclosing granules of casein in several zones [11]. Sandoval-Castilla et al. [12] studied, by SEM, the microstructure of reduced-fat yoghurts elaborated using different fat replacers and concluded that the protein matrix of the reduced-fat yoghurts was in general terms more open and less dense than that of full-fat yoghurt.

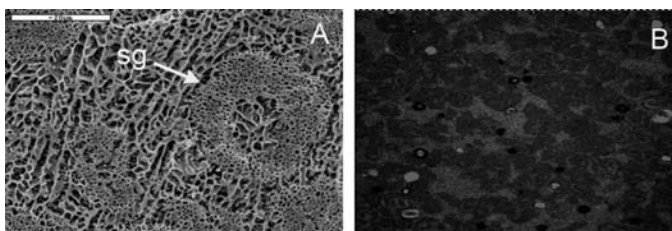
“Ice cream” is a fat-foam solid containing air as a disperse phase. Figure 13.8D shows its structure, containing a large volume of air in the form of air cells with fat globules at the interface and protruding into the air cells [3]. SEM micrographs showed a similar structure [13]: air bubbles in ice cream appeared spherical with diameters 10–50  $\mu\text{m}$  or distorted by the growth of nearby ice crystal, fat globules appeared as smaller spheres with diameters 0.2–1.0  $\mu\text{m}$  as partially coalesced clusters and ice crystals appeared as rectangles or polygons, with sizes depending on ingredients, processing, and storage conditions. TEM technique is useful to study the fat stability at higher magnifications when other ingredients such as calcium or carrageenan are added to the ice cream



**Figure 13.8** Yoghurt (A), dairy product with skimmed-milk powder (B), dairy product with gelatin (C), and ice cream (D) observed by Cryo-SEM. a, air cells; f, fat globules. (From Lluch, M.A. et al., in *Chemical and Functional Properties of Food Lipids*, Sikorski, Z.E. (ed.), CRC Press, Boca Raton, FL, 2003, Chapter 2.)

[13]. Ice cream structure can also be characterized by direct optical microscopy [14]; the ice crystal distribution can be easily studied using this technique, which has the great advantage of being easy to implement with low running costs.

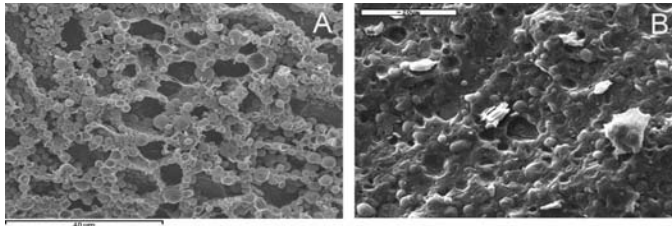
Other dairy desserts, such as “custards,” may include polysaccharides in their formulation. Although the starch is often used as a base component in these products, other hydrocolloids can be used to achieve an adequate texture. In Figure 13.9A, the structure of a custard made with full-fat milk, modified starch,  $\kappa$ -carrageenan, and sugar can be observed. The microstructure consists of isolated and collapsed starch granules immersed in a continuous matrix. This matrix would be mainly formed by macromolecules such as dairy proteins, carrageenan, and amylose from the starch granules; all of them play an important role in the development of the continuous matrix [15]. CLSM makes it possible to locate the situation of different polysaccharides in the custard. In Figure 13.9B, starch stained with rhodamine can be observed in red, while carrageenan stained with fluoroisothiocyanate is seen in green [16].



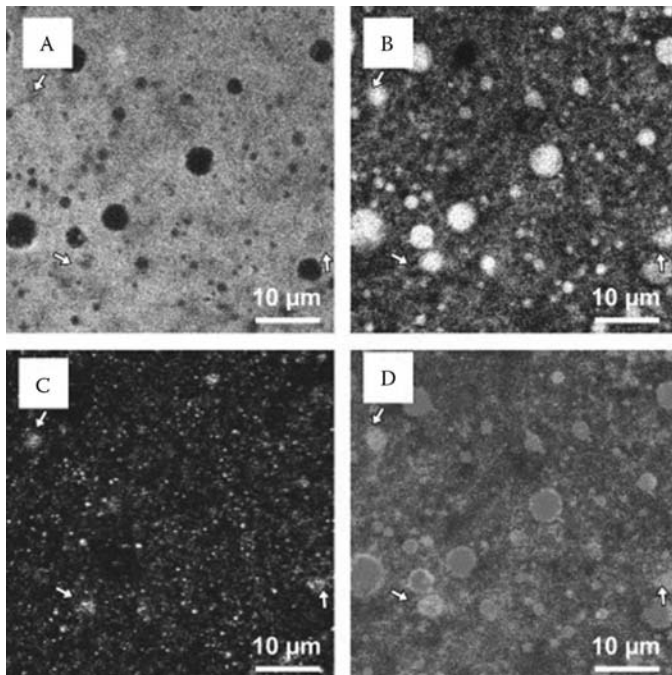
**Figure 13.9** Custard observed by Cryo-SEM (A) and CLSM (B). sg, starch granule. (From Vélez-Ruiz, J. et al., *Flavour Frag. J.*, 21, 30, 2006; Savary, G. et al., *Food Hyd.*, 22, 520, 2008.)

### 13.3.2.2 Cream and Butter

“Cream” contains 30%–50% fat. This fat is organized in globules surrounded by a protein shell, constituting a continuous matrix in which both air and water are trapped. The matrix is mainly stabilized by protein–protein interactions, although it can also be reinforced by adding hydrocolloids. Figure 13.10A shows fat globule membranes interacting with each other and voids where air was located in the original cream.



**Figure 13.10** Cream (A) and butter (B) observed by Cryo-SEM. (From Lluch, M.A. et al., in *Chemical and Functional Properties of Food Lipids*, Sikorski, Z.E. (ed.), CRC Press, Boca Raton, FL, 2003, Chapter 2.)



**Figure 13.11** Butter observed by CLSM. (A) Fluorescence of Nile red in the fat phase, (B) fluorescence of acridine orange in the water droplets, (C) reflection, and (D) the combined image of images A, B, and C. Arrow, droplet surfaces with strong reflection. (From Van lent, K. et al., *Int. Dairy J.*, 18, 12, 2008.)

“Butter” is manufactured using cream as the raw material. The ripening and subsequent whipping steps during the process break down the fat globule protein membranes, allowing fat to be released from the globule. This free fat acts as cement between the fat globules which remain intact. The microstructure of butter observed by Cryo-SEM (Figure 13.10B) shows fat globules to be embedded in a matrix of free fat [4]. CLSM provides valuable information on the microstructure of the butter; the successive staining with acridine orange and Nile red offers the possibility to distinguish between water droplets and air bubbles (Figure 13.11) [17].

## References

1. Pérez-Munuera, I.; Larrea, V.; Quiles, A.; and Lluch, M.A., Microstructure in muscle foods, in *Handbook of Muscle Foods Analysis*, Toldrá F. and Nolle L. (eds.), CRC Press, Boca Raton, FL, 2008, Chapter 19.
2. Herbert, S.; Bouchet, B.; Riaublanc, A.; Dufour, E.; and Gallant, D.J., Multiple fluorescence labeling of proteins, lipids and whey in dairy products using confocal microscopy, *Lait*, 79, 567–575, 1999.
3. Lluch, M.A.; Hernando, I.; and Pérez-Munuera, I., Lipids in food structures, in *Chemical and Functional Properties of Food Lipids*, Sikorski, Z.E. (ed.), CRC Press, Boca Raton, FL, 2003, Chapter 2.
4. Kalab, M., Microstructure of dairy foods. 1. Milk products based on protein, *J. Dairy Sci.*, 62(8), 1352–1364, 1979.
5. Velez-Ruiz, J.F.; Swanson, B.G.; and Barbosa-Cánovas, G.V., Flow and viscoelastic properties of concentrated milk treated by high hydrostatic pressure, *Lebensm.-Wiss. U.-Technol.*, 31, 182–195, 1998.
6. Everett, D.W. and Auty, M.A.E., Cheese structure and current methods of analysis, *Int. Dairy J.*, 18, 759–773, 2008.
7. Pérez-Munuera, I.; Estévez, M.; and Lluch, M.A., Study of some typical Spanish cheeses by scanning electron microscopy. Main microstructural modifications caused by freezing, *Food Sci. Tech. Int.*, 5(6), 515–521, 1999.
8. Hernando, I.; Pérez-Munuera, I.; and Lluch, M.A., Microstructural characterization of Burgos cheese using different microscopy techniques, *Food Sci. Tech. Int.*, 6(2), 151–157, 2000.
9. Rowney, M.K.; Roupas, P.; Hickey, M.W.; and Everett, D.W., Salt-induced structural changes in 1-day old Mozzarella cheese and the impact upon free oil formation, *Int. Dairy J.*, 14, 809–816, 2004.
10. Lluch, M.A.; Pérez-Munuera, I.; and Hernando, I., Proteins in food structures, in *Chemical and Functional Properties of Food Proteins*, Sikorski, Z.E. (ed.), Technomic Publishing Co., Inc., Lancaster, PA, 2001, Chapter 2.
11. Fiszman, S.M.; Lluch, M.A.; and Salvador, A., Effect of addition of gelatine on microstructure of acidic milk gels and yoghurt and on their rheological properties, *Int. Dairy J.*, 9, 895–901, 1999.
12. Sandoval-Castilla, O.; Lobato-Calleros, C.; Aguirre-Mandujano, E.; and Vernon-Carter, E.J., Microstructure and texture of yogurt as influenced by fat replacers, *Int. Dairy J.*, 14, 151–159, 2004.
13. Costa, F.F.; Resende, J.V.; Abreu, L.R.; and Goff, H.D., Effect of calcium chloride addition on ice cream structure and quality, *J. Dairy Sci.*, 91(6), 2165–2174, 2008.
14. Caillet, A.; Coiné, C.; Andrieu, J.; Laurent, P.; and Rivoire, A., Characterization of ice cream structure by direct optical microscopy. Influence of freezing parameters, *Lebensm.-Wiss. U.-Technol.*, 36, 743–749, 2003.
15. Vélez-Ruiz, J.; Hernando, I.; González-Tomás, L.; Pérez-Munuera, I.; Quiles, A.; Tárrega, A.; Lluch, M.A.; and Costell, E., Rheology and microstructure of custard model systems with cross-linked waxy maize starch, *Flavour Frag. J.*, 21, 30–36, 2006.

16. Savary, G.; Handschin, S.; Conde-Petit, B.; Cayot, N.; and Doublier, J.L., Structure of polysaccharide-starch composite gels by rheology and confocal laser scanning microscopy: Effect of the composition and of the preparation procedure, *Food Hyd.*, 22, 520–530, 2008.
17. Van lent, K.; Vanlerberghe, B.; Van Oostveldt, P.; Thas, O.; and Van der Meeren, P., Determination of water droplet size distribution in butter: Pulsed field gradient NMR in comparison with confocal scanning laser microscopy, *Int. Dairy J.*, 18, 12–22, 2008.

# Chapter 14

---

## Biosensors

---

Nóra Adányi

### CONTENTS

14.1	Biosensors: The Principle of Measurement.....	308
14.2	Proteins in Milk.....	310
14.3	Urea .....	311
14.4	Determination of Different Carbohydrates .....	311
14.4.1	Biosensors for Glucose Determination .....	311
14.4.2	Biosensors for Galactose Determination.....	312
14.4.3	Multienzyme Biosensors for Disaccharide Determination.....	312
14.5	Lipids and Fatty Acids.....	313
14.6	Vitamins .....	313
14.7	Lactate/Lactic Acid .....	313
14.8	Progesterone.....	314
14.9	Alkaline Phosphatase .....	315
14.10	Residues .....	315
14.10.1	Antibiotics .....	315
14.10.1.1	Aminoglycosides.....	315
14.10.1.2	$\beta$ -Lactam Antibiotics .....	315
14.10.1.3	Sulfonamides.....	316
14.10.1.4	Others .....	316
14.10.2	Other Drug Residues .....	317
14.10.3	Pesticides, Herbicides, Phenols, and Dioxins .....	317
14.11	Whole Cells and Bacteria .....	318
14.12	Toxins .....	318

14.13 Hydrogen Peroxide.....	319
14.14 Amino Acids, Biogenic Amines.....	319
Abbreviations.....	320
References.....	321

## 14.1 Biosensors: The Principle of Measurement

The use of immobilized enzymes has recently arisen as a powerful tool in the field of chemical analysis. Immobilized enzymes coupled with electrochemical sensors provide a new set of devices that can be used as rapid, repetitive, and cheap assays. The research of biologically active compounds connected to detector devices began with Clark's publication [1] on the oxygen electrode. Few years later, a glucose electrode was investigated by entrapping glucose oxidase (GOD) enzyme with dialysis membrane on the surface of a Clark oxygen electrode [2]. In this approach, the decrease in measured oxygen concentration was proportional to the glucose concentration. The general interest in biosensor technology was sparked by Updike and Hicks' [3] description of an enzyme electrode based on GOD deposited on an oxygen sensor. This work marked the beginning of a major research endeavor into the biotechnological and environmental applications of biosensors [4].

Biosensor is an analytical tool that responds to the presence of a specific analyte through a selective biochemical reaction by producing an electrical signal that is proportional to the concentration of the analyte. Biosensors are constructed from a bioreceptor, a detector, and a processor (Figure 14.1). The receptor is the biologically sensitive component, responsible for producing a biochemical signal that is converted into an electrical response by the detector. The biologically sensitive material may consist of enzymes, proteins, antibodies, DNA, organelles, microbial cells, mammalian, or plant tissues. The receptor is usually immobilized next to the sensor, using a wide range of immobilization techniques and bearer materials. The sensor converts the effects of the biocatalytical reaction into signals that can be electronically amplified, stored, and displayed. Changes in pH, ionic concentration, and light emission occurring due to the effect of the biocatalyst can be detected by amperometric, potentiometric, conductometric, optical, calorimetric, or piezoelectric systems [5].

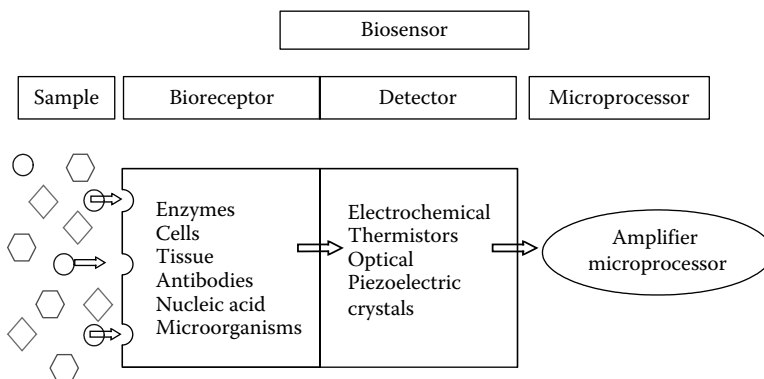


Figure 14.1 Principle of biosensor technique.

- The use of amperometric detection as the method of transduction has received most attention in the literature. Both one-shot (disposable) and online (multimeasurement) sensors have been investigated, using a wide range of immobilizing techniques and electrode systems. Amperometric biosensors measure the produced current during the oxidation or reduction of a product or reactant, usually at a constant applied potential. The most important factor influencing amperometric biosensors is the electron transfer between the catalytic molecule (usually oxidase or dehydrogenase) and the electrode surface, most often involving a mediator molecule or conducting salts or polymers. Amperometric biosensors monitor either the consumed oxygen or the produced hydrogen peroxide, both being electrochemically active, oxygen can be reduced, whereas hydrogen peroxide can only be oxidized. The current generated by the reaction will be proportional to the concentration of the measured substrate [6].
- Potentiometric biosensors are based on monitoring the potential of an electrochemical cell at a working electrode with respect to an accurate reference electrode under conditions of essentially zero current flow. Potentiometric measurements are related to the analyte activity, described by the Nernst equation. The electrochemical potential is usually proportional to the logarithm of the substrate concentration in the sample. Three basic types of potentiometric electrodes are used as measuring electrodes: ion-selective electrodes (ISEs), gas-sensing electrodes (GSEs), and field-effect transistors (FETs). Conductometric biosensors measure the change in the conductance of the biological component between a pair of metal electrodes.
- Optical biosensors are based on the measurement of absorbed or emitted light as a consequence of a biochemical reaction. Optical sensors can employ different techniques to detect the presence of a substrate using well-understood phenomena including chemiluminescence, light absorbance, fluorescence, phosphorescence, light polarization and rotation, surface plasmon resonance (SPR), optical waveguide lightmode spectroscopy (OWLS), and total internal reflectance.
- Calorimetric detectors are used to detect generated or consumed heat during the biological reaction of interest.
- Piezoelectric quartz crystal microbalance (QCM) can be affected by a change of mass on the surface of the crystal, when the crystal is placed in an alternating electric field, any change in mass is detected by the change in oscillating frequency of the crystal.

One of the most important questions in biosensor research is the method of immobilization of the biocatalyst. Several techniques have been reported; the main trends can be summarized as follows [7,8]:

- In the first applications, enzymes were enclosed with semipermeable membranes (e.g., dialysis membrane) onto the surface of the electrodes.
- Using small cross-linker molecules (e.g., glutaraldehyde [GA]) with albumin, a matrix could be formed to entrap the enzyme molecules at the electrode surface. Synthetic gels formed by cross-linking acrylamide/methacrylamide copolymers have also been used.
- Covalent binding (e.g., using 1-ethyl-3-[3-dimethylaminopropyl]carbodiimide/*N*-hydroxysuccinimide (EDC/NHS) chemistry) of the enzyme to various electrodes has been attempted.
- To achieve direct electron transfer between the flavin adenine dinucleotide (FAD) moieties of flavoenzymes (such as glucose oxidase) and an electrode, “conducting organic salts” (e.g., tetrathiafulvalinium tetracyanoquinodimethanide, TTF-TCNQ) have been used as electrode materials.



- The electrically conducting polymers are excellent materials for the immobilization of biomolecules, moreover provide rapid electron transfer for the construction of efficient biosensors.
- Incorporation of the enzyme directly onto the electrode surface by electrochemical metalization of a metal or carbon electrode.

The increasing demand for quick and reliable measurement of milk composing major compounds (as proteins, carbohydrates) or microconstituents (as progesterone, drug residues, or toxins) directs analytical science and industry to search for practical solutions, and the use of biosensors may be possible. Without aiming for completeness, we review the different types of biosensors and immunosensors investigated in the dairy industry.

## 14.2 Proteins in Milk

The main constituents of the milk protein fraction are caseins, and lactalbumin, lactoglobulin as minor components. Quality control is an important task; some of the proteins cause allergy and therefore their concentration must be controlled in the commercial products. An optical biosensor has been developed both for direct and sandwich immunoassays using polyclonal antibodies that rise against the proteins immobilized on the biosensor chip. Proteins from the samples that bound to the antibodies on the surface were detected by a shift in the resonance angle. By adding a second antibody in a sandwich assay, matrix effects could be overcome and the sensitivity and selectivity enhanced down to 1–12.5  $\mu\text{g/g}$  [9]. Inhibition biosensor immunoassays were developed for the determination of bovine  $\kappa$ -casein ( $\kappa$ -CN) for the detection of cows' milk, as well as in the milk of ewes and goats, on the basis of SPR technique by immobilizing the proper antibodies raised against bovine  $\kappa$ -CN. However, using direct biomolecular interaction analysis (BIA), the linear measuring range was improved (0.1%–10% cows' milk). The inhibition assay using  $\kappa$ -CN immobilized on the chip was preferred because of the higher responses, the higher sensitivity and its robustness (>800 cycles per chip) [10]. Different forms of casein were determined separately with immunoassays, quantifying the intact form of  $\alpha$ S1-casein ( $\alpha$ S1-CN) in milk based on the anti- $\alpha$ S1-CN antibodies directed against each extremity of the molecule. The proteolysis of  $\beta$ -casein during ripening of cheese was followed using a two-step sandwich strategy, with two anti- $\beta$ -casein antibodies directed against each extremity of the casein [11–13]. Dupont and Muller-Renaud [14] reported a method for the simultaneous quantification of the three major intact caseins with a two-step sandwich strategy, with two monoclonal antibodies directed against the N- and C-terminal extremities of each caseins. The denaturation of proteins was widely used on the base of SPR biosensor assay to control the heating systems. The denaturation index of  $\alpha$ -lactalbumin was determined by quantifying separately the native and “heat-denatured” forms of  $\alpha$ -lactalbumin with specific monoclonal antibodies [15].

The vital minor proteins as immunoglobulin G (IgG), folate-binding protein (FBP), lactoferrin, and lactoperoxidase in milk were also investigated. Biotin- and folate-supplemented infant formulas and milk powders were analyzed by SPR biosensor-based inhibition immunoassay using monoclonal antibodies. The active concentration of FBP was estimated by SPR detection of the specific interaction with a pteroyl-L-glutamic (folic) acid (PGA) derivative immobilized on the sensor surface. The detection limit was 0.13  $\mu\text{g/mL}$  in fluid milk [16,17]. Nygren et al. [18] demonstrated that since the biosensor method is based on the specific interaction between FBP and

PGA, unless a sample pretreatment to remove folate is applied, it will only determine free FBP. The difference between free FBP and bound FBP to folate can be of interest and exploited in certain situations. In a further study, the levels of FBP (total and apo-form) were determined by SPR biosensor method. There was considerable variation between the cows in the levels of total FBP (2.9–11.1  $\mu\text{g}/\text{mL}$ ), whereas the ratio between total FBP and its apo-form was relatively constant [19]. A direct and nonlabeled SPR biosensor was developed for the determination of IgG in bovine milk and colostrum with either goat or rabbit antibovine IgG or protein G used as detecting molecule. The working range was found to be 15–10,000  $\text{ng}/\text{mL}$ . Lactoferrin in bovine milk was determined by utilizing SPR detection with an antibovine lactoferrin antibody in a direct-binding assay format [20].

The low prices of some nonmilk proteins make them attractive as potential adulterants in dairy products. An SPR biosensor was used to develop a direct and combined immunoassay for the simultaneous detection of soy, pea, and soluble wheat proteins in milk powders. Affinity-purified polyclonal antibodies raised against the three protein sources were immobilized in different flow channels on the CM5 chip and the antibody-bound plant proteins were detected directly. The limits of detection in milk powder were below 0.1% of plant protein in the total milk protein content [21].

## 14.3 Urea

Verma and Singh [22] investigated a urea biosensor using immobilized urease yielding bacterial cell biomass coupled to the ammonium ISE with a response time as 2 min. Jenkins et al. [23] presented a biosensor for online measurement of urea in milk during milking process. A manometric sensor was constructed for the carbon dioxide generated by the enzymatic hydrolysis with urease.

## 14.4 Determination of Different Carbohydrates

### 14.4.1 Biosensors for Glucose Determination

GOD is the most important model enzyme in both basic and applied biosensor research because its enzymological properties are well understood and it is very cheap in comparison to other oxidases; however, the use in the dairy industry is not yet so intensive. Different design approaches have been investigated depending on the samples to be measured, including needle-type sensors, flow injection analysis (FIA) applications, combination of the glucose biosensors with microdialysis sampling technique, and disposable sensors [24,25].

Glucose was determined by an interference-free amperometric biosensor coupled with microdialysis fiber samplers based on GOD immobilized on a platinum electrode by an electroproduced bilayer of overoxidized polypyrrole. The first undercoating is polypyrrole entrapped GOD, while the second (grown onto the first), has limited glucose diffusion, improving the linear response to 500 mM [26]. Ivekovic et al. [27] investigated an amperometric glucose biosensor for the analysis of yoghurt drinks with GOD immobilized into palladium hexacyanoferrate hydrogel. An inner thin layer of nickel hexacyanoferrate was electrodeposited onto the surface of graphite electrode was used as an electrocatalyst in order to reduce the overpotential for reduction of hydrogen peroxide produced in the enzyme reaction.

### 14.4.2 *Biosensors for Galactose Determination*

Galactose oxidase (GAO) enzyme is used to develop biosensors for the determination of galactose or lactose, especially in food samples. Lundback and Olsson [28] reported on amperometric determination of galactose and lactose using GAO in an FIA system with immobilized enzyme reactors. The enzyme was immobilized on aryloamino-derivatized controlled-pore glass and packed into a reactor. Schumacher et al. [29] constructed an electrode for determination of galactose and galactose-containing disaccharides, where GAO enzyme was immobilized in gelatine between two dialysis membranes and tightened to an electrode. Malhotra et al. [30] prepared an enzymatic amperometric biosensor to measure galactose in milk and milk products by immobilizing the enzymes in Langmuir–Blodgett (LB) films of poly-3-hexyl thiophene (P3HT) mixed with stearic acid (SA) and depositing the LB film onto indium tin-oxide (ITO)-coated glass plates.

### 14.4.3 *Multienzyme Biosensors for Disaccharide Determination*

Lactose is the main sugar component in milk, but for people who suffer from lactose intolerance, dietetic milk products are produced by treatment with  $\beta$ -1,4-galactosidase. Ghamouss et al. [31] investigated a screen-printed carbon electrode (SPCE) modified with both lactate oxidase (LOD) and horseradish peroxidase (HRP) that had been developed for the determination of L-lactate concentration in real samples. Marrakchi et al. [32] investigated a biosensor of  $\beta$ -galactosidase and GOD combined with conductometric detection. Eshkenazi et al. [33] developed an electrochemical biosensor to determine lactose concentration in fresh raw milk based on serial reactions of three enzymes— $\beta$ -galactosidase, GOD, and HRP—immobilized on a glassy carbon electrode. The sequential enzymatic reactions increased the selectivity and sensitivity of the sensor. For lactose sensing,  $\beta$ -galactosidase, GAO, and GOD enzymes were entrapped on the surface of the measuring electrode with triacetate cellulose membrane, or immobilized by covalent coupling on the surface of different resins or controlled-pore glass used in analytical reactors or on protein membrane [34]. A chronoamperometric biosensor prepared by gelatin and GA immobilization of  $\beta$ -galactosidase and GOD onto a glassy carbon electrode coated with mercury thin film was developed ( $-0.2\text{ V}$  vs. Ag/AgCl) [35]. Sharma et al. [36] presented an amperometric biosensor by immobilizing lactase (EC 3.2.1.23) and GAO in LB films of P3HT/SA and used as working electrode and platinum as reference electrode. The enzyme electrodes showed linearity of 1–6 g lactose/dL and have a shelf life of more than 120 days. A manometric sensor has also been developed to measure glucose and lactose through enzymatic oxidation. The change in pressure in an enclosed cavity was correlated to the depletion of oxygen resulting from the enzymatic oxidation of glucose or lactose. The use of manometric sensors for oxidizable substrates may be preferable to optical and electrochemical methods for fluids such as milk, because they are robust and suffer low degree interferences [37].

Lactulose was found in heated milk products and was hydrolyzed to fructose and galactose by soluble  $\beta$ -galactosidase from *Aspergillus oryzae*. The amount of fructose was determined by using immobilized fructose dehydrogenase (FDH) and potassium ferrocyanide as mediator. The reduced mediator was reoxidized at a screen-printed Pt-electrode at a potential of 385 mV vs. a screen-printed Pt-pseudoreference electrode [38]. A dual enzyme ring electrode was explored onto which tetrathiafulvalen–tetracyanoquinodimethane salt was physically packed and FDH and  $\beta$ -galactosidase were immobilized with a dialysis membrane. The hydrolyzed D-fructose was oxidized by FDH which was simultaneously reduced. The detection limit of the lactulose sensor was 1.0 mM [39].

## 14.5 Lipids and Fatty Acids

Cholesterol is the most important lipid constituent in milk and dairy products, so the determination of it has a great importance. Ram et al. [40] reported a biosensor, in which cholesterol oxidase (COD) and cholesterol esterase (CE) enzymes were bound to collagen membrane or immobilized on conducting polymer matrix and amperometric detection was carried out in water phase by platinized electrodes vs. Ag/AgCl [41]. Gobi and Mizutani [42] constructed a direct amperometric biosensor by a layer-by-layer nanothin film formation using COD and poly(styrenesulfonate) on a monolayer of microperoxidase covalently immobilized on Au-alkanethiolate electrodes. Situmorang et al. [43] studied the conversion of esterified cholesterol by flow injection potentiometry using ferricyanide-mediated tungsten electrode. Buckland et al. [44] reported first that the conversion of cholesterol to cholestenone could be done in the presence of high concentration of water-immiscible solvents of low polarity. The use of carbon tetrachloride resulted in a much faster reaction rate than was observed without the presence of organic solvent. Pena et al. [45] investigated an amperometric composite biosensor for the determination of free and total cholesterol. COD and HRP, together with potassium ferrocyanide as a mediator were incorporated into a graphite–70% Teflon matrix. Free and total cholesterol content was determined in butter samples with a thin-layer cell containing COD and CE connected into a stopped-flow injection system, with amperometric detector using organic solvents [46].

The concentration of free short-chain fatty acids in milk was detected as butyric acid equivalent with a microbial biosensor. The microorganism, *Arthrobacter nicotianae*, was immobilized in Ca-alginate gel directly on the electrode surface, while the respiratory activity was monitored by oxygen consumption at  $-600$  mV vs. Ag/AgCl reference electrode [47].

## 14.6 Vitamins

BIA was evaluated for the determination of vitamin B12 with a SPR biosensor-based inhibition protein-binding assay using nonintrinsic R-protein [48].

Caelen et al. [49] developed an assay for quantification riboflavin (Rf) in dairy products using SPR measurement by measuring excess of Rf-binding protein (RBP) that remains free after complexation with Rf molecules originally present in the sample solution. The chip was modified with covalently immobilized Rf in order to bind the RBP in excess.

Pati et al. [50,51] described a method for the analysis of major choline fractions in milk and in dietary supplements. A phospholipase-packed bioreactor was connected to an amperometric biosensor in which choline oxidase was immobilized onto an electropolymerized polypyrrole film. The response for choline and phosphatidyl choline was linear up to 0.5 and 1 mM, respectively. With the addition of an acidic hydrolysis step, the concentrations of total, free, phosphatidyl-bound, and nonphosphatidyl-bound choline esters have been differentiated.

## 14.7 Lactate/Lactic Acid

L-lactic acid was determined during the production of mozzarella cheese by an electrochemical wall-jet cell biosensor where the platinum electrode was covered with the LOD enzyme [52]. In another construction, L-lactic acid was determined with bienzymatic multilayer system, where the inner layer HRP was cross-linked with poly(allylamine) containing an osmium complex, and

the outer layer containing LOD was immobilized in polymeric matrices [53,54]. Palmisano et al. [55] investigated a disposable biosensor, where the biosensing layer of LOD was cast on an underlying electropolymerized layer of overoxidized polypyrrole. The introduction of a microdialysis membrane-based sampler increased the sensitivity to  $7.9 \pm 0.2$  mM. Zaydan et al. [56] studied the fermentation capability of milk samples by using a bioreactor employing bacteria (*Streptococcus thermophilus*) encapsulated in Ca-alginate beads coupled with an L-lactate biosensor containing HRP/FcH-modified electrode ( $-100$  mV vs. Ag/AgCl). Carbon paste electrodes were modified with baker's yeast *Saccharomyces cerevisiae* and were investigated as amperometric biosensors for lactic acid. The yeast cells remained viable at least for 1 month [57]. A microbial biosensor, using *Acetobacter pasteurianus* cells and an oxygen electrode, was developed where the bacterial cells were retained on a nylon membrane and attached to the surface of the oxygen electrode [58].

Montagné and Marty [59] developed a bienzyme sensor for the determination of D-lactate. The D-lactate dehydrogenase, NADH oxidase, and NAD<sup>+</sup> coupled to dextran was fixed and covered by a dialysis membrane. The measurement was conducted using hexacyanoferrate(III) as an electron relay.

## 14.8 Progesterone

The determination of milk progesterone as an accurate indicator of ovulation has a great importance, so different types of biosensors were investigated. A lateral flow immunoassay was introduced for measuring progesterone by producing test strips from polyester-backed nitrocellulose membrane on which antigen-capture with antigen-competition was used with HRP as the enzyme label. The signals were detected by measuring transmittance with a light-emitting diode at 645 nm [60]. An improved immunoassay was developed by antiprogesterone coating on small disks of nitrocellulose membrane, which were inserted in the reaction chamber prior to testing. An antigen capture format was used with HRP-labeled progesterone as competitor and tetramethylbenzidine as chromophore (645 nm) [61,62]. A disposable, single-use biosensor as a SPCE coated with antibodies, has been developed. After the competitive binding of sample/conjugate (alkaline phosphatase [ALP]-labeled progesterone mixture) a steady-state amperometric baseline current was established. In the case of 1-naphthyl phosphate as substrate, 1-naphthol was detected by chronoamperometry (at  $+0.20$  V), by cyclic voltammetry vs. saturated calomel electrode, or by amperometry ( $0.3$  V vs. Ag/AgCl) [63–65]. Xu et al. [66] detected the amperometric signal in the presence of *p*-nitrophenylphosphate using either colorimetric assays or cyclic voltammetry. Velasco-Garcia and Mottram [67] developed a fully automated system with a disposable screen-printed amperometric progesterone biosensor using the same labeling system as mentioned earlier and producing a signal that is inversely proportional to the concentration of unlabeled progesterone in milk. Carralero et al. [68] reported an amperometric immunosensor using a colloidal gold-graphite-Teflon-tyrosinase composite electrode with a linear measuring range of 0–40 ng/mL.

Gillis et al. [69,70] developed a rapid inhibition immunoassay based on SPR technique, where progesterone was covalently bound to the carboxymethyl dextran matrix of a CM5 sensor chip. A fixed amount of monoclonal antiprogesterone antibody was mixed in the ratio of 9:1 with the sample and the amount of free antibody was then determined. When both the absolute sample volume and the antibody dilution were increased, sensitivity was improved. A total internal reflectance fluorescence (TIRF) biosensor was developed as a binding-inhibition test with a progesterone derivative covalently immobilized on the sensor surface and a monoclonal antiprogesterone antibody as biological recognition element [71].

## 14.9 Alkaline Phosphatase

Lipase and ALP in milk are thermally instable, whereas acid phosphatase is relatively stable; therefore ALP is used to distinguish raw milk from pasteurized milk because its activity is easier to be determined than that of lipase. An amperometric graphite–Teflon composite tyrosinase biosensor was built for the rapid monitoring of ALP using phenyl phosphate as substrate. The produced phenol was monitored at the tyrosinase composite electrode through the electrochemical reduction of the *o*-quinone to catechol. A linear calibration plot was obtained for ALP between  $2.0 \times 10^{-13}$  and  $2.5 \times 10^{-11}$  M, with a detection limit of  $6.7 \times 10^{-14}$  M [72].

## 14.10 Residues

### 14.10.1 Antibiotics

The  $\beta$ -lactam antibiotics, including penicillins, are the most important antimicrobial substances used for mastitis treatment. Consequently, this is also the most frequently occurring type of antibiotic residues in milk. On the other hand, elimination of microflora by physical methods is not always possible therefore the use of antimicrobial agents is often required.

#### 14.10.1.1 Aminoglycosides

For the determination of gentamicin residues antigentamicin monoclonal antibodies immobilized on the surface of SPR sensor chip was reported as the first single antibody based and label-free noncompetitive immunoassay, showing 50% binding in butter and milk at 20 and 35 ng/mL, respectively [73]. Inhibition assays with SPR detection were investigated for detection of streptomycin and dihydrostreptomycin residues in whole milk, where a streptomycin derivative was immobilized on the reusable sensor chip surface [74]. The antibody resulted excellent cross-reactivity with dihydrostreptomycin (106%), but there was no significant cross-reaction with other aminoglycosides or common antibiotics [75]. In combination with a mixture of four specific antibodies a four flow channels SPR sensor was built for the simultaneous detection of the five relevant aminoglycosides (gentamicin, neomycine, kanamycin, streptomycin, and dihydrostreptomycin) in skimmed milk [76].

#### 14.10.1.2 $\beta$ -Lactam Antibiotics

Gaudin et al. [77] constructed an SPR biosensor using commercial antibody against ampicillin, which had much higher affinity for open beta-lactam than for ring. Two different pretreatments (enzymatic with penicillinase and chemical) were tested to open the ring in order to increase the sensitivity. The enzymatic pretreatment was much easier to perform and led to more reproducible results, however the chemical pretreatment resulted in improved detection limit. A microbial receptor protein with enzymatic activity of carboxypeptidase was used as a detection molecule in the SPR assay. The carboxypeptidase converted tripeptides into dipeptides, a reaction which was inhibited in the presence of active (intact)  $\beta$ -lactams. Polyclonal antibodies against the two type peptides were developed to measure either the decrease or increase of enzymatic product formed. The limit of detection for penicillin G in milk samples was  $2.6 \mu\text{g}/\text{kg}$  [78–80]. After further investigation, an SPR assay using a general sensor surface was developed where a hapten molecule (HI)

was immobilized. First the sample was mixed with the developed microbial receptor protein, then together with a conjugate between cephalosporin C and a monoclonal HI antibody was injected to the sensor surface. The receptor inhibited by  $\beta$ -lactam residues did not bind to the sensor surface and the reduction in response was inversely related to the  $\beta$ -lactam concentration of the sample [81]. Cacciatore et al. [82] developed an assay for  $\beta$ -lactam antibiotics based on the inhibition of membrane-bound enzymes (penicillin-binding proteins, PBPs). The complexes formed were detected in a biospecific interaction assay with an antibody against digoxigenin immobilized on the SPR sensor chip. Although binding of matrix components to the sensor chip (nonspecific binding) occurred, benzylpenicillin, ampicillin, amoxicillin, cloxacillin, cephalexin, and cefoprazone could be detected in defatted bulk raw milk samples. Galindo et al. [83] investigated an electrochemical biosensor for penicillin determination. *Escherichia coli* harboring the multicopy plasmid pBR 327, which codes for  $\beta$ -lactamase synthesis, was immobilized on acetylcellulose membranes, which was placed on a flat pH electrode. A linear detection range between 5 and 30 mM of penicillin was achieved. Pellegrini et al. [84] presented a novel application of an electrochemical biosensor based on carbon dioxide production rate in relation to inhibition of microbial growth (*E. coli*).

#### 14.10.1.3 *Sulfonamides*

Sulfonamides (SMZs) are one of the oldest groups of antimicrobial compounds and used as veterinary therapeutic agents, hence they may be present in milk samples. To determine the SMZ residue in milk, an SPR sensor was built by covalently immobilizing SMZ onto a carboxymethyl-dextran-modified gold film on the surface. Polyclonal SMZ antibodies were added to samples and free antibodies were detected. No cross-reactivity of antibodies with other antibiotics was found [85]. A general capturing surface mentioned earlier was designed, where the immobilization of biomolecules is expected to be independent of the type of analyte. The monoclonal antibodies against the HI molecules were immobilized and used to capture a conjugate between HI and SMZ. The polyclonal SMZ antibodies were added to the milk sample and the amount of antibodies bound to the surface was in inverse proportion to the SMZ concentration in the milk sample. The detection limit was 0.5  $\mu\text{g}/\text{kg}$ . The advantages of the new assay format include analyte-independent immobilization and regeneration. Furthermore, the assay enables measurements with covalent interactions between the analyte and detecting molecule. The main disadvantage is the requirement of a conjugate between analyte and the HI [86].

Möller et al. [87] developed an indirect tetracycline assay using SPR detection. The principle of the new strategy was based on the most important resistance mechanism against tetracycline in Gram-negative bacteria. Tetracyclines release the 46.6 kDa Tet repressor protein from the tet operator, a biotinylated short double-strand DNA sequence was bound to a streptavidin biosensor chip. Tetracyclines present in a sample solution bind to the repressor protein, inducing a conformational change accompanied by a reduction of the affinity constant of Tet repressor protein and tet operator.

#### 14.10.1.4 *Others*

A LOD-based amperometric biosensor was investigated for rapid determination of chloramphenicol (CAP) and penicillin residues in raw milk. Adding LOD into reaction cells, containing air-saturated lactate solution, caused typical S-shaped decrease of the sensor signal in time. Both CAP

and penicillin inhibited the reaction, but they changed the total signal in different ways. The shift of the combined total signal change parameter at the simultaneous presence of these antibiotics indicated their antagonistic effect [88]. Competitive immunochemical screening assays using SPR have been developed for CAP and CAP glucuronide residues in cows' milk [89,90] while Adányi et al. [91] compared the determination of CAP with QCM and OWLS detection.

A biosensor for determination of enrofloxacin was developed using SPR technology and employed a gold-coated glass surface on which denatured DNA was immobilized in alternate layers with a cationic polymer. In performance tests the biosensor demonstrated an almost linear response with enrofloxacin up to 20 µg/mL, and with detection limit for the antibiotic in milk samples of 3 µg/mL. In another application a SPR biosensor was developed where heating denatured DNA was immobilized on the gold-coated glass surface by a layer-by-layer codeposition with a cationic polymer [92].

Knecht et al. [93] presented a parallel affinity sensor array (PASA) for the rapid automated analysis of 10 antibiotics in milk, using multianalyte immunoassays with an indirect competitive enzyme-linked immunosorbent assay (ELISA) format. Microscope glass slides modified with 3-glycidyloxypropyl trimethoxysilane (GOPS) were used for the immobilization of protein conjugates of the haptens as spots on disposable chips. A second antibody labeled with HRP generating enhanced chemiluminescence, which was recorded with a sensitive charge-coupled device (CCD) camera, detected antibody binding. Link et al. [94] designed an easy-to-handle dipstick assay for detection of antibiotic levels based on bacterial transcriptional regulators (TetR, PIP, E). The generic dipstick consisted of either nitrocellulose, nylon, or polyvinylidene fluoride membrane strips coated with streptavidin and immobilized biotinylated operator DNA. Antibiotics present in specific samples triggered the dose-dependent release of the capture DNA–biosensor interaction, which resulted in a correlated conversion of a chromogenic substrate by a standard His6-targeted enzyme complex. The results were quantified in comparison with the color of dipstick to a standardized color scale at 450 nm.

### 14.10.2 Other Drug Residues

Samsonova et al. [94] reported a sensitive immunoassay for determination of ivermectin, a broad-spectrum antiparasite residue in bovine milk. An SPR sensor was used for the experiment, with the detection limit of 16.2 ng/mL. Crooks et al. [95] determined levamisole residues, levamisole was widely used for the control of gastrointestinal parasites. The conjugate of the drug was immobilized onto the sensor in the SPR instrument and the binding of the antibody to the sensor chip surface was inhibited in the presence of levamisole.

Immonen and Karp [96] introduced a method for determining ultralow amounts of nisin (polycyclic peptide used as food preservative) applying luminescent biosensor bacteria. Modified bacterial luciferase operon luxABCDE was placed under control of the nisin-inducible nisA promoter in plasmid pNZ8048 and transformed into *Lactococcus lactis* strains. The resulting luminescence could directly be measured in living bacteria without the addition of exogenous substrates with sensitivity of 0.1 pg/mL in pure solution and 3 pg/mL in milk.

### 14.10.3 Pesticides, Herbicides, Phenols, and Dioxins

A biosensor test based on disposable screen-printed electrodes (SPEs) was developed for the monitoring organophosphate and carbamate residues in foods with increased fat contents such as milk



with a special combination of wild-type acetylcholinesterase with three engineered variants to enhance sensitivity [97]. Nikolelis et al. [98] described an electrochemical FIA inhibition sensor for the determination of carbofuran in foods. Air-stable lipid films supported on a methylacrylate polymer incorporating acetylcholinesterase enzyme was used for the determination of the degree of inhibition caused by the presence of the pesticide. Shan et al. [99] developed a stable amperometric biosensor for phenolic compounds, using polyaniline–polyacrylonitrile composite matrix in which the benzoic acid affected inhibition on the biocatalytic activity of the polyphenol oxidase to its substrate (catechol). The proposed biosensor detected levels of benzoic acid as low as  $2 \times 10^{-7}$  M.

Mascini et al. [100] investigated a QCM method modified with synthetic oligopeptides, designed as biomimetic traps, to obtain piezoelectric sensors selective to dioxins. The cross-reactivity of the system was quantified spiking the samples with commercial polychlorinated biphenyls (PCBs) and a mixture of PCBs and dioxins.

## 14.11 Whole Cells and Bacteria

Chang et al. [101] developed a remote monitoring system with a QCM sensor for the determination of the bacteria population in raw milk. Immersion of the electrodes in a cell culture with bacteria inoculums resulted in a change of frequency caused by the impedance change due to the microbial metabolism and the adherence of bacteria on the surface of the electrodes. The calibration curve of bacteria density showed a linear correlation over the range of  $70 \times 10^6$  colony-forming unit (CFU)/mL. Lakshmanan et al. [102] developed a magnetoelastic sensor with immobilized bacteriophage for the detection of *Salmonella typhimurium* in fat-free milk. Upon exposure to the target pathogen, the response of the phage-immobilized magnetoelastic sensor changed, which was quantified by the shift in the sensor's resonance frequency. A QCM biosensor was developed for the detection of *Listeria monocytogenes* by immobilizing the antibody on the gold surface of the crystals [103]. An SPR biosensor using specific antibodies was developed to detect *E. coli* O157:H7 spiked in milk with a sensitivity of  $10^2$ – $10^3$  CFU/mL [104].

The fermentation process of milk inoculated with bacteria was monitored amperometrically using an L-lactate biosensor in an FIA system. The effect of *Enterococcus faecalis*, *Bacillus coagulans*, *Enterobacter sakazakii*, *Staphylococcus aureus*, and *Bacillus sphericus* was investigated [105]. A QCM biosensor for detecting *S. aureus* cells was demonstrated. *S. aureus* cells expressed protein-A at their surface, and this protein was detected by binding to human IgG immobilized on an aminosilane-derivatized sensor surface [106]. Akerstedt et al. [107] developed an alternative method for the determination of the somatic cell count (SCC) with SPR technology measuring the interaction between acute phase protein, haptoglobin, and hemoglobin.

## 14.12 Toxins

Aflatoxin B1 in animal feed converts in part to a hydroxylated compound, aflatoxin M1, which appears in the milk of lactating cows and are highly stable during normal milk-processing procedures. Cucci et al. [108] presented a compact fluorometric sensor with a light-emitting diode (LED) source and a highly sensitive photomultiplier tube (PMT) detector for the selective detection of native fluorescence of aflatoxin M1 in liquid solutions, enabling the detection of concentrations up to the legal limit (50 ppt). Disposable electrochemical aflatoxin M1 immunosensors

were constructed by immobilizing the antibodies directly on the surface of SPEs allowing the competition between free aflatoxin M1 and that conjugated with HRP enzyme. Chronoamperometry was used for the detection ( $-100$  mV), with a detection limit of 25 ppt [109]. For one-shot devices the transduction of interactions of aflatoxin M1 with bilayer lipid membranes composed from egg phosphatidylcholine was used for the direct electrochemical sensing, with a measuring range of 2–15 nM [110].

Besides aflatoxin M1 the presence of staphylococcal enterotoxin A (SEA) and staphylococcal enterotoxin B (SEB) was also detected. An SPR biosensor was evaluated for the detection of SEB in milk in two modes of operation, as direct detection of SEB and sandwich assay. According to the results, both methods were found to be applicable for milk samples, the limit of detection was 5 ng/mL measured directly (without amplification), while 0.5 ng/mL using sandwich assay [111]. Rasooly and Rasooly [112] used SPR as sandwich-type biosensor assay for real-time detection of SEA in milk utilizing two antibodies. BIA connected to mass spectrometry was applied for SEB determination. This two-step approach utilized SPR to detect the binding of the toxin(s) to antibodies immobilized on the surface of the chip followed by identification of the bound toxin(s) by matrix-assisted laser desorption/ionization time-of-flight mass spectrometry (MALDI-TOF). The SEB was detected in milk at levels of 1 ng/mL [113].

### 14.13 Hydrogen Peroxide

Mastitic milk is known to degrade hydrogen peroxide at a higher rate than milk from healthy cows due to increased enzymatic, i.e., catalase activity. Amperometric measurement was performed by using sensors based on injection of the recognition element (SIRE) instrument using a two-point differential mode, evaluating the signal difference between the electrode in contact with the sample alone and the sample with the selected enzyme [114]. A bioelectrode was investigated as a gold disk electrode modified with mercaptopropionic acid (MPA) self-assembled monolayer (SAM) and HRP was immobilized together with GA and tetrathiafulvalene as mediator [115], while in another construction HRP was immobilized onto a membrane of regenerated silk fibroin [116]. Valdés Garcia et al. [117] reported an HRP-ferrocene-modified carbon paste electrode (CPE) biosensor coated with a layer of electrochemically generated poly(*o*-aminophenol). Catalase enzyme was immobilized by entrapping in cellulose acetate beads. This organic matrix is mechanically stable and can be used under various conditions [118]. Ozturk et al. [119] developed a biosensor using homogenized artichoke (*Cynara scolymus* L.) tissue with catalase activity, immobilized with gelatine by GA and fixed on a pretreated Teflon membrane on a dissolved oxygen electrode.

### 14.14 Amino Acids, Biogenic Amines

D-Amino acids are important markers of bacterial contamination of food products, in the case of milk analysis the aging effects could be monitored by following the level of L- and D-amino acids. Sarkar et al. [120] investigated a cheap and simple assay using SPE amperometric sensor incorporating L- and/or D-amino acid oxidase, where the working electrode was modified with rhodinized carbon, to facilitate hydrogen peroxide oxidation at a decreased operating potential. The devices responded to all 20 common L-amino acids and all of the D-amino acids excepting L- and D-proline. Wcislo et al. [121] constructed an SPE sensor by the immobilization of D-amino acid oxidase with bovine serum albumin (BSA) and GA on a graphite working electrode of a screen-printed strip

modified with Prussian Blue and Nafion layers. Additional modification of the graphite electrode with carbon nanotubes led to a significant enhancement of the signal intensity. D-Amino acid oxidase from *Rhodotorula gracilis* was used in amperometric and colorimetric biosensor, where the linear response was between 0.2–3 and 0.1–1 mM D-alanine for the amperometric (+400 mV vs. Ag/AgCl) and colorimetric system, respectively [122]. Following the relative amount of D-alanine, D-aspartate, and D-glutamate, the results allowed to discriminate between Italian cheeses and also the age of the cheese itself could be determined [123].

The QCM sensors were modified by a plasma-based electron beam generator in order to detect the level of the biogenic amine histamine within different food samples (wine, cheese, fish, etc.). Cysteamine and ethylenediamine were used as precursors in the plasma. The frequency shifts of the prepared sensors by plasma polymerization of ethylenediamine and cysteamine were approximately 3230 and 5630 Hz, respectively, whereas the frequency change of the unmodified crystal surface was around 575 Hz [124].

## Abbreviations

ALP	alkaline phosphatase
BIA	biomolecular interaction analysis
CAP	chloramphenicol
CE	cholesterol esterase
CFU	colony-forming unit
COD	cholesterol oxidase
CPE	carbon paste electrode
EDC	1-ethyl-3-[3-dimethylaminopropyl]carbodiimide
FAD	flavin adenine dinucleotide
FBP	folate-binding protein
FcH	ferrocene
FDH	fructose dehydrogenase
FIA	flow injection analysis
GA	glutaraldehyde
GAO	galactose oxidase
GOD	glucose oxidase
GOPS	3-glycidyoxypropyl trimethoxysilane
Hp	haptoglobin
HRP	horseradish peroxidase
IgG	immunoglobulin G
ITO	indium tin-oxide
LB	Langmuir–Blodgett
LOD	lactate oxidase
MPA	mercaptopropionic acid
NHS	<i>N</i> -hydroxysuccinimide
OWLS	optical waveguide lightmode spectroscopy
PCB	polychlorinated biphenyl
PGA	pteroyl-L-glutamic (folic) acid
QCM	quartz crystal microbalance
Rf	riboflavin

RBP	Rf-binding protein
SAM	self-assembled monolayer
SCC	somatic cell count
SEA	staphylococcal enterotoxin A
SEB	staphylococcal enterotoxin B
SMZ	sulfamethazine
SPCE	screen-printed carbon electrode
SPE	screen-printed electrodes
SPR	surface plasmon resonance
$\alpha$ S1-CN	$\alpha$ S1-casein
$\kappa$ -CN	$\kappa$ -casein

## References

- Clark L.C. Jr. Monitor and control of blood and tissue oxygen tensions. *Trans. Am. Artif. Intern. Organs* 2, 41–48, 1956.
- Clark L.C. Jr., Lyons, C. Electrode systems for continuous monitoring in cardiovascular surgery. *Ann. N. Y. Acad. Sci.*, 102, 29–45, 1962.
- Updike, S.J., Hicks, G.P. The enzyme electrode. *Nature*, 214, 986–988, 1967.
- Malhotra, B.D., Chaubey, A. Biosensors for clinical diagnostics industry. *Sens. Actuators B-Chem.* 91, 117–127, 2003.
- Gürtas, F. Use of on-line biosensors in food industry. *J. Qafqaz Univ.*, 1, 138–150, 1997.
- White, S. Biosensors for food analysis. In *Handbook of Food Analysis*, Nolle, L.M.L., ed., Marcel Dekker Inc., New York, 2004.
- Harwood, G.W.J., Pouton, C.W. Amperometric enzyme biosensors for metabolites the analysis of drugs and metabolites. *Adv. Drug Deliver. Rev.* 18, 163–191, 1996.
- Gerard, M., Chaubey, A., Malhotra, B.D. Application of conducting polymers to biosensors. *Biosens. Bioelectron.* 17, 345–359, 2002.
- Yman, I.M., Eriksson, A., Johansson, M.A., Hellenäs, K.-E. Food allergen detection with biosensor immunoassays. *J. AOAC Int.* 89, 856–861, 2006.
- Haasnoot, W., Smits, N.G.E., Kemmers-Voncken, A.E.M., Bremer, M.G.E.G. Fast biosensor immunoassays for the detection of cows' milk in the milk of ewes and goats. *J. Dairy Res.* 71, 322–329, 2004.
- Muller-Renaud, S., Dupont, D., Dulieu, P. Quantification of  $\kappa$ -casein in milk by an optical immunosensor. *Food Agric. Immunol.* 15, 265–277, 2003.
- Muller-Renaud, S., Dupont, D., Dulieu, P. Quantification of  $\beta$ -casein in milk and cheese using an optical immunosensor. *J. Agric. Food Chem.* 52, 659–664, 2004.
- Muller-Renaud, S., Dupont, D., Dulieu, P. Development of a biosensor immunoassay for the quantification of  $\alpha$ S1-casein in milk. *J. Dairy Res.* 72, 57–64, 2005.
- Dupont, D., Muller-Renaud, S. Quantification of proteins in dairy products using an optical biosensor. *J. AOAC Int.* 89, 843–848, 2006.
- Dupont, D., Rolet-Repecaud, O., Muller-Renaud, S. Determination of the heat treatment undergone by milk by following the denaturation of  $\alpha$ -lactalbumin with a biosensor. *J. Agric. Food Chem.* 52, 677–681, 2004.
- Indyk, H.E., Filonzi, E.L. Direct optical biosensor analysis of folate-binding protein in milk. *J. Agric. Food Chem.* 52, 3253–3258, 2004.
- Indyk, H.E., Filonzi, E.L., Gapper, L.W. Determination of minor proteins of bovine milk and colostrum by optical biosensor analysis. *J. AOAC Int.* 89, 898–902, 2006.
- Nygren, L., Sternesjö, Å., Björck, L. Determination of folate-binding proteins from milk by optical biosensor analysis. *Int. Dairy J.* 13, 283–290, 2003.

19. Nygren-Babol, L., Sternesjö, Å., Björck, L. Factors influencing levels of folate-binding protein in bovine milk. *Int. Dairy J.* 14, 761–765, 2004.
20. Indyk, H.E., Filonzi, E.L. Determination of lactoferrin in bovine milk, colostrum and infant formulas by optical biosensor analysis. *Int. Dairy J.* 15, 429–438, 2005.
21. Haasnoot, W., Olieman, K., Cazemier, G., Verheijen, R. Direct biosensor immunoassays for the detection of nonmilk proteins in milk powder. *J. Agric. Food Chem.* 49, 5201–5206, 2001.
22. Verma, N., Singh, M. A disposable microbial based biosensor for quality control in milk. *Biosens. Bioelectron.* 18, 1219–1224, 2003.
23. Jenkins, D.M., Michael, J., Delwiche, M.J. Manometric biosensor for on-line measurement of milk urea. *Biosens. Bioelectron.* 17, 557–563, 2002.
24. Wilkins, E., Atanasov, P. Glucose monitoring: State of the art and future possibilities *Med. Eng. Phys.* 18, 273–288, 1996.
25. Wilson, G.S., Gifford, R. Biosensors for real-time in vivo measurements. *Biosens. Bioelectron.* 20, 2388–2403, 2005.
26. Centonze, D., Zambonin, C.G., Palmisano, F. Determination of glucose in nonalcoholic beverages by a biosensor coupled with microdialysis fiber samplers. *J. AOAC Int.* 80, 829–833, 1997.
27. Ivekovic, D., Milardovic, S., Grabaric, B.S. Palladium hexacyanoferrate hydrogel as a novel and simple enzyme immobilization matrix for amperometric biosensors. *Biosens. Bioelectron.* 20, 872–878, 2004.
28. Lundback, H., Olsson, B. Amperometric determination of galactose, lactose and dihydroxyacetone using galactose oxidase in a flow injection system with immobilized enzyme reactors and on-line dialysis. *Anal. Lett.* 18, 871–889, 1985.
29. Schumacher, D., Vogel, J., Lerche, U. Construction and application of an enzyme electrode for determination of galactose and galactose-containing saccharides. *Biosens. Bioelectron.* 9, 85–90, 1994.
30. Malhotra, B.D., Singhal, R., Chaubey, A., Sharma, S.K., Kumar, A. Recent trends in biosensors. *Curr. Appl. Phys.* 5, 92–97, 2005.
31. Ghamouss, F., Ledru, S., Ruille, N., Lantier, F., Boujtita, M. Bulk-modified modified screen-printing carbon electrodes with both lactate oxidase (LOD) and horseradish peroxidase (HRP) for the determination of L-lactate in flow injection analysis mode. *Anal. Chim. Acta* 570, 158–164, 2006.
32. Marrakchi, M., Dzyadevych, S.V., Lagarde, F., Martelet, C., Jaffrezic-Renault, N. Conductometric biosensor based on glucose oxidase and beta-galactosidase for specific lactose determination in milk. *Mater. Sci. Eng. C* 28, 872–875, 2008.
33. Eshkenazi, I., Maltz, E., Zion, B., Rishpon, J. A three-cascaded-enzymes biosensor to determine lactose concentration in raw milk. *J. Dairy Sci.* 83, 1939–1945, 2000.
34. Adányi, N., Szabó, E.E., Váradi, M. Multi-enzyme biosensors with amperometric detection of lactose in milk and dairy products. *Z. Lebensm. Unters.-Forsch. A* 209, 220–226, 1999.
35. Göktug, T., Sezgintürk, M.K., Dinckaya, E. Glucose oxidase- $\beta$ -galactosidase hybrid biosensor based on glassy carbon electrode modified with mercury for lactose determination. *Anal. Chim. Acta* 551, 51–56, 2005.
36. Sharma, S.K., Rahul Singhal, R., Malhotra, B.D., Neeta Sehgal, N., Ashok Kumara, A. Lactose biosensor based on Langmuir–Blodgett films of poly(3-hexyl thiophene). *Biosens. Bioelectron.* 20, 651–657, 2004.
37. Jenkins, D.M., Delwiche, M.J. Adaptation of a manometric biosensor to measure glucose and lactose. *Biosens. Bioelectron.* 18, 101–107, 2003.
38. Mayer, M., Genrich, M., Künnecke, W., Bilitewski, U. Automated determination of lactulose in milk using an enzyme reactor and flow analysis with integrated dialysis. *Anal. Chim. Acta* 324, 37–45, 1996.
39. Sekine, Y., Hall, E.A.H. A lactulose sensor based on coupled enzyme reactions with a ring electrode fabricated from tetrathiafulvalen–tetracyanoquinodimethane. *Biosens. Bioelectron.* 13, 995–1005, 1998.

40. Ram, M.K., Bertoncello, P., Ding, H., Paddeu, S., Nicolini, C. Cholesterol biosensors prepared by layer-by-layer technique. *Biosens. Bioelectron.* 16, 849–856, 2001.
41. Vidal, J.C., Garcia-Ruiz, E., Castillo, J.R. Strategies for the improvement of an amperometric cholesterol biosensor based on electropolymerization in flow system: Use of charge-transfer mediators and platinization of the electrode. *J. Pharmaceut. Biomed. Anal.* 24, 51–63, 2000.
42. Gobi, K.V., Mizutani, F. Layer-by-layer construction of an active multilayer enzyme electrode applicable for direct amperometric determination of cholesterol. *Sens. Actuat. B-Chem.* 80, 272–277, 2001.
43. Situmorang, M., Alexander, P.W., Hibbert, D.B. Flow injection potentiometry for enzymatic assay of cholesterol with a tungsten electrode sensor. *Talanta* 49, 639–649, 1999.
44. Buckland, B.C., Dunnill, P., Lilly, D. The enzymatic transformation of water-insoluble reactants in nonaqueous solvents. Conversion of cholesterol to cholest-4-ene-3-one by a *Nocardia* sp. *Biotechnol. Bioeng.* 17, 815–826, 1975.
45. Pena, N., Ruiz, G., Reviejo, A.J., Pingarron, J.M. Graphite-Teflon composite bienzyme electrodes for the determination of cholesterol in reversed micelles. Application to food samples. *Anal. Chem.* 73, 1190–1195, 2001.
46. Adányi, N., Váradi, M. Development of organic phase amperometric biosensor for measuring cholesterol in food samples. *Eur. Food Res.* 218, 99–104, 2003.
47. Schmidt, A., Standfuss-Gabisch, C., Bilitewski, U. Microbial biosensor for free fatty acids using an oxygen electrode based on thick film technology. *Biosens. Bioelectron.* 2, 1139–1145, 1996.
48. Indyk, H.E., Persson, B.S., Caselunghe, M.C.B., Moberg, A., Filonzi, E.L., Woollard, D.C. Determination of vitamin B12 in milk products and selected foods by optical biosensor protein-binding assay: Method comparison. *J. AOAC Int.* 85, 72–81, 2002.
49. Caelen, I., Kalman, A., Wahlstrom, L. Biosensor-based determination of riboflavin in milk samples. *Anal. Chem.* 76, 137–143, 2004.
50. Pati, S., Quinto, M., Palmisano, F., Zambonin, P.G. Determination of choline in milk, milk powder, and soy lecithin hydrolysates by flow injection analysis and amperometric detection with a choline oxidase based biosensor. *J. Agric. Food Chem.* 52, 4638–4642, 2004.
51. Pati, S., Palmisano, F., Quinto, M., Zambonin, P.G. Quantitation of major choline fractions in milk and dietary supplements using a phospholipase D bioreactor coupled to a choline amperometric biosensor. *J. Agric. Food Chem.* 53, 6974–6979, 2005.
52. Esti, M., Messia, M.C., La Notte, E., Lembo, P., Compagnone, D., Palleschi, G. Curd-ripening evaluation by flow injection analysis of L-lactic acid with an electrochemical biocell during Mozzarella Cheese manufacture. *J. Agric. Food Chem.* 44, 3102–3107, 1996.
53. Cortón, E., Battaglini, F. Effect of milk proteins on the behavior of a biosensor based on poly(allylamine) containing an osmium complex wired to redox enzymes, Part 1. Monoenzymatic configuration. *J. Electroanal. Chem.* 511, 1–7, 2001.
54. Cortón, E., Battaglini, F. Effect of milk proteins on the behavior of a biosensor based on poly(allylamine) containing an osmium complex wired to redox enzymes, Part 2. Bienzymatic configuration. *J. Electroanal. Chem.* 511, 8–12, 2001.
55. Palmisano, F., Quinto, M., Rizzi, R., Zambonin, P.G. Flow injection analysis of L-lactate in milk and yoghurt by on-line microdialysis and amperometric detection at a disposable biosensor. *Analyst* 126, 866–870, 2001.
56. Zaydan, R., Dion, M., Boujtita, M. Development of a new method, based on a bioreactor coupled with an L-lactate biosensor, toward the determination of a nonspecific inhibition of L-lactic acid production during milk fermentation. *J. Agric. Food Chem.* 52, 8–14, 2004.
57. Garjonyte, R., Melvydas, V., Malinauskas, A. Mediated amperometric biosensors for lactic acid based on carbon paste electrodes modified with baker's yeast *Saccharomyces cerevisiae*. *Bioelectrochemistry* 68, 191–196, 2006.
58. Luong, J.H.T., Mulchandani, A., Groom, C.A. The development of an amperometric microbial biosensor using *Acetobacter pasteurianus* for lactic acid. *J. Biotechnol.* 10, 241–252, 1989.

59. Montagné, M., Marty, J.L. Bi-enzyme amperometric D-lactate sensor using NAD<sup>+</sup>. *Anal. Chim. Acta*. 315, 297–302, 1995.
60. Sananikone, K., Delwiche, M.J., Bon Durant, R.H., Munro, C.J. Quantitative lateral flow immunoassay for measuring progesterone in bovine milk. *Trans. Am. Soc. Agric. Eng.* 47, 1357–1365, 2004.
61. Delwiche, M., Tang, X., BonDurant, R., Munro, C. Improved biosensor for measurement of progesterone in bovine milk. *Trans. Am. Soc. Agric. Eng.* 44, 1997–2002, 2001.
62. Delwiche, M., Tang, X., BonDurant, R., Munro, C. Estrus detection with a progesterone biosensor. *Trans. Am. Soc. Agric. Eng.* 44, 2003–2008, 2001.
63. Pemberton, R.M., Hart, J.P., Foulkes, J.A. Development of a sensitive, selective electrochemical immunoassay for progesterone in cow's milk based on a disposable screen-printed amperometric biosensor. *Electrochim. Acta* 43, 3567–3574, 1998.
64. Pemberton, R.M., Hart, J.P., Stoddard, P., Foulkes, J.A. A comparison of 1-naphthyl phosphate and 4 aminophenyl phosphate as enzyme substrates for use with a screen-printed amperometric immunosensor for progesterone in cows' milk. *Biosens. Bioelectron.* 14, 495–503, 1999.
65. Pemberton, R.M., Hart, J.P., Mottram, T.T. An electrochemical immunosensor for milk progesterone using a continuous flow system. *Biosens. Bioelectron.* 16, 715–723, 2001.
66. Xu, J.F., Velasco-Garcia, M., Mottram, T.T. Quantitative analysis of the response of an electrochemical biosensor for progesterone in milk. *Biosens. Bioelectron.* 20, 2061–2070, 2005.
67. Velasco-Garcia, M.N., Mottram, T. Biosensors in the livestock industry: An automated ovulation prediction system for dairy cows. *Curr. Appl. Phys.* 3, 191–194, 2003.
68. Carralero, V., González-Cortés, A., Yáñez-Sedeno, P., Pingarrón, J.M. Nanostructured progesterone immunosensor using a tyrosinase-colloidal gold-graphite-Teflon biosensor as amperometric transducer. *Anal. Chim. Acta* 596, 86–91, 2007.
69. Gillis, E.H., Gosling, J.P., Sreenan, J.M., Kane, M. Development and validation of a biosensor-based immunoassay for progesterone in bovine milk. *J. Immunol. Methods* 267, 131–138, 2002.
70. Gillis, E.H., Traynor, L., Gosling, J.P., Kane, M. Improvements to a surface plasmon resonance-based immunoassay for the steroid hormone progesterone. *J. AOAC Int.* 89, 838–842, 2006.
71. Kappel, N.D., Pröll, F., Gauglitz, G. Development of a TIRF-based biosensor for sensitive detection of progesterone in bovine milk. *Biosens. Bioelectron.* 22, 2295–2300, 2007.
72. Serra, B., Morales, M.D., Reviejo, A.J., Hall, E.H., Pingarrón, J.M. Rapid and highly sensitive electrochemical determination of alkaline phosphatase using a composite tyrosinase biosensor. *Anal. Biochem.* 336, 289–294, 2005.
73. Haasnoot, W., Verheijen, R. A direct (non-competitive) immunoassay for gentamicin residues with an optical biosensor. *Food Agric. Immunol.* 13, 131–134, 2001.
74. Ferguson, J., Baxter, A., McEvoy, J.D.G., Stead, S., Rawlings, E., Sharman, M. Detection of streptomycin and dihydrostreptomycin residues in milk, honey and meat samples using an optical biosensor. *Analyst* 127, 951–956, 2002.
75. Baxter, G.A., Ferguson, J.P., O'Connor, M.C., Elliott, C.T. Detection of streptomycin residues in whole milk using an optical immunobiosensor. *J. Agric. Food Chem.* 49, 3204–3207, 2001.
76. Haasnoot, W., Cazemier, G., Koets, M., van Amerongen, A. Single biosensor immunoassay for the detection of five aminoglycosides in reconstituted skimmed milk. *Anal. Chim. Acta* 488, 53–60, 2003.
77. Gaudin, V., Fontaine, J., Maris, P. Screening of penicillin residues in milk by a surface plasmon resonance-based biosensor assay: Comparison of chemical and enzymatic sample pre-treatment. *Anal. Chim. Acta* 436, 191–198, 2001.
78. Gustavsson, E., Bjurling, P., Sternesjö, Å. Biosensor analysis of penicillin G in milk based on the inhibition of carboxypeptidase activity. *Anal. Chim. Acta* 468, 153–159, 2002.
79. Gustavsson, E., Sternesjö, Å. Biosensor analysis of  $\beta$ -lactams in milk: Comparison with microbiological, immunological, and receptor-based screening methods. *J. AOAC Int.* 87, 614–620, 2004.
80. Sternesjö, Å., Gustavsson, E. Biosensor analysis of  $\beta$ -lactams in milk using the carboxypeptidase activity of a bacterial penicillin binding protein. *J. AOAC Int.* 89, 832–837, 2006.

81. Gustavsson, E., Bjurling, P., Degelaen, J., Sternesjö, Å. Analysis of  $\beta$ -lactam antibiotics using a microbial receptor protein-based biosensor assay. *Food Agric. Immunol.* 14, 121–131, 2002.
82. Cacciatore, G., Petz, M., Rachid, S., Hakenbeck, R., Bergwerff, A.A. Development of an optical biosensor assay for detection of  $\beta$ -lactam antibiotics in milk using the penicillin-binding protein 2x. *Anal. Chim. Acta* 520, 105–115, 2004.
83. Galindo, E., Bautista, D., Garcia, J.L., Quintero, R. Microbial sensor for penicillins using a recombinant strain of *Escherichia coli*. *Enzyme Microb. Technol.* 12, 642–646, 1990.
84. Pellegrini, G.E., Carpico, G., Coni, E. Electrochemical sensor for the detection and presumptive identification of quinolone and tetracycline residues in milk. *Anal. Chim. Acta* 520, 13–18, 2004.
85. Sternesjö, Å., Mellgren, C., Björck, L. Determination of sulfamethazine residues in milk by a surface plasmon resonance-based biosensor assay. *Anal. Biochem.* 226, 175–181, 1995.
86. Bergstrom, C., Sternesjö, Å., Bjurling, P., Lofas, S. Design and use of a general capturing surface in optical biosensor analysis of sulphamethazine in milk. *Food Agric. Immunol.* 11, 329–338, 1999.
87. Möller, N., Müller-Seitz, E., Scholz, O., Hillen, W., Bergwerff, A.A., Petz, M. A new strategy for the analysis of tetracycline residues in foodstuffs by a surface plasmon resonance biosensor. *Eur. Food Res. Technol.* 224, 285–292, 2006.
88. Rinken, T., Riik, H. Determination of antibiotic residues and their interaction in milk with lactate biosensor. *J. Biochem. Biophys. Methods* 66, 13–21, 2006.
89. Gaudin, V., Maris, P. Development of a biosensor-based immunoassay for screening of chloramphenicol residues in milk. *Food Agric. Immunol.* 13, 77–86, 2001.
90. Ferguson, J., Baxter, A., Young, P., Kennedy, G., Elliott, C., Weigel, S., Gatermann, R., Ashwin, H., Stead, S., Sharman, M. Detection of chloramphenicol and chloramphenicol glucuronide residues in poultry muscle, honey, prawn and milk using a surface plasmon resonance biosensor and Qflex® kit chloramphenicol. *Anal. Chim. Acta* 529, 109–113, 2005.
91. Adányi, N., Váradi, M., Kim, N., Szendrő, I. Development of new immunosensors for determination of contaminants in food. *Curr. Appl. Phys.* 6, 279–286, 2006.
92. Cao, L., Lin, H., Mirsky, V.M. Surface plasmon resonance biosensor for enrofloxacin based on deoxyribonucleic acid. *Anal. Chim. Acta* 589, 1–5, 2007.
93. Knecht, B.G., Strasser, A., Dietrich, R., Märtlbauer, E., Niessner, R., Weller, M.G. Automated microarray system for the simultaneous detection of antibiotics in milk. *Anal. Chem.* 76, 646–654, 2004.
94. Link, N., Weber, W., Fussenegger, M. A novel generic dipstick-based technology for rapid and precise detection of tetracycline, streptogramin and macrolide antibiotics in food samples. *J. Biotechnol.* 128, 668–680, 2007.
94. Samsonova, J.V., Baxter, G.A., Crooks, S.R.H., Elliott, C.T. Biosensor immunoassay of ivermectin in bovine milk. *J. AOAC Int.* 85, 879–882, 2002.
95. Crooks, S.R.H., McCarney, B., Traynor, I.M., Thompson, C.S., Floyd, S., Elliott, C.T. Detection of levamisole residues in bovine liver and milk by immunobiosensor. *Anal. Chim. Acta* 483, 181–186, 2003.
96. Immonen, N., Karp, M. Bioluminescence-based bioassays for rapid detection of nisin in food. *Biosens. Bioelectron.* 22, 1982–1987, 2007.
97. Zhang, Y., Muench, S.B., Schulze, H., Perz, R., Yang, B., Schmid, R.D., Bachmann, T.T. Disposable biosensor test for organophosphate and carbamate insecticides in milk. *J. Agric. Food Chem.* 53, 5110–5115, 2005.
98. Nikolelis, D.P., Simantirakia, M.G., Siontoroua, C.G., Toth, K. Flow injection analysis of carbofuran in foods using air stable lipid film based acetylcholinesterase biosensor. *Anal. Chim. Acta* 537, 169–177, 2005.
99. Shan, D., Shi, Q., Zhu, D., Xue, H. Inhibitive detection of benzoic acid using a novel phenols biosensor based on polyaniline–polyacrylonitrile composite matrix. *Talanta* 72, 1767–1772, 2007.
100. Mascini, A.M., Macagnano, A., Scortichini, G., Del Carlo, M., Diletti, G., D'Amico, A., Di Natale, C., Compagnone, D. Biomimetic sensors for dioxins detection in food samples. *Sens. Actuators B-Chem.* 111–112, 376–384, 2005.



101. Chang, K.S., Jang, H.D., Lee, C.F., Lee, Y.G., Yuan, C.J., Lee, S.H. Series quartz crystal sensor for remote bacteria population monitoring in raw milk via the Internet. *Biosens. Bioelectron.* 21, 1581–1590, 2006.
102. Lakshmanan, R.S., Guntupalli, R., Hu, J., Petrenko, V.A., Barbaree, J.M., Chin, B.A. Detection of *Salmonella typhimurium* in fat free milk using a phage immobilized magnetoelastic sensor. *Sens. Actuators B-Chem.* 126, 544–550, 2007.
103. Minunni, M., Mascini, M., R.M., Carter, R.M., Jacobs, M.B., Lubrano, G.J., Guillbault, G.G. A quartz crystal microbalance displacement assay for *Listeria monocytogenes*. *Anal. Chim. Acta* 325, 169–174, 1996.
104. Waswa, J., Irudayaraj, J., DebRoy, C. Direct detection of *E. Coli* O157:H7 in selected food systems by a surface plasmon resonance biosensor. *LWT* 40, 187–192, 2007.
105. Skladal, P., Mascini Skladal, M., Salvadori, C., Zannoni, G. Detection of bacterial contamination in sterile UHT milk using an L-lactate. *Enzyme Microb. Technol.* 15, 508–512, 1993.
106. Watts, H.J., Lowe, C.R., Pollard-Knight, D.V. Optical biosensor for monitoring microbial cells. *Anal. Chem.* 66, 2465–2468, 1994.
107. Akerstedt, M., Björck, L., Persson Waller, K., Sternesjö, Å. Biosensor assay for determination of haptoglobin in bovine milk. *J. Dairy Res.* 73, 299–305, 2006.
108. Cucci, C., Mignani, A.G., Dall’Asta, C., Pela, R., Dossena, A. A portable fluorometer for the rapid screening of M1 aflatoxin. *Sens. Actuators B-Chem.* 126, 467–472, 2007.
109. Micheli, L., Grecco, R., Badea, M., Moscone, D., Palleschi, G. An electrochemical immunosensor for aflatoxin M1 determination in milk using screen-printed electrodes. *Biosens. Bioelectron.* 21, 588–596, 2005.
110. Andreou, V.G., Nikolelis, D.P. Electrochemical transduction of interactions of aflatoxin M1 with bilayer lipid membranes (BLMs) for the construction of one-shot sensors. *Sens. Actuators B-Chem.* 41, 213–216, 1997.
111. Homola, B., Dostálek, J., Chen, S., Rasooly, A., Jiang, S., Yee, S.S. Spectral surface plasmon resonance biosensor for detection of staphylococcal enterotoxin B in milk. *Int. J. Food Microbiol.* 75, 61–69, 2002.
112. Rasooly, L., Rasooly, A. Real time biosensor analysis of Staphylococcal enterotoxin A in food. *Int. J. Food Microbiol.* 49, 119–127, 1999.
113. Nedelkov, D., Rasooly, A., Nelson, R.W. Multitoxin biosensor-mass spectrometry analysis: A new approach for rapid, real-time, sensitive analysis of staphylococcal toxins in food. *Int. J. Food Microbiol.* 60, 1–13, 2000.
114. Leth, S., Krook, M., Hörnsten, E.G. A feasibility study of the use of a SIRE biosensor in the monitoring of H<sub>2</sub>O<sub>2</sub> added to milk samples. A possible new technology for early detection of mastitis? *Innov. Food Sci. Emerg. Technol.* 5, 515–522, 2004.
115. Campuzano, S., Maria Pedrero, M., Pingarroón, J.M. A peroxidase-tetrathiafulvalene biosensor based on self-assembled monolayer modified Au electrodes for the flow-injection determination of hydrogen peroxide. *Talanta* 66, 1310–1319, 2005.
116. Qian, J., Liu, Y., Liu, H., Yu, T., Deng, J. Immobilization of horseradish peroxidase with a regenerated silk fibroin membrane and its application to a tetrathiafulvalene-mediated H<sub>2</sub>O<sub>2</sub> sensor. *Biosens. Bioelectron.* 12, 1213–1218, 1997.
117. Valdés Garcia, M.A., Tunón Blanco, P., Ivaska, A. A poly(*o*-aminophenol) modified electrode as an amperometric hydrogen peroxide biosensor. *Electrochim. Acta* 43, 3533–3539, 1998.
118. Yildiz, H., Akyilmaz, E., Dinckaya, E. Catalase immobilization in cellulose acetate beads and determination of its hydrogen peroxide decomposition level by using a catalase biosensor. *Artif. Cells Blood Substit. Immobil. Biotechnol.* 32, 443–452, 2004.
119. Ozturk, G., Ertas, F.N., Akyilmaz, E., Dinckaya, E., Tural, H. A novel amperometric biosensor based on artichoke (*Cynara scolymus* L.) tissue homogenate immobilized in gelatin for hydrogen peroxide detection. *Artif. Cells Blood Substit. Immobil. Biotechnol.* 32, 637–645, 2004.

120. Sarkar, P., Tothill, I.E., Setford, S.J., Turner, A.P.F. Screen-printed amperometric biosensors for the rapid measurement of L- and D-amino acids. *Analyst* 124, 865–870, 1999.
121. Wcislo, M., Compagnone, D., Trojanowicz, M. Enantioselective screen-printed amperometric biosensor for the determination of D-amino acids. *Bioelectrochemistry* 71, 91–98, 2007.
122. Sacchi, S., Pollegioni, L., Pilone, M.S., Rossetti, C. Determination of D-amino acids using a D-amino acid oxidase biosensor with spectrophotometric and potentiometric detection. *Biotechnol. Tech.* 12, 149–153, 1998.
123. Marchelli, R., Palla, G., Dossena, A., Galaverna, G., Corradini, R., Dementi, S. D-Amino acidi: Marker molecolari di stagionatura e di tipicità per il Parmigiano Reggiano ed il Grana Padano. *Scienza Tecnica Lattiero-Casearia* 48, 21–32, 1997.
124. Mutlu, S., Cökeler, D., Shard, A., Goktas, H., Ozansoy, B., Mutlu, M. Preparation and characterization of ethylenediamine and cysteamine plasma polymerized films on piezoelectric quartz crystal surfaces for a biosensor. *Thin Solid Films* 516, 1249–1255, 2008.



## Chapter 15

---

# Physical Sensors and Techniques

---

Colette C. Fagan and Colm P. O'Donnell

### CONTENTS

15.1	Introduction .....	329
15.2	Infrared Sensors .....	330
15.2.1	Near-Infrared Technology .....	330
15.2.2	Mid-Infrared Spectroscopy .....	331
15.3	Imaging Techniques .....	332
15.3.1	Computer Vision .....	333
15.3.2	Hyperspectral Imaging .....	335
15.3.3	Ultrasound Imaging.....	337
15.3.4	Magnetic Resonance Imaging.....	337
15.4	Dielectric Sensors .....	338
15.5	Process Viscometry.....	340
	Acknowledgments.....	341
	References.....	341

### 15.1 Introduction

The large-scale production of consistently high-quality products with specific functional properties has become increasingly important for consumer acceptability of dairy products as either food ingredients or consumer products. In order to achieve these goals, systems are required for designing, analyzing, and controlling the manufacturing process through timely measurements of critical quality and performance attributes of raw and in-process materials and processes [1]. However

this requires the control of the manufacturing process through real-time analysis of critical quality parameters. Therefore techniques and technologies, which can rapidly, accurately, and preferably nondestructively assess the quality and functional properties of dairy products are essential for the modern dairy processing industry.

Numerous sensors and technologies have been applied to the prediction of quality attributes of milk, cheese, butter, and yogurt. This chapter will highlight the role of four techniques: infrared sensors, imaging techniques, dielectric sensors, and process viscometry as sensor technologies and techniques for process control applications as well as in predicting a range of quality parameters.

## 15.2 Infrared Sensors

Infrared spectroscopy has been one of the most widely studied sensor technologies for the prediction of dairy food quality attributes including composition, sensory, and rheological attributes, maturity, authenticity, and adulterant detection. Infrared technology has also been employed in sensors for the control of manufacturing processes such as cheese and butter production. Examples of the use of near- and mid-infrared technology in prediction and control of milk, cheese, butter, and milk powder quality attributes are outlined.

### 15.2.1 *Near-Infrared Technology*

The near-infrared region of the electromagnetic spectrum lies between 750 and 2500 nm. Near-infrared spectroscopy has predominately been studied for the determination of composition of a variety of dairy foods including milk [2,3], cheese [4–7], and butter [8]. More recently near-infrared spectroscopy has been applied to the assessment of cheese, butter, and milk powder quality and/or authenticity.

Although infrared spectra contain a large amount of information on the molecular product, all spectroscopic signals of a molecular group are strongly influenced by neighboring molecular groups [9]. While this provides a challenge in developing calibration models, powerful statistical techniques such as chemometrics can be employed. Chemometric techniques such as principal component analysis and partial least squares regression can be employed to compute a new smaller set of variables, which are linear combinations of the spectral data, to be used in the prediction model [10]. Karoui and De Baerdemaeker [11] have reviewed analytical methods coupled with chemometric tools for the determination of the quality and identity of dairy products

Downey et al. [12] successfully developed models to predict Cheddar cheese sensory properties and age using near-infrared spectroscopy and partial least squares regression. The authors stated that parameters such as crumbly, rubbery, chewy, mouthcoating, and massforming could be predicted with sufficient accuracy to be industrially useful, although further validation of the results of this study is required due to the small sample set employed. Processed cheese has also been studied using near-infrared spectroscopy and models were developed to predict composition, sensory, and instrumental texture attributes [13]. Blazquez et al. [13] modeled the texture attributes of processed cheese using near-infrared reflectance spectroscopy and found that it was possible to model a number of parameters including hardness, springiness, and meltability as determined using a computer vision system.

Kliman and Pallansch [14] examined the use of infrared spectroscopy in the analysis of oils and fats and found that the water content of butter oil was relative to the absorption at 1900 nm. Sato et al. [15] studied the detection of foreign fat in butter using near-infrared spectroscopy and

found that it was capable of detecting as little as 3% foreign fat in butter and margarine mixtures. Near-infrared spectroscopy has also been used for determining the composition of butter, with Hermida et al. [16] predicting moisture ( $R^2 = 0.83$ ), solids-nonfat ( $R^2 = 0.94$ ), and fat ( $R^2 = 0.72$ ) in butter without any sample pretreatment.

Prediction of milk powder composition, quality, and detection of milk powder adulteration by near-infrared spectroscopy has also been studied. Reh et al. [17] found that milk powder moisture content was highly correlated with absorbance at 1940 nm ( $R^2 = 0.94$ ), while Downey et al. [18] found it was possible to differentiate between milk powder based on heat treatment. Cen et al. [19] also used the visible near-infrared spectra of nine different varieties of powdered infant milk to distinguish between them ( $R^2 = 0.98$ ). Near-infrared spectroscopy has also been demonstrated as an effective technique for detecting milk powders adulterated with 0%–5% vegetables protein ( $R^2 = 0.99$ ) [20].

Sensors have also been developed which use radiation in the near-infrared region to monitor milk coagulation based on the changes in the optical properties of the milk during coagulation. Light in the near-infrared region can be transmitted through a fiber-optic bundle and diffuse reflectance or transmission is monitored. As the gel is formed, reflectance will increase while transmission will decrease. Payne et al. [21] developed a method for predicting coagulum cutting time based on changes in diffuse reflectance during milk coagulation. Reflectance was measured using a fiber-optic probe, utilizing a photodiode light source at a wavelength of 940 nm. The time to the inflection point ( $t_{\max}$ ) was determined from the first derivative and was found to correlate well with Formograph cutting times. In a further work by Payne et al. [21], a fiber-optic sensor was developed which operated using light at a wavelength of 950 nm. All the reflection profile displayed induction, sigmoidal, and logarithmic periods.  $t_{\max}$  was again found to be well correlated with the observed cutting time (subjective measurement). Linear prediction equations, which were considered to be of the form required for predicting cutting time, were also developed using  $t_{\max}$ . This has facilitated the development of the CoAguLite (Figure 15.1) (Reflectronics, Lexington, KY, United States), a near-infrared reflectance sensor which is employed in industry for the prediction of cutting time.

### 15.2.2 Mid-Infrared Spectroscopy

Mid-infrared spectroscopy or Fourier transform infrared spectroscopy (FTIR) is based on the absorption of radiation in the 4000–400  $\text{cm}^{-1}$  region of the electromagnetic spectrum. It can



**Figure 15.1** The CoAguLite sensor (Reflectronics, Lexington, KY) which can be installed in the wall of a cheese vat and employed to objectively determine curd cutting time during cheese manufacture. (Courtesy of Reflectronics Inc.)

provide rapid characterization of food products and hence this technology has been applied in the prediction of composition, quality, and authenticity of various dairy products. While there is a growing body of work in which mid-infrared spectroscopy has been used in the prediction of numerous quality attributes of food products [22–25], the focus of the majority of studies has been laboratory based. However, the evolution of guided-wave optics and linear detector technology has created new possibilities for the realization of miniature infrared spectrometers that can rival much larger bench spectrometers [26]. Such spectrometers will facilitate online or in-line process monitoring.

Mid-infrared spectroscopy has predominately been applied to the study of two particular dairy foods, milk and cheese. Due to the success of the FTIR measuring principle for the analysis of milk, this technology has been successfully commercialized with products such as the MilkoScan™ FT 120 (Foss, Hillerød, Denmark) which employs this principle in compliance with IDF and AOAC standards.

The quality of any given type of cheese is related to a large extent to its texture, which in turn is influenced by moisture and other compositional components, and processing conditions. Therefore mid-infrared spectroscopy has been investigated as a tool for predicting not only compositional parameters but also textural attributes. Irudayaraj et al. [25] investigated the use of mid-infrared spectroscopy to follow texture development in Cheddar cheese during ripening, whereby springiness was found to be correlated with bands in mid-infrared spectra. The development of cheese microflora during ripening is extremely important in the development of flavor and texture [10]. Lefier et al. [27] demonstrated that FTIR spectroscopy could be used to identify *Lactococcus* sp., while Lucia et al. [28] found that during cheese ripening changes in the amide I and amide II spectral bands occurred. Dufour et al. [29] also demonstrated that mid-infrared spectroscopy has the ability to discriminate between Cheddar cheese samples at various ripening stages. The level of water-soluble nitrogen (WSN) content of cheese increases during maturation and FTIR spectroscopy has been employed to predict the WSN content of Emmental cheese [30].

Karoui et al. [31] also found that FTIR spectroscopy could discriminate between Emmental cheeses produced during summer and winter in five different countries while the discrimination between five geographical regions was weaker. Pillonel et al. [32] investigated discrimination of Emmental cheeses based on geographic origins using mid-infrared and found that mid-infrared transmission spectra achieved 100% correct classification when differentiating Swiss Emmental from cheeses of other origin.

The potential of mid-infrared spectroscopy to predict cheese sensory and rheological properties has been the topic of a number of recent studies. Mid-infrared spectroscopy has been applied to the prediction of processed cheese texture and meltability attributes [33,34]. Models predicting hardness, springiness, massforming, and mass-coating gave approximate quantitative results ( $R^2 = 0.66–0.81$ ); models predicting cohesiveness, Olson and Price meltability, firmness, rubbery, creamy, and chewy gave good prediction results ( $R^2 = 0.81–0.90$ ); only the fragmentable model provided excellent predictions ( $R^2 > 0.91$ ).

### 15.3 Imaging Techniques

Imaging techniques can provide important information on the surface and internal properties of dairy products which can be employed in product quality and safety evaluation. Imaging techniques can include computer vision, hyperspectral imaging (HIS), ultrasound imaging, and nuclear magnetic resonance imaging (MRI).

### 15.3.1 Computer Vision

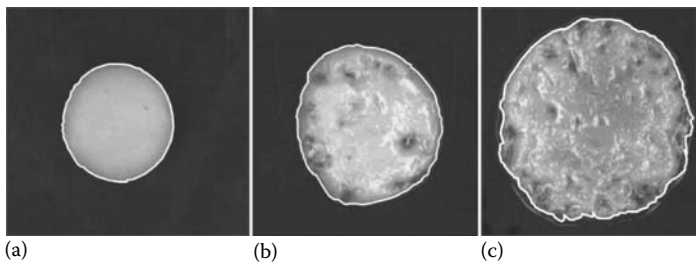
Computer vision is defined as the construction of explicit and meaningful descriptions of physical objects from images [35]. Computer vision systems are comprised of the following; a source of illumination, a digital camera for image acquisition, a frame grabber or digitizer, a computer, and software. In the dairy food sector computer vision has primarily been employed to obtain the functional properties of cheese and in particular its melting characteristics. Cheese meltability is a crucial functional property which determines its suitability for use as a topping or ingredient in prepared consumer foods [36].

Cheese meltability has traditionally been determined by empirical techniques such as the Olson and Price method [37], Arnott et al. [38] and Schreiber tests [39], etc. The Olson and Price method involves measuring the distance of flow of a cheese sample in a glass tube after heating, thereby giving an index of meltability. In the Schreiber and Arnott tests a cheese disc is placed on a flat dish and the percent increase in sample diameter [39] or percent decrease in sample height [38] after heating is taken as an index of meltability. However Park et al. [40] found a lack of correlation between the Arnott and Schreiber test although sample size and heating conditions were varied between the two tests. Subsequently Wang et al. [36,41] demonstrated the significant effect of cheese dimensions on meltability and reported that there is a nonlinear relationship between cooking conditions and cheese meltability.

Muthukumarappan et al. [42] stated that there are two major problems with the Schreiber test i.e., scorching can occur at the outer edges of the melted cheese and noncircular cheese spread also occurs as observed in Figure 15.2. Therefore Muthukumarappan et al. [42] proposed measuring the change in area of the cheese sample after heating rather than the change in diameter. They achieved this by using a computer vision system. By measuring the spread area of mozzarella cheese after melting rather than the diameter they found that the coefficient of variation improved and samples were better discriminated according to their meltability and hence the measurement of spread area was a more accurate and consistent technique for determining cheese meltability [42].

Wang et al. [43] utilized a computer vision system to evaluate the melting and browning properties of Cheddar cheese. They reported meltability as the increase in area after cooking:

$$\text{Meltability} = \frac{A_t}{A_0} \quad (15.1)$$



**Figure 15.2** Images captured using a computer vision system of the area of (a) a Cheddar cheese sample before melting, (b) a Cheddar cheese sample of low meltability, and (c) a Cheddar cheese sample of high meltability.



where

$A_t$  is the area of cheese at cooking time  $t$

$A_0$  is the initial cheese area

Wang and Sun [43] determined the browning factor of the samples as the reciprocal of the ratio between the gray value (GV) of the cheese sample after and before melting:

$$\text{browning factor} = \left( \frac{GV_t}{GV_0} \right)^{-1} = \frac{GV_0}{GV_t} \quad (15.2)$$

where

$GV_t$  is the gray value of the cheese at cooking time  $t$

$GV_0$  is the initial cheese gray value gray

The authors reported that the method provided an objective, rapid, and accurate approach to the simultaneous determination of cheese melting and browning [43]. They also stated that additional advantages of using a computer vision system to determine cheese browning were (a) that unlike a colorimeter, the computer vision system takes the whole sample area into consideration when the gray level is calculated and therefore the reading is more representative and (b) that the computer vision system is not in contact with the cheese samples and therefore the method can be carried out regardless of specimen temperature and hence samples can be processed at a higher temperature thereby shortening the analysis time. Additional work by Wang and Sun [44] investigated the correlation between cheese meltability determined using the Schreiber test, Arnott test, and computer vision method. They found that there was a better correlation between meltability determined by the Schreiber test and computer vision method ( $R^2 = 0.88$ ) than between the meltability determined by the Arnott test and computer vision method ( $R^2 = 0.69$ ). It has also been suggested that computer vision systems could be multifunctional allowing for the assessment of Cheddar and Mozzarella meltability and browning [45].

Meltability as determined by descriptive sensory analysis is an important parameter in determining the consumer acceptability of a cheese product. Everard et al. [46] examined the relationship between the computer vision and descriptive sensory analysis methods for determining processed cheese meltability. They found a significant correlation between meltability determined by the two techniques ( $R^2 = 0.71$ ).

Machined, and in particular shredded, cheese is an important sector of the cheese industry. Traditionally cheese-shred evaluation is carried out by sieving which does not take into account the functionality of the unbroken shreds, instead focusing on the fragmented pieces. However Ni and Gunasekaran [47] proposed a computer vision method for determining the length of single, touching, and overlapping cheese shreds. They found that the sequential thinning algorithm applied to cheese shred images determined shred length with an error as low as 0.2% and not more than 10%, but it can be sensitive to noise at the boundaries. In a further study by Ni and Gunasekaran [48], they found that an X–Y sweep method was a robust and efficient algorithm which successfully recognized and merged occluded segments in shred like objects. When applied to images of touching and overlapping shreds the algorithm estimated the shred length with an accuracy of about 95%.

Computer vision also has a role to play in the development and quality assessment of innovative cheese products such as cheese products with added vegetable ingredients. The distribution

and quantity of such ingredients in cheese is important in determining the consumer acceptance. Therefore computer vision has been evaluated as a sensor technology for the inspection of ingredient distribution and quantity in cheese [49]. It was demonstrated that the technique could be used to predict the amount of added ingredient with accuracies between 71.7% and 88.8% and the grade of the cheese according to ingredient distribution with accuracies between 81.9% and 89.0%.

While all examples of the application of computer vision to the determination of quality in dairy foods given above are related to a finished cheese product the technology also has the potential to be applied online during the production of dairy foods. Everard et al. [50] and Fagan et al. [51] have examined the potential of computer vision to monitor syneresis during cheese production. In both studies, images of the surface of the curd/whey mixture in the cheese vat were captured and subjected to image analysis with the objective of extracting parameters which could be used to predict important syneresis indices such as curd moisture which will impact the final cheese quality. Everard et al. [50] defined a threshold value in order to distinguish between curd and whey and calculate their areas. The change in the ratio of the area of whey to the area of curd as well as the change in the average RGB values for each image was used to predict curd moisture content. However the predictions tended to be confounded by changes in the stirring speed within the vat. Fagan et al. [51] utilized image texture analysis to determine if the confounding effect of stirring speed could be removed. They found that the features extracted by the fractal dimension technique predicted curd moisture during syneresis with a standard error of prediction of 1.03% (w/w). The authors concluded that syneresis indices were most closely related to the image texture features of multiscale representation and that these features could take into account the effect of stirring speed on syneresis.

### 15.3.2 Hyperspectral Imaging

The powerful nature of sensor technologies based on either computer vision (Section 15.3.1) or infrared spectroscopy (Section 15.2) for quality determination is clear. However each technology does have some limitations, for example, while conventional computer vision techniques provide spatial information they do not provide spectral information which can be obtained from spectroscopic techniques and vice versa. HSI is an emerging platform technology that integrates conventional computer vision and spectroscopy to attain both spatial and spectral information from an object [52]. Table 15.1 gives a comparison of computer vision, infrared spectroscopy, and HSI techniques. HSI

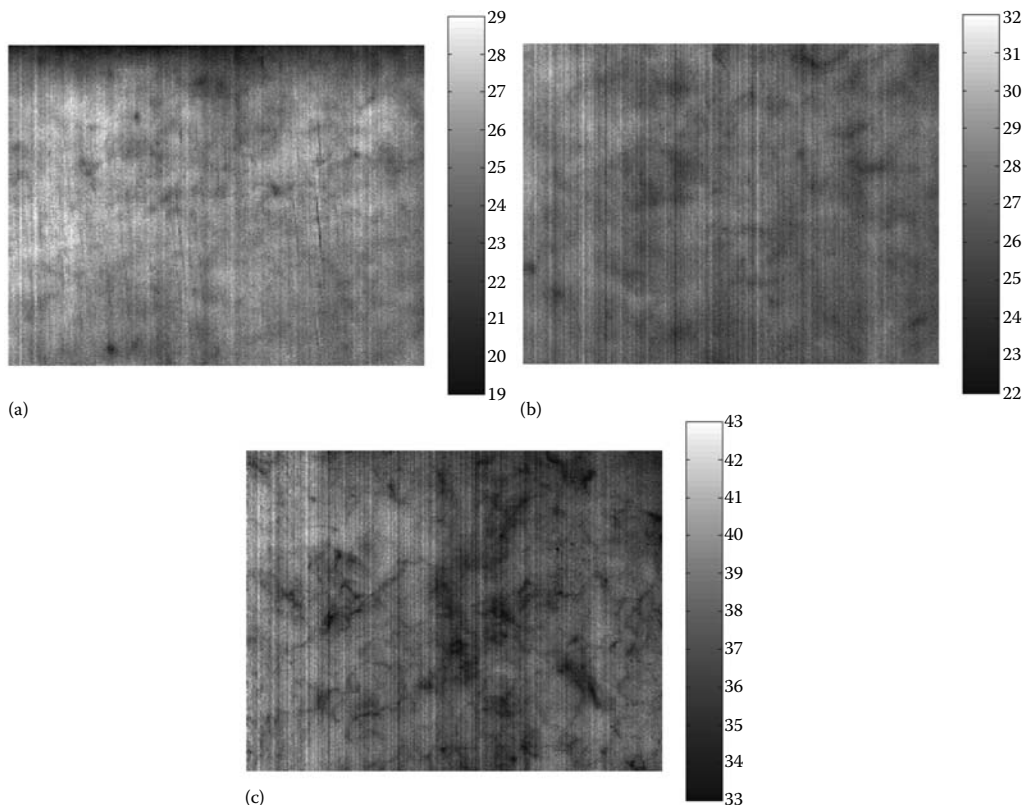
**Table 15.1 Comparison of Computer Vision (CV), Infrared Spectroscopy (IR), and Hyperspectral Imaging (HSI)**

<i>Feature</i>	<i>CV</i>	<i>IR</i>	<i>HSI</i>
Spatial information	✓		✓
Spectral information		✓	✓
Multiconstituent information	Limited	✓	✓
Sensitivity to minor components			✓

Source: Modified from Gowen, A.A. et al., *Trends Food Sci. Technol.*, 18, 590, 2007. With permission.

combines the advantages of computer vision and infrared spectroscopy in that it can provide spatial, spectral, and multiconstituent information, while also being sensitive to minor food constituents.

HSI has been predominately employed to detect defects, contaminants, and quality attributes of fruit, vegetable, meat, and poultry products [53–55]. However, in the future it will be an important technology for quality attribute prediction of dairy products. A limited number of studies have applied HSI to dairy products. As part of their study, Burger and Geladi [56] studied the prediction errors of partial least squares regression errors in determining protein, fat, and carbohydrate concentrations using various image data pretreatments and corrections. Concentration predictions from individual HSI spectra were mapped to provide spatial information. They found that slight inhomogeneous areas were easily noticed due to coloration of the images. Figure 15.3 shows fat content prediction maps for three different cheeses. Eight cheeses were imaged (960–1660 nm) using a HSI system (BurgerMetrics, Jelgava, Latvia) with a  $100\mu\text{m} \times 100\mu\text{m}$  pixel resolution. The fat content of each cheese, as specified by the manufactures, were used to create a partial least squares model based on the median first derivative spectrum obtained from each cheese image. This partial least squares model which used two loadings was then used to predict the fat content at each pixel in the image, the results of which are displayed as prediction maps for three cheese images (Figure 15.3). Areas of inhomogeneous distribution of fat are easily visualized. Hence HSI



**Figure 15.3** Fat content prediction maps obtained from a two loading partial least squares model for three Norwegian cheeses with reported fat contents of (a) 24%, (b) 27%, and (c) 38%.

could be used to provide detailed spatial resolution which could provide valuable information to the cheese maker as well as those working in product development.

Qin and Lu [57] demonstrated that a HSI technique could be applied to the measurement of the optical properties of turbid liquid foods including milk. They found that they could determine the optical properties of three classes of turbid samples with average errors of 16% and 11% for the absorption and reduced scattering coefficients, respectively and that in milk these parameters were highly correlated with fat content ( $R = 0.995$  and  $0.998$ , respectively).

### 15.3.3 *Ultrasound Imaging*

Ultrasound waves may be reflected or transmitted when they pass from one medium to another, the relative amount of which is related to the materials' relative acoustic properties. Gan et al. [58] stated that ultrasound has the ability to differentiate between both the propagation velocity within various media and the differences in acoustic impedance between different regions in a given volume. Therefore ultrasound can be applied to the detection of foreign objects or investigation of structure in quality of dairy foods. In the case of foreign object detection where, for example, glass may be present in cheese a strong reflection and refraction should occur at the product–glass interface. Cho and Irudayaraj [59] employed noncontact ultrasound imaging to detect foreign objects in cheese. Noncontact ultrasound measurement is useful in situations where contact measurement that employ a liquid couplant between the transducer and food product may introduce contamination or adversely affect product quality. However where noncontact ultrasound measurement is employed the acoustic signal will be highly dependent on air conditions, for example, humidity and temperature. Cho and Irudayaraj [59] overcame this problem by employing an air instability compensation transducer with a fixed metal reference in front of its surface. They demonstrated that this improved the stability in velocity and thickness measurements in food and also that it was possible to detect glass and artificial holes in Cheddar cheese blocks giving the correct location and reasonable dimensions. The noncontact ultrasound imaging also detected naturally occurring holes and cracks in uncompromised Cheddar cheese blocks. This indicates that noncontact ultrasound imaging could also be used to characterize the internal structure of cheese [60].

The quality, commercial value, and acceptability of Swiss cheese are greatly affected by eye structure and pattern [61]. Eskelinen et al. [62] demonstrated the feasibility of using an ultrasonic method in which measurements were conducted through a commonly used maturation wrapper using water coupling. They compared three-dimensional (3D) ultrasound images with reference 3D images of Swiss cheese and found that eyes, cracks, and the cheese matrix could be differentiated in ultrasound images. The authors suggested that the technique could be employed in quality control applications such as defect detection, eye formation monitoring, and ripening stage monitoring.

### 15.3.4 *Magnetic Resonance Imaging*

MRI is based on the interaction between an external magnetic field and atomic particles, and electrons and nuclei that possess spin angular momentum [63]. It has been widely applied to food quality assessment, including investigation of phase separation, component distribution, rheology, and basic structure of dairy foods.

Due to the importance of eye formation on the quality of Swiss cheese, Rosenberg et al. [61] evaluated eye formation and structural quality of Swiss cheese by MRI. They found that MRI can

be used to nondestructively identify defective cheeses during the early stages of ripening and that potentially this could be used to identify the unit operation which is the cause of the defect which could then be adjusted appropriately to correct the problem.

Duce et al. [64] examined dairy foods in two and three dimensions using MRI. They utilized two-dimensional (2D) spin warp imaging to study the ripeness of cheese and to detect physical features such as holes and seams, missing pulse steady-state free precession (MP-SSFP) imaging to acquire 3D data to determine the size, shape, and distribution of voids within cheese and finally 2D chemical shift resolved Dixon imaging sequence to produce water- and lipid-resolved images of milk, for the study of milk-phase separation. They demonstrated that in spin warp imaging, air holes appeared black as air does not produce a NMR response; however, magnetic field gradients caused slight distortions in the images at the air–cheese interface making it difficult to measure their size, and hence 3D imaging was required to investigate 3D features such as the shape, size, and distribution of cheese voids. The signal intensity across cheese samples was also found to be related to sample homogeneity. Finally they proposed that it was also possible to determine the movement of milk lipids to the top of a vial of milk using chemical shift resolved Dixon imaging sequence; hence, water- and lipid-resolved imaging could be used to study the rate of the collapse of an emulsion. More recently MRI has been applied to the evaluation of curd grain structure using 3D magnetic resonance microimaging [65]. The technique allowed the author to visual carbon dioxide microbubbles and fat volumes on the curd grain surfaces.

In industry, where large cheese blocks are produced, rapid cooling can create an uneven distribution of moisture within the block, resulting in texture and flavor defects [66]. Ruan et al. [66] investigated MRI for the mapping of moisture and fat in Cheddar cheese blocks. They noted that variations in moisture and fat occurred throughout the cheese block and that the distribution of moisture was somewhat more variable than fat distribution.

MRI has also been applied to the characterization of yogurt rheology [67] as information on the flow behavior of yogurt is critical to the design of equipment, and control of the manufacturing process. Yoon and McCarthy [67] utilized a MRI viscometer to characterize yogurt flow properties in pipes. They found that in addition to yield stress, the magnetic resonance images clearly showed slip velocity at the pipe wall.

McCarthy and Choi [63] have stated that although MRI can provide a wide range of measurements for a wide range of products the difficulties associated with employing it in an on- or in-line setting, such as cost, complexity and equipment size, has, as yet, limited its uptake as a process control tool.

## 15.4 Dielectric Sensors

Dielectric spectroscopy has the potential to offer rapid, nondestructive, and real-time measurements of moisture and salt content. This technology is also cost-effective, robust and safe and has the potential to replace laboratory techniques that are labor-intensive and involve the use of chemicals [68]. Dielectric sensing could be used in a number of applications in both cheese and butter manufacture. Automated grading and quality control, detection of substandard product prior to distribution as well as improved control of the moisture to salt ratio would result in a more consistent cheese product, while in a continuous butter-making process it would facilitate greater control of salt and moisture contents.

Electromagnetic field effects at radio and microwave frequencies arise from interactions between the electrical components of an electromagnetic field and the chemical constituents of

a material [69]. When an electric field is applied, the electrical charges in that material try to orientate themselves in opposition to the polarity of the applied field. Equilibrium occurs when the effect of the field created by the separation of the two types of charges is equal and opposite in direction to that of the applied field [70]. This reorientation of the charges is termed polarization. For polar materials orientational polarization occurs, whereby the polar molecule and its dipole rotate to align with the field in order to take up a position of minimum potential energy in that field [70]. In many practical applications of dielectric sensing, dipole rotation takes place simultaneously along with ionic conduction. Ionic conduction is the conductive migration of dissolved ions in the applied electromagnetic field. At frequencies below the microwave region, conductive migration effects become increasingly more pronounced due to an inverse relationship between ionic loss and frequency [69]. The main dielectric properties of interest are the dielectric constant and the loss factor.

A number of studies have investigated the potential of dielectric sensing as a method for determining the composition of food products, with numerous studies emphasizing the application of dielectric spectroscopy for prediction of salt and moisture content in food products [71–73]. Kudra et al. [74] determined the dielectric properties of milk and its constituents at 2450 MHz. They determined the contribution of protein, lactose, and fat to the permittivity and loss factor and used this data to predict the electromagnetic properties of milk by the Hasted–Debye model.

Green [75] was one of the first to provide chemical analysis and dielectric measurements of cheese at high frequencies (750 MHz to 12.4 GHz). He observed decreases in both the dielectric constant and loss factor with decreasing moisture content along with a rapidly increasing loss factor at low frequencies when the salt content was increased. However the permittivity of the fat fraction was low and constant between 2.6 and 12.4 GHz. Therefore he concluded that the dielectric properties of Cheddar cheese were largely determined by their moisture and salt content.

Further work has led to the development of an online dielectric sensor by Keam Holdem Associates for the determination of moisture and salt content in natural cheese [71,72,76]. It consists of a broadband antenna directing a signal into the cheese block, allowing volumetric averaging of parameters such as moisture content and conductivity to be determined explicitly [72]. Mean differences between the predicted and actual results for moisture and salt content were approximately 0.5% and 0.2%, respectively.

Fagan et al. [77] and Everard et al. [78] applied dielectric spectroscopy to the characterization of processed cheese. Fagan et al. [77] determined that the dielectric constant and loss factor spectra (0.3–3 GHz) in conjunction with partial least squares regression could be used to predict moisture ( $R^2 = 0.98$ ) and inorganic salt content ( $R^2 = 0.90$ – $0.91$ ) of processed cheese products. Everard et al. [78] investigated the effect of temperature on the dielectric properties of processed cheese. They found that up to 55°C–75°C the dielectric constant generally decreased with increasing temperature, while the loss factor generally increased with increasing temperature.

Shiinoki et al. [73] stated that online monitoring of moisture and salt contents was also very important for controlling the process and quality during the manufacture of salted butter, but that it was very difficult to control the moisture and salt contents in a continuous butter-making process because they cannot be measured continuously or nondestructively. Hence they examined the potential of dielectric spectroscopy in such an application. They found that salt content had a greater influence on the attenuation of the microwaves transmitted through salted butter than on the phase shift and proposed that the moisture and salt contents could be independently predicted by measuring the two microwave propagation properties of phase shift and attenuation. Using the proposed method they found that measurement of phase shift and attenuation was accurate to  $\pm 0.1\%$  and  $\pm 0.2\%$  for the moisture and salt contents, respectively.

Keam Holdem Associates have also shown that dielectric sensing can be successfully applied to the simultaneous determination of moisture and salt content in butter [76]. They developed an online sensor which was installed inside a butter pipe and took measurements using a waveguide sensor. They found that the average difference between the dielectric and independent salt measurement during this period was 0.15%.

## 15.5 Process Viscometry

Viscosity measurement is an integral and necessary component of many quality control procedures in dairy food processing, for example, milk powder production. Cullen et al. [79] stated monitoring viscosity online/in-line provides real-time analysis, enabling the food technologist to control many unit operations with greater precision and confidence.

One such unit operation is the atomization step in spray drying which is central to the dehydration process. The viscosity of the milk concentrate at atomization will affect the final powder characteristics and hence its quality. However, due to its non-Newtonian flow properties, age-thickening characteristics, and the presence of suspended solids and gases, determining the viscosity of concentrated milk is difficult. The selection of a suitable online viscometer is dependent on a number of criteria as provided by Cullen et al. [79] (Figure 15.4).

O'Callaghan and O'Donnell [80] carried out an investigation of three online viscometers for use in milk powder manufacture at industrial scale. The viscometers comprised two types of vibrating probe and a sliding piston probe i.e., a torsional-mode vibrating probe, a transverse-mode vibrating probe, and a translational viscometer. Vibrational viscometers are considered surface-loaded systems, responding to a thin layer of fluid, which surrounds the oscillating probe. Measurement depends on the surrounding fluid dampening the probe vibration, in proportion to its viscosity and density [79]. Translational viscometers are based on the cyclic speed of a piston between two magnetic coils along a small measuring chamber, and it uses the piston stroke to refresh the sample. O'Callaghan and O'Donnell [80] measured the viscosity of concentrated milk online in a commercial evaporator and compared these measurements with off-line measurements of total solids. They found that there was potential to increase the level of milk concentration in the evaporator without exceeding the desired viscosity limit when either the preheat treatment was high or the protein-to-lactose ratio was low. They monitored the viscosity online of regular,

1. Conformity with grade standards.
2. Installation mode: inline, sidestream, or immersion.
3. Output signal required: intermittent or continuous, response time, etc.
4. Control parameter: viscosity, or some secondary related parameter; yield point,  $G'$ , etc.
5. Fluid characteristics: multiphase, solid particulates suspension, fibrous, fouling characteristics, etc.
6. Rheological characteristics of fluid: i.e., Newtonian or non-Newtonian, viscosity level, plastic, thixotropic, dilatant, etc.
7. Process operating conditions: temperature, pressure, and laminar/turbulent flow.
8. Viscometer characteristics: repeatability, reliability, precision required, construction materials, ease of cleaning, intrusiveness, moving parts, and seals.

**Figure 15.4** Selection criteria for food process viscometers. (Reprinted from Cullen, P.J. et al., *Trends Food Sci. Technol.*, 11, 451, 2000. With permission.)

low-, and high-density whole-milk powder at two points in the process, i.e., (a) ex-evaporator (before balance tank), and (b) preatomizer (before concentrate heater). They stated that torsional, vibrational viscometers had the most trouble-free performance of the systems evaluated for monitoring viscosity due to its high immunity to plant vibrations, ease of cleaning and lack of moving parts. However they did note that the design of the sliding piston viscometer was subsequently improved, which should eliminate a number of problems they encountered.

## Acknowledgments

The authors acknowledge funding provided by the Irish Department of Agriculture Fisheries and Food through the Food Institutional Research Measure (FIRM). The authors also gratefully acknowledge Dr. James Burger (BurgerMetrics, Latvia) for obtaining and analyzing the hyperspectral cheese images.

## References

- Balboni, M. L., Process analytical technology concepts and principles, *Pharm. Technol.* October 2003, 54–66, 2003.
- Carl, R. T., Quantification of the fat-content of milk using a partial-least-squares method of data-analysis in the near-Infrared, *Fres. J. Anal. Chem.* 339, 70–71, 1991.
- Kawamura, S. et al., Near-infrared spectroscopic sensing system for online monitoring of milk quality during milking, *Sens. Instrum. Food Qual. Saf.* 1, 37–43, 2007.
- Frank, J. F. and Birth, G. S., Application of near infrared reflectance spectroscopy to cheese analysis, *J. Dairy Sci.* 65, 1110–1116, 1982.
- Molt, K. and Kohn, S., Near-IR spectroscopy. Chemometry for processed cheese products in quality control and process analysis, *Dtsch. Milchwirtschaft* 44, 1102, 1104–1107, 1993.
- Blazquez, C. et al., Prediction of moisture, fat, and inorganic salts in processed cheese by near infrared reflectance spectroscopy and multivariate data analysis, *J. Near Infrared Spectrosc.* 12, 149–157, 2004.
- Rodriguezotero, J. L., Hermida, M., and Cepeda, A., Determination of fat, protein, and total solids in cheese by near-infrared reflectance spectroscopy, *J. AOAC Int.* 78, 802–806, 1995.
- Meagher, L. P. et al., At-line near-infrared spectroscopy for prediction of the solid fat content of milk fat from New Zealand butter, *J. Agric. Food Chem.* 55, 2791–2796, 2007.
- Reh, C., In-line and off-line FTIR measurements, in *Instrumentation and Sensors for the Food Industry*, 2nd edn., Kress-Rogers, E. and Brimelow, C. J. B., eds., Woodhead and CRC Press, Cambridge and Boca Raton, 2001, pp. 213–232.
- Fagan, C. C. and O'Donnell, C. P., Application of mid-infrared spectroscopy to food processing systems, in *Nondestructive Testing of Food Quality*, Irudayaraj, J. and Reh, C., eds., Blackwell Publishing, Ames, IA, 2008, pp. 119–143.
- Karoui, R. and De Baerdemaeker, J., A review of the analytical methods coupled with chemometric tools for the determination of the quality and identity of dairy products, *Food Chem.* 102, 621–640, 2007.
- Downey, G. et al., Prediction of maturity and sensory attributes of Cheddar cheese using near-infrared spectroscopy, *Int. Dairy J.* 15, 701–709, 2005.
- Blazquez, C. et al., Modelling of sensory and instrumental texture parameters in processed cheese by near infrared reflectance spectroscopy, *J. Dairy Res.* 73, 58–69, 2006.
- Kliman, P. G. and Pallansch, M. J., Method for determination of water in butteroil by near-Infrared spectrophotometry, *J. Dairy Sci.* 48, 859–862, 1965.



15. Sato, T., Kawano, S., and Iwamoto, M., Detection of foreign fat adulteration of milk fat by near infrared spectroscopic method, *J. Dairy Sci.* 73, 3408–3413, 1990.
16. Hermida, M. et al., Moisture, solids-non-fat and fat analysis in butter by near infrared spectroscopy, *Int. Dairy J.* 11, 93–98, 2001.
17. Reh, C., Bhat, S. N., and Berrut, S., Determination of water content in powdered milk, *Food Chem.* 86, 457–464, 2004.
18. Downey, G. et al., Classification of commercial skim milk powders according to heat treatment using factorial discriminant analysis of near-infrared reflectance spectra, *Appl. Spectrosc.* 44, 150–155, 1990.
19. Cen, H. Y. et al., Comparison of data pre-processing in pattern recognition of milk powder Vis/NIR spectra, in *Advanced Data Mining and Applications, Proceedings 2006*, 2006, pp. 1000–1007.
20. Maraboli, A., Cattaneo, T. M. P., and Giangiacomo, R., Detection of vegetable proteins from soy, pea and wheat isolates in milk powder by near infrared spectroscopy, *J. Near Infrared Spectrosc.* 10, 63–69, 2002.
21. Payne, F. A., Hicks, C. L., and Shen, P. S., Predicting optimal cutting time of coagulating milk using diffuse reflectance, *J. Dairy Sci.* 76, 48–61, 1993.
22. McQueen, D. H. et al., Comparison of two infrared spectroscopic methods for cheese analysis, *Talanta* 42, 2007–2015, 1995.
23. Downey, G., Food and food ingredient authentication by mid-infrared spectroscopy and chemometrics, *Trends Anal. Chem.* 17, 418–424, 1998.
24. Chen, M. X., Irudayaraj, J., and McMahan, D. J., Examination of full fat and reduced fat cheddar cheese during ripening by Fourier transform infrared spectroscopy, *J. Dairy Sci.* 81, 2791–2797, 1998.
25. Irudayaraj, J., Chen, M., and McMahan, D. J., Texture development in cheddar cheese during ripening, *Can. Agric. Eng.* 41, 253–258, 1999.
26. Kruzelecky, R. and Ghosh, A., Miniature spectrometers, in *Handbook of Vibrational Spectroscopy*, Chalmers, J. and Griffiths, P., eds., Wiley & Sons, Chichester, U.K., 2002, pp. 423–435.
27. Lefier, D., Lamprell, H., and Mazerolles, G., Evolution of *Lactococcus* strains during ripening in Brie cheese using Fourier transform infrared spectroscopy, *Lait* 80, 247–254, 2000.
28. Lucia, V., Daniela, B., and Rosalba, L., Use of Fourier transform infrared spectroscopy to evaluate the proteolytic activity of *Yarrowia lipolytica* and its contribution to cheese ripening, *Int. J. Food Microbiol.* 69, 113–123, 2001.
29. Dufour, E. et al., Phase transition of triglycerides during semi-hard cheese ripening, *Int. Dairy J.* 10, 81–93, 2000.
30. Karoui, R. et al., Chemical characterisation of European Emmental cheeses by near infrared spectroscopy using chemometric tools, *Int. Dairy J.* 16, 1211–1217, 2006.
31. Karoui, R. et al., Determining the geographic origin of Emmental cheeses produced during winter and summer using a technique based on the concatenation of MIR and fluorescence spectroscopic data, *Eur. Food Res. Technol.* 219, 184–189, 2004.
32. Pillonel, L. et al., Analytical methods for the determination of the geographic origin of Emmental cheese: Mid- and near-infrared spectroscopy, *Eur. Food Res. Technol.* 216, 174–178, 2003.
33. Fagan, C. C. et al., Evaluating mid-infrared spectroscopy as a new technique for predicting sensory texture attributes of processed cheese, *J. Dairy Sci.* 90, 1122–1132, 2007.
34. Fagan, C. C. et al., Prediction of processed cheese instrumental texture and meltability by mid-infrared spectroscopy coupled with chemometric tools, *J. Food Eng.* 80, 1068–1077, 2007.
35. Ballard, D. A. and Brown, C. M., *Computer Vision*, Prentice-Hall, Englewood Cliffs, NJ, 1982.
36. Wang, H. H. and Sun, D. W., Melting characteristics of cheese: Analysis of effect of cheese dimensions using computer vision techniques, *J. Food Eng.* 52, 279–284, 2002.
37. Olson, N. F. and Price, W. V., A melting test for pasteurized process cheese spreads, *J. Dairy Sci.* 41, 999–1000, 1958.
38. Arnott, D. R., Morris, H. A., and Combs, W. B., Effect of certain chemical factors on the melting quality of process cheese, *J. Dairy Sci.* 40, 957–963, 1957.

39. Kosikowski, F. V., *Cheese and fermented milk foods*, 2nd edn., F.V. Kosikowski and Associates, New York, 1982.
40. Park, J., Rosenau, J. R., and Peleg, M., Comparison of four procedures of cheese meltability evaluation, *J. Food Sci.* 49, 1158–1162, 1170, 1984.
41. Wang, H. H. and Sun, D. W., Melting characteristics of cheese: Analysis of effects of cooking conditions using computer vision technology, *J. Food Eng.* 51, 305–310, 2002.
42. Muthukumarappan, K., Wang, Y. C., and Gunasekaran, S., Modified Schreiber test for evaluation of Mozzarella cheese meltability, *J. Dairy Sci.* 82, 1068–1071, 1999.
43. Wang, H. H. and Sun, D. W., Evaluation of the functional properties of Cheddar cheese using a computer vision method, *J. Food Eng.* 49, 49–53, 2001.
44. Wang, H. H. and Sun, D. W., Correlation between cheese meltability determined with a computer vision method and with Arnott and Schreiber tests, *J. Food Sci.* 67, 745–749, 2002.
45. Wang, H. H. and Sun, D. W., Assessment of cheese browning affected by baking conditions using computer vision, *J. Food Eng.* 56, 339–345, 2003.
46. Everard, C. D. et al., Correlation between process cheese meltability determined by sensory analysis, computer vision method and Olson and Price test, *Int. J. Food Prop.* 8, 267–275, 2005.
47. Ni, H. and Gunasekaran, S., A computer vision method for determining length of cheese shreds, *Artif. Intell. Rev.* 12, 27–37, 1998.
48. Ni, H. X. and Gunasekaran, S., Image processing algorithm for cheese shred evaluation, *J. Food Eng.* 61, 37–45, 2004.
49. Jelinski, T. et al., Inspection of the distribution and amount of ingredients in pasteurized cheese by computer vision, *J. Food Eng.* 83, 3–9, 2007.
50. Everard, C. D. et al., Computer vision and color measurement techniques for inline monitoring of cheese curd syneresis, *J. Dairy Sci.* 90, 3162–3170, 2007.
51. Fagan, C. C. et al., Application of image texture analysis for online determination of curd moisture and whey solids in a laboratory scale stirred cheese vat, *J. Food Sci.* 73, E250–E280, 2008.
52. Gowen, A. A. et al., Hyperspectral imaging—an emerging process analytical tool for food quality and safety control, *Trends Food Sci. Technol.* 18, 590–598, 2007.
53. Liu, Y. et al., Development of simple algorithms for the detection of fecal contaminants on apples from visible/near infrared hyperspectral reflectance imaging, *J. Food Eng.* 81, 412–418, 2007.
54. Qiao, J. et al., Pork quality and marbling level assessment using a hyperspectral imaging system, *J. Food Eng.* 83, 10–16, 2007.
55. Park, B. et al., Contaminant classification of poultry hyperspectral imagery using a spectral angle mapper algorithm, *Biosyst. Eng.* 96, 323–333, 2007.
56. Burger, J. and Geladi, P., Hyperspectral NIR image regression part II: Dataset preprocessing diagnostics, *J. Chemometr.* 20, 106–119, 2006.
57. Qin, J. W. and Lu, R. F., Measurement of the absorption and scattering properties of turbid liquid foods using hyperspectral imaging, *Appl. Spectrosc.* 61, 388–396, 2007.
58. Gan, T. H., Pallav, P., and Hutchins, D. A., Non-contact ultrasonic quality measurements of food products, *J. Food Eng.* 77, 239–247, 2006.
59. Cho, B. K. and Irudayaraj, J. M. K., Foreign object and internal disorder detection in food materials using noncontact ultrasound imaging, *J. Food Sci.* 68, 967–974, 2003.
60. Gülseren, I. and Coupland, J. N., Ultrasound: New tools for product improvement, in *Nondestructive Testing of Food Quality*, Irudayaraj, J. and Reh, C., eds., Blackwell Publishing, Ames, IA, 2008, pp. 45–66.
61. Rosenberg, M., McCarthy, M., and Kauten, R., Evaluation of eye formation and structural quality of Swiss-type cheese by magnetic-resonance-imaging, *J. Dairy Sci.* 75, 2083–2091, 1992.
62. Eskelinen, J. J. et al., Preliminary study of ultrasonic structural quality control of Swiss-type cheese, *J. Dairy Sci.* 90, 4071–4077, 2007.
63. McCarthy, M. J. and Choi, Y. J., Recent advances in nondestructive testing with nuclear magnetic resonance, in *Nondestructive Testing of Food Quality*, Irudayaraj, J. and Reh, C., eds., Blackwell Publishing, Ames, IA, 2008, pp. 211–236.

64. Duce, S. L. et al., Nuclear-magnetic-resonance imaging of dairy-products in 2-dimensions and 3-dimensions, *Int. Dairy J.* 5, 311–319, 1995.
65. Mahdjoub, R. et al., High resolution magnetic resonance imaging evaluation of cheese, *J. Food Sci.* 68, 1982–1984, 2003.
66. Ruan, R. et al., A magnetic resonance imaging technique for quantitative mapping of moisture and fat in a cheese block, *J. Dairy Sci.* 81, 9–15, 1998.
67. Yoon, W. B. and McCarthy, K. L., Rheology of yogurt during pipe flow as characterized by magnetic resonance imaging, *J. Texture Stud.* 33, 431–444, 2002.
68. Fagan, C. C. and O'Donnell, C. P., Dielectric sensing of salt concentrations, in *Encyclopedia of Agricultural, Food, and Biological Engineering*, Heldman, D. R., ed., Marcel Dekker, New York, 2005, pp. 1–4.
69. Mudgett, R. E., Electrical properties of foods, in *Engineering Properties of Foods*, 2nd edn., Rao, M. A. and Rizvi, S. S. H., eds., Marcel Dekker, New York, 1995, pp. 389–454.
70. Kent, M. et al., Composition of foods including added water using microwave dielectric spectra, *Food Control* 12, 467–482, 2001.
71. Keam Holdem Associates Ltd., On-line measurement of cheese curd moisture on the draining belt, in *Application Note KHA0413* Auckland, New Zealand, 1999, pp. 1–4.
72. Keam Holdem Associates Ltd., On-line measurement of moisture and salt content of 20 kg cheese blocks, in *Application Note KHA0414* Auckland, New Zealand, 1999.
73. Shiinoki, Y., Motouri, Y., and Ito, K., On-line monitoring of moisture and salt contents by the microwave transmission method in a continuous salted butter-making process, *J. Food Eng.* 38, 153–167, 1998.
74. Kudra, T. et al., Electromagnetic properties of milk and its constituents at 2.45 GHz, *J. Microw. Power Electromag. Energy* 27, 199–204, 1992.
75. Green, A. D., Measurements of the dielectric properties of cheddar cheese, *J. Microw. Power Electromag. Energy* 32, 16–27, 1997.
76. Keam Holdem Associates Ltd., Salt measurement in dairy products, in *Application Note KHA0415* Auckland, New Zealand, 1999, pp. 1–2.
77. Fagan, C. C. et al., Prediction of inorganic salt and moisture content of process cheese using dielectric spectroscopy, *Int. J. Food Prop.* 8, 543–557, 2005.
78. Everard, C. D. et al., Dielectric properties of process cheese from 0.3 to 3 GHz, *J. Food Eng.* 75, 415–422, 2006.
79. Cullen, P. J. et al., Process viscometry for the food industry, *Trends Food Sci. Technol.* 11, 451–457, 2000.
80. O'Callaghan, D. J. and O'Donnell, C. P., On-line sensor control for milk powder and cheese manufacture, End of Project Report 2000, DPRC No. 42, Teagasc, Fermoy, 2001, p. 15.

## Chapter 16

---

# Rheological Properties and Flavor Release

---

Nathalie Cayot

### CONTENTS

16.1	Introduction.....	346
16.1.1	Textural Variety of Dairy Foods.....	346
16.1.2	Influence of Rheological Properties on Flavor Release.....	347
16.2	How to Characterize Flavor Release?.....	348
16.2.1	Mechanistic Approach to Flavor Release.....	348
16.2.2	Methods to Measure Diffusion.....	348
16.2.2.1	Nuclear Magnetic Resonance and Self-Diffusion.....	349
16.2.2.2	Concentration Profiles.....	349
16.2.2.3	Diffusion Cell.....	350
16.2.3	Methods to Measure Flavor Transfer.....	352
16.2.3.1	<i>In Vitro</i> or <i>In Vivo</i> Experiments.....	352
16.2.3.2	Static or Dynamic Headspace Measurements.....	353
16.3	Influence of Rheological Properties on Flavor Release from Dairy Foods.....	353
16.3.1	Gel Model Systems.....	353
16.3.2	Yoghurts.....	354
16.3.3	Custard.....	355
16.3.4	Cheese.....	357
16.4	Conclusion.....	358
	References.....	358

## 16.1 Introduction

Flavor is one of the key factors determining food quality and acceptance. When formulating food products, it is thus important to be able to control flavoring during processing, storage, and consumption. Since the release of aroma compounds is widely assumed to be responsible for the characteristic flavor of food, many works focus on the release of volatile constituents. Aroma compounds present in a food product are distributed between the matrix and the gas phase. Then, a fraction of the free flavor can reach the olfactory receptors and the food consumer can perceive the aroma.

Food texture may be of concern at different levels but is a main concern during food consumption. In fact, the way to handle food depends a lot on its texture: beyond interindividual differences, liquid products are swallowed more rapidly than solid products. The strength applied by teeth to bite food products and to transform the food bolus depends a lot on food stiffness. When food is eaten, it undergoes many modifications due to mastication, but also dilution through the addition of saliva, and variation in temperature. These modifications result in great changes in food structure and texture, and thus involve significant changes in the partition of aroma compounds between the matrix and the air phase [1].

### 16.1.1 *Textural Variety of Dairy Foods*

The dairy industry is one of the most highly developed food industries in the world. In fact, as a major source of protein, milk was used from the very beginning of humanity when prehistoric man became a stock breeder. Together with the development of the food industry, many industrial dairy products appeared, thanks to processes such as thermal treatments (UHT), protein fractionation (isolation, purification), and protein modification (enzymes, microorganisms).

All the resulting by-products or intermediate products were thus involved in food formulations to design new foods, new textures, new functionalities, and new services.

The functional properties of milk proteins are diverse: mainly, gelling properties, emulsifying properties, and foaming properties. Within the range of dairy products, these properties are used to produce:

- Gels with a wide range of hardness and mesostructure depending on the mechanism involved in gel setting (thermal gelation, coagulation by acidification, or by enzymatic action) and depending on the ripening (from yoghurts to cheeses).
- Emulsions and foams, such as ice creams.

The addition of polysaccharides may lead to semiliquid to semisolid dairy desserts.

Dairy products could also be multiphasic products or multilayer products.

Flavor perception is governed by the way aroma molecules are distributed through various phases [2]. In multilayer products, for example, containing dairy products and fruit preparations, transfers of colorings, sugar, water, protons, and flavor occur simultaneously between the different layers due to concentration gradients and can modify the sensory properties of the product [3].

The texture and rheological characteristics of such products are linked to their mesostructure, i.e., aggregation of casein micelles, thermodynamic incompatibility between polysaccharides, granulometry of particles, or size of fat globules.

For example, creaminess, one important property of texture for semisolid dairy desserts, can be increased by

- Increasing the bulk-viscosity of the food.
- Minimizing, but not eliminating, loss of bulk-viscosity during oral processing by using starches that show limited mechanical and enzymatic break down during oral processing.
- Using small stable fat droplets.
- Adding flavors associated with creaminess [4].

Others [5] found that fat-free, stirred yoghurts could be perceived more or less creamy depending on the viscosity, as for semisolid dairy desserts, and on the particle size: products perceived as creamy were firm; however, when particle size was above 150 nm, products could not be perceived as creamy.

### 16.1.2 Influence of Rheological Properties on Flavor Release

Many studies, done in a static state, i.e., in a state of equilibrium between the matrix and the gaseous phase, showed that the chemical nature of the different constituents involved in the product and their state have an impact on aroma partition [6]. For example, Relkin et al. [7] reported studies with flavored food emulsions containing either hydrogenated palm kernel oil or anhydrous milk fat. The fats differed by their fatty acid and triacylglycerol compositions and by their melting behavior, while the aroma compounds (ethyl butanoate, ethyl hexanoate, methyl hexanoate, mesifurane, linalool, diacetyl, *cis*-3-hexen-1-ol, and gamma-octalactone) differed by their hydrophobicity. Differential scanning calorimetry measurements applied to fat samples in bulk and emulsified forms indicated differences in the ratio of solid-to-liquid between temperatures ranging from 10°C to 35°C. Solid-phase microextraction (SPME) coupled with GC–MS analysis indicated that flavor release from food emulsions containing animal or vegetable fat differed depending on both the nature of the fat and the hydrophobicity of the flavor compound.

Additionally, other authors demonstrated that aroma transfer through the different phases may be influenced by the structure of the matrix. For example, Seuvre et al. [8] studied the retention of some aroma compounds in a medium based on water and miglyol. This mixture was emulsified with  $\beta$ -lactoglobulin or used as it is. Among the studied aroma compounds, 2-nonanone, and isoamyl acetate present opposite behaviors: the volatility of isoamyl acetate was not affected by the change of the medium structure, whereas the volatility of 2-nonanone increased. The authors attributed the decrease of retention of 2-nonanone in the emulsified system to a modification in the fixation site for this compound on the protein or to competition between the lipid and the aroma compound, while the protein was adsorbed at the lipid–water interface.

In viscous or solid matrices, diffusion of small molecules such as volatile compounds may be lowered. In fact, following the Stokes–Einstein law (Equation 16.1), the diffusion coefficient of a molecule in a given medium is inversely proportional to its viscosity:

$$D_i = \frac{kT}{6\pi\eta r} \quad (16.1)$$

with

$k$  is the Boltzman constant

$T$  is the temperature (K)

$\eta$  is the dynamic viscosity (Pa s)

$r$  is the radius of the molecule (m)

This was also observed in gelled products containing polysaccharides [9–14].

During food consumption, mastication influences flavor perception due to the increase in surface exchange and the modification of the concentration gradient for the aroma compounds. During this step, the food product is distorted by teeth, tongue, and palate. Different types of distortion can be distinguished: shearing, stretching, and compression, fractionation. The main type of distortion will depend on the structure of the product: for a solid product, mainly compression and fractionation will occur, for a viscous product, shearing will be the main distortion observed [15].

Several *in vitro* studies showed that mastication led to an increase in aroma release [16,17]. Other authors [18] reported that the duration of mastication had an impact on the amount of released aroma, depending on the polarity of the aroma compound.

Considering all these studies, it appears that aroma release and its evolution with rheological properties is a complex phenomenon. Both macroscopic and microscopic scales must be considered to fully understand the rheological properties of the food matrix as well as the partition of aroma compounds. More than that, static and dynamic measurements are needed to fully understand the mechanisms of aroma release. Methods are being explored in order to make measurements at different scales and to make it possible to handle texture variation and flavor release simultaneously.

## 16.2 How to Characterize Flavor Release?

### 16.2.1 Mechanistic Approach to Flavor Release

As discussed above, the measurement of transport phenomena is a central preoccupation when trying to explain aroma perception.

In food products, transfers of small molecules can occur between two phases of the product that are heterogeneous in terms of composition or in terms of physical state (liquid, solid, or gaseous). To measure these transfers, diffusion coefficients ( $D$ ) are needed. However, it is not always easy to determine such dynamic parameters [19]. Many methods exist but they are not always suitable for the measurement of transport phenomena of volatiles [20].

Two main mechanisms of mass transfer can be considered in such cases: convective transport in well-stirred phases and diffusive transport in motionless phases.

Diffusion is the process by which matter is transported from one part of a system to another [21]. The rate of transfer of one component across a fixed-volume section may be expressed as the combined effect of mass flow, proportional to the concentration gradient normal to the section, and true diffusion, resulting from random molecular motions [22]. Molecular diffusion can be explained by the free volume concept [23] and also depends on medium viscosity, as expressed by Stokes–Einstein relations that distinguish translational and rotational diffusions. Translational diffusion, expressed in  $\text{m}^2 \text{s}^{-1}$ , corresponds to the diffusion of molecules as a function of their concentration gradient. Rotational diffusion, expressed in  $\text{s}^{-1}$ , corresponds to the frequency of molecular reorientation.

Experimentally, while determining diffusion coefficients in a complex medium, the term apparent or effective diffusion is generally preferred because not only molecular diffusion is taken into account but also other phenomena, which cannot be distinguished from molecular diffusion, such as capillary or Knudsen diffusion, as well as diffusion modification due to matrix changes (obstruction, retraction...) are taken into account.

### 16.2.2 Methods to Measure Diffusion

There is no standardized method to determine the diffusivity of small molecules in food systems. Pure or true diffusion based on Fick's law rarely occurs alone as foods are complex systems with

different phases (gas, liquid, gel, solid), each of them being characterized by different transport properties. Effective or apparent diffusivity is generally measured for these complex systems.

Instrumental techniques such as nuclear magnetic resonance (NMR) spectroscopy are high-resolution tools for diffusion measurements in homogeneous media, but mobility can also be characterized by experimental methods based on the presence of a concentration gradient [24]. Some methods that have been used to determine diffusivity of aroma compounds within solid or semisolid (such as gels) food products are reported hereafter.

### 16.2.2.1 Nuclear Magnetic Resonance and Self-Diffusion

By using radioactively labeled molecules, it is possible to determine the rate of diffusion of one component in a two-component system of uniform chemical composition. What is involved is an interchange of labeled and unlabeled molecules while the total amount of that molecule, labeled and unlabeled, is constant throughout the system. As a consequence, no mass-flow occurs and what is measured is a self-diffusion coefficient [21].

The NMR spectroscopic technique using the pulsed field gradient (PFG) spin-echo method is a nondestructive and noninvasive way to measure the self-diffusion coefficient of small molecules through the detection of their protons' mobility, but only for values over  $10^{-14} \text{ m}^2 \text{ s}^{-1}$  [25]. This method is thus perfectly suitable for high-water content media, such as water or aroma compounds in gels [26]. Likewise, the PFG-diffusion ordered spectroscopy (DOSY) technique also gives self-diffusion coefficients through the identification of protons assigned to a given molecule, as for aroma compounds in sucrose-based solutions or a carrageenan matrix [12,27].

In the study of Savary et al. [27], cross-linked waxy corn starch and carrageenans in combination with sucrose were used to mimic the structure of fruit preparation models. DOSY-PGF-NMR spectroscopy was used to measure self-diffusion coefficients of aroma molecules in the model fruit preparations. The authors reported that this method was convenient and accurate. It allowed them to show that, in the studied systems, the decrease in the self-diffusion of aroma molecules was principally dependent on the sucrose content. As a consequence, self-diffusion decreased as medium viscosity increased.

### 16.2.2.2 Concentration Profiles

At a microscopic scale, the concentration–distance curves—or concentration profiles—method consists of bringing into contact two cylinders of a solid or semisolid product, either of which contains a different initial concentration of the studied substance. The concentration profiles are measured from their distance to the interface, as a function of time, along a one-dimension axis. However, this type of experiment is generally destructive. Thin slicing of the sample gives a spatial resolution of about 1 mm. It was used by different authors [3,28–30].

Recently, Nongonierma et al. [3] used such a method to study the transfer of colorants in a multiphasic stirred fruit yoghurt model. This yoghurt model was made of a pectin gel aimed to mimic fruit pieces and a dairy gel made with milk acidified by glucono- $\delta$ -lactone hydrolysis. To measure transfers, the gels were put in glass tubes of 200 mm length and 5 mm internal diameter half filled with the pectin gel and the other half with the dairy gel. The tubes were closed with septa. Transfer of colorants was determined by measuring the optical density in the biphasic samples, at different storage times. The optical density was measured every 0.8 mm in each gel.



Diffusivity of the colorant was determined using Fick's second law, assuming that

- At  $T = 0$ , there was no colorant in the noncolored gel (pectin gel)
- The concentration of colorant in the colored gel (dairy gel) was constant
- During the transfer, there was a local equilibrium at the interface between the two gels
- There was no accumulation of colorant at the interface

Thanks to this method, the authors found that the diffusivity in the two gels depended not only on the molar mass of the colorants, but also on their charge. In the pectin gel, the diffusivity of negatively charged colorants was the lowest. The authors hypothesized that charged colorants might interact with the constituents of the pectin gel. In the dairy gel, migration of colorants was affected by hydrophobic and electrostatic interactions with the components of the gel (i.e., proteins and fat).

### 16.2.2.3 Diffusion Cell

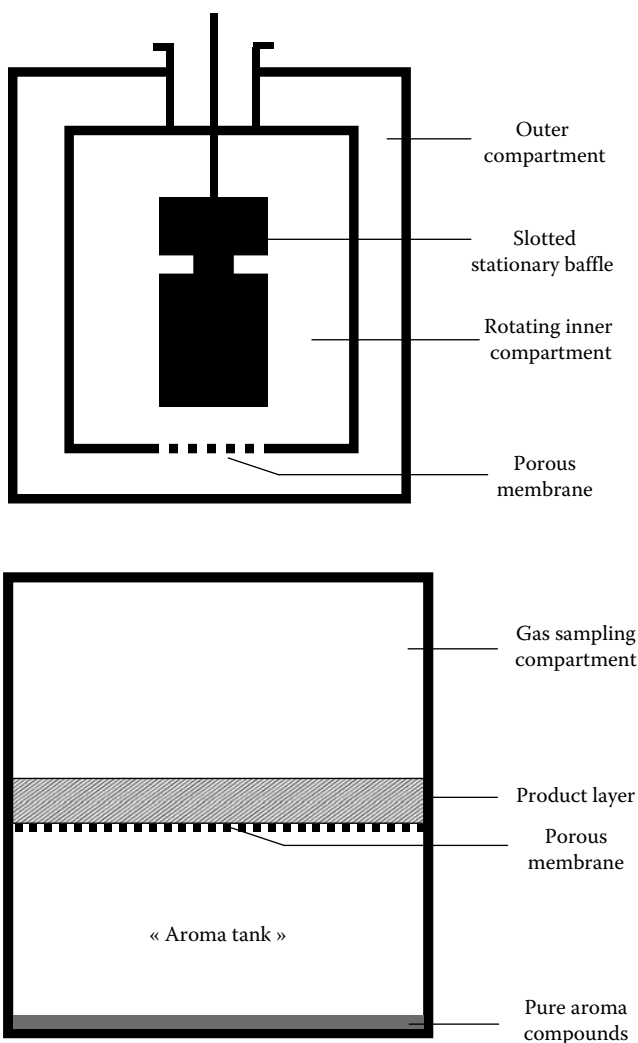
With the diaphragm cell technique, two compartments (with different initial solute concentrations) are separated by the product in which the diffusivity has to be measured [31]. As the solute diffuses through the product, concentrations in both compartments are measured as a function of time, and the diffusion coefficient is determined on the basis of Fick's second law.

On this basis, a rotating diffusion cell was developed to investigate the rate of transfer of solutes from an aqueous phase to another phase through a lipid layer, as a model of double emulsions, along with the resistances to mass transfer within the aqueous boundary layers, across the oil–water interface and within the oil layer. The rotating diffusion cell (Figure 16.1a) was designed hydrodynamically in such a way that stationary diffusion layers of known thickness were created on each side of the oil layer [32].

Landy et al. [32] used this device to study the transfer of solutes (ethyl acetate, ethyl butanoate, and ethyl hexanoate) from aqueous phases to oil (miglyol), and from oil to aqueous phases by determining resistances to mass transfer of the solute and by estimating the rate-limiting step of the transfer. They found that the transfer of ethyl acetate through the interface was the rate-limiting step, while the transfer of ethyl butanoate and ethyl hexanoate through the oil was limited by the diffusion in the aqueous phase. The effect of sodium caseinate was different for the less hydrophobic compound (ethyl acetate) and the more hydrophobic compounds (ethyl butanoate and ethyl hexanoate); in the presence of sodium caseinate, the  $R_{aq}$  value (resistance to diffusion through the two stagnant aqueous diffusion layers which are established at each side of the filter) increased for ethyl acetate, while the  $R_l$  value (resistance due to the solute transfer across the two aqueous phase/oil interfaces) increased for ethyl butanoate and ethyl hexanoate.

Déléris et al. [24] developed another experimental device, based on the diffusion cell concept, to determine the apparent diffusivity of aroma compounds within food products using direct gaseous measurements.

In their device, two main gaseous compartments were separated by the food product being studied, which was supported by a thin hydrophobic porous membrane. The “aroma tank” (Figure 16.1b) contained a small volume of pure aroma compounds and ensured a constant gaseous concentration throughout the whole experiment. Aroma compounds moved from the lower compartment, passed through the gas phase contained within the membrane pores, diffused through the food product, and were finally released into the gaseous phase of the sampling compartment.



**Figure 16.1** Schematic representation of different diffusion cells used to measure diffusion of aroma compounds. (a) Rotating diffusion cell. (Adapted from Landy, P. et al., *Colloids Surf. B: Biointerfaces*, 12(1), 57, 1998.) (b) Diffusion cell. (Adapted from D el eris, I. et al., *J. Food Eng.*, 85(2), 232, 2008. With permission.)

They compared the diffusion results they obtained using this device with data found in the literature for simple model systems and concluded that their system was reliable and robust. Then, they used this diffusion cell to measure apparent diffusion coefficients of ethyl hexanoate and ethyl acetate in a stirred yoghurt enriched with caseinates. They found that the yoghurt had a clear impact on the diffusion properties of both compounds: the presence of yoghurt decreased diffusion compared with that measured within 1% agar gel. Depending on the physicochemical properties of aroma compounds, the effect was much more pronounced for ethyl hexanoate (36-fold decrease) than for ethyl acetate (2.4-fold reduction).

### 16.2.3 *Methods to Measure Flavor Transfer*

Numerous methods have been developed to monitor variations in aroma concentration in the gas phase as a function of time. The development by Lee [33] of a system, which was able to monitor the headspace continuously by using a mass spectrometer coupled with a dynamic headspace system, was followed by many other attempts to follow and/or reproduce the oral processing of food.

When the purpose is to follow aroma release during the consumption of a food product, the measurement can be done directly during consumption of the food product thanks to *in vivo* measurement as is the case for the API-MS “in nose” method or the “in mouth” method as developed by Taylor and Linfoth [34]. Sensory analysis and *in vivo* aroma delivery were carried out in low-fat and regular-fat milk samples prepared with the same amount of ethyl hexanoate [35]. The sensory results were in accordance with differences in aroma delivery, with low-fat samples delivering more ethyl hexanoate than regular-fat samples. Aroma content in low-fat samples was adjusted so that aroma delivery *in vivo* was the same for both low-fat and regular-fat samples. In this case, panelists could not differentiate between samples, which showed a good correlation between aroma delivery and perception. In this case, concerning a liquid product with a major and well-known effect of fat, the sensory method and *in vivo* aroma measurement were in accordance, which is not always the case for other products.

Some devices can also be used to mimic phenomena occurring during food consumption (*in vitro* measurement). Van Ruth and Roozen [36] developed a model system in which mouth conditions are simulated taking into account the volume of the mouth, temperature, salivation, and mastication. Different laboratories are developing more and more complex “artificial mouth” systems, which are able to handle food products of different textures. Such a device is being designed by Mielle et al. [37] with the objective to reproduce as closely as possible the deconstruction of food as done by teeth and by the compression between tongue and palate.

Depending on the aim of the study, on the timescale for observations, and on the methods available, experiments can be conducted by discrete or by continuous sampling of the headspace. For the qualitative and quantitative analyses of volatile compounds, gas chromatography is of course the reference technique.

The release of volatile compounds may be influenced by numerous parameters such as temperature, structure or texture, pressure, relative humidity, dilution by saliva, enzymatic reactions, respiratory flux, and chewing pattern. The control of all these parameters is of major importance for the reproducibility of measurements and comparisons of data sets.

#### 16.2.3.1 *In Vitro or In Vivo Experiments*

Concerning *in vivo* measurements, the flavored food product is placed in the mouth and flavor release in the oral or nasal cavity is analyzed, whereas for *in vitro* measurements the product is placed in a container and the analysis concerns aroma compounds released in the headspace.

In both cases, several forms of sampling and detection can be used. Most of the time, direct analysis is used for *in vivo* measurements with proton-transfer reaction mass spectrometry (PTR-MS) or atmospheric pressure chemical ionization mass spectrometry (APCI-MS). In this case, chemical ionization allows quantitative analysis of aroma release on line [38]. For *in vitro* measurements, sampling of the gaseous phase was more often done by discrete sampling with a gas syringe, an SPME fiber or *via* a trap on an adsorbent polymer.

### 16.2.3.2 Static or Dynamic Headspace Measurements

For *in vitro* measurements, the analysis of the headspace can be done using static or dynamic measurements. In static measurements, the gas phase is sampled at thermodynamic equilibrium and the system is closed, whereas in dynamic measurements equilibrium is not reached and the system is open. The method of exponential dilution consists in studying the exponential decrease in the concentration of aroma compounds in the gas phase with time after reaching equilibrium [39,40]. Other authors considered an initial state near zero and followed the release of aroma compounds in the headspace with time until reaching equilibrium [41].

## 16.3 Influence of Rheological Properties on Flavor Release from Dairy Foods

### 16.3.1 Gel Model Systems

Gel model systems have often been used to study interactions between specific compounds of dairy products and aroma compounds or even to follow transfers and other transport phenomena. Gel models based on biopolymers are convenient models to study the impact of texture on aroma release, as their rheological properties can be easily modified by varying biopolymers in concentration or in nature. Nevertheless, the consequence of such an approach is that it is sometimes difficult to separate the impact of physicochemical interactions from the impact of texture on aroma release, and it is risky to show a general trend.

In gel model systems, different authors [42,43] observed that aroma release decreased when the rigidity of gels increased. However, Weel et al. [44] and Mestres et al. [45] showed that the quantity of aroma released was not modified by the texture of whey protein gels. Other studies showed an increase in the amount of aroma released with increased hardness of gelatin and pectin gels [13].

In a recent study, Monge et al. [46] used pectin gels at different polymer concentrations as matrices for the encapsulation of a volatile flavor (limonene). They aimed to study the influence of the viscoelastic properties of the matrix on flavor release toward the gel headspace. The electronic nose technique and principal component analysis were used to detect changes in the fingerprint of the released vapor as a function of pectin concentration. Samples with different compositions were also studied by rheological measurements in order to distinguish between the effects of polymer concentration on gelation kinetics and those due to the addition of limonene and the detergent used to dissolve it.

They obtained a correlation between the decrease in flavor release intensity and the increase in solid-like character of the matrix. Comparing the viscoelastic properties of matrices with and without the flavor, with direct observations by optical microscopy, the authors concluded that the release modulation was mainly due to the interaction of the gelling pectin with the microemulsion of detergent and flavor.

The release of a strawberry aroma from different composite gels taken as models of fruit preparations and from a sucrose solution was investigated by Savary et al. [47]. The composition of the model systems differed with regard to the gelling agent, either pectin or carrageenan, and to the rigidity of the gel. The release profiles of the aroma compounds were determined under stirring by APCI-MS. At the same time, purge and trap measurements were performed to determine the release profiles of the aroma compounds without stirring. The authors aimed to determine how

the structure of the matrix, the mechanical treatment and the properties of the aroma compound affect aroma release. In purge and trap measurements, the gelled systems were not sheared and the structure of these unsheared gelled matrices played a role in the release of ethyl hexanoate; in the case of the carrageenan-based composite systems, increasing the amount of carrageenan induced a decrease in the release of ethyl hexanoate. APCI-MS experiments showed clearly that an increase in the release of ethyl hexanoate was triggered as soon as stirring was applied:

- The more gelled the matrix, the faster the release.
- The higher the initial rigidity of the gel, the greater the degree of break down and the greater the amount of aroma compound released from the matrix.

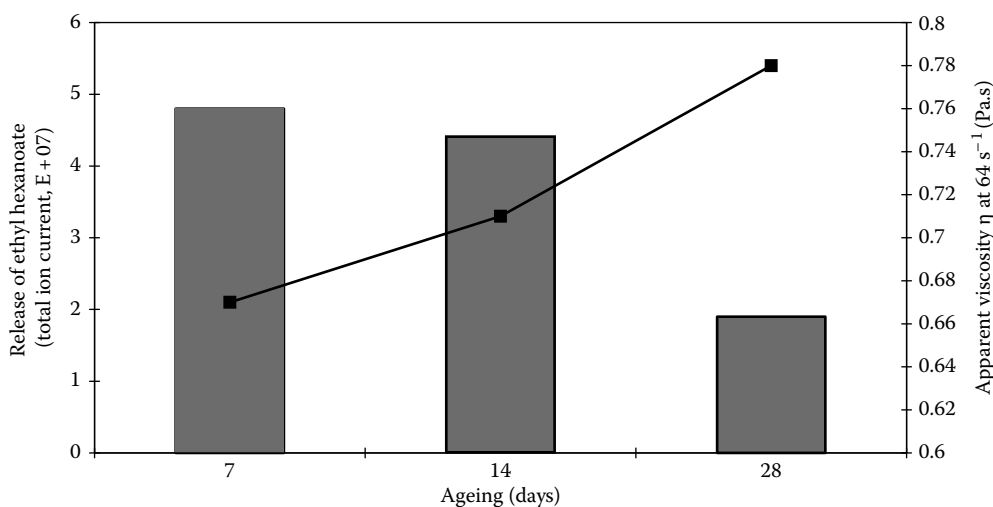
The results with the sucrose solution showed a higher release of aroma compounds as compared to the release from gels that was attributed to a higher diffusion coefficient. In fact, Savary et al. [27] measured this parameter by NMR-DOSY and found that for ethyl butyrate, release from the gel was about 50% lower than that from the sucrose solution.

### **16.3.2 Yoghurts**

In the field of dairy products, yoghurts of different types were a main concern.

To study aroma release from stirred yoghurt during storage, Decourcelle et al. [48] used a blend of five aroma compounds in food concentrations. Thickeners were incorporated into industrial yoghurt via a model fruit preparation. Flavor release from the yoghurt was determined using a SPME method. Rheological characterization was performed to try to link the release of the aroma compound and the macroscopic properties of yoghurt. Flavor release and rheological properties of the product were followed during a 28 days storage period. The apparent viscosity ( $\eta$ ) at a shear rate of  $64\text{ s}^{-1}$  was obtained with a coaxial cylinder viscometer at  $21^\circ\text{C}$ . No significant difference was noted between the first two samples (7 and 14 days). At the third period of aging, the quantity of flavors in the headspace of yoghurts was significantly lower for methyl 2-methylbutanoate, ethyl hexanoate, and hexyl acetate. The quantity was half in comparison with that in day 7 (Figure 16.2). The authors underlined that, putting aside the presence of proteins and polysaccharides, which can interact with aroma compounds; the rheological characteristics of yoghurt change during aging. The main effect they observed on a plain yoghurt was an increase in viscosity due to bacterial activity, which decreased the pH during aging. Indeed, the strength of the protein network increased along with the increase in the amount of lactic acid and exopolysaccharide production, from live bacteria in yoghurt. They thus concluded that the changes in rheological properties observed during aging could partly explain the results in flavor release.

Nongonierma et al. [49] followed the release of strawberry flavor compounds at vapor/matrix interfaces in model food systems simulating a yoghurt with a fruit preparation syrup. The effect of different parameters including the physicochemical characteristics of the flavor compound, the structure, and composition of the matrix and the temperature on the release of the flavor compounds were investigated. There was an effect of the composition and structure of the matrix upon the partition of the flavor compounds. In the dairy gel, retention of flavor compounds was caused by the physicochemical interactions with the proteins and the solubilization in dispersed fat. The addition of syrup to the low-fat dairy gel slightly increased the retention of the flavor compounds; this was attributed to physicochemical interactions with pectin and sucrose. In the presence of fat (5%), the flavor compounds were solubilized in the fat and their release was not affected by the composition of the dispersing medium. As expected, temperature affected the release; an increase



**Figure 16.2** Release of ethyl hexanoate and apparent viscosity for fat-free stirred yoghurt during storage. Aroma release was followed by SPME. Apparent viscosity was measured in a coaxial cylinder viscometer at  $64 \text{ s}^{-1}$ . Both measurements were conducted at  $21^\circ\text{C}$ . (Adapted from Decourcelle, N. et al., *Int. Dairy J.*, 4(9), 783, 2004.)

from  $4^\circ\text{C}$  to  $10^\circ\text{C}$  resulted in an increase in the overall amount of flavor released. This work is in accordance with the numerous studies that demonstrate the preponderant effect of fat on the flavor release from model yoghurts. In the low-fat dairy gels used by the authors, the addition of thickeners such as pectin contained in the syrup was not sufficient to control the release. Nongonierma et al. [49] suggested that the structure of the residual fat globules of skimmed milk could be modified in order to improve the sensory quality of low-fat yoghurts.

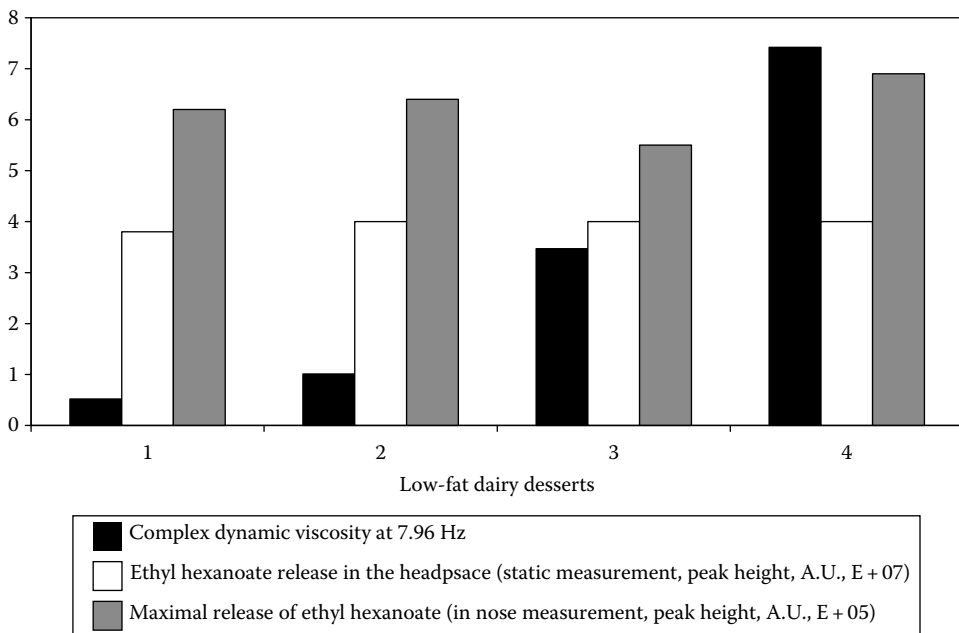
### 16.3.3 Custard

De Wijk et al. [50] studied the effect of milk fat content (0%–15%) in vanilla custards with different starch types and concentrations by means of sensory and instrumental tests such as image analysis, turbidity, friction, and rheological measurements. They found great differences in the texture attributes perceived in these systems due to the different fat contents used. Tárrega and Costell [51] observed important differences in the pasting behavior, viscoelastic parameters, and the in-mouth thickness perceived when studying skimmed and whole milk dairy desserts containing  $\lambda$ -carrageenan. A work of Gonzalez-Tomas et al. [52] dealt with the influence of the type of milk (whole or skimmed) on the flow behavior, flavor release, and perception of strawberry-flavored custard model systems. The type of milk was observed to influence flavor release and sensory perception of strawberry flavor.

Lethuaut et al. [53] observed differences in the perceived texture of dairy desserts formulated with skimmed milk, two levels of sucrose and three types of carrageenan. In a later work, Lethuaut et al. [54] studied the *in vivo* release by MS-nose and sensory perception of flavor by time–intensity measurements with the same samples. Changes in sweetness and aroma perception were observed, while aroma release remained unaffected, suggesting that perceptual interactions between aroma, sweetness, and texture occurred.

In a recent work, Gonzalez-Tomas et al. [55] studied aroma release by APCI-MS in low-fat dairy desserts. Four formulations were prepared with different starch concentrations, with or without  $\kappa$ -carrageenan. The amounts of sugar, strawberry flavor, and the weight of rehydrated skimmed milk remained fixed. Ten panelists were asked to breathe in, sip 5 mL of sample, close their mouths, swallow the sample then exhale, and continue to breathe normally while resting their nose on the APCI-MS nasal sampling tube. The data were analyzed to extract two parameters, the maximum aroma intensity ( $I_{\max}$ ) and the cumulative area under the 1 min release profile ( $A_{\text{cum}}$ ). The rheological properties of the low-fat desserts were significantly affected by both starch and  $\kappa$ -carrageenan content, leading to significant differences in the orally perceived thickness. In spite of these differences, neither flavor release nor the perception of strawberry flavor intensity of the low-fat dairy dessert was significantly affected (Figure 16.3).

Kersiene et al. [56] studied the same type of products, measuring flavor release of custard desserts by headspace SPME. The authors also concluded that the presence of milk fat induced a significant decrease in the headspace concentration of flavor compounds. An elevated starch concentration enhanced the strength of the custard gels considerably. During storage time, a denser network was formed as shown by rheological measurements, but no significant difference in flavor release was noted upon storage (3 days).

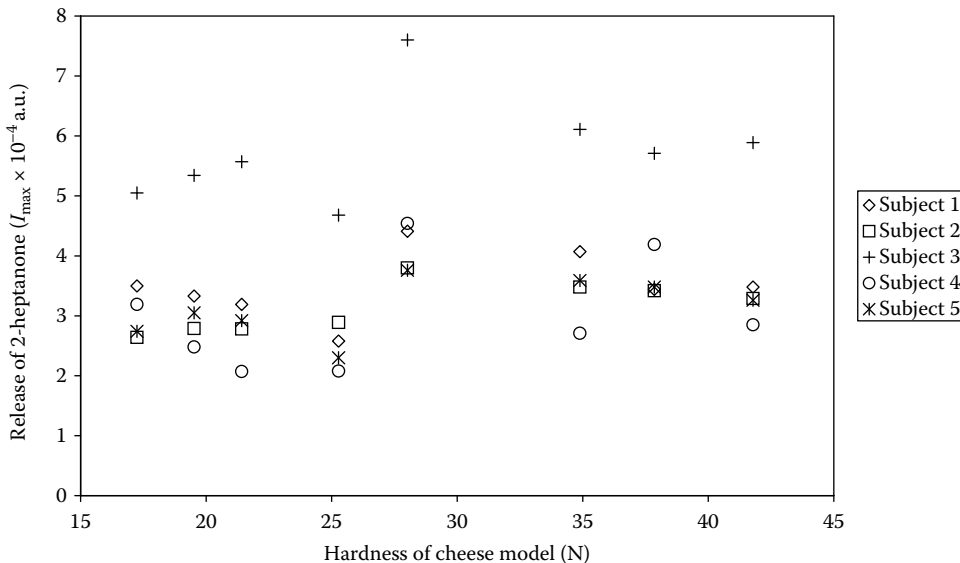


**Figure 16.3** Dynamic complex viscosity and release of ethyl hexanoate for various models of low-fat dairy desserts storage. Rheological measurements were carried out in a controlled stress rheometer using parallel plate geometry at 10°C. Static headspace measurements were done by sampling the headspaces in turn into the APCI-MS at 5 mL min<sup>-1</sup>. For *in vivo* aroma release, 10 panelists were asked to breathe in, sip 5 mL of sample, close their mouths, swallow the sample then exhale and continue to breathe normally, while resting their nose on the APCI-MS nasal sampling tube. Air from the nose was sampled into the APCI-MS source at 40 mL min<sup>-1</sup>. (Adapted from Gonzalez-Tomas, L. et al., *Food Res. Int.*, 40(4), 520, 2007.)

### 16.3.4 Cheese

Gierczynski et al. [57] observed an increase in the amount of aroma release with an increased hardness of model cheeses.

Tarrega et al. [58] studied the effect of cheese characteristics on both chewing behavior and aroma release. For this purpose, they followed the release of four aroma compounds during the consumption of eight equally flavored model cheeses. Cheese analogs of significantly different hardness were manufactured. They varied in the lipid–protein ratio, the type of fat, and the mixing speed during processing. The hardness of the cheese was determined with a TA-XT2 Texture Analyser at 10°C using a cylindrical probe of 5 mm diameter. The force required to penetrate the sample to a depth of 5 mm at a speed of 1 mm s<sup>-1</sup> was recorded as the hardness value ( $N$ ). The kinetics of aroma release and the chewing activity were simultaneously monitored during the consumption of cheese cubes by five subjects. Aroma release in breath was measured using API-MS. Value of the maximum concentration reached ( $I_{\max}$ ) was recorded on aroma release profiles obtained for each compound, product, and subject. Data obtained for 2-heptanone is shown in Figure 16.4. Tarrega et al. [58] analyzed their data through PLS regression applied to, on the one hand, the chewing parameters, cheese variables, and cheese hardness, and on the other hand, aroma release parameters. They concluded that the increase in hardness led to a considerable increase in chewing activity. In this case, the negative effect the structure had on aroma release can be counteracted and even inverted. Thanks to this study, they highlighted the strong interaction between cheese composition and chewing behavior on aroma release during cheese consumption. The composition influenced the texture of the product, which in turn influenced the chewing pattern and both influenced aroma release.



**Figure 16.4** *In vivo* aroma release from various model cheeses as a function of their hardness. Rheological measurements were carried out by penetrometry with a TA-XT2 at 10°C. Aroma release was monitored during the consumption of cheese cubes (7 g, 10°C) by five subjects. Subjects were asked to introduce the cheese cube in the mouth and to chew without swallowing. After completing 20 chewing cycles, they were allowed to swallow when they wanted. Aroma release in breath was measured using API-MS. Air from the nose was sampled at a flow rate of 35 mL min<sup>-1</sup>.  $I_{\max}$  is the maximum released intensity. (Adapted from Tarrega, A. et al., *Int. Dairy J.*, 18, 849, 2008.)



## 16.4 Conclusion

From the results reported above, it appears that many methodological problems are still to be solved in order to study the impact of texture on flavor release.

- Firstly, there are numerous types of transfer and other transport phenomena, but they are often studied separately. Progress needs to be made in the measurement of at least coupled transfer analysis.
- Another difficulty is to handle the evolution of texture and aroma release simultaneously. Continuous sampling of aroma release can be achieved *in vivo* by APCI-MS, but the continuous measurement of the evolution of the rheological characteristics of a food bolus is not possible. In “mouth simulator” devices, it is often possible to measure viscosity and aroma release together continuously. Other devices are to be developed for solid products or to permit more sophisticated rheological measurements.
- Finally, the link between aroma release and aroma perception is still not well established. Among all interindividual differences that may explain the gap between aroma release and aroma perception, some authors stressed the impact of panelists’ chewing patterns on the measurements. Other explanations also concern interaction among senses.

Nevertheless, assuming all the biases in the cited methodologies are solved, all the reported studies suggest that, in most cases, physicochemical interactions have a greater impact on aroma release than does texture. The effect of fat in particular has been extensively demonstrated. In addition to the cited examples, studies have also been conducted on ice creams. Li et al. [59] and Frøst et al. [60] found differences between ice-cream samples with different fat levels, both in terms of flavor and textural properties. Miettinen et al. [61] also reported that the amount of fat-affected aroma release when studying strawberry flavor ice creams with an electronic nose, sensory tests, and gas chromatography.

Nevertheless, in low-fat products, texture is a major factor in the control of aroma release.

## References

1. Taylor, A.J. et al., In vivo measurement of flavour release from mixed phase gels. *Biomol. Eng.*, 17(4–5): 143–150, 2001.
2. Bruin, S., Phase equilibria for food product and process design. *Fluid Phase Equilib.*, 158–160: 657–671, 1999.
3. Nongonierma, A.B. et al., Transfers of small analytes in a multiphasic stirred fruit yoghurt model. *Food Hydrocol.*, 21(2): 287–296, 2007.
4. de Wijk, R.A. et al., Perceived creaminess of semi-solid foods. *Trends Food Sci. Technol.*, 17(8): 412–422, 2006.
5. Cayot, P. et al., Creaminess in relation to consistency and particle size in stirred fat-free yogurt. *Int. Dairy J.*, 18(3): 303–311, 2008.
6. Guichard, E., Interactions between flavor compounds and food ingredients and their influence on flavor perception. *Food Rev. Int.*, 18(1): 49–70, 2002.
7. Relkin, P., M. Fabre, and E. Guichard, Effect of fat nature and aroma compound hydrophobicity on flavor release from complex food emulsions. *J. Agric. Food Chem.*, 52(20): 6257–6263, 2004.
8. Seuvre, A.M., M.A. Espinosa Diaz, and A. Voilley, Influence of the food matrix structure on the retention of aroma compounds. *J. Agric. Food Chem.*, 48(9): 4296–4300, 2000.
9. Rega, B., E. Guichard, and A. Voilley, Flavour release from pectin gels: Effects of texture, molecular interactions and aroma compounds diffusion. *Sci. Aliments*, 22: 235–248, 2002.

10. Lubbers, S. and E. Guichard, The effects of sugars and pectin on flavour release from a fruit pastille model system. *Food Chem.*, 81(2): 269–273, 2003.
11. Bylaite, E. et al., Influence of lambda-carrageenan on the release of systematic series of volatile flavor compounds from viscous food model systems. *J. Agric. Food Chem.*, 52(11): 3542–3549, 2004.
12. Gostan, T. et al., Measurement of aroma compound self-diffusion in food models by DOSY. *Magn. Reson. Chem.*, 42(6): 496–499, 2004.
13. Boland, A.B., C.M. Delahunty, and S.M. van Ruth, Influence of the texture of gelatin gels and pectin gels on strawberry flavour release and perception. *Food Chem.*, 96(3): 452–460, 2006.
14. Juteau, A. et al., Flavour release from polysaccharide gels: Different approaches for the determination of kinetic parameters. *Trends Food Sci. Technol.*, 15(7–8): 394–402, 2004.
15. Overbosch, P., W.G.M. Afterof, and P.G.M. Haring, Flavor release in the mouth. *Food Rev. Int.*, 7(2): 137–184, 1991.
16. van Ruth, S.M. and J.P. Roozen, Influence of mastication and saliva on aroma release in a model mouth system. *Food Chem.*, 71(3): 339–345, 2000.
17. van Ruth, S.M. and K. Buhr, Influence of mastication rate on dynamic flavour release analysed by combined model mouth/proton transfer reaction-mass spectrometry. *Int. J. Mass Spectrom.*, 239(2–3): 187–192, 2004.
18. Buettner, A. and P. Schieberle, Influence of mastication on the concentrations of aroma volatiles—Some aspects of flavour release and flavour perception. *Food Chem.*, 71(3): 347–354, 2000.
19. Voilley, A. and I. Souchon, Flavour retention and release from the food matrix: An overview. In A. Voilley and P. Etievant (Eds.), *Flavour in Food*. Cambridge, U.K.: Woodhead Publishing Limited, 2006.
20. Cayot, N. et al., Measurement of transport phenomena of volatile compounds: A review. *Food Res. Int.*, 41(4): 349–362, 2008.
21. Crank, J. and G.S. Park, Methods of measurement. In J. Crank and G.S. Park (Eds.), *Diffusion in Polymers*. London: Academic Press Inc., 1968, pp. 1–39.
22. Crank, J., *The Mathematics of Diffusion*, 2nd edn. Oxford, U.K.: Oxford University Press, 1975.
23. Vrentas, C.M. and J.L. Duda, Diffusion of small molecules in amorphous polymers. *Macromolecules*, 9: 785–779, 1976.
24. Déléris, I. et al., An experimental device to determine the apparent diffusivities of aroma compounds. *J. Food Eng.*, 85(2): 232–242, 2008.
25. Stilbs, P., Fourier transform pulsed-gradient spin-echo studies of molecular diffusion. *Prog. Nucl. Magn. Reson. Spectrosc.*, 19(1): 1–45, 1987.
26. Rondeau-Mouro, C. et al., NMR investigations of the 4-ethyl guaicol self-diffusion in iota (iota)-carrageenan gels. *Carbohydr. Pol.*, 57(4): 459–468, 2004.
27. Savary, G. et al., Influence of ingredients on the self-diffusion of aroma compounds in a model fruit preparation: An nuclear magnetic resonance-diffusion-ordered spectroscopy investigation. *J. Agric. Food Chem.*, 54(3): 665–671, 2006.
28. Karathanos, V.T., A.E. Kostaropoulos, and G.D. Saravacos, Diffusion and equilibrium of water in dough/raisin mixtures. *J. Food Eng.*, 25(1): 113–121, 1995.
29. Monnerat, S.M. et al., Concentration profiles and effective diffusion coefficients of sucrose and water in osmo-dehydrated apples. *Food Res. Int.*, 39(6): 739–748, 2006.
30. Champion, D., H. Hervet, G. Blond, and D. Simatos, Comparison between two methods to measure translational diffusion of a small molecule at subzero temperature. *J. Agric. Food Chem.*, 43: 2887–2891, 1995.
31. Cussler, E.L., *Diffusion: Mass Transfer in Fluid Systems* (Cambridge Series in Chemical Engineering), 2nd edn.. Cambridge, U.K.: Cambridge University Press, 1997.
32. Landy, P. et al., Thermodynamic and kinetic aspects of the transport of small molecules in dispersed systems. *Colloids Surf. B: Biointerfaces*, 12(1): 57–65, 1998.
33. Lee, W.E.I., A suggested instrumental technique for studying dynamic flavor release from food products. *J. Food Sci.*, 51(1): 249–250, 1986.

34. Taylor, J.A. and R.S.T. Linforth, Methodology for measuring volatile profiles in the mouth and nose during eating, in *Trends in Flavour Research*, H. Maarse and D.G. van der Heij (Eds.). Amsterdam, the Netherlands: Elsevier Science, 1994, pp. 3–14.
35. Shojaei, Z.A., R.S.T. Linforth, and A.J. Taylor, Estimation of the oil water partition coefficient, experimental and theoretical approaches related to volatile behaviour in milk. *Food Chem.*, 103(3): 689–694, 2007.
36. van Ruth, S.M. and J.P. Roozen, Gas chromatography/sniffing port analysis and sensory evaluation of commercially dried bell peppers (*Capsicum annuum*) after rehydration. *Food Chem.*, 51(2): 165–170, 1994.
37. Mielle, P. et al., An “artificial mouth” as a novel sampling device for E-nose, E-tongue and API-MS, in *Proceedings of the 11th International Symposium Olfaction & Electronic Noses (ISOEN 05)*, Barcelona, ESP, 2005.
38. Hansson, A., P. Giannouli, and S. Van Ruth, The influence of gel strength on aroma release from pectin gels in a model mouth and in vivo, monitored with proton-transfer-reaction mass spectrometry. *J. Agric. Food Chem.*, 51(16): 4732–4740, 2003.
39. Langourieux, S. and J. Crouzet, Study of aroma compound–natural polymer interactions by dynamic coupled column liquid chromatography. *J. Chromatogr. A*, 707(2): 181–187, 1995.
40. Seuvre, A.M., M.A. Espinoza Diaz, and A. Voilley, Transfer of aroma compounds through the lipidic-aqueous interface in a complex system. *J. Agric. Food Chem.*, 50: 1106–1110, 2002.
41. Juteau, A., J.L. Doublier, and E. Guichard, Flavor release from iota-carrageenan matrices: A kinetic approach. *J. Agric. Food Chem.*, 52(6): 1621–1629, 2004.
42. Baek, I., et al., Sensory perception is related to the rate of change of volatile concentration in-nose during eating of model gels. *Chem. Senses*, 24(2): 155–160, 1999.
43. Guinard, J.X. and C. Marty, Time-intensity measurement of flavor release from a model gel system: Effect of gelling agent type and concentration. *J. Food Sci.*, 60(4): 727–730, 1995.
44. Weel, K.G.C. et al., Flavor release and perception of flavored whey protein gels: Perception is determined by texture rather than by release. *J. Agric. Food Chem.*, 50(18): 5149–5155, 2002.
45. Mestres, M. et al., Aroma release and retronasal perception during and after consumption of flavored whey protein gels with different textures. 1. In vivo release analysis. *J. Agric. Food Chem.*, 53(2): 403–409, 2005.
46. Monge, E.M., et al., Correlation between rheological properties and limonene release in pectin gels using an electronic nose. *Food Hydrocol.*, 22(5): 916–924, 2008.
47. Savary, G., et al., Impact of destroying the structure of model gels on volatile release. *J. Agric. Food Chem.*, 55(17): 7099–7106, 2007.
48. Decourcelle, N. et al., Effect of thickeners and sweeteners on the release of blended aroma compounds in fat-free stirred yoghurt during shear conditions. *Int. Dairy J.*, 4(9): 783–789, 2004.
49. Nongonierma, A.B. et al., Flavour release at gas/matrix interfaces of stirred yoghurt models. *Int. Dairy J.*, 16(2): 102–110, 2006.
50. de Wijk, R.A., J.F. Prinz, and A.M. Janssen, Explaining perceived oral texture of starch-based custard desserts from standard and novel instrumental tests. *Food Hydrocol.*, 20(1): 24–34, 2006.
51. Tárrega, A. and E. Costell, Effect of composition on the rheological behaviour and sensory properties of semisolid dairy dessert. *Food Hydrocoll.*, 20(6): 914–922, 2006.
52. Gonzalez-Tomas, L., et al., Flavour release and perception from model dairy custards. *Food Res. Int.*, 40(4): 520–528, 2007.
53. Lethuaut, L. et al., Sweetness–texture interactions in model dairy desserts: Effect of sucrose concentration and the carrageenan type. *Int. Dairy J.*, 13: 631–641, 2003.
54. Lethuaut, L. et al., Flavor perception and aroma release from model dairy desserts. *J. Agric. Food Chem.*, 52(11): 3478–3485, 2004.
55. Gonzalez-Tomas, L. et al., Rheology, flavour release and perception of low-fat dairy desserts. *Int. Dairy J.*, 18(8): 858–866, 2008.

56. Kersiene, M. et al., Interactions between flavour release and rheological properties in model custard desserts: Effect of starch concentration and milk fat. *Food Chem.*, 108(4): 1183–1191, 2008.
57. Gierczynski, I. et al., Impact of hardness of model cheese on aroma release: In vivo and in-vitro study. *J. Agric. Food Chem.*, 55(8): 3066–3073, 2007.
58. Tarrega, A. et al., Aroma release and chewing activity during eating different model cheeses. *Int. Dairy J.*, 18(8): 849–857, 2008.
59. Li, Z. et al., Effect of milk fat content on flavor perception of vanilla ice cream. *J. Dairy Sci.*, 80(12): 3133–3141, 1997.
60. Frøst, M.B. et al., Sensory measurement of dynamic flavour intensity in ice cream with different fat levels and flavourings. *Food Qual. Pref.*, 16(4): 305–314, 2005.
61. Miettinen, S.M. et al., Electronic and human nose in the detection of aroma differences between strawberry ice cream of varying fat content. *J. Food Sci.*, 67(1): 425–430, 2002.



## *Chapter 17*

---

# Determination of Identity and Quality of Dairy Products

---

Romdhane Karoui

### CONTENTS

17.1	Introduction .....	364
17.2	Traditional Techniques Used for Monitoring Cheese Ripening and Determination of the Quality and Authenticity of Dairy Products .....	364
17.2.1	Physicochemical Analyses.....	364
17.2.2	Liquid Chromatographic Techniques.....	365
17.2.3	Gas Chromatographic Techniques .....	367
17.2.4	Rheological Techniques.....	367
17.2.5	Sensory Analysis.....	368
17.3	Spectroscopic Techniques Used for the Determination of the Quality and Authenticity of Dairy Products.....	369
17.3.1	Control of Coagulation, Syneresis, and Heat Treatment.....	369
17.3.2	Monitoring of Cheese Ripening.....	371
17.3.3	Measurements of Cheese Composition, Cheese Rheology, and Sensory Attributes .....	373
17.3.4	Cheese Authenticity Determination .....	375
17.4	Conclusion .....	379
	References.....	380

## 17.1 Introduction

There is an increasing demand of the consumers and actors of the food industry sector to have means of measurement allowing the characterization of food. Dairy products such as milk, ice cream, yogurt, butter, cheese, and the like are in considerable demand, command premium prices and are, therefore, vulnerable to economic adulteration. The determination of the quality and identity of these products is an important issue for food processors, retailers, regulatory authorities, and consumers. It is also valuable for ensuring fair competition and as a means of protecting consumers against fraud due to mislabeling. Different analytical techniques could be utilized: (1) the traditional analytical strategies that have relied on wet chemistry to determine the amount of a marker compound or compounds in a suspect material and a subsequent comparison of the value(s) obtained with those established for equivalent material of known provenance [1]. This approach suffers from a number of disadvantages, namely, the ever-increasing range of analytes, which must be included in any test procedures and the limited knowledge of the range of each constituent in normal lots of the substance. In addition, the above-mentioned methods required sophisticated analytical equipments and skilled operators; they are also time consuming and need both the purchase and disposal of chemical reagents. For all these reasons, there is a continuing demand for (2) new, rapid, and relatively cheaper methods for direct quality measurement in food and food ingredients. Spectroscopic techniques, such as near infrared (NIR), midinfrared (MIR), front-face fluorescence spectroscopy (FFFS), stable isotope, and nuclear magnetic resonance (NMR) have demonstrated their ability for the determination of the quality and/or geographical origins of dairy products [2]. This chapter will provide the reader with a review of the use of different techniques for the assessment of the quality of dairy products. This chapter also examines some of the reported approaches adopted for the determination of the identity and quality of dairy products by using multivariate statistical analyses.

## 17.2 Traditional Techniques Used for Monitoring Cheese Ripening and Determination of the Quality and Authenticity of Dairy Products

### 17.2.1 *Physicochemical Analyses*

Cheese-making is dependent upon local, regional, or national traditions leading to differences between cheeses of the same variety but of different origins. Starters, heating temperature of the curd, brining, and ripening time are some of the processing parameters that are typical for a defined region and lead to chemical, physical, or microbial secondary indicators. Indicators of origin for produced dairy products were reported to be subdivided into primary and secondary indicators [2]. The first indicators are not influenced by the technology applied for manufacture or ripening conditions but depend only on the feed of the cows, while the secondary indicators depend on the technology used for manufacturing the product. Guinot-Thomas et al. [3] monitored the changes that occur in milk kept at 4°C for 24 and 48 h. The authors showed that no significant difference for nitrogenous compounds (caseins, whey proteins, and nonprotein nitrogen) was observed between the investigated milk samples. However, mineral composition presented significant changes; indeed, milk samples kept at 4°C for 24 h exhibited a decrease of 50%, 36%, 30%, and 40% for calcium, phosphorus, magnesium, and sodium, respectively, while milk kept at 4°C during 48 h showed a decrease of 75%, 22%, 53%, and 50% for calcium, phosphorus, magnesium, and sodium, respectively.

Bugaud et al. [4] pointed out the impact of pastures given to the herd on the physicochemical parameters of both milk and cheese samples. In their research, the protein amount of milk samples produced in mountain pastures ( $n=5$ , 1500–1850 m) was similar to those produced in valley pastures ( $n=5$ , 850–1100 m), while fat content of milk and cheese samples from the mountain were found to be lower than that of the valley. The obtained results confirmed partially previous findings performed on Abondance semi-hard French cheese made with milk produced in the mountain which presented the highest values of most indicators of proteolysis, while those produced with milk produced in the valley showed the lowest ones [5].

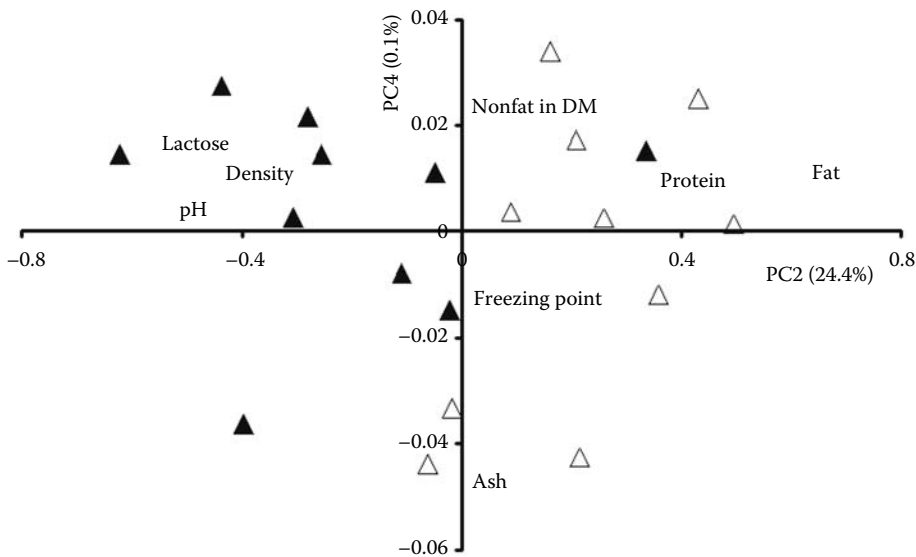
Recently, Pillonel et al. [6] pointed out that some chemical parameters such as total nitrogen (TN), water-soluble nitrogen (WSN), 12% TCA soluble nitrogen (TCA-SN), and pH could be considered as promising parameters among others to discriminate Emmental cheeses produced during winter (110 samples) and summer (73 samples) periods and originating from different European countries, in agreement with previous findings of Millán et al. [7] who used some chemical parameters (such as ammonia nitrogen, nonprotein nitrogen, moisture, salt, and pH) for differentiating between 80 cheeses representative of 10 varieties of Spanish cheeses. By using discriminant analysis (DA), 10% of correct classification was obtained. One of the main conclusions of this study was that the physicochemical parameters could be considered as a suitable tool for discriminating cheeses according to their varieties.

Recently, Maâmouri et al. [8] used some physicochemical parameters (pH, density, nonfat in dry matter [DM], fat, protein, lactose, ash, and freezing point) for discriminating Sicilo-Sarde ewe's milk during the lactation period after replacing soybean meal with scotch bean in the feed ration. Some physicochemical parameter (density, protein, and nonfat DM levels) were found to be significantly ( $P \leq 0.05$ ) lower at the beginning of the lactation period, whereas the freezing point values showed an opposite trend. In order to have into account the whole data sets, principal component analysis (PCA) was applied to the normalized data sets. The obtained result is shown in Figure 17.1. According to the principal component 2 (PC2) accounting for 24.4% of the total variance, milk from ewes fed on scotch bean meal presented mostly negative scores, while milk produced from ewes fed on soybean meal exhibited mostly positive score values. The authors concluded that the composition of diets had an effect on the physicochemical parameters of milk. The same research group continued this work by recording physicochemical parameters on two genotypes ewe's (Sicilo-Sarde and Comisana) milk during lactation period. The PCA performed on the physicochemical period did not allow a good discrimination between milk samples produced from the two-genotype ewe's [9]. The authors concluded that the physicochemical analyses could not be considered as a powerful tool to identify milk samples according to their breeds, but recommended further investigations in this area of study.

## 17.2.2 Liquid Chromatographic Techniques

Liquid chromatograph could be used for dairy compounds that cannot be volatilized readily. O'shea et al. [10] used reverse phase high-performance liquid chromatography (RP-HPLC) to analyze water-soluble fraction of 60 Cheddar cheeses, varying in age (mild, mature, and extra-mature) and flavor quality (defective, nondefective). Only 33.3% and 48.3% of samples were correctly classified. Using the total concentration of free amino acids, 70% of correct classification was obtained for all the cheeses, while only 20% of mature cheeses were correctly classified. In a similar approach, Pripp et al. [11,12] applied PCA and hierarchical cluster analysis (HCA) to the RP-HPLC chromatograms of ethanol (70%) soluble and insoluble fractions and free





**Figure 17.1** PCA similarity map determined by principal components 2 (PC2) and 4 (PC4) of the physicochemical parameters recorded on Sicilo-Sardegna ewe's milk fed soybean meal ( $\Delta$ ) and scotch bean ( $\blacktriangle$ ) during lactation period.

amino acids to evaluate proteolysis in Cheddar-type model cheeses made by the use of different single-strain starters. From the PCA applied to the RP-HPLC chromatograms of ethanol (70%) soluble and insoluble fractions on cheeses that were 2 months old, the researchers concluded that group strains could be classified according to their effects on chromatographic profiles and free amino acids. Ferreira and Caçote [13] continued this work and utilized RP-HPLC to assess its potential for detecting and quantifying bovine, ovine, and caprine milk percentages in milks and cheeses. As expected, different chromatographic profiles were obtained for each type of milk binary mixtures. In addition, similar chromatographic profiles were obtained for each milk mixture and the respective fresh and ripened cheeses. One of the main conclusions of this study was that RP-HPLC could be considered as a very sensitive and accurate method for studying milk percentage as well as fresh and ripened cheeses made from binary mixtures of bovine, ovine, or caprine raw milks.

In a similar approach, Bara-Herczegh et al. [14] applied multivariate statistical analysis to identify the indices of secondary proteolysis by using HPLC of 40 Hungarian Trappist cheeses throughout ripening as well as during storage for 28, 42, 56, and 70 days. The authors concluded that the results obtained could be possible to monitor the significant changes of fractions of different molecular weight during the ripening time and shelf-life using HPLC.

Frau et al. [15] used an amino analyzer by ion-exchange chromatography on a sulfonated polystyrene column with postcolumn ninhydrin derivation to quantify free amino acids in Mahon cheese made with raw milk (three batches) and pasteurized milk (two batches). The cheeses were analyzed at 10, 60, 150, and 300 days of ripening. The authors applied PCA to the 27 amino acids and derived compounds and the results obtained allowed the discrimination of cheeses according to their ripening times and the quality of milk used for producing the cheeses.

### 17.2.3 Gas Chromatographic Techniques

Flavor compounds in dairy products are characteristics; consequently, the quantity and quality of flavor constituents analyzed by gas chromatography could be used as an efficient tool for determining the quality and identity of dairy products [16].

Terpene content in dairy products are influenced by the feed given to the herd and especially by grazed herbage. In this context, Viallon et al. [17] utilized dynamic head space to extract monoterpenes and sesquiterpenes in milk fat, and then gas chromatography to separate these compounds collected from different cows fed successively with forage containing high and low amounts of terpenes. The modification of the plant species composition of forages was found to strongly influence the proportions and quantities of monoterpenes and sesquiterpenes in milk fat.

In a similar approach, Fernandez et al. [18] used dynamic head space-gas chromatography–mass spectrometry (DHS-GC–MS) to discriminate 35 milk samples produced in both high- and low-land region in France. The milk samples were collected during both the grazing period (spring and summer) and the stabling period (winter). Correct classification of 100% was observed for milk samples according to their geographical origin irrespective of season herd management pattern. The authors concluded that terpene compounds could provide useful fingerprints for the characterization of dairy products according to their geographical origin and their production conditions.

In another approach, Collomb et al. [19] used gas chromatography for quantifying fatty acid composition of 44 summer milk samples collected from different geographical sites located at different altitudes (lowlands, mountains, and highlands). Milk from highland regions exhibited smaller level of saturated short- and medium-chain fatty acids, and more polyunsaturated fatty acids, than milk produced in the lowlands, in agreement with the findings of Bosset et al. [20] regarding research on cheeses, Cornu et al. [21] utilized DHS-GC–MS for discriminating two French cheeses: Saint-Nectaire and Cantal. The investigated cheeses were produced from raw and pasteurized milk. The authors reported that milk pasteurization did not induce significant changes in the terpenes profile of cheese, while significant difference was found between Cantal and Saint-Nectaire cheeses. One of the main conclusions of this study was that cheese-making procedure was the most important factor inducing changes in terpene profiles, possibly due to the physicochemical conditions applied, microbial population, and the duration of cheese maturation period, in agreement with the findings of Pillonel et al. [22] who succeeded to discriminate Emmental cheeses produced in Switzerland (90% of correct classification) from those made in France, Finland, Germany, and Australia).

### 17.2.4 Rheological Techniques

Commonly, fluid milk and cream are considered examples of liquids, and hard cheeses as an example of solid. But concentrated milk, yogurt, butter, ice cream, and several types of cheese could show an intermediate behavior as viscoelastic [23]. Texture properties of dairy products play a key role in consumer acceptance of cheese [4,5,24,25]. Thus rheological characterization of dairy products is important as a means of determining body and texture for quality and identity as a function of composition, processing techniques, and storage conditions.

The effect of temperature on the viscosity of milk was reported by Gryzowska and Tuszyński [26]. The authors pointed out that temperatures less than 50°C presented no effect on the viscosity of skim milk, while temperatures above 60°C induced an increase in the viscosity, even when

temperature was applied for a short time. The results obtained were confirmed after partially by Jeurink and DeKruif [27] who found that the viscosity of skim milk increased after heat treatments at temperature above 70°C. Quality attributes such as texture, consistency, firmness, curd tension, and flow properties of yogurt were measured with good satisfaction and allowed improvement of yogurt quality for consumer satisfaction. Because the network structure of yogurt plays an important role in the viscoelasticity, dynamic testing rheology is finding an excellent field of application in analyzing the viscoelastic nature of yogurt affected by process variables and measuring conditions [28–30].

Vlahopoulou and Bell [31] utilized dynamic tests to identify the viscoelastic differences between ropy and nonropy yogurts. The storage and loss moduli of the ropy gels were found to be lower than those corresponding to nonropy yogurts. Recently, Köksoy and Kiliç [32] investigated the effect of different levels of water and salt on the rheological properties and serum separation during storage of traditionally manufactured yogurts. The yoghurt samples were prepared by the addition of water at levels of 30 or 50 g/100 g and salt at levels of 0, 0.5, or 1 g/100 g and stored at 4°C. The results obtained showed that the consistency coefficient decreased and the flow behavior index increased dramatically with increasing levels of water and salt.

Regarding the texture of butter, Dixon and Parekh [33] examined different analytical techniques: penetration, cutting, extrusion, compression, and spreadability. Of these five instrumental methods, compression and extrusion were found to be the most used methods because of their high reproducibility, precision, and simplicity.

Recently, Raphaelides et al. [34] used dynamic testing rheology to monitor changes occurring in Halloumi cheeses throughout ripening, manufactured either from cows' milk or ewes' milk. Before the starting of ripening stage, bovine Halloumi was more rigid than the ovine Halloumi. In addition, the elasticity modulus of ovine Halloumi remains practically unchanged after an aging period of 15 days, while those produced from bovine Halloumi requires an aging period of 30 days to reach a constant elastic modulus value. After 30 days, the two Halloumi types presented the same values of storage modulus. The same technique was used to monitor changes that occurred in semi-hard and hard cheeses as a function of temperature [35]. The storage modulus ( $G'$ ), the loss modulus ( $G''$ ), and the complex viscosity ( $\eta^*$ ) decreased while strain and  $\tan(\delta)$  increased as the temperature increased from 5°C to 60°C. The same research group outlined that  $G'$  and  $G''$  increased, whereas  $\tan(\delta)$  and the strain decreased from the surface to the inner part of the three soft different cheeses [36].

### **17.2.5 Sensory Analysis**

Sensory analysis of food involves the measurement, interpretation, and understanding of human responses to the properties of food perceived by the senses such as sight, smell, taste, touch, and hearing [37,38]. Recently, the impact of different processing conditions on the sensory characteristics of milk was reported to have no significant effect [39]. Horimoto and Nakai [40] used sensory analysis to detect off-flavors of milk subjected to light-induced, cooked, and heated flavor milk. The authors have then applied PCA to the data sets and only slight differences were obtained. In another study, Quinones et al. [41,42] determined the effect of substitution of nonfat dry milk with a protein standardization by ultrafiltration and the results obtained reported that sensory texture and appearance descriptors were affected by both the protein standardization and the fat content. Regarding research on cheese, Lebecque et al. [43] studied the sensory attributes of 25 Salers PDO cheeses presenting 3.5 months ripening time. Eight attributes for texture profiling were

studied, and significant differences were obtained between the cheeses. Indeed, the 25 investigated cheeses were classified into five groups. Recently, Ritvanen et al. [44] studied 44 reduced and full fat cheese types (Edam, Emmental, and Havarti) and significant differences in flavor and texture of full fat and reduced fat cheeses were observed by the panel.

### **17.3 Spectroscopic Techniques Used for the Determination of the Quality and Authenticity of Dairy Products**

Although the importance of the above-mentioned techniques is unquestionable, these methods are hardly possible to implement for practical use when many samples need to be analyzed online or at-line in the food industry. For practical reasons, the quality criteria of such products should be easily measurable. Simple and rapid methods are needed for quality control and for screening many samples in a research or development situation.

Spectroscopic techniques such as NIR, FT-MIR, FFFS, NMR, and stable isotope are becoming increasingly attractive analytical techniques for measuring quality parameters in dairy products with decreasing instrument prices and improved equipment and chemometric tools. The main advantages of using spectroscopic techniques are rapid sample data acquisition, the possibility of simultaneous determination of several quality parameters and the ability to replace expensive and time-consuming reference techniques.

#### **17.3.1 Control of Coagulation, Syneresis, and Heat Treatment**

The first step in cheese manufacture is the transformation of milk into a gel, following the addition of an enzyme that induces destabilization of the casein micelles. When sufficient micelles are destabilized, they aggregate together, forming a gel network (coagulum); the time taken to form this network is called the gel time. Over time, the firmness of the coagulum continues to develop until it is sufficiently firm to cut. This is known as the cutting time. Several studies have stressed the importance of obtaining objective online measurements for monitoring gel time, coagulum firmness, and cutting time during cheese manufacture to obtain high quality and consistent cheese products [45]. Originally, the cheese-maker established the cutting time based on his expertise. Although this method is accurate, it is not feasible in closed commercial vats. Indeed, during milk coagulation, the time at which the gel is cut directly affects the quality of the resulting curd, and hence, the finished cheese. If the gel is too firm when cut, the result will be higher losses of curd and fat. An increase in cheese moisture will also occur if the gel is cut before the optimum time. This has resulted in the development of a number of online sensors that can be used to successfully monitor milk coagulation. O'Callaghana et al. [46] pointed out the usefulness of NIR as an online method for monitoring the coagulation of milk without causing damage to the formation of curd. McMahon et al. [47] and Payne et al. [48] used diffuse reflectance technique during milk coagulation by utilizing photodiode light sources at 940 and 950 nm. In both cases, cutting time was predicted using parameters derived from the NIR reflectance profiles recorded during coagulation. However, these studies only monitored coagulation at a single wavelength. Laporte et al. [49] continued this work and used full spectrum information and partial least squares (PLS) regression. Reflectance spectra were acquired during coagulation in the 1100 and 2500 nm. The obtained results were considered promising by the authors since the percentage of coagulation determined by NIR presented a standard error of prediction (SEP)

of 0.26%. Recently, Guillemain et al. [50] and Fagan et al. [51–53] examined the potential of NIR reflectance profiles for monitoring syneresis. Cutting of the coagulum initiates syneresis, which is the expulsion of whey from curd particles. Fagan et al. [51] proposed that a sensor-detecting NIR light backscatter in the 300–1100 nm in a cheese vat with a large field of view relative to curd particle size would have the potential to monitor both milk coagulation and curd syneresis. The authors pointed out that the response of the sensor was affected by temperature and that the sensor showed the potential tool for predicting whey fat content, curd moisture content, and curd yield. However, this preliminary study is only realized on a relatively small number of samples, and it would be interesting to validate the obtained results on a high number of samples. To respond to this request, Fagan et al. [52] continued this work and found that optical sensor could provide the information on gel assembly and curd shrinkage kinetics that were required for accurate predictions of whey fat losses and curd yield as well as for curd moisture control, in agreement with previous findings of Guillemain et al. [50] reporting that NIR could be considered as a potential technique for online determination of casein particle size distribution and of the volume fraction relative to the whey as a function of time.

In consideration with research that makes use of FFFS, Herbert et al. [54] used this technique to monitor milk coagulation at the molecular level. Three different coagulation processes were studied: the glucono- $\delta$ -lactone (GDL), rennet-induced coagulation system, and a mix system of GDL + rennet-induced coagulation. Emission fluorescence spectra of the protein tryptophanyl residues were recorded for each system during the milk coagulation kinetics. By applying the PCA to the normalized fluorescence spectral data corresponding to the three systems, detection of structural changes in casein micelles during coagulation and discrimination of different dynamics of the three coagulation systems was found. Herbert et al. [54] concluded that FFFS allowed the investigation of network structure and molecular interactions during milk coagulation.

Regarding the application of spectroscopic techniques for the evaluation of heat treatment, Dufour and Riaublanc [55] investigated the potential of FFFS to discriminate between raw, heated (70°C for 20 min), homogenized, and homogenized + heated milks. Different intrinsic probes were utilized (tryptophan and vitamin A). To extract information from the data sets, the authors applied, separately, PCA to the tryptophan and vitamin A fluorescence spectra, and a good discrimination between samples as a function of homogenization and heat treatment was found. One of the main conclusions of this study was that the treatments applied to milk-induced specific modifications in the shape of the fluorescence spectra, which were confirmed recently by Dufour and coworkers [56]. The authors used different intrinsic probes (aromatic amino acid and nucleic acid [AAA + NA], NADH, and FADH) for evaluating changes in milk samples following thermal treatments in the range of 57°C–72°C for 0.5 up to 30 min. The PCA applied on the normalized spectra allowed a good discrimination of milk samples subjected to different temperatures and times. Recently, the same research group used synchronous FFFS for the characterization at molecular level of milk changes during mild-heating from 4°C to 50°C and acidification in the 6.8–5.1 pH range. The spectra were acquired between 250 and 550 nm. By applying parallel factors (PARAFAC) analysis in the decomposition of the whole synchronous fluorescence data, contribution of each of the fluorescent compounds present in milk was pointed out for both heating and acidification [57]. However, the aforementioned researchers have only applied relatively low temperatures to milk samples, which did not allow monitoring the development of Maillard reaction browning, which was pointed out by Schamberger and Labuza [58]; the fluorescence spectra of milks which were processed for 5, 15, 20, 25, and 30 s in 5°C increments from 110°C to 140°C were found to be well correlated with hydroxymethylfurfural (HMF). One of the main conclusion of this study was that FFFS could be considered as a very promising method for measuring

Maillard browning in milk and could also be used as an online instrument for monitoring and control of thermal processing of milk, in agreement with the findings of Liu and Metzger [59] who have used FFS for monitoring changes in nonfat dry milk ( $n=9$ ), collected from three different manufacturers and stored at four different temperatures (4°C, 22°C, 35°C, and 50°C) during 8 weeks of storage; a good discrimination of milk samples according to the storage time was depicted. In a similar approach, Feinberg et al. [60] also utilized fluorescence spectroscopy to identify five types of heat treatments (pasteurization, high pasteurization, direct UHT, indirect UHT, and sterilization) of 200 commercial milk samples stored at 25°C and 35°C for 90 days. By applying factorial discriminant analysis (FDA), Feinberg et al. [60] found that tryptophan fluorescence spectra could be considered as well adapted to discriminate sterilized milks and probably pasteurized milk from the other milk samples. However, tryptophan spectra failed to discriminate the other types of milk. An explanation could arise from the fact that fluorescence spectra were recorded in the pH 4.6 soluble fraction of milk sample inducing a loss of information, and not on native samples.

### 17.3.2 Monitoring of Cheese Ripening

During the ripening step, cheese undergoes a series of chemical, bacterial, and enzymatic reactions that are responsible for breakdown of the protein matrix and ultimately the development of the texture and sensory characteristics that are typical of ripened cheese. Thus, determination of the degree of ripening of cheese is important since it could help the cheese-maker to better understand the biochemical kinetics of ripening and in consequence to improve the ripening process [61,62]. Considerable interest exists in the development of instrumental techniques to enable more objective, faster, and less expensive assessments to be made in this area [63]. Burns and Ciurczak [64] used NIR to study the ripeness age of different varieties of Dutch cheeses (Edam and Gouda), with the goal to classify them into different aging groups (young, young-matured, matured, and extramatured). The results obtained from their study were considered as promising since a correlation coefficient of 0.92 and a standard error of calibration (SEC) values of 28 days for samples of ripeness interval between 25 and 412 days were obtained. Testing specific calibrations models of subgroups of reduced samples with ripeness intervals of 160 days induced better results since a correlation coefficient and SEC of 0.96 and 11, respectively. Recently, the NIR-Fourier transform infrared (FT-NIR) was applied to the Italian fresh cheese Crescenza [65], and a successful discrimination between cheeses according to their storage times was obtained. Indeed, three well-separated groups corresponding to the fresh (0–6 days), aged (8–10 days), and old (storage time > 10 days) were observed. The authors concluded that FT-NIR could be a suitable technique for the evaluation of the shelf-life in which Crescenza freshness is maintained. However, no interpretation at the molecular level was provided in this study.

Regarding the potential of FT-MIR for monitoring the ripening stage of cheese samples [66–68], outlined a good discrimination of 16 experimental semi-hard cheeses as a function of their ripening times (e.g., 1, 21, 51, and 81 days) by using the 1700–1500  $\text{cm}^{-1}$  spectral region. Better results on the same research group were obtained following the use of FFS [66,67]. By applying PCA to the normalized tryptophan fluorescence spectra, a good discrimination of cheeses presenting a ripening time of 21, 51, and 81 days was observed. The authors have then studied the spectral patterns, which were used to derive structural information at the molecular level. By studying the spectral pattern, a redshift of tryptophan spectra of aged cheeses was observed, suggesting that the environment of old cheeses was more hydrophilic than the young cheeses

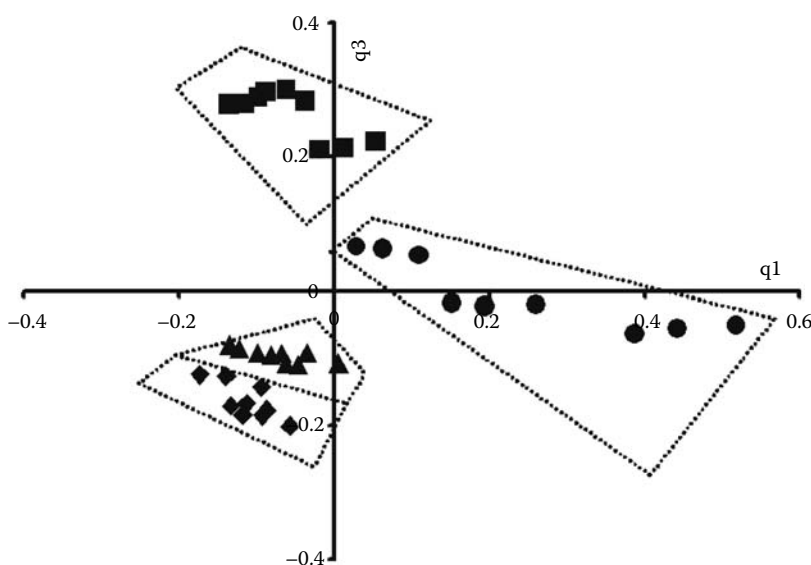
(1 day old). This phenomenon was explained by a partial proteolysis of casein as well as to the salting phenomenon, which could induce some changes in the tertiary and quaternary structures of casein micelles. Regarding fluorescence spectra of vitamin A, two shoulders located at 295 and 305 nm and a maximum located at 322 nm were observed [66]. In addition, the shape of the spectra changed with the ripening time. In order to determine the level of the link between FT-MIR and fluorescence spectra, canonical correlation analysis (CCA) was applied, on one hand, to the 1700–1500  $\text{cm}^{-1}$  spectral region and tryptophan fluorescence spectra and, on the other hand, to the 3000–2800  $\text{cm}^{-1}$  spectral region and vitamin A spectra [67]. A relatively high correlation was found since the first two canonical varieties with squared canonical correlation coefficient were higher than 0.58. The researchers concluded that FT-MIR and FFF spectra provided a common description of cheese samples throughout ripening. The obtained results were confirmed after on 24 semi-hard (Raclette) cheeses, produced during summer and autumn periods, analyzed at different ripening time (2, 30, and 60 days) using FFFS [68,69] and a good discrimination of cheeses according to their ripening time as well as a function of their production seasons was outlined by the authors. The researchers concluded that FFFS could be considered as a promising tool considering the significant effect of the season on the characterization of chesses.

In a similar approach, Martín-del-Campo et al. [61] used FT-MIR for monitoring the ripening stage of Camembert-type-cheese produced at a pilot scale. Cheese samples were analyzed at two different zones (core and under-rind) during the first 10 days of ripening as well as after 13, 15, 17, 20, and 27 days of ripening. From the results obtained, it was pointed out that the under-rind cheese samples presented some modifications in the spectra, while only a weak difference was observed between samples recorded on core spectra, throughout the ripening stage; these peaks were ascribed to some molecules, among them there are carbohydrate and organic acid associated bands located in the 1490–950  $\text{cm}^{-1}$  spectral region [70]. Regarding the region located between 1700 and 1500  $\text{cm}^{-1}$ , two characteristic bands of protein structures were observed: the *Amide I* located around at 1640  $\text{cm}^{-1}$  ( $\nu\text{C}=\text{O}$ ,  $\nu\text{C}-\text{N}$ ) and the *Amide II* observed at 1550  $\text{cm}^{-1}$  ( $\delta\text{N}-\text{H}$  and  $\nu\text{C}-\text{N}$ ), in agreement with previous findings [66].

The 3000–2800  $\text{cm}^{-1}$  spectral region, characteristic of fat, was characterized by methylene bands located around 2920 and 2851  $\text{cm}^{-1}$  and methyl peaks observed around 2954 and 2871  $\text{cm}^{-1}$ . The authors outlined that the intensity of these peaks did not change significantly in the core, while significant changes were observed for spectra recorded on the under-rind zone, confirming the findings of [66,71] on semi-hard cheeses and soft cheeses, respectively.

In another study, Karoui et al. [72] recorded tryptophan, vitamin A, and riboflavin spectra on 12 semi-hard cheeses (Raclette), belonging to four brand products, which were produced during summer period at an industrial level. By applying common component and specific weights analysis (CCSWA) to the spectral data sets and physicochemical data, a good discrimination of the four brand cheeses was observed (Figure 17.2).

In another approach, De Angelis Curtis et al. [73] monitored the ripening of Italian PDO cheeses (6, 12, and 18 months) using both low and high NMR. Using low NMR, an increase in the amount of free water and a decrease in the level of bound water and total water for the cheese samples cut at 2, 5, 8 cm from the base of the wheel as well as for those cut at 2, 8, and 14 cm from the rind side of the wheel was pointed out. This phenomenon was ascribed to the hydrolysis of protein during ripening. Lipolysis could also contribute to this phenomenon, but this was of secondary importance with respect to proteolysis. Indeed, the same research group pointed out an increase in the level of serine, alanine, phenylalanine, and methionine and a decrease in the amounts of glutamate, leucine, and valine during the ripening stage, which was attributed by the authors to the proteolysis and to metabolic processes during the ripening time.



**Figure 17.2** CCSWA similarity map defined by the common components 1 ( $q_1$ ) and 3 ( $q_3$ ) of A (◆), B (■), C (▲), and D (●) semi-hard cheeses at 60 days of ripening. CCSWA was performed on data tables obtained using riboflavin, tryptophan, and vitamin A fluorescence spectra and physicochemical data.

Kuo et al. [74] investigated changes in molecular mobility of water of Pasta Filata and non-Pasta Filata Mozzarella cheeses after 10 days of storage using NMR. The observed modifications were attributed to the changes in the physicochemical environments due to the structural rearrangements of protein matrix, contributing to the change of water mobility during aging. Moreover, some changes of both  $T_1$  and  $T_2$  were depicted during aging, and were attributed to the increase of hydration of proteins and to the change in the structure of protein matrix caused by proteolysis.

### 17.3.3 Measurements of Cheese Composition, Cheese Rheology, and Sensory Attributes

Cheeses are produced with a wide range of sensor, texture, and compositional parameters. The quality of any given type of cheese is mostly determined by its texture, which, in turn, is influenced by composition components and processing conditions. Manufacturers have traditionally depended on a wide range of physicochemical analyses to quantify major food components such as moisture, protein, and fat. Recently, Filho and Volery [75] used NIR to quantify total solid contents of fresh cheeses, having low, medium, and high solid contents, and a good discrimination of cheeses according to their solid contents was outlined. Indeed, all cheese samples located in the top cluster along the regression line belong to those, which had the highest solid contents, while those in the bottom cluster represent cheeses, which had the lowest solid contents. In a similar approach, Blaquez et al. [76] utilized NIR reflectance spectroscopy to predict moisture, fat, and inorganic salts in processed cheeses and accurate results were obtained. One of the main conclusions of this study was that NIR technique could be useful for off-line quality assessment of processed cheese.



Recently, the potential of NIR to predict maturity and sensory attributes of 24 Cheddar cheeses produced using five renneting enzymes and stored at 4°C for up to 9 months was assessed [63]. The NIR spectroscopy was found to have the ability to predict cheese maturity and several sensory attributes (crumbly, rubbery, chewy, etc.); with sufficient accuracy; the authors suggested the use of this technique for online purpose. In a similar approach, Blaquez et al. [77] used NIR reflectance spectroscopy in the range of 750–2498 nm to record spectra on cheeses which were stored for 2 and 4 weeks at 4°C. Nine sensory properties, five instrumental parameters, and cheese meltability were determined on cheese samples. The sensory attributes and instrumental texture measurements were found to be predicted with sufficient accuracy. The authors recommended the use of NIR reflectance spectroscopy for routine quality assessment of processed cheese, in agreement with the findings of McKenna [78] who have, however, used NIR transmission measurement on Edam, Gouda, Brie, Colby, and Cheddar and a range of SEP values varying from 0.12 to 0.35 were obtained using different methods of calibration for a number of types of cheese types.

Regarding the use of FT-MIR for the prediction of milk composition, Lynch and Barbano [79] outlined how well the calibration equations generated by using reconstituted “milk powders” could be used to predict the chemistry of raw milk samples. Regarding the prediction of fat content, the reconstituted powders were found not to provide an accurate fat calibration for testing raw milk samples. This phenomenon was ascribed by the authors to differences in the characteristics of the fat in the reconstituted powders and in raw milk. Considering protein content, comparable precisions for both types of calibration was depicted. Later, Sørensen et al. [80] assessed the potential FT-MIR for determining casein content in dairy cow’s milk. The researchers applied PLS regression to the spectra and the obtained results showed SEP of 0.033% and 0.89% for casein concentrations in the range of 2.1%–4% and 70.7%–81%, respectively. The main conclusion of this study was that FT-MIR was found to be less sensitive to heat denaturation of whey proteins than the reference method. Recently, Etzion et al. [81] succeeded to predict protein concentrations by using FT-MIR of 26 milk standards for which the amount of proteins ranged from 2.27 to 3.90 g/100 g. The obtained findings were confirmed after by Iñón et al. [82] who assessed the potential of FT-MIR to predict nutritional parameters of 83 commercially milk bottles covering the whole range of available brand names and types of milk in Spain. By applying the PLS regression, relative precision of 0.062 g/100 g, 0.04 g/100 g, 0.039 g/100 g, 0.66 kcal 100/mL, and 2.1 mg of ca. 100/mL, were obtained, respectively for total fat, total protein, total carbohydrates, calories, and calcium, respectively. One of the main conclusions of this study was that FT-MIR could be used as a suitable technique for the classification of milk samples.

Recently, Martín-del-Campo et al. [62] utilized FT-MIR to predict some chemical parameters in soft cheeses (pH, acid-soluble nitrogen, nonprotein nitrogen, ammonia (NH<sub>4</sub><sup>+</sup>), lactose, and lactic acid). By applying PLS regression, a good prediction of these parameters, except for that of pH was observed, in agreement with the findings of Karoui et al. [83] The authors concluded that, although the physicochemical parameters were determined at different ripening time, they were comparable to previous findings obtained on ripened cheeses. The authors [83] compared NIR and FT-MIR for predicting some chemical parameters of 91 Emmental cheeses produced during the winter time in Austria (*n* = 4), Finland (*n* = 6), Germany (*n* = 13), France (*n* = 30), and Switzerland (*n* = 38). The authors applied PLS regression with the leave-one-out cross-validation technique and the obtained results suggested the use of the NIR for the determination of fat and TN contents, and the FT-MIR for NaCl and NPN contents as well as for the pH. Similar results were obtained for WSN using the two techniques together. The authors have then combined spectra of both NIR and FT-MIR and concluded that no improvement of the results were obtained, since comparable

results to those obtained from either the NIR or MIR were observed. The results obtained using FT-MIR were partially confirmed on Emmental cheeses produced during the summer period since the authors suggested the use of FT-MIR for NPN and WSN. Indeed,  $R^2$  of 0.80 and 0.71 and ratio of standard deviation to root mean square error of prediction (RPD) of 2.22 and 1.85, were obtained for WSN and NPN, respectively. However, the NaCl, pH, and TN were found to could be estimated, but with much lower precision [84].

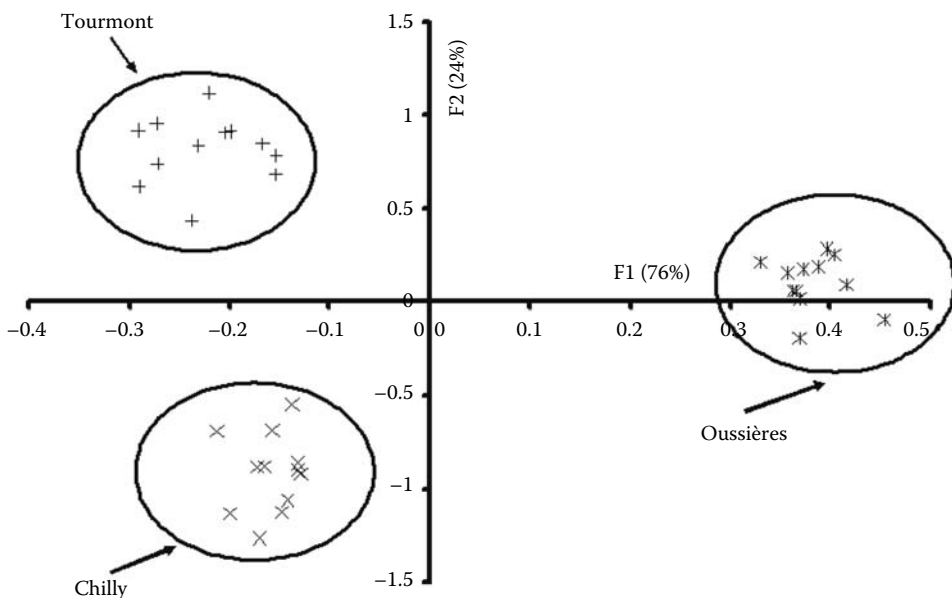
The results obtained on Emmental cheeses were then partially confirmed on soft cheeses cut at two sampling zones (surface and center) [85]. Indeed, fat, DM, TN, and WSN contents were found to be the best predicted with the VIS-NIR models providing the lowest values of the root mean square error of prediction (RMSEP) of 1.32, 0.70, 0.11, and 0.10, respectively. Again, the combination of the VIS-NIR and MIR spectral slightly improved the prediction of the pH only. The authors suggested the use of VIS-NIR for the determination of fat, DM, TN, and WSN. The pH was found to be predicted from the two techniques with approximate quantitative prediction, while a difference between low and high levels of WSN/TN ratio could be determined by the VIS-NIR, MIR, or joint use of VIS-NIR-MIR. Regarding research on soft cheeses, Karoui and coworkers [86] also assessed the potential of FFFS for predicting some chemical parameters in cheeses. Tryptophan (excitation, 290 nm; emission, 305–450 nm), riboflavin (excitation, 380 nm; emission, 400–640 nm), and vitamin A fluorescence spectra (emission, 410 nm; excitation, 270–350 nm) were recorded on the investigated cheeses [86]. The results showed that fat, DM, fat in DM, and WSN were the best predicted with the vitamin A fluorescence spectra models providing the highest values of the correlation coefficient ( $R^2$ ) was 0.88, 0.86, 0.86, and 0.84, respectively. The prediction of the pH was also successful using riboflavin fluorescence spectra ( $R^2 = 0.85$ ). The WSN/TN ratio can also be predicted from the three intrinsic probes, but with much lower precision. The obtained results confirmed previous findings reporting that FFFS could be used for the prediction of the rheological parameter and melting points of cheeses [87,88]. Indeed, excellent predictions were obtained from the tryptophan and vitamin A models for fat ( $R^2 = 0.99$  and 0.97, respectively), DM ( $R^2 = 0.94$  and 0.96, respectively), fat in DM ( $R^2 = 0.92$  and 0.99, respectively), TN ( $R^2 = 0.91$  and 0.91, respectively). Excellent predictions were also obtained for WSN ( $R^2 = 0.96$ ) and melting point ( $R^2 = 0.97$ ) from vitamin A spectra. The results for pH were good ( $R^2 = 0.82$ ) and approximate ( $R^2 = 0.76$ ) with tryptophan and vitamin A, respectively. The authors concluded that FFFS might be used for rapid online determination of the melting point and physicochemical parameters of cheeses.

### 17.3.4 Cheese Authenticity Determination

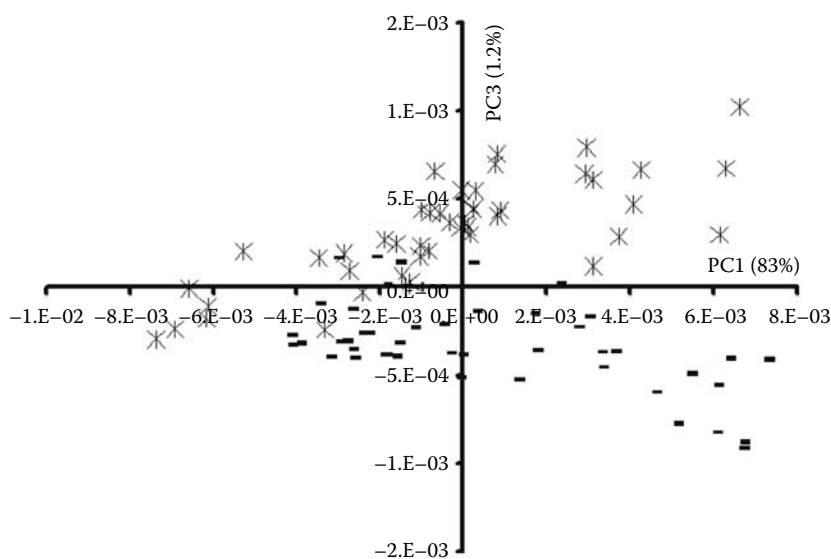
Cheese authenticity is an emerging research area that is becoming increasingly important to the dairy sector. The requirement for manufacturers and producers to be able to demonstrate food chain traceability, together with a rise in consumer awareness in food products, has focused renewed interest in food authenticity determination [89].

The potential of NIR diffuse reflection in combination with multivariate chemometric tools for discriminating Emmental cheeses of various geographic origins was investigated by Pillonel et al. [90] The authors applied linear discriminant analysis (LDA) to the PCA scores, and 100% correct classification was found. Although, the obtained results were interesting, they are realized on a small number of samples ( $n = 20$ ); thus the models were not very robust against the inclusion or exclusion of samples. Therefore, the obtained results should be regarded with precaution until validation on a large number of cheeses.

In this context, Karoui et al. [91,94] assessed the ability of NIR, FT-MIR, and FFFS for determining the geographic origin of European Emmental cheeses and Cheeses produced in Jura (France, Figure 17.3) [92–94]. Regarding cheeses produced during the winter period and investigated by NIR, a good classification of cheeses was achieved for 89% and 86.8% for the calibration and validation spectral data sets, respectively [94]. The FT-MIR results were comparable to those observed with NIR. Indeed, the 3000–2800  $\text{cm}^{-1}$  spectral region allowed 84.1% and 85.7% of correct classification for the calibration and validation data sets, respectively. The classification obtained with the tryptophan fluorescence spectra was considerably lower, since only 67.6% and 41.7% for classification and validation spectra was obtained. But tryptophan fluorescence spectra approved a good discrimination of Emmental cheeses made from raw milk and those produced from thermised milk, which were not obtained by the other two techniques (Figure 17.4). The authors concluded that NIR as well as FT-MIR could be used as fingerprint that allows the identification of Emmental cheeses according to their geographic origins and production conditions. However, in this study, only the tryptophan fluorescence spectra were acquired on the spectra and it would be interesting to compare the above-mentioned spectroscopic techniques with the vitamin A spectra, which were found to be the valuable tools for the evaluation of the quality and identity of cheeses [54]. Thus, a total of 74 Emmental cheeses, produced during the summer, originating from six countries, were analyzed by both FT-MIR and FFFS [93]. The best results were obtained with vitamin A fluorescence spectra since 93.9% and 90.5% of the calibration and validation spectra, respectively, were correctly classified. One of the main conclusions of this study was that vitamin A fluorescence spectra might be considered as a promising probe for the reliable evaluation of Emmental cheese origin.



**Figure 17.3** DA similarity map determined by discriminant factors 1 and 2 for mid-infrared spectra (1700–1500  $\text{cm}^{-1}$ ) of hard cheeses produced in three different regions in Jura (France).

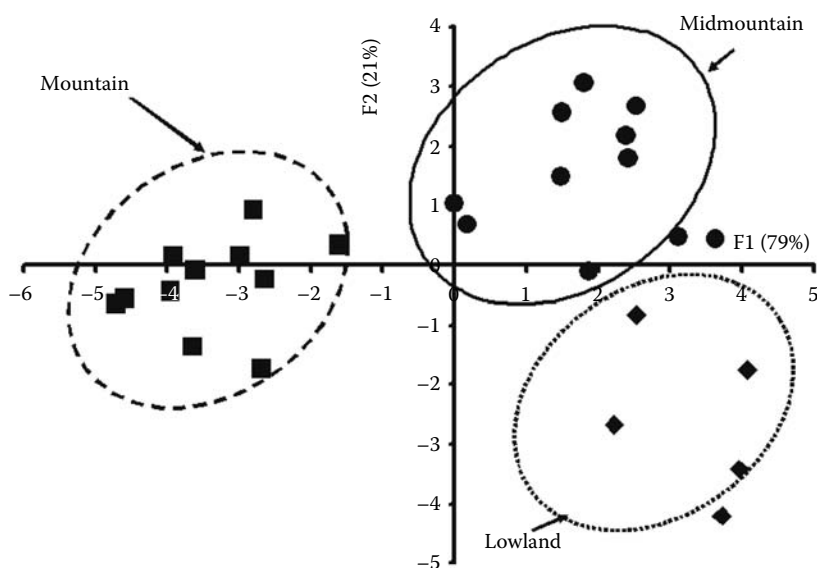


**Figure 17.4** PCA is similarity map determined by principal components 1 (PC1) and 2 (PC2) for the tryptophan spectra of French Emmental cheeses made from raw (\*) and thermised (-) milks.

In order to determine the geographic origin of Emmental cheeses independently of their manufacture periods, concatenation technique was applied [94]. A total of 163 Emmental cheeses produced in winter ( $n = 91$ ) and summer ( $n = 72$ ) periods were investigated by the MIR and FFFS. Correct classification of 89% and 76.7% was observed for the calibration and validation samples, respectively. The authors reported that although this statistical technique did not allow 100% correct classification for all the groups, the obtained results could be considered as promising given the significant effect of the season on the quality of investigated cheeses. These results were confirmed after by the same research group on milk samples originating from different geographical origin in France by using the same statistical technique (Figure 17.5) [95].

The same research group continued this work and assessed the feasibility of discriminating the manufacturing process and sampling zone of 10 traditional M1 ( $n = 5$ ) and M2 ( $n = 5$ ) soft cheeses produced from raw milk, and five other stabilized M3 ( $n = 5$ ) manufactured from pasteurized milk using the techniques mentioned earlier. References [96,97] provide an apt comparison of the three spectroscopic techniques used on the same cheese samples.

Regarding the FT-MIR spectra, the percentage of samples correctly classified into six groups (three for external and three for central zones) following FDA was 64.8% and 33.3%, respectively, for the calibration and validation sets [96]. Better classification was obtained from the VIS-NIR spectra where the corresponding results were 85.2% and 63.2%. However, the best results were obtained with vitamin A spectra since 91.8% and 80.6% of correct classification was obtained for the calibration and validation data sets, respectively in agreement with previous findings reporting that vitamin A was a good probe for discriminating eight varieties of soft cheeses since 96% and 93% for the calibration and validation samples, respectively [54]. The above-mentioned papers outlined that although many papers were published in the area of



**Figure 17.5** DA similarity maps determined by discriminant factors 1 and 2. FDA performed on the first 20 concatenated PC of the PCA performed on the fluorescence spectral data of the investigated: milks produced in lowland (◆), milks produced in mid-mountain (●), and milks produced in mountain (■) regions.

cheese authenticity using FT-MIR spectroscopic techniques, both NIR and FFS spectroscopies still more accurate tool in this area. The obtained results confirmed previous findings reporting the superiority of FFS to FT-MIR for determining the geographic origin of Gruyère cheeses produced at different altitudes by using different manufacturing processes [92,93]. Karoui et al. [93] overcame some of these difficulties of the MIR technique by concentrating on a particular wavelength range. In assessing the potential of FT-MIR for the determination of the geographical origin of Gruyère cheeses, the FT-MIR results were found to be comparable to the FFS results, giving corresponding correct classification of 90.5% and 90.9% within the 3000–2800  $\text{cm}^{-1}$  and 1500–900  $\text{cm}^{-1}$  spectral regions, respectively. As pointed out, the results obtained from FFS were still superior to those obtained from FT-MIR, but by concentrating on some wavelength range in FT-MIR, a closer comparison was achieved. A good example of how wavelength selections leads to favorable results was outlined by Picque et al. [98] who obtained a correct classification of 93% by using the reduced wavelength range of 1050–1800  $\text{cm}^{-1}$  in the FT-MIR region.

As illustrated earlier, most of the studies have utilized NIR, FT-MIR, and FFS for determining the geographic origin of dairy products. However, other spectroscopic techniques have also demonstrated their high potential for determining the identity of dairy products. Renou et al. [99] used O and H isotopic ratios to differentiate between milks produced in plains (altitude 200 m) from those produced in mountains (altitude 1100 m). Their studies showed that milk enrichments differed significantly between sites for both  $^{18}\text{O}$  and  $^2\text{H}$ . On the plains, the  $^{18}\text{O}$  enrichments were significantly higher for grazing cows than those fed on maize silage or hay. However, for the latter two diets, no significant differences were observed in  $\delta^{18}\text{O}$  or  $\delta^2\text{H}$ .

In another study, Manca et al. [100] applied PCA to the  $^{13}\text{C}/^{12}\text{C}$  and  $^{15}\text{N}/^{14}\text{N}$  of casein and a good discrimination was found according to the origin of cheeses. These findings were fully supported, recently, by Pillonel et al. [101] who attempted to discriminate European Emmental cheeses using different stable isotope ratios. Finnish and French cheeses were well separated using  $\delta^{13}\text{C}$ ,  $\delta^{15}\text{N}$ ,  $\delta^2\text{H}$ ,  $\delta^{87}\text{Sr}$ -values. However, cheeses from Switzerland, Allgäu, and Vorarlberg were found to be similar. The obtained results confirmed previous findings of the same research group Rossmann et al. [102] outlining that stable isotope analysis succeeded to determine the geographic origin of butter originating from different geographic origins. The authors concluded that this technique could be a very potent tool with which to solve the problem of butter origin assignment.

However, the stable isotope approach also has some important constraints. Results obtained from stable isotope must be based on uniform environment features (e.g., climate, altitude, and distance from oceans) allowing few or no differences in isotopic ratios of the dairy products. Therefore, dairy products from animals originating from different, but climatically or geologically similar areas might have an identical isotopic signature. In addition, Ritz et al. [103] demonstrated that the breed of cows could influence the isotopic enrichment of milk, even in circumstances where the food and water consumed are similar.

The accuracy of  $^{13}\text{C}$  NMR to differentiate cows' milk from buffaloes' milk was outlined by Andreotti et al. [104]. In their study, although a relatively low number of milk samples was studied, a good discrimination between the investigated milks was achieved following the application of PCA to the 10 NMR parameters.

## 17.4 Conclusion

The quality control measurements of dairy products could be determined by several analytical techniques as presented in this chapter. However, spectroscopic techniques were demonstrated to be more rapid than traditional techniques, which needs skilled operators. FFFS, FT-MIR, and NIR, among other spectroscopies were demonstrated to be more suited to industrial applications than the traditional techniques. The potential of these technologies for compositional, ripening stage, rheological, and process monitoring applications at laboratory scale is also well documented. However, to date, there is no feasible ideal method for all purposes. An accurate determination of the quality and/or identity of dairy product seems feasible only when a combination of all parameters is applied. Indeed, the results illustrated in this chapter showed that the methodology of coupling different spectroscopic techniques by using appropriate chemometric tools enabled better discrimination of dairy products according to their geographical origin and ripening time. These techniques provide fingerprints of dairy products, which by comparison with authentic samples can be used to detect certain fraudulent practices and to authenticate the geographical origin. They can also provide an efficient means of enforcing the restricted rules associated with PDO-labeled products.

The equipment manufacturers are likely to put renewed emphasis on developing online instrumentation to facilitate improved process monitoring of cheese quality during manufacture. Thus, ready transfer of these techniques especially NIR and FFFS to the dairy plants as either on- or in-line methods is already possible. This transfer should increase the understanding of manufacturers of constituents that determine food texture and may allow them devising a structure engineering of cheese.

## References

1. Downey, G. Authentication of food and food ingredients by near infrared spectroscopy, *J. Near Infrared Spectrosc.*, 4, 47, 1996.
2. Karoui, R. and De Baerdemaeker, J. A review of the analytical methods coupled with chemometric tools for the determination of the geographical origin of dairy products. *Food Chem.*, 102, 641, 2007.
3. Guinot-Thomas, P., Al Ammoury, M., and Laurent, L. Effects of storage conditions on the composition of raw milk. *Int. Dairy J.*, 5, 211, 1995.
4. Bugaud, C. et al. Influence of the nature of alpine pastures on plasmin activity, fatty acid and volatile compound composition of milk. *Lait*, 81, 401, 2001.
5. Bugaud, C. et al. Relationships between Abondance cheese texture and that of milk produced by cows grazing different types of pastures. *Lait*, 81, 593, 2001.
6. Pillonel, L. et al. Geographic origin of European Emmental. Use of discriminant analysis and artificial neural network for classification purposes. *Int. Dairy J.*, 15, 557, 2005.
7. Millán, R. et al. Application of discriminant analysis to physico-chemical variables for characterizing Spanish cheeses. *Food Chem.*, 55, 189, 1996.
8. Maâmoury, O. et al. Mid infrared attenuated total reflection spectroscopy as a rapid tool to assess the quality of Sicilo-Sarde ewe's milk during the lactation period after replacing soybean meal with scotch bean in the feed ration. *Food Chem.*, 106, 361, 2008.
9. Zaïdi, F. et al. Front face fluorescence spectroscopy as a rapid and non-destructive tool for differentiating between Sicilo-Sarde and Comisana ewe's milk during lactation period: A preliminary study. *Food Bioprocess Technol.*, 1, 143, 2008.
10. O'Shea, B.A., Uniacke-Lowe, T., and Fox, P.F. Objective assessment of Cheddar cheese quality. *Int. Dairy J.*, 6, 1135, 1996.
11. Pripp, A.H. et al. Comparison of the biochemical characteristics of three Norwegian cheese varieties using multivariate statistical analysis. *Milchwissenschaft*, 54, 558, 1999.
12. Pripp, A.H. et al. Multivariate statistical analysis of peptide profiles and free amino acids to evaluate effects of single-strain starters on proteolysis in miniature Cheddar-type cheeses. *Int. Dairy J.*, 9, 473, 1999.
13. Ferreira, I.M.P.L.V.O. and Caçote, H. Detection and quantification of bovine, ovine and caprine milk percentages in protected denomination of origin cheeses by reversed-phase high-performance liquid chromatography of beta-lactoglobulins. *J. Chromatogr.*, 1015, 111, 2003.
14. Bara-Herczegh, O., Horváth-Almássy, K., and Őrsi, F. Application of multivariate methods to identify the indices of secondary proteolysis for Trappist cheese maturity and quality. *Eur. Food Res. Technol.*, 214, 516, 2002.
15. Frau, M. et al. Evolution of free amino acid content during ripening of Mahon cheese. *Food Chem.*, 60, 651, 1997.
16. Salles, C. et al. Evaluation of taste compounds in water-soluble extract of goat cheeses. *Food Chem.*, 68, 429, 2000.
17. Viallon, C. et al. Transfer of monoterpenes and sesquiterpenes from forages into milk fat. *Lait*, 80, 635, 2000.
18. Fernandez, C. et al. Characterization of milk by analysis of its terpene fractions. *Int. J. Food Sci. Technol.* 38, 445, 2003.
19. Collomb, M. et al. Composition of fatty acids in cow's milk fat produced in the lowlands, mountains and highlands of Switzerland using high-resolution gas chromatography. *Int. Dairy J.*, 12, 649, 2002.
20. Bosset, J.O. et al. Comparison of some highland and lowland Gruyère type cheese of Switzerland: A study of their potential PDO/AOC/AOP characteristics. Authenticity and adulteration of food—The analytical approach. *Proc. Eur. Food Chem.*, 220, 395, 1997.

21. Cornu, A. et al. Terpene profiles in Cantal and Saint-Nectaire-type cheese made from raw or pasteurised milk. *J. Sci. Food Agric.*, 85, 2040, 2005.
22. Pillonel, L. et al. Analytical methods for the determination of the geographic origin of Emmental cheese: Volatile compounds by GC/MS-FID and electronic nose. *Eur. Food Res. Technol.*, 216, 179, 2003.
23. Shoemaker, Ch.F. et al. Rheological characterization of dairy products. *Food Technol.*, January, 98, 1992.
24. Ak, M.M. and Gunasekaran, S. Stress-strain curve analysis of Cheddar cheese under uniaxial compression. *J. Food Sci.*, 57, 1078, 1992.
25. Jaros, D. et al. Effect of water addition on composition and fracture properties of Emmental cheese. *Lait*, 77, 467, 1997.
26. Gryzowska, A. and Tuszynsky, W. Measurement of relative milk viscosity as criterion of analysis of its physical structure. *Technol. Żywnosci*, 1, 25, 1973.
27. Jeurink, T.J.M. and DeKruif, K.G. Changes in milk on heating: Viscosity measurements. *J. Dairy Res.*, 60, 139, 1993.
28. Biliaderis, C.G., Khan, M.M., and Blank, G. Rheological and sensory properties of yogurt from skim milk and ultrafiltered retentates. *Int. Dairy J.*, 5, 311, 1992.
29. Rhom, H. and Kovac, A. Effects of starter cultures on linear viscoelastic and physical properties of yogurt gels. *J. Text. Stud.*, 25, 311, 1994.
30. Rönnegård, E. and Dejmeq, P. Development and breakdown in yoghurt studied by oscillatory rheological measurements. *Lait*, 73, 371, 1993.
31. Vlahopoulou, I. and Bell, A.E. The application of oscillatory testing to bovine and caprine yoghurt gel systems. In *Rheology of Food, Pharmaceutical and Biological Materials with General Rheology*, Carter, R.E. Ed., Elsevier, London, pp. 331, 1990.
32. Köksoy, A. and Kiliç, M. Effects of water and salt level on rheological properties of ayran, a Turkish yoghurt drink. *Int. Dairy J.*, 13, 835, 2003.
33. Dixon, B.D. and Parekh, J.V. Use of the cone penetrometer for testing the firmness of butter. *J. Text. Stud.*, 10, 421, 1979.
34. Raphaelides, S.N., et al. Ripening effects on the rheological behaviour of Halloumi cheese. *J. Food Eng.* 76, 321, 2005.
35. Karoui, R., Laguet, A., and Dufour, E. Interest of fluorescence spectroscopy for the investigation of cheese melting—Correlation with rheology characteristics. *Lait*, 83, 251–264.
36. Karoui, R. and Dufour, E. Dynamic testing rheology and fluorescence spectroscopy investigations of surface to centre differences in ripened soft cheeses. *Int. Dairy J.*, 13, 973, 2003.
37. Martens, M. A philosophy for sensory science. *Food Qual. Pref.*, 10, 233, 1999.
38. Martens, M. and Martens, H. *Multivariate Analysis of Quality*. John Wiley and Sons, Chichester, U.K., 2001.
39. Wormbs, G. et al. The use of design of experiment and sensory analysis as tools for the evaluation of production methods for milk. *Chem. Intell. Lab. Syst.*, 73, 67, 2004.
40. Horimoto, Y. and Nakai, S. Classification of pasteurized milk using principal component similarity analysis of off-flavours. *Food Res. Int.*, 31, 279, 1998.
41. Quinones, H.J., Barbano, D.M., and Phillips, L.G. Influence of protein standardization by ultrafiltration on the viscosity, color, and sensory properties of 2% and 3.3% milks. *J. Dairy Sci.*, 81, 884, 1998.
42. Quinones, H.J., Barbano, D.M., and Phillips, L.G. Influence of protein standardization by ultrafiltration on the viscosity, color, and sensory properties of skim and 1% milk. *J. Dairy Sci.*, 80, 3142, 1997.
43. Lebecque, A. et al. Delineation of the texture of Salers cheese by sensory analysis and physical methods. *Lait*, 81, 609–623.
44. Ritvanen, T. et al. Sensory evaluation, chemical composition and consumer acceptance of full fat and reduced fat cheeses in the Finnish market. *Food Qual. Pref.*, 16, 479, 2005.



45. Payne, F.A., Hicks, C.L., and Sheng, P. Predicting optimal cutting time of coagulating milk using diffuse reflectance. *J. Dairy Sci.*, 76, 48, 1993.
46. O'Callaghana, D.J., O'Donnellb, C.P., and Payne, F.A. On-line sensing techniques for coagulum setting in renneted milks. *J. Food Eng.*, 43, 155, 2000.
47. McMahon, D.J., Brown, R.J., and Ernstrom, C.A. Enzymic coagulation of milk casein micelles. *J. Dairy Sci.*, 67, 745, 1984.
48. Payne, F.A. et al. Fibre optic sensor for predicting the cutting time of coagulating milk for cheese production. *Trans. ASAE*, 36, 841, 1993.
49. Laporte, M.F., Martel, R., and Paquin, P. The near-infrared optic probe for monitoring rennet coagulation in cow's milk. *Int. Dairy J.*, 8, 659, 1998.
50. Guillemin, H. et al. An optical method to monitor casein particle size distribution in whey. *Lait*, 86, 359, 2006.
51. Fagan, C.C. et al. Development of a light scatter sensor technology for on-line monitoring of milk coagulation and whey separation. *J. Food Eng.*, 83, 61, 2007.
52. Fagan, C.C. et al. On-line prediction of cheese making indices using backscatter of near infrared light. *Int. Dairy J.*, 18, 120, 2008.
53. Fagan, C.C. et al. Novel on-line sensor technology for continuous monitoring of milk coagulation and whey separation in cheese making. *J. Agric. Food Chem.*, 55, 8836, 2007.
54. Herbert, S. et al. Fluorescence spectroscopy investigations of acid- and rennet-induced milk coagulation of milk. *J. Dairy Sci.*, 82, 2056, 1999.
55. Dufour, E. and Riaublanc, A. Potentiality of spectroscopic methods for the characterisation of dairy products. I. Front-face fluorescence study of raw, heated and homogenised milks. *Lait*, 77, 657, 1997.
56. Kulmyrzaev, A., Levieux, D., and Dufour, E. Front-face fluorescence spectroscopy allows the characterization of mild heat treatment applied to milk. Relations with the denaturation of milk proteins. *J. Agric. Food Chem.*, 53, 502, 2005.
57. Boubellouta, T. and Dufour E. Mild-heating and acidification effects on the molecular structure of milk components as investigated by synchronous front-face fluorescence spectroscopy coupled with parallel factors (PARAFAC) analysis. *Appl. Spectrosc.*, 62, 490, 2008.
58. Schamberger, G.P. and Labuza, T.P. Evaluation of front-face fluorescence for assessing thermal processing of milk. *J. Food Sci.*, 71, 69, 2006.
59. Liu, X. and Metzger, L.E. Application of fluorescence spectroscopy for monitoring changes in nonfat dry milk during storage. *J. Dairy Sci.*, 90, 24, 2007.
60. Feinberg, M. et al. Evaluation of tracers for the authentication of thermal treatments of milks. *Food Chem.*, 98, 188, 2006.
61. Martín-del-Campo, S.T. et al. Middle infrared spectroscopy characterization of ripening stages of camembert-type cheese. *Int. Dairy J.*, 17, 835, 2007.
62. Martín-del-Campo, S.T. et al. Evaluation of chemical parameters in soft mold-ripened cheese during ripening by mid-infrared spectroscopy. *J. Dairy Sci.*, 90, 3018, 2007.
63. Downey, G. et al. Prediction of maturity and sensory attributes of Cheddar cheese using near-infrared spectroscopy. *Int. Dairy J.*, 15, 701, 2005.
64. Burns, D.A. and Ciurczak, E.W. *Handbook of Near Infrared Analysis*. Dekker, New York, 1992.
65. Cattaneo, T.M.P. et al. Application of FT-NIR and FT-IR spectroscopy to study the shelf-life of Crescenza cheese. *Int. Dairy J.*, 15, 693, 2005.
66. Dufour, E. et al. Phase transition of triglycerides during semi-hard cheese ripening. *Int. Dairy J.*, 10, 81, 2000.
67. Mazerolles, G. et al. Infrared and fluorescence spectroscopy for monitoring protein structure and interaction changes during cheese ripening. *Lait*, 81, 509, 2001.
68. Mazerolles, G. et al. Chemometric methods for the coupling of spectroscopic techniques and for the extraction of the relevant information contained in the spectral data tables. *Chem. Intell. Lab. Syst.*, 63, 57, 2002.

69. Karoui, R., Dufour, E., and De Baerdemaeker, J. Monitoring the molecular changes by front face fluorescence spectroscopy throughout ripening of a semi-hard cheese. *Food Chem.* 104, 409, 2007.
70. Picque, D., Lefier, D., and Grappin, R. Monitoring of fermentation by infrared spectrometry: Alcoholic and lactic fermentation. *Anal. Chim. Acta*, 279, 67, 1993.
71. Kulmyrzaev, A. et al. Investigation at the molecular level of soft cheese quality and ripening by infrared and fluorescence spectroscopies and chemometrics—Relationships with rheology properties. *Int. Dairy J.*, 15, 669, 2005.
72. Karoui, R., Dufour, E., and De Baerdemaeker, J. Common components and specific weights analysis: A tool for monitoring the molecular structure of semi-hard cheese throughout ripening. *Anal. Chim. Acta*, 572, 125, 2006.
73. De Angelis Curtis, S. et al. Amino acid profile in the ripening of Grana Padano cheese: A NMR study. *Food Chem.*, 71, 495, 2000.
74. Kuo, M.I. et al. Nuclear Magnetic Resonance study of water mobility in Pasta Filata ad non-Pasta Filata Mozzarella. *J. Dairy Sci.*, 84, 1950, 2006.
75. Filho, P.A.D.A. and Volery, P. Broad-based versus specific NIRS calibration: Determination of total solids in fresh cheeses. *Anal. Chim. Acta*, 544, 82, 2005.
76. Blaquez, C. et al. Prediction of moisture, fat and inorganic salts in processed cheese by near infrared reflectance spectroscopy and multivariate data analysis. *J. Near Infrared Spectrosc.*, 12, 149, 2004.
77. Blaquez, C. et al. Modelling of sensory and instrumental texture parameters in processed cheese by near infrared reflectance spectroscopy. *J. Dairy Res.*, 73, 58, 2006.
78. McKenna, D. Measuring moisture in cheese by near infrared absorption spectroscopy. *J. AOAC Int.*, 84, 623, 2001.
79. Lynch, J.M. and Barbano, D.M. Evaluation of commercially available milk powder for calibration of mid-infrared analyzers. *J. AOAC Int.*, 78, 1219, 1995.
80. Sørensen, L.K., Lund, M., and Juul, B. Accuracy of Fourier transform infrared spectrometry in determination of casein in dairy cow's milk. *J. Dairy Res.*, 70, 445, 2003.
81. Etzion, Y. et al. Determination of protein concentration in raw milk by mid-infrared Fourier transform infrared/attenuated total reflectance spectroscopy. *J. Dairy Sci.*, 87, 2779, 2004.
82. Iñón, F.A., Garrigues, J.M., and de la Guardia, M. Nutritional parameters of commercially available milk samples by FTIR and chemometric techniques. *Anal. Chim. Acta*, 513, 401, 2003.
83. Karoui, R. et al. A comparison and joint use of two spectroscopic methods for the determination of some parameters in European Emmental cheeses. *Eur. Food Res. Technol.*, 223, 44, 2006.
84. Karoui, R. et al. Mid infrared spectrometry: A tool for the determination of chemical parameters of Emmental cheeses produced during winter. *Lait*, 86, 83, 2006.
85. Karoui, R. et al. A comparison and joint use of NIR and MIR spectroscopic methods for the determination of some chemical parameters in soft cheeses at external and central zones. *Eur. Food Res. Technol.*, 223, 363, 2006.
86. Karoui, R. et al. Utilisation of front face fluorescence spectroscopy for the determination of some chemical parameters in soft cheeses at external and central zones. *Lait*, 86, 155, 2006.
87. Karoui, R. and Dufour, E. Prediction of the rheology parameters of ripened semi-hard cheeses using fluorescence spectra in the UV and visible ranges recorded at a young stage. *Int. Dairy J.*, 16, 1490, 2006.
88. Karoui R., De Baerdemaeker, J., and Dufour, E. Utilisation of front face fluorescence spectroscopy as a tool for the prediction of some chemical parameters and the melting point of semi-hard and hard cheeses: A preliminary study. *Eur. Food Res. Technol.*, 226, 1119, 2008.
89. Woodcock, T. et al. Application of near and mid-infrared spectroscopy to determine cheese quality and authenticity. *Food Process Technol.*, 1, 117, 2008.
90. Pillonel, L. et al. Analytical methods for the determination of the geographic origin of Emmental cheese. Mid and near-infrared spectroscopy. *Eur. Food Res. Technol.*, 216, 174, 2003.
91. Karoui, R. et al. Determination of the geographic origin of Emmental cheeses by combining infrared and fluorescence spectroscopies. *Int. Dairy J.*, 15, 287, 2005.

92. Karoui, R. et al. Monitoring the geographic origin of both experimental French Jura hard cheeses and Swiss Gruyère and l'etivaz PDO cheeses using mid-infrared and fluorescence spectroscopies. *Int. Dairy J.*, 15, 275, 2005.
93. Karoui, R. et al. Fluorescence and infrared spectroscopies: A tool for the determination of the geographic origin of Emmental cheeses manufactured during summer. *Lait*, 84, 359, 2004.
94. Karoui, R. et al. Determining the geographic origin of Emmental cheeses produced during winter and summer using a technique based on the concatenation of MIR and fluorescence spectroscopic data. *Eur. Food Res. Technol.*, 219, 184, 2004.
95. Karoui, R., Martin, B., and Dufour, E. Potentiality of front-face fluorescence spectroscopy to determine the geographic origin of milks from Haute-Loire department (France). *Lait*, 85, 223, 2005.
96. Karoui, R. et al. Feasibility study of discriminating the manufacturing process and sampling zone in ripened soft cheeses using attenuated total reflectance MIR and fiber optic diffuse reflectance VIS-NIR spectroscopy. *Food Res. Int.* 39, 588, 2006.
97. Karoui, R., De Baerdemaeker, J., and Dufour, E. A comparison and joint use of mid infrared and fluorescence spectroscopic methods for differentiating between manufacturing process and sampling zones of ripened soft cheeses. *Eur. Food Res. Technol.*, 226, 861, 2008.
98. Picque, D. et al. Discrimination of European Emmental cheese by midinfrared spectroscopy. *Proceedings of IDF Symposium on Cheese: Ripening, Characterisation and Technology*, Prague, Czech Republic, 21–25 March 2004.
99. Renou, J.P. et al. Characterization of animal products according to geographic origin and feeding diet using nuclear magnetic resonance and isotope ratio mass spectrometry: Cow milk. *Food Chem.*, 85, 63, 2004.
100. Manca, G. et al. Characterization of the geographical origin of Pecorino Sardo cheese by casein stable isotope ( $^{13}\text{C}/^{12}\text{C}$  and  $^{15}\text{N}/^{14}\text{N}$ ) ratios and free amino acid ratios. *J. Agric. Food Chem.*, 49, 1404, 2001.
101. Pillonel, L. et al. Stable isotope ratios, major, trace and radioactive elements in Emmental cheeses of different origins. *Lebensm-Wissenschaft und-Technologie*, 36, 615, 2003.
102. Rossmann, A. et al. The potential of multielement stable isotope analysis for regional origin assignment of butter. *Eur. Food Res. Technol.*, 211, 32, 2000.
103. Ritz, P. et al. Milk characterization: Effect of the breed. *Food Chem.*, 91, 521, 2005.
104. Andreotti, G. et al. Milk identification of different species:  $^{13}\text{C}$ -NMR Spectroscopy of triacylglycerols from cows and buffaloes' milks. *J. Dairy Sci.*, 83, 2432, 2000.

## Chapter 18

---

# Determination of Glycolysis

---

Gaspar Pérez-Martínez

### CONTENTS

18.1	Introduction.....	386
18.2	Metabolic Pathways .....	387
18.2.1	Sugar Transport.....	387
18.2.1.1	Lactose Transport.....	387
18.2.1.2	Hexose Transport.....	387
18.2.2	Metabolism: Metabolites Produced .....	388
18.2.2.1	Glycolysis (Homofermentative Pathway).....	388
18.2.2.2	Pentose Phosphate Pathway (Heterofermentative Pathway)...	389
18.2.2.3	Fructose-6P Shuttle (Bifidus Pathway).....	389
18.2.2.4	Galactose Catabolism: Leloir and Tagatose-6P Pathways.....	390
18.2.2.5	Alternative Pathways from Pyruvate (Mix Acid Fermentation) .....	391
18.2.2.6	Propionate Production by Propionibacterium .....	393
18.3	Methods.....	394
18.3.1	General Methods .....	394
18.3.1.1	Sample Preparation.....	395
18.3.1.2	Enzymatic Methods .....	395
18.3.1.3	Chromatographic Methods .....	395
18.3.1.4	Spectroscopic Techniques .....	396
18.3.2	Detection of Glycolysis Metabolites.....	396
18.3.2.1	Lactose .....	396
18.3.2.2	Glucose .....	397
18.3.2.3	Galactose .....	398

18.3.2.4	Lactate .....	398
18.3.2.5	Acetate, Propionate, and Butyrate .....	398
18.3.2.6	Diacetyl, Acetoin, and Acetolactate.....	399
18.3.2.7	Ethanol .....	399
18.4	Conclusions.....	400
	References.....	400

## 18.1 Introduction

Although fresh milk contains active enzymes, effective glycolysis in dairy products is necessarily associated with microbial metabolism. In fact, a vast amount of commercial dairy products have undergone a fermentative process carried out by lactic acid bacteria (LAB), and in Swiss like cheeses, propionibacteria. This fermentation has been used by humans throughout history to preserve a precious and perishable food like milk. In this process, lactose is transformed to lactic acid and, as consequence, pH falls below 5.0 inhibiting growth of spoilage and pathogenic bacteria. However, production of lactic acid is accompanied by the production of a number of flavor rich compounds responsible for the characteristic organoleptic properties of fermented dairy products, such as acetate, propionic acid, acetaldehyde, or diacetyl.

Dairy products obtained from raw milk, where indigenous bacteria are preserved, are restricted to small facilities where production conditions should be strictly controlled due to the high risk of pathogen contamination and to a great variability between batches. Large industrial facilities normally use pasteurized or UHT-treated milk that is subsequently inoculated with very well characterized bacterial cultures (starter cultures). Therefore, fermentation control becomes necessary in both cases but for different reasons. When using raw milk, determination of fermentation metabolites helps to anticipate variability between batches and the growth of undesired contaminants. In the case of factories using pasteurized or UHT milk, fermentation control will determine product quality and the efficiency of the starter culture allowing standardization of processes like starter culture's rotation.

The analytical procedures reviewed in this chapter will be described following the order in carbohydrate catabolism pathways (glycolytic flux), starting from lactose and finishing with D,L-lactate. Determination of lactose has a great relevance as it is a fundamental element in milk (45–50 g/L) and its actual role in milk could be related to its very high hygroscopic power during secretion by the mammary glands, as knockout mice unable to produce lactose in milk are unable to rear their offspring [1]. This carbohydrate constitutes a remarkable source of energy for the consumer, however, lactose intolerance in human adults and environmental problems caused by the high lactose content in milk whey have prompted investigations to reduce lactose content on milk and dairy products.

The relevance of D, L-lactate in dairy processes has been pinpointed above, as it has bacteriostatic properties and also confers the particular acidic taste to fermented milks. However, other important acids are produced by fermentative bacteria during the manufacture of dairy products and in particular those produced from lactic acid by *Propionibacterium* in cheeses, like acetic and propionic acid (bacteriostatic and fungistatic, respectively).

However, diacetyl is the principal aroma compound in butter and fresh cheeses. It is a very volatile compound and has a very high organoleptic power, that is, very small molar amounts can be sensed by the human pituitary. These features together with its very pleasant flavor makes it one of the most valuable additives in food industry.

Unless the particular fermentation process requires their production (for example, kefir), the presence of ethanol and acetate in dairy products is generally related to spoilage bacteria or yeasts. Therefore, early detection of these compounds could be an indication of a foul process.

Following this introduction, the metabolic pathways leading to the glycolytic compounds relevant to dairy fermentations by LAB and propionibacteria will be described in a summarized form, detailed description of each enzymatic step can be found elsewhere [2]. Then, an overview of the methods used for the detection and quantification of these metabolites in dairy products is offered followed by the particular conditions used for each compound or group of compounds. Certainly, not all the methods are represented, just those that are widely used or validated have been represented.

## 18.2 Metabolic Pathways

### 18.2.1 Sugar Transport

#### 18.2.1.1 Lactose Transport

An efficient utilization of lactose is essential for LAB used in dairy fermentations. This sugar can be transported by lactose-specific phosphoenol pyruvate:sugar phosphotransferase systems (PTS<sup>Lac</sup>), proton symport and lactose–galactose antiport systems [3,4]. Frequently, LAB carry the genes for lactose utilization in plasmids, in fact the first lactose deficient variants isolated from *Lactococcus lactis* were spontaneous plasmid-cured strains [5,6].

The lactose-specific PTS<sup>Lac</sup> from various LAB has been thoroughly described in this chapter. The PTS<sup>Lac</sup> activity generates lactose-6-phosphate, which is then hydrolyzed by the phospho-β-galactosidase yielding galactose-6-phosphate and glucose. These sugars will be respectively metabolized by the tagatose-6-phosphate and the glycolysis pathways (see below). There is a remarkable case of efficient lactose assimilation, the yogurt bacteria *Streptococcus thermophilus*. In this species, lactose is transported via a symporter-type transport system (LacS) [7] that is hydrolyzed by the enzyme β-galactosidase into glucose and galactose. However, possibly due to the great abundance of lactose, in most strains of this species galactose is pumped out of the bacterial cell by the same permease, which can act either as lactose-proton symporter or as lactose/galactose exchanger (antiporter) [8,9].

#### 18.2.1.2 Hexose Transport

Monosaccharides and specially hexoses are not natural constituents of milk, however, they can be used as ingredients, often as part of maltodextrins and syrups. As mentioned, glucose and fructose are most efficiently assimilated by most microorganisms. LAB contain different transport systems for these carbohydrates: mannose/glucose-specific PTS (II<sup>Man</sup>) [10–12], a glucose proton motive force permease [13] and various fructose specific PTS [14].

The proliferation of lactose free products—where lactose has been hydrolyzed to glucose and galactose—are normally containing free galactose. LAB present in dairy products can generally utilize galactose as a carbon source. It is transported by proton motive force permeases and by PTS that yield respectively galactose and galactose-6-phosphate. Inside the cell, galactose is metabolized by the Leloir pathway, rendering glucose-6P, while galactose-6P generated by the PTS enters the tagatose-6P pathway (see below), yielding glyceraldehyde-3P that is incorporated to the glycolysis. The presence of galactose pathways was initially demonstrated in *L. lactis* but has been shown to be common in most LAB (see the following).

### 18.2.2 Metabolism: Metabolites Produced

In LAB, glycolysis (Embden–Meyerhoff pathway) is the major route of carbohydrate catabolism and most sugars (monosaccharides and disaccharides) are finally transformed into glucose or fructose to enter this pathway. A difference between this bacterial group and other microorganisms (aerobic) and higher organisms is that this group cannot perform respiration, as they lack Krebs cycle, cytochromes, and cofactors that carry out proton transport to oxygen, hence they require an acceptor for the proton excess generated by glyceraldehyde-3-phosphate dehydrogenase, such as pyruvate.

#### 18.2.2.1 Glycolysis (Homofermentative Pathway)

This pathway starts when glucose is loaded with energy by undertaking two consecutive phosphorylations carried out by hexokinase at the expense of ATP. It is also called Embden–Meyerhof–Parnas pathway. However if transport occurs through PTS, phosphorylation is simultaneous to transport [15] and phosphoryl group is obtained from phosphoenol pyruvate (PEP) (Figure 18.1) [16]. Then successive reactions take place until fructose-1,6BP is cleaved by fructose-1,6BP aldolase in two triose

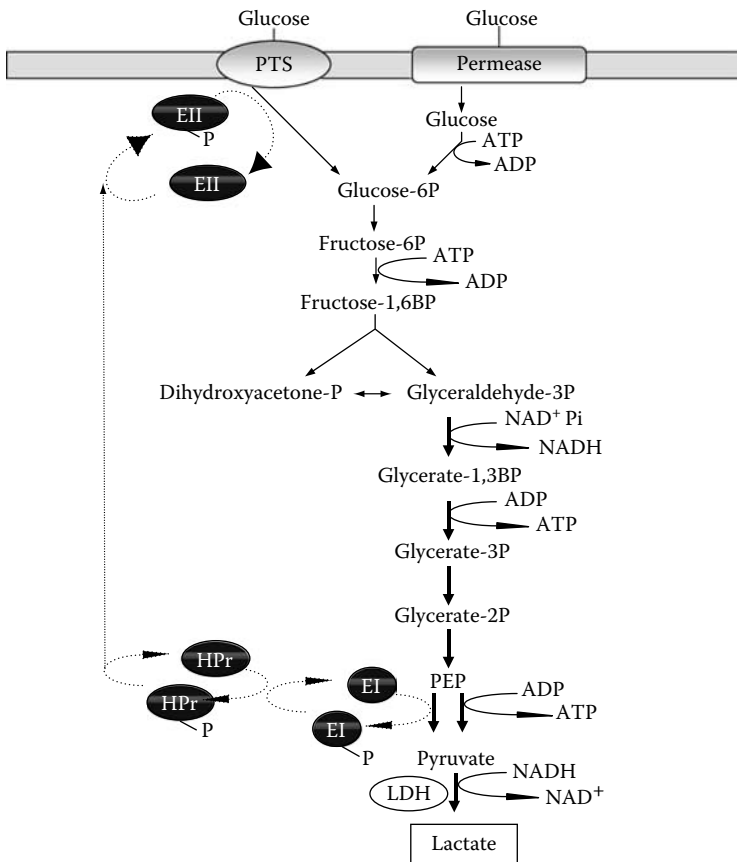


Figure 18.1 Homofermentative pathway. Lower part of glycolysis comprise glyceraldehyde-3P to lactate. LDH, lactate dehydrogenase.

molecules, dihydroxyacetone phosphate and glyceraldehyde-3P that are interchangeable by action of the enzyme triose phosphate isomerase. At this stage the lower part of glycolysis starts and molar proportions are doubled, hence each molecule of glucose will yield two of glyceraldehyde-3P.

The conversion of glyceraldehyde-3P to glycerate-1,3BP is a key reaction performed by glyceraldehyde-3P dehydrogenase, in which inorganic phosphate is incorporated and in the dehydrogenation process,  $\text{NAD}^+$  is reduced to NADH. Then, the enzyme glycerophosphate kinase mediates the transfer of a phosphate from glycerate-1,3BP to ADP, hence obtaining a mol of ATP and glycerate-3P through substrate level phosphorylation. The following reactions lead to an increase of the hydrolysis energy of the phosphate group. As consequence, the second substrate level phosphorylation catalyzed by pyruvate kinase yields another ATP and pyruvate. PEP energy can also be utilized by the PTS transport system after the transfer of its phosphate group to Enzyme I (see above). As result, the global balance of the glycolysis is the production of 2 mol of lactate and 2 mol of ATP per mol of glucose that enters the pathway.

During glycolytic catabolism of glucose, 2 mol of  $\text{NAD}^+$  are also converted to NADH. In order to regenerate  $\text{NAD}^+$ , pyruvate is reduced to lactic acid by the enzyme lactate dehydrogenase with the consequent oxidation of NADH to  $\text{NAD}^+$ . This reaction is absolutely essential for the overall redox balance during glycolysis. Different LAB accumulate D- or L-lactate, or both isomers, in the culture supernatant following a species specific pattern, depending on the specificity of their respective lactate dehydrogenases (D-Ldh or L-Ldh).

### 18.2.2.2 Pentose Phosphate Pathway (Heterofermentative Pathway)

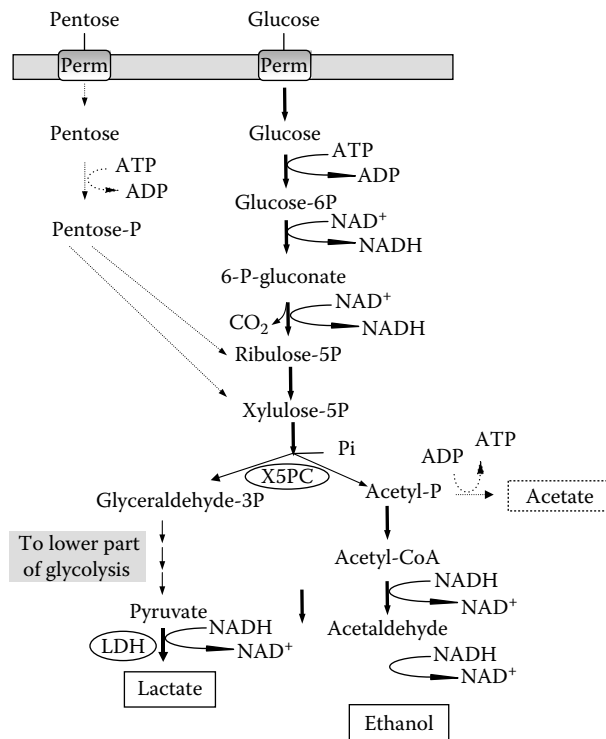
Some microorganisms use glucose through the pentoses phosphate pathway [17] (Figure 18.2) which has, to some extent, certain structural parallelism with glycolysis. In heterofermentative bacteria, glucose is normally transported by a proton motive force permease, and then it is phosphorylated by hexokinase [18]. After glucose phosphorylation, glucose-6P undertakes two consecutive dehydrogenations, where two NADH molecules are formed per molecule of glucose. During the second dehydrogenation, a decarboxylation also takes place, hence ribulose-5P and  $\text{CO}_2$  are formed from 6-phosphogluconate. Then, ribulose-5P is epimerized to xylulose-5P, which by action of xylulose-5P/fructose-6P phosphoketolase, renders glyceraldehyde-3P and acetyl-P. This enzyme binds an effector molecule of thiamine diphosphate (TPP), like some other catabolic enzymes, such as transketolase, pyruvate oxidase, and pyruvate decarboxylase [19]. Actually, when this pathway is used for pentose catabolism the early redox reactions on hexoses are not required.

Glyceraldehyde-3P enters the lower part of the common glycolysis, rendering two ATP molecules, one of NADH and one of pyruvate. Therefore, during heterofermentative catabolism three molecules of NADH need to be oxidized back to  $\text{NAD}^+$ . As in the homolactic pathway, lactate dehydrogenase reduces pyruvate to lactate to regenerate one molecule of  $\text{NAD}^+$ . The other two NADH molecules are oxidized by means of acetyl-P obtained in the upper part. Phosphotransacetylase leads to the formation of acetyl-CoA, which will be reduced twice consecutively by reactions catalyzed by alcohol dehydrogenase. Two NADH molecules are consumed in this process to regenerate two  $\text{NAD}^+$ . Therefore, the global balance of the heterofermentation of a mol of glucose is a mol of lactate, one of ethanol and one of  $\text{CO}_2$ , with a net energy yield of 1 mol of ATP.

### 18.2.2.3 Fructose-6P Shuttle (Bifidus Pathway)

Bifidobacteria are taxonomically and biochemically very different to LAB. They produce lactic acid using a particular pathway called fructose-6P shuttle with a key enzyme, which in this case



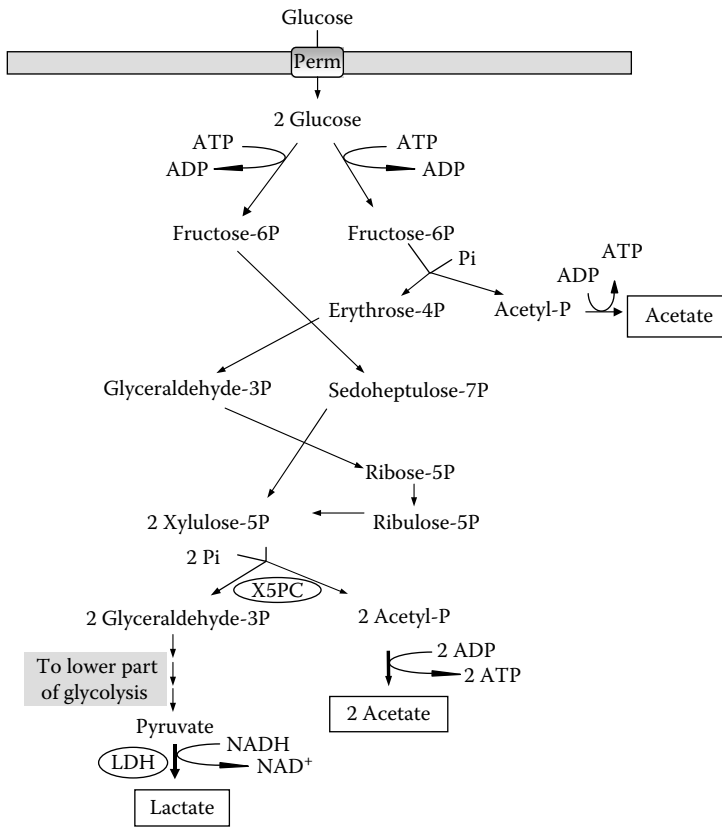


**Figure 18.2 Pentose phosphate pathway (heterofermentative pathway).** X5PC, xylulose-5P phosphoketolase; LDH, lactate dehydrogenase.

could be a fructose-6P phosphoketolase or a xylulose-5P/fructose-6P phosphoketolase, as in LAB [20]. As shown in Figure 18.3, during the Bifidus pathway, two molecules of glucose are fermented into two molecules of lactate and three of acetate [21]. In the sequence of reactions of this pathway, two glucose molecules translocated by a permease are transformed to fructose-6P by means of hexokinase and glucose-6P isomerase. A fructose-6P molecule is then hydrolyzed to erythrose-4P and acetyl-P by fructose-6P phosphoketolase. Another fructose-6P molecule, together with erythrose-4P is transaldolated rendering glyceraldehyde-3P and sedoheptulose-7P; then, both are transketolated yielding xylulose-5P and ribose-5P that will be catabolized in a similar way to pentoses via the pentose phosphate pathway. Hence the Bifidus pathway will produce 2 mol of lactate and 2 mol of acetate from 2 mol of glucose. However, it is most remarkable that this pathway has a higher energy yield than both, homo- and heterofermentative pathways (2.5 mol of ATP per mol of glucose) of LAB.

#### 18.2.2.4 Galactose Catabolism: Leloir and Tagatose-6P Pathways

Galactose catabolism constitute a remarkable exception among hexoses. When it is transported into the cell by a PTS mechanism it is driven through the tagatose-6P pathway [22], a catabolic pathway different from the upper part of glycolysis. However, LAB strains that transport galactose via permeases normally convert it to glucose through the Leloir pathway [23] (Figure 18.4).



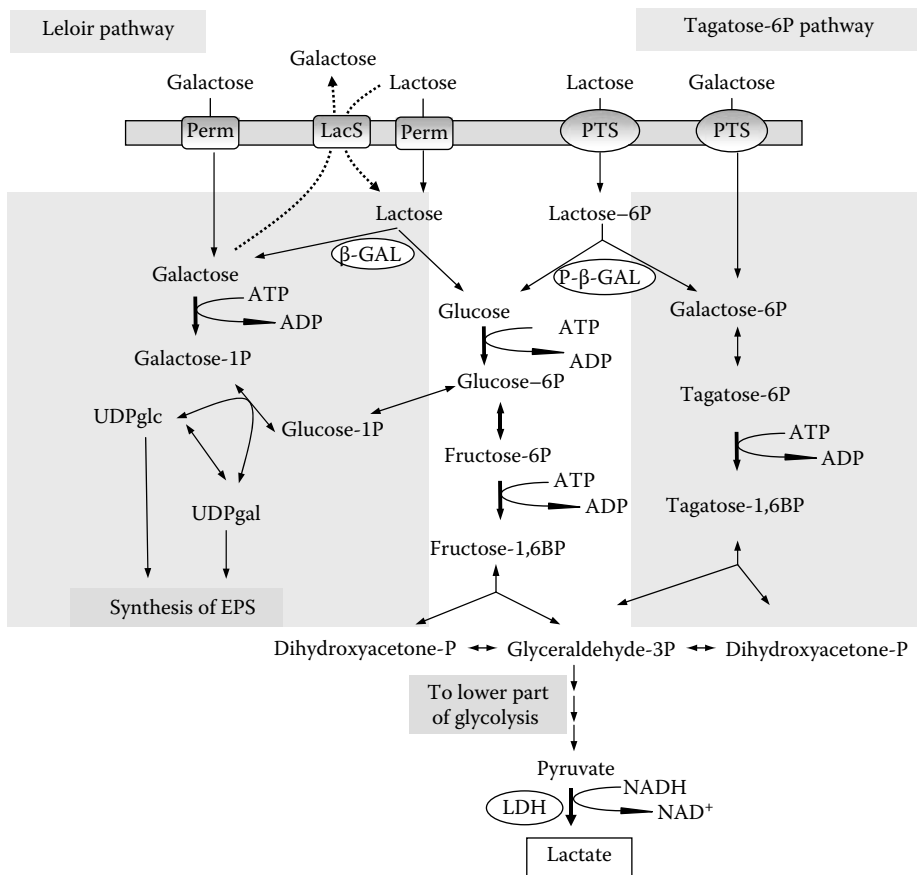
**Figure 18.3 Fructose-6P shuttle or Bifidus pathway.** X5PC, xylulose-5P phosphoketolase; LDH, lactate dehydrogenase.

The tagatose-6P pathway has great analogy with the upper part of glycolysis. All enzymatic reactions have a similar function until the obtention of a hexose-1,6-bisphosphate that can be cleaved into two trioses-P. Tagatose is a stereoisomer of fructose, however it requires specific enzymes.

The Leloir pathway is ubiquitous in eubacteria. It can be used to assimilate galactose as carbon and energy source, as well as carbohydrate anabolic pathway, since galactosides are frequently useful as building blocks in the synthesis of lipopolysaccharide, cell wall constituents, and exopolysaccharides (EPS) [24]. As shown in Figure 18.4, this pathway starts with the phosphorylation of intracellular galactose (transported by a permease) by galactokinase at position C<sub>1</sub>. Then galactose-1P is exchanged for glucose-1P in UDP-glucose (glucose uridine diphosphate), yielding UDP-galactose and glucose-1P as products. Phosphoglucomutase is responsible for the isomerization of glucose-1P to glucose-6P that will be incorporated to glycolysis.

### 18.2.2.5 Alternative Pathways from Pyruvate (Mix Acid Fermentation)

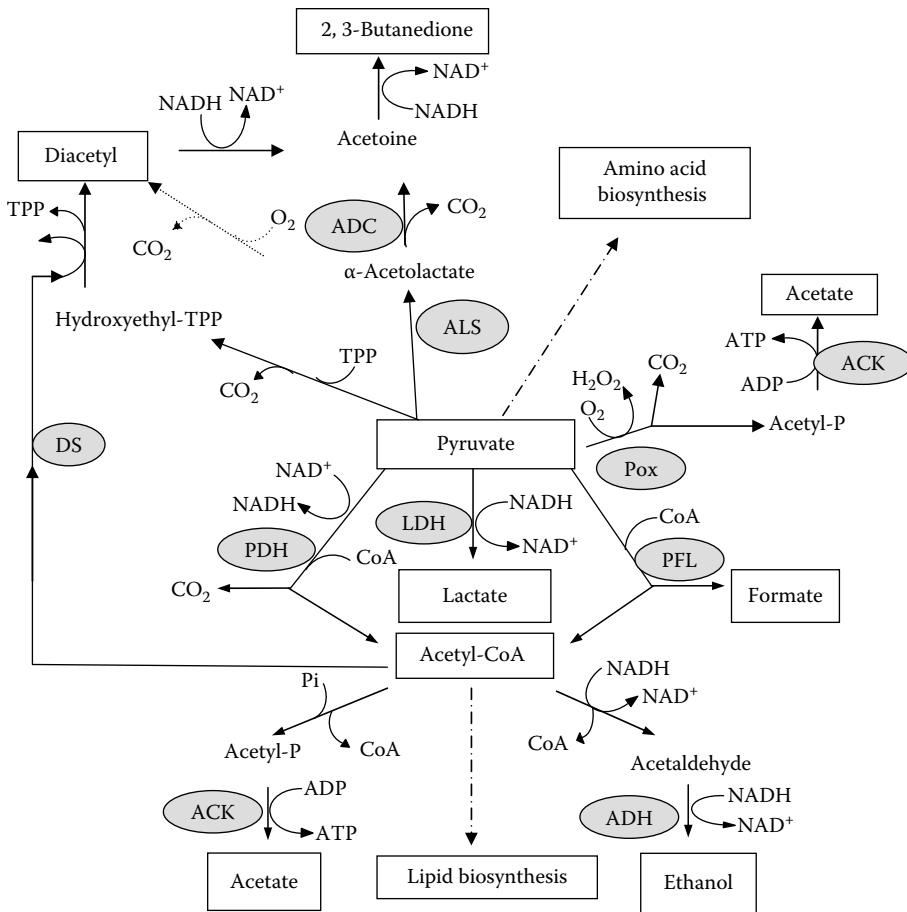
Most of the pyruvate produced through the different pathways is reduced to lactate in order to preserve the redox balance during fermentative processes. However, LAB also produce many compounds other than lactate. Figure 18.5 shows a scheme with alternative pathways from pyruvate



**Figure 18.4** Galactose pathways, Leloir (left) and tagatose-6P (right), and channeling of metabolites to the lower part of glycolysis or EPS synthesis.  $\beta$ -GAL,  $\beta$ -galactosidase; P- $\beta$ -GAL, phospho- $\beta$ -galactosidase.

[21], where the production of different compounds is represented. Not every strain is able to produce all of them and the fact that a certain pathway is used or not will depend upon the strain/species and the environmental conditions. The pyruvate-formate lyase and pyruvate dehydrogenase pathways are very interesting and are of great relevance. They have been described in detail elsewhere [2], however, due to the specific focus of this work, attention will be centered on the formation of diacetyl/acetoin [21]. These very important compounds are significantly accumulated when pyruvate constitutes an excess relative to the cell requirement for NAD<sup>+</sup> regeneration. There are two possible routes to obtain these compounds (Figure 18.5), but evidences indicate that it proceeds via  $\alpha$ -acetylactate [25] that can render diacetyl by decarboxylation, which occurs by chemical oxidation (growth with O<sub>2</sub> at low pH) or acetoin by enzymatic decarboxylation.

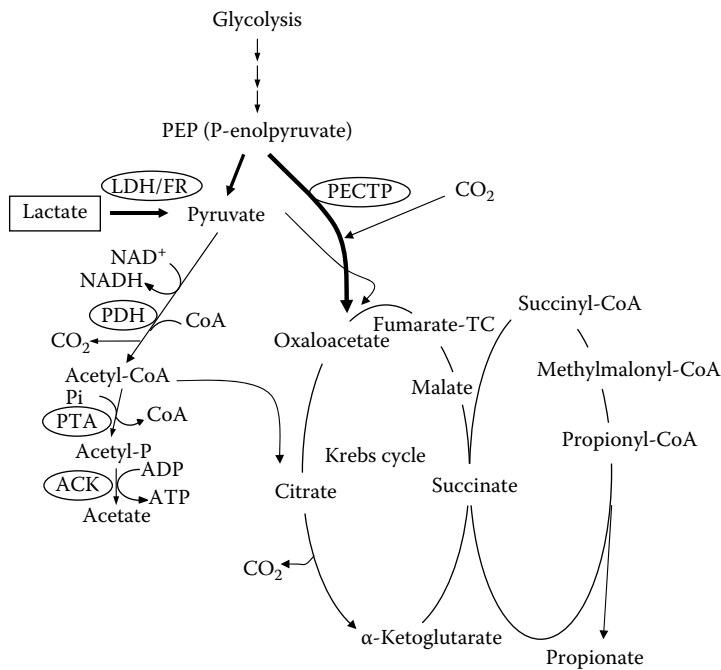
However, in dairy fermentations, a remarkable amount of the diacetyl and acetoin present have not originated from sugar metabolism but from citrate. Citrate is naturally present in milk (~1.5 g/l) and is often added to improve flavor formation. LAB and particularly *L. lactis* subsp. *cremoris* var. *diacetylactis* can transform citrate into pyruvate by action of the enzyme citrate lyase that forms oxaloacetate and acetate and subsequently by the enzyme oxaloacetate decarboxylase [26].



**Figure 18.5** Alternative pathways of pyruvate. ACK, acetate kinase; ADC, acetolactate decarboxylase; ADH, alcohol dehydrogenase; ALS, acetolactate synthase; CoA, coenzyme A; DS, diacetyl synthase; LDH, lactate dehydrogenase; PDH, pyruvate dehydrogenase; PFL pyruvate-formate lyase; POX, pyruvate oxidase.

### 18.2.2.6 Propionate Production by *Propionibacterium*

*Propionibacteria* play an essential role in the ripening of Swiss type cheeses by producing propionate, acetate and CO<sub>2</sub>, and vitamin B<sub>12</sub> [27]. Unlike LAB, these gram-positive bacteria have a functional Krebs cycle and they can use lactate in addition to sugars like lactose, glucose, galactose and pentoses [28], as energy source. Hexoses and ultimately lactose are catabolized via glycolytic pathway, while lactate is reduced to pyruvate by a membrane bound NAD<sup>+</sup> independent lactate dehydrogenase that uses fumarate as proton acceptor (fumarate reductase activity), then following the dicarboxylic acid pathway (Figure 18.6). The overall stoichiometry of lactate conversion follows the following ratios: 3 lactate → 2 propionate + 1 acetate + 1 CO<sub>2</sub> + 1 HO<sub>2</sub>. Furthermore, lactate is considered the preferential substrate for propionate production in laboratory fermentations as well as during cheese ripening [29], in particular, L-lactate is preferred to D-lactate [30]. Two interesting features of propionibacterial metabolism are the central carbon



**Figure 18.6 Propionate pathway in propionibacteria.** LDH/FR, lactate dehydrogenase/fumarate reductase; PECTP, phosphoenol carboxytransphosphorylase; TC, transcarboxylase.

metabolic pathway of the Wood–Werkman cycle (heterotrophic assimilation of CO<sub>2</sub>) and the presence of a multimeric transcarboxylase. This transcarboxylase catalyzes the reversible transfer of a carboxyl group from methylmalonyl coenzyme A (CoA) to pyruvate yielding propionyl-CoA and oxaloacetate. The carboxyl group transferred is never released nor exchanged with the CO<sub>2</sub> dissolved in the medium.

## 18.3 Methods

### 18.3.1 General Methods

Different methods have been compiled for the detection of sugars and technologically relevant intermediates and products of glycolysis. Some indirect procedures are obsolete or just too unspecific, such as the gravimetric method for lactose determination (AOAC 930.28). They have been avoided in this review, in favor of substrate specific assays or new promising techniques. However, due to their simplicity and widespread use techniques such as titrable acidity (AOAC 947.05) can still be the method of choice to monitor fermentations under certain conditions.

They have been classified according to their fundamentals, as enzymatic, chromatographic (high-performance liquid chromatography, HPLC, gas chromatography, GC), near infrared (NIR) or medium infrared (MIR), and a mention will be made of enzyme immobilized electrochemical sensors. Unfortunately not all of them have yet been validated by official organisms (IUPAC, AOAC, ISO).

### 18.3.1.1 Sample Preparation

Except for certain applications of spectrometric methods, such as MIR or NIR, the presence of milk fat globules and the casein emulsion cause serious disturbances along the procedures or at the detection level. Hence, a “cleanup” step should normally be introduced. For HPLC assays, liquid (milk, yogurt, kefir, etc.) samples can be diluted and then, protein is precipitated with HPLC compatible agents, such as trichloroacetic acid (6% final conc.) (TCA) [31], mixed 1:1 with 70% acetonitrile, acetone, or 2-propanol [32]. In cheese samples, organic acids can be recovered by steam distillation [33] or simply by 2 h incubation of 5 g sample with 25 mL of 0.01 N sulfuric acid [34]. In all cases, samples are filtered to eliminate the protein precipitate formed. Often a chloroform extraction of fat is required. An excellent review on general food preparation techniques for HPLC can be found in Peris-Tortajada (2000) [35].

For enzymatic determination of lactose AOAC validated procedure 984.15 [36] recommends dilution of 2 mL in 60 mL of water and addition of 5 mL  $K_4Fe(CN)_6 \cdot 3H_2O$  (3.6 g/100 mL, Carrez sol. I) and 5 mL  $ZnSO_4 \cdot 7H_2O$  (7.2 g/100 mL, Carrez sol. II), plus 10 mL 0.1 M NaOH, shake and complete the volume at 100 mL with water. Then, samples must be filtered before their use not only in the enzymatic assay [36], but also for HPLC analysis.

### 18.3.1.2 Enzymatic Methods

In general terms, enzymatic methods have been developed to detect almost any sugar, intermediate, and final product of glycolysis and annex pathways, which are available as commercial kits from various firms. Boehringer Mannheim pioneered such developments and edited a very useful manual, with all these methods, which was very helpful in experimental developments [37]. They are based on linked enzymatic reactions that have the common strategy of a final oxido-reductase enzyme that reduces  $NAD^+$  to NADH, which absorbs UV light at 340, 334, or 365 nm, depending on the light source, with a molar extinction coefficient of  $6.2 \times 10^{-3} \text{ mol}^{-1} \text{ cm}^{-1}$ , for which absorbance can be transformed to substrate mols through the simple formula  $A = \epsilon \cdot b \cdot c$  ( $A$  is the absorbance at 340 nm,  $\epsilon$  is the molar extinction coefficient,  $b$  in the cell path, normally 1 cm, and  $c$  is the concentration of NADH). To correctly apply the method, the calculations must be made as change of absorbance per time unit ( $\Delta c/\text{min} = (\Delta A/\text{min})/\epsilon \cdot b$ ). This commitment has been overtaken by the Roche Diagnostics branch, R-Biopharm, but numerous companies have followed this trend (Sigma-Aldrich, BioAssays, BioVision, and others), or even simplified the procedures by the inclusion of formazan (MTT)/phenazine methosulfate (PMS) color development to read the reaction at 565–570 nm, however with a significant loss of sensitivity.

Enzymes used for each particular compound are described in the following.

### 18.3.1.3 Chromatographic Methods

Chromatographic methods are very efficient when several compounds of similar nature are to be monitored because in one run relative concentrations, given as peak areas, can be determined with a linear response over a wide concentration range. However, they require technical skills, familiarity with the procedures and specialized equipments (HPLC, GC), to choose the appropriate column and mobile phase. Normally, sugars and glycolytic metabolites have a high refractive index in solution, which facilitates detection and quantifications in liquid chromatography (HPLC). The standard procedure for sugars has been validated by ISO and International Dairy Federation—IDF (ISO CD 22622/IDF 198) [38]. It uses degassed HPLC-grade water (mobile phase), a flow rate of 0.6 mL/min, a refraction index detector (temperature 350°C), a styrene divinylbenzene resin type

column and an oven for the column set at 85°C. In these conditions, a volume of 20 µL should be injected and a run time of 15 min would be enough to separate and yield reproducible peaks for lactose, glucose, galactose, sucrose, fructose, and other sugars. However, numerous specialized columns are commercialized by highly qualified brands for determination of sugars, and mobile phases can include a proportion of acetonitrile in water (25%–75% acetonitrile). A compatible guard microcolumn is required in all cases as recommended by manufacturers. The same column type used for sugars can also be used for the determination of end product organic acids, although temperature of the column is dropped to 50°C–60°C [33]. However, specialized organic acids columns are recommended (AOAC method 986.13) [39] of the reverse phase C18 type. Because organic acids are low in molecular weight and polar, 100% aqueous and acidic (0.01 N H<sub>2</sub>SO<sub>4</sub>) mobile phase under isocratic conditions is used. Thus, acidic groups are protonated and interaction with the C18 stationary phase is favored. A very efficient chromatography system is based on high-performance anion exchange chromatography (HPAEC) coupled to electrochemical system (pulsed amperometric detector, PAD). This system joins the resolution of HPAEC to the most sensitive PAD.

GC has been extensively used for determination of volatile glycolytic products, such as diacetyl, ethanol, and some volatile acids, such as acetic acid, propionate, or butyrate [40]. Compounds of interest can be recovered from the samples by solid phase system or the microextraction variant [41] (SPE and SPME), as well as with automated [42] or semiautomated head space extraction systems. However, the quantitative value of solid phase microextraction systems is still questionable, due to the variables introduced by the partition coefficient (water/gas) of volatiles and affinity of the solid phase for each compound. For separation, multivalent silica fused columns (60 m × 0.32 mm Agilent SPB-5 type) with helium as carrier gas, heated progressively to 37°C, 55°C, and 175°C achieving the complete elution at 240°C [42], are most efficient. Other parameters depend very much on the equipment itself: coupled or not to automatic dynamic head space apparatus; septum or mechanic injector; split (5:1) or splitless preheated injector (240°C); coupled to mass spectrometer or FID detectors; etc.

#### *18.3.1.4 Spectroscopic Techniques*

MIR, NIR, and Raman spectroscopy constitute very efficient systems for quality control in food and especially in dairy products [38]. They require a long and laborious calibration procedure. However this task is compensated when numerous sample parameters are obtained in a few seconds. These techniques are based upon the analysis of the infrared absorption/reflection spectra obtained from the studied products. They depend on the specific absorption/reflection capacity of the molecular structures in the sample, for which these analytical procedures inevitably require application chemometrics and complex mathematical developments such as the Fourier transform. MIR and NIR have different applications, as they give different spectra and also their penetration power is different. While MIR is used as a standard technique for industrial quality control in solids, NIR can be used for liquid samples, with no sample preparation and minimal training, however, there is still a very strong interference of water and it has a very low sensitivity to minor components. A review on the fundamentals of these techniques can be found elsewhere [43,44].

### **18.3.2 Detection of Glycolysis Metabolites**

#### *18.3.2.1 Lactose*

Lactose is the only source of sugars that enter the glycolysis in milk. As described before (Figure 18.1), lactose is hydrolyzed by microbial β-galactosidases, or phospho-β-galactosidases when lactose-specific PTS is present, to be metabolized by bacteria through various pathways converging to the glycolysis.

There are different validated methods for lactose quantification [45]: enzymatic assay [36], including differential pH [46], MIR [47], polarimetry [48], gravimetry [49], and HPLC. All of them have advantages and disadvantages. For instance, an inexistent sample preparation and short analytical time required by MIR allows processing of hundreds of samples per hour, while the use of polarimetry, gravimetry, and enzyme-based methods have very low cost in reagents and equipment. Alternatively, HPLC is highly specific, flexible, it differentiates other sugars, however, together with MIR, both demand a high equipment investment.

Enzymatic hydrolysis of lactose to glucose and galactose is one of the preferred procedures for the precise and specific quantification of lactose in research laboratories. Both monosaccharides can be enzymatically oxidized with the concomitant reduction of NAD to NADH, which allows monitoring of the reaction as described above [37]. In these procedures, glucose from lactose can be phosphorylated by hexokinase in the presence of ATP and then, enzymatically oxidized through a coupled reaction with glucose-6P dehydrogenase (see below, determination of glucose). Oxidation of galactose and formation of NADH requires a single step carried out by galactose dehydrogenase. This option constitutes the official validated method for enzymatic determination of lactose [36].

Lactose determination through the differential pH procedure also uses enzyme reactions. Lactose (also lactulose) is hydrolyzed by  $\beta$ -galactosidase and the resulting sugar mix is treated with hexokinase and glucokinase as above. However, glucokinase reaction liberates  $H^+$  (glucose + ATP  $\rightarrow$  sugar-P + ADP +  $H^+$ ) that will be measured by highly sensitive pH measuring devices [46,50].

Sugar determinations through HPLC are very well established and regularly used in research studies. As mentioned above, HPLC allows the separation of closely related chemical species and automatic sample injection; however, the cost of the equipments and differences between assay conditions in different laboratories hampered so far its establishment as standard procedure for routine food analysis. The standard procedure validated by ISO and IDF (ISO CD 22622/IDF 198) [38] uses degassed HPLC grade water (mobile phase), a flow rate of 0,6 mL/min, a refraction index detector (temperature 350°C), a styrene divinylbenzene resin type column and an oven for the column set at 85°C. In these conditions, a volume of 20  $\mu$ L should be injected and a run time of 15 min would be enough to separate and yield reproducible peaks for lactose, glucose, galactose, sucrose, fructose, and other sugars. Some authors claim that the HPLC method offers slightly less variation between samples than the enzymatic one [32].

### 18.3.2.2 Glucose

Glucose is transiently present in the cytoplasm of fermenting microorganisms of dairy products after lactose hydrolysis. However, glucose and often fructose are ingredients in dairy products and they both are key precursors of glycolysis.

Reducing sugars determination with dinitrosalicylic acid is the most widespread and inexpensive method for the quantification of mono- and disaccharides [51]. However, it may be unsuitable for some food products due to its unspecificity. In dairy products, it could be very useful for the analysis of total sugars in finished plain or sugary products, with added dextrans, glucose, or fructose. It is also applicable in the case of lactose free products, in which lactose has been hydrolyzed with a  $\beta$ -galactosidase enzyme to galactose and glucose.

Enzymatic determinations are always very specific and precise for quantification of sugars. In the case of glucose determinations, a coupled enzymatic reaction is used where hexokinase phosphorylates glucose to glucose-6P, which in turn reacts with glucose-6P dehydrogenase and NAD to form NADH that can be quantified as described above, as its formation is stoichiometric to the amount of glucose in the sample. This method has been validated by AOAC for wine analysis but



is very adaptable to any food/drink sample [52]. As described above, differential pH determination is a variant of the enzymatic method and it consists in measurement of the stoichiometric formation of  $H^+$  after the glucokinase action on glucose ( $\text{glucose} + \text{ATP} \rightarrow \text{glucose-P} + \text{ADP} + H^+$ ), which is measured by highly sensitive pH measuring device [50].

Chromatographic methods are very suited for sugar determinations. In case of HPLC, a very similar protocol can be used to detect and quantify mono- or disaccharides (see above).

As described above, HPAEC with an amperometric detector is a highly efficient method for the determination of monosaccharides, disaccharides, and oligosaccharides. Although it has not been validated for dairy products, it can be used to determine the content of trace amounts of fructose and glucose in cane sugar with great precision [53].

### 18.3.2.3 Galactose

This monosaccharide is found in many yogurts and fermented milks in which *S. thermophilus* has been used. As mentioned, this microorganism expels the galactose moiety of lactose during its growth on milk (Figure 18.4), reaching concentrations of 7–20 g/L as recorded after the analysis of various fermented dairy products [54].

Most of the methods described for lactose and glucose can be applied for the quantification of galactose. Hence, HPLC and HPAEC can be used with the same columns and running conditions and the AOAC validated enzymatic method for lactose detection can be simplified—by omission of  $\beta$ -galactosidase treatment—to efficiently detect galactose [36].

### 18.3.2.4 Lactate

Lactic acid is the major product of glycolysis and the compound responsible for the pH decrease in dairy products, therefore a simple titration with 0.1 M NaOH can suffice to evaluate the amount of lactate produced (AOAC 947.05) [55]. In this simple technique, phenolphthalein is added to the sample and shaken until pink color stabilizes, then acidity is given as % or g/L lactic acid (1 mL 0.1 M NaOH = 0.00090 g lactic acid). However, the enzymatic determination is most widespread for a finer estimation of lactate produced (ISO 8069/IDF 69), or even for the differentiation of D and L isomers. It is technically simple and allows very reproducible determinations [56–59], it has been validated for dried milk, and it can be implemented for other dairy products [60]. The principle of the procedure is similar to that of the enzymatic determination of sugars, although in this case D- or L-lactic acid is oxidized by D- or L-lactate dehydrogenase and  $NAD^+$ , respectively. The reaction yields pyruvate and NADH, which can be quantified at OD 340 nm following the calculations described above. However, the reaction requires a second enzyme, the glutamate pyruvate transaminase, which catalyzes the conversion ( $\text{pyruvate} + \text{L-glutamate} \rightarrow \text{L-alanine} + 2\text{-oxoglutarate}$ ), in order to drain pyruvate formed yielding a stoichiometric reaction. Variants of the enzymatic method for determination of lactate have recently been published [56–59].

The most common chromatographic method used for lactic acid is the general HPLC procedure for organic acids, the same as for other organic acids (see below).

### 18.3.2.5 Acetate, Propionate, and Butyrate

Acetate, propionate, and butyrate are very volatile acids, so steam distillation yields an excellent recovery. Determination of short chain acids by ligand-exchange, ion-exclusion HPLC is most

widespread. For cheese, 20 g of the sample can be grated followed by addition of 10 mL of 10% (w/v)  $\text{H}_2\text{SO}_4$ , one drop of antifoam agent (silicone) and 40 mL of deionized water. The volume collected after distillation can be directly injected onto an HPLC with acidic isocratic mobile phase, for instance 0.01 N  $\text{H}_2\text{SO}_4$  [33,34]. Then determination is performed using a thermostated (50°C) monosaccharide [33] column or a specialized column for organic acids [34,39], which is a 8% cross-linked sulfonated styrene divinylbenzene (SDVB) type column with  $\text{H}^+$  ionic form.

GC is most efficient for the detection of diacetyl, ethanol, and volatile acids, such as acetic acid, propionate, or butyrate [40,42]. For separation, multivalent silica-fused columns are also efficient (see above).

Validated procedures for acetic acid determination through enzymatic reactions have been developed for applications other than dairy products [61]. Through these procedures, the enzyme acetyl-CoA synthetase catalyzes the reaction ( $\text{acetate} + \text{ATP} + \text{CoA} \rightarrow \text{acetyl-CoA} + \text{AMP} + \text{pyrophosphate}$ ). Then, citrate synthase converts acetyl-CoA to citrate through the reaction ( $\text{acetyl-CoA} + \text{oxaloacetate} + \text{H}_2\text{O} \rightarrow \text{citrate} + \text{CoA}$ ). This ingenious procedure relies in the consumption of oxaloacetate by this reaction, which is formed from L-malate and  $\text{NAD}^+$  in the presence of L-malate dehydrogenase. This reaction will form NADH ( $\text{malate} + \text{NAD}^+ \leftrightarrow \text{oxaloacetate} + \text{NADH} + \text{H}^+$ ) that can be quantified by absorbance at 340 nm, as described before.

### 18.3.2.6 *Diacetyl, Acetoin, and Acetolactate*

Diacetyl (2,3-butanedione), acetoin (acetyl methylcarbinol), and  $\alpha$ -acetolactate are chemically and metabolically close compounds (Figure 18.5). Diacetyl can be decarboxylated to acetoin, a step required in the enzymatic determinations as well as for GC, since acetoin is highly fixed to ionic solvents. Acetolactate, acetoin, and diacetyl can be quantified by a colorimetric reaction performed by the method of Westerfield [62]. However, a double measurement is required before and after acetolactate is decarboxylated to acetoin upon heating in diluted acid. Acid, 0.1 mL of 50%  $\text{H}_2\text{SO}_4$  (v/v), is added to a 1 mL sample containing acetolactate, and the mixture is incubated for 10 min at 70°C to complete the decarboxylation. A 0.5 mL portion of this mixture is then neutralized by the addition of 0.5 mL of 2.5 N NaOH. Then 1 mL of creatine (0.5%, w/v) and 1 mL of freshly prepared  $\alpha$ -naphthol (5%, w/v in 2.5 M NaOH) are added. The sample is then incubated at 37°C. The color produced is measured at 530 nm after 60 min for acetolactate and acetoin and after 10 min for diacetyl. For the determination of diacetyl and acetoin, the acid decarboxylation and neutralization steps are omitted.

GC is most efficient for the detection of diacetyl, ethanol, and volatile acids. In this particular case, acetone also needs to be converted to diacetyl for an efficient quantification. Methods described above are most suited for diacetyl detection.

### 18.3.2.7 *Ethanol*

Ethanol determination can be very important in LAB driven fermentations, as indication of yeast contamination. However, it is a desirable compound in certain products such as kefir or curdled milk. Certainly, ethanol is very easy to determine and quantify by any of the chromatographic techniques mentioned, specially by GC under the conditions described for diacetyl detection.

An enzymatic detection system can also be efficiently applied through the reaction catalyzed by alcohol dehydrogenase ( $\text{ethanol} + \text{NAD}^+ \rightarrow \text{acetaldehyde} + \text{NADH} + \text{H}^+$ ). Then, acetaldehyde is consumed by coupled action of acetaldehyde dehydrogenase ( $\text{acetaldehyde} + \text{NAD}^+ \rightarrow \text{acetic acid} + \text{NADH} + \text{H}^+$ ) [63,64].

## 18.4 Conclusions

All methods described are highly precise although the analytical method of choice will depend upon the instrumentation available, number of samples to be analyzed, personnel qualification and time.

“Enzymatic methods” are efficient and relatively cheap if the number of samples is not too large and they only require certain technical skills and a UV/Vis spectrophotometer.

“Chromatographic methods” are faster and several compounds can be determined in every run, but the equipments are normally expensive, they require better sample preparation procedures and require higher technical skills and knowledge than enzymatic methods.

“Spectrometric methods” are the champions regarding number of samples studied per time unit. They are precise if properly calibrated, and qualifications required in the operating personnel are very low due to the high level of computer processing. However, calibration is a very time consuming task that requires great chemometric knowledge. Furthermore, equipments (NIR, MIR) are very expensive.

## References

- Asano, M., Furukawa, K., Kido, M., Matsumoto, S., Umesaki, Y., Kochibe, N., Iwakura, Y., Growth retardation and early death of beta-1,4-galactosyltransferase knockout mice with augmented proliferation and abnormal differentiation of epithelial cells, *EMBO J.*, 16, 1850, 1997.
- Perez Martinez, G., Monedero, V., Yebra, M. J., Sugar catabolism and lactic acid production, in Mayo, B., Lopez, P., and Perez Martinez, G., (eds.), *Molecular Aspects of Lactic Acid Bacteria for Traditional and New Applications*, Kerala, India, Research Signpost, 2008, 29.
- Poolman, B., Energy transduction in lactic acid bacteria, *FEMS Microbiol. Rev.*, 12, 125, 1993.
- Poolman, B., Regulation of bacterial sugar-H<sup>+</sup> symport by phosphoenolpyruvate-dependent enzyme I/HPr-mediated phosphorylation, *Proc. Natl. Acad. Sci. USA*, 92, 778, 1995.
- McKay, L., Miller III, A., Sandine, W. E., Elliker, P. R., Mechanisms of lactose utilization by lactic acid streptococci: enzymatic and genetic analysis, *J. Bacteriol.*, 102, 804–809, 1970.
- McKay, L. L., Functional properties of plasmids in lactic streptococci, *Antonie van Leeuwenhoek*, 49, 259–274, 1983.
- Foucaud, C., Poolman, B., Lactose transport system of *Streptococcus thermophilus*. Functional reconstitution of the protein and characterization of the kinetic mechanism of transport, *J. Biol. Chem.*, 267, 22087, 1992.
- Cochu, A., The doubly phosphorylated form of HPr, HPr(Ser-P)(His-P), is abundant in exponentially growing cells of *Streptococcus thermophilus* and phosphorylates the lactose transporter LacS as efficiently as HPr(His-P), *Appl. Environ. Microbiol.*, 71, 1364, 2005.
- Gunnewijk, M. G., Phosphorylation state of HPr determines the level of expression and the extent of phosphorylation of the lactose transport protein of *Streptococcus thermophilus*, *J. Biol. Chem.*, 275, 34073, 2000.
- Abe, K., Uchida, K., Release of glucose mediated catabolite repression due to a defect in the membrane fraction of phosphoenolpyruvate: Mannose phosphotransferase system in *Pediococcus halophilus*, *Arch. Microbiol.*, 155, 517, 1991.
- Gauthier, L., Control of sugar utilization in oral streptococci. Properties of phenotypically distinct 2-deoxyglucose-resistant mutants of *Streptococcus salivarius*, *Oral. Microbiol. Immunol.*, 5, 352, 1990.
- Veyrat, A., Monedero, V., Perez-Martinez, G., Glucose transport by the phosphoenolpyruvate: Mannose phosphotransferase system in *Lactobacillus casei* ATCC 393 and its role in carbon catabolite repression, *Microbiology*, 140, 1141, 1994.

13. Veyrat, A., Monedero, V., Perez-Martinez, G., Glucose transport by the phosphoenolpyruvate:mannose phosphotransferase system in *Lactobacillus casei* ATCC 393 and its role in carbon catabolite repression, *Microbiology* 140, 1141–1149, 1994.
14. Yebra, M. J., Veyrat, A., Santos, M. A., Perez-Martinez, G., Genetics of L-sorbose transport and metabolism in *Lactobacillus casei*, *J. Bacteriol.*, 182, 155, 2000.
15. Deutscher, J., Francke, C., Postma, P. W., How phosphotransferase system-related protein phosphorylation regulates carbohydrate metabolism in bacteria, *Microbiol. Mol. Biol. Rev.*, 70, 939, 2006.
16. Lehninger, *Principles of Biochemistry*, W.H. Freeman, New York, 2004, 1.
17. Gottschalk, G., *Bacterial Metabolism*, Springer-Verlag, New York, 1979.
18. Helanto, M., Aarnikunnas, J., Palva, A., Leisola, M., Nyysölä, A., Characterization of genes involved in fructose utilization by *Lactobacillus fermentum*, *Arch. Microbiol.*, 186, 51, 2006.
19. Muller, Y. A., Lindqvist, Y., Furey, W., Schulz, G. E., Jordan, F., Schneider, G., A thiamin diphosphate binding fold revealed by comparison of the crystal structures of transketolase, pyruvate oxidase and pyruvate decarboxylase, *Structure*, 1, 95, 1993.
20. Meile, L., Rohr, L. M., Geissmann, T. A., Herensperger, M., Teuber, M., Characterization of the D-Xylulose 5-Phosphate/D-Fructose 6-Phosphate Phosphoketolase Gene (xpf) from *Bifidobacterium lactis*, *J. Bacteriol.*, 183, 2929, 2001.
21. Kandler, O., Carbohydrate metabolism in lactic acid bacteria, *Antonie van Leeuwenhoek*, 49, 209, 1983.
22. Bissett, D. L., Anderson, R. L., Lactose and D-galactose metabolism in group N streptococci: Presence of enzymes for both the D-galactose 1-phosphate and D-tagatose 6-phosphate pathways, *J. Bacteriol.*, 117, 318–320, 1974.
23. Thomas, T. D., Turner, K. W., Crow, V. L., Galactose fermentation by *Streptococcus lactis* and *Streptococcus cremoris*: Pathways, products, and regulation, *J. Bacteriol.*, 144, 672, 1980.
24. Frey, P. A., The Leloir pathway: a mechanistic imperative for three enzymes to change the stereochemical configuration of a single carbon in galactose, *FASEB J.*, 10, 461, 1996.
25. Hugenholtz, J., Perdon, L., Abee, T., Growth and energy generation by *Lactococcus lactis* subsp. *lactis* biovar diacetylactis during citrate metabolism, *Appl. Environ. Microbiol.*, 59, 4216, 1993.
26. Garcia Quintans, N., Blancato, V., Repizo, G., Magni, C., Lopez, P., Citrate metabolism and aroma compound production in lactic acid bacteria, in Mayo, B., Lopez, P., and Perez Martinez, G., (eds.), *Molecular Aspects of Lactic Acid Bacteria for Traditional and New Applications*, Research Signpost, Kerala, India, 2008, 65.
27. Hettinga, D. H., Reinbold, G. W., The propionic acid bacteria—A review. II. Metabolism, *J. Milk Food Technol.*, 35, 358, 1972.
28. Piveteau, P., Metabolism of lactate and sugars by dairy propionibacteria: A review, *Lait*, 79, 23, 1999.
29. Deborde, C., Boyaval, P., Interactions between pyruvate and lactate metabolism in *Propionibacterium freudenreichii* subsp. *shermanii*: In vivo <sup>13</sup>C nuclear magnetic resonance studies, *Appl. Environ. Microbiol.*, 66, 2012, 2000.
30. Crow, V. L., Utilization of lactate isomers by *Propionibacterium freudenreichii* subsp. *shermanii*: Regulatory role for intracellular pyruvate, *Appl. Environ. Microbiol.*, 52, 352, 1986.
31. Euber, J. R., Brunner, J. R., Determination of lactose in milk products by high performance liquid chromatography, *J. Dairy Sci.*, 62, 685, 1979.
32. Kwak, H. S., Jeon, J., Comparison of high performance liquid chromatography and enzymatic method for the measurement of lactose in milk, *J. Food Sci.*, 53, 975, 2006.
33. Kilcawley, K. N., Wilkinson, M. G., Fox, P. F., A survey of lipolytic and glycolytic end-products in commercial Cheddar enzyme-modified cheese, *J. Dairy Sci.*, 84, 66, 2001.
34. Lues, J. F., Botha, W. C., Smit, E. J., Ion-exchange HPLC analysis of a broad spectrum of organic acids from matured Cheddar cheese and assessment of extraction methods, *Food Res. Int.*, 31, 441, 1998.
35. Peris-Tortajada, M., HPLC determination of carbohydrates in foods, in Nolle, L. L. M., (ed.), *Food Analysis by HPLC*, Taylor & Francis, London, 2000.

36. AOAC. AOAC Official method 984.15. Lactose in milk. Enzymatic method, in *Official Methods of Analysis of AOAC International*, AOAC, 2005.
37. Boehringer Mannheim GmbH. *Methods of Biochemical Analysis and Food Analysis*. Boehringer Mannheim GmbH, 1989.
38. International Dairy Federation. New applications of mid-infra-red spectrometry for the analysis of milk and milk products. Bulletin—International Dairy Federation 406, all. 2006. Belgium.
39. AOAC. AOAC Official method 986.13. Quinic, malic and citric acids in cranberry juice cocktail and apple juice. Liquid chromatographic method, in *Official Methods of Analysis of AOAC International*, AOAC, 1989.
40. Mariaca, R., Bosset, J. O., Instrumental analysis of volatile (flavour) compounds in milk and dairy products, *Lait*, 77, 13, 1997.
41. Condurso, C., Verzera, A., Romeo, V., Ziino, M., Conte, F., Solid-phase microextraction and gas chromatography mass spectrometry analysis of dairy product volatiles for the determination of shelf-life, *Int. Dairy J.*, 18, 819, 2008.
42. Dauneau, P. J., Pérez-Martinez, G., Fractional factorial design and multiple linear regression to optimise extraction of volatiles from a *Lactobacillus plantarum* bacterial suspension using purge and trap, *J Chromatogr. A*, 775(1/2), 225–230, 1997.
43. Beaten, V., Dardenne, P., Spectroscopy: Developments in instrumentation and analysis, *Grasas y Aceites*, 53, 45, 2002.
44. Woodcock, T., Fagan, C. C., O'Donnell, C. P., Downey, G., Application of near and mid-infrared spectroscopy to determine cheese quality and authenticity, *Food Bioprocess Technol.*, 1, 117, 2008.
45. Kouaouci R., *Analytical Methods for Lactose Quantification in Milk and Milk Products*. IDF International Symposium, Moscow, China, 2007.
46. Luzzana, M., Agnellini, D., Cremonesi, P., Caramenti, G., de Vita, S., Milk lactose and lactulose determination by the differential pH technique, *Le Lait*, 83, 409, 2003.
47. AOAC. AOAC Official method 972.16. Fat, lactose, protein and solids in milk. MIR, in *Official Methods of Analysis of AOAC International*, AOAC, 2005.
48. AOAC. AOAC Official method 896.01. Lactose in milk. Polarimetric method, in *Official Methods of Analysis of AOAC International*, AOAC, 2005.
49. AOAC. AOAC Official method 930.28. Lactose in milk. Gravimetric method, in *Official Methods of Analysis of AOAC International*, AOAC, 2005.
50. Luzzana, M., Agnellini, D., Cremonesi, P., Caramenti, G., Enzymatic reactions for the determination of sugars in food samples using the differential pH technique, *The Analyst*, 126, 2149, 2001.
51. Miller, G. L., Use of dinitrosalicylic acid reagent for determination of reducing sugars, *Anal. Chem.*, 31, 426, 1959.
52. AOAC. AOAC Official method 985.09. Glucose and fructose determination in wine. Enzymatic method, in *Official Methods of Analysis of AOAC INTERNATIONAL*, AOAC, 2005.
53. AOAC. AOAC Official method 2000.17. Determination of trace glucose and fructose in raw cane sugar, high-performance anion-exchange chromatography, in *AOAC TDLM Method Verification Workshop. Example 2: Determination of Low-Level Glucose in Sugar*, AOAC, 2005.
54. O'Brien, J., Sugar profiles of cultured dairy products in the UK, *J. Hum. Nutr. Diet.*, 12, 245, 1999.
55. AOAC Official method 947.05. Acidity of milk. Titration, in *Official Methods of Analysis of AOAC International*, AOAC, 2005.
56. Ameyama, M., Enzymic microdetermination of -glucose, -fructose, -gluconate, 2-keto-gluconate, aldehyde, and alcohol with membrane-bound dehydrogenases, in *Methods in Enzymology Part D: Carbohydrate Metabolism, Part E*, Willis, A. W., Ed., Academic Press, New York, 1982, 20.
57. Byers, F. M., Automated enzymic determination of (+)- and (-)-lactic acid, in *Methods in Enzymology Part D: Carbohydrate Metabolism, Part E*, Willis, A. W., Ed., Academic Press, New York, 1982, 29.
58. Everse, J., Enzymic determination of lactic acid, in *Methods in Enzymology Part B: Carbohydrate Metabolism*, Wood, W. A., Ed., Academic Press, New York, 1975, 41.

59. Barker, S. B., Preparation and colorimetric determination of lactic acid, in *Methods in Enzymology*, Academic Press, New York, 1957, 241.
60. ISO 8069:2005. Dried milk—Determination of content of lactic acid and lactates. 2005.
61. EN ISO 11213 Modified Starch—Determination of acetyl content—Enzymatic method. European Standard ISO. 1995.
62. Westerfeld, W. W., A colorimetric determination of blood acetoin, *J. Biol. Chem.*, 161, 495, 1945.
63. International federation of fruit juice producers, IFU, Methods of Analysis, no. 52–1983, in *Code of Practice for Evaluation of Fruit and Vegetables*, Association of the Industry of juices and nectars from fruits and vegetables of the European Economic Community (A.I.J.N.), 1996.
64. American Society of Brewing Chemists, Enzymatic method for low alcohol concentrations in malt beverages, *ASBC J.*, 49, 185, 1991.



## *Chapter 19*

---

# Determination of Proteolysis in Cheese

---

N. Bansal, P. Piraino, and Paul L.H. McSweeney

### CONTENTS

19.1	Introduction .....	405
19.2	Extraction Methods .....	406
19.3	Expression of the Aqueous Phase of Cheese.....	408
19.4	Fractionation of Peptides Based on Molecular Mass.....	408
19.5	Methods Based on the Liberation of Reactive Compounds or Groups .....	409
19.6	Colorimetric and Fluorimetric Methods for Free Amino Acids .....	409
19.7	Electrophoresis .....	410
19.8	Chromatographic Methods to Assess Proteolysis in Cheese.....	411
19.9	Matrix-Assisted Laser Desorption/Ionization Time-of-Flight Mass Spectrometry to Study Proteolysis in Cheese .....	412
19.10	Chemometric Analysis of Peptide Profiles from HPLC or MALDI-ToF Technology .....	414
	References.....	417

### 19.1 Introduction

Most cheeses are ripened for a period from 2 weeks (e.g., Mozzarella) to 2 or more years (e.g., Italian Grana-type cheeses and extra-mature Cheddar). Biochemical changes which occur in cheese during ripening are usually grouped into one of three broad headings:



- Proteolysis and amino acid catabolism
- Lipolysis and fatty acid metabolism
- Metabolism of residual lactose and of lactate and citrate

Proteolysis is the most complex, and one of the most important, series of biochemical events that occurs in cheese during ripening. Levels of proteolysis vary from limited (e.g., Mozzarella) to extensive (e.g., Blue cheese). Proteolysis is commonly assessed in most cheese ripening studies and a variety of methods which have been used are summarized in this chapter. Proteolysis in cheese during ripening [1–11] and methods for studying proteolysis [1,3,12–15] have been reviewed extensively.

## 19.2 Extraction Methods

The principle of a number of widely used methods for assessing proteolysis in cheese is that caseins are insoluble in various solvents, but the peptides produced from them during the ripening of cheese may be soluble. Thus the quantity of these soluble peptides increases as the cheese ripens and is commonly used as an index of ripening of cheese. Several solvent systems that have been used to extract peptides are described below but the ones most commonly used are water, buffers at or near pH 4.6 or fractionation using trichloroacetic acid (TCA), although some authors have used extractants such as solutions containing salts, urea, organic solvents, and other compounds.

Extraction of cheese with water efficiently separates the small peptides from the proteins and large peptides; in terms of nitrogenous compounds, the water-soluble extract (WSE) of Cheddar cheese contains mainly small- and medium-sized peptides, free amino acids, and their salts. The level of water-soluble nitrogen (WSN) is a very commonly used index for cheese ripening [1,10,14,15].

Kuchroo and Fox [16] compared various extraction procedures for Cheddar cheese. All but one of several homogenization techniques yielded essentially similar results; a stomacher was used for routine work. Although the extractable N was not affected much by the homogenization temperature (in the range 5°C–40°C), it increased with the ratio of water to cheese. A ratio of 2:1 was recommended and 90% of the potentially water-extractable N was obtained in two extractions. The procedure recommended by Kuchroo and Fox [16] or similar procedures have been used widely [17–21].

Studies on cheese with a controlled microflora and studies which investigated peptides in this fraction have shown that the residual coagulant and, to a lesser extent, plasmin is responsible for the production of most of the WSN [7,22,23]. WSN as a percentage of total N varies with cheese variety and increases throughout ripening. A serious drawback of WSN as an index of proteolysis is that this parameter varies with pH; the higher the pH above the isoelectric point of the caseins (pH 4.6) the more N that is soluble in water, irrespective of the extent of proteolysis. WSN is thus a valid index of proteolysis only when there is no variation in pH during ripening or between samples. Hence, we recommend that pH 4.6-soluble N (see below) be used as an index of primary proteolysis in preference to WSN.

Measurement of pH 4.6-soluble N in cheese is another widely used index of proteolysis. According to Kuchroo and Fox [16], this method gives slightly lower values for soluble N than extraction with water and, although marginally more difficult to perform, it is easier to standardize [3]. There is little difference between levels of N soluble in water or in pH 4.6 buffers for internal bacterially ripened cheeses like Cheddar or Swiss [16]. For cheeses characterized by a significant

increase in pH during ripening, such as mould and bacterial surface-ripened varieties, WSN may be far higher than pH 4.6-soluble N. Like WSN, pH 4.6-soluble N is produced mainly by the activity of rennet [24] and increases during cheese ripening.

TCA is a classical protein/peptide precipitant and TCA at concentrations ranging from 2%, 2.5%, or 3% [16,25–28] to 12% [14,21,29–32] have been used to precipitate peptides from usually a water, or pH 4.6-soluble extract of cheese. The choice of concentration depends on the degree of fractionation required; the larger peptides are soluble at lower concentrations. Although rennet is responsible for the production of some of the 12% TCA-soluble N, starter proteinases and peptidases make a substantial contribution [24,33]. Typically, in mature Cheddar cheese about 15% of the total N [25] and ~90% of the WSN [26] is soluble in 2.5% TCA; while 50%–60% of an ultrafiltration (UF) retentate obtained using a 10 kDa membrane and 100% of the UF permeate [27] is soluble in 2% TCA. Polychroniadou et al. [34] studied the effect of time, temperature, and extraction method of the TCA-soluble N in three Greek cheeses, Feta, Graviera, and Kefalotyri. It was reported that the time and the temperature of extraction had little effect on TCA-soluble N; the amount and type of peptides extracted varied significantly with cheese to water ratio, pH of the extract, nature of the solvent (water or citrate buffer pH 7.0), and the NaCl content of the cheese.

The major disadvantage of using TCA for fractionation of cheese N is the difficulty in removing it prior to further analysis of the fractions [3,14]. While this is not a problem if all that is desired is the level of N soluble in a particular concentration of TCA, but it is a serious drawback if it is necessary to study these peptides further. Therefore, the use of 70% ethanol, which gives similar precipitation levels, is sometimes preferable because ethanol can be readily evaporated [3].

The large oligopeptides which are insoluble in many other solvents (e.g., water) can be fractionated or solubilized using urea. All the proteins and polypeptides in cheese are soluble in 4–6 M urea. Hence, urea has been used primarily to solubilize cheese samples prior to analysis by chromatography and electrophoresis [14].

Chloroform and methanol in the ratio 2:1 (v/v) were used to extract bitter and astringent peptides from freeze-dried cheese [35]. This method has been used to subfractionate different fractions of cheese by several authors [36–41]. McGugan et al. [42] used methylene chloride, methanol, and water in the ratio 10:10:1 (v/v) to extract centrifugally defatted Cheddar cheese. This extraction procedure was also used by Smith and Nakai [43]. Fractionation of proteins and peptides by ethanol has been used extensively to fractionate peptides in cheese [13,15,16,25,26,44–52]. The concentration of ethanol has been varied from 30% to 80% [14]. However, 70% ethanol has been used most widely. Although TCA (12%) and 70% ethanol had approximately similar extraction levels [25], and TCA (12%) or 70% ethanol-soluble fractions gave similar patterns on high-voltage paper electrophoresis, differences were detected in the insoluble fractions [44].

There are very few references to the use of trifluoroacetic acid (TFA) in the fractionation of cheese. Bican and Spahni [53,54] used a buffer containing TFA (1%, v/v)/formic acid (5%, v/v), 1% (v/v) NaCl, and 1 M HCl as an extractant for Appenzeller cheese. The mechanism of protein precipitation using TFA is similar to that of using TCA, but TFA can be evaporated from the fractions far easily than TCA. Hence TFA may be a useful alternative to TCA as a precipitant or extractant for cheese peptides.

The samples for analysis of free amino acids must be free from peptides and hence more discriminating precipitants are commonly used to precipitate the peptides from the cheese extracts. Phosphotungstic acid (PTA) is a very discriminating protein precipitant. Only free amino acids, except lysine and arginine, and peptides less than about 600 Da are soluble in 5% PTA [55]. Nitrogen soluble in 1%, 2.5%, 5%, 6%, or 6.5% PTA has been used widely as an index of free

amino acids in cheese [21,29,32,56–61]. The most widely used PTA concentration is 5%. The PTA-soluble peptides of some cheese varieties have been studied [53,55,62]. Treatment with 3% or 6.25% sulfosalicylic acid (SSA) has been used to analyze amino acids in water-soluble fractions of cheese [33,63–65] or as an index of amino acid N [66]. Only 10% of the WSN is precipitated using 2.5% SSA [16]. The water-soluble peptides in the fractions obtained with SSA have not been characterized [46]. Picric acid is also a very discriminating protein precipitant [3]. Finally, Hickey et al. [67] extracted free amino acids from Cheddar cheese using 0.15 M Ba(OH)<sub>2</sub> and 0.14 M ZnSO<sub>4</sub>. No data were presented on extraction levels or whether peptides were soluble. This reagent has not been used widely to fractionate cheese N or in the preparation of samples for amino acid analysis.

Solutions containing CaCl<sub>2</sub> have been used as the primary extractant or as a method of sub-fractionation of WSN [22,28,57,68–70]. The extracts contain whey proteins, peptides, and amino acids, while the CaCl<sub>2</sub>-insoluble fraction contains caseins and large peptides, similar to those in the water-insoluble fraction [46]. Although the increase in CaCl<sub>2</sub>-soluble N correlates with the age of cheese, Kuchroo and Fox [16] found that only 40% of the WSN was soluble in 0.1 M CaCl<sub>2</sub>. Increasing the concentration of CaCl<sub>2</sub> above 0.05% at or above pH 7.0 has little influence on extractability [69]. CaCl<sub>2</sub> is now used less commonly as an extractant.

Five percent (5%) NaCl solution has been used to fractionate cheese N [71,72]. Reville and Fox [25] reported that >90% of the total N of a mature Cheddar cheese was soluble in 5% NaCl, which was thus not sufficiently discriminating, except perhaps for very young cheeses. NaCl (5%)-soluble N and unfractionated cheese are indistinguishable electrophoretically, suggesting that the parent caseins are extracted as well as the peptides [1,53]. Inclusion of CaCl<sub>2</sub> in the NaCl solution reduces the percentage N extracted [3].

BaCl<sub>2</sub> (10–50 mM) can be used to precipitate phosphopeptides (or other peptides with a high negative charge) from a water extract of cheese while 0.1 M ethylenediaminetetraacetic acid (EDTA) precipitates approximately 30% of the water-soluble N. Chitosan has also been used to fractionate effectively the water-soluble peptides of Cheddar cheese [14].

### 19.3 Expression of the Aqueous Phase of Cheese

The aqueous phase of cheese (cheese juice) can be expressed by subjecting a cheese/sand mixture to hydraulic pressure (e.g., ~30 MPa). Although the method is slow and tedious and special equipment is required, it has the advantage of not altering the ionic composition of the aqueous phase of cheese. Guo and Kindstedt [73] had prepared the aqueous fraction of Mozzarella by using centrifugation at 12,500 *g* for 75 min at 25°C instead of hydraulic pressure. The expression of “cheese juice” by hydraulic pressure or centrifugal force is of particular use when studying the ratio of soluble to casein-bound calcium in cheese, its buffering capacity, and starter cell autolysis in cheese [74–85].

### 19.4 Fractionation of Peptides Based on Molecular Mass

As an alternative to techniques based on peptide solubility in various reagents, peptides can also be fractionated by using techniques based on their molecular mass, e.g., dialysis, UF, and size-exclusion chromatography. These techniques allow fractionation of large sample sizes and do not require solvents, which facilitate taste panel work [3].

Several authors have used dialysis as a simple and effective method to fractionate the peptides in the water-soluble fraction or in unfractionated, grated cheese dispersed in water [14]. Dialysis has been superseded by UF which is faster, capable of handling larger samples, uses membranes of known molecular mass cut-off, and reduces the problem of recovering peptides from a large volume of dilute sample. Diafiltration can be used to improve the resolution further. Membranes with nominal molecular weight cut-offs in the range 500–10,000 Da have been used to fractionate peptides [27,53,86–91]. Potential limitations in the use of UF are rejection of hydrophobic peptides by UF membranes and aggregation (and thus retention) of small peptides.

## 19.5 Methods Based on the Liberation of Reactive Compounds or Groups

Most of the nonspecific methods for assessing proteolysis in cheese are time consuming and therefore there has always been a demand for rapid methods for assessing cheese maturity [92]. Several methods have been developed to estimate proteolysis rapidly, as described below.

During cheese ripening, ammonia is produced by deamination of free amino acids and this contributes to characteristic flavor and texture in certain cheese varieties (e.g., Camembert or smear-ripened varieties [7]). Production of ammonia during cheese ripening has been monitored indirectly by measuring the increase in the pH of cheeses [93–95] and directly by measuring the reaction of ammonium salts with the Nessler reagent [96] or by isothermal distillation [97–99]. An enzymatic assay for ammonia is also available [14].

After a preliminary fractionation (e.g., preparation of a water, or TCA, soluble extract) aromatic amino acid residues can be quantified by using Folin and Ciocalteu's reagent or by measuring absorbance at 280 nm [14], although these methods are now obsolete.

Proteins have a net positive charge at pH values below their isoelectric point and thus can interact with anionic dyes; dye-binding methods have been used in the past as indices of proteolysis [14], but are now rarely used. Bradford [100] proposed a method for protein determination based on the color change in Coomassie Blue G250 when it interacts with proteins. Wallace and Fox [101] studied the potential use of this method in quantifying water-soluble peptides and found that the coefficient of variation for this method was unacceptably high.

The formol titration is a simple method for estimating amino groups in milk and has been used to measure the extent and rate of proteolysis [14]; however, it is now considered obsolete owing to difficulties caused by variations in the buffering capacity of cheese [92]. To assess proteolysis in a Swiss-type cheese, the increase in the buffering capacity of cheese during ripening was measured [102]; it was claimed that the method is rapid and convenient and as accurate as colorimetric methods. Lucey et al. [76] attributed the changes in the buffering capacity of Emmental cheese around pH 9 to proteolysis.

## 19.6 Colorimetric and Fluorimetric Methods for Free Amino Acids

Reagents which react with free amino groups have been used to develop a number of colorimetric and fluorimetric techniques to assay proteolysis in cheese. Satake et al. [103] introduced one such reagent, 2,4,6-trinitrobenzenesulfonic acid (TNBS), which reacts stoichiometrically with primary amines, producing a chromophore which remains attached to the amino acid, peptide, or

protein and absorbs maximally at 420 nm. Since then several authors have used TNBS method to assess proteolysis in cheese [11,37,50,104–108]. Clegg et al. [109] reported that since ammoniacal nitrogen produces only 20% of the absorbance of amino groups when it reacts in equimolar concentrations with TNBS, this reagent might underestimate proteolysis in cheeses which have undergone significant deamination. Clegg et al. [109] concluded that TNBS is not as sensitive as ninhydrin for assaying proteolysis in cheese but is preferable owing to the simple analytical procedure; they proposed a correction factor for ammoniacal nitrogen. Another disadvantage of the TNBS method is that the dry powder is explosive and prolonged storage leads to high blank values [92].

Ninhydrin is another reagent which reacts with free amino groups and forms a purple chromophore which is then measured spectrophotometrically. The levels of proteolysis found by ninhydrin assays are consistently higher than those found by the TNBS procedure because ninhydrin reacts with ammonia almost as readily as it reacts with amino groups [109]. Several ninhydrin reagents, e.g., Li- or Cd-ninhydrin, have been used by authors to develop assays for assessing proteolysis in cheese [110–116]. The Cd-ninhydrin reagent was found to be more selective for the amino group of free amino acids than the amino groups of peptides or proteins and was the most sensitive of several ninhydrin reagents, including Sn-ninhydrin. Hence, the Cd-ninhydrin assay of Doi et al. [113] has been used by several authors to assess the proteolysis in cheese [29,117–121].

Fluorescamine (4-phenylspiro [furan-2 (3H), 1'-phthalan]-3,3'-dione), introduced by Weigele et al. [122], reacts with primary amino groups to produce a fluorophor which is assayed at 390 nm excitation and 475 nm emission. It has been used to study the hydrolysis of  $\kappa$ -casein and to quantify acid-soluble proteins, peptides, and amino acids from cheese [14]. *o*-Phthaldialdehyde (OPA) reacts with  $\beta$ -mercaptoethanol and primary amines to form a fluorescent complex (1-alkylthio-2-alkylisoindole). OPA has been used to quantify proteolysis in milk protein systems and to study proteolysis in cheese [14,123–126]. Fluorimetric techniques are more sensitive than the colorimetric techniques described above but have not been used as widely.

## 19.7 Electrophoresis

Although the above nonspecific techniques can provide valuable information about the extent of proteolysis and the extent of the activity of certain proteolytic agents, they provide little detail as to which peptides accumulate or are degraded during ripening. For this reason techniques which resolve individual peptides are also usually used as parts of schemes for studying proteolysis in cheese during ripening.

Electrophoresis has been used widely to study primary proteolysis in cheese. Since only proteins and large peptides can be visualized by staining, the technique is limited to monitoring hydrolysis of the parent caseins and the formation and subsequent hydrolysis of the primary proteolytic products of caseins. However, it is a powerful technique for studying proteolysis during the early stages of cheese ripening.

Several different methods of electrophoresis have been applied to study cheese ripening. Early methods included paper electrophoresis, free boundary electrophoresis, high-voltage paper electrophoresis, and starch gel electrophoresis [14] and are now generally obsolete. Isoelectric focusing has been also used to study proteolysis in cheese [127–136]. However, polyacrylamide gel electrophoresis (PAGE), first applied to cheese by Ledford et al. [137], has found the most widespread application and is now used most commonly. The literature on electrophoresis of cheese peptides has been extensively reviewed [3,13–15,134,136,138].

Nearly all one-dimensional (1D) electrophoretic techniques that are now used for the analysis of cheese involve discontinuous buffer systems containing urea or sodium dodecylsulfate (SDS) as a dissociating agent. Shalabi and Fox [138] compared several electrophoretic procedures for the analysis of cheese and strongly recommended the stacking gel system of Andrews [139] in alkaline (pH 8.9) gels containing 6M urea and the direct staining procedure of Blakesley and Boezi [140] with Coomassie Blue G250. This method has been used by several authors to study the ripening in various cheese varieties [47,49–51,141,142]. The peptides in a 10kDa UF permeate do not stain with Coomassie Blue on urea-PAGE, but the retentate of the WSN, the 2% TCA-soluble and insoluble fractions of the retentate contain several detectable peptides [27]. Low-molecular mass peptides can be visualized using a silver staining technique incorporating extensive glutaraldehyde fixing although such stains have not been widely used to study cheese peptides.

Electrophoresis in SDS-containing buffers is less widely used for cheese. Shalabi and Fox [138] concluded that SDS-PAGE was inferior to urea-PAGE for cheese analysis because all the caseins have similar molecular weights (20–25kDa) and they are not as well resolved by SDS-PAGE as in alkaline urea-containing gels. However, Creamer [134] and Strange et al. [136] considered that SDS-PAGE provides valuable information on cheese ripening and it has been used by a number of authors [14].

Two-dimensional electrophoresis has been used by some authors. Trieu-Cuot and Gripon [127] used SDS-PAGE in one dimension and isoelectric focusing in the other to study proteolysis in Camembert cheese. Bican and Spahni [53] separated peptides in extracts from Appenzeller cheese by thin-layer chromatography (TLC) in one dimension followed by electrophoresis in the other.

After staining, gel electrophoretograms are usually now digitized by scanning on a flat-bed scanner, although densitometry or excision and elution of the stained bands, followed by spectrophotometric quantitation, have also been used [134]. The peptides resolved on PAGE gels can be isolated and identified by excision of the bands or by electroblotting. Because of higher recoveries of protein and because PAGE gels can change size on staining, which makes accurate excision of unstained regions difficult, the latter technique is preferable. Electroblotted peptides can be identified by N-terminal amino acid sequencing, but they are difficult to analyze by mass spectrometry (MS) because they must not be stained prior to MS and must be eluted from the blotting matrix. However, the location of all the casein fractions and some major degradation products (e.g.,  $\gamma$ -caseins and  $\alpha_{s1}$ -CN f24-199) is known on most PAGE systems [134,136]. The majority of the peptides in a urea-PAGE electrophoretogram of a Cheddar cheese have been partially identified [143].

Capillary electrophoresis (CE) is reported to have great potential for the resolution of complex mixtures of peptides. CE resolves peptides in a buffer-filled capillary under the influence of an electric field on the basis of the net charge on the peptides, their mass, and Stokes' radius [144] and has a number of advantages over HPLC [145–147]. The potential of this technique for isolating peptides derived from the caseins was demonstrated by Zeece [145]. To date, CE has had relatively limited use to characterize proteolysis in cheese [61,148–150].

## 19.8 Chromatographic Methods to Assess Proteolysis in Cheese

Paper chromatography (PC) and TLC on silica gel, using different solvents, have been used to characterize peptides in cheese fractions [14] but these chromatographic techniques are not now widely used and have been superseded by techniques for separating peptides which yield better resolution, particularly HPLC. Likewise, column chromatographies on silica gels, metal chelating media, on the cation-exchanger Dowex 50, or on hydrophobic interaction media have been used to fractionate cheese peptides in the past [14].

When a gel-permeation column has been calibrated, molecular weights may be estimated and this technique has been applied to cheese or high-molecular weight peptides derived therefrom or various WSEs [14]. More recently, low-pressure, preparative high-performance liquid chromatographic techniques on gel-permeation media have simplified this form of chromatography and have been used for the characterization of peptides in various fractions obtained from Cheddar or Gouda [56,151–155]. High performance gel permeation chromatography (HPGPC) has also been used to characterize caseins, whey proteins, and peptides derived therefrom [14].

Ion-exchange chromatography is used widely to fractionate milk proteins but has not been used as widely to study peptides from cheese [3]. Anion-exchange chromatography on diethylaminoethyl (DEAE) cellulose has been used to isolate  $\alpha_{s1}$ -CN (f24-199) from Cheddar [156] and to fractionate the water-insoluble peptides [143,157] and the 2% TCA-soluble and -insoluble fractions of a 10 kDa UF retentate of a WSE of Cheddar cheese [27]. High-performance ion-exchange columns give better resolution of bovine milk proteins than classical chromatography on DEAE-cellulose [151,158,159]. Urea-containing buffers have usually been used to disperse cheese prior to chromatography and chromatograms are read by measurement of  $A_{280}$ , although ninhydrin has been used by some workers [15].

It is our experience that anion-exchange chromatography on DEAE cellulose or equivalent high-performance media in urea-containing buffers is very suitable for the fractionation of large casein-derived peptides. Fractions from the anion-exchange chromatogram can be collected and further analyzed by urea-PAGE. The introduction of high-performance ion-exchange chromatography (HPIEC) and HPGPC has greatly reduced the work-load involved in these forms of column chromatography, while increasing speed and reproducibility.

RP-HPLC has been used extensively to characterize peptides in casein hydrolysates [160,161] and the technique is also of great use for the separation of shorter peptides from cheese. WSEs have been used most widely for RP-HPLC analysis [62,66] but other fractions studied have included pH 4.6-soluble and -insoluble extracts [162,163], 10 kDa UF permeate [89], 70% ethanol-soluble and -insoluble fractions [49–51,95,141,142], and fractions from gel-permeation chromatography [164].

Most commonly gradient elution with solvent systems containing water/acetonitrile or occasionally water/methanol [164] have been used, but isocratic conditions using a phosphate buffer has also been used by some workers [165]. TFA is the most widely used ion-pair reagent. Detection is generally by UV spectrophotometry, usually at a wavelength in the range 200–230 nm (which measures the carbonyl group in the peptide bond), although 280 nm has been used in cases where larger peptides, which are more likely to contain aromatic residues, are expected [163]. Fluorescence detection has also found limited use [62].

Two-dimensional HPLC (2D-HPLC) has been used to fractionate the peptides in a WSE of Cheddar cheese [166]. The eluent from the first dimension (ion-exchange) was directed to a reverse-phase column (C18). The resolution obtained was impressive although increased equipment requirements and long analysis times (~10 h) has militated against 2D-HPLC becoming widely used.

## 19.9 Matrix-Assisted Laser Desorption/Ionization Time-of-Flight Mass Spectrometry to Study Proteolysis in Cheese

Nonspecific methods for assessing proteolysis (e.g., liberation of reactive groups or levels of N soluble in a particular extractant) provide very useful information about the extent of proteolysis

and the proteolytic agents involved, but do not provide the number, the identity, and the amount of peptides characterizing the patterns of proteolysis in a given variety of cheese. Such information provides an insight into the complex process of proteolysis occurring in cheese and is essential to understand casein degradation mechanisms during ripening.

Several methods have been developed to profile cheese at the peptide level. The use of separation techniques such as electrophoresis or chromatography in combination with multivariate statistical analysis (e.g., principal component analysis [PCA], discriminant analysis, principal component similarity analysis) has emerged as a powerful tool to improve the understanding of proteolysis in cheese [167–171], and is still used for descriptive purposes [52,141,172]. However, such separation techniques, while providing complex patterns of proteolysis and thus characterizing proteolysis in some extent, suffer from low resolution and do not permit identification (i.e., peptides are unknown and not always resolved in the profile), so that the interpretation of the patterns of proteolysis and agents responsible can be difficult.

During the early 1980s, mass spectrometric techniques, and in particular matrix-assisted laser desorption/ionization time-of-flight mass spectrometry (MALDI-ToF-MS) emerged for the analysis of large biomolecules, including food proteins [173]. Such technology is characterized by sample ionization without fragmentation. Peptide ions are generated by laser excitation of the analyte/matrix crystals and accelerated to travel through a flight tube. They approach the ion detector at different time points that correspond to their specific mass-to-charge ratio ( $m/z$ ), with low mass ions “traveling” at higher speed compared to higher mass ions [174]. MALDI technology provides accurate mass determination, and picomole to femtomole sensitivity [175]. Unlike other mass spectrometric techniques, MALDI-ToF-MS can be used in the presence of salts and other buffer components [173], a property that makes MALDI-ToF-MS a powerful tool for the study of proteolysis.

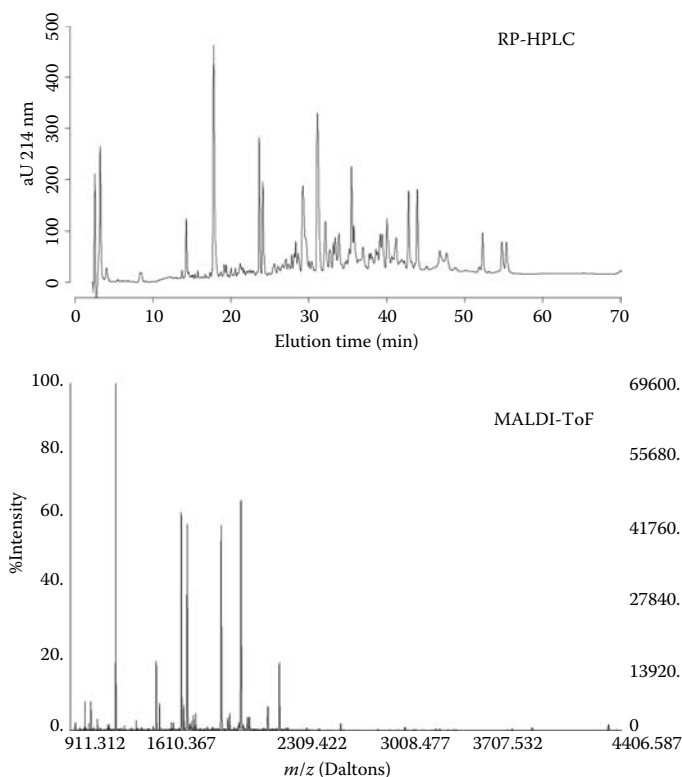
Numerous studies have been performed on milk proteins using MALDI-ToF-MS, including identification of milk protein variants, analysis of structural modifications in milk proteins, and studies of glycoforms and degree of glycosylation [176–183]. MALDI-ToF-MS has been employed as a technique for characterizing water buffalo milk and to detect adulteration, with bovine milk, of buffalo milk that is used for the manufacture of Mozzarella cheese [184,185]. The technique has also been used to detect the presence of cows’ milk in ewes’ or buffaloes’ milk and powdered milk in fresh raw milk [177,186] and to determine proteolysis in yoghurt caused by strains of *Lactobacillus delbrueckii* ssp. *bulgaricus* and *Streptococcus thermophilus* [187]. Recently, Wedholm et al. [188] used MALDI-ToF-MS to identify peptides actually present in milk as a result of proteolysis at different levels of somatic cell count, and in some cases was possible to assign these peptides to potential responsible proteases. MALDI-ToF-MS has been employed to identify peptides from Cheddar cheese separated by RP-HPLC [189,190] and to quantify the bitter peptide  $\beta$ -CN (f193–209) in Queso Fresco cheese [191], to correlate the concentration of  $\beta$ -CN (f193–209) with bitterness in Cheddar cheese [192], and to differentiate peptidase activities of starter and adjunct cultures on  $\beta$ -CN (f193–209) under simulated cheese-like conditions [193]. Patterns of proteolysis as output from MALDI-ToF technology were used to study miniature Cheddar-type cheeses manufactured using enzymes extracted from the crustacean *Munida* or chymosin as coagulant [194]. The study explicated the complexity of the products of proteolysis found in cheese made using the *Munida* extracts compared to the pattern of proteolysis found in cheese made by chymosin as coagulant, and with the aid of multivariate statistical analysis the results discriminated the cheeses on the basis of coagulant used, as well as, on the basis of ripening time.



## 19.10 Chemometric Analysis of Peptide Profiles from HPLC or MALDI-ToF Technology

Chromatographic or MS-based profiling of peptides has promising potential to elucidate the complex process of proteolysis in a biological sample containing proteins and proteolytic agents. In a typical experiment for the assessment of cheese proteolysis, extracts are obtained from cheese sampled at different time points and analyzed by chromatography and/or MS. The collection of such complex peptide profiles leads to a large amount of data, which requires suitable data analysis tools in order to extract and interpret the relevant information.

With regard to cheese profiling using HPLC or MS instruments, the relevant information of a profile is carried by peaks, as peak intensity (height, area, or other parameters), associated with peptide concentration, and as peak position (elution time for chromatograms or mass for mass spectra), associated with peptide identity. Figure 19.1 shows examples of HPLC and MALDI-ToF profiles obtained from cheese extracts. Peptide profiles can show from a few up to hundreds of peaks. Peaks are detected after profile calibration and baseline subtraction, and such steps are



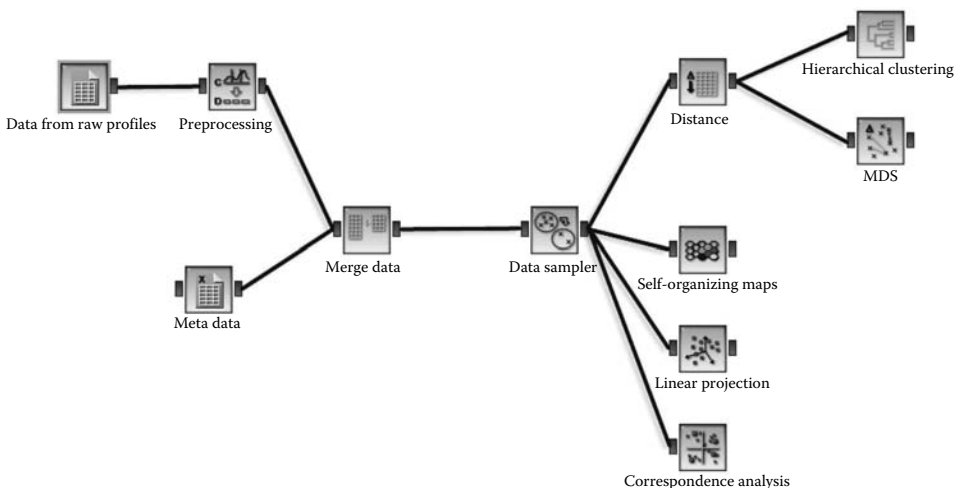
**Figure 19.1** Examples of peptide profiles obtained from a Cheddar cheese extract. RP-HPLC profile of the water soluble fraction (top) and MALDI-ToF mass spectrometry profile of a RP-HPLC fraction eluting from 28 to 36 min.

generally performed using software and tools provided together with the instruments. However, it is also common to download raw data from the instrument (e.g., as TXT or ASCII files) and use other programs to process data files (a collection of free software for data preprocessing is available from the R-project repository, R Development Core Team, 2005).

Once profiles have been properly processed and peaks have been extracted, the resulting data is converted by visual peak matching and normalization procedures into a matrix which is suitable for statistical analysis. For complex profiles, instead of visual peak matching, which could be inaccurate and time consuming, other alternatives have been employed, such as the use of a logistic function [195].

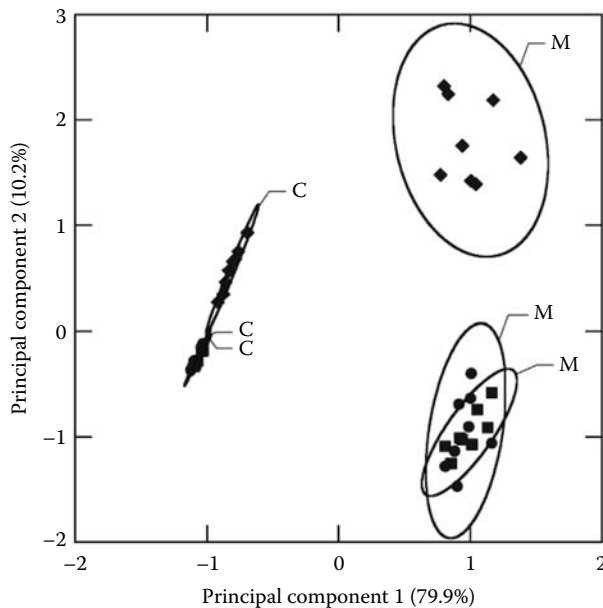
Statisticians can play an important role in data mining to attempt to evaluate reliably the associations of peptide patterns with given proteolytic events. This involves the selection of relevant peaks, statistical model building, and comprehensive evaluation of sources of systematic and random error. Statistical analyses to address key hypotheses should be specified in the study protocol; however, exploratory approaches may allow one to formulate important new hypotheses and may lead to further experiments and improvements in experimental approach. To obtain a realistic assessment of exploratory findings it is advisable to perform resampling procedures, which are computer-intensive procedures that samples repeatedly from observed data to generate empirical estimates of results that would be expected by “chance” (bootstrapping and permutation tests are examples), thus giving statistical significance to results from descriptive techniques.

Figure 19.2 shows an example of workflow that could be used for chemometric analysis of peptide profiles obtained from cheese extracts. The profiles consisting of continuous raw data are processed and discrete peaks are obtained for the given number of samples. Such a matrix is merged with the information from the experimental design which is available for the same

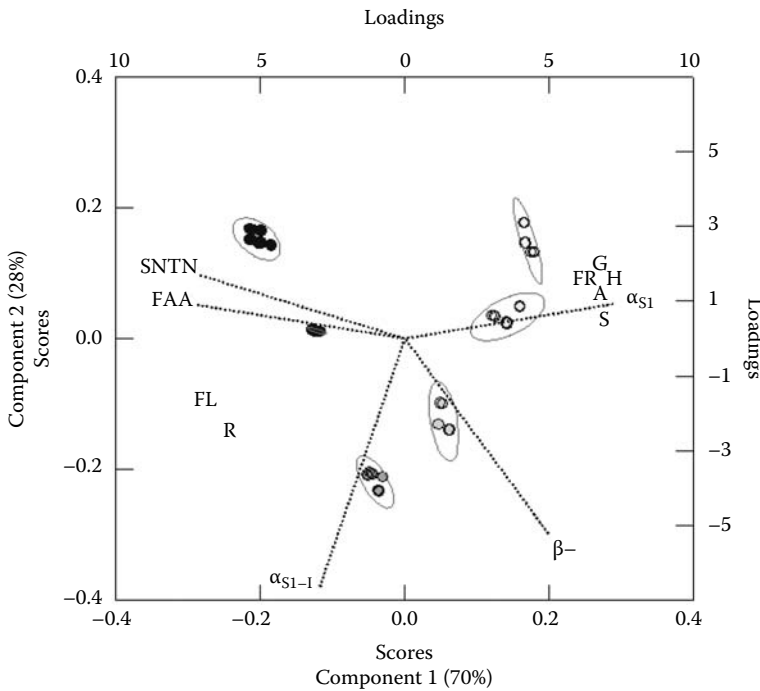


**Figure 19.2** An example of data analysis workflow for the analysis of cheese profiles obtained by HPLC or MALDI-ToF technology.

samples, and the merged data is then submitted to sampling procedures in order to perform and assess the significance of the subsequent statistical tests. Depending on the aim of the study, several statistical techniques could be applied to peptide profiles from cheese extracts, such as, clustering (e.g., hierarchical, self-organizing maps), projection methods (e.g., PCA, partial least square [PLS], correspondence analysis, multidimensional scaling), or multiple hypothesis testing. When PCA is performed, for instance, the delivered results are comparable to the one shown in Figure 19.3 [194]. Cheese samples can be differentiated into groups on the basis of their distance in a bidimensional space of two meaningful principal components. The use of confidence ellipses facilitates the interpretation of the statistical significance, while the analysis of the loadings elucidates the variables, in other words, the peaks, which are associated with each group. When a supervised analysis such as PLS is performed, the results are comparable to the ones shown in Figure 19.4 [141]. In addition to the characteristics described for PCA, PLS allows estimation of associations among variables in terms of multivariate regressions, thus allowing the association of peptide patterns with given proteolytic events and other related characteristics (e.g., textural, functional) to be discovered.



**Figure 19.3** Score plots obtained from PCA of MALDI-ToF profiles of the ethanol-soluble fractions of miniature Cheddar-type cheeses manufactured using chymosin (C) or *Munida* (M) proteinasas as coagulant, at 2 (◆), 6 (■), and 12 (●) weeks of ripening. Confidence ellipses (90%) enclosing the eight replicate profiles are also shown. (From Rossano, R. et al., *J. Biotechnol.*, 120, 220, 2005. With permission.)



**Figure 19.4** The plot of scores and loadings for the first two dimensions of the PLS model built using proteolysis data (free amino acids [FAA] pH 4.6-SN/TN [SNTN], band intensity of  $\alpha_{s1}$ -casein,  $\beta$ -casein, and  $\alpha_{s1}$ -casein [f24–199] [ $\alpha_{s1}$ -I]). Ellipses represent the 0.95% confidence interval for the replicate cheeses at each ripening time. Ripening time is expressed as gray scale from 7 (○) to 168 days (●). Loadings of the response variables are also shown on the same scale (flowability [FL], storage modulus [G], hardness [H], fracturability [FR], adhesiveness [A], and springiness [S]). (From Brickley, C.A. et al., *J. Food Sci.*, 72, C483, 2007. With permission.)

## References

1. Rank TC, Grappin R, and Olson NF (1985) Secondary proteolysis of cheese during ripening. A review. *J Dairy Sci* 68, 801–805.
2. Grappin R, Rank TC, and Olson NF (1985) Primary proteolysis of cheese proteins during ripening. *J. Dairy Sci* 68, 531–540.
3. Fox PF (1989) Proteolysis in cheese during manufacturing and ripening. *J Dairy Sci* 72, 1379–1400.
4. Fox PF and Law J (1991) Enzymology of cheese ripening. *Food Biotechnol* 5, 239–262.
5. Fox PF, Law J, McSweeney PLH, and Wallace J (1993) Biochemistry of cheese ripening, In *Cheese: Chemistry, Physics and Microbiology*, 2nd edn., Vol. 1 (Fox PF, ed.), Chapman & Hall, London, pp. 389–438.
6. Fox PF, Singh TK, and McSweeney PLH (1994) Proteolysis in cheese during ripening. In: *Biochemistry of Milk Products* (Andrews AT, and Varley J, eds.), Royal Society of Chemistry, Cambridge, pp. 1–31.

7. Fox PF, Singh TK, and McSweeney PLH (1995) Biogenesis of flavour compounds in cheese. In: *Chemistry of Structure/Function Relationships in Cheese* (Malin EL, and Tunick MH, eds.) Plenum Publishing Corp., New York, pp. 59–98.
8. Fox PF, O'Connor TP, McSweeney PLH, Guinee TP, and O'Brien NM (1996) Cheese: Physical, chemical, biochemical and nutritional aspects. *Adv Food Nutr Res* 39, 163–328.
9. Fox PF and McSweeney PLH (1996) Proteolysis in cheese during ripening. *Food Rev Int* 12, 457–509.
10. Sousa MJ, Ardö Y, and McSweeney PLH (2001) Advances in the study of proteolysis during cheese ripening. *Int Dairy J* 11, 327–345.
11. Upadhyay VK, Sousa MJ, Ravn P, Israelsen H, Kelly AL, and McSweeney PLH (2004) Use of exogenous streptokinase to accelerate proteolysis in Cheddar cheese during ripening. *Lait* 84, 527–538.
12. IDF (1991) Chemical methods for evaluating proteolysis in cheese maturation. Bulletin 261, International Dairy Federation, Brussels.
13. McSweeney PLH and Fox PF (1993) Cheese, methods of chemical analysis, In: *Cheese, Chemistry, Physics and Microbiology*, Vol. 1, General Aspects 2nd edn. (Fox PF, ed.), Chapman & Hall, London, pp. 341–388.
14. McSweeney PLH and Fox PF (1997) Chemical methods for the characterization of proteolysis in cheese during ripening. *Lait* 77, 41–76.
15. Fox PF, McSweeney PLH, and Singh TK (1995) Methods for assessing proteolysis in cheese during ripening, In: *Chemistry of Structure/Function Relationships in Cheese* (Malin EL, and Tunick MH, eds.) Plenum Publishing Corp., New York, pp. 161–194.
16. Kuchroo CN and Fox PF (1982) Soluble nitrogen in Cheddar cheese: Comparison of extraction procedures. *Milchwissenschaft* 37, 331–335.
17. Salles C, Septier C, Roudot-Algaron F, Guillot A, and Etiévant PX (1995) Sensory and chemical analysis of fractions obtained by gel permeation of water-soluble Comté cheese extracts. *J Agric Food Chem* 43, 1659–1668.
18. Taborda G, Gómez-Ruiz JA, Martínez-Castro I, Amigo L, Ramos M, and Molina E (2008) Taste and flavour of artisan and industrial Manchego cheese as influenced by the water-soluble extract compounds. *Eur Food Res Technol* 227, 323–330.
19. Taborda G, Molina E, Martínez-Castro I, Ramos M, and Amigo L (2003) Composition of the water-soluble fraction of different cheeses. *J Agric Food Chem* 51, 270–276.
20. Haque ZU, Kucukoner E, and Aryana KJ (2007) Influence of fat-replacing ingredients on process and age induced soluble nitrogen content and ultra structure of low fat Cheddar cheese. *Food Sci Technol Res* 13, 338–344.
21. Ong L and Shah NP (2008) Influence of probiotic *Lactobacillus acidophilus* and *L. helveticus* on proteolysis, organic acid profiles, and ACE-inhibitory activity of Cheddar cheeses ripened at 4, 8, and 12 degrees C. *J Food Sci* 73, M111–M120.
22. Visser FMW (1977) Contribution of enzymes from rennet, starter bacteria and milk to proteolysis and flavour development in Gouda cheese 3 Protein breakdown, analysis of the soluble nitrogen and amino acid fractions. *Neth Milk Dairy J* 31, 210–239.
23. Visser FMW and de Groot-Mostert AEA (1977) Contribution of enzymes from rennet, starter bacteria and milk to proteolysis and flavour development in Gouda cheese. 4. Protein breakdown: A gel electrophoretical study. *Neth. Milk Dairy J.* 31, 247–264.
24. O'Keeffe RB, Fox PF, and Daly C (1976) Contribution of rennet and starter proteases to proteolysis in Cheddar cheese. *J Dairy Res* 43, 97–107.
25. Reville WJ and Fox PF (1978) Soluble protein in Cheddar cheese, A comparison of analytical methods. *Irish J Food Sci Technol* 2, 67–76.
26. Kuchroo CN and Fox PF (1982) Fractionation of water-soluble nitrogen from Cheddar cheese, chemical methods. *Milchwissenschaft* 37, 651–653.
27. O'Sullivan M and Fox PF (1990) A scheme for partial fractionation of cheese peptides. *J Dairy Res* 57, 135–139.

28. Addeo F, Chianese L, Salzano A, Sacchi R, Cappuccio U, Ferranti P, and Malorni A (1992) Characterization of the 12% trichloroacetic acid-soluble oligopeptides of Parmigiano-Reggiano cheese. *J Dairy Res* 59, 401–411.
29. Katsiari MC, Alichanidis E, Voutsinas LP, and Roussis IG (2000) Proteolysis in reduced sodium Feta cheese made by partial replacement of NaCl with KCl. *Int Dairy J* 10, 635–646.
30. Pillonel L, Buetikofer U, Rossmann A, Tabacchi R, and Bosset JO (2004) Analytical methods for the detection of adulteration and mislabelling of Raclette Suisse(R) and Fontina PDO cheese. *Mitt Lebensm Unters Hyg* 95, 489–502.
31. Govindasamy-Lucey S, Jaeggi JJ, Johnson ME, Wang T, and Lucey JA (2007) Use of cold microfiltration retentates produced with polymeric membranes for standardization of milks for manufacture of pizza cheese. *J Dairy Sci* 90, 4552–4568.
32. Tarakci Z and Tunçtürk Y (2008) The effect of adjunct cultures on some chemical and biochemical properties of white-brined cheese. *J Food Biochem* 32, 490–505.
33. Reiter B, Sorokin Y, Pickering A, and Hall AJ (1969) Hydrolysis of fat and protein in small cheeses made under aseptic conditions. *J Dairy Res* 36, 65–76.
34. Polychroniadou A, Michaelidou A, and Paschaloudis N (1999) Effect of time, temperature and extraction method on the trichloroacetic acid-soluble nitrogen of cheese. *Int Dairy J* 9, 559–568.
35. Harwalkar VR, and Elliott JA (1971) Isolation of bitter and astringent fractions from Cheddar cheese. *J Dairy Sci* 54, 8–11.
36. Lemieux L, Puchades R, and Simard RE (1989) Size-exclusion HPLC separation of bitter and astringent fractions from Cheddar cheese made with added *Lactobacillus* strains to accelerate ripening. *J Food Sci* 54, 1234–1237.
37. Lemieux L, Puchades R, and Simard RE (1990) Free amino acids in Cheddar cheese, comparison of quantitation methods. *J Food Sci* 55, 1552–1554.
38. Puchades R, Lemieux L, and Simard RE (1989) Evolution of free amino acids during the ripening of Cheddar cheese containing added lactobacilli strains. *J Food Sci* 54, 885–888, 946.
39. Puchades R, Lemieux L, and Simard RE (1989) Sensitive, rapid and precise determination of L-glutamic acid in cheese using a flow injection system with immobilized enzyme column. *J Food Sci* 54, 423–426.
40. Puchades R, Lemieux L, and Simard RE (1990) Determination of free amino acids in cheese by flow injection analysis with an enzyme reactor and chemiluminescence detector. *J Food Sci* 55, 1555–1558, 1578.
41. Tieleman AE and Warthesen JJ (1991) Comparison of three extraction procedures to characterize Cheddar cheese proteolysis. *J Dairy Sci* 74, 3686–3694.
42. McGugan WA, Emmons DB, and Larmond E (1979) Influence of volatile and nonvolatile fractions on intensity of Cheddar cheese flavor. *J Dairy Sci* 62, 398–403.
43. Smith AM and Nakai S (1990) Classification of cheese varieties by multivariate analysis of HPLC profiles. *Can Inst Food Sci Technol J* 23, 53–58.
44. Kuchroo CN and Fox PF (1983) A fractionation scheme for the water-soluble nitrogen in Cheddar cheese. *Milchwissenschaft* 38, 389–391.
45. Abdel Baky AA, Abo Ella WM, Aly ME, and Fox PF (1987) Improving the quality of Ras-type cheese made from recombined milk containing high levels of total solids. *Food Chem* 26, 175–188.
46. Christensen TMIE, Bech A-M, and Werner H (1991) Methods for crude fractionation (extraction and precipitation) of nitrogen components in cheese. Bulletin 261, 4–9, International Dairy Federation, Brussels.
47. McGoldrick M and Fox PF (1999) Intervarietal comparison of proteolysis in commercial cheese. *Zeitschrift für lebensmittel-untersuchung und-forschung A-Food Res Technol* 208, 90–99.
48. Hynes E, Ogier JC, and Delacroix-Buchet A (2001) Proteolysis during ripening of miniature washed-curd cheeses manufactured with different strains of starter bacteria and a *Lactobacillus plantarum* adjunct culture. *Int Dairy J* 11, 587–597.

49. O'Mahony JA, Sousa MJ, and McSweeney PLH (2003) Proteolysis in miniature Cheddar-type cheeses made using blends of chymosin and *Cynara cardunculus* proteinases as coagulant. *Int J Dairy Technol* 56, 52–58.
50. O'Mahony JA, Lucey JA, and McSweeney PLH (2005) Chymosin-mediated proteolysis, calcium solubilisation, and texture development during the ripening of Cheddar cheese. *J Dairy Sci* 88, 3101–3114.
51. de Candia S, De Angelis M, Dunlea E, Minervini F, McSweeney PLH, Faccia M, and Gobbetti M (2007) Molecular identification and typing of natural whey starter cultures and microbiological and compositional properties of related traditional Mozzarella cheeses. *Int J Food Micro* 119, 182–191.
52. Piraino P, Upadhyay VK, Rossano R, Riccio P, Parente E, Kelly AL, and McSweeney PLH (2007) Use of mass spectrometry to characterize proteolysis in cheese. *Food Chem* 101, 964–972.
53. Bican P and Spahni A (1991) Low molecular mass nitrogen components in ripening cheese. *Lebensm-Wiss Technol* 24, 315–322.
54. Bican P and Spahni A (1993) Proteolysis in Swiss-type cheeses: A high performance liquid chromatographic study. *Int Dairy J* 3, 73–84.
55. Jarrett WD, Aston JW, and Dullely JR (1982) A simple method for estimating free amino acids in Cheddar cheese. *Aust J Dairy Technol* 37, 55–58 (corrected 1983, 38).
56. Wilkinson MG, Guinee TP, O'Callaghan DM, and Fox PF (1992) Effect of commercial enzymes on proteolysis and ripening in Cheddar cheese. *Lait* 72, 449–459.
57. Bütikofer U, Ruegg M, and Ardo Y (1993) Determination of nitrogen fractions in cheese, evaluation of a collaborative study. *Lebensm Wiss u Technol* 26, 271–275.
58. Picon A, Gaya P, Medina M, and Nuñez M (1994) The effect of liposome encapsulation of chymosin derived by fermentation on Manchego cheese ripening. *J Dairy Sci* 77, 16–23.
59. Guinee TP, Pudja PD, Reville WJ, Harrington D, Mulholland EO, Cotter M, and Cogan TM (1995) Composition, microstructure and maturation of semi-hard cheeses from high protein ultrafiltered milk retentates with different levels of denatured whey proteins. *Int Dairy J* 5, 543–568.
60. Folkertsma B, Fox PF, and McSweeney PLH (1996) Accelerated ripening of Cheddar cheese at elevated temperatures. *Int Dairy J* 6, 1117–1134.
61. Roseiro LB, Garcia-Risco M, Barbosa M, Ames JM, and Wilbey RA (2003) Evaluation of Sepra cheese proteolysis by nitrogen content and capillary zone electrophoresis. *Int J Dairy Technol* 56, 99–104.
62. González de Llano D, Polo C, and Ramos M (1991) Production, isolation and identification of low molecular mass peptides from Blue cheese by high performance liquid chromatography. *J Dairy Res* 58, 363–372.
63. Ramos M, Caceres I, Polo C, Alonso L, and Juarez M (1987) Effect of freezing on soluble nitrogen fraction of Cabrales cheese. *Food Chem* 24, 271–278.
64. Izawa N, Izumi T, and Hayashi K (1998) Accelerated ripening of Gouda cheese using *Aeromonas* aminopeptidase and neurase. *Nippon Shokuhin Kogaku Kaishi* 45, 114–121.
65. Mendia C, Ibanez FC, Torre P, and Barcina Y (2000) Influence of the season on proteolysis and sensory characteristics of Idiazabal cheese. *J Dairy Sci* 83, 1899–1904.
66. Cliffe AJ and Law BA (1991) A time course study of peptide production in accelerated-ripened Cheddar cheese using reverse phase high performance liquid chromatography. *Food Biotechnol* 5, 1–17.
67. Hickey MW, van Leeuwen H, Hillier AJ, and Jago GR (1983) Amino acid accumulation in Cheddar cheese manufactured from normal and ultrafiltered milk. *Aust J Dairy Technol* 38, 110–113.
68. Noomen A (1977) Noordhollandse Meshanger cheese, a novel method for research on cheese ripening. 2. The ripening of the cheese. *Neth Milk Dairy J* 31, 75–102.
69. Noomen A (1977) A rapid method for the estimation of the dissolved and the undissolved nitrogen compounds in cheese. *Neth Milk Dairy J* 31, 163–176.
70. Lau KY, Barbano DM, and Rasmussen RR (1991) Influence of pasteurization on protein breakdown in Cheddar cheese during aging. *J Dairy Sci* 74, 727–740.

71. Chakravorty SC, Srinivasan RA, Babbar IJ, Dudani AT, Burde SD, and Iya KK (1966) Comparative study of proteolysis during ripening of Cheddar cheese by bacterial milk clotting enzymes and rennet extract. *Proceedings of the 17th International Dairy Congress (Munich) D*, Germany, pp. 187–198.
72. Gupta SK, Whitney RM, and Tuckey SL (1974) Brine soluble protein of Cheddar and Gouda cheese. *J Dairy Sci* 57, 540–544.
73. Guo MR and Kindstedt PS (1995) Age-related changes in the water-phase of Mozzarella cheese. *J Dairy Sci* 78, 2099–2107.
74. Mabbitt LA (1955) Quantitative estimation of the amino acids in Cheddar cheese and their importance in flavour. *J Dairy Res* 22, 224–231.
75. Morris HA, Holt C, Brooker BE, Banks JM, and Manson W (1988) Inorganic constituents of cheese, analysis of juice from a one month old Cheddar cheese and the use of light and electron microscopy to characterize the crystalline phases. *J Dairy Res* 55, 255–268.
76. Lucey JA, Gorry C, and Fox PF (1993) Changes in the acid-base buffering curves during the ripening of Emmental cheese. *Milchwissenschaft* 48, 183–186.
77. Wilkinson MG, Guinee TP, O’Callaghan DM, and Fox PF (1994) Autolysis and proteolysis in different strains of starter bacteria during Cheddar cheese ripening. *J Dairy Res* 61, 249–262.
78. Boutrou R, Gaucheron F, Piot M, Michel F, Maubois J-L, and Léonil J (1999) Changes in the composition of juice expressed from Camembert cheese during ripening. *Lait* 79, 503–513.
79. Kiernan RC, Beresford TP, O’Cuinn G, and Jordan KN (2000) Autolysis of lactobacilli during Cheddar cheese ripening. *Irish J Agric Food Res* 39, 95–106.
80. Gagnaire V, Thierry A, and Leonil J (2001) Propionibacteria and facultatively heterofermentative lactobacilli weakly contribute to secondary proteolysis of Emmental cheese. *Lait* 81, 339–353.
81. Collins YF, McSweeney PLH, and Wilkinson MG (2003) Evidence of a relationship between autolysis of starter bacteria and lipolysis in Cheddar cheese during ripening. *J Dairy Res* 70, 105–113.
82. Hassan A, Johnson ME, and Lucey JA (2004) Changes in the proportions of soluble and insoluble calcium during the ripening of Cheddar cheese. *J Dairy Sci* 87, 854–862.
83. Lee MR, Johnson ME, and Lucey JA (2005) Impact of modifications in acid development on the insoluble calcium content and rheological properties of Cheddar cheese. *J Dairy Sci* 88, 3798–3809.
84. Sheehan A, Cuinn GO, FitzGerald RL, and Wilkinson MG (2006) Proteolytic enzyme in Cheddar cheese juice made using lactococcal starters of differing autolytic properties. *J Appl Micro* 100, 893–901.
85. Upadhyay VK, Huppertz T, Kelly AL, and McSweeney PLH (2007) Use of high pressure treatment to attenuate starter bacteria for use as adjuncts for Cheddar cheese manufacture. *Innovat Food Sci Emerg Technol* 8, 485–492.
86. Visser S, Hup G, Exterkate FA, and Stadhouders J (1983) Bitter peptides in cheese. 2. Model studies on the formation and degradation of bitter peptides by proteolytic enzymes from calf rennet, starter cells and starter cell fractions. *Neth Milk Dairy J* 37, 169–180.
87. Visser S, Slangen KJ, Hup G, and Stadhouders J (1983) Bitter flavour in cheese. 3 Comparative gel-chromatographic analysis of hydrophobic peptide fractions from twelve Gouda-type cheese and identification of bitter peptides isolated from a cheese made with *Streptococcus cremoris* strain HP. *Neth Milk Dairy J* 37, 181–192.
88. Aston JW and Creamer LK (1986) Contribution of the components of the water-soluble fraction to the flavour of Cheddar cheese. *NZ J Dairy Sci Technol* 21, 229–248.
89. Singh TK, Fox PF, Højrup P, and Healy A (1994) A scheme for the fractionation of cheese nitrogen and identification of principal peptides. *Int Dairy J* 4, 111–122.
90. Singh TK, Fox PF, and Healy A (1995) Water soluble peptides in Cheddar cheese: Isolation and identification of peptides in the UF retentate of water-soluble fractions. *J Dairy Res* 62, 629–640.
91. Toelstede S and Hofmann T (2008) Sensomics mapping and identification of the key bitter metabolites in Gouda cheese. *J Agric Food Chem* 56, 2795–2804.
92. Ardö Y and Meisel H (1991) Methods for direct measurement of peptide bond cleavage in cheese. *Bulletin* 261, pp. 10–13, International Dairy Federation, Brussels.



93. Furtado MM and Chandan RC (1985) Ripening changes in blue-mold surface ripened cheese from goat's milk. *J Food Sci* 50, 545–546.
94. Alonso L, Juárez M, Ramos M, and Martín-Alvarez PJ (1987) Effects of changes during ripening and frozen storage of the physicochemical and sensory characteristics of Cabrales cheeses. *Int J Food Sci Technol* 22, 525–534.
95. Zarpoutis IV, McSweeney PLH, and Fox PF (1997) Proteolysis in blue-veined cheese: An intervariety study. *Irish J Agric Food Res* 36, 219–229.
96. Ordóñez JA and Burgos J (1977) Etude de la variété de fromage "Ulloa." 1. Evolution de la flore microbienne et des composants azotes au cours de la maturation. *Lait* 57, 150–163.
97. Fernández-Salguero J, Andrés Marcos Alcalá M, and Esteban MA (1989) Proteolysis of Cabrales cheese and other European blue vein cheese varieties. *J Dairy Res* 56, 141–145.
98. Carmona M, Sanjuán E, Gómez R, and Fernández-Salguero J (1999) Effect of starter cultures on the physico-chemical and biochemical features in ewe cheese made with extracts from flowers of *Cynara cardunculus* L. *J Sci Food Agric* 79, 737–744.
99. Sanjuán E, Millán R, Saavedra P, Carmona MA, Gome R, and Fernández-Salguero J (2002) Influence of animal and vegetable rennet on the physicochemical characteristics of Los Pedroches cheese during ripening. *Food Chem* 78, 281–289.
100. Bradford M (1976) A rapid and sensitive method for the quantitation of microgram quantities of protein utilizing the principle of protein-dye binding. *Anal Biochem* 72, 248–254.
101. Wallace JM and Fox PF (1994) Comparison of different methods for quantitation of peptides/amino acids in the water-soluble fraction of Cheddar cheese. *Proceedings of the FLAIR Meeting*, Lisbon, pp. 41–58.
102. Ollikainen P (1990) Titration—A rapid method for the determination of proteolysis in cheese. *J Dairy Res* 57, 149–150.
103. Satake K, Okuyama T, Ohashi M, and Shineda T (1960) The spectrophotometric determination of amine, amino acid and peptide with 2,4,6-trinitrobenzene 1-sulfonic acid. *J Biochem (Tokyo)* 47, 654.
104. Madkor SA, Fox PF, Shalabi SI, and Metwally NH (1987) Studies on the ripening of Stilton cheese, Proteolysis. *Food Chem* 25, 13–19.
105. Polychroniadou A (1988) A simple procedure using trinitrobenzene sulphonic acid for monitoring proteolysis in cheese. *J Dairy Res* 55, 585–596.
106. Humbert G, Guingamp M-F, Kouomegne R, and Linden G (1990) Measurement of proteolysis in milk and cheese using trinitrobenzene sulphonic acid and a new dissolving reagent. *J Dairy Res* 57, 143–148.
107. Bouton Y and Grappin R (1995) Comparison of the final quality of a swiss-type cheese made from raw or microfiltered milk. *Lait* 75, 31–44.
108. Izco JM, Torre P, and Barcina Y (2000) Ripening of Ossau-Iraty cheese: Determination of free amino acids by RP-HPLC and f total free amino acids by the TNBS method. *Food Control* 11, 7–11.
109. Clegg KM, Lee YK, and McGilligan JF (1982) Trinitrobenzene sulphonic acid and ninhydrin reagents for the assessment of protein degradation in cheese samples. *J Food Technol* 17, 517–520.
110. Moore S and Stein WH (1948) Photometric ninhydrin method for use in the chromatography of amino acids. *J Biol Chem* 176, 367–388.
111. Moore S and Stein WH (1954) A modified ninhydrin reagent for the photometric determination of amino acids and related compounds. *J Biol Chem* 211, 907–913.
112. Tsarichenko AP (1966) New ninhydrin reagent for quantitative determination of amino acids in eluates in column chromatography. *Nauch Tr Krasnodar Gos Pedagog Inst No* 70, pp. 86–88, cited from *Chem Abstr*, 1967, 67,79479c.
113. Doi E, Shibata D, and Matoba T (1981) Modified colorimetric ninhydrin methods for peptidase assay. *Anal Biochem* 118, 173–184.
114. Friedman M, Pang J, and Smith GA (1984) Ninhydrin-reactive lysine in food proteins. *J Food Sci* 49, 10–13, 20.

115. Pearce KN, Karahalios D, and Friedman M (1988) Ninhydrin assay for proteolysis in ripening cheese. *J Food Sci* 53, 432–435, 438.
116. Pavia M, Trujillo AJ, Guamis B, and Ferragut V (2000) Proteolysis in Manchego-type cheese salted by brine vacuum impregnation. *J Dairy Sci* 83, 1441–1447.
117. Folkertsma B and Fox PF (1992) Use of Cd-ninhydrin reagent to assess proteolysis in cheese during ripening. *J Dairy Res* 59, 217–224.
118. Law J, Fitzgerald GF, Daly C, Fox PF, and Farkye NY (1992) Proteolysis and flavour development in Cheddar cheese made with the single starter strains *Lactococcus lactis* ssp. *lactis* UC 317 or *Lactococcus lactis* ssp. *cremoris* HP. *J Dairy Sci* 75, 1173–1185.
119. McSweeney PLH, Fox PF, Lucey JA, Jordon KN, and Cogan TM (1993) Contribution of the indigenous microflora to the maturation of Cheddar cheese. *Int Dairy J* 3, 613–634.
120. Shakeel-Ur-Rehman, Feeney EP, McSweeney PLH, and Fox PF (1998) Inhibition of residual coagulant in cheese using pepstatin. *Int Dairy J* 8, 987–992.
121. Katsiari MC, Alichanidis E, Voutsinas LP, and Roussis IG (2001) Proteolysis in reduced sodium Kefalograviera cheese made by partial replacement of NaCl with KCl. *Food Chem* 73, 31–43.
122. Weigele M, de Bernardo SL, Tengji JP, and Leimgruber W (1972) A novel reagent for the fluorometric assay of primary amines. *J Am Chem Soc* 94, 5927–5928.
123. Pripp AH, Kieronczyk A, Stepaniak L, and Sorhaug T (1999) Comparison of biochemical characteristics of three Norwegian cheese varieties using multivariate statistical analysis. *Milchwissenschaft* 54, 558–562.
124. Garde S, Gaya P, Fernandez-Garcia E, Medina M, and Nunez M (2003) Proteolysis, volatile compounds, and sensory evaluation in Hispanico cheese manufactured with the addition of a thermophilic adjunct culture, nisin, and calcium alginate-nisin microparticles. *J Dairy Sci* 86, 3038–3047.
125. Avila M, Garde S, Gaya P, Medina M, and Nunez M (2005) Influence of bacteriocin-producing lactic culture on proteolysis and texture of Hispanico cheese. *Int Dairy J* 15, 145–153.
126. Avila M, Garde S, Medina M, and Nunez M (2007) Characteristics of Manchego cheese made from pasteurized ewes' milk inoculated with a bacteriocin-producing adjunct culture. *Milchwissenschaft* 62, 184–187.
127. Trieu-Cuot P and Gripon J-C (1982) A study of proteolysis during Camembert cheese ripening using isoelectric focusing and two-dimensional electrophoresis. *J Dairy Res* 49, 501–510.
128. Addeo F, Chianese L, Di Luccia A, Petrilli P, Mauriello R, and Anelli G (1983) Identification of bovine casein variants by gel isoelectric focusing. *Milchwissenschaft* 38, 586–588.
129. Addeo F, Moio L, Chianese L, Stingo C, and Di Luccia A (1990) Improved procedure for detecting bovine and ovine milk mixtures in cheese by isoelectric focusing of para- $\kappa$ -casein. *Milchwissenschaft* 45, 221–224.
130. Addeo F, Moio L, Chianese L, Stingo C, Resmini E, Berner I, Krause D, Di Lucci A, and Bocca A (1990) Use of plasmin to increase the sensitivity of the detection of bovine milk in ovine cheese by gel isoelectric focusing of  $\gamma^2$ -caseins. *Milchwissenschaft* 45, 708–711.
131. Conti A, Napolitano L, Cantisani SM, Davoli R, and Dall'Olio S (1988) Bovine beta-lactoglobulin H— isolation by preparative isoelectric-focusing in immobilized pH gradients and preliminary characterization. *J Biochem Biophys Methods* 16, 205–214.
132. Moio L, Di Luccia A, and Addeo F (1989) Fast isoelectric-focusing of milk-proteins on small ultrathin polyacrylamide gels containing urea. *Electrophoresis* 10, 533–535.
133. Moio L, Chianese L, Rivemale M, and Addeo F (1992) Fast detection of bovine milk in Roquefort cheese with PhastSystem® by gel isoelectric focusing and immunoblotting. *Lait* 72, 87–93.
134. Creamer LK (1991) Electrophoresis of cheese. *Int Dairy Fed* 261, 14–28.
135. Amigo L, Ramos M, Calhau L, and Barbosa M (1992) Comparison of electrophoresis, isoelectric focusing, and immunodiffusion in determination of cow's and goat's milk in Serra da Estrela cheeses. *Lait* 72, 95–101.
136. Strange ED, Malin EL, Van Heken DL, and Basch JJ (1992) Chromatographic and electrophoretic methods used for analysis of milk proteins. *J Chromatogr* 624, 81–102.

137. Ledford RA, O'Sullivan AC, and Nath KR (1966) Residual casein fractions in ripened cheese determined by polyacrylamide-gel electrophoresis. *J Dairy Sci* 49, 1098–1101.
138. Shalabi SI and Fox PF (1987) Electrophoretic analysis of cheese, comparison of methods. *Irish J Food Sci Technol* 11, 135–151.
139. Andrews AT (1983) Proteinases in normal bovine milk and their action on caseins. *J Dairy Res* 50, 45–55.
140. Blakesley RW and Boezi JA (1977) A new staining technique for proteins in polyacrylamide gels using Coomassie Brilliant Blue G250. *Anal Biochem* 82, 580–582.
141. Brickley CA, Auty MAE, Piraino P, and McSweeney PLH (2007) The effect of natural Cheddar cheese ripening on the functional and textural properties of the processed cheese manufactured therefrom. *J Food Sci* 72, C483–C490.
142. Sheehan JJ, Oliveira JC, Kelly AL, and McSweeney PLH (2007) Effect of cook temperature on primary proteolysis and predicted residual chymosin activity of a semi-hard cheese manufactured using thermophilic cultures. *Int Dairy J* 17, 826–834.
143. McSweeney PLH, Pochet S, Fox PF, and Healy A (1994) Partial identification of peptides from the water-soluble fraction of Cheddar cheese. *J Dairy Res* 61, 587–590.
144. Young PM, Astephen NE, and Wheat TE (1992) Effects of pH and buffer composition on peptide separations by high performance liquid chromatography and capillary electrophoresis. *LC-GC* 10, 26–30.
145. Zeece M (1992) Capillary electrophoresis, a new analytical tool for food science. *Trends Food Sci Technol* 3, 6–10.
146. Lindeberg J (1996) Addendum to capillary electrophoresis in food analysis. *Food Chem* 55, 95–101.
147. Lindeberg J (1996) Capillary electrophoresis in food analysis. *Food Chem* 55, 73–94.
148. Gouldsworthy AM, Banks JM, Law AJR, and Leaver J (1999) Casein degradation in Cheddar cheese monitored by capillary electrophoresis. *Milchwissenschaft* 54, 620–623.
149. Albillos SM, Busto MD, Perez-Mateos M, and Ortega N (2006) Prediction of the ripening times of ewe's milk cheese by multivariate regression analysis of capillary electrophoresis casein fractions. *J Agric Food Chem* 54, 8281–8287.
150. Revilla I, Rodriguez-Nogales JM, and Vivar-Quintana AM (2007) Proteolysis and texture of hard ewes' milk cheese during ripening as affected by somatic cell counts. *J Dairy Res* 74, 127–136.
151. Haasnoot W, Stouter P, and Venema DP (1989) High performance liquid chromatography determination of the extent of proteolysis in Gouda cheese. *J Chromatogr* 483, 319–329.
152. Breen ED, Fox PF, and McSweeney PLH (1995) Fractionation of water-soluble peptides from Cheddar cheese. *Italian J Food Sci* 7, 211–220.
153. Fenelon MA, Ryan MP, Rea MC, Guinee TP, Ross RP, Hill C, and Harrington D (1999) Elevated temperature ripening of reduced fat Cheddar made with or without lactacin 3147-producing starter culture. *J Dairy Sci* 82, 10–22.
154. Fenelon MA, O'Connor P, and Guinee TP (2000) The effect of fat content on the microbiology and proteolysis in Cheddar cheese during ripening. *J Dairy Sci* 83, 2173–2183.
155. O'Reilly CE, O'Connor PM, Murphy PM, Kelly AL, and Beresford TP (2000) The effect of exposure to pressure of 50 MPa on Cheddar cheese ripening. *Innovat Food Sci Emerg Technol* 1, 109–117.
156. Creamer LK and Richardson BC (1974) Identification of the primary degradation product of  $\alpha_{s1}$ -casein in Cheddar cheese. *NZ J Dairy Sci Technol* 9, 9–13.
157. Breen ED (1992) Fractionation and identification of water-soluble and water-insoluble cheese nitrogen. MSc thesis, National University of Ireland, Cork.
158. Barrefors P, Ekstrand B, Fagerstam L, Larson-Raznikiewicz M, Scharr J, and Steffner P (1985) Fast protein liquid chromatography (FPLC) of bovine caseins. *Milchwissenschaft* 40, 257–260.
159. St. Martin M and Paquin P (1990) Ion exchange fast protein liquid chromatography, optimization of the purification of caseins using a non-denaturing detergent. *J Dairy Res* 57, 63–68.
160. Le Bars D and Gripon J-C (1989) Specificity of plasmin towards bovine  $\alpha_{s2}$ -casein. *J Dairy Res* 56, 817–821.

161. McSweeney PLH, Olson NF, Fox PF, Healy A, and Hojrup P (1993) Proteolytic specificity of chymosin on bovine  $\alpha_{s1}$ -casein. *J Dairy Res* 60, 401–412.
162. Kaminogawa S, Yan TR, Azuma N, and Yamauchi K (1986) Identification of low molecular weight peptides in Gouda-type cheese and evidence for the formation of these peptides from 23-N-terminal residues of  $\alpha_{s1}$ -casein by proteinases of *Streptococcus cremoris* H61. *J Food Sci* 51, 1253–1256, 1264.
163. Christensen TMIE, Kristiansen KR, and Madsen, JS (1989) Proteolysis in cheese investigated by high performance liquid chromatography. *J Dairy Res* 56, 823–828.
164. Cliffe AJ, Marks JD, and Mulholland F (1993) Isolation and characterization of non-volatile flavours from cheese, peptide profile of flavour fractions from Cheddar cheese, determined by reverse phase high-performance liquid chromatography. *Int Dairy J* 3, 379–387.
165. Pham A-M and Nakai S (1984) Application of stepwise discriminant analysis to high pressure liquid chromatography profiles of water extract for judging ripening of Cheddar cheese. *J Dairy Sci* 67, 1390–1396.
166. Lagerwerf FM, van Wassenaar PD, and Haverkamp J (1995) Comparison of Cheddar cheeses produced with recombinant chymosin with calf rennet using two dimensional high-performance liquid chromatography. *J Dairy Res* 62, 673–679.
167. Pripp AH, Tobiassen RO, Stepaniak L, and Sørhaug T (1998) Comparative capillary electrophoresis analysis of proteolysis breakdown in caseinate and cheese curd models. *Lebensmitt Wiss Technol* 31, 177–181.
168. Pripp AH, Shakeel-Ur-Rehman, McSweeney PLH, and Fox PF (1999) Multivariate statistical analysis of peptide profiles and free amino acids to evaluate effects of single-strain starters on proteolysis in miniature Cheddar-type cheeses. *Int Dairy J* 9, 473–479.
169. Pripp AH, Shakeel-Ur-Rehman, McSweeney PLH, Sørhaug T, and Fox PF (2000) Comparative study by multivariate statistical analysis of proteolysis in a sodium caseinate solution under cheese-like conditions caused by strains of *Lactococcus*. *Int Dairy J* 10, 25–31.
170. Pripp AH, Stepaniak L, and Sørhaug T (2000) Chemometrical analysis of proteolytic profiles during cheese ripening. *Int Dairy J* 10, 249–253.
171. Shakeel-Ur-Rehman, Pripp AH, McSweeney PLH, and Fox PF (1999) Assessing the proteolytic and cheese ripening properties of single strains of *Lactococcus* in miniature cheeses. *Lait* 79, 361–383.
172. Hayaloglu AA, Brechany EY, Deegan KC, and McSweeney PLH (2008) Characterization of the chemistry, biochemistry and volatile profile of Kufli cheese, a mould-ripened variety. *Lebensmitt Wiss Technol* 41, 1323–1334.
173. Alomirah HF, Alli I, and Konishi Y (2000) Applications of mass spectrometry to food proteins and peptides. *J Chromatogr A* 893, 1–21.
174. Karas M (1996) Matrix-assisted laser desorption ionization MS: A progress report. *Biochem Soc Trans* 24, 897–900.
175. Abell DC and Sporns P (1996) Rapid quantitation of potato glycoalkaloids by matrix-assisted laser desorption/ionization time-of-flight mass spectrometry. *J Agric Food Chem* 44, 2292–2296.
176. de Frutos M, Cifuentes A, Diez-Masa JC, Camafeita E and Mendez E (1998) Multiple peaks in HPLC of proteins: Bovine serum albumin eluted in a reversed-phase system. *J High Res Chromatogr* 21, 18–24.
177. Fanton C, Delogu G, Maccioni E, Podda G, Seraglia R, and Traldi P (1998) Matrix-assisted laser desorption/ionization mass spectrometry in the dairy industry 2. The protein fingerprint of ewe cheese and its application to detection of adulteration by bovine milk. *Rapid Commun Mass Spectrom* 12, 1569–1573.
178. Ferranti P, Malorni A, Nitti G, Laezza P, Pizzano R, Chianese L, and Addeo F (1995) Primary structure of ovine alpha(s1)-caseins - localization of phosphorylation sites and characterization of genetic-variant-A, genetic-variant-C and genetic-variant-D. *J Dairy Res* 62, 281–296.
179. Ferranti P, Addeo F, Malorni A, Chianese L, Leroux C, and Martin P (1997) Differential splicing of pre-messenger RNA produces multiple forms of mature caprine alpha(s1)-casein. *Eur J Biochem* 249, 1–7.

180. Stahl B, Thurl S, Zeng JR, Karas M, Hillenkamp F, Steup M, and Sawatzki G (1994) Oligosaccharides from human milk as revealed by matrix-assisted laser-desorption ionization mass-spectrometry. *Anal Biochem* 223, 218–226.
181. Kim H, Leszyk J, and Taub I (1997) Direct observation of protein glycosylation by matrix-assisted laser desorption/ionization time-of-flight mass spectrometry. *J Agric Food Chem* 45, 2158–2165.
182. Zappacosta F, Di Luccia A, Ledda L, and Addeo F (1998) Identification of C-terminally truncated forms of beta-lactoglobulin in whey from Romagnola cows' milk by two dimensional electrophoresis coupled to mass spectrometry. *J Dairy Res* 65, 243–252.
183. Siciliano R, Rega B, Amoresano A, and Pucci P (2000) Modern mass spectrometric methodologies in monitoring milk quality. *Anal Chem* 72, 408–415.
184. Angeletti R, Gioacchini AM, Seraglia R, Piro R, and Traldi P (1998) The potential of matrix-assisted laser desorption/ionization mass spectrometry in the quality control of water buffalo Mozzarella cheese. *J Mass Spectrom* 33, 525–531.
185. Cozzolino R, Passalacqua S, Salemi S, and Garozzo D (2002) Identification of adulteration in water buffalo mozzarella and in ewe cheese by using whey proteins as biomarkers and matrix-assisted laser desorption/ionization time-of-flight mass spectrometry. *J Mass Spectrom* 37, 985–991.
186. Cozzolino R, Passalacqua S, Salemi S, Malvagna P, Spina E, and Garozzo D (2001) Identification of adulteration in milk by matrix-assisted laser desorption/ionization time-of-flight mass spectrometry. *J Mass Spectrom* 36, 1031–1037.
187. Fedele L, Seraglia R, Battistotti B, Pinelli C, and Traldi P (1999) Matrix-assisted laser desorption/ionization mass spectrometry for monitoring bacterial protein digestion in yogurt production. *J Mass Spectrom* 34, 1338–1345.
188. Wedholm A, Møller HS, Lindmark-Månsson H, Rasmussen MD, Andrén A, and Larsen LB (2008) Identification of peptides in milk as a result of proteolysis at different levels of somatic cell counts using LC MALDI MS/MS detection. *J Dairy Res* 75, 76–83.
189. Broadbent JR, Strickland M, Weimer BC, Johnson ME, and Steele JL (1998) Peptide accumulation and bitterness in Cheddar cheese made using single-strain *Lactococcus lactis* starters with distinct proteinase specificities. *J Dairy Sci* 81, 327–337.
190. Gouldsworthy AM, Leaver J, and Banks JM (1996) Application of a mass spectrometry sequencing technique for identifying peptides present in cheddar cheese. *Int Dairy J* 6, 781–790.
191. Soeryapranata E, Powers JR, Hill HH, Siems WF, Al-Saad K, and Weller KM (2002) Matrix-assisted laser desorption/ionization time-of-flight mass spectrometry method for the quantification of  $\beta$ -casein fragment (f193–209). *J Food Sci* 67, 534–538.
192. Soeryapranata E, Powers J, Fajarrini F, Weller K, Hill H, and Siems W III (2002) Relationship between MALDI-TOF analysis of  $\beta$ -CN f193–209 concentration and sensory evaluation of bitterness intensity of aged Cheddar cheese. *J Agric Food Chem* 50, 4900–4905.
193. Soeryapranata E, Powers J, Weller K, Hill H, and Siems W (2004) Differentiation of intracellular peptidases of starter and adjunct cultures using matrix-assisted laser desorption/ionization time-of-flight mass spectrometry. *Lebensmittel-Wissenschaft und-Technologie* 37, 17–22.
194. Rossano R, Piraino P, D'Ambrosio A, Ungarno N, McSweeney PLH, and Riccio P (2005) Proteolysis in miniature Cheddar-type cheeses manufactured using extracts from the crustacean *Munida* as coagulant. *J Biotechnol* 120, 220–227.
195. Piraino P, Parente E, and McSweeney PLH (2004) Processing of chromatographic data for chemometric analysis of peptide profiles from cheese extracts: A novel approach. *J Agric Food Chem* 52, 6904–6911.

## Chapter 20

---

# Determination of Lipolysis

---

Kieran Kilcawley

### CONTENTS

20.1	Introduction.....	428
20.1.1	Nomenclature of Lipids.....	428
20.1.2	Key Aspects of Lipolysis and Related Enzymatic Reactions.....	428
20.1.3	Industrial Uses of Lipolytic Enzymes .....	430
20.2	Lipolytic Determination .....	432
20.2.1	Methods .....	433
20.2.2	Turbidimetric Assays .....	433
20.2.2.1	Agar Plate Assays or Gel Diffusion Assays.....	433
20.2.3	Titrimetric Assays.....	433
20.2.3.1	ADV and BDI Methods.....	433
20.2.3.2	pH Stat Method.....	434
20.2.4	Spectrophotometric Assays.....	435
20.2.4.1	Chromogenic Substrates.....	435
20.2.4.2	Fluorimetric Assays .....	438
20.2.4.3	Infrared.....	439
20.2.5	Radioactive Assays .....	439
20.2.5.1	Radiolabeled Substrates .....	439
20.2.6	Chromatographic Methods.....	440
20.2.6.1	Thin-Layer Chromatography.....	440
20.2.6.2	Gas Chromatography.....	440
20.2.6.3	Liquid Chromatography .....	441
20.2.7	Immunological Methods .....	443
20.2.7.1	Enzyme-Linked Immunoassays Methods .....	443

20.2.8	Surface Tension Methods .....	443
20.2.8.1	Oil Drop Method.....	443
20.2.8.2	Monomolecular Films (Wilhelmy Plate Method) .....	444
References	.....	444

## 20.1 Introduction

Bovine milk lipids are similar to other mammalian species as they are mainly composed of triacylglycerides (~98.3%, w/w), diacylglycerides (0.3%), monoacylglycerides (0.03%), free fatty acids (0.1%), phospholipids (0.8%), sterols (0.3%), with trace amounts of fat-soluble vitamins,  $\beta$ -carotene, and fat-soluble flavoring compounds [1]. Triacylglycerides exert a major direct effect on the properties of milk due to their high levels in milk fat. Milk fat contains many different combinations of triacylglycerides that vary in molecular weight, degree of unsaturation, and number of carbon atoms. The complexity of triacylglycerides is a result of the wide array of different saturated or unsaturated fatty acids (>400) that can be esterified on the hydroxyl groups of a glycerol molecule to form different acylglycerides. Milk fat contains approximately 50 mol% long-chain saturated fatty acids and 15 mol% short- to medium-chain saturated fatty acid mixtures [2]. Milk fat contains over 250 different fatty acids, but 15 of these make up 95% of the total fatty acid content [3] (Table 20.1).

### 20.1.1 Nomenclature of Lipids

A stereospecific numbering (*sn*) system is recommended by a IUPAC-IUB commission to denote the esterification position of carbons on the glycerol molecule. A denotation of *sn*-1, *sn*-2, and *sn*-3 is used to identify the esterification position of carbon 1, 2, and 3 on the glycerol molecule, as shown in a Fischer projection of a natural L-glycerol derivative (Figure 20.1). The secondary hydroxyl group is shown to the left of C-2; the carbon atom above this then becomes C-1 while that below becomes C-3, and the prefix *sn* is placed before the stem name of the compound. The term “triacyl-*sn*-glycerol” should then be used to designate the molecule rather than “triglyceride.” Position *sn*-1 and *sn*-3 are known as the primary hydroxyl groups as many fatty acids have a preference for esterification at these positions and due to the fact that fatty acids at these positions are more stable than at position *sn*-2. The glycerol molecule is symmetrical, but the central atom acquires chirality when one of the primary hydroxyl groups is esterified or if these two primary hydroxyl groups are esterified with different fatty acids [2].

### 20.1.2 Key Aspects of Lipolysis and Related Enzymatic Reactions

Lipolysis is a hydrolysis reaction, where lipolytic enzymes cleave the ester linkage between a fatty acid and the glycerol backbone of triacylglycerides to produce free fatty acids, di-, and monoacylglycerides [4]. There are two types of lipolytic enzymes: esterases and lipases. Esterases hydrolyze (EC 3.1.1.1) acyl ester chains between 2 and 8 carbon atoms in length, from soluble substrates in aqueous (polar) solutions and have classical Michaelis–Menten type kinetics. While lipases (EC 3.1.1.3) hydrolyze acyl ester chains of 10 or more carbon atoms, from emulsified substrates (nonpolar) and have “interfacial” Michaelis–Menten type kinetics, since they are activated only in the presence of a hydrophobic/hydrophilic interface [5,6]. This interfacial activation is the

**Table 20.1 Major Fatty Acids in Bovine Milk Fat**

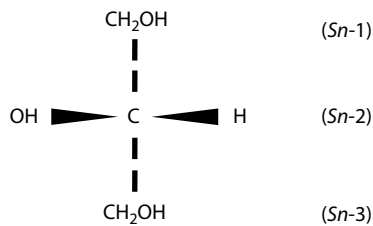
	Common Name	Composition		
		Typical % (w/w)	mol %	Range % (w/w)
4:0	Butyric	3.9	10.1	3.1–4.4
6:0	Caproic	2.5	4.9	1.8–2.7
8:0	Caprylic	1.5	2.4	1.0–1.7
10:0	Capric	3.2	4.3	2.2–3.8
12:0	Lauric	3.6	4.1	2.6–4.2
14:0	Myristic	11.1	11.1	9.1–11.9
14:1	Myristoleic	0.8	0.8	0.5–1.1
15:0		1.2	1.1	0.9–1.4
16:0	Palmitic	27.9	24.9	23.6–31.4
16:1	Palmitoleic	1.5	1.4	1.4–2.0
18:0	Stearic	12.2	9.8	10.4–14.6
18:1 <i>cis</i>	Oleic	17.2	13.9	14.9–22.0
18:1 <i>trans</i>		3.9	3.2	
18:2	Linoleic	1.4	1.1	1.2–1.7
18: conj	Conjugated linoleic acid	1.1	0.9	0.8–1.5
18:3	$\alpha$ -Linolenic	1.0	0.8	0.9–1.2
	Minor acids	6.0	5.1	4.8–7.5

Source: Fox, P.F. and McSweeney, P.L.H., *Advanced Dairy Chemistry*, Vol. 2: Lipids, Springer, New York, p. 690, 2006. With permission.

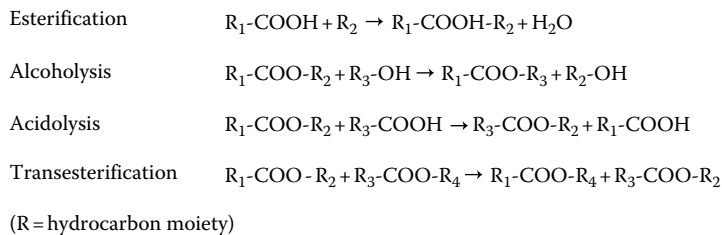
fundamental difference between esterases and lipases and is predominantly due to a change in the lipase conformation at the water/oil interface [7]. A hydrophobic “lid” covers the active site of the lipase, which is closed in a hydrophilic environment and opens in a hydrophobic environment making the active site accessible to the substrate [7,8]. However, interfacial activation is not sufficient to distinguish lipases and esterases, as not all lipases with an amphiphilic lid obey this rule [9]. The term lipase is commonly used to denote both types of activities.

In addition to hydrolysis, lipolytic enzymes catalyze various reactions, these include esterification and transesterification (alcoholysis, acidolysis, and interesterification) Figure 20.2. Esterification is the opposite of hydrolysis and involves the production of esters from an acid and an alcohol. In excess water hydrolysis is enhanced, whereas under water limiting conditions esterification is enhanced. Lipases do not affect the position of equilibrium, but only the speed of the reaction. Transesterification refers to the process of exchanging an acyl group between: an ester and an acid (acidolysis); an ester and an alcohol (alcoholysis); or an ester and another ester, which leads to randomization of acyl and alcohol moieties (interesterification) [10,11].





**Figure 20.1** Stereospecific numbering of triacylglycerol.

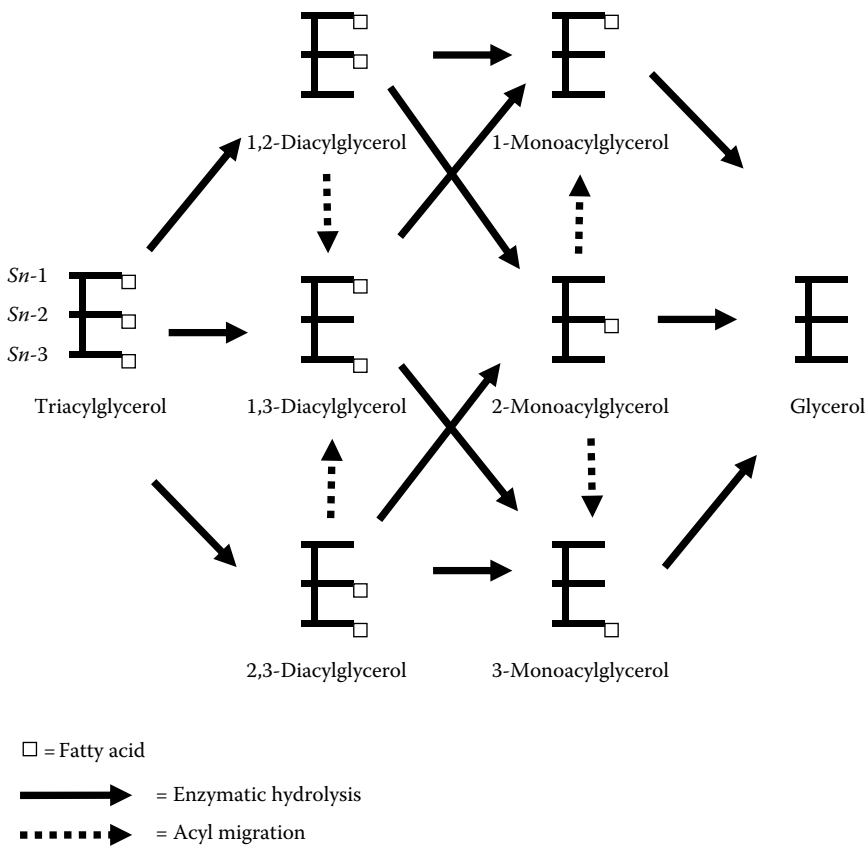


**Figure 20.2** Lipolytic enzymes catalyze a variety of reactions. (Adapted from Holland, R. et al., *Int. Dairy J.*, 15, 711, 2005. With permission.)

Lipolytic enzymes display marked differences in their specificities toward lipid substrates. Some are substrate specific, in that they hydrolyze only monoacylglycerides, mono- and diacylglycerides, or only triacylglycerides. Others are stereospecific, where they are selective toward given positions on the glycerol backbone, such as *sn*-1 or *sn*-3. Other lipolytic enzymes have positional selectivity or regioselectivity, such as *sn*-1, 3-regioselectivity, or *sn*-2 regioselectivity, while others show no apparent selectivity for substrate or acyl position or *sn*-3 [7]. In general, most lipolytic enzymes are *sn*-1, 3-regioselective. It is worth noting that certain mono- and diacylglycerides; 2,3-diacylglycerides, 1,2-diacylglycerides, and 2-monoacylglycerides are inherently unstable and will undergo acyl migration to 1,3-diacylglycerides and 1-monoacylglycerides, respectively, in order to become more stable [12,13] (Figure 20.3). The instability of these mono- and diacylglycerides has an impact on the action of the lipolytic enzymes, as in theory under the right conditions most enzymes in time will hydrolyze tri-, di-, and monoacylglycerides to individual fatty acids and glycerol.

### 20.1.3 Industrial Uses of Lipolytic Enzymes

Lipases are well recognized by scientists as a very important class of enzyme, because of their versatility, but in reality they only account for about 4% of the worldwide enzyme market. Even though lipases have arguably more diverse possibilities than most other enzyme classes, industrial uses for such activities have not yet been developed that are cost effective, and for this reason lipases are often called “solutions in search of problems” [2]. However, it is anticipated that lipase use, will increase although at a low rate as production by genetic engineering and microbial cloning techniques, coupled with improvements in purification will reduce production



**Figure 20.3** Enzymatic hydrolysis and acyl migration of triacylglycerol. (Fox, P.F. and McSweeney, P.L.H., *Advanced Dairy Chemistry*, Vol. 2: Lipids, Springer, New York, p. 690, 2006. With permission.)

costs. Currently the main usages are in the detergent, chemical, and food industries, and in biomedical sciences. New uses of lipases in the development of biopolymeric materials, conversion of vegetable oil to methyl or other short-chain alcohol esters and for use in therapeutics are under investigation [14]. Usage in the food industry relates mainly to flavor production, as the flavor of many dairy products is influenced by unique aspects of mammalian (bovine, ovine, and caprine) milk fat, which contains a high concentration of volatile short-chain fatty acids. Such fatty acids in their free form are responsible for the characteristic flavor of many dairy products and are widely used as ingredients in applications, such as oils, fats, cereals, snacks, and in particular baked goods. However, lipolysis is responsible for both desirable and undesirable flavor in dairy products. Short-chain free fatty acids, such as butyric, caproic, and caprylic give sharp tangy flavors, while medium-chain free fatty acids impart soapiness. Long-chain free fatty acids contribute little to flavor, but many of these free fatty acids act as precursors for very flavorsome compounds, such as  $\beta$ -keto acids, esters, methyl ketones, acetoacetate, and lactones [15]. In addition, unsaturated free fatty acids are susceptible to oxidation, which gives rise to oxidized and metallic notes.

## 20.2 Lipolytic Determination

There has long been a need in the dairy industry to quantify low levels of lipolytic activity in milk due to the lipolytic activity of psychotropic bacteria [4] and today with advances in biotechnology for discovering or altering the properties of existing esterases/lipases the need for suitable rapid screening techniques, reliable reproducible methods are more important than ever. In addition, the growth in products and processes that utilize hydrolyzed dairy fat has resulted in the need for accurate methods to quantify the products of lipolysis and lipolytic activity.

Depending upon the requirements, different options are available to determine lipolytic activity from rapid qualitative assays to assess the presence of activity or kinetic selectivity assays to determine rates of reactions toward specific substrates for quantifiable comparison. However, a major issue with the measurement of lipolytic activity in milk or milk products is the presence of inherently high levels of lipid, as bovine milk contains 37–41 g/L of lipid [16]. Such high concentrations of available substrate interfere with artificial substrates unless the lipolytic activity has significantly more specificity toward the artificial substrate than the natural lipid. Therefore, fat is typically removed or the free fatty acids are isolated prior to the assay. Moreover, the products of lipolytic activity, free fatty acids, di-, and monoacylglycerides are spectrally nondistinct and therefore direct spectrophotometric analysis is not possible. Thus, many methods concentrate on measuring the liberated products directly; some methods have been developed to measure physicochemical changes induced during the reaction, whereas other methods utilize specialized synthetic substrates.

A key aspect in many lipolytic assays is the use of a stable reproducible substrate emulsion [17]. The importance of this emulsion cannot be stated enough as the success or failure of many lipolytic assays is governed by the ability to reproduce stable emulsions. It is recommended that such lipolytic assays are carried out in triplicate using separate emulsions in order to take into account slight differences in the emulsion preparation. In emulsions the interfacial surface will become reduced with time due to coalescence of fat droplets, and therefore surfactants are typically required to stabilize the emulsion, but their effect is greatly diminished with time. Therefore, it is also recommended that fresh emulsions are prepared daily and that such substrates should be liquid between room temperature and 50°C [18]. Triton X-100 is used because of its emulsification properties, but it can also inhibit some lipases. Tween 20 is also used, but may act as a competitive substrate. Proteins such as sodium caseinate have been used but these can adversely interfere with the lipid–water interface; in addition, if the lipase preparation is not pure and contains proteolytic activity the emulsion may collapse due to hydrolysis of the protein. Gum Arabic is a good option as it has excellent emulsification properties and does not appear to interfere with the assay. Reverse micelles have also been developed in order to create homogenous stable emulsions. These are microemulsions of water-in-oil droplets where the lipase is entrapped in the aqueous phase [4].

Another important aspect of lipolytic assays is to clarify the initial rates of the reaction. The rate of reaction is dependent upon the surface area of the substrate at the substrate–water interface. The activity of a lipase or esterase is directly related to the initial rate of the reaction rather than that measured over a fixed period of time unless it has already been found that the fixed period of time covers the initial rate under the conditions of the assay. It is essential to ensure that the initial rate of lipolysis be determined correctly, because lipases can be easily inhibited, as the interfacial site can be blocked by the accumulation of liberated free fatty acids. The addition of salts can alleviate this to some extent, but it should not be necessary as time elapses to successfully measure the initial rate as the inclusion of salts will bring other problems in that assay conditions may be inadvertently modified.

A number of reviews of lipolytic assays have been carried out that cover the most relevant methods [4,19–22].

It is however quickly apparent that no one method will be suitable for all applications due to the significant amount of factors that adversely influence the reaction. Thus, the choice of the assay will vary depending upon individual requirements.

### **20.2.1 Methods**

Numerous methods exist to measure lipolytic activity. For the purpose of this chapter they are classified into: turbidimetric, titrimetric, spectrophotometric, radiolabeled, chromatographic, immunological, and surface tension methods.

#### **20.2.2 Turbidimetric Assays**

These techniques are widely used as qualitative techniques for lipase activity because of their low cost and simplicity.

##### **20.2.2.1 Agar Plate Assays or Gel Diffusion Assays**

This is a qualitative technique that utilizes solid media incorporating carboxylic esters, the agar is poured onto a sterile petri dish and left to set. Circular wells are punched into the media and the sample to be tested is added as a solution into the wells and left to incubate under controlled conditions. A positive result is observed by a zone of clearing around the well, the extent of the zone is an indication of the activity. The zone of clearing occurs when partly water-soluble free fatty acids are released from triacylglycerides, which reduces the size of the emulsified particles and thus impacts on light diffusion [23]. The pH can decrease around the well if acid metabolites are produced in sufficient quantities during the reaction, which can also produce a clear zone giving a false positive. Various dyes can be added to improve visibility of the clearing zone as they offer a better contrast than just the opaque background without the dye. Dyes such as fluorescent Rhodamine B, which emit fluorescence orange on exposure to UV light at 350 nm, or dyes such as violet blue (Victoria Blue or Nile Blue Sulfate), which stain fat globules pink and once the fat is partially hydrolyzed turns blue [24–26]. Typically tributyrin, triolein, tweens of different chain length, or olive oil are utilized, although butterfat and milk fat have also been evaluated. The method is suitable for confirming lipolytic activity, but only triolein (18:0, 18:0, 18:0) is a true indication of lipolytic activity. As triolein does not contain water-soluble fatty acids, it is necessary to utilize a dye when using triolein in order to visualize the zone of clearing. The method is widely used as a qualitative screening method for detection of lipolytic activity in microorganisms.

#### **20.2.3 Titrimetric Assays**

A very common, simple method to indicate lipolytic activity, where a sample is titrated with alkali to a specific end point.

##### **20.2.3.1 ADV and BDI Methods**

These methods are utilized for the direct quantification of lipolytic activity in samples, and are typically used for milk, cream, and/or cheeses. Numerous variations exist for these assays, but the

principles remain the same. The acid degree value (ADV) is typically described as a measurement of the degree of lipolysis of milk fat. ADV is the amount of 1 N base required to titrate 100 g of fat (Richardson [27]). The BDI method originated at the Bureau of Dairy Industries in the United States, which first standardized the method in 1955. The principle is based on mixing the sample (milk or cream) with a solution containing sodium tetraphosphate and a surface-active agent and heating in a boiling water bath to separate the fat. A measured quantity of fat is dissolved in an organic solvent, and titrated with an alcoholic alkali (thymol blue is used as an indicator), the amount of which required to reach a specific end point equates to the extent of activity. The International Dairy Federation method uses a BDI reagent containing Triton X-100 and sodium tetraphosphate to ensure that all free fatty acids are extracted [28]. Different tubes can be used to aid fat separation, which is carried out by a series of heat-treatments, mixing, and centrifugation. The fat solvent, petroleum ether contains thymol blue as an indicator. The titration is performed under nitrogen free of carbon dioxide and tetra-*n*-butyl ammonium hydroxide is used as the neutralizing agent. The reference samples of known fat acidity are used for comparative purposes to ensure accuracy and reproducibility of the method. The results are given as millimoles per 100 g of fat. Deeth et al. [29] evaluated different versions of the BDI method for the quantification of lipolysis in milk and more recently Evers [30] carried out a detailed analysis of the procedure and suggested the use of thymol blue sodium salt over thymol blue acid, and that the titration medium should be replaced regularly. The method described by Case et al. [31] has some modifications in that larger sample volumes, babcock tubes, different heating regimes and fat solvents, and phenolphthalein and alcoholic potassium hydroxide are used to titrate to a colored end point without the use of nitrogen. Results are expressed in ADV units where the volume of KOH used minus that used for a blank are multiplied by the normality of the alcoholic KOH solution and by 100, which is then divided by the exact weight of extracted fat used. Guidelines for this method suggest that raw milk should have values between 0.25 and 0.40, and that rancidity will be perceived above 1.20<sup>29</sup>. The method was adopted by the International Standards Organization [32]. This method was successfully used to quantify levels of lipolysis in enzyme-modified cheese samples [33] where values up to 22.8 ADV units were found.

### 20.2.3.2 *pH Stat Method*

Titrimetry is a simple relatively accurate and reproducible quantitative method for lipase activity and has also been utilized for lipase specificity and interfacial activation studies, as virtually any triacylglycerol can be used as a substrate as long as it can be readily dispersed in liquid. Numerous titration methods exist and are based on the same principles; a reaction mixture containing a lipid substrate such as triolein, tributyrin, milk fat, and the like is maintained as an emulsion at a set pH in an alkaline buffer, at a suitable temperature, and rate of agitation. Lipase is then added. Two separate approaches are typically employed: (a) direct titration of the emulsion, *via* a pH Stat method or (b) sample extraction usually by a solvent at a given time or times followed by titration to a specific end point. In method (a) the pH Stat method, the pH is maintained at an optimal pH for lipases (usually pH 8.0 or pH 8.5) using an alkali, such as sodium hydroxide over a given time or until the reaction stops. The amount of sodium hydroxide required over time is directly related to the activity of the enzyme. Both variations of the method are useful in determining the rate of reaction. These methods are typically employed using triolein or olive oil (70% triolein) as a substrate. The amount of fatty acids released during the reaction is determined by direct titration with NaOH, usually to a thymolphthalein end point. The use of a thymolphthalein end point

is important as a pH of 9.3–10.5 is required to ensure that all fatty acids are titrated as the  $pK_a$  values for oleic acid are high (7.7–8.9 in the presence of 0.1 M sodium) [18]. A 50 mM sodium phosphate buffer at pH 8.0 is routinely used because most lipases have an optimal pH range of 7–9 and also the presence of sodium reduces the  $pK_a$  value of oleic acid ensuring it is fully titrated. The pH must be above pH 7.0 as free fatty acids are not fully ionized, below pH 7.0 it is inaccurate or impossible. The use of an automated pH stat or similar automatic titration apparatus provides the benefit of a continuous output, which makes it easy to follow the rate of reaction. Samples taken must be quenched with ethanol or with a similar substance to stop the reaction. Units are typically expressed as the amount of enzyme (weight, protein, or volume) that produces 1  $\mu\text{mol}$  of fatty acid per minute under the specified assay conditions.

Even though this is one of the most routinely used laboratory assay for lipolytic activity, it is not without its drawbacks due to the difficulty of preparing reproducible emulsions. The assay is quite time consuming and assays that are based on color development as opposed to a specific pH are inherently prone to operator error. The assay also lacks sensitivity, especially when concentrations of up to 0.1 M NaOH are required. The assay is also restricted to a limited range of pH [21].

## 20.2.4 Spectrophotometric Assays

The use of ultraviolet–visible or fluorometric spectroscopy to quantify products of lipolysis is very common due to the proliferation of available chromogenic/fluorogenic substrates and spectrophotometric instruments. Although it is worth noting that the sensitivity of spectrophotometric instruments varies considerably and therefore maybe an important factor in relation to the type of assay required.

### 20.2.4.1 Chromogenic Substrates

Chromogenic substrates are widely used for their ease of use and potential to measure the rate of lipolytic activity. The principles surrounding the different chromogenic substrates are described, outlining both advantages and disadvantages.

#### 20.2.4.1.1 *p*-Nitrophenyl Acyl Substrate Analogs

The most common spectrophotometric lipolytic assay utilizes *p*-nitrophenyl acyl substrate analogs. A wide range of analogs are commercially available. When these substrates are hydrolyzed they yield a fatty acid and a *p*-nitrophenyl, which has an absorption maximum of 400–410 nm. The assay typically consists of an alkaline buffer, containing a low sodium chloride concentration and Triton X-100. A low concentration (50 mM) of the *p*-nitrophenyl acyl substrate is prepared in acetonitrile and added to the buffer and preheated to the desired reaction temperature. A known volume of lipolytic enzyme is added (preferably of known protein concentration). The reaction is mixed and is measured over a given time under controlled conditions. The activity is determined by comparison to standard curve prepared under the same assay conditions using *p*-nitrophenyl alone. The activity is quantified using the molar extinction coefficient of *p*-nitrophenyl for the pH and wavelength used. The major advantages of the method are its simplicity, the use of small volumes, and the ability for continuous measurement when using a thermostatically controlled peltier spectrophotometer. The activity is typically expressed as units per mg (weight/volume/protein)

per min under the conditions of the assay. A major disadvantage with this assay is that *p*-nitrophenyl does not absorb at acidic pH and is thus best used at neutral or alkaline pH [20]. It is possible to raise the pH after hydrolysis prior to reading the absorbance, but this can make comparison assays more difficult. Another important aspect of this assay is that the correct molar extinction coefficient for *p*-nitrophenol must be used as it differs at different pH and wavelengths. Short-chain esters, such as acetate, butyrate, or caproate are typically utilized to quantify esterase activity and laurate, myristate, palmitate, stearate, or oleate esters are utilized for lipase activity. A main difficulty that arises with the use of longer chain aliphatic acyl chains is their lack of solubility in aqueous buffer systems. To circumnavigate this condition, some researchers have utilized organic solvents, such as heptane [34], acetone [35], or dimethyl sulfoxide [36]. In addition Gilham and Lehner [22] have utilized emulsifying agents such as Triton X-100 and Gum Arabic. The utilization of *p*-nitrophenol esters to quantify lipolytic activity is quite versatile, but appears more suitable for the quantification of esterase rather than lipase activity, however it is also only best used to assay purified lipolytic preparations as proteinases, peptidases, serum albumin, and insulin have been found to hydrolyze *p*-nitrophenol short-chain esters [22]. It also appears that the presence of free fatty acids in the reaction mixture reduces sensitivity, which may be similar to the effect of product inhibition on tri-, di-, and monoacylglycerides [37].

#### 20.2.4.1.2 $\beta$ - or $\alpha$ -Naphthyl Acyl Substrate Analogs

Another commonly used chromogenic substrate for lipolytic activity is  $\beta$ -naphthyl or  $\alpha$ -naphthyl esters. They are typically used to quantify lipolytic activity milk, but have also been used to quantify activity in cheese and in bacterial cell extracts. Although naphthyl esters are colorless and hydrophobic, once released by the action of lipase they are reacted with an azo dye which results in the formation of an insoluble colored diazonium salt, which has an absorbance maximum of  $\sim 560$  nm [19,22,38]. A range of analogs are commercially available for esterase and lipase activity. McKeller [38] utilized  $\beta$ -naphthyl-caprylate and Fast Blue BB salt as the dye to measure lipolytic activity in raw milk. Gobbetti et al. [39] used a range of  $\beta$ -naphthyl esters from butyrate to oleate to quantify esterase and lipase activity in mesophilic and thermophilic lactobacilli. The assay involved the use of a Tris-HCl buffer at pH 7.0 to which  $\beta$ -naphthyl esters in methanol and bacterial cellular fractions were added. The mixture was incubated for 1 h at 37°C, after which Fast Garnet GBC (5 mg/mL in 10% sodium dodecyl sulfate) dye was added and color was left to develop for 15 min at room temperature. The absorbance was measured at 560 nm from a standard curve and results expressed as moles of  $\beta$ -naphthyl released per min per mg of protein.  $\alpha$ -Naphthyl esters of acetic acid have been used as the substrate and the liberated  $\alpha$ -naphthyl reacted with 2,6-dibromoquinone chloramine under suitable conditions [40]. Naphthyl esters are fat soluble and the presence of 2% milk fat in the reaction mixture is enough to markedly reduce sensitivity, which is most likely due to an inability of the enzyme to access the substrate. Turbidity due to micelles can also negatively impact on the sensitivity of the assay, but this can be elevated by the inclusion of a centrifugation step or a clarification step [4,41]. Studies do not appear to have been carried out to determine the sensitivity of naphthyl esters to nonlipolytic enzymes, but it is quite likely that they have similar limitations as *p*-nitrophenol esters.

#### 20.2.4.1.3 Resorufin Esters

Resorufin ester (1,2-*O*-diaryryl-*rac*-glycero-3-glutaric acid-resorufin ester) is another commercially available colorimetric substrate for lipolytic activity. The assay is described by Lehner and Verger

[42], where the substrate is diluted in a Tris-HCl buffer at pH 8 containing salt, Triton X-100, and sodium taurodeoxycholate. The enzyme and the mixture are incubated at 37°C. The activity is determined by cleavage of the resorufin ester on *sn*-3 position of the substrate which has an absorption maximum at 572 nm. Marangoni [43] utilized this substrate to measure lipolytic activity in microbial extracts in buffer at 40°C. However, Beisson et al. [21] found that the assay lacked sensitivity.

#### 20.2.4.1.4 Esters of 5-(4-Hydroxy-3,5-Dimethoxyphenylmethylene)-2-Thioxothiazoline-3-Acetic Acid

A method utilizing propanate, decanoate, laurate, and myristate esters of 5-(4-hydroxy-3,5-dimethoxyphenylmethylene)-2-thioxothiazoline-3-acetic acid was developed to quantify esterase activity in bacteria [44]. Once hydrolyzed the esters produce a phenol which is red and has an absorption maximum at 505 nm. Samples are incubated with the substrate in a buffer solution and the reaction terminated by the addition of 1,4-diazobicyclo (2.2.2) octane solution and results are estimated based on the use of a standard curve. The method appears more suitable for esterase activity as water solubility decreases with increased chain length of the esters. The authors also used this as a screening method to detect activity of bacterial colonies growing on agar plates. In this instance, the substrate was absorbed onto filter disks which were placed over colonies growing on agar plates. The presence of activity was indicated by the appearance of a red coloration of the disks over time. A similar method was used by Cooke et al. [45] to detect the presence of salmonellae.

#### 20.2.4.1.5 Indoxyl Acyl Substrate Analogs

The principle of the method involves the utilization of indoxyl acyl esters as a substrate, indoxyl radicals are released by lipolytic activity, which oxidize and condense to produce a blue indigo dye that can be measured calorimetrically [4]. A method to detect lipolytic activity in milk powder and yogurt was described by Allen [46]. This method appears more suitable as a qualitative technique where filter paper or test stripes are impregnated with different indoxyl substrates and contacted with test solutions [47,48]. It is possible to use a range of different indoxyl substrates to determine lipase/esterase activity in raw, pasteurized, and UHT-milk. However, this method lacks sensitivity and appears to be only suitable as a basic screening method.

#### 20.2.4.1.6 Copper Soaps

In this assay, previously liberated free fatty acids can be determined colorimetrically using a cupric acetate/pyridine reagent. Free fatty acids complex with copper to form cupric salts or soaps, benzene is added and the mixture is centrifuged. Free fatty acids partition into the benzene phase where they absorb light in the visible range (715 nm), yielding a blue color [18]. The inclusion of pyridine prevents the buildup of cupric fatty acid salts forming aggregates that would otherwise decrease the sensitivity of the assay. The activities are typically determined from a standard curve produced using oleic acid. The values are expressed as  $\mu\text{mol}$  oleic acid per mL and if the protein content of the sample is known, results can be expressed as specific activity, one unit equals 1  $\mu\text{mol}/\text{min}$  per mg of protein [18,49]. The assay has some limitations, many of the reagents are toxic and fatty acids of less than 12 carbons are less soluble in benzene, which reduces the sensitivity of the assay and thus makes it irrelevant as a measure of esterase activity. Kim et al. [50] evaluated a range



of organic solvents on the stability and catalytic activity of a microbial lipase on the hydrolysis of triacylglycerides and found that *iso*-octane and cyclohexane performed best. This method was further modified by Kwon and Rhee [51] who eliminated the centrifugation step and decreased the reaction time and increased sensitivity through the use of *iso*-octane instead benzene.

#### 20.2.4.2 Fluorimetric Assays

In general, fluorescence methods are very sensitive, quick, and easy to use. They typically involve the conversion of a nonfluorescent substrate to a fluorescent product that can be used to quantify lipolytic activity, although some assays utilize fluorescent substrates directly.

##### 20.2.4.2.1 4-Methylumbelliferone Methods

A wide variety of 4-methylumbelliferone esters are commercially available. 4-Methylumbelliferone is nonfluorescent but the product of lipolytic hydrolysis 4-methylumbelliferone is at an excitation and emission wavelength of 325 and 448 nm, respectively. Substrate emulsions are prepared in organic solvents in an aqueous buffer and the results are determined using a standard curve of 4-methylumbelliferone. 4-Methylumbelliferone exhibits optimum fluorescence in alkaline conditions, but its fluorescence characteristics are greatly affected by pH [52].

##### 20.2.4.2.2 Umbelliferly Esters

In this method a nonfluorescent substrate (umbelliferly esters) is utilized which becomes fluorescent (umbelliferone) upon hydrolysis. De Laborde de Monpezat et al. [53] described a method where the umbelliferly ester was prepared in ethylene glycol monomethyl ester and subsequently added to a Tris–maleate buffer at pH 7.4. An aqueous lipase solution was added and the reaction carried out at 30°C and fluorescence recorded over 2–3 min at an emission and excitation wavelength of 470 and 320 nm, respectively. These authors also found that umbelliferly esters were more stable than 4-methylumbelliferone.

##### 20.2.4.2.3 Pyrenic Acylglycerol Derivatives

In these methods, specific substrate analogs are prepared, triacylglycerides that have one of the alkyl groups substituted with pyrene. This molecule has high background fluorescence and the pyrene-labeled free fatty acid has to be isolated from the reaction medium to quantify activity [54]. Jaeger et al. [13] utilized a shift in fluorescence wavelength after the reaction. The isolation was eliminated by Duque et al. [55] who added trinitrophenylamine as a quencher to create 1-*O*-hexadecyl-2-pyrene-decanoyl-3-trinitrophenylaminododecanoyl-*sn*-glycerol. Thus as pyrene is released by lipolytic activity its fluorescence increases and can be measured at 342 nm excitation and 378 nm emission wavelengths, and thus can be used to continuously quantify lipolytic activity. However, this substrate was not readily hydrolyzed by many lipases, probably due to the position of pyrene and the overall structure of the analog [21].

##### 20.2.4.2.4 *p*-Nitrobenzofurazan

*p*-Nitrobenzofurazan (NBD) substrates have been widely used to quantify phospholipase activity (Hendrickson [56]). Petry et al. [57] utilized *p*-nitrobenzofurazan as a fluorescence label. They

produced a monoacylglycerol containing NBD and stabilized it in liposomes (phospholipid vesicles), which were resuspended in buffer for immediate use. The suspension was disrupted using an ultrasonic treatment which shifted the absorption maximum from 481 to 550 nm. A portion of this disrupted suspension was mixed with buffer, heated to 30°C and the lipase was added. Optical density was measured at 481 nm and recorded continuously against a control containing only buffer instead of lipase. The advantages of the assay were its high sensitivity, stability of the substrate in the presence of oxygen, however the substrate requires synthesis and has to be incorporated into liposomes for stability which greatly increases the length of time required and complexity of the assay.

#### 20.2.4.2.5 Rhodamine B

Reaction of Rhodamine B with released fatty acids from hydrolysis of triacylglycerols as described by Jette and Ziomek [58] has been used to quantify lipolytic activity. The method is flexible as a range of different substrates can be used and assay conditions can be modified accordingly [20]. However, it does not appear to be very widely used.

#### 20.2.4.3 Infrared

Infrared is not readily used to quantify lipolytic activity, but a method utilizing Fourier transform infrared spectroscopy (FTIR) is outlined.

##### 20.2.4.3.1 Fourier Transform Infrared Spectroscopy

FTIR spectroscopy was utilized to continuously quantify lipolytic activity using various vegetable oils as substrates [59]. FTIR is an analytical technique used to identify mainly organic material and measures the absorption of various infrared light wavelengths by the material of interest. These infrared absorption bands identify specific molecular components and structures. This method involved the preparation of reverse micelles. FTIR can be used because both fatty acid esters and free fatty acids have different peak maximums at 1751 and 1715  $\text{cm}^{-1}$ , respectively, and thus they can be quantified by their molar absorption coefficients and Beer's law [21]. The use of FTIR is described in more detail by Reymond [60].

### 20.2.5 Radioactive Assays

These methods are based on the use of radioactively labeled fatty acids and are highly sensitive, but cannot be utilized in continuous assays for kinetic studies as the liberated radioactive fatty acids must be separated prior to analysis using a scintillation counter.

#### 20.2.5.1 Radiolabeled Substrates

Isolation of the radioactive fatty acids is performed using chromatography or organic solvent fractionation. Fatty acids radiolabeled with  $^{63}\text{Ni}$  [61],  $^3\text{H}$  [62,63], or  $^{14}\text{C}$  [64] have been used. Deeth and Touch [4] outlined a number of drawbacks of using radiolabeled substrates which reduce their potential use; the cost of substrates, the need to purify substrates, potential hazardous effect of the substrate, the length of time required to carry out the assay, and high cost of scintillation counters.

## 20.2.6 *Chromatographic Methods*

Chromatographic methods have been widely used in lipid research, particularly gas chromatography (GC) due to its versatility, sensitivity, and relatively low cost [65]. Numerous methods have been developed and chromatography has been typically used to quantify isolated free fatty acids from natural tri-, di-, or monoacylglycerides or mixtures thereof. A study was undertaken by García-Ayuso and Luque de Castro [66] to compare various techniques to chromatography techniques used to quantify lipids in dairy products.

### 20.2.6.1 *Thin-Layer Chromatography*

Legakis and Papavassiliou [67] described a thin-layer chromatographic (TLC) technique to rapidly determine lipolytic activity of bacterial lipases. The method utilized a filter sterilized triolein emulsion in a phosphate buffer which was inoculated with different cultures. After controlled incubation samples were mixed, centrifuged, and the supernatant applied to silica plates and spots were air dried. Various chloroform solutions of free fatty acids, mono-, and diacylglycerides were used as standards. A mixture of petroleum ether, diethylether, and acetic acid was used as the developing agent. After development, spots were detected by the spray addition of copper acetate and densitometry was used to quantify activity. This technique is quite time consuming and is prone to operator error.

TLC is now more commonly utilized with radiolabeled substrates. Neutral lipids are separated on a nitrocellulose membrane in a heptane/isopropyl ether/acetic acid (60:40:4 by volume) solvent. Lipids are visualized by exposure to iodine vapor and compared to known standards. Each spot is scraped from the TLC plate and solubilized in a relevant scintillation fluid, then measured by a scintillation counter [22,68,69]. Obviously this technique suffers from some of the same drawbacks as direct methods that utilize radiolabeled substrates.

### 20.2.6.2 *Gas Chromatography*

GC is widely utilized to quantify triacylglycerols, diacylglycerols, monoacylglycerols, and free fatty acids postextraction. Kilcawley [65] provides a useful background on GC techniques and on fat isolation techniques commonly used. Many methods are available to quantify various lipids and these can be generally divided depending upon the type of detector used.

#### 20.2.6.2.1 *Flame Ionization Detection*

Flame ionization detectors (FIDs) are very common and generally known as universal detectors. The International Standard Organization method for the quantification of free fatty acids involves the production of fatty acid methyl esters (FAMES) by transesterification prior GC injection [70–72]. However, another very useful method involves the direct injection of free fatty acids by on-column injection using a free fatty acid phase column postremoval of mono-, di-, and triacylglycerides by solid-phase microextraction [73]. Kulkarni and Gadre [74] outlined another simple GC flame ionization method to quantify liberated butyric acid from a tributyrin emulsion also using a free fatty acid phase column. Quantification was based on the recovery on caproic acid which was used as an internal standard. Innocente et al. [75] quantified short-chain free fatty acids directly from a diethyl ether extract, the main advantages of the method was its rapidity and

reliability. Patel et al. [76] used a GC method to quantify trimethylsilyl derivatives of free fatty acids, mono-, di-, and triacylglycerides and glycerol using on-column inject with flame ionization detection. They carried out qualitative and quantitative chromatographic analyses using *n*-tetradecane as an internal standard. All such methods require the use of internal standards and the recovery of individual products of lipolysis of interest are based on their recovery.

#### 20.2.6.2.2 Mass Spectrometry Detection

Mass spectrometry is a technique that measures the mass to charge ratios of ions and is an excellent tool for chemical analysis. Its implementation requires suitable methods of ion generation, ion analysis, and ion detection. Different ionization techniques have been developed, such as electrospray, atmospheric pressure chemical ionization, matrix-assisted laser desorption, and different mass analyzers can be used such as ion-traps and quadrupoles depending upon the sensitivity and mass range required. This is an area that is growing rapidly especially in the study of lipidomics, which is a comprehensive approach to the analysis of lipids from biological systems [77]. Although mass spectrometry is not typically utilized to assess lipolytic activity, it is mentioned because it is best used for identification, structural, and quantification purposes of many lipid compounds.

#### 20.2.6.3 Liquid Chromatography

High-performance liquid chromatography (HPLC) is a very common laboratory procedure due to its versatility. Some of the basic methods and type of detectors used to quantify the products of lipolysis are described.

##### 20.2.6.3.1 Ultraviolet–Visible Detection

A reverse-phase HPLC method was used by Veeraragavan [78] to quantify oleic acid release from a triolein emulsion and quantified by absorption at 280 nm. The technique involves solvent extraction of the oleic acid prior to injection onto the HPLC and appears to be relatively simple and quick. Another HPLC method that has been used periodically to quantify free fatty acids involves the conversion of liberated free fatty acids to *p*-bromophenacyl esters via a crown-ether-catalyzed reaction [79–81]. Christie [82] described a HPLC to quantify free fatty acids without esterification using an ODS stationary phase column and acetic or phosphoric acid to suppress ions. These methods typically employ UV detection at 205–210 nm.

Ligand exchange columns have been adopted to quantify liberated short-chain fatty acids by HPLC at absorption wavelengths of 210–220 nm. A method was described by Guerrant et al. [83] and subsequently modified by Bouzas et al. [84] and Kilcawley et al. [85]. Maurich and Zacchigna [86] developed a method utilizing *p*-nitrophenyl acyl substrate analogs. They investigated the use of palmitic and lauric acid esters of *p*-nitrophenyl in a similar manner as described earlier, however the *p*-nitrophenyl released was quantified by a reverse-phase HPLC method at 300 nm using a standard curve generated by *p*-nitrophenyl. 2,4-Dinitroaniline was used as an internal standard. In the experiment, only *p*-nitrophenyl was released from *p*-nitrophenyllaurate and only *p*-nitrophenyl was visible in the chromatograph. The method appears to be reproducible and sensitive. Maurich et al. [87] also developed a similar method utilizing naphthyllaurate as the substrate and quantifying  $\beta$ -naphthyl by reverse-phase HPLC.

#### 20.2.6.3.2 Refractive Index Detection

This type of detector continuously monitors the difference in refractive index between an eluent and a mobile phase and is best used with isocratic elution. Refractive index detectors are very easy to operate, but sensitive to temperature changes and need to be carefully calibrated. They are not commonly used for the quantification of lipid compounds. Hein and Isengard [88] evaluated methods for the qualitative and quantitative determination of underivatized fatty acids using reverse-phase columns and refractive index and diode array detectors.

#### 20.2.6.3.3 Fluorescence Detection

While lipids in general do not have natural fluorescence they have to be converted to suitable derivatives prior to determination. Fluorescence detectors are very sensitive and can be used to detect a wide variety of lipids. Lu et al. [89] describe a method to detect long-chain free fatty acids in milk. The fatty acids are fluorogenically derivatized with 2-(2-naphthoxy)ethyl 2-(piperidino)ethanesulfonate and separated by isocratic HPLC and detected at an excitation wavelength of 235 nm and an emission wavelength of 350 nm. The method is highly sensitive to  $\mu\text{M}$  quantities.

#### 20.2.6.3.4 Mass Spectrometry Detection

Liquid chromatography mass spectrometry is fast becoming a useful technique to quantify lipid materials as the costs associated with such instrumentation decreases and advances in technology improves the ability to quantify complex lipids. A very useful review of the methods of lipid analysis by liquid chromatography mass spectrometry was given by Byrdwell [90]. Hao et al. [91] describes a quantitative liquid chromatographic mass spectrometric method to detect lipase activity. Oleic acids enzymatically released from a triolein substrate emulsion were isolated by reverse-phase HPLC, ionized in negative mode electrospray mass spectrometry and quantified with the aid of radiolabeled  $^{13}\text{C}$  oleic acid as an internal standard. The authors used micromass quadrupole-time-of-flight (Q-TOF) mass spectrometer and suggest that the need for an internal standard would be eliminated if a mass spectrometer with a greater dynamic range was used. The assay appears relatively simple, but is obviously still requires expensive detection equipment and an experienced user.

#### 20.2.6.3.5 Evaporative Light-Scattering Detection

This is often described as a universal detector and can be used for the quantification of many lipid compounds. The eluent from the HPLC column is evaporated in an air stream in a heated chamber and nebulized, it then passes through a light beam where it is reflected and refracted. The detector will respond to any solute that does not evaporate prior to passing through the light beam. The use of evaporative light-scattering detection (ELSD) in the quantification of lipids has been reviewed by Moreau and Christie [92].

#### 20.2.6.3.6 Charged Aerosol Detection

This type of detector is described as a new universal detector that can charge neutral compounds and thus enable their detection. The detection method is similar to ELSD and involves

nebulizing eluent from an HPLC column, evaporating the solvents, charging the aerosol particles, and measuring the current from the charged aerosol flux [93]. It is not suitable for short-chain volatile free fatty acids but can be used to quantify triacylglycerols, diacylglycerols, monoacylglycerols, and nonvolatile free fatty acids. It appears to be very sensitive with very good reproducibility and is easy to use. At present this detector is marketed by ESA (Corona CAD<sup>®\*</sup>).

### **20.2.7 Immunological Methods**

Immunological methods are very sensitive and easily adoptable, however only useful for purified enzyme preparations an appropriate antibody is required. The basis of the method involves the development of a color produced by an enzyme on coupling to a specific antibody. Thus, the method measures the actual amount of enzyme present rather than its activity.

#### **20.2.7.1 Enzyme-Linked Immunoassays Methods**

Deeth and Touch [4] outlined the bases of enzyme-linked immunoassays (ELISA) methods, which are performed with a solid-phase coated with antiserum and incubated with the antigen (lipase). After incubation and washing, an enzyme-labeled preparation of anti-immunoglobulin is added to react with the antigen of an antiserum to the antigen. After gentle washing, the remaining enzyme is assayed colorimetrically to determine the amount of antigen (lipase) present. Methods to quantify lipoprotein lipase activity were detailed by Anderson [94] and Vilella and Joven [95]. A range of different ELISA assays for specific lipases such as human gastric lipase and human pancreatic lipases are outlined by Beisson et al. [21], but these techniques are not readily applied for lipases in the dairy industry due to the requirements for pure enzyme preparations and the need for specific poly- or monoclonal antibodies.

### **20.2.8 Surface Tension Methods**

Lipases work at an interface between a hydrophobic substrate and a hydrophilic water phase and the activity of the lipase alters the surface tension. For example, as milk fat is hydrolyzed a decrease in surface tension occurs due to the movement of the liberated molecule from the hydrophobic to the hydrophilic phase and this change in surface tension can be used to quantify lipolytic activity.

#### **20.2.8.1 Oil Drop Method**

This method consists of forming an oil drop from a syringe containing the oil. The shape of the oil droplet is directly correlated to the interfacial surface tension. Increase in lipolysis caused the oil droplet to change from an apple to a pear shape until it can no longer support itself. Specialized oil drop tensiometers or digital cameras with appropriate software can quantify minute changes in the droplet. The disadvantages of this method are that it requires high-quality equipment, requires pure unhydrolyzed oils and takes considerable experience to get reliable reproducible results.

### 20.2.8.2 Monomolecular Films (Wilhelmy Plate Method)

This technique involves the use of a Teflon trough filled with an aqueous solution. A thin platinum plate connected to an electromicrobalance is dipped into the surface of the aqueous phase. The electromicrobalance measures the surface pressure, which is directly related to the interfacial tension. A monomolecular film of lipids is spread across the surface of the aqueous solution. The addition of a lipase causes a reduction in the surface pressure which can be measured. This method is very sensitive and kinetic measurements can be measured using only very small amounts of lipids. However, this method measures an air–water interface and it is not fully ascertained as to how representative this is of an actual oil–water interface. This method is explained in detail by Beisson et al. [21].

## References

1. MacGibbon, A.K.H. and Taylor, M.W., Composition and structure of bovine milk lipids, in *Advanced Dairy Chemistry*, Vol. 2, 3rd edn., Fox, P.F. and McSweeney, P.L.H., Eds., Springer, New York, 2006, Chap. 1.
2. Balcão, V.M. and Malcata, F.X., Enzyme-mediated modification of milkfat, in *Lipid Biotechnology*. Kuo, T.M. and Gardner, H.W., Eds., Marcel Dekker, New York, 2002, Chap. 23.
3. Banks, W., Milk lipids, in *Utilizations of Milk Fat, Bulletin 260*, International Dairy Federation, Brussels, 1991, Chap. 1.
4. Deeth, H.C. and Touch, V., Methods for detecting lipase activity in milk and milk products, *Aust. J. Dairy Technol.*, 55, 153, 2000.
5. Chich, J.F., Marchesseau, K., and Gripon, J.C., Intercellular esterase from *Lactococcus lactis* subsp. *Lactis* NCDO 763: Purification and characterization, *Int. Dairy J.*, 7, 169, 1997.
6. Collins, Y.F., McSweeney, P.L.H., and Wilkinson, M.G., Lipolysis and free fatty acid catabolism in cheese: A review of current knowledge, *Int. Dairy J.*, 13, 841, 2003.
7. Villeneuve, P. and Foglia, T.A., Lipase specificities: Potential applications in lipid bioconversions, *Inform.*, 8, 640, 1997.
8. Diks, R.M., Production and modification of acylglycerides, in *Handbook of Food Enzymology*, Whitaker, J.R., Voragen, A.G.J., and Wong, D.W.S., Eds., Marcel Dekker, New York, 2003, Chap. 18.
9. Verger, R., 'Interfacial activation' of lipases: Facts and artefacts, *Trends Biotechnol.*, 15, 32, 1997.
10. Holland, R., Liu, S.-Q., Crow, V.L., Delabre, M.-L., Lubbers, M., Bennet, M., and Norris, G., Esterases of lactic acid bacteria and cheese flavour: Milk fat hydrolysis, alcoholysis and esterification, *Int. Dairy J.*, 15, 711, 2005.
11. Villeneuve, P., Muderhwa, J.M., Graille, J., and Haas, M.J., Customizing lipase for biocatalysis: A survey of chemical, physical and molecular biological approaches. *J. Mol. Catal.*, 9, 113, 2000.
12. Kilara, A., Enzyme-modified lipid food ingredients, *Process Biochem.*, 20 (2), 35, 1985.
13. Jaeger, K.E., Ransac, S., Dijkstra, B.W., Colson, C., van Heuvel, M., and Misset, O., Bacterial lipases, *FEMS Microbiol. Rev.*, 15, 29, 1994.
14. Jaeger, K.E. and Eggert, T., Lipases for biotechnology, *Curr. Opin. Biotechnol.*, 13, 390, 2002.
15. Chen, L., Daniel, R.M., and Coolbear, T., Detection and impact of protease and lipase activities in milk and milk powders, *Int. Dairy J.*, 13, 255, 2003.
16. Jensen, R.G., Ferris, A.M., and Lammi-Keefe, C.J., The composition of milk fat, *J. Dairy Sci.*, 74, 3228, 1991.
17. Lowe, M.E., Assays for pancreatic triglyceride lipase and colipase, in *Methods in Molecular Biology: Lipase and Phospholipase Protocols*, Vol. 109, Doolittle, M.H. and Reue, K., Eds., Humana Press, Totowa, NJ, 1999, Chap. 7.

18. Wrolstad, R.E., Acree, T.E., Decker, E.A., Penner, M.H., Reid, D.S., Schwartz, S.J., Shoemaker, C.F., and Sporns, P., Lipolytic enzymes, in *Handbook of Food Analytical Chemistry*, Vol. 1, Wrolstad, R.E., Acree, T.E., Decker, E.A., Penner, M.H., Reid, D.S., Schwartz, S.J., Shoemaker, C.F., and Sporns, P, Eds., Wiley & Sons, Hoboken, NJ, 2005, Section C.
19. Deeth, H.C. and Fitz-Gerald, C.H., Lipolysis in dairy products: A review, *Aust. J. Dairy Technol.*, 31, 53, 1976.
20. Gupta, R., Rathi, P., Gupta, N., and Bradoo, S., Lipase assays for conventional and molecular screening: An overview, *Biotechnol. Appl. Biochem.*, 37, 63, 2003.
21. Beisson, F., Tiss, A., and Rivière, R.V., Methods for lipase detection and assay: A critical review, *Eur. J. Lipid Sci. Technol.*, 2, 133, 2000.
22. Gilham, D. and Lehner, R., Techniques to measure lipase and esterase activity in vitro, *Methods*, 36, 139, 2005.
23. Wilson, D.E., Flowers, C.M., and Reading, J.C., Validation of a clearing assay for milk lipoprotein lipase in agarose gel, *J. Lipid Res.*, 14, 124, 1973.
24. Lawrence, R.C., Fryer, T.F., and Reiter, B., Rapid method for the quantitative estimation of microbial lipases, *Nature*, 213 (5082), 1264, 1967.
25. Christen, G.L. and Marshall, R.T., Selected properties of lipase and protease of *Pseudomonas fluorescens* 27 produced in four media, *J. Dairy Sci.*, 67, 1680, 1984.
26. Kouker, G. and Jaeger, K.E., Specific and sensitive assay for bacterial lipases, *Appl. Environ. Microbiol.*, 53, 211, 1987.
27. Richardson, G.H., *Standard Methods for the Examination of Dairy Products*, 15th edn., American Public Health Association, Washington, DC, 327, 1985.
28. International Dairy Federation, Routine methods for determination of free fatty acids in milk, in *Monograph on Determination of Free Fatty Acids in Milk and Milk Products*, Bulletin of the International Dairy Federation, No. 265, 26, 1991.
29. Deeth, H.C., Fitz-Gerald, C.H., and Wood, A.F., A convenient method for determining the extent of lipolysis in milk, *Aust. J. Dairy Technol.*, 30, 109, 1975.
30. Evers, J.M., Determination of free fatty acids in milk using the BDI method—some practical and theoretical aspects, *Int. Dairy J.*, 13, 111, 2003.
31. Case, R.A., Bradley, R.L. Jr, and Williams, R.R., Chemical and physical methods, in *Standard Methods for the Examination of Dairy Products*, 15th edn., Richardson, G.H., Ed., American Public Health Association, Washington, DC, 1985.
32. International Standard., *Milkfat Products and Butter—Determination of Fat Acidity*. International Organization for Standardization, Geneva, Switzerland, ISO 1740, 2004.
33. Kilcawley, K.N., Wilkinson, M.G., and Fox, P.F., A novel two-stage process for the production of enzyme-modified cheese, *Food Res. Int.*, 39, 619, 2006.
34. Pencreac'h, G. and Baratti, J.C., Hydrolysis of *p*-nitrophenyl palmitate in *n*-heptane by the *Pseudomonas cepacia* lipase: A simple test for the determination of lipase activity in organic media, *Enzyme Microbiol. Technol.*, 18, 417, 1996.
35. Maurich, V. and Zacchigna, M., *p*-Nitrophenyllaurate: A substrate for the high-performance liquid chromatographic determination of lipase activity, *J. Chromatogr.*, 566, 453, 1991.
36. Østdal, H. and Andersen, H.J., Non-enzymic protein induced hydrolysis of *p*-nitrophenyl acyl esters in relation to lipase/esterase assays, *Food Chem.*, 55, 55, 1996.
37. Blake, M.R., Koka, R., and Weimer, B.C., A semiautomated reflectance colorimetric method for the determination of lipase activity in milk, *J. Dairy Sci.*, 79, 1164, 1996.
38. McKellar, R.C., Colorimetric assay for lipases. *Dairy Ind. Int.*, 51 (12), 19, 1986.
39. Gobbetti, M., Fox, P.F., and Stepaniak, L., Esterolytic and lipolytic activities of mesophilic and thermophilic lactobacilli, *Ital. J. Food Sci.*, 2, 127, 1996.
40. Greenbank, G.R., A colorimetric determination of lipase, *J. Dairy Sci.*, 33, 396, 1950.



41. Versaw, W.K., Cuppett, S.L., Winters, D.D., and Williams, L.E., An improved colorimetric assay for bacterial lipase in nonfat dry milk, *J. Food Sci.*, 54, 1557, 1989.
42. Lehner, R. and Verger, R., Purification and characterization of a porcine liver microsomal triacylglycerol hydrolyase, *Biochemistry*, 36, 1861, 1997.
43. Marangoni, A.G., Candida and Pseudomonas lipase-catalyzed hydrolysis of butteroil in the absence of organic solvents, *J. Food Sci.*, 59 1096, 1994.
44. Miles, R.J., Siu, E.L., Carrington, C., Richardson, A.C., Smith, B.V., and Price, R.G., The detection of lipase activity in bacteria using novel chromogenic substrates, *FEMS Microbiol. Lett.*, 90, (3), 283, 1992.
45. Cooke, V.M., Miles, R.J., Price, R.G., and Richardson, A.C., A novel chromogenic ester agar medium for detection of Salmonellae, *Appl. Environ. Microbiol.*, 65, 807, 1999.
46. Allen, J.C., Rancidity in dairy products, in *Rancidity in Foods*, Allen, J.C. and Hamilton, R.J., Eds., Blackie Academic and Professional, Glasgow, U.K., 1994, Chap. 10.
47. Slack, P., *Analytical Methods Manual*, 2nd edn., Leatherhead Food Research Association, U.K., 1987.
48. Brand, E., Liaudat, M., Olt, R., and Linxweiler, W., Rapid determination of lipase in raw, pasteurized and UHT-milk, *Milchwissenschaft*, 55 (10), 573, 2000.
49. Lowry, R.R. and Tinsley, I.J., Rapid colorimetric determination of free fatty acids, *J. Am. Oil Chem. Soc.* 53, 430, 1976.
50. Kim, K.H., Kwon, D.Y., and Rhee, J.S., Effects of organic solvents on lipase for fat splitting, *Lipids*, 19 (12), 975, 1984.
51. Kwon, D.Y. and Rhee, J.S., A simple and rapid colorimetric method for determination of free fatty acids for lipase assay, *J. Am. Oil Chem. Soc.*, 63 (1), 89, 1986.
52. Stead, D., Microbial lipases: Their characteristics, role in food spoilage, and industrials used, *J. Dairy Res.*, 53, 481, 1986.
53. De Laborde de Monpezat, T., De Jeso, B., Butour, J.-L., Chavant, L., and Sancholle, M., A fluorimetric method for measuring lipase activity based on umbelliferyl esters, *Lipids*, 25 (10), 661, 1990.
54. Nègre, A.E., Salvayre, R.S., Dagan, A., and Gatt, S., New fluorometric assay of lysosomal acid lipase and its applications to the diagnosis of Wolman and cholesteryl ester storage diseases, *Clin. Chim. Acta*, 149, 81, 1985.
55. Duque, M., Graupner, M., Stutz, H., Wicher, I., Zechner, R., Paltauf, F., and Hermetter, A., New fluorogenic triacylglycerol analogs as substrates for the determination and chiral discrimination of lipase activities, *J. Lipid Res.*, 37, 868, 1996.
56. Hendrickson, H.S., Fluorescence-based assays of lipases, phospholipases, and other lipolytic enzymes, *Anal. Biochem.*, 219, 1, 1994.
57. Petry, S., Ben Ali, Y., Chahinian, H., Jordan, H., Kleine, H., Muller, G., Carrière, F., and Abousalham, A., Sensitive assay for hormone-sensitive lipase using NBD-labeled monoacylglycerol to detect low activities in rat adipocytes, *J. Lipid Res.*, 46, 603, 2005.
58. Jette, J.F. and Ziomek, Z., Determination of lipase activity by a rhodamine-triglyceride-agarose assay, *Anal. Biochem.*, 219, 256, 1994.
59. Walde, P. and Luisi, P.L., A continuous assay for lipase in reverse micelles based on Fourier transform infrared spectroscopy, *Biochemistry*, 28, 3353, 1989.
60. Reymond, J.L., High-throughput screening for assaying the enantioselectivity of enzymes, in *High-throughput Screening, Genetic Selection and Fingerprinting*, Reymond, J.L., Ed., Wiely-VCH Verlag GmbH, 2006, Chap. 2.
61. Huang, J., Roheim, P.S., Sloop, C.H., and Wong, L., A sensitive, inexpensive method for determining minute quantities of lipase activity, *Anal. Biochem.*, 179, 413, 1989.
62. Nilsson-Ehle, P. and Schotz, M.C., A stable radioactive substrate emulsion for assay of lipoprotein lipase, *J. Lipid Res.*, 17, 536, 1976.
63. Clegg, R.A., Activation of milk lipase by serum proteins: A possible role in the occurrence of lipolysis in raw bovine milk, *J. Dairy Res.*, 47, 61, 1980.

64. Scott, K., The measurement of esterase activity in cheddar cheese, *Aust. J. Dairy Technol.*, 20, 36, 1965.
65. Kilcawley, K.N., Chromatographic methods for lipid analysis, in *Advanced Dairy Chemistry*, Vol. 2, 3rd edn., Fox, P.F and McSweeney, P.L.H, Eds., Springer, New York, 2006, Chap. 19.
66. García-Ayuso, L.E. and Luque de Castro, M.D., A comparative study between chromatography and other techniques for the quantification of triglycerides and fatty acids in dairy products, *Sem. Food Anal.*, 4, 39, 1999.
67. Legakis, N. and Papavassiliou, J., A thin-layer chromatographic technique for rapid estimation of bacterial lipases, *J. Appl. Bacteriol.* 37, 341, 1974.
68. Lehner, R. and Kuksis, A., Utilization of 2-monoacylglycerols for phosphatidylcholine biosynthesis in the intestine, *Biochim. Biophys. Acta*, 1125, 171, 1992.
69. Lehner, R. and Vance, D.E., Cloning and expression of cDNA encoding a hepatic microsomal lipase that mobilizes stored triacylglycerol, *Biochem. J.*, 343, 1, 1999.
70. Martín-Hernández, M.C., Alonso, L., Juárez, M., and Fontecha, J., Gas chromatographic method for determining free fatty acids in cheese, *Chromatographia*, 25, 87, 1988.
71. International Standard, *Milk and Milk Products-Extraction Methods for Lipids and Liposoluble Compounds*. International Organization for Standardization, Geneva, Switzerland, ISO 15884, 2002.
72. International Standard, *Milk Fat—Determination of the Fatty Acid Composition by Gas Liquid Chromatography*. International Organization for Standardization, Geneva, Switzerland, ISO 15885, 2002.
73. De Jong, C. and Badings, H.T., Determination of free fatty acids in milk and cheese. Procedures for extraction, clean up and capillary gas chromatographic analysis, *J. High Res. Chromatogr.*, 13, 94, 1990.
74. Kulkarni, N. and Gadre, R.V., Simple gas chromatography method for lipase assay, *Biotechnol. Tech.*, 12 (8), 627, 1998.
75. Innocente, N., Moret, S., Corradini, C., and Conte, L.S. A rapid method for the quantitative determination of short-chain free volatile fatty acids from cheese, *J. Agric. Food Chem.*, 48, 3321, 2000.
76. Patel, T.P., Nagarajan, R., and Kilara, A., Hydrolysis of milk fat by lipase in solvent-free phospholipid reverse micellar media, *J. Food Sci.*, 61, 33, 1996.
77. Brown, H.A., Lipodomics and bioactive lipids: Mass spectrometry based lipid analysis, in *Methods in Enzymology*, Vol. 432, Academic Press, Boston, MA, 2007.
78. Veeraragavan, K., A simple and sensitive method for the estimation of microbial lipase activity, *Anal. Biochem.*, 186, 301, 1990.
79. Reed, A.W., Deeth, H.C., and Clegg, D.E., Liquid chromatographic method for the quantitative determination of free fatty acids in butter, *J. Assoc. Off. Anal. Chem.*, 67 (4), 718, 1984.
80. Elliott, J.M., de Hann B., and Parkin, K.L., An improved liquid chromatographic method for the determination of free fatty acids in milk products, *J. Dairy Sci.*, 72, 2478, 1989.
81. Garcia, H.S., Reyes, H.R., Malcata, F.X., Hill, C.G. Jr, and Amundson, C.H., Determination of the major free fatty acids in milkfat using a three-component mobile phase for HPLC analysis, *Milchwissenschaft*, 45, 757, 1990.
82. Christie, W.W., Analysis of fatty acids by high-performance liquid chromatography, *Lipid Technol.*, 9, 124, 1997
83. Guerrant, G.O., Lambert, M.A., and Moss, C.W., Analysis of short chain acids from anaerobic bacteria by high-performance liquid chromatography, *J. Clin. Microbiol.*, 16, 355, 1982.
84. Bouzas, J.C.A., Kantt, F., Bodyfelt, F., and Torres, J.A., Simultaneous determination of sugars and organic acids in Cheddar cheese by high-performance liquid chromatography, *J. Food Sci.*, 56, 276, 1991.
85. Kilcawley, K.N., Wilkinson, M.G., and Fox, P.F., A survey of lipolytic and glycolytic end-products in commercial Cheddar enzyme-modified cheese, *J. Dairy Sci.*, 84, 66, 2001.
86. Maurich, V. and Zacchigna, M., *p*-Nitrophenyllaurate: A substrate for the high-performance liquid chromatographic determination of lipase activity, *J. Chromatogr.*, 566, 453, 1991.

87. Maurich, V., Moneghini, M., Zacchigna, M., Pitotti, A., and Lencioni, E., High-performance liquid chromatographic assay of pancreatic lipase activity, *J. Pharm. Biomed. Anal.*, 9 (5), 427, 1991.
88. Hein, M and Isengard, H.-D., Determination of underivatized fatty acids by HPLC, *Z. Lebensm. Unters Forsch. A.*, 204, 420, 1997.
89. Lu, C.Y., Wu, H.L., Chen, S.H., K, H.S., and Wu, S.M., Simple and sensitive analysis of long-chain free fatty acids in milk by fluorogenic derivatization and high-performance liquid chromatography, *J. Agric. Food Chem.*, 50, 71, 2002.
90. Byrdwell, W.C., *Modern Techniques for Lipid Analysis by Liquid Chromatography/Mass Spectrometry and Related Techniques*, AOCS Press, Champaign, IL, 2005.
91. Hao, G., Yang, L., Mazsaroff, I., and Lin, M., Quantitative determination of lipase activity by liquid chromatography–mass spectrometry, *J. Am. Soc. Mass Spectrom.*, 18, 1579, 2007.
92. Moreau, R.A. and Christie, W.W., The impact of evaporative light-scattering detectors on lipid research, *INFORM*, 10, 471, 1999.
93. Moreau, R.A., The analysis of lipids via HPLC with a charged aerosol detector, *Lipids*, 41 (7), 727, 2006.
94. Anderson, M., Enzyme-immunoassay for measuring lipoprotein lipase activators in milk, *J. Dairy Sci.*, 62, 1380, 1979.
95. Vilella, E. and Joven, J., In vitro measurement of lipoprotein and hepatic lipases, *Methods Microbiol.*, 110, 243, 1998.

## *Chapter 21*

---

# **Characterization of Lactic Acid Bacteria Used as Starter Cultures**

---

Teresa Requena and Carmen Peláez

### **CONTENTS**

21.1	Introduction .....	450
21.2	Enumeration and Identification of LAB in Starter Cultures.....	450
21.2.1	Culture Methods for Enumeration of LAB.....	450
21.2.2	Phenotypic Methods for Identification of LAB.....	451
21.2.3	Molecular Methods for Species and Strains Identification .....	452
	21.2.3.1 Culture-Dependent Methods.....	452
	21.2.3.2 Culture-Independent Methods .....	453
21.3	Technological Characteristics of LAB as Starter Cultures .....	454
21.3.1	Acidification and Diacetyl Production.....	454
21.3.2	Proteolysis.....	454
21.3.3	Amino Acid Catabolism .....	455
21.3.4	Bacteriophage Resistance Analysis .....	458
21.3.5	Production of Exopolysaccharides.....	459
21.3.6	Production of Antimicrobial Compounds .....	460
21.4	Production and Maintenance of LAB Starters.....	461
21.5	Future Trends.....	462
	Acknowledgment .....	463
	References .....	463

## 21.1 Introduction

Lactic acid bacteria (LAB) are a heterogeneous group of functionally related Gram positive bacteria that can be found in a wide range of habitats that includes dairy, meat, and vegetable environments. The most common genera of LAB found in dairy starter cultures are *Lactococcus*, *Lactobacillus*, *Streptococcus*, and *Leuconostoc*. LAB starter cultures may consist of single strains used alone or in combinations as mixed strain or multiple-species starter cultures. Cultures can also be either mesophilic (optimal growth at approximately 26°C) or thermophilic (optimal growth at approximately 42°C). During dairy fermentation processes, LAB produce mainly lactic acid from lactose, providing an effective method of preserving the final product. In addition to rapid acid production, LAB used in commercial starter cultures are selected for their contribution to a variety of desirable product characteristics, such as, flavor, aroma, texture, and biopreservation.

This chapter describes methodologies currently in use for the selection and analysis of LAB strains to be employed as starter cultures in dairy fermentations. The aspects addressed are the methods for enumeration and identification of LAB strains, the evaluation of their technological properties for improving processing conditions and product quality during dairy fermentations, and the conditions for the production and maintenance of LAB starters.

## 21.2 Enumeration and Identification of LAB in Starter Cultures

### 21.2.1 Culture Methods for Enumeration of LAB

The basis of culturing techniques for starter culture enumeration and identification involves plating out dilutions of samples previously homogenized in a sterile solution such as sodium citrate or Ringer. Enumeration of specific bacterial genera is generally achieved by plating on selective media. Selective media are based on biochemical characteristics (oxygen tolerance, antibiotic resistance, fermentation patterns, etc.), and conditions for growth to enumerate bacteria selectively by changing the incubation temperature or by changing pH. Several agents such as bile, esculin, organic acids, LiCl, or antibiotics can be used for selective enrichment for certain species, although the use of selective agents would underestimate the species counts.

Enumeration of lactococci and *Streptococcus thermophilus* is commonly performed in M17 agar [1] and plates incubated aerobically at 30°C during 72 h for lactococci and for *S. thermophilus* at 37°C for 48 h. Lactobacilli are generally isolated on rich media such as de Man, Rogosa, and Sharpe (MRS) [2], which is routinely used for the isolation and counting of lactobacilli from most fermented products, and plates are incubated anaerobically at 37°C for 72 h. Plating on MRS agar adjusted to pH 5.4 is normally used to enumerate lactobacilli in starter cultures containing also *S. thermophilus*. Facultative and obligate heterofermentative lactobacilli and leuconostocs are vancomycin resistant and can be isolated using MRS agar containing vancomycin [3].

The presence of multiple and closely related species in dairy fermented products makes the differential enumeration of LAB difficult due to similarity in growth requirements and overlapping biochemical profiles of the species. Tabasco et al. [4] described selective plating methodologies for enumeration of mixed cultures of *S. thermophilus*, *Lactobacillus delbrueckii* susp. *bulgaricus*, *Lactobacillus acidophilus*, and *Lactobacillus casei* subsp. *casei* based on antibiotic-free media, carbohydrate fermentation patterns and different incubation conditions. Selective enumeration of *S. thermophilus* can be performed in M17 agar containing lactose and incubation in aerobiosis

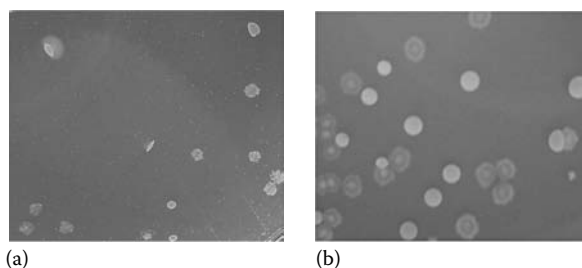
at 45°C for 24 h. For enumeration of *L. delbrueckii* subsp. *bulgaricus*, appropriate dilutions are pour-plated into MRS fermentation agar [2], which does not contain either glucose or meat extract, enriched with 0.2% Tween 80 and supplemented with 1% fructose, 0.8% casein acid hydrolysate and 0.05% cysteine. Plates are incubated in anaerobiosis at 45°C for 72 h and lenticular colonies of *L. delbrueckii* subsp. *bulgaricus* can easily be differentiated from cottony-fluffy colonies of *L. acidophilus* (Figure 21.1a). Enumeration of *L. acidophilus* in the mixed culture can be performed by spreading out appropriate dilutions onto the MRS fermentation agar supplemented with 1% maltose. Plates are incubated in a 20% CO<sub>2</sub> atmosphere incubator at 37°C for 72 h. Flat, rough egg-shaped colonies correspond to *L. acidophilus*, whereas *L. casei* subsp. *casei* develops as white, smooth, and circular colonies (Figure 21.1b).

### 21.2.2 Phenotypic Methods for Identification of LAB

Upon isolation of colonies, the isolates are likely to be identified to the species or strain level. The phenotypical characterization requires several biochemical tests, and the accuracy of the identification will increase with more tests that are carried out. Phenotypic taxonomic criteria used for differentiation include morphological appearance, growth temperature range, fermentation end products, carbohydrate fermentation, and fingerprint techniques based on phenotypic characteristics.

Bacterial isolates are examined for colony and cell appearance (rod or coccus). For lactobacilli, however, cell morphology varies widely from long, straight, or slightly crescent shaped rods to coryneform coccobacilli [3]. Based on fermentation end products, LAB degrade carbohydrates either to lactate (homofermentatives) or to lactate and additional products such as acetate, ethanol, carbon dioxide, formate, or succinate (heterofermentatives). The fermentative differentiation can be analyzed by following the production of CO<sub>2</sub> from glucose in M17 or MRS broth using Durham tubes or agar plugs. Phenotypical analysis of LAB isolates for identification at species level can be performed by combination of several tests and ready-to-inoculate identification commercial kits such as API 50-CH, PhenePlate system, LRA Zym, and API Zym tests.

Fingerprint techniques based on phenotypic characteristics have been developed to search for LAB species variability. The phenotypic fingerprint most used for LAB classification is the total soluble cytoplasmic protein profile obtained by sodium dodecyl sulfate polyacrylamide gel electrophoresis (SDS-PAGE) [5]. To obtain reproducible patterns, the procedure requires that the bacteria



**Figure 21.1** Morphological differentiation on selective agar media of (a) *L. delbrueckii* subsp. *bulgaricus* (lenticular colonies) from *L. acidophilus* (cottony-fluffy colonies) and (b) *L. acidophilus* (egg-shaped colonies) from *L. casei* (white colonies).

should be grown under highly standardized conditions. SDS-PAGE separates proteins exclusively according to molecular weight. Native (nondenaturing) PAGE can be used as a complementary technique, separating cell proteins according to their charge and size. Protein profiles can be stored in database format, including reference patterns of type strains, and may be routinely used to confirm the identity of strains at species level or to show the similarity of strains within the same species or subspecies.

Another protein fingerprinting technique currently in use is the analysis of electrophoretic mobilities of intracellular enzymes named multilocus enzyme electrophoresis. The method is based on that about 50% of all enzymes exist in multiple molecular forms. The differences are related to mutations at the gene locus that cause amino acid substitutions in the enzyme. Difference in the electrostatic charge between the original and substituted amino acid will affect the net charge of the enzyme, and hence its electrophoretic mobility. The protein-soluble extracts are separated by electrophoresis under native conditions (starch, polyacrylamide, and cellulose acetate), and the location of enzymes in the gel after electrophoresis can be determined by the enzymes catalyzing specific reactions with a colored substrate or by yielding a colored product. The electrophoretic mobility of lactate dehydrogenase in starch gels and in polyacrylamide gels has been used to discriminate between *Lactobacillus* spp. [6] Lortal et al. [7] have used the peptidoglycan hydrolase patterns of industrial starters for species identification.

### **21.2.3 Molecular Methods for Species and Strains Identification**

#### **21.2.3.1 Culture-Dependent Methods**

Advances in molecular techniques have represented a meaningful improvement to reliably identify LAB isolates. The most used method for taxonomic identification is the sequencing of the 16S rRNA gene amplified by PCR using primers directed at universally conserved regions [8]. This approach is based on the universal presence of rRNA genes and that its nucleotide sequence can be used for phylogenetic classification and for the accurate typing of unknown isolates, given that the available database of 16S rRNA gene sequences is by far the most extensive among bacterial genes. Within several species (e.g., *L. casei* group) the rRNA sequence may not be enough for the desired level of identification. The nucleotide sequence of the region between the 16S and 23S rRNA genes, termed the internal transcribed spacer, can be used for identification [9]. The region is universally present in bacteria, but exhibits very low sequence conservation, and then PCR can be used to amplify the region using primers directed at universally conserved regions within the bordering 16S and 23S rRNA genes. The restriction of the 16S rRNA gene with an appropriate restriction enzyme and the separation of fragments by agarose gel electrophoresis result in a characteristic pattern of DNA fragments that is referred to as a restriction fragment length polymorphism (RFLP) and is specific of the particular genus or species [10].

The randomly amplified polymorphic DNA (RAPD) method is a PCR-based DNA fingerprinting technique that uses arbitrary primers to study genomic DNA polymorphism. A single arbitrary oligonucleotide primer of about 10 nucleotides long is used for the amplification of random segments of genomic DNA and it generates a characteristic spectrum of short DNA products of various lengths. The RAPD technique has been extensively used for the typing of LAB [11] and to monitor population dynamics in dairy fermentations [12]. The RAPD analysis is suitable for revealing species-specific genetic profiles and for individual strain differentiation [13]. It is also possible to use a combination of two or more oligonucleotides (multiplex RAPD) in a single PCR to generate RAPD profiles reliable for typing strains [14].

The digestion of the bacterial genome into relatively few (5–50) large fragments, by using rare cutting restriction enzymes that generally have an 8 bp recognition site or a statistically rare 6 bp recognition site, results in a highly characteristic RFLP pattern. Due to the large size of the fragments, all manipulations are carried out on cells embedded in agarose plugs, inserted after digestion in a well in an agarose gel and separated by pulsed field gel electrophoresis (PFGE). PFGE is considered the gold standard of molecular genotyping methods, which is also appropriate for bacterial typing at the strain level [15]. PCR amplification of repetitive bacterial DNA elements (rep-PCR) has also been recognized as a simple PCR-based technique with a high discriminatory power. For example in lactobacilli, rep-PCR has demonstrated that it was more rapid and reproducible, and has a higher resolution than PFGE for reliably determining the identity isolates at the strain level [16]. The primer GTG<sub>5</sub> (5'-GTG GTG GTG GTG GTG-3') is recommended for LAB identification by rep-PCR [17].

### 21.2.3.2 Culture-Independent Methods

Culture-independent methods for bacterial identification based on genetic analysis have become a valuable tool, since these techniques have the advantage to analyze the product as a whole. Separation of genus or species-specific PCR products by denaturing gradient gel electrophoresis (DGGE) has become the most commonly used technique among the culture-independent fingerprinting techniques for detection and identification of LAB from fermented products [18]. DGGE is an electrophoretic method capable of separating individual genes and although the amplicons are of the same length, electrophoresis through a linearly increasing gradient of denaturants can separate the products of different sequence based on their differential denaturation (melting) profile. Melting changes the conformation of the DNA molecule, slowing its migration through the gel. Urea and formamide are generally used to form the denaturing gradient. Temperature can also be used, thus creating a temperature gradient gel electrophoresis (TGGE). To prevent complete dissociation of the double stranded DNA, a GC clamp consisting of 30–50-GC bases attached to the 5' region of one of the primers can be used, which in addition insures that the fragment is in the lowest melting domain.

Multiplex PCR is used to amplify a specific DNA sequence but more than one set of primers is included to enable the simultaneous amplification of a number of target DNA regions. In order to guarantee the specificity of the system (a unique target sequence per primer pair), it is fundamental to design primers longer than those used in monoplex PCR and characterized by a higher melting temperature. The technique allows to rapidly detecting multiple microorganisms in a single PCR assay and, with respect to DGGE, it enables the direct identification of various species and represents the fastest culture-independent approach for species-specific detection in complex matrices. Thus, multiplex PCR might also be useful to define the structure of certain microbial communities and to evaluate community dynamics, e.g., during fermentation or in response to environmental variations [19].

Fluorescent-labeled probes targeting 16S rRNA-specific domains have been developed for the in situ identification of individual microbial cells that can be visualized by fluorescent in situ hybridization (FISH). This culture-independent technique is the most commonly applied among the non-PCR-based molecular techniques [20]. Cells are fixed on a glass slide and the fixing process permeates the cells to allow the short probes to access the nucleic acid inside the cell. The cells with the hybridized fluorescent probe can be visualized by fluorescent microscopy or flow cytometry. By the use of rRNA targeted probes, in contrast to the DGGE approach, FISH would detect only the viable fraction of the specific groups of bacteria within the matrix under study [21].



The simultaneous enumeration and identification of viable LAB in fermented dairy products can be performed with real-time PCR (RTi-PCR) by using species-specific primers and DNA intercalating agents to distinguish between live and dead bacteria [22]. The procedure combines both the sensitivity and specificity of the RTi-PCR and the use of propidium monoazide (PMA) to prevent amplification of DNA from damaged cells. The viable cells with intact membranes are impermeable to the passage of PMA that, however, easily penetrates damaged membranes and binds covalently to DNA upon light exposure. This modification prevents the DNA from being amplified by PCR. The effectiveness of this agent in the enumeration of viable cells has been demonstrated in pure cultures of different Gram negative and Gram positive species [23].

## 21.3 Technological Characteristics of LAB as Starter Cultures

Selection criteria for valuable technological properties of LAB strains to use as starter cultures incorporate considerations for improving processing conditions and product quality. Several properties of LAB, such as, rapid acidification, proteinase, and peptidase activities, production of volatile compounds, resistance to bacteriophages, production of inhibitory compounds, etc., are important for their use as starters or adjuncts and have been evaluated in screening and characterization studies.

### 21.3.1 Acidification and Diacetyl Production

The main criterion for selecting LAB starters is a rapid acid production. The acidification activity is commonly determined in heat-treated (15 min at 115°C) 100 g/L reconstituted skim milk and inoculated with a fresh overnight culture of the tested strain or with a specified quantity of starter culture. The acidification activity can be described as (1) the time the starter takes to start acidifying milk from the inoculation time, (2) the pH after a certain time (4, 6, or 24 h) of milk acidification at 30°C, 37°C, or 43°C, depending on the characteristics of the starter culture, and (3) the time needed to acidify the milk to a certain pH and it depends on the characteristics of the starter culture and the application for which it is used (e.g., pH 4.5 for yoghurt production). The acidification activity can be measured during incubation by continuous pH measurements using a pH electrode and a data logger [24].

Selection of LAB strains as starter cultures is also based on their capacity to produce diacetyl, which is an important flavor compound in dairy products characterized for providing a typical butter aroma. It is usually produced during cometabolic conversion of oxidized carbon sources, such as citrate. Diacetyl production has been determined traditionally by colorimetric determination [25], but the determination is not specific and diacetyl is measured in combination with acetoin. Phalip et al. [26] described a method for screening diacetyl and acetoin-producing bacteria on agar plates by visualizing, in the presence of creatine, the formation of a red insoluble complex resulting from the reaction between acetoin and/or diacetyl and  $\alpha$ -naphthol. Recent studies use headspace techniques coupled with gas chromatography (GC) and using flame-ionization or mass spectrometer (MS) detectors to determine the diacetyl production by starter bacteria [27,28].

### 21.3.2 Proteolysis

Associated with the acidic production is the LAB proteolytic capacity that ensures rapid growth of starter cultures in milk, thereby warranting successful fermentation. In general, the utilization

of casein by LAB is initiated by a cell-wall-bound proteinase (PrtP) that degrades casein into oligopeptides that are subsequently taken up by the cells via specific peptide transport systems for further degradation into shorter peptides and amino acids by a concerted action of various intracellular peptidases [29]. Comparative genomics have revealed some differences between the proteolytic systems of LAB; for example, compared to *Lactococcus lactis*, lactobacilli are characterized by an ability to encode a large number of peptidases, amino acid permeases, and multiple oligopeptide transport systems [30].

A more sensitive and rapid procedure that is routinely used in laboratories to determine the proteolytic activity of LAB in milk is the use of *o*-phthaldialdehyde (OPA) [31]. The reaction of OPA with primary amines occurs only in the presence of a thiol, typically  $\beta$ -mercaptoethanol, and the product formed is analyzed spectrometrically at 340 nm. The assay is sensitive because OPA reacts with eighteen of the common amino acids, although it gives a weak reaction with cysteine and none with proline.

Chromogenic substrates are commonly used for evaluation of the proteolytic system of LAB (Table 21.1). The chromogenic method is based on the spectrometric determination of the released chromogen from *p*-nitroanilide, naphthylamide, arylamide, etc., derivatives released from the chromogenic peptides by the action of the proteolytic enzymes [32]. The different

**Table 21.1 Chromogenic Substrates and Corresponding References to the Methods Employed for the Determination of Proteolytic Activities in LAB**

Enzyme	Substrate	Reference
Proteinases (PrtP, PrtS, PrtH)	Azocasein, azocoll	[95]
	Universal protease substrate	[96]
	Succinyl-Ala-Glu-Pro-Phe- <i>p</i> -nitroanilide	[33]
	Methoxysuccinyl-Arg-Pro-Tyr- <i>p</i> -nitroanilide	[33]
	Acetyl-Ala-Ala-Pro-Phe- <i>p</i> -nitroanilide	[97]
Endopeptidases (PepO, PepE, PepF)	<i>N</i> -Glutaryl-Ala-Ala-Phe-4-methoxy- $\beta$ -naphthylamide	[98]
	<i>N</i> -Benzoyl-Val-Gly-Arg- <i>p</i> -nitroanilide	[99]
	<i>N</i> -Benzoyl-Pro-Phe-Arg- <i>p</i> -nitroanilide	[99]
	<i>N</i> -Succinyl-Ala-Ala-Pro-Phe- <i>p</i> -nitroanilide	[99]
X-prolyl-dipeptidyl aminopeptidase (PepX)	X-Pro- <i>p</i> -nitroanilide	[100]
Prolyl iminopeptidase (PepI)	Pro- $\beta$ -naphthylamide	[101]
Leucyl aminopeptidase (PepL)	Leu- $\beta$ -naphthylamide	[102]
Glutamyl aminopeptidase (PepA)	Glu/Asp- <i>p</i> -nitroanilide	[103]
General aminopeptidases (PepN, PepC)	Leu- <i>p</i> -nitroanilide	[34]
	Lys- <i>p</i> -nitroanilide	

PrtP variants of *L. lactis* have been identified based on their specificity toward the two different charged chromophoric peptides methoxysuccinyl-arginyl-prolyl-tyrosyl-*p*-nitroanilide and succinyl-alanyl-X-prolyl-phenylalanyl-*p*-nitroanilide [33]. The broad-specificity aminopeptidases PepN and PepC are also capable of acting on oligopeptides, but the substrates generally used for their characterization are leucyl- and lysyl-chromogenic derivatives [34]. Other peptidases have more specific substrate specificities such as PepA, which liberates *N*-terminal acidic residues, and PepL that shows preference for peptides with *N*-terminal leucine residues. Several peptidases such as PepX, PepI, PepP, PepQ, and PepR have preference for peptides containing proline in different positions [29].

Reversed-phase high-performance liquid chromatography (HPLC)-based methods have been used for the analysis of endopeptidase and proteinase activities on caseins and peptides, such as  $\alpha_{s1}$ -casein f1–23 and  $\beta$ -casein f193–209 derived from the hydrolysis of caseins by rennet [35,36]. More recently, the determination of the different starter LAB proteolytic enzymes acting in situ during cheese ripening has been assayed by proteomic tools [37]. The study was carried out in the aqueous phase of Emmental cheese that was prefractionated by size exclusion chromatography in order to separate bacteria and milk proteins and to concentrate the explored proteins. The soluble proteins were separated by 2D-PAGE and the protein spots identified by MALDI-TOF mass spectrometry. The study revealed the presence of peptidases during cheese ripening derived from both starter strains *S. thermophilus* and *Lactobacillus helveticus*. *S. thermophilus* participated in peptide degradation with the production of general aminopeptidase PepN, PepX, and aminopeptidase PepS, and *L. helveticus* expressed aminopeptidases PepN and PepE and endopeptidase PepO.

### 21.3.3 Amino Acid Catabolism

Flavor-producing characteristics are also important criteria for starter cultures selection. Microbial metabolic processes that lead to aroma development during cheese ripening are closely related to the amino acid catabolism reactions conducted by LAB (Table 21.2). Amino acid transamination is the key route for conversion of amino acids by LAB. The resulting  $\alpha$ -keto acids are converted to carboxylic acids and aldehydes by oxidative and nonoxidative decarboxylation processes, respectively [38]. A 96-well plate spectrometric assay for amino acid aminotransferase activities was developed by Cooper et al. [39] The determination of the concentration of keto

**Table 21.2** Aroma Compounds Derived from the Catabolism of Amino Acids and Their Sensory Descriptors

Amino Acid	Metabolite	Aroma Descriptor
Leucine	3-Methylbutanal (isoamylaldehyde)	Malty, cheese, chocolate-like
	3-Methylbutanol (isoamyl alcohol)	Malty, alcoholic, fresh cheese
	3-Methylbutanoate (isovalerate)	Sweat, ripe cheese, putrid, rancid
Isoleucine	2-Methylbutanal (methylvaleraldehyde)	Malty, cheese, chocolate-like
	2-Methylbutanol (active amyl alcohol)	Malty, alcoholic
	2-Methylbutanoate (methylvalerate)	Sweat, ripe cheese, putrid

**Table 21.2 (continued) Aroma Compounds Derived from the Catabolism of Amino Acids and Their Sensory Descriptors**

<i>Amino Acid</i>	<i>Metabolite</i>	<i>Aroma Descriptor</i>
Valine	2-Methylpropanal (isobutanal)	Malty, cheese, banana, chocolate-like
	2-Methylpropanol (isobutanol)	Malty, alcoholic
	2-Methylpropanoate (isobutyrate)	Sweat, rancid, acid
Phenylalanine	2-Phenylethanal (2-phenylacetaldehyde)	Floral, rose
	2-Phenylethanol	Floral, rose, honey-like
	2-Phenylethanoate (2-phenylacetate)	Honey-like
	Phenylethylacetate	Floral, vegetative
	Benzaldehyde	Bitter almond oil, sweet cherry
Tyrosine	<i>p</i> -Hydroxyphenylacetate	
	<i>p</i> -Cresol	Medicinal
	Phenol	Medicinal
Tryptophan	Indole	Putrid, musty
	3-Methylindole (skatole)	Naphthalene, faecal
Methionine	3-Methylthiopropional (methional)	Cooked potato, sulfur
	3-Methylthiopropional (methionol)	Potato
	3-Methylthiopropanoate	
	Methanethiol	Cooked cabbage, garlic, vegetative, sulfur
	Dimethyldisulphide	Cabbage, garlic, ripe cheese
	Dimethyltrisulphide	Garlic, putrid, cabbage
	Dimethylsulphide	Cabbage, garlic, sulfur
	Methylthioacetic acid	
Aspartic acid	2,3-Butanedione (diacetyl)	Butter, nutty
	3-Hydroxy-2-butanone (acetoin)	Butter, sour milk
	Acetate	Vinegar, sour acid

acids was based on the decrease in absorbance at 340 nm due to the NADH oxidation in the presence of leucine dehydrogenase and ammonia. Aminotransferase assays are also carried out with colorimetric L-glutamic acid assay kits [40]. In this assay, the reduced cofactor (NADH) produced by oxidative deamination of glutamic acid reacts with idonitrotetrazolium in the

presence of diaphorase to produce a product that absorbs at 492 nm. Reverse-phase HPLC has been used for the study of  $\alpha$ -keto acids and aldehydes obtained by LAB enzymatic conversion of amino acids [41]. The carboxylic acids derived from  $\alpha$ -keto acids can also be measured by HPLC after ion exchange chromatographic separation [42]. The C-S lyase activity of LAB strains can produce volatile sulfur compounds from methionine, cysteine, and cystathionine and this can be analyzed by the determination of the free-thiol group formation with 5,5'-dithiobis 2-nitrobenzoic acid [40]. A rapid automated system using GC coupled to mass spectrometry (GC/MS) has been developed for headspace analysis of volatile flavor compounds produced by LAB strains [43].

### 21.3.4 Bacteriophage Resistance Analysis

Bacteriophage infection of LAB is a significant and persistent problem for the dairy industry and is still considered the main cause of delayed lactic acid production during milk fermentation. Inside a dairy processing facility, bacteriophages are spread by improper whey handling and aerosols and become fixed on fermentation equipment [44]. Cheese milk is exposed to a phage-contaminated environment and the continued use of the same starter cultures provides a constant host for phage proliferation and development of increasing numbers of phages active against the culture within the manufacturing plant. Therefore, rapid and sensitive methods are required to detect and identify phages at all stages of milk product manufacture and to control maintenance of cultures free of virulent phages.

Lactococcal phages are the most numerous LAB phages that have been isolated and characterized worldwide. However, only three genetically distinct groups of *L. lactis* phages are commonly found in dairy plants, namely the 936, c2, and P335 species [45]. Less information is available for phages infecting other dairy LAB, such as *S. thermophilus* and *Lactobacillus* spp. [44] Milk and whey are usually examined for incidence of phages using standard microbiological methods, such as the spot and turbidity tests [46]. For the spot assay, samples are centrifuged and filtered through a 0.45  $\mu\text{m}$  pore size filter. The filtrates suspected of containing phages are spotted on double-layer plates consisting of a thin top layer of medium soft agar (0.6%), seeded with the pure starter cultures grown at the logarithmic phase, and a bottom medium 1.2% agar containing 10 mM  $\text{CaCl}_2$ . After overnight incubation, the plates are checked for the incidence of lysis plaques. The phage turbidity test is performed in broth added with 10 mM  $\text{CaCl}_2$  and inoculated with pure cultures and the whey filtrates. After incubation, tubes are analyzed for reduction of turbidity in comparison to the control tubes inoculated only with the pure strains.

Enumeration of phages particles can be performed by the double-layer plaque titration method, which involves mixing the indicator strain with decimal dilutions of the phage suspension [47]. Calcium is added to the mixture and after a preincubation to allow adsorption of the phages, the bacteria-phage mixture is added to molten soft agar, poured on Petri dishes that contain solidified agar media added with 10 mM  $\text{CaCl}_2$ . The phage titer is calculated by multiplying the number of plaques by the inverse of the decimal dilution and it is expressed in plaque forming units per mL (PFU/mL). Isolation and purification of phages can be carried out by picking up plaques and placed in broth with calcium. Tubes are kept for 24 h at 4°C and then inoculated with a culture of the host strain and incubated until the lysis of the culture is complete. The phages can be kept at -80°C as high-titer filtrates with the addition of 15% glycerol. Phage suspensions can be concentrated by ultracentrifugation (70,000  $\times g$  for 1 h) and then stained using 2% uranyl acetate, pH 4.5, or 2% phosphotungstic acid to visualize phages by electron microscopy [47].

Other possible sources of virulent phages are lysogenic bacteria and the prophages they contain, which may lyse their host after prophage induction. As a matter of fact, most of the sequenced bacterial genomes contain prophage sequences [48]. Mitomycin C is the standard drug used to activate the lytic life cycle of temperate phages. Mitomycin C is added to the early exponential-phase culture of the strain to a final concentration of 0.1–0.5 µg/mL and incubation is continued up to clarification of the culture. Activation of LAB prophages can be carried out also by thermoinduction. Tested strains are incubated at the optimal growth temperature to reach the mid exponential phase; afterwards, the incubation temperature is shifted to sublethal conditions for a period of 2.5 h and returned back to the growth temperature thereafter. Prophage induction is measured by determining the decrease in optical density during incubation.

Microbiological methods have the advantage of providing information about the sensitivity of a starter culture but cannot determine the nature of the phage species involved. Molecular methods adapted for the detection of LAB phages in milk and whey are mainly based on PCR. A multiplex PCR method has been developed for the identification, in a single reaction, of phages from the three lactococcal groups 936, c2, and P335 directly from whey samples [49]. The reaction contains three sets of primers, the c2-specific primers designed from the major capsid protein, the 936 primers selected on the major structural protein, and P335-specific primers based on two conserved genes involved in the phage lytic cycle. Another multiplex PCR method has recently been developed for the detection and identification, in a single reaction, of *L. lactis*, *L. delbrueckii*, and *S. thermophilus* phages in milk and dairy products [50].

An enzyme-linked immunosorbent method has been designed for specific detection of 936-, P335-, and c2-species phages [51–53]. The antibodies used for the assays were raised against the major capsid proteins in the P335 and c2 phage species, while antibodies raised against whole phages were used for assays targeting the 936-species.

### 21.3.5 Production of Exopolysaccharides

Manufacture of yoghurt and low-fat cheese usually requires the increase of milk solids or the addition of stabilisers to improve consistency and viscosity and to minimize syneresis of the product. In this regard, recent attention has been paid to exopolysaccharides (EPS) produced by LAB to use as natural thickening, because EPS can act as viscosifying, stabilizing, gel-forming, and water-binding agents in foods [54,55]. The EPS secreted into the extracellular environment by LAB can be divided into homopolysaccharides (homo-EPS), which consist of repeating units of only one type of monosaccharide (glucose or fructose) and are represented by the two major groups glucans and fructans, and heteropolysaccharides (hetero-EPS), which are long-chain polysaccharides consisting of branched, repeating units of mainly glucose, galactose, and rhamnose or their derivatives [56,57].

The media used most often for the detection of EPS-producing LAB strains are skim milk, whey-based media, and MRS medium supplemented with high concentrations (100 g/L) of different sugars [56]. Depending on the complexity of the media used for production of EPS, the method used for EPS isolation might need additional purification steps to reduce the protein content and other components in the final EPS preparation. EPS are generally obtained from the LAB culture by dialysis of the supernatant or of the EPS precipitated with ethanol and then lyophilized. For EPS obtained from media with high protein content (e.g., milk), the isolation process involves TCA precipitation [58]. Preparative size exclusion chromatography has been used as a final EPS purification step when highly pure samples were required [59]. In addition, gel

permeation chromatography in an HPLC system using refractive index (RI) detector can be used to simultaneously quantify and purify the corresponding EPS fraction [60]. Another method developed for the identification and quantification of EPS yield directly in the culture media is based on the use of near infrared spectroscopy, which can be used for monitoring EPS production during fermentations [61].

LAB strains that are able to produce homo-EPS can be screened by PCR using primers targeting the conserved catalytic domain in genes encoding glucansucrases or fructansucrases [62,63]. The biosynthesis mechanism of hetero-EPS is more complex. The repeating unit of hetero-EPS is produced intracellularly using sugar nucleotides as precursor molecules, then translocated across the cell-membrane, polymerized, and finally released into the medium [64,65]. Several primer pairs targeting regulatory genes [66], genes involved in chain length determination [67], and genes coding for glycosyltransferases [68] have been described based on the remarkable similarity between the hetero-EPS gene clusters from different LAB [69]. Van der Meulen et al. [70] have developed a rapid screening method based on ultrafiltration, gel permeation chromatography, and primer pairs targeting different genes involved in EPS production to identify LAB producing homo- and hetero-EPS.

The structure determination of EPS requires combining several techniques to determine the monomer composition, the glycosidic linkages, the type and location of noncarbohydrate constituents, etc. [71] The analysis of the monomer composition of EPS is usually carried out by GC/MS. The type of glycosidic linkages and the structure of the repeating units can be determined by nuclear magnetic resonance (NMR). The molar mass and radius of gyration ( $R_g$ ) of the EPS can be simultaneously determined by gel permeation chromatography using a multiangle laser light scattering detector coupled online with the RI detector in the HPLC system [56]. Physical properties of EPS, such as, stretching of the polysaccharide chains can be determined using Atomic Force Microscopy (AFM), which provides information at the single molecule level on properties which are traditionally determined on ensembles of molecules by biophysical techniques such as light scattering [72].

### **21.3.6 Production of Antimicrobial Compounds**

The bioprotective effect of LAB in dairy fermented products is based on their capability to produce antimicrobial metabolites. The main preservative action of LAB is production of organic acids. Acids produced by LAB are mainly lactic acid and in lesser amounts acetic and formic acids although, at equivalent pH values, acetic and formic acids have greater inhibitory effect than lactic acid. Hydrogen peroxide can act by itself or in concert with lactoperoxidase and thiocyanate to constitute the lactoperoxidase system [73]. Other metabolite inhibitors are carbon dioxide, low-molecular weight carbonyl compounds (e.g., diacetyl), ethanol, and bacteriocins.

Bacteriocins are gene-encoded antimicrobial peptides with an apparent antagonistic function against those inhabiting the same environmental niche and therefore competing for the same resources [74]. Recent revised classifications of bacteriocin propose their division into two distinct categories: the lanthionine-containing lantibiotics (class I) and the nonlanthionine-containing bacteriocin (class II) [75]. Best LAB characterized bacteriocin is nisin, which is produced from *L. lactis* and extensively used as food preservative [76]. The classical way of detection of bacteriocins has been by determining its biological activity through extensive testing of the producer strain for inhibition of the growth of other bacteria. The agar diffusion assay is the preferred method used for the determination of bacteriocin activity. Generally, the assay is carried out by serial twofold

dilutions of the culture broth supernatants or food extracts, and the titer is expressed in arbitrary units (AU/mL) as the reciprocal of the highest dilution that inhibits growth of the indicator lawn under the test conditions. Microtiter plate assay is another popular method carried out by adding serial twofold dilutions of culture supernatant of bacteriocin producer in a 96-well plate and the exponential growing indicator culture. Growth inhibition is followed by measuring the optical density at 600 nm of the indicator strain. The bacteriocin unit (BU) is defined as the amount of bacteriocin that inhibits growth of the indicator strain by 50%, when compared with control culture without bacteriocin [77]. Confirmation of the proteinaceous nature of the antimicrobial product is carried out upon treatment of culture supernatants with various proteolytic enzymes, such as chymotrypsin, trypsin, proteinase K, pronase E, and papain.

In order to detect and identify novel bacteriocins in early stages of screening by excluding reported bacteriocins, such as, known nisin variants, new alternatives for testing antimicrobial activity have been developed. Proposed methods include immunological assays using polyclonal or monoclonal antibodies such as, competitive direct and indirect ELISA [78,79]. Genetic methods used include bacteriocin structural genes-specific PCR [80] and colony hybridization [81]. Recently, a new system based on liquid chromatography/mass spectrometry (LC-MS) has been described for the detection and identification of novel bacteriocins [82]. The system identified bacteriocins such as nisin (variants A, Z, and Q) and lacticin 481 in the early stage of screening from culture supernatants or pretreated samples. MS analysis allowed not only the detection of known bacteriocins but also the identification of novel bacteriocins by accurate mass determination.

At present, bacterial genome sequencing represents a source of discovering new bacteriocins for which efficient search tools have been developed. Recently, a Web-based mining tool for prediction of putative structural bacteriocin genes from genome sequences (BAGEL) and a Web-accessible database for bacteriocin characterization (BACTIBASE) are publicly available [83,84].

In addition to bacteriocins, some LAB (certain strains of *Lactobacillus reuteri*) also produce other low molecular weight compounds that are able to inhibit the growth of a broad range of microorganisms, including fungi, such as reuterin and reutericyclin. Reuterin is a dynamic multicomponent equilibrium mixture of monomers, hydrated monomers, and cyclic dimers of  $\beta$ -hydroxypropionic aldehyde formed during anaerobic catabolism of glycerol [85]. Reutericyclin is an *N*-acylated tetramic acid structurally related to tenuazonic acid [86], although no data are available on the biosynthetic pathway of reutericyclin production [87]. Elucidation of the chemical structure of these compounds has required the use of NMR and FTIR spectroscopy and LC-MS and GC-MS analysis, among other specialized methods.

## 21.4 Production and Maintenance of LAB Starters

The objective of starter culture production is to attain a concentrated preparation of active cells that are capable of initiating an effective fermentation. Starter cultures may be preserved and distributed in frozen, freeze-dried, or spray-dried forms. However, freeze-drying is commonly used for the production of starter cultures and for the long-term preservation and storage of microorganisms in stock collections.

Besides intrinsic tolerance of cultures, the important factors that need to be considered to achieve high levels of LAB viability include growth media and conditions, use of protective agents, and storage. Milk and whey are traditional growth media for LAB starter cultures; however, they do not provide optimal nutrient contents to attain high cellular densities. Ingredients commonly used to formulate starter culture media include lactose as the major carbohydrate, although,



depending on the species, low concentrations of maltose, sucrose, or glucose are sometimes added to stimulate growth [88]. Whey proteins, protein hydrolysates, and yeast extract are added as the source of nitrogen as well as suppliers of vitamins, minerals, and other amino acids. Neutralizers, such as ammonium or potassium hydroxides and phosphates, are added to prevent excessive acidity. Growth is carried out in fermenters under controlled pH conditions by maintaining the pH around 6.0 by the addition of sodium or ammonium hydroxide [89]. Incubation temperature, rate of agitation and headspace gases in the fermenter are optimized for each strain. The conditions produce cell suspensions 5–10-fold more concentrated than a normally acidified bulk starter. After fermentation, the biomass is concentrated by centrifugation or membrane ultrafiltration that allows a further 5–40-fold concentration of the cells. After concentration, the bacterial cell biomass is pelletized by raining the concentrate into an agitated bath of liquid nitrogen ( $-196^{\circ}\text{C}$ ). For the preservation of starter cultures by freeze drying, the frozen concentrated cells are dried by sublimation under high vacuum. Cryoprotective agents (polyols such as mannitol, glycerol, and sorbitol or disaccharides such as lactose and sucrose) are added to the concentrated product before freezing to increase the survival rate of the microorganisms by preventing the formation of extracellular and intracellular ice crystals [90]. After freezing or freeze-drying, the activity of the culture is maintained by storage under the specified conditions. Frozen cultures should be stored at  $-45^{\circ}\text{C}$  and freeze-dried products should be stored at  $-18^{\circ}\text{C}$ . Both cultures types will retain their activity for at least 12 months. LAB starter cultures preserved as frozen or freeze-dried forms are suitable for ready-to-use culture concentrates for direct inoculation of milk vats.

The high costs and energy consumption of freezing and freeze drying have attracted increasing attention to alternative drying processes for the preservation of LAB starter cultures [91]. Spray-drying produces a dry powder by atomizing the cell suspension at high velocity and directing the spray of droplets into a flow of hot air ( $150^{\circ}\text{C}$ – $200^{\circ}\text{C}$ ) in a drying chamber. The process results in exposure of the culture to high temperatures for a short time. Vacuum-drying reduces the effect on viability loss caused by heating, since the boiling point of water decreases with reducing pressure. Samples are placed in heated shelves and water is removed in a vacuum pump and condensed at a condenser.

Protective agents are commonly added to the media for the preservation of starter cultures during drying and storage [88,90]. The protectants that can be added include skim milk powder, whey protein, trehalose, glycerol, betaine, adonitol, sorbitol, sucrose, lactose, and polymers such as dextran and polyethylene glycol [92,93]. To diminish lipid oxidation during storage, antioxidants such as ascorbic acid and monosodium glutamate can be used to scavenge free radicals [94]. Appropriate packages that are able to prevent oxygen, moisture, and light during storage of the cultures are also important. The dried powders should be stored under vacuum and at a low temperature to ensure high viability of cultures after rehydration.

## 21.5 Future Trends

Selection of starter cultures for fermented foods keeps focusing on the characterization of new strains that are able to increase biodiversity, diversify flavor, and, in some cheese varieties, to restore the unique characteristics of traditional products. Selection of strains is also addressing the LAB ability to produce new or specific aroma compounds in addition to their acid-producing capability. Advances in genomics, transcriptomics, proteomics, and metabolomic analyses, along with the development of bioinformatics, should provide the basis to investigate and comprehend the specific metabolic pathways involved in texture and flavor characteristics of dairy products,

in stress resistance of the bacteria to different technological treatments or in the production of bioactive compounds. Automated screening procedures may enable the selection of strains or blends of starter cultures with specific phenotypic traits for the tailored design of dairy products exhibiting specific flavor profiles.

## Acknowledgment

Financial support from Spanish Ministerio de Educación y Ciencia (Projects AGL2004-07285-C02-02, AGL2006-12100, and Consolider FUN-C-FOD CSD2007-063) and Comunidad Autónoma de Madrid (ALIBIRD: S-0505/AGR-0153) is gratefully acknowledged.

## References

1. Terzaghi, B.E. and Sandine, W.E. Improved medium for lactic streptococci and their bacteriophages. *Appl. Microbiol.* 29: 807–813, 1975.
2. De Man, J.C., Rogosa, M., and Sharpe, M.E. A medium for the cultivation of lactobacilli. *J. Appl. Bacteriol.* 23: 130–135, 1960.
3. Coeuret, V. et al. Isolation, characterisation and identification of lactobacilli focusing mainly on cheeses and other dairy products. *Lait* 83: 269–306, 2003.
4. Tabasco, R. et al. Selective enumeration and identification of mixed cultures of *Streptococcus thermophilus*, *Lactobacillus delbrueckii* subsp *bulgaricus*, *L. acidophilus*, *L. paracasei* subsp *paracasei* and *Bifidobacterium lactis* in fermented milk. *Int. Dairy J.* 17: 1107–1114, 2007.
5. Vandamme, P. et al. Polyphasic taxonomy, a consensus approach to bacterial systematics. *Microbiol. Rev.* 60: 407–438, 1996.
6. Fujisawa, T. et al. Taxonomic study of the *Lactobacillus acidophilus* group, with recognition of *Lactobacillus gallinarum* sp. nov. and *Lactobacillus johnsonii* sp. nov. and synonymy of *Lactobacillus acidophilus* group A3 (Johnson et al., 1980) with the type strain of *Lactobacillus amylovorus* (Nakamura, 1981). *Int. J. Syst. Bacteriol.* 42: 487–491, 1992.
7. Lortal, S. et al. Electrophoretic pattern of peptidoglycan hydrolases, a new tool for bacterial species identification: Application to 10 *Lactobacillus* species. *Res. Microbiol.* 148: 461–474, 1997.
8. Woese, C.R. Bacterial evolution. *Microbiol. Rev.* 51: 221–271, 1987.
9. Tannock, G.W. et al. Identification of *Lactobacillus* isolates from the gastrointestinal tract, silage, and yoghurt by 16S–23S rRNA gene intergenic spacer region sequence comparisons. *Appl. Environ. Microbiol.* 65: 4264–4267, 1999.
10. Rodas, A.M., Ferrer, S., and Pardo, I. 16S-ARDRA, a tool for identification of lactic acid bacteria isolated from grape must and wine. *Syst. Appl. Microbiol.* 26: 412–422, 2003.
11. Coconcelli, P.S. et al. Development of RAPD protocol for typing of strains of lactic-acid bacteria and enterococci. *Lett. Appl. Microbiol.* 21: 376–379, 1995.
12. Fitzsimons, N.A. et al. Phenotypic and genotypic characterization of non-starter lactic acid bacteria in mature cheddar cheese. *Appl. Environ. Microbiol.* 65: 3418–3426, 1999.
13. Berthier, F. and Ehrlich, S.D. Genetic diversity within *Lactobacillus sakei* and *Lactobacillus curvatus* and design of PCR primers for its detection using randomly amplified polymorphic DNA. *Int. J. Syst. Bacteriol.* 49: 997–1007, 1999.
14. Khaled, A.K.D. et al. Identification and phylogenetic analysis of *Lactobacillus* using multiplex RAPD-PCR. *FEMS Microbiol. Lett.* 153: 191–197, 1997.
15. Tynkkynen, S. et al. Comparison of ribotyping, randomly amplified polymorphic DNA analysis, and pulsed-field gel electrophoresis in typing of *Lactobacillus rhamnosus* and *L. casei* strains. *Appl. Environ. Microbiol.* 65: 3908–3914, 1999.

16. Coudeyras, S. et al. Taxonomic and strain-specific identification of the probiotic strain *Lactobacillus rhamnosus* 35 within the *Lactobacillus casei* group. *Appl. Environ. Microbiol.* 74: 2679–2689, 2008.
17. Gevers, D., Huys, G., and Swings, J. Applicability of rep-PCR fingerprinting for identification of *Lactobacillus* species. *FEMS Microbiol. Lett.* 205: 31–36, 2001.
18. Ercolini, D. PCR-DGGE fingerprinting: Novel strategies for detection of microbes in food. *J. Microbiol. Meth.* 56: 297–314, 2004.
19. Settanni, L. and Corsetti, A. The use of multiplex PCR to detect and differentiate food- and beverage-associated microorganisms: A review. *J. Microbiol. Meth.* 69: 1–22, 2007.
20. Satokari, R.M. et al. Molecular approaches for the detection and identification of bifidobacteria and lactobacilli in the human gastrointestinal tract. *Syst. Appl. Microbiol.* 26: 572–584, 2003.
21. Cocolin, L. et al. Optimization of conditions for profiling bacterial populations in food by culture-independent methods. *Int. J. Food Microbiol.* 120: 100–109, 2007.
22. García-Cayuela, T. et al. Simultaneous detection and enumeration of viable lactic acid bacteria and bifidobacteria in fermented milks by using propidium monoazide and real-time PCR. *Int. Dairy J.* 19: 405–409, 2009.
23. Nocker, A. et al. Use of propidium monoazide for live/dead distinction in microbial ecology. *Appl. Environ. Microbiol.* 73: 5111–5117, 2007.
24. International Dairy Federation. IDF guideline-determination of acidifying activity of dairy cultures. *Bull. IDF* 306: 34–36, 1995.
25. Westerfield, W.W. A colorimetric determination of blood acetoin. *J. Biol. Chem.* 161: 495–502, 1945.
26. Phalip, V., Schmitt, P., and Divies, C. A method for screening diacetyl and acetoin-producing bacteria on agar plates. *J. Basic Microbiol.* 34: 277–280, 1994.
27. Le Bars, D. and Yvon, M. Formation of diacetyl and acetoin by *Lactococcus lactis* via aspartate catabolism. *J. Appl. Microbiol.* 104: 171–177, 2008.
28. Macciola, V., Candela, G., and De Leonardis, A. Rapid gas-chromatographic method for the determination of diacetyl in milk, fermented milk and butter. *Food Control* 19: 873–878, 2008.
29. Savijoki, K., Ingmer, H., and Varmanen, P. Proteolytic systems of lactic acid bacteria. *Appl. Microbiol. Biotechnol.* 71: 394–406, 2006.
30. Klaenhammer, T.R. et al. Genomic features of lactic acid bacteria effecting bioprocessing and health. *FEMS Microbiol. Rev.* 29: 393–409, 2005.
31. Church, F.C. et al. Spectrophotometric assay using o-phthaldialdehyde for determination of proteolysis in milk and isolated proteins. *J. Dairy Sci.* 66: 1219–1227, 1983.
32. Matthews, A. et al. Lactic acid bacteria as a potential source of enzymes for use in vinification. *Appl. Environ. Microbiol.* 70: 5715–5731, 2004.
33. Exterkate, F.A., Alting, A.C., and Bruinenberg, P.G. Diversity of cell-envelope proteinase specificity among strains of *Lactococcus lactis* and its relationship to charge characteristics of the substrate-binding region. *Appl. Environ. Microbiol.* 59: 3640–3647, 1993.
34. Fernández de Palencia, P., Peláez, C., and Martín-Hernández, M.C. Characterization of the aminopeptidase system from *Lactobacillus casei* subsp. *casei* IFPL 731. *J. Agric. Food Chem.* 45: 3778–3781, 1997.
35. Exterkate, F.A. and Alting, A.C. The conversion of the  $\alpha_{s1}$ -casein-(1–23)-fragment by the free and bound form of the cell-envelope proteinase of *Lactococcus lactis* subsp. *cremoris* under conditions prevailing in cheese. *Syst. Appl. Microbiol.* 16: 1–8, 1993.
36. Parra, L. et al. Hydrolysis of  $\beta$ -casein (193–209) fragment by whole cells and fractions of *Lactobacillus casei* and *Lactococcus lactis*. *J. Food Sci.* 64: 899–902, 1999.
37. Gagnaire, V. et al. Survey of bacterial proteins released in cheese: A proteomic approach. *Int. J. Food Microbiol.* 94: 185–201, 2004.
38. Yvon, M. Key enzymes for flavour formation by lactic acid bacteria. *Aust. J. Dairy Technol.* 61: 88–96, 2006.

39. Cooper, A.J.L., Conway, M., and Hutson, S.M. A continuous 96-well plate spectrophotometric assay for branched-chain amino acid aminotransferases. *Anal. Biochem.* 308: 100–105, 2002.
40. Martínez-Cuesta, M.C. et al. YtjE from *Lactococcus lactis* IL1403 is a C-S lyase with  $\alpha,\gamma$ -elimination activity toward methionine. *Appl. Environ. Microbiol.* 72: 4878–4884, 2006.
41. Amarita, F. et al. Cooperation between wild lactococcal strains for cheese aroma formation. *Food Chem.* 94: 240–246, 2006.
42. Kieronczyk, A. et al. Cooperation between *Lactococcus lactis* and nonstarter lactobacilli in the formation of cheese aroma from amino acids. *Appl. Environ. Microbiol.* 69: 734–739, 2003.
43. Smit, B.A. et al. Development of a high throughput screening method to test flavour-forming capabilities of anaerobic micro-organisms. *J. Appl. Microbiol.* 97: 306–313, 2004.
44. Sturino, J.M. and Klaenhammer, T.R. Bacteriophage defense systems and strategies for lactic acid bacteria. *Adv. Appl. Microbiol.* 56: 331–378, 2004.
45. Deveau, H. et al. Biodiversity and classification of lactococcal phages. *Appl. Environ. Microbiol.* 72: 4338–4346, 2006.
46. Svensson, U. and Christiansson, A. Methods for phage monitoring. *Bull. IDF* 263: 29–39, 1991.
47. Quiberoni, A. et al. Diversity of *Streptococcus thermophilus* phages in a large-production cheese factory in Argentina. *J. Dairy Sci.* 89: 3791–3799, 2006.
48. Pfeiler, E.A. and Klaenhammer, T.R. The genomics of lactic acid bacteria. *Trends Microbiol.* 15(12): 546–553, 2007.
49. Labrie, S. and Moineau, S. Multiplex PCR for detection and identification of lactococcal bacteriophages. *Appl. Environ. Microbiol.* 66: 987–994, 2000.
50. Del Rio, B. et al. Multiplex PCR for the detection and identification of dairy bacteriophages in milk. *Food Microbiol.* 24: 75–81, 2007.
51. Lembke, J. and Teuber, M. Detection of bacteriophages in whey by an enzyme-linked immunosorbent assay (ELISA). *Milchwissenschaft* 34: 457–458, 1979.
52. Moineau, S. et al. Production of monoclonal-antibodies against the major capsid protein of the *Lactococcus* bacteriophage- $\phi$ 36 and development of an enzyme-linked-immunosorbent-assay for direct phage detection in whey and milk. *Appl. Environ. Microbiol.* 59: 2034–2040, 1993.
53. Azaiez, S.R.C. et al. Monoclonal antibodies raised against native major capsid proteins of lactococcal  $\phi$ 2-like bacteriophages. *Appl. Environ. Microbiol.* 64: 4255–4259, 1998.
54. Duboc, P. and Mollet, B. Applications of exopolysaccharides in the dairy industry. *Int. Dairy J.* 11: 759–768, 2001.
55. Hassan, A.N. Possibilities and challenges of exopolysaccharide producing lactic cultures in dairy foods. *J. Dairy Sci.* 91: 1282–1298, 2008.
56. Ruas-Madiedo, P. and De los Reyes-Gavilán, C.G. Methods for the screening, isolation, and characterization of exopolysaccharides produced by lactic acid bacteria. *J. Dairy Sci.* 88: 843–856, 2005.
57. Mozzi, F. et al. Diversity of heteropolysaccharide-producing lactic acid bacterium strains and their biopolymers. *Appl. Environ. Microbiol.* 72: 4431–4435, 2006.
58. van Marle, M.E. and Zoon, P. Permeability and rheological properties of microbially and chemically acidified skim-milk gels. *Neth. Milk Dairy J.* 49: 47–65, 1995.
59. Faber, E.J. et al. Characterization of the exopolysaccharide produced by *Streptococcus thermophilus* 8S containing an open chain nononic acid. *Eur. J. Biochem.* 269: 5590–5598, 2002.
60. Harding, L.P. et al. Structural characterisation of a highly branched exopolysaccharide produced by *Lactobacillus delbrueckii* subsp *bulgaricus* NCFB2074. *Carbohydr. Res.* 340: 1107–1111, 2005.
61. Macedo, M.G., Laporte, M.F., and Lacroix, C. Quantification of exopolysaccharide, lactic acid, and lactose concentrations in culture broth by near-infrared spectroscopy. *J. Agric. Food Chem.* 50: 1774–1779, 2002.
62. Kralj, S. et al. Efficient screening methods for glucosyltransferase genes in *Lactobacillus* strains. *Bio-catal. Biotransform.* 21: 181–187, 2003.
63. Tieking, M. et al. *In situ* production of exopolysaccharides during sourdough fermentation by cereal and intestinal isolates of lactic acid bacteria. *Appl. Environ. Microbiol.* 69: 945–952, 2003.

64. De Vuyst, L. and Degeest, B. Heteropolysaccharides from lactic acid bacteria. *FEMS Microbiol. Rev.* 23: 153–77, 1999.
65. Welman, A.D. and Maddox, I.S. Exopolysaccharides from lactic acid bacteria: Perspectives and challenges. *Trends Biotechnol.* 21: 269–274, 2003.
66. Low, D. et al. Role of *Streptococcus thermophilus* MR-1C capsular exopolysaccharide in cheese moisture retention. *Appl. Environ. Microbiol.* 64: 2147–2151, 1998.
67. Deveau, H. and Moineau, S. Use of RFLP to characterize *Lactococcus lactis* strains producing exopolysaccharides. *J. Dairy Sci.* 86: 1472–1475, 2003.
68. Provencher, C. et al. Consensus-degenerate hybrid oligonucleotide primers for amplification of priming glycosyltransferase genes of the exopolysaccharide locus in strains of the *Lactobacillus casei* group. *Appl. Environ. Microbiol.* 69: 3299–3307, 2003.
69. Jolly, L. and Stingle, F. Molecular organization and functionality of exopolysaccharide gene clusters in lactic acid bacteria. *Int. Dairy J.* 11: 733–745, 2001.
70. Van der Meulen, R. et al. Screening of lactic acid bacteria isolates from dairy and cereal products for exopolysaccharide production and genes involved. *Int. J. Food Microbiol.* 118: 250–258, 2007.
71. Sletmoen, M. et al. Characterisation of bacterial polysaccharides: Steps towards single molecular studies. *Carbohydr. Res.* 338: 2459–2475, 2003.
72. Ubbink, J. and Schar-Zammaretti, P. Probing bacterial interactions: Integrated approaches combining atomic force microscopy, electron microscopy and biophysical techniques. *Micron* 36: 293–320, 2005.
73. Juven, B.J. and Pierson, M.D. Antibacterial effects of hydrogen peroxide and methods for its detection and quantitation. *J. Food Protect.* 59: 1233–1241, 1996.
74. Claverys, J.P. and Havarstein, L.S. Cannibalism and fratricide: Mechanisms and raisons d'être. *Nat. Rev. Microbiol.* 5: 219–229, 2007.
75. Cotter, P.D., Hill, C., and Ross, R.P. Bacteriocins: Developing innate immunity for food. *Nat. Rev. Microbiol.* 3: 777–788, 2005.
76. Cleveland, J. et al. Bacteriocins: Safe, natural antimicrobials for food preservation. *Int. J. Food Microbiol.* 71: 1–20, 2001.
77. Holo, H., Nilssen, O., and Nes, I.F. Lactococcin A, a new bacteriocin from *Lactococcus lactis* subsp. *cremoris*: Isolation and characterization of the protein and its gene. *J. Bacteriol.* 173: 3879–3887, 1991.
78. Falahee, M.B. et al. An enzyme immunoassay for nisin. *J. Food Sci. Technol.* 25: 590–595, 1990.
79. Bouksaim, M. et al. Production and utilization of polyclonal antibodies against nisin in an ELISA and for immuno-location of nisin in producing and sensitive bacterial strains. *J. Appl. Microbiol.* 87: 500–510, 1999.
80. Klijn, N., Weerkamp, A.H., and De Vos, W.M. Detection and characterization of lactose utilizing *Lactococcus* spp. in natural ecosystems. *Appl. Environ. Microbiol.* 61: 788–792, 1995.
81. Martínez, M.I. et al. Detection of specific bacteriocin-producing lactic acid bacteria by colony hybridization. *J. Appl. Microbiol.* 84: 1099–1103, 1998.
82. Zendo, T. et al. Bacteriocin detection by liquid chromatography/mass spectrometry for rapid identification. *J. Appl. Microbiol.* 104: 499–507, 2008.
83. De Jong, A. et al. BAGEL: A web-based bacteriocin genome mining tool. *Nucleic Acids Res.* 34: W273–W279, 2006.
84. Hammami, R. et al. BACTIBASE: A web-accessible database for bacteriocin characterization. *BMC Microbiol.* 7: 89, 2007.
85. Talarico, T.L. and Dobrogosz, W.J. Chemical characterization of an antimicrobial substance produced by *Lactobacillus reuteri*. *Antimicrob. Agents Chemother.* 33: 674–679, 1989.
86. Hölzel, A. et al. The first low molecular weight antibiotic from lactic acid bacteria: Reutericyclin, a new tetramic acid. *Angew. Chem. Int. Ed.* 39: 2766–2768, 2000.
87. Gänzle, M.G. Reutericyclin: Biological activity, mode of action, and potential applications. *Appl. Microbiol. Biotechnol.* 64: 326–332, 2004.

88. Carvalho, A.S. et al. Relevant factors for the preparation of freeze-dried lactic acid bacteria. *Int. Dairy J.* 14: 835–847, 2004.
89. Tamime, A.Y. *Fermented Milks*, Blackwell publishing, Oxford, 2006.
90. Santivarangkna, C., Higl, B., and Foerst, P. Protection mechanisms of sugars during different stages of preparation process of dried lactic acid starter cultures. *Food Microbiol.* 25: 429–441, 2008.
91. Santivarangkna, C., Kulozik, U., and Foerst, P. Alternative drying processes for the industrial preservation of lactic acid starter cultures. *Biotechnol. Prog.* 23: 302–315, 2007.
92. Hubalek, Z. Protectants used in the cryopreservation of microorganisms. *Cryobiology* 46: 205–229, 2003.
93. Morgan, C.A. et al. Preservation of micro-organisms by drying: A review. *J. Microbiol. Meth.* 66: 183–193, 2006.
94. Teixeira, P.C. et al. Survival of *Lactobacillus delbrueckii* ssp. *bulgaricus* following spraydrying. *J. Dairy Sci.* 78: 1025–1031, 1995.
95. Fontecha, J., Requena, T., and Swaisgood, H.E. Affinity chromatography of proteinases using bacitracin immobilized to porous glass beads. *Lett. Appl. Microbiol.* 22: 371–374, 1996.
96. Roche Applied Science. Universal Protease Substrate: Casein, resorufin-labeled. Product instructions. Retrieved July, 2008, from <http://www.roche-applied-science.com/pack-insert/1080733a.pdf>
97. Fernández-Esplá, M.D. et al. *Streptococcus thermophilus* cell wall-anchored proteinase: Release, purification, and biochemical and genetic characterization. *Appl. Environ. Microbiol.* 66: 4772–4778, 2000.
98. Lian, W. et al. Heterologous expression and characterization of recombinant *Lactococcus lactis* neutral endopeptidase. *Arch. Biochem. Biophys.* 333: 121–126, 1996.
99. Chen, Y.S. and Steele, J.M. Genetic characterization and physiological role of endopeptidase O from *Lactobacillus helveticus* CNRZ32. *Appl. Environ. Microbiol.* 64: 3411–3415, 1998.
100. Zevaco, C., Monnet, V., and Gripon, J.C. Intracellular X-prolyl dipeptidyl peptidase from *Lactococcus lactis* subsp. *lactis*: Purification and properties. *J. Appl. Bacteriol.* 68: 357–366, 1990.
101. Klein, J., Schmidt, U., and Plapp, R. Cloning, heterologous expression, and sequencing of a novel proline iminopeptidase gene, *pepI*, from *Lactobacillus delbrueckii* subsp. *lactis* DSM7290. *Microbiology* 140: 1133–1139, 1994.
102. Klein, J. et al. Molecular cloning and DNA sequence analysis of *pepL*, a leucyl aminopeptidase gene from *Lactobacillus delbrueckii* subsp. *lactis* DSM7290. *Eur. J. Biochem.* 228: 570–578, 1995.
103. L'Anson, K.J.A. et al. A nonessential glutamyl aminopeptidase is required for optimal growth of *Lactococcus lactis* MG1363 in milk. *Microbiology* 141: 2873–2881, 1995.



## Chapter 22

---

# Detection of Bacteriophages in Milk

---

Alfonso H. Magadán, Victor Ladero, Noelia Martínez,  
Beatriz del Rio, M. Cruz Martín, and Miguel A. Alvarez

### CONTENTS

22.1	The Bacteriophage Problem in the Dairy Industry.....	470
22.2	The Importance of Early Bacteriophage Detection in Milk .....	471
22.3	Bacteriophage Detection Systems .....	471
22.3.1	Microbiological Assays.....	472
22.3.1.1	Spot/Plaque Assay .....	472
22.3.1.2	Turbidity or Growth Test.....	473
22.3.1.3	Impedance or Conductance Measurement.....	473
22.3.1.4	Electron Microscopy .....	473
22.3.1.5	Flow Cytometric Detection.....	475
22.3.2	Molecular Methods .....	475
22.3.2.1	ELISA.....	475
22.3.2.2	DNA-Hybridization .....	476
22.3.2.3	PCR.....	476
22.3.2.4	Multiplex PCR .....	477
22.3.2.5	Real-Time Quantitative PCR (RT-qPCR) .....	478
22.4	Concluding Remarks .....	480
	References.....	480



## 22.1 The Bacteriophage Problem in the Dairy Industry

Food fermentations have been carried out ever since the Neolithic period and they are one of the oldest manifestations of biotechnology. The process could have been a consequence of an accidental contamination by environmental microorganisms, which would have caused the alteration of the raw material. In the case of milk, this contamination by lactic acid bacteria (LAB) had originated in products with an acceptable final flavor and texture, and which, most importantly, could be preserved for longer periods of time. Through the LAB ability to ferment milk sugar (lactose) into lactic acid, there is a concomitant drop in pH that inhibits the growth of most spoilage and pathogenic bacteria. Throughout time, LAB have been selected to obtain high-quality dairy products by using part of a successful fermentation as starter of the next one.

LAB are widely used as bacterial starters in many feed and food fermentations. This heterogeneous bacterial group, which predominantly includes the genera *Streptococcus*, *Lactococcus*, *Leuconostoc*, *Lactobacillus*, and *Pediococcus*, plays an important role in flavor and texture development and also participates in the formation of other nutritional added attributes in fermented products. Thus, the success of food fermentations depends on the LAB growth, either if they are added as starters, or are present as normal microbiota in the raw material. So, any factor or agent, able to delay or to inhibit the growth of these bacteria will generate technological problems in the fermentation process leading, in this way, to defective products and impairing the economic yield. LAB can be inhibited by different substances present in the raw material or in the fermentation tank, including antibiotics, antiseptics, and detergent residues, free fatty acids, or bacteriocins that are produced as a result of the growth of other microorganisms. But the main inhibitor in the dairy industry is, without doubt, bacteriophage infection [1].

Phage attack has always been the main problem for industrial milk fermentations and it has remained the major cause of fermentation failure ever since they were first described in 1935 [2]. The bacteriophage infection of starter bacteria results in the slow production of lactic acid with the result of unacceptably long times of fermentation and, in extreme cases, may lead to loss of the product. The conditions prevailing in these industrial environments represent unique ecological niches that support phage proliferation [1]. Milk fermentations could be considered as vast high-density microorganism cultures containing one, or a few, selected bacterial strains. These cultures are maintained in an exponential phase of growth for extended periods of time and the manufacturing process is regularly repeated, over and over, in successive batches with the same strains. These conditions are ideal for phage propagation, and contamination of fermentation vessels by lytic viruses has dramatic consequences [3]. It is important to highlight the additional problem of lysogeny, since it is a frequent phenomenon in LAB [4]. When a temperate phage infects a cell, it can go to a lysogenic cycle, in which the viral DNA integrates in the host chromosome and is replicated and transmitted to the progeny. These infected cells are then called lysogens and the dormant phage is known as prophage. Lysogens act as a reservoir of phages that can be liberated at any time during fermentation; additionally some authors have proposed that prophages participate in the origin and evolution of lytic bacteriophages [5]. Thus, an appropriate selection of prophage-free strains to be used as starters is vital. Throughout this chapter, variation in the described methods specifically dedicated to prophage detection will be highlighted.

The huge variety of fermented products consumed at the present time has prompted an increasing interest in LAB investigation. Studies on physiology and fermentation processes of LAB have transformed some of the empirical traditional fermentations into carefully controlled industrial processes. However, the dairy industry is especially susceptible to phage attacks because the raw material, the milk, is not sterile, even if it has been submitted to pasteurization. Moreover, the

economic yield of the process is easily affected due to the strictly controlled timing of production. In this way, it must be outstanding that the dairy factories receive milk every day of the year and must be processed within the same day.

At present, the phage problem, far from being solved, is getting worse because starters are constituted by a reduced number of selected bacterial strains. Traditionally the dairy industry employed undefined starters formed by a complex microbiota. The biodiversity of these undefined starters, including subpopulations of susceptible and resistant host strains, allowed the establishment of population equilibrium between phages and their host strains based on coevolution. So, even in the presence of high viral titers, the drop in the acidification activity was not observed. Nowadays, the increasing demand for high-quality uniform products and the standardization of processes have motivated the replacement of those traditional undefined starters by defined ones, constituted of a few selected strains with specific technological characteristics. This dependency on a low number of specific strains has limited the quantity and diversity of starters and its continued utilization has provided a host system vulnerable to phage attacks [6].

## 22.2 The Importance of Early Bacteriophage Detection in Milk

Due to the magnitude of the problem and its economic impact, bacteriophages have been studied widely in the last few decades. Investigations have been focused on the quest for phage-resistant strains and in the characterization of phage populations. Hence, dairy bacteriophages have become the most documented group of viruses in biological databases [7]. However, in spite of this knowledge and the efforts made by dairy companies in the application of measures to face phage attacks: starter culture rotation, use of antiphage broth, cleaning measures, the search for highly resistant strains, and the like, there is no definitive strategy to eliminate bacteriophages from milk and dairy plants. Thus, early and specific detection of dairy bacteriophage in milk, that is going to be employed as fermentation substrate, is crucial to reduce economic losses.

Ideally, no phages should be present in a dairy plant, although this is a rare case. Undefined strain starters may not be inhibited by levels up to  $10^8$  pfu mL<sup>-1</sup> or greater [8], but defined starters can be inhibited by significantly lower levels. It is generally accepted as safe environment if phages are present at levels lower than  $10^5$  pfu mL<sup>-1</sup>. If they are present in milk at this level or greater, an inhibition, or even total failure, of the fermentation process is expected [8].

## 22.3 Bacteriophage Detection Systems

An optimal detection system should possess a few basic requirements: high sensitivity, rapid detection, and high fidelity. In addition, low cost and full automation is also recommended. Unfortunately, despite the abundant and diverse approaches to phage detection, no one possesses all the virtues mentioned earlier.

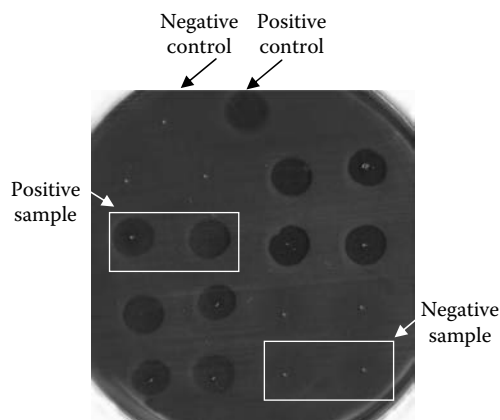
The bacteriophage detection methods proposed up to date could be grouped into two principal strategies: (1) microbiological assays, which are based on showing the phage presence by direct visualization of the virions or by indirect assays detecting the inhibitory effect on starter cultures; and (2) molecular assays, which try to demonstrate its presence by detecting different parts of the viral particle.

### 22.3.1 Microbiological Assays

When a delay in acidification is detected in a milk fermentation, dairy factories usually check the presence of bacteriophages using a variety of classical microbiological assays: spot, activity, indicator, or turbidity tests, and impedance or conductance measurement [9], toward the demonstration of their presence and implication in the fermentation failure. Some of these methods are widely used in all-size dairy plants, although in larger plants faster and automated methods are arising.

#### 22.3.1.1 Spot/Plaque Assay

Plaque assay is a quantitative and sensitive microbiological method for phage detection, based on the inhibition of the host growth. Basically, a sample from the problematic fermentation is dissolved in an isotonic solution or medium, then centrifuged, and filtered ( $0.45\ \mu\text{m}$ ) to remove residual bacterial cells. A drop of this processed sample is then spotted on the top of an agar plate seeded with an indicator bacterial strain (Figure 22.1). The indicator strains should correspond with those that constitute the starter culture. After sample spotting, plates are incubated at the indicator strain optimal growth conditions. After the appropriate incubation time, the drop areas are checked for cleared zones or plaques within the bacterial growth. The appearance of plaques clearly demonstrates the presence of phages, whereas the uniformly cleared spots could be caused by other inhibitory agents (antibiotics, antiseptics, bacteriocins, etc.). So in order to ensure that bacteriophages are present in the fermentation process, it is necessary to proceed with tenfold serial dilutions of the filtered samples. The inhibition area due to chemicals, would gradually disappear as the dilution factor increases; in contrast, in the case of phage-inhibition isolated plaques would appear within the spotted area. This microbiological test is accurate, sensitive, and quantitative, but the main problem is the time required to get a conclusion. Results cannot be obtained until several hours and can be delayed for up to a few days, depending on the bacterial host/phage combination.



**Figure 22.1** Interpretation of spot assay in indicator strain (*S. thermophilus*). Eight samples from failed fermentations were spotted by duplicate onto single-layer lawn of potential host bacteria. Lytic activity was recorded after 24 h at  $42^\circ\text{C}$ . Negative control:  $\Phi\text{LL-H}$  (*Lb. delbrueckii* phage) and positive control:  $\Phi\text{DT1}$  (*S. thermophilus* phage).

A variation of this method has been traditionally used to test the phage release by lysogenic strains. In this case, the tested strain is treated with a prophage induction agent, such as mitomycin C or UV light. After the treatment, the supernatant of the culture follows the same procedure as an industrial sample. However, in this case the difficulty is to find the appropriate indicator strain, since the lysogens are immune to the infection [10].

### 22.3.1.2 *Turbidity or Growth Test*

These methods are based on the detection of the effects caused by phages: inhibition of the starter growth or decrease in acid production [11]. In these methods, a filtered sample is added to a liquid starter culture in the laboratory and then the growth is analyzed by absorbance or pH and then compared with a control (test sample was not added). These tests are very sensitive, although they present two important drawbacks. Firstly, the inhibition of the starter growth detected could be caused by another inhibitory substance, as previously mentioned. Antibiotics, detergent residues, or bacteriocins could inhibit growth and give a false positive result. Therefore, a secondary analysis is required to confirm the phage presence. This second test must be performed separately on each of the strains that form the starter culture. Finally, time-consuming is the major inconvenience of these kind of test, generally, at least 8–24 h is needed to complete the primary test. Another inconvenience is the need of maintenance of the starter cultures strains and trained technicians in the laboratory to carry out the test, resources not always available in dairy plants.

The current trend in the development of new microbiological phage detection systems, is managing to improve the old ones, so scientists are trying to reduce the time frame and associated cost. For larger dairy plants, miniaturization and automation is the major challenge. Recently, the old detection method based on pH indicators was adapted to be performed in 96-well microtiter plates [12]. The pH indicators reveal the acidifying activity of the cultures by changing the color of the culture, which can be measured at different time points by a plate reader. An image of the color wells can be captured and translated into pH values by referencing them to a standard curve. As other methods, reveals the presence of an inhibitory substance in the culture, and the likelihood of phage infection must be proven later. On the other hand, this method could be used as a high-throughput analysis of strain collections to select those nonlysogenic strains, after treatment with an induction agent, as “phage-free” starters.

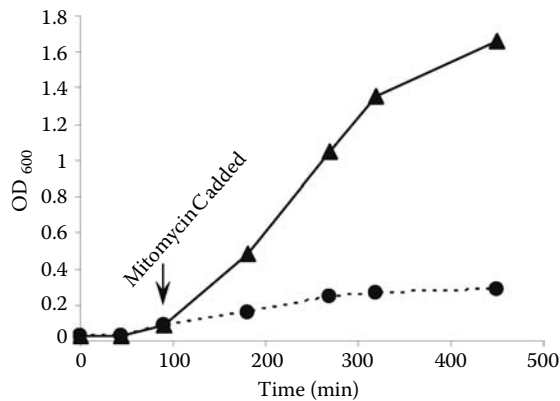
### 22.3.1.3 *Impedance or Conductance Measurement*

These methods can be considered as an evolution of the turbidity or growth test. In this case the growth is measured by the change in the impedance or conductance of the cultures [13]. The advantages and drawbacks are mainly the same as the previously described methods.

These methods could also be used as screening for lysogenic strains, after treatment with the induction agent, a comparison between the problem strain treated and nontreated will reveal the presence of a functional prophage by the inhibition of the growth after several minutes (Figure 22.2).

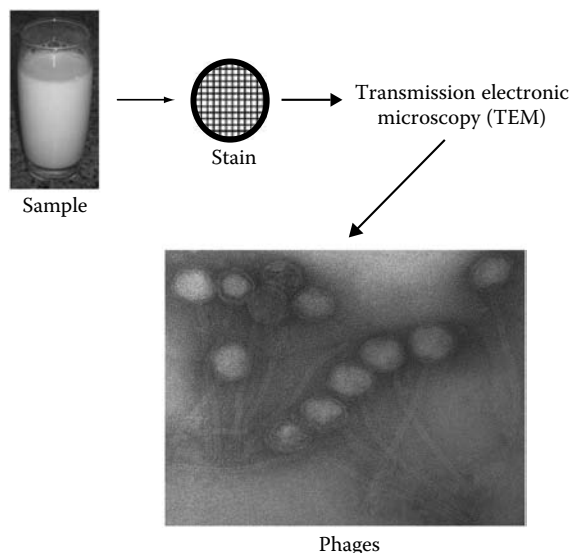
### 22.3.1.4 *Electron Microscopy*

In some cases, these microbiological methods are not always available to phage detection and some traditional fermentation processes involve so many undefined bacterial strains that phage



**Figure 22.2** Effect of mitomycin C treatment in the growth of a *Lc. lactis* lysogen strain. Cell densities in broth cultures were determined by measuring the optical densities at 600 nm ( $OD_{600}$ ). Mitomycin C was added approximately 90 min after inoculation ( $OD_{600} = 0.1$ ). (▲), control strain culture; (●), mitomycin C-induced culture.

monitoring can be difficult to do. In those cases, the direct observation of a sample with an electron microscope could be possible. The samples have to be sent to a microscopy service, correctly arranged, properly stained (uranyl acetate or potassium phosphotungstate), and finally, observed at the right magnification (Figure 22.3). So, the setting up of these hard techniques as a routine detection tool is quite difficult and they are more orientated to research facilities.



**Figure 22.3** Electron microscopy micrographies of *S. thermophilus* phage, obtained from a dairy sample, stained with 2% uranyl acetate.

### 22.3.1.5 Flow Cytometric Detection

Recently, another independent bacterial culture detection test was developed for the detection of phage infection in *Lactococcus lactis* dairy cultures [14]. The method is based on the detection of phage-infected cells by flow cytometry. This is possible because the intracellular replication of the bacteriophages has a detectable effect on the density of the cell wall during infection and breaks the chains of *Lc. lactis* [14]. This method allows fast and early detection of phage-infected bacteria, independently of which phage has infected the culture. An additional advantage of the method is that it can be performed in real time and, therefore, increases the chance of successful intervention in the fermentation process. In spite of its high cost, the need to be set up for other species of LAB, and the presence of highly skilled, adequately trained personnel are the main drawbacks.

### 22.3.2 Molecular Methods

As was introduced before, the molecular detection assays try to demonstrate the bacteriophage presence by detecting different parts of the viral particle. In the case of these simple biological forms, the targets are their genomic DNA or the proteic envelope that protects them. In this way, immunological assays [enzyme-linked immunosorbent assay (ELISA)] have been developed to detect the major capsid proteins of some *Lc. lactis* bacteriophages [15–18]. The viral DNA, can also be detected with specific DNA-hybridization probes or by polymerase chain reaction (PCR) amplification [19–23].

The main advantage of molecular techniques is that they are generally well suited to rapid and high-throughput detection. Despite of its usual employment in research activities for many years; there are few reports of its habitual use in the food industry. Whereas, in other fields like clinical analysis, currently exists a large number of similarly rapid detection technologies, which have been used extensively [24]. On the other hand, molecular assays have an important drawback, they do not discriminate infectious phages from those that are in an inactivated status. Thus, positive results could overestimate the level of phage threat, although it could be a good warning to apply safety preventive measurements to avoid forthcoming problems. In this context, these probes are helpful tools to identify potential sources of contamination in the fermentation facilities, and in some cases even allow quick identification of the detected phage species [23].

#### 22.3.2.1 ELISA

The ELISA test is based on the use of specific antibodies against principal structural proteins of the virion. It has been investigated for its potential use in routine screening of the main problematic families of *Lc. lactis* bacteriophages [15–18], since it has been well established that the serological relationships of lactococcal phages correlate well with their morphology [25]. *Lc. lactis* bacteriophages are currently classified into 10 different species [26], but the c2, the 936, and the P335 species are responsible for most of the fermentation failures that occur during industrial cheese elaboration [27–29].

Although these specific ELISA methods are significantly faster than traditional ones (4–5 h approx.), to our knowledge they have not been adopted as common detection methods, mainly because these tests showed an insufficient sensibility,  $10^7$  pfu mL<sup>-1</sup> detection limit, which is about 2 log units higher than the disturbing threshold titer ( $10^5$  pfu mL<sup>-1</sup>).

### 22.3.2.2 DNA-Hybridization

The first approximation to viral DNA detection was developed using dot blot DNA-hybridization [19]. This assay was developed to detect two lactococcal phage species directly from cheese whey and milk. Although this method showed a good detection limit ( $10^5$ – $10^6$  pfu mL<sup>-1</sup>) and could be suitable for simultaneous processing of a large number of samples, it is seldom used by the food industry because it is time-consuming and needs well-trained personnel at the factories. These kinds of assays are commonly used for research purposes, as a phage characterization system.

### 22.3.2.3 PCR

In the last decade, the asserting detection technique is the PCR [30]. This technique allows the specific exponential amplification of a target sequence comprised between two oligonucleotides in a cycling reaction in a thermo-cycler. Theoretically, from a single copy of the target DNA in the reaction tube it is possible to get up to  $2^{35}$  copies at the end of the 35 cycles of a standard PCR. The specificity of the reaction is based on the homology of the flanking oligonucleotides with conserved regions in the target sequence. It has been applied in many medical diagnostic assays, pathogen detection, and research purposes in all fields of life science. For the successful development of a useful PCR assay it is required to get access to large, adequately structured DNA databases. Due to the large progress made during the last 30 years in LAB genetics and its phages, hundreds of phages infecting dairy LAB have been characterized worldwide, being the phage group best represented in databases [7,31,32]. In this context, the dairy industry is far ahead of other industries in its capability to start up such kinds of detection tests.

The PCR technique has been applied in the different stages of dairy product manufacture to detect and identify viruses and bacteria in a number of food environments [33–35]. This technique has been adapted to detect phages in milk samples [21–23] and in cheese whey [20,34] with a detection limit ( $10^3$ – $10^4$  pfu mL<sup>-1</sup>) under the threat threshold. It is noteworthy to state at this point that deviations from standard PCR protocols needed to be able to detect the presence of phage DNA from an industrial sample are minimal and low quantities of the problematic sample can be directly added to the PCR reaction. Moreover, a large number of samples can be analyzed in a short period of time, up to 3–4 h. These characteristics have made this tool the most appropriate to check for the presence of lysogen strains in the large collections of dairy starter culture companies toward the selection of phage-free starter cultures [36].

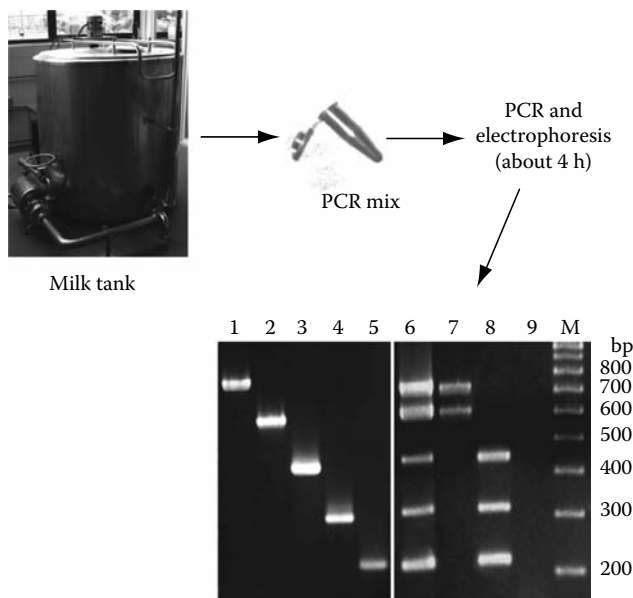
Furthermore, it is possible to get additional information apart from the presence of the phage DNA. Recently, a new PCR tool based on conserved regions in the gene coding for the major structural proteins was developed to directly detect and classify *Streptococcus thermophilus* phages within one of the two main groups (*cos* and *pac*) [37]. In this context, the detection method of *S. thermophilus* bacteriophages based on the amplification and sequencing of the variable region of the antireceptor gene allows the typification of the detected phages and establishes a correlation between typing profiles and host ranges [21]. In other words, it is possible to know which strains infect, and which strains do not infect, the detected phages. This is a useful relationship for the dairy industry, allowing it to face phage attacks by designing a rational starter rotation system based on the phage type detected.

PCR detection methods continuously evolve as much research and knowledge is accumulated, allowing for most sophisticated and useful methods.

### 22.3.2.4 Multiplex PCR

As has been commented on earlier, starter cultures can be constituted by several strains of different LAB species that have been selected for their technological aptitude to accelerate acidification or contribute to final flavor or taste. Thus, in the case of these mixed starter cultures more than one PCR reaction would be needed to detect all the phage types able to infect the starter. Multiplex PCR is an elegant solution to avoid this problem, by being able to detect more than one phage specie in the same reaction.

There are two notable reports of bacteriophage detection methods by using the multiplex PCR [20,23]. In the first assay, the multiplex PCR method was adapted to detect, in a single reaction, the presence of the three problematic *Lc. lactis* phages species, namely c2, 936, and P335, from phage lysates or whey samples. In the second one [23] the detection range was extended to two additional phage groups. This simple and rapid multiplex PCR method detects the presence of bacteriophages infecting LAB most commonly found in dairy plants, the three genetically distinct groups of *Lc. lactis* phages species (c2, 936, and P335) plus phages infecting *S. thermophilus* and *Lactobacillus delbrueckii*. Available bacteriophage genome sequences were examined and the most conserved regions used to design five pairs of primers, one for each of the aforementioned bacteriophage species. These primers were specifically designed to generate fragments of different sizes depending on the phage species amplified (Figure 22.4). The method showed a detection limit of  $10^3$ – $10^4$  pfu mL<sup>-1</sup> and a short time range, 3–4 h.



**Figure 22.4** Early detection of bacteriophages in milk by multiplex PCR. The 1.5% agarose gel shows the results of amplification from skimmed milk contaminated with different dairy phages. **Lanes:** M, molecular weight marker; 1, ΦDT1 (*S. thermophilus* phage); 2, ΦLL-H (*Lb. delbrueckii* phage); 3, Φc2 (*Lc. lactis* phage of the specie c2); 4, ΦbIL170 (*Lc. lactis* phage of the specie 936); 5, ΦTuc2009 (*Lc. lactis* phage of the specie p335); 6, all the phages together; 7, LL-H and DT1 phages; 8, c2, bIL170 and Tuc2009 phages; 9, uninfected milk.



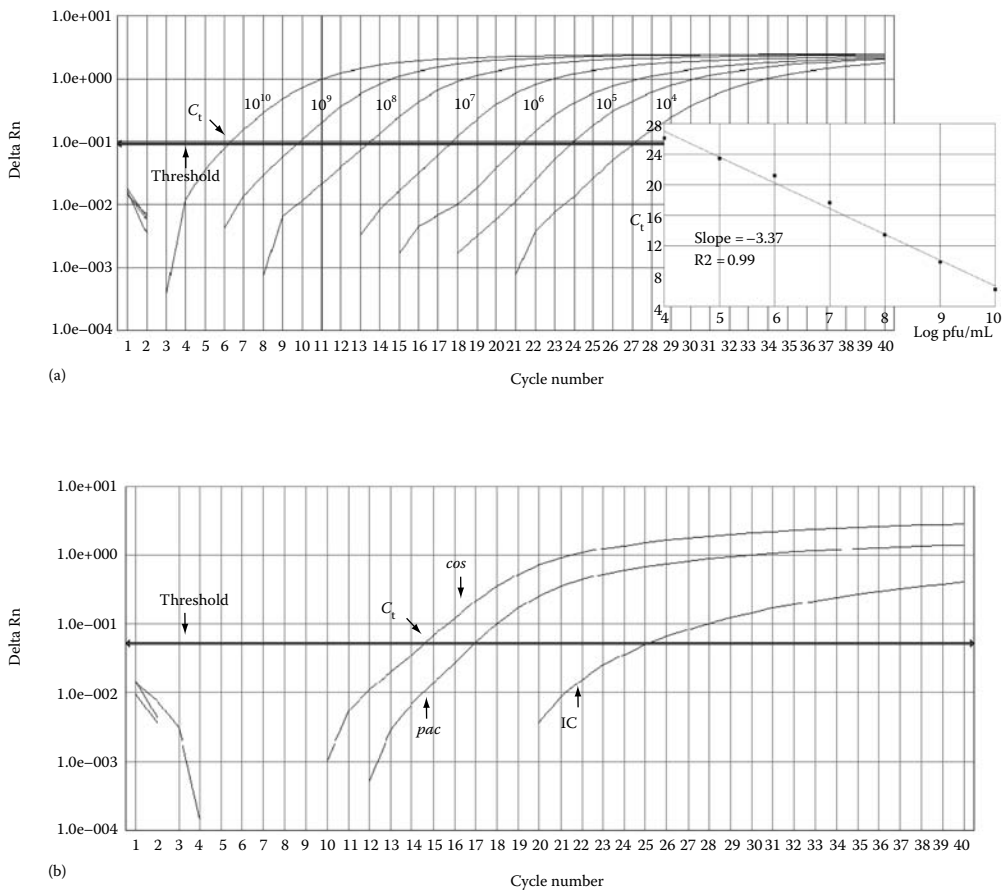
Most of the habitual methods used in dairy plants, mainly microbiological assays, are time-consuming and mostly rely on the availability of single indicator strains. In contrast, the multiplex PCR assay described can detect bacteriophages in fresh milk samples in just 4 h. Since this method can directly detect the aforementioned phages in raw milk, it can easily be incorporated into dairy industry routines. The accurate and rapid identification of phages potentially able to attack starter cultures allow for speedy decisions with regard to the fate of contaminated milk. It might readily be used to earmark contaminated milk for use in processes that do not involve susceptible starter organisms or for its use in those that involve phage-deactivating conditions. For example, if a sample of milk is contaminated with *Lc. lactis* phages, it could be employed for yogurt production or in any case, it can be treated to be sold as UHT milk.

### 22.3.2.5 *Real-Time Quantitative PCR (RT-qPCR)*

The main drawback of conventional PCR systems is the impossibility to quantify the target sequence; in most cases we can only get a presence/absence response after the analysis. Since this is usually not enough, there was an increasing demand for quantitative, more sensitive, and rapid procedures in all diagnostic fields and this has prompted the development of fluorescence-based PCR, originating a new revolution in PCR detection systems. The RT-qPCR can be used to estimate the copy number of a target gene in a sample; and it has been reported to be much faster and more sensitive than conventional PCR [38]. Basically, the RT-qPCR combines a thermo-cycler, a fluorimeter, and a computer. The method is based on the utilization of fluorogenic molecules that can be attached to the primers, to internal probes, or directly to the amplified double-stranded DNA, to detect in real time the amplification of the target DNA during the PCR reaction. The method is quantitative, because the first cycle in which the amplification (increase in fluorescence) is detected, known as threshold cycle ( $C_t$ ), is proportional to the initial number of target DNA molecules present in the reaction [39,40]. Another advantage is the possibility of including in the same reaction an internal positive amplification control [41]. In addition, as in conventional PCR, it is possible to develop multiplex RT-qPCR systems by using different fluorogenic reporters into the same reaction to detect different targets. At present, only RT-qPCR methods for the detection of *S. thermophilus* phages have been described [41].

The method, in fact, consists of a multiplex RT-qPCR reaction in which specific primers and Taqman<sup>®</sup>-MGB probes were designed to target two different genes that allow the detection and identification of *cos* and *pac* type *S. thermophilus* phages. Additionally, an internal amplification control was included. The method has been optimized for FAST technology (Applied Biosystems, Warrington, United Kingdom) allowing detection and quantification of *S. thermophilus* bacteriophages directly from milk samples in 30 min. Quantification is obtained by comparing the sample  $C_t$  value against a standard curve of known phage concentrations (Figure 22.5a). With this RT-qPCR detection system it is possible to know the phage titer of a milk sample in just 30 min, while a microbiological assay will take 12–24 h. The reaction showed a high specificity and sensitivity, since the detection limit has been established in 1 pfu per reaction. Moreover, since each of the probes, *cos* and *pac*, can be labeled with a different reporter dye (Figure 22.5b), it is possible to classify the detected phages, again in less than half an hour, within the two groups that have been established based on the DNA packaging mechanism [42].

The most important advantage of the proposed system for the dairy industry is probably the considerable time reduction of the analysis. It is possible to detect, quantify, and even classify phages in no more than 30 min, without previous sample preparation requirements, thus being



**Figure 22.5** RT-qPCR amplification curves. (a) Amplification curves and regression line of serial dilutions of a  $\Phi 0BJ$  *S. thermophilus* viral suspension, the number of pfu in the viral suspension and the  $C_t$  obtained are indicated. (b) Multiplex RT-qPCR of  $\Phi 0BJ$  (*cos* type) and  $\Phi P13.2$  (*pac* type) *S. thermophilus* phages in a single reaction using Taqman-MGB probes incorporating Fam (*cos*) and Vic (*pac*). The internal positive control (IC) is labeled with Taqman-MGB Ned specific probe.

suitable for routine use. Till date, this is the first virus detection method based on Taqman-MGB probes and FAST-RT-qPCR technology.

In addition, the availability of different fluorescent dyes and the possibility of their combination, open the possibility to extend the system for the simultaneous detection of other phage species. The FAST-RT-qPCR detection of phages would be of benefit for dairy companies where milk storage time plays an important strategic role with economic implications. The correct and rapid identification and quantification of bacteriophages potentially able to attack starter cultures allows for rapid decisions with regard to the destination of contaminated milk. In addition, the method would also be used to detect and characterize phages within a factory and be included in the Hazard Analysis and Critical Control Points (HACCPs) protocol to prevent phage accumulation niches.

## 22.4 Concluding Remarks

Phage attacks have remained the major cause of fermentation failures in the dairy industry since they were first described in 1935 [2]. The prevalent conditions in dairy industrial environments are ideal for phage propagation, therefore, contamination of fermentation vessels has negative economic consequences. Over the years, many approximations to avoid the phage presence in fermentation plants have been developed, cleaning and sanitation procedures, air control systems, and even newly designed factories. The most successful strategy against phage attack is culture rotation of phage-unrelated strains or strains which present natural phage-resistance mechanisms. A rational design of this rotation systems based on the information obtained by phage characterization will improve their efficiency [21]. Therefore, more studies about the relationship between phages and host strains must be carried out toward the establishment of bases allowing for new and rational culture rotation systems. Molecular biology detection techniques arise as an efficient methodology that is gaining position in dairy plants. It does not mean that classical microbiological techniques must be forgotten. In fact, these techniques give very important information about dairy phages. However, they must be adapted to high-throughput and automation systems reducing significantly the time frame. Since complete eradication of bacteriophages in industrial fermentation settings does not seem possible, the rapid detection, quantification, and identification of phages able to attack starter cultures is an efficient alternative, allowing for speedy decisions with regard to the destination of contaminated milk. In this context, the FAST-RT-qPCR-detection of phages would become the choice detection technique, because it possesses all the basic ideal requirements to be settled down for routine use: rapid detection, specificity, and high sensitivity. In addition, most of the RT-qPCR supplier companies offer innovative complete solutions to get full automated systems adapted to industrial needs. The only drawback could be the cost; however, the increasing use of this technique is reducing the cost per sample analysis making it a very attractive solution for dairy companies.

## References

1. Josephsen, J. and H. Neve. 1998. Bacteriophages and lactic acid bacteria. In: *Lactic Acid Bacteria. Microbiology and Functional Aspects*. Eds. Salminen, S., and S. von Wright, Marcel Dekker Inc. New York.
2. Whitehead, H. R. and G. A. Cox. 1935. The occurrence of bacteriophage in cultures of lactic streptococci. *N. Z. J. Dairy Sci. Technol.* 16:319–20.
3. Emond, E. and S. Moineau. 2007. Bacteriophages and food fermentations. In: *Bacteriophage: Genetics and Molecular Biology*. Eds. McGrath, S. and D. van Sinderen, pp. 93–124. Horizon Scientific Press/ Caister Academic Press. Norwich, U.K.
4. Canchaya, C., C. Proux, G. Fourmous, A. Bruttin, and H. Brüssow. 2003. Prophage genomics. *Microbiol. Mol. Biol. Rev.* 67:238–76.
5. Lucchini, S., F. Desiere, and H. Brüssow. 1999. The genetic relationship between virulent and temperate *Streptococcus thermophilus* bacteriophages: Whole genome comparison of *cos*-site phages Sfi19 and Sfi21. *Virology* 260:232–43.
6. Klaenhammer, T. R. and F. G. Fitzgerald. 1994. Bacteriophages and bacteriophage resistance. In: *Genetics and Biotechnology of Lactic Acid Bacteria*. Ed. Gasson, M. J., and W. M de Vos, pp. 106–68. Blackie, Glasgow, U.K.
7. Brüssow, H. and F. Desiere. 2001. Comparative phage genomics and the evolution of *Siphoviridae*: Insights from dairy phages. *Mol. Microbiol.* 39:213–22.

8. Neve, H. and M. Teuber. 1991. Basic microbiology and molecular biology of bacteriophage of lactic acid bacteria in dairies. *Bull. IDF* 263:3–15.
9. Svensson, U. and A. Christiansson. 1991. Methods for phage monitoring. *Bull. IDF* 263:29–39.
10. Ladero, V., P. García, V. Bascarán, M. Herrero, M. A. Alvarez, and J. E. Suárez. 1998. Identification of the repressor-encoding gene of the *Lactobacillus* bacteriophage A2. *J. Bacteriol.* 180:3474–6.
11. Bhimani, R. S. and Y. M. Freitas. 1993. Growth characteristics of lactococcal phages isolated from the dairy sources in India. *J. Dairy Sci.* 76:3338–49.
12. Houlberg, U., P. Herbsleb, and J. Sturino. 2005. Method and system for colorimetric determination of a chemical or physical property of a turbid medium. Patent: WO2005068982.
13. Carminati, D. and E. Neviani. 1991. Application of the conductance measurement technique for detection of *Streptococcus salivarius* ssp. *thermophilus* phages. *J. Dairy Sci.* 74:1472–6.
14. Michelsen, O., A. Cuesta-Dominguez, B. Albrechtsen, and P. R. Jensen. 2007. Detection of bacteriophage-infected cells of *Lactococcus lactis* by using flow cytometry. *Appl. Environ. Microbiol.* 73:7575–81.
15. Lembke, J. and M. Teuber. 1979. Detection of bacteriophage in whey by an enzyme-linked immunosorbent assay. *Milchwissenschaft*, 34:457–8.
16. Moineau, S., D. Bernier, M. Jobin, J. Hebert, T. R. Klaenhammer, and S. Pandian. 1993. Production of monoclonal antibodies against the major capsid protein of the *Lactococcus* bacteriophage ul36 and development of an ELISA for direct phage detection in whey and milk. *Appl. Environ. Microbiol.* 59:2034–40.
17. Chibani-Azaïez, S. R., I. Fliss, R. E. Simard, and S. Moineau. 1998. Monoclonal antibodies raised against native major capsid proteins of lactococcal C2-like bacteriophages. *Appl. Environ. Microbiol.* 64:4255–9.
18. Ledebøer, A. M., S. Bezemer, J. J. W. de Haard, I. M. Schaffers, C. T. Verrips, C. van Vliet, E. M. Düsterhöft, P. Zoon, S. Moineau, and L. G. J. Frenken. 2002. Preventing phage lysis of *Lactococcus lactis* in cheese production using a neutralizing heavy-chain antibody fragment. *J. Dairy Sci.* 85:1376–82.
19. Moineau, S., J. Fortier, and S. Pandian. 1992. Direct detection of lactococcal bacteriophages in cheese whey using DNA probes. *FEMS Microbiol. Lett.* 92:169–74.
20. Labrie, S. and S. Moineau. 2000. Multiplex PCR for detection and identification of lactococcal bacteriophages. *Appl. Environ. Microbiol.* 66:987–94.
21. Binetti, A. G., B. del Rio, M. C. Martín, and M. A. Alvarez. 2005. Detection and characterization of *Streptococcus thermophilus* phages based on the antireceptor gene sequence. *Appl. Environ. Microbiol.* 71:6096–103.
22. Dupont, K., F. K. Vogensen, and J. Josephsen. 2005. Detection of lactococcal 936-species bacteriophages in whey by magnetic capture hybridization PCR targeting a variable region of receptor-binding protein genes. *J. Appl. Bacteriol.* 98:1001–9.
23. del Río, B., A. G. Binetti, M. C. Martín, M. Fernández, A. H. Magadán, and M. A. Álvarez. 2007. Multiplex PCR for the detection and identification of dairy bacteriophages in milk. *Food Microbiol.* 24:75–81.
24. Sharpe, A. N. 1993. Rapid tests for food microbiology quality. *Food Aust.* 45:129–34.
25. Jarvis, A. W., G. F. Fitzgerald, M. Mata, A. Mercenier, H. Neve, I. B. Powell, C. Ronda, M. Saxelin, and M. Teuber. 1991. Species and type phages of lactococcal bacteriophages. *Intervirology.* 32:2–9.
26. Deveau, H., S. J. Labrie, M. C. Chopin, and S. Moineau. 2006. Biodiversity and classification of lactococcal phages. *Appl. Environ. Microbiol.* 72:4338–46.
27. Moineau, S., M. Borkaev, B. J. Holler, S. A. Walker, J. K. Kondo, E. R. Vedamuthu, and P. A. Vandenberg. 1996. Isolation and characterization of lactococcal bacteriophages from cultured buttermilk plants in the United States. *J. Dairy Sci.* 79:2104–11.
28. Moineau, S. 1999. Applications of phage resistance in lactic acid bacteria. *Anton. Leeuw. Int. J. G.* 76:377–82.

29. Bissonnette, F., S. Labrie, H. Deveau, M. Lamoureux, and S. Moineau. 2000. Characterization of mesophilic mixed starter cultures used for the manufacture of aged cheddar cheese. *J. Dairy Sci.* 83:620–7.
30. Mullis, K. B. and F. A. Faloona. 1987. Specific synthesis of DNA *in vitro* via a polymerase-catalyzed chain reaction. *Methods Enzymol.* 155:335–50.
31. Brüssow, H. 2001. Phages of dairy bacteria. *Annu. Rev. Microbiol.* 55:283–303.
32. Ackermann, H. W. 2006. 5500 phages examined in the electron microscope. *Arch. Virol.* 152:227–43.
33. Starbuck, M. A., P. J. Hill, and G. S. Stewart. 1992. Ultra sensitive detection of *Listeria monocytogenes* in milk by the polymerase chain reaction (PCR). *Lett. Appl. Microbiol.* 15:248–52.
34. Brüssow, H., M. Freimont, A. Bruttin, J. Sidoti, A. Constable, and V. Fryder. 1994. Detection and classification of *Streptococcus thermophilus* bacteriophages isolated from industrial milk fermentation. *Appl. Environ. Microbiol.* 60:4537–43.
35. Allmann, M., C. Höfelein, E. Köppel, J. Lüthy, R. Meyer, C. Niederhauser, B. Wegmüller, and U. Candrian. 1995. Polymerase chain reaction (PCR) for detection of pathogenic microorganisms in bacteriological monitoring of dairy products. *Res. Microbiol.* 146:85–97.
36. Martín, M. C., V. Ladero, and M. A. Alvarez. 2006. PCR identification of lysogenic *Lactococcus lactis* strains. *J. Verbr. Lebensm.* 1:121–4.
37. Quiberoni, A., D. Tremblay, H. W. Ackermann, S. Moineau, and J. A. Reinheimer. 2006. Diversity of *Streptococcus thermophilus* phages in a large-production cheese factory in Argentina. *J. Dairy Sci.* 89:3791–9.
38. Mackay, I. M. 2004. Real-time PCR in the microbiology laboratory. *Clin. Microbiol. Infect.* 10:190–212.
39. Holland, P. M., R. D. Abramson, R. Watson, and D. H. Gelfand. 1991. Detection of specific polymerase chain reaction product by utilizing the 5' to 3' exonuclease activity of *Thermus aquaticus* DNA polymerase. *Proc. Natl. Acad. Sci. U.S.A.* 88:7276–80.
40. Heid, C. A., J. Stevens, K. J. Livak, and P. M. Williams. 1996. Real-time quantitative PCR. *Genome Res.* 6:986–94.
41. del Río, B., M. C. Martín, N. Martínez, A. H. Magadán, and M. A. Álvarez. 2008. Multiplex fast real-time polymerase chain reaction for quantitative detection and identification of *cos* and *pac* *Streptococcus thermophilus* bacteriophages. *Appl. Environ. Microbiol.* 74:4779–81.
42. Le Marrec, C., D. van Sinderen, L. Walsh, E. Stanley, E. Vlegels, S. Moineau, P. Heinze, G. Fitzgerald, and B. Fayard. 1997. *Streptococcus thermophilus* bacteriophages can be divided into two distinct groups based on mode of packaging and structural protein composition. *Appl. Environ. Microbiol.* 63:3246–53.

**NUTRITIONAL QUALITY**





## Chapter 23

---

# Prebiotics

---

K. C. Mountzouris and P. Tsirtsikos

### CONTENTS

23.1	Introduction.....	485
23.2	Prebiotic Origin, Manufacture, and Physicochemical Properties .....	486
23.3	Analytical Methods .....	487
23.3.1	Determination of Total Dietary Fiber.....	487
23.3.2	Determination of Fructans (Oligofructans, Inulin Derivatives, and Fructo-Oligosaccharides) .....	489
23.3.3	Determination of <i>Trans</i> -Galactooligosaccharides .....	489
23.3.4	Determination of Polydextrose .....	489
23.3.5	Determination of Resistant Maltodextrins .....	496
	References .....	499

### 23.1 Introduction

Prebiotics are food ingredients that currently find many applications in the development of functional foods. They have been defined as “nondigestible food ingredients that beneficially affect the host by selectively stimulating the growth and/or activity of one or a limited number of bacteria in the colon, and thus improve host health” [1]. According to their definition, prebiotics are nonviable food/feed ingredients that should not be confused with probiotics, which are beneficial for health as live microbial feed supplements [2].

In humans prebiotics have been shown to have a beneficial effect on gut physiology and function via the fortification of the numbers and metabolic activities of purportedly beneficial members (e.g., lactic acid bacteria, bifidobacteria) of the commensal gastrointestinal (GI) microflora [3–6]. In addition, results from animal models indicate that via the fortification of the beneficial



GI microflora, prebiotics may enhance defense mechanisms of the host, increase resistance to various health challenges and accelerate the recovery of GI-tract disturbances [7].

Other beneficial properties of prebiotics include relief from constipation due to their function as dietary fiber [8–10], contribution to lower dietary energy intake and lower glycemia compared with equal amounts of digestible carbohydrates.

From the three principal macronutrients of foods (i.e., proteins, carbohydrates, and fats) only carbohydrates are currently represented in the prebiotic concept. In particular, prebiotics belong to the class of nondigestible carbohydrates and could therefore be regarded as dietary fiber components [8,11].

The most commonly researched prebiotics include inulin (i.e., storage carbohydrate consisting mainly of fructose moieties found in certain plants such as chicory), fructo-oligosaccharides or oligofructose [3,12,13], *trans*-galactooligosaccharides [14], and high-amylose starch [15,16].

Examples of foods containing prebiotics include dairy products (i.e., yoghurts and milk), cereal bars, breakfast cereals, biscuits, cookies, various ready meals, soft drinks, confectionary, infant formulae and weaning foods, table sugar, vinegar, and powdered soup [17–19]. From the prebiotic products, inulin, oligofructose, and *trans*-galactooligosaccharides (TGOS) are very popular. Other food applications for inulin and oligofructose include baked goods and breads, fillings, fruit preparations, salad dressings, meat products, dietetic products and meal replacers, table sugar, and chocolate [20].

## 23.2 Prebiotic Origin, Manufacture, and Physicochemical Properties

Prebiotic ingredients form part of a normal diet since they exist in nature in a variety of foods such as garlic, onions, leeks, asparagus, chicory, artichokes, bananas, human milk, wheat, maize, and soy. For example, it has been estimated that the average intake of fructans through the normal diet amounts to several grams per day [10]. Commercially available prebiotic carbohydrates are shown in Table 23.1.

Generally oligosaccharides of nonstarch origin dominate the prebiotic arena with the exception of isomalto-oligosaccharides that however get partly digested in the upper gut. Prebiotic polysaccharides include inulin which is one of the most widely studied prebiotics [3,13] and resistant starch (e.g., high amylose) [15,16].

Commercially available prebiotics are supplied in the form of powder and/or solutions of variable purity and concentration level. They are produced by different extraction methods from their natural sources (e.g., inulin), enzymatic processes (e.g., oligo fructose and TGOS), and chemical modification (e.g., lactulose) [14].

Prebiotics have been classified as food or food ingredients in all EU countries and therefore can be used without specific limitations as ingredients in foods and drinks [20].

The physicochemical composition of the prebiotic carbohydrates is important not only for their effects in GI physiology and function but also for their application in food science. Factors such as the type of sugar moieties, the type of glycosidic linkages present, and the molecular weight of the prebiotic molecule determine the selectivity of their fermentation by the intestinal microflora [21].

Moreover, physicochemical properties such as viscosity, solubility, solution stability, crystallization, freezing point depression, sweetness, humectant properties, heat, and acid resistance will determine the functionality of the prebiotic molecules in food systems.

**Table 23.1 Names and Chemical Formulas of Common Prebiotic Food Ingredients**

<i>Prebiotic Name</i>	<i>Chemical Formula</i>
Inulin	$\beta\text{-D-Fru-(1} \rightarrow 2\text{)-}[\beta\text{-D-Fru-(1} \rightarrow 2\text{)-}]_{n=1 \text{ to } >60}$
	$\alpha\text{-D-Glu-(1} \rightarrow 2\text{)-}[\beta\text{-D-Fru-(1} \rightarrow 2\text{)-}]_{n=2 \text{ to } >60}$
Fructooligosaccharides or oligofructose	$\alpha\text{-D-Glu-(1} \rightarrow 2\text{)-}[\beta\text{-D-Fru-(1} \rightarrow 2\text{)-}]_{n=2-4}$
	$\alpha\text{-D-Glu-(1} \rightarrow 2\text{)-}[\beta\text{-D-Fru-(1} \rightarrow 2\text{)-}]_{n=2-9}$
	$\beta\text{-D-Fru-(1} \rightarrow 2\text{)-}[\beta\text{-D-Fru-(1} \rightarrow 2\text{)-}]_{n=1-9}$
TGOS	$\alpha\text{-D-Glu-(1} \rightarrow 4\text{)-}[\beta\text{-D-Gal-(1} \rightarrow 6 \text{ or } 1 \rightarrow 4\text{)-}]_{n=2-5}$
Lactulose	$\beta\text{-D-Gal-(1} \rightarrow 4\text{)-}\beta\text{-D-Fru}$
Lactosucrose <sup>a</sup>	$\beta\text{-D-Gal-(1} \rightarrow 4\text{)-}\alpha\text{-D-Glu-(1} \rightarrow 2\text{)-}\beta\text{-D-Fru}$
Xylooligosaccharides	$[\beta\text{-D-Xyl-(1} \rightarrow 4\text{)-}]_{n=2-9}$
Soybean oligosaccharides	$[\alpha\text{-D-Gal-(1} \rightarrow 6\text{)-}]_{n=1-2} \alpha\text{-D-Glu-(1} \rightarrow 2\text{)-}\beta\text{-D-Fru}$
Isomaltooligosaccharides	$[\alpha\text{-D-Glu-(1} \rightarrow 6\text{)-}]_{n=2-5}$

<sup>a</sup> Lactulose is used therapeutically for the treatment of constipation and hepatic encephalopathy and is therefore not used in food formulations in Europe.

From the prebiotics described in Table 23.1 oligofructose, inulin, and TGOS are extensively used by the European food industry. For these prebiotics, food manufacturers have the opportunity to consider making nutritional and health claims for their products as there is accumulating scientific evidence on their beneficial effects *in vivo* in animals and humans. In addition, they are produced in large quantities by companies which provide a high level of technical support for food applications involving their products.

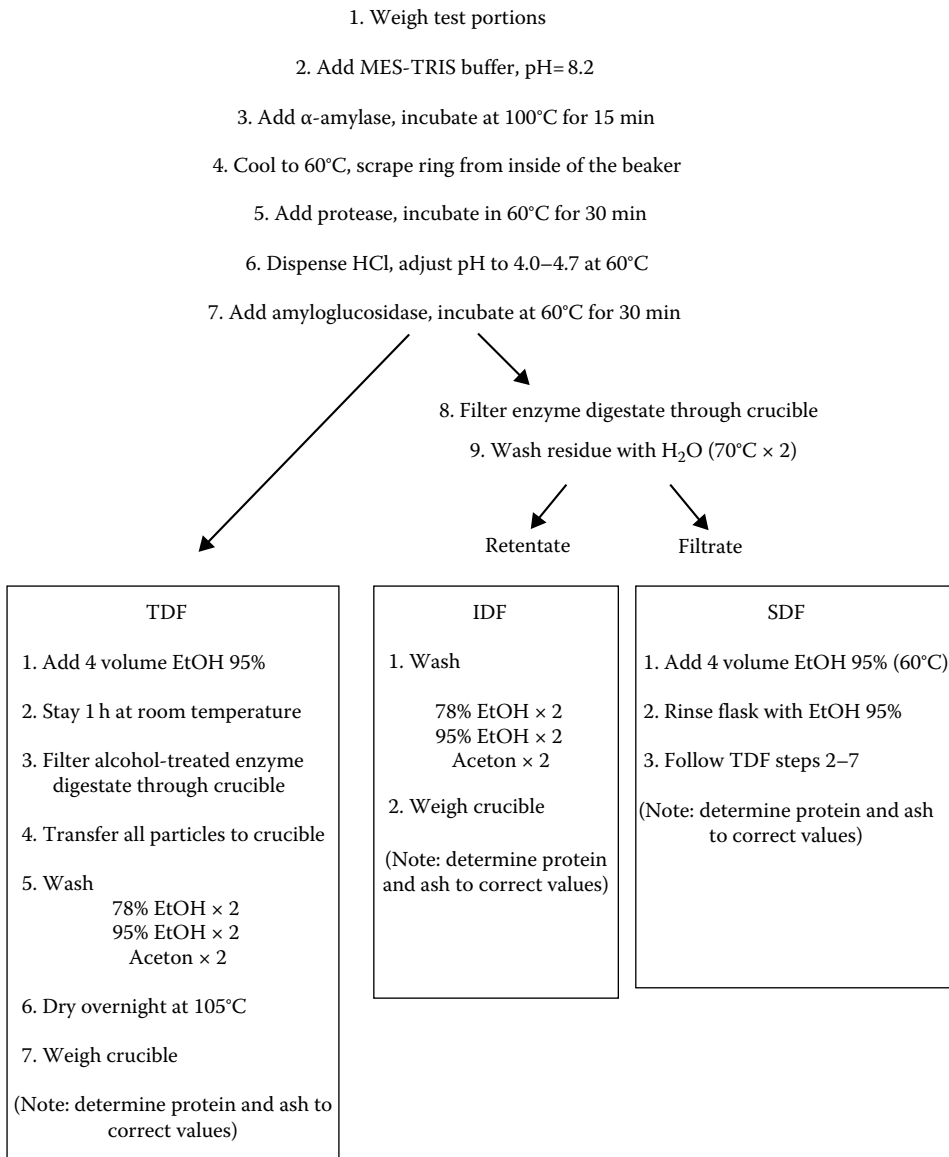
In the section below the analytical methods used for the quantification of prebiotics in foods will be given. Since prebiotics could be considered as dietary fiber components, a description of the official methods available for the determination of total dietary fiber (TDF) in foods was considered relevant and appropriate to start the section.

## 23.3 Analytical Methods

### 23.3.1 Determination of Total Dietary Fiber

The importance of measuring dietary fiber in food and feed led to the development of a method, which utilizes standard laboratory equipment. The AOAC 985.29 method [22,23] has been reported as the first official AOAC method that calculated TDF as the sum of alcohol precipitated soluble dietary fiber (SDF) fraction and filtered insoluble dietary fiber (IDF) fraction. In addition, the AOAC 991.42 method [24,25] that followed, attempted to determine TDF as the sum of IDF and SDF fractions. However, because of the unacceptable variability in measuring the SDF fraction, the method was only given an AOAC approval to measure IDF. Another disadvantage of earlier methods was the use of phosphate buffer that led to coprecipitation of the phosphates and gave higher residue values, thus led to overestimation of the dietary fiber values. The replacement

of phosphate with the organic 2-(*N*-morpholino) ethanesulfonic acid/tris(hydroxymethyl) aminomethane (MES-TRIS) buffer resulted in the measurement of TDF, either by direct measurement or as the sum of IDF and SDF (AOAC 991.43 method [26,27]). With the failure of AOAC 991.42 method [24,25], a modified protocol managed to determine SDF. It was accepted from AOAC referees as the 993.19 method [28,29], but it gained little notice or use because of the availability of the 991.43 method [26,27]. As a result, the AOAC 991.43 method [26,27], which is shown in Figure 23.1, is the most commonly used method worldwide for the measurement of TDF in foods. Method 991.43 has essentially replaced the AOAC 985.29, 991.42 and 993.19 methods [22–29].



**Figure 23.1 Schematic representation of AOAC 991.43 method for the determination of TDF, SDF, and IDF in foods.**

Recently, Tada and Innami [30] modified the three-step enzymatic digestion of AOAC method 991.43 [26,27] to a two-step process without pH adjustment. The validity of the modified method was further ensured by adding  $\alpha$ -amylase stabilizing agents to the reaction system according to Kanaya [31] (Table 23.2).

### **23.3.2 Determination of Fructans (Oligofructans, Inulin Derivatives, and Fructo-Oligosaccharides)**

Many methods for measuring fructans and especially inulin and fructo-oligosaccharides in foods have been reported [32–36]. Among them, the most frequently used method for analysis of fructans is the one described by McCleary et al. [37]. This is known as the AOAC 999.03 method [38], which is a development of the Hoebregs' method [33] (AOAC 997.08 method [39]). In both the methods, fructans are extracted from food samples with hot water, but there are differences regarding the enzymatic treatments described below. In particular, the AOAC 999.03 method [37,38] uses a combination of sucrase/amylase and fructanase solution to remove starch and reducing sugars, in contrast to AOAC 997.08 method [33,39] which uses amyloglucosidase and inulinase solution for the same purpose. The disadvantage of 997.08 method [33,39] is that small inaccuracies in the determination of high glucose or sucrose values from samples rich in starch, maltodextrines, or sucrose, can sometimes significantly overestimate the glucose contents resulting from fructans. Furthermore, the AOAC 999.03 method [37,38] is easy to use and requires no specialized equipment or highly skilled technicians. The colorimetric determination of fructans according to AOAC 999.03 method [37,38] is shown in Figure 23.2.

Other methods for determination of fructans have been reported in the literature. Steegmans et al. [40] developed an enzymatic and colorimetric method for the determination of inulin via a UV method (Table 23.2). This method allows the accurate quantification of different types of oligomers produced by the hydrolysis of inulin in contrast to AOAC 999.03 method [37,38].

### **23.3.3 Determination of Trans-Galactooligosaccharides**

*Trans*-galactooligosaccharides are soluble galactans that can be classified as dietary fiber because they pass through the small intestinal intact undigested and get fermented in the colon by the intestinal flora. De Slegte [41] organized a successful AOAC collaborative study for the determination of TGOS in food products and the resulting analytical method has been approved as the AOAC 2001.02 method [42] (Table 23.2). According to this method, a buffered extract of the sample containing TGOS is treated with  $\beta$ -galactosidase, which hydrolyzes TGOS to galactose and glucose. For the blank solution it is very important that the enzyme solution has been completely deactivated before mixing it with the sample. Otherwise, elevated initial galactose will be measured resulting in underestimation of the true TGOS content. The procedure described above is schematically represented in Figure 23.3.

### **23.3.4 Determination of Polydextrose**

The first method developed to measure polydextrose in food involved an aqueous extraction of polydextrose, followed by a colorimetric assay described by Dubois et al. [43]. Later it was attempted to calculate the quantity of polydextrose in food with the aid of methods used to determine TDF

**Table 23.2 Determination of Prebiotics According to AOAC Official Methods and Newer Trends**

References	Quantified Compounds	Type of Method	Materials and Conditions	Comments and Conclusions
Prosky et al. [27] AOAC 991.43 [26]	Total, soluble, and IDF	Enzymatic/ gravimetric	Enzymes: amylase, protease, and amyloglucosidase	The use of organic buffers (MES-TRIS) in place of phosphate buffers (985.29) prevents the coprecipitation of the phosphates that gives higher dietary fiber values
			MES-TRIS buffer	
Kanaya [31]	TDF	Enzymatic/ gravimetric	Enzymes: thermostable amylase, neutral protease, and amyloglucosidase	The use of developed enzymes modified method 985.29 to a nontime-consuming method. The enzymatic digestion was performed successfully without pH adjustment
Hoebregs et al. [33]; AOAC 997.08 [39]	Fructans (oligofructans, inulin derivatives and fructo-oligosaccharides)	Enzymatic/ HPAEC-PAD	Enzymes: amyloglucosidase and inulinase	Small inaccuracies in the determination of high glucose or sucrose values from samples containing high starch, maltodextrins, or sucrose amounts can sometimes significantly influence the small glucose contents resulting from fructans
			Columns: analytical, CarboPac PA1 4.0 mm x 25 cm	
			Guard, CarboPac PA 4.0 mm x 5 cm	
			Mobile phase, eluents: (a) carbonate-free NaOH 10 mM and (b) carbonate-free NaOH 1 M	
			Analysis time: 83 min	

McCleary et al. [37]	Fructans (oligofructans, inulin derivatives, and fructo-oligosaccharides)	Enzymatic/colorimetric	Enzymes: sucrase/amylase and fructanase Measured by PAHBAH reducing sugar assay reagent Abs: 410 nm	A specific sucrase enzyme is used to remove sucrose, whereas in AOAC 997.08 method this is allowed for after chromatographic separation. So the current method is easy to use and requires no specialized equipment
AOAC 999.03 [38]				
Corradini et al. [49]	Fructans (oligofructans, inulin derivatives, and fructo-oligosaccharides)	Bacterial fermentation ( <i>Bifidobacterium</i> sp.) and HPAEC-PAD	Column: CarboPac PA100 Mobile phase eluents: (a) water, (b) NaOH 0.6 M, and (c) CH <sub>3</sub> COONa 0.5 M Analysis time: 110 min	Provides significant information about interactions among bacteria and prebiotic fibers
Steegmans et al. [40]	Fructans (oligofructans, inulin derivatives, and fructo-oligosaccharides)	Enzymatic/colorimetric	Enzymes: sucrase and fructanase Enzymatic, spectrophotometric measurement	Compares the results with AOAC 997.08 and AOAC 999.03 method. In contrast to AOAC 999.03, the method described allows the accurate quantification of all inulin oligomers

(continued)

Table 23.2 (continued) Determination of Prebiotics According to AOAC Official Methods and Newer Trends

References	Quantified Compounds	Type of Method	Materials and Conditions	Comments and Conclusions
De Slegte [41] AOAC 2001.02 [42]	TGOS	Enzymatic/ HPAEC-PAD	<p>Enzyme: <math>\beta</math>-galactosidase</p> <p>Columns: analytical, CarboPac PA1 4.0 mm <math>\times</math> 25 cm</p> <p>Guard, CarboPac PA 4.0 mm <math>\times</math> 5 cm i.d.</p> <p>Mobile phase, eluents: (a) carbonate-free NaOH 12.5 mM, (b) carbonate-free NaOH 125 M, (c) carbonate-free NaOH 125 mM + CH<sub>3</sub>COONa 500 mM</p> <p>Analysis time: 61 min</p>	It is extremely important to deactivate the enzyme properly before bringing it into contact with the test extract. Otherwise, elevated initial galactose is measured, resulting in underestimation of the final TGOS content
Montilla et al. [50]	Oligosaccharides (fructo-oligosaccharides, galactooligosaccharides, maltodextrines)	HRGC and HT-HRGC	<p>HRGC</p> <p>Column: CP-SIL 5CB 8 m <math>\times</math> 0.25 mm i.d., 0.25 <math>\mu</math>m thickness</p> <p>Detector: 365°C</p> <p>Analysis time: 75.65 min</p> <p>HT-HRGC</p> <p>Column: HT5, 12 m <math>\times</math> 0.32 mm i.d., 0.1 <math>\mu</math>m thickness</p> <p>Detector: 444°C</p> <p>Analysis time: 54 min</p>	The accuracy, repeatability, and reproducibility of the HRGC method were acceptable and similar to the results obtained with HT-HRGC method. Oligosaccharides with DP up to 7 could be detected without the use of sugar hydrolysis

Craig et al. [44]	Polydextrose	Enzymatic and HPAEC-ED	Enzymes: amyloglucosidase, isoamylase, and fructanase Columns: analytical, CarboPac PA1 4.0 mm x 25 cm Guard, CarboPac PA1 3.0 mm x 2.3 cm i.d. Mobile phase, eluents: (a) NaOH 0.15 M and (b) NaOH 0.15 M + CH <sub>3</sub> COONa 0.5 M Analysis time: 20 min	The chromatogram may have a pronounced front tailing in some samples. This is often corrected by cleaning or replacing the detector electrodes.
AOAC 2000.11 [45]				
Guenu et al. [46]	Maltodextrins	HPLC-ELSD	Column 1: octadecyl-silica Spherisorb ODS-1 (250 x 4.6 mm i.d., particle size 5 µm) Mobile phase, eluents: (a) water and (b) methanol Time: 55 min Flow: 1 mL min <sup>-1</sup> Column 2: amino-bonded vinyl alcohol copolymer Astec (250 x 4.6 mm i.d.) Mobile phase, eluents: (a) water and (b) acetonitrile Analysis time: 55 min	Determination of the carbohydrate profile of MD from glucose to saccharides of DP 12–13 was achieved using two simple HPLC procedures

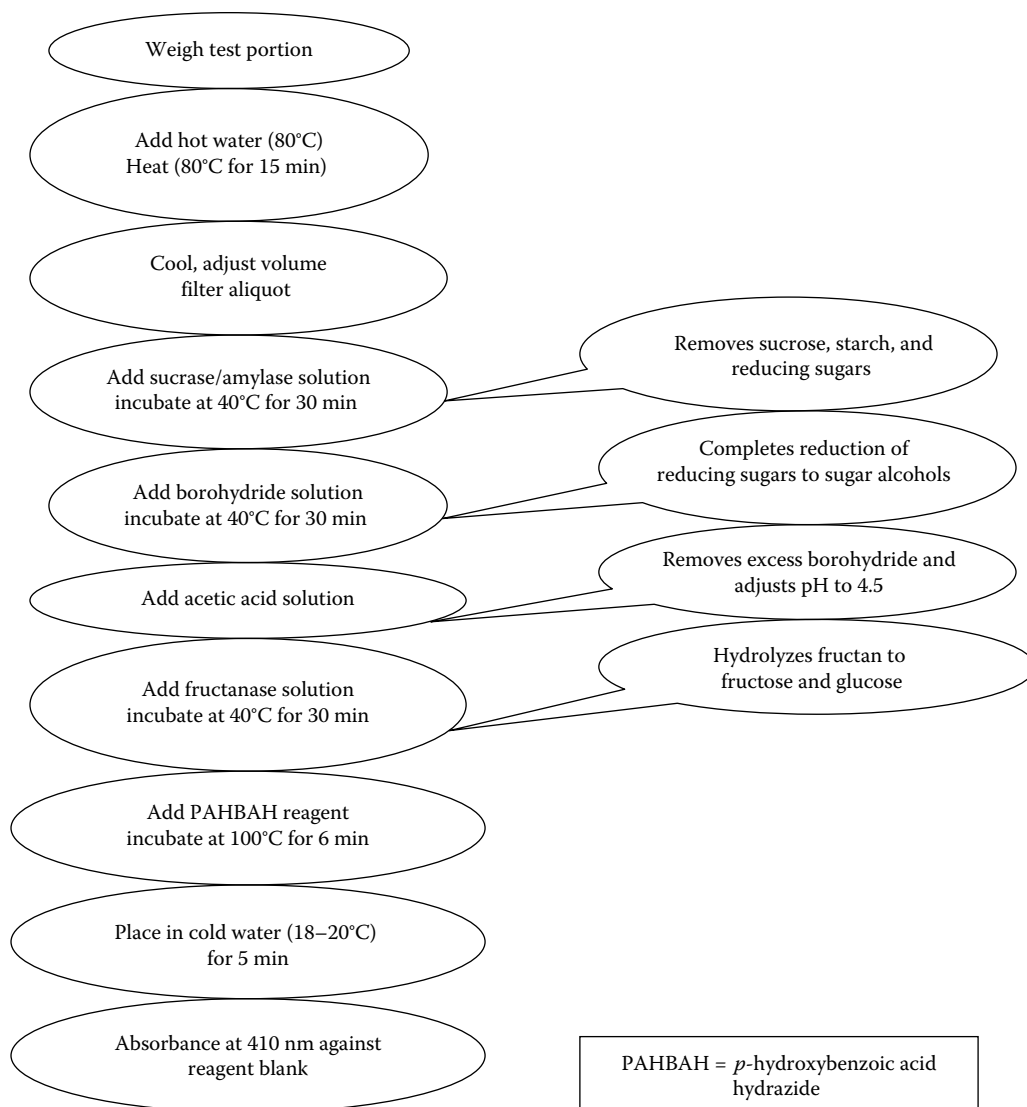
(continued)



**Table 23.2 (continued) Determination of Prebiotics According to AOAC Official Methods and Newer Trends**

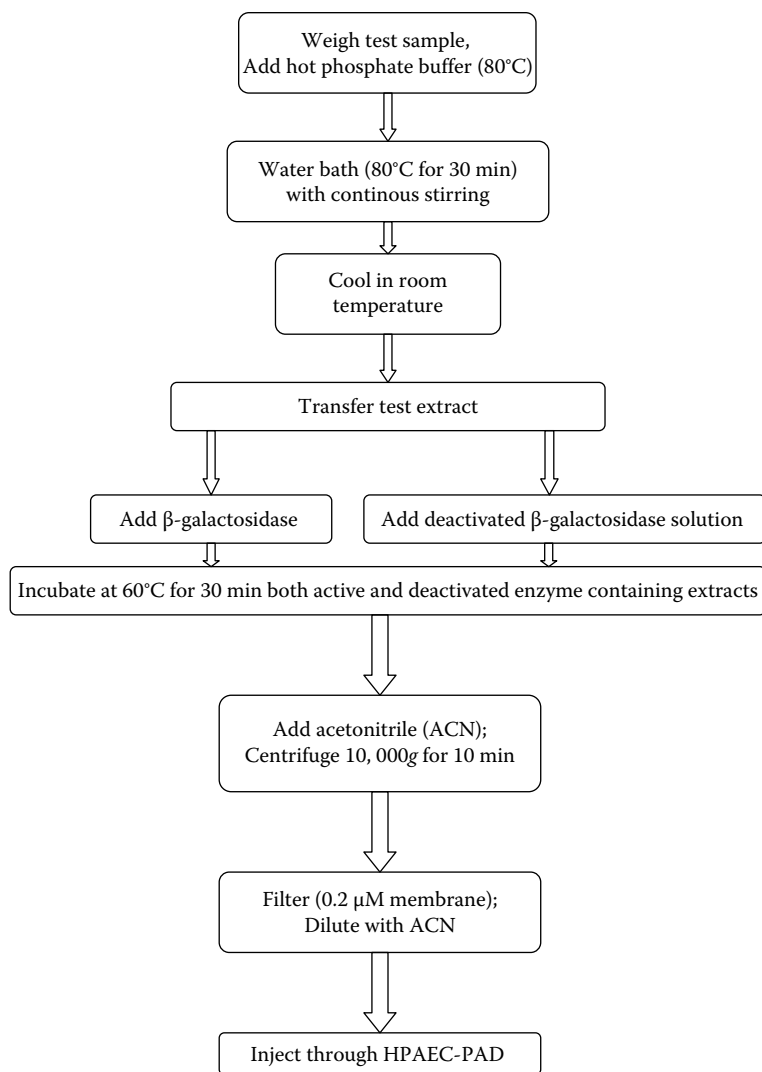
References	Quantified Compounds	Type of Method	Materials and Conditions	Comments and Conclusions
Gordon and Okuma [48]	Total dietary fiber in foods containing RMDs	Enzymatic, gravimetric, and liquid chromatography	Enzyme: amylase, protease, amyloglucosidase Columns: Analytical, 2 LC columns in series, TSK® G2500PWXL, 7.8 mm i.d. x 30 cm	The AOAC 2001.03 method consists of a developed edition of AOAC 985.29 method for RMD. Approximately 45%–55% of RMD is not recovered as TDF using the 985.29 method because the fiber is not precipitated in 78% ethanol.
AOAC 2001.03 [47]			Guard, TSK® PWXL, 6.0 mm i.d. x 4 cm Mobile phase, eluent: distilled water	

HPLC-ELSD, high-performance liquid chromatography evaporative light-scattering detection; HRGC, high-resolution gas chromatography; HT-HRGC, high-temperature high-resolution gas chromatography; HPAEC-PAD, high-performance anion-exchange chromatography with pulsed amperometric detection; HPAEC-ED, high-performance anion-exchange chromatography with electrochemical detection; MD, maltodextrin; DP, degree of polymerization; RMD, resistant maltodextrin.



**Figure 23.2** Schematic representation of AOAC 999.03 method for the determination of fructans in foods.

such as the AOAC 985.29 method [22,23]. However, the AOAC methods for measuring TDF in foods included an ethanol precipitation step in which polydextrose and similar carbohydrates are soluble and therefore discarded and not quantitated. Craig et al. [44] determined polydextrose content for a wide variety of food via high-performance anion-exchange chromatography with electrochemical detection (HPAEC-ED) (Table 23.2). Prior to the analysis they used a centrifugal ultrafiltration step, followed by an enzyme treatment with amyloglucosidase, isoamylase, and fructanase in order to remove potential interfering components. The only drawback is that sometimes chromatographs had a pronounced front tailing in some test samples. This phenomenon can be

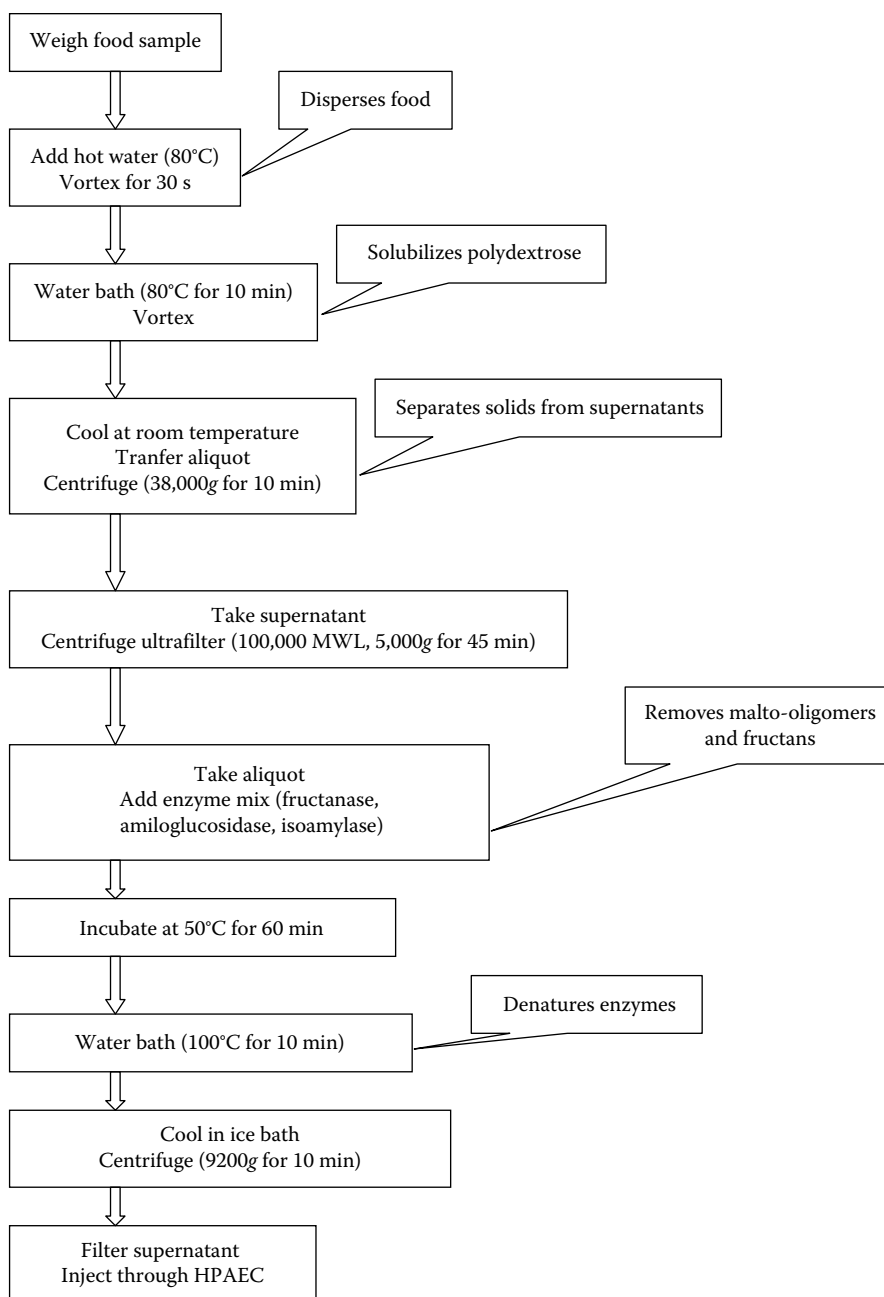


**Figure 23.3** Schematic representation of AOAC 2001.02 method for the determination of TGOS in foods.

corrected by cleaning or replacing the detector electrodes. This method is known as the AOAC 2000.11 method [45] and schematically presented in Figure 23.4.

### 23.3.5 Determination of Resistant Maltodextrins

Liquid chromatography (LC) is the most common method used for the determination of saccharides. However, often this technique requires the use of high pH eluents that result in epimerization and degradation of sugars. In particular, for maltodextrins, Guenu et al. [46] described a method based on LC using an octadecyl-bonded silica column and a methanol/water mobile phase or an

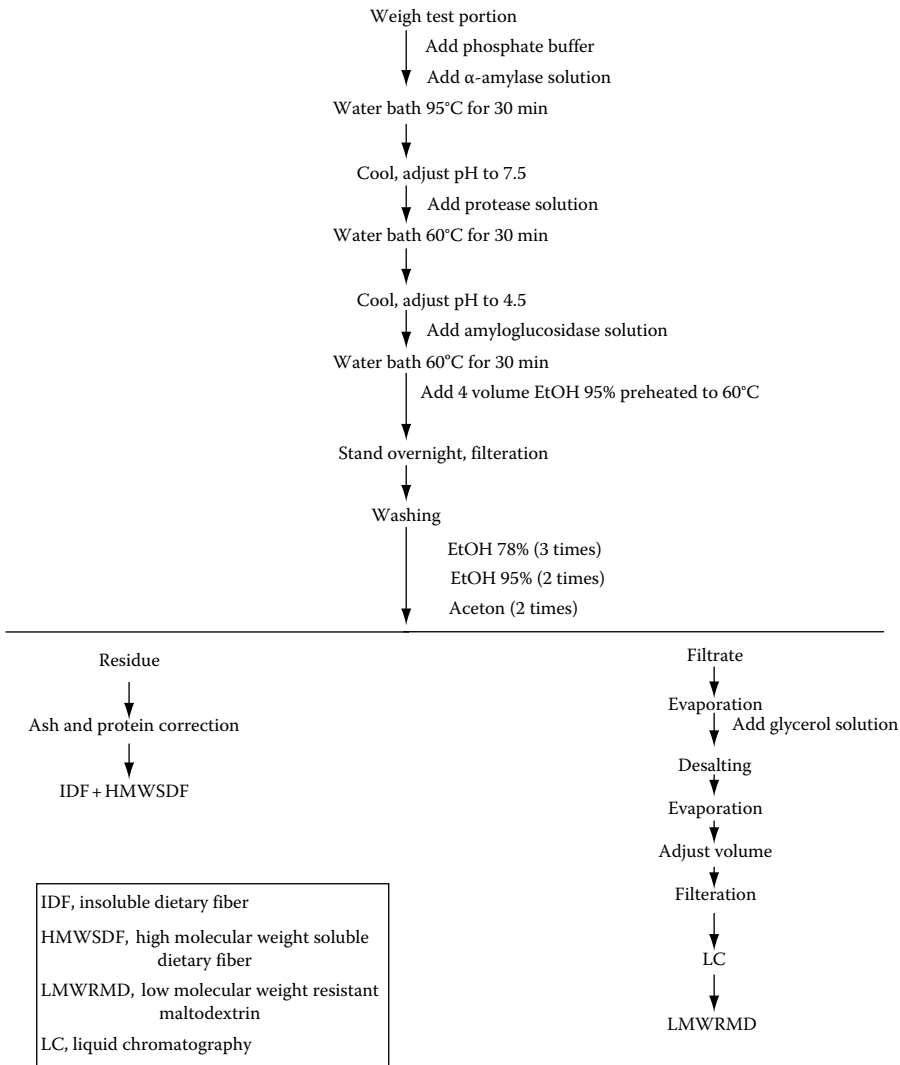


**Figure 23.4** Schematic representation of the AOAC 2000.11 method for the determination of polydextrose in foods.

amino-bonded polymeric stationary phase and an acetonitrile/water eluent (Table 23.2). Recently, a method was developed which has been adopted as the official AOAC method 2001.03 [47,48] that describes an enzymatic/gravimetric and LC determination of dietary fiber containing resistant maltodextrin (RMD). Application of the AOAC 985.29 method [22,23] to foods containing

RMD results in only a portion of RMD getting precipitated in the aqueous/ethanol solution (i.e., high-molecular weight soluble dietary fiber [HMWSDF]). RMDs that are soluble in the aqueous/ethanol solution (low-molecular weight RMD [LMWRMD]) are desalted, concentrated, and measured by LC (Figure 23.5).

It is expected that with the rapid growth of functional food products containing prebiotics and the advent of analytical technologies, existing methods will be further improved and newer official methods will be developed for the quantitative analysis of prebiotic ingredients in food matrices.



**Figure 23.5** Schematic representation of the AOAC 2001.03 method for the determination of dietary fiber containing RMD.

## References

- Gibson, G.R. and Roberfroid, M.B., Dietary modulation of the human colonic microbiota: Introducing the concept of prebiotics, *J. Nutr.*, 125, 1401, 1995.
- Salminen, S. et al., Functional food science and gastrointestinal physiology and function, *Brit. J. Nutr.*, 80, S147, 1998.
- Gibson, G.R. et al., Selective stimulation of bifidobacteria in the human colon by oligofructose and inulin, *Gastroenterology*, 108, 975, 1995.
- Buddington, R.K. et al., Dietary supplement of neosugar alters the fecal flora and decreases activities of some reductive enzymes in human subjects, *Am. J. Clin. Nutr.*, 63, 709, 1996.
- Bouhnik, Y. et al., Administration of transgalacto-oligosaccharides increases fecal bifidobacteria and modifies colonic fermentation metabolism in healthy humans, *J. Nutr.*, 127, 444, 1997.
- Bouhnik, Y. et al., Short-chain fructo-oligosaccharide administration dose-dependently increases fecal bifidobacteria in healthy humans, *J. Nutr.*, 129, 113, 1999.
- Buddington, R.K. et al., Non-digestible oligosaccharides and defence functions: lessons learned from animal models, *Brit. J. Nutr.*, 87, S231, 2002.
- Roberfroid, M., Dietary fiber, inulin, and oligofructose: A review comparing their physiological effects, *Crit. Rev. Food Sci. Nutr.*, 33, 103, 1993.
- Teuri, U. and Korpela, R., Galacto-oligosaccharides relieve constipation in elderly people, *Ann. Nutr. Metab.*, 42, 319, 1998.
- Van Loo, J., Functional food properties of non-digestible oligosaccharides: A consensus report from the ENDO project (DGXII AIRII-CT94–1095), *Brit. J. Nutr.*, 81, 121, 1999.
- Codex Alimentarius Commission and FAO/WHO, Proposals for a definition and methods of analysis for dietary fiber content, ALINORM 03/26A, 2004. Available at <http://www.codexalimentarius.net/web/>.
- Yun, J.W., Fructooligosaccharides-occurrence, preparation and application, *Enzyme Microb. Technol.*, 19, 107, 1996.
- Kolida, S., Touhy, K., and Gibson, G.R., Prebiotic effects of inulin and oligofructose, *Brit. J. Nutr.*, 87, S193, 2002.
- Sako, T., Matsumoto, K., and Tanaka, R., Recent progress on research and applications of non-digestible galacto-oligosaccharides, *Int. Dairy J.*, 9, 69, 1999.
- Brown, I. et al., Fecal numbers of Bifidobacteria are higher in pigs fed *bifidobacterium longum* with a high amylase cornstarch than with a low amylase cornstarch, *J. Nutr.* 127, 1822, 1997.
- Wang, X. et al., In vitro utilisation of amylopectin and high amylose maize (amylo maize) starch granules by human colonic bacteria, *Appl. Environ. Microbiol.*, 65, 4848, 1999.
- Young, J., European market developments in prebiotic- and probiotic-containing foodstuffs, *Brit. J. Nutr.*, 80, S231, 1998.
- Gibson, G., Ottaway, P., and Rastall, R., Legal aspects, In: *Prebiotics New Developments in Functional Foods*, Chandos Publishing Limited, Oxford, 2000.
- Arai, S., Global view on functional foods: Asian perspectives, *Brit. J. Nutr.*, 88, S139, 2002.
- Franck, A., Technological functionality of inulin and oligofructose, *Brit. J. Nutr.*, 87, S287, 2002.
- Olano-Martin, E. et al., In vitro fermentability of dextran oligodextran and maltodextrin by human gut bacteria, *Brit. J. Nutr.*, 83, 247, 2000.
- AOAC official method 985.29. Total dietary fiber in foods, AOAC, 2005. Available at <http://www.eoma.aoac.org/>.
- Prosky, L. et al., Determination of total dietary fiber in foods and food products: collaborative study, *J. AOAC Int.*, 68, 677, 1985.
- AOAC official method 991.42. Insoluble dietary fiber in foods and food products, AOAC, 2005. Available at <http://www.eoma.aoac.org/>.
- Prosky, L. et al., Determination of insoluble and soluble dietary fiber in foods and food products: collaborative study, *J. AOAC Int.*, 75, 360, 1992.

26. AOAC official method 991.43, Total, soluble and insoluble dietary fiber in foods, AOAC, 2005. Available at <http://www.eoma.aocac.org/>.
27. Lee, S.C., Prosky, L., and De Vries J.W., Determination of total, soluble and insoluble dietary fiber in foods—enzymatic gravimetric method, MES-TRIS buffer: Collaborative study, *J. AOAC Int.*, 75, 395, 1992.
28. AOAC official method 993.19, Soluble dietary fiber in foods and food products, AOAC, 2005. Available at <http://www.eoma.aocac.org/>.
29. Prosky, L. et al., Determination of soluble dietary fiber in foods and food products: Collaborative study, *J. AOAC Int.*, 77, 690, 1994.
30. Tada, S., Innami, S., A simplified modification of the AOAC official method for determination of total dietary fiber using newly developed enzymes, *J. AOAC Int.*, 90, 217, 2007.
31. Kanaya, K., A simplified modification of the AOAC official method for determination of total dietary fiber using newly developed enzymes: Preliminary interlaboratory study, *J. AOAC Int.*, 90, 225, 2007.
32. Quemener, B., Thibault, J.F. and Coussement, P., Determination of inulin and oligofructose in food products, and integration in the AOAC method for measurement of total dietary fibre, *Lebensm.-Wiss. Technol.*, 27, 125, 1994.
33. Hoebregs, H., Fructans in foods and food products, ion-exchange chromatographic method: Collaborative study, *J. AOAC Int.*, 80, 1029, 1997.
34. Barthomeuf, C., Grizard, D. and Teulade, J. C., Assay and structural determination of fructo-oligosaccharides synthesized by an enzymatic system from *Penicillium rugulosum*, *Biotechnol. Tech.* 11, 845, 1997.
35. Wang, J., Sporns, P. and Low, N.H., Analysis of food oligosaccharides using MALDI-MS: Quantification of fructooligosaccharides, *J. Agric. Food Chem.*, 47, 1549, 1999.
36. Andersen, R., and Sørensen, A., An enzymatic method for the determination of fructans in foods and food products, *Eur. Food Res. Technol.*, 210, 148, 1999.
37. McCleary, B.V., Murphy, A. and Mugford, D.C., Measurement of fructan in foods by enzymatic/spectrophotometric method: collaborative study, *J. AOAC Int.*, 83, 356, 2000.
38. AOAC official method 999.03, Measurement of fructan in foods, AOAC, 2007. Available at <http://www.eoma.aocac.org/>.
39. AOAC official method 997.08, Fructans in food products, AOAC, 2005. Available at <http://www.eoma.aocac.org/>.
40. Steegmans, M., Iliens, S. and Hoebregs, H., Enzymatic, spectrophotometric determination of glucose, fructose, sucrose and inulin/oligofructose in foods, *J. AOAC Int.*, 87, 1200, 2004.
41. De Slegte, J., Determination of trans-galactooligosaccharides in selected food products by ion-exchange chromatography: collaborative study, *J. AOAC Int.*, 85, 417, 2002.
42. AOAC official method 2001.02, *trans*-Galactooligosaccharides (TGOS) in selected food products, AOAC, 2005. Available at <http://www.eoma.aocac.org/>.
43. Dubois, M. et al., Colorimetric method for determination of sugars and related substances, *Anal. Chem.*, 28, 350, 1956.
44. Craig, S.A.S., Holden, J.F., and Khaled M.Y., Determination of polydextrose in foods by ion chromatography: collaborative study, *J. AOAC Int.*, 84, 472, 2001.
45. AOAC official method 2000.11, Polydextrose in foods, AOAC, 2005. Available at <http://www.eoma.aocac.org/>.
46. Guenu, S., Seigneuret, J.M., and Dreux, M., Analysis of maltodextrins in plant extracts by LC using evaporating light scattering detection, *J. Liq. Chromatogr. Relat. Technol.*, 23, 2883, 2000.
47. AOAC official method 2001.03, Dietary fiber containing supplemented resistant maltodextrin (RMD), AOAC. 2006. Available at <http://www.eoma.aocac.org/>.
48. Gordon, D.T. and Okuma, K., Determination of total dietary fiber in selected foods containing resistance maltodextrin by enzymatic-gravimetric method and liquid chromatography: Collaborative study, *J. AOAC Int.*, 85, 435, 2002.

49. Corradini, C. et al., High-performance anion-exchange chromatography coupled with pulsed amperometric detection and capillary zone electrophoresis with indirect ultra violet detection as powerful tools to evaluate prebiotic properties of fructooligosaccharides and inulin, *J. Chromatogr. A*, 1054, 165, 2004.
50. Montilla, A. et al., Determination of oligosaccharides by conventional high-resolution gas chromatography, *Chromatographia* 63, 453, 2006.





## Chapter 24

---

# Probiotics

---

Ana M. Gomes, Manuela E. Pintado, and F. Xavier Malcata

### CONTENTS

24.1	Introduction.....	503
24.2	Selection of Probiotic Strains .....	506
24.3	Nutritional and Health Features of Probiotic Foods .....	506
24.4	Detection, Identification, and Enumeration of Probiotic Microorganisms .....	508
24.4.1	Conventional Methods of Enumeration .....	509
24.4.2	Fluorescence Methods of Quantification .....	516
24.4.3	Enzymatic Methods of Identification .....	518
24.4.4	Molecular Biology Methods of Identification.....	518
	24.4.4.1 Culture-Dependent Techniques .....	519
	24.4.4.2 Culture-Independent Techniques.....	522
24.5	Overall Critical Assessment of Analytical Methods .....	523
24.6	Conclusions .....	524
	References.....	525

### 24.1 Introduction

The word “probiotic”—from the Greek “for life,” has over the last few decades been used in a multitude of ways. At present, probiotics are described as live microorganisms, which—when administered in adequate numbers, confer a health benefit to the host [12]. Fermented or unfermented dairy foods—including milk, buttermilk, yogurt, ice cream, desserts, and even cheese, are the most common vectors for their administration [4,15]; however, probiotics are also available as dietary supplements—in which the microorganism appears in the forms of powder, capsules, or tablets.

Milk and dairy products contain an array of compounds that provide critical nutritional elements, immunological protection, and biologically active substances to both neonates and adults; therefore, when they are complemented with probiotics, they eventually fall within the realm of functional foods. The excellent nutritional profile and health value of probiotic milk and dairy foods thus rely upon the many bioactive components inherent to milk, coupled with the many metabolic products of the biochemical pathways in resident microflora. In a more detailed analysis, the latter advantages come first from the viable, ingested microorganisms—which by themselves induce changes and play positive ecological roles on the intestinal environment, and secondly from the metabolites they release to the milk matrix during growth or maintenance. Furthermore, fermented dairy foods provide physiological functionality, which is accounted for by the intrinsic biological activity of the microorganisms employed.

The majority of probiotics are bacteria, especially from the genera *Lactobacillus* and *Bifidobacterium* (Table 24.1). A few studies have meanwhile been performed on the probiotic potential of certain pediococci, propionibacteria, and enterococci—*viz.* *Enterococcus faecium* isolated from traditional cheese products [38], which is relatively stable to pH, possesses appropriate technological features, and may even produce bacteriocins against food pathogens (which will accordingly play an active role as biopreservatives).

In order to effectively convey such health functionalities while complying with legislation pertaining to standards of identity, the minimum number of viable probiotic bacteria is suggested as  $10^7$ – $10^8$  colony forming unit (cfu)/g of a product by the time of consumption [15,51]. This range has been put forward to compensate for the expected decline in concentration of probiotic microorganisms during food processing and storage, as well as during passage through the upper and lower parts of the gastrointestinal tract. The Fermented Milks and Lactic Acid Bacteria Beverages Association has also formally adopted  $10^7$  cfu/g as the minimum required for a food to be able to provide measurable effects to humans. However, in such food products for which intrinsic or extrinsic factors may severely constrain viability of probiotic bacteria, said required viable numbers may not be attained at all in the colon. For this reason, technologies such as enteric coating and microencapsulation have been developed and implemented, and also publicized as a most promising method for efficient protection and delivery of (physiologically active) probiotic strains.

In view of the aforementioned fact, survival is essential for probiotic organisms to be able to eventually populate the human gut, and several factors—*viz.* temperature, pH, redox potential,  $pO_2$ , accompanying microbes, sensitivity to antimicrobial substances produced by starter bacteria, lack of nutrients, and gas permeability of packaging materials, affect the viability of probiotic bacteria, and will eventually constrain their successful delivery [15,18,45,46]. The food carrier may even enhance survival during passage through the gastrointestinal tract; this is the case of milk and dairy products, owing also to their buffering capacity.

Cheeses, in particular, contribute greatly toward such bioavailability because of their almost neutral pH, low oxygen level, high fat content, and good consistency—which promote long-term survival of bifidobacteria and lactobacilli, during processing and digestion. Studies addressing this issue have encompassed, among others, Gouda cheese [16], goat's cheese [14], and whey cheese [32] for delivery of viable probiotic bifidobacteria and lactobacilli to the gastrointestinal tract. Nonfermented milk products may also bring about a few advantages as probiotic carriers due to the absence of fermentation end-products—which may possess negative impact on the survival of probiotic bacteria, *viz.* organic acids and flavor compounds in yogurt. On the other hand, ice cream and milk powders are carriers that guarantee a longer survival, because of its storage at low temperature and its low water activity, respectively [13]. However, the high oxygen content in

**Table 24.1 Examples of *Lactobacillus* and *Bifidobacterium* Strains Used as Commercial Probiotic Cultures**

<i>Lactobacillus</i> Species	Strains	<i>Bifidobacterium</i> Species	Strains
<i>L. acidophilus</i>	LA-1/LA-5 (Chr. Hansen)	<i>B. adolescentis</i>	ATCC 15703, 94-BIM
<i>L. acidophilus</i>	NCFM (Danisco)	<i>B. bifidum</i>	Bb-11 (Chr. Hansen)
<i>L. acidophilus</i>	Lafti™, L10 (DSM)	<i>B. breve</i>	Yakult (Yakult)
<i>L. acidophilus</i>	DDS-1 (Nebraska cultures)	<i>B. lactis</i> (reclassified as <i>B. animalis</i> )	Bb-12 (Chr. Hansen)
<i>L. acidophilus</i>	SBT-2062 (Snow Brand Milk Products)	<i>B. lactis</i>	Bb-02 (Chr. Hansen)
<i>L. acidophilus</i>	Ceska®-star A 900 (CSK)	<i>B. lactis</i>	Lafti™, B94 (DSM)
<i>L. acidophilus</i> <i>Johnsonii</i>	La1 (Nestlé)	<i>B. lactis</i>	DR10/HOWARU (Danisco)
<i>L. casei</i>	431 (Chr. Hansen)	<i>B. lactis</i>	Ceska®-star B 100 (CSK)
<i>L. casei</i>	Lafti™, L26 (DSM)	<i>B. animalis</i>	Essensis (Activia, Danone)
<i>L. casei</i> Immunitass	Danone	<i>B. laterosporus</i>	CRL 431
<i>L. casei</i> Shirota	Yakult	<i>B. longum</i>	BB536 (Morinaga Milk Industry)
<i>L. fermentum</i>	RC-14 (Urex Biotech)	<i>B. longum</i>	UCC 35624 (UCCork)
<i>L. helveticus</i>	LH-B02 (Chr. Hansen)	<i>B. longum</i>	SBT-2928 (Snow Brand Milk Products)
<i>L. lactis</i>	L1A (Essum AB)	<i>B. longum</i>	Bb46 (Chr. Hansen)
<i>L. paracasei</i>	CRL 431 (Chr. Hansen)		
<i>L. plantarum</i>	299v (Probi AB)		
<i>L. reuteri</i>	SD2112/MM2 (Biogaia)		
<i>L. rhamnosus</i>	GG (Valio and Chr. Hansen)		
<i>L. rhamnosus</i>	GR-1 (Urex Biotech)		
<i>L. rhamnosus</i>	LB21 (Essum AB)		
<i>L. rhamnosus</i>	271 (Probi AB)		

Source: Adapted from Shah, N.P., *Int. Dairy J.*, 17, 1262, 2007.

ice cream, coupled with the injury due to freezing are disadvantages if a successful delivery of the required levels of viable cells is sought [47].

Finally, it should be noted that probiotic food products should be consumed regularly and in sufficient quantities, so as to deliver the relevant doses (and at the right frequency) of live bacteria to the gut—knowing that losses in cell viability are typically encountered during gastric transit, and that a repetitive input is required via ingestion that is at least equal to the numbers lost daily in one's feces [51].

## 24.2 Selection of Probiotic Strains

The choice of probiotic bacteria for incorporation in novel functional foods implies validation of several technological and physiological characteristics, *viz.* the culture should be: a normal inhabitant of the intestine, nonpathogenic, capable of efficient gut colonization, and delivered to sufficiently high levels. A FAO/WHO [12] expert panel has recently suggested that the specificity of the probiotic action is more important than the source of the probiotic microorganism; this suggestion was based on realization of the uncertain origin of the human intestinal microflora, since infants are born with a virtually sterile intestine. However, the panel also emphasized the need to improve *in vitro* tests, in the attempts to predict the performance of probiotics in humans [58].

The first step in selecting a probiotic strain is determination of its taxonomic classification—which may give a clue as to the origin, habitat, and physiology thereof. Other important safety issues include absence of pathogenicity and infectivity, which are closely related with validation of absence of virulence factors—e.g., toxicity, metabolic activity, and antibiotic resistance. It should be noted that antibiotic-resistance genes (as well as other virulence factors) are normally encoded by plasmids, so they can easily be transferred between microorganisms.

Functional attributes should also be characterized during selection—which include tolerance to gastric acid and bile salts, adhesion to mucosal surfaces, and production of antimicrobial compounds. New probiotic strains should also be screened for their technological performance—including genetic stability, growth rate, stability in milk, acidification ability, favorable organoleptic properties, phage resistance, and suitability for large-scale production.

Finally, desirable physiological properties have to be adequately validated and documented; these encompass immunomodulation, antagonistic activity toward gastrointestinal pathogens (e.g., *Helicobacter pylori* and *Candida albicans*), cholesterol and lactose metabolisms, and antimutagenic and anticarcinogenic properties [37]. Very recently, Vinderola et al. [63] established a set of simple *in vitro* tests—*viz.* identification by species-specific polymerase chain reaction (PCR), genetic diversity, phage sensitivity, growth and viability in milk, resistance to salts and flavor compounds, bacterial interactions, tolerance to simulated gastric juice and bile, bile salt deconjugation, hydrophobicity, and  $\beta$ -galactosidase and antibacterial activities. This set can be assayed for by almost every laboratory of microbiology—even in developing countries, where there is often limited access to sophisticated analytical techniques. Those tests allowed as well the aforementioned authors to identify—among 19 intestinal human isolates, a potential candidate for new probiotic dairy foods designed to the local market.

## 24.3 Nutritional and Health Features of Probiotic Foods

Besides prebiotics, foods that contain probiotics currently represent the largest segment of the functional food market in Europe, Japan, and Australia. A wide variety of probiotic functional dairy foods are now available worldwide—e.g., Yakult, Actimel, and LC-1. In order to improve of the

host's colon microbial balance, several biological actions were considered in the original screening [15]: (a) increased digestive capacity, (b) improved intestinal defenses, (c) sustained and modulated intestinal and systemic immunity, (d) enhanced mucosal barrier, and (e) reduced inflammation and allergic sensitization to foods (Table 24.2). These actions entertained by probiotic bacterial strains make them not only agents with preventive functionalities, but also active curative agents in therapeutic settings. Nevertheless, the underlying molecular mechanisms by which these bacteria function as probiotic organisms are not yet fully understood. Genome sequencing has recently conveyed an insight into the genetic make-up of some members of the *Bifidobacterium* and *Lactobacillus* genera—yet availability of the full genome of the microorganism represents only the first step toward a better understanding of its biology.

The nutritional benefits of probiotics have been studied mostly in milk-based products that were fermented with lactobacilli and bifidobacteria. Such food products are characterized by a lower level of residual lactose, and higher levels of free amino acids and certain vitamins

**Table 24.2 Potential Health and Nutritional Benefits of Functional Foods Prepared with Probiotic Bacteria**

<i>Beneficial Effect</i>	<i>Possible Causes and Mechanisms</i>
Improved digestibility	Partial breakdown of proteins, fats, and carbohydrates
Improved nutritional value	Higher levels of vitamins of B group and certain free amino acids, viz. methionine, lysine, and tryptophan
Improved lactose utilization	Reduced lactose in product, and further availability of lactase
Antagonistic action toward enteric pathogens	Disorders, such as functional diarrhea, mucous colitis, ulcerated colitis, diverticulitis, and antibiotic colitis, controlled by acidity, microbial inhibitors, and prevention of pathogen adhesion or activation
Gut colonization	Survival in gastric acid, resistance to lysozyme and low surface tension in intestine, adhesion to intestinal mucosa, multiplication in intestinal tract, and immune modulation
Anticarcinogenic effect	Conversion of potential precarcinogens into less harmful compounds
	Inhibitory toward some types of cancer, in particular cancers of the gastrointestinal tract, via degradation of precarcinogens, reduction of carcinogen-promoting enzymes, and stimulation of immune system
Hypocholesterolemic action	Production of inhibitors of cholesterol synthesis
	Use of cholesterol, by assimilation and precipitation with deconjugated bile salts
Immune modulation	Enhancement of macrophage formation, and stimulation of production of suppressor cells and $\gamma$ -interferon
Vaccine vehicle	Naturally occurring or rDNA vaccinal epitopes

than their nonfermented counterparts. Furthermore, they preferentially contain L(+)-lactic acid (which is more easily metabolized by human beings than its D(-)enantiomer), released by bifidobacteria in addition to acetic acid; this feature prevents manifestation of metabolic acidosis in infants older than 1 year. Moreover, the L(+)-lactic acid absorbed in the intestine is used as energy source, with a yield of 15 kJ/g—that compares well with that of 16 kJ/g for lactose [66].

*Lactobacillus acidophilus* and bifidobacteria have also been reported to synthesize folic acid, niacin, thiamine, riboflavin, pyridoxine, and vitamin K—all of which are slowly absorbed in the body [39,52]. The vitamins of the B-complex are frequently added to foods, so addition of bifidobacteria to the diet will constitute an alternative, indirect way of meeting that goal. The bioavailability of minerals such as calcium, zinc, iron, manganese, copper, and phosphorus may also be enhanced upon consumption of fermented dairy products containing bifidobacteria—as a result of gastric pH lowering (which facilitates ionization of the said minerals, a requirement for absorption) and protein digestibility improvement [39].

In summary, the increase in digestibility of proteins and fat, the reduction in lactose content, the improved absorption of calcium and iron, the more balanced content of several vitamins, and the presence of extra useful microbial secondary metabolites—coupled with the presence of viable probiotic cells themselves, turn fermented milk (bio)products into the most valuable natural products recommended for human consumption.

## 24.4 Detection, Identification, and Enumeration of Probiotic Microorganisms

The ability to accurately enumerate probiotic bacteria in cultured dairy products—when in the presence of lactic acid bacteria—is crucial in assessing the health benefits of those products, and in determining whether they will convey any therapeutic effect [29]. In general, it is presumed that probiotic viability is a reasonable indicator of probiotic activity; even if viability is not a requirement, it likely correlates with most probiotic effects, as it is an indicator of the number of active cells present regardless of which cell components will be specifically active. It should be noted that most probiotic products in the market are standardized in terms of viable counts, based on the claim that this is the most important factor to consider in actual product functionality. However, a growing concern of consumers and consumer organizations has been witnessed, regarding the quality and labeling of commercial probiotic products. A number of studies have accordingly demonstrated that recovery of the incorporated probiotic microorganism is often poor—and that more attention should be paid to the accurate identity, safety, and functionality of those microorganisms [10,18,20,54].

Ideally, microbiological analysis of probiotic products for taxonomic purposes requires standard and accurate procedures, encompassing both isolation and identification of the probiotic strains at the genus and species levels. The existing isolation media are often insufficiently selective or elective—which, in either case, produces inaccurate and/or nonreproducible quantitative results [33]; in addition, many of them are not commercially available, and are thus cumbersome to prepare. On the other hand, phenotypic characteristics do not always lead to clear results, because bifidobacteria can change their morphology—depending on the growth medium and culture conditions at stake [60]. Despite these drawbacks, plate count methods are still routinely used in quality control assessment of probiotic products—and are as well frequently followed for identification of a limited number of isolates at the species level.

With the advent of molecular biology techniques, an elaborate picture of the probiotic microflora in food has been possible; they may also allow a more comprehensive understanding of the interactions between distinct strains. There is an extensive library of DNA primers available for detection of probiotic bacteria, which are genus- or species-specific and even strain-specific [33,59]. Such primers were developed from the most variable region of the bacterial DNA sequence, i.e., the region that codes for the 16S or 23S ribosomal RNA (rRNA). It should be outlined that the differentiation of bifidobacteria and lactobacilli isolated from probiotic food at the individual strain level is an important tool toward functionality and safety assessments.

#### 24.4.1 Conventional Methods of Enumeration

The culture technique—based on reproduction of bacterial cells on agar plates, is the traditional method used for quality assurance of probiotic products. In the case of products containing a high background of microbes and/or a mixture of several probiotics strains, culture on selective media followed by identification of each strain by accurate molecular methods is a must to assess viability of each probiotic strain.

The aforementioned traditional methods are still widespread in most laboratories, and constitute a simple and relevant analytical tool in attempts to control probiotic bacteria in commercial products. As a rule, the enumeration methodologies should not be complex or time-consuming—and should offer good cell recovery as well [62]. In general, the incubation atmosphere is crucial for successful growth; it should be remembered that aerobic incubation on agar only allows growth of *Lactobacillus* cultures, whereas *Bifidobacterium* growth requires anaerobic conditions. For illustrative purposes, a compilation of the various conventional methodologies utilized to isolate, enumerate, and/or identify probiotic bacteria most commonly encountered (*viz.* *Lactobacillus* and *Bifidobacterium*) is depicted in Table 24.3. Several culture media have accordingly been suggested for isolation and differential/selective enumeration of bifidobacteria and lactobacilli in fermented dairy products, and their performance has been thoroughly discussed elsewhere [4,9,46].

Selective detection and enumeration of *Lactobacillus* and *Bifidobacterium* spp. in dairy products may thus be performed in a variety of ways, as a consequence of extensive research carried out over the years by various researchers—which led to a multitude of differential plating methodologies, which were specifically designed and duly tested. Differentiation by these media is on the basis of specific characteristics of probiotic cultures, such as oxygen tolerance, nutritional requirements, antibiotic susceptibility, and colony morphology and color. The choice of detection and identification methodologies should simultaneously address the issue of the nature of the food product intended as vector, as well as the presence of competing genera [11,26].

The difficulties associated with detection and enumeration of bifidobacteria are accordingly caused by strain specificities, simultaneous presence of various species in the product, and differences found in cell recovery or colony differentiation [67]. Many of the culture media developed to date aimed at enumerating strains of different species have failed due to the lack of recovery of one (or more) species, or the lack of selectivity or differentiation among colonies [4]. Enumeration of bifidobacteria from cultured dairy products that contain only bifidobacteria should, on the other hand, not cause major problems; de Man, Rogosa, and Sharpe (MRS) agar—which is frequently used to enumerate lactic acid and probiotic bacteria in cultured dairy products, is particularly effective when bifidobacteria are the only live culture present [4]. Among the methods listed for enumeration of bifidobacteria as a single culture, Arroyo et al. [2] suggested modified MRS (mMRS) and reinforced clostridial agar (RCA) as best choices (Table 24.3). Lahtinen et al.



**Table 24.3 Examples of Identification and/or Enumeration Methods Available for Detection of *Bifidobacterium* and *Lactobacillus* Strains**

Species	Identification Method	Specifications	References
<i>Bifidobacterium</i> spp.	Modified NPNL-agar (glucose blood liver agar added with neomycin sulfate, paromomycin sulfate, nalidixic acid, and lithium chloride)	Selective medium for enumeration of bifidobacteria in dairy products containing lactobacilli and streptococci	[56]
<i>L. acidophilus</i>	Aesculin cellobiose agar	Hydrolysis of esculin to esculetine by <i>L. acidophilus</i> , which reacts with Fe(III) ions to form olive-green to black complex Other lactobacilli, streptococci, bifidobacteria react differently, or do not grow at all Difficult differentiation between <i>L. acidophilus</i> and <i>L. plantarum</i>	[64]
<i>Bifidobacterium</i> spp.	Modified Columbia agar at pH 5.0, with glucose, cysteine-HCL, and propionic acid	Elective and selective for <i>Bifidobacterium</i> spp. in presence of other gram-positive bacteria ( <i>Enterobacteriaceae</i> )	[3]
<i>Bifidobacterium</i> spp.	TPY agar with dicloxacillin	Recoveries and counts of bifidobacteria in fermented dairy products similar to NPNL agar Lactobacilli and streptococci not detectable	[49]
<i>Bifidobacterium</i> spp. ( <i>B. infantis</i> , <i>B. breve</i> , <i>B. longum</i> , <i>B. bifidum</i> , <i>B. adolescentis</i> )	5-Bromo-4-chloro-3-indolyl- $\alpha$ -D-galactoside-based medium (X- $\alpha$ -Gal)	Identification of bifidobacteria among <i>Lactobacillus</i> strains ( <i>L. acidophilus</i> , <i>L. delbrueckii</i> subsp. <i>bulgaricus</i> , <i>L. helveticus</i> ) Split of X- $\alpha$ -Gal by $\alpha$ -galactosidase activity of bifidobacteria, and release of indol that imparts blue color to bifidobacterial colonies	[7]
<i>Bifidobacterium</i> spp. ( <i>B. infantis</i> , <i>B. Longum</i> , <i>B. bifidum</i> )	Lithium chloride-sodium propionate agar	Selective enumeration of all bifidobacteria (except <i>B. longum</i> ) among lactobacilli and streptococci in fermented dairy products	[27]

<i>B. bifidum</i>	Modified VF-Bouillon medium with lithium chloride, sodium lauryl sulfate, sodium propionate, neomycin sulfate	[6]	
<i>L. acidophilus</i>			
<i>E. faecium</i>			
<i>L. acidophilus</i>	Rogosa agar medium with 40 µg/mL 5-bromo-4-chloro-3-indolyl-β-D-glucopyranoside (X-Glu)	[24]	
<i>Bifidobacterium</i> spp. ( <i>B. infantis</i> , <i>B. longum</i> , <i>B. adolescentis</i> )	Brain heart infusion (BHI), modified Columbia (mCol), modified MRS (mMRS), reinforced clostridial (RCA), and modified blood liver (mBL) agars	[2]	
			Accurate counts of bifidobacteria
			RCA and mMRS as best choice
			mBL with longer preparation time
			5-Day incubation for BHI, and colony pinpointed by size
<i>Bifidobacterium</i> spp. ( <i>B. bifidum</i> , <i>B. infantis</i> , <i>B. longum</i> )	Blood–glucose–liver agar with oxgall and gentamicin	[29]	
<i>L. acidophilus</i>	Bile-MRS agar	[23]	
	Trehalose-MRS (T-MRS)		
	Galactose-MRS (G-MRS)		
<i>B. bifidum</i>	MRS agar with cysteine, sheep's blood, lithium chloride, sodium propionate, and bile salts	[16]	

(continued)

**Table 24.3 (continued) Examples of Identification and/or Enumeration Methods Available for Detection of *Bifidobacterium* and *Lactobacillus* Strains**

Species	Identification Method	Specifications	References
Mixed probiotic culture (lactobacilli, enterococci, and bifidobacteria)	Resuspension medium (KH <sub>2</sub> PO <sub>4</sub> , Na <sub>2</sub> HPO <sub>4</sub> , cysteine, Tween 80, agar, antifoam agent), with multiple-layer diffusion technique	Improved selection of and enumeration in dried cultures of mixed genera compared to MRS-cysteine, acidified MRS, and M17 culture media	[36]
	MRS-maltose agar	Total counts of <i>L. acidophilus</i> and <i>Bifidobacterium</i> spp.	[11,28]
<i>L. acidophilus</i>	MRS-salicin agar	Selective enumeration of <i>L. acidophilus</i>	
	MRS-sorbitol agar	Selective enumeration of <i>Bifidobacterium</i> spp.	
	MRS-NNLP agar		
<i>Bifidobacterium</i> spp.	Reinforced clostridial Prussian blue agar (RCPbPH5)	Selective for <i>Bifidobacterium</i> spp.	[44]
	<i>L. acidophilus</i>		Inhibition of <i>L. acidophilus</i> due to low pH
		Bifidobacteria differentiated on basis of colony color	
<i>Bifidobacterium</i> spp.	Trehalose-MRS	Enumeration of bifidobacteria and <i>L. acidophilus</i> in presence of yogurt bacteria	[62]
	Bile-MRS agar	Growth of only <i>L. acidophilus</i> on trehalose-MRS, bile-MRS agar (aerobic)	
<i>L. acidophilus</i>	Lithium propionate MRS (anaerobic)	Selective count of <i>B. bifidum</i> on lithium propionate MRS	

<i>L. acidophilus</i> , <i>L. casei</i> ,	Bile-MRS agar lithium propionate MRS (LP-MRS)	Starter lactic acid bacteria inhibited by MRS-LP-MRS agar	[62]
<i>L. delbrueckii</i> ssp. <i>bulgaricus</i> ,	<i>S. thermophilus</i> agar, modified pH MRS agar, MRS-vancomycin agar, MRS-bile agar, MRS-NaCl agar, MRS-lithium chloride agar, MRS-NNLP (nalidixic acid, neomycin sulfate, lithium chloride, paramomycin sulfate) agar, reinforced clostridial agar, sugar-based (maltose, galactose, sorbitol, manitol, esculin) media, sodium lactate agar, arabinose agar, raffinose agar, xylose agar, and <i>L. casei</i> agar	Selective colony count, even differential cell enumeration of <i>L. casei</i> by LP-MRS	[57]
<i>L. casei</i>			
<i>L. rhamnosus</i>		<i>L. delbrueckii</i> ssp. <i>bulgaricus</i> on MRS agar (anaerobic, pH 4.58 or 5.20, 45°C, 72 h)	
<i>L. acidophilus</i>		<i>L. rhamnosus</i> on MRS-vancomycin agar (anaerobic, 43°C, 72 h)	
Bifidobacteria		<i>L. casei</i> on MRS-vancomycin agar (anaerobic, 37°C, 72 h), or estimated by subtraction method	
		<i>L. rhamnosus</i> on MRS-vancomycin (anaerobic, 43°C, 72 h), subtracted from total counts of <i>L. casei</i> and <i>L. rhamnosus</i> on MRS-vancomycin agar (anaerobic, 37°C, 72 h)	
Propionibacteria		<i>L. acidophilus</i> on MRS-agar (anaerobic, 43°C, 72 h) or Basal agar-maltose agar (43°C, 72 h) or BA-sorbitol agar at (37°C, 72 h)	
		Bifidobacteria on MRS-NNLP agar (anaerobic, 37°C, 72 h)	
		Propionibacteria on sodium lactate agar (anaerobic, 30°C, 7–9 days) or subtraction — counts of lactic bacteria on sodium lactate agar (anaerobic, 30°C, 3 days), subtracted from counts of lactic bacteria and propionibacteria by 7 days	

(continued)

**Table 24.3 (continued) Examples of Identification and/or Enumeration Methods Available for Detection of *Bifidobacterium* and *Lactobacillus* Strains**

Species	Identification Method	Specifications	References
<i>Bifidobacterium</i> spp.	TPY-agar with 100 mg/mL mupirocin	High selectivity for <i>Bifidobacterium</i> sp. from dairy products	[60]
<i>B. adolescentis</i>	DP	DP based on Columbia agar, with dicloxacillin for inhibition of streptococci and lactococci, and with propionic acid to stimulate bifidobacterial growth	[33]
<i>B. animalis</i> subsp. <i>animalis</i>			
<i>B. bifidum</i> (except for LMG 11041T)	BFM	BFM antibiotic-free, with lactulose as main carbon source, and propionic acid, methylene blue, and lithium chloride as inhibitory agents	
<i>B. breve</i>	AMC	AMC based on commercially available Reinforced Clostridial Agar, with supplements (lithium chloride, sodium propionate, iodoacetate, 2,3,5-triphenyltetra-zolium) and antibiotics (nalidixic acid, polymyxin B sulfate, and kanamycin sulfate)	
<i>B. longum</i> biotype <i>infantis</i>	Modified Columbia agar		
<i>B. animalis</i> subsp. <i>Lactis</i>			
<i>B. longum</i> biotype <i>longum</i>			
<i>Bifidobacterium</i> spp.	Reinforced clostridial medium (RCM)	RCM chosen as best among several media for enumeration of isolated bifidobacteria	[25]

[25] confirmed that RCA was the best among several media for enumeration of isolated bifidobacteria. Specific inhibitors or supplements may in any case be used (in combination with other compounds)—to enhance selectivity for growth of bifidobacteria, and inhibit growth of lactic acid bacteria.

When in cocultures, differential enumeration of *L. acidophilus* and *Bifidobacterium* sp. usually resorts to differential plating protocols; MRS-maltose and NPNL agars were the media of choice by Lankaputhra and Shah [26] and Dave and Shah [11], respectively. However, two other formulated media, *viz.* “Bif” agar [68] and BLOG agar [29], apparently offer further advantages for selective enumeration of bifidobacteria in fermented dairy products: they are simpler to prepare, and the latter permits higher recovery of bifidobacteria from yogurt—which suggests a particular suitability for routine detection and enumeration of bifidobacteria in fermented dairy products that contain other lactic acid bacteria [69].

The International Dairy Federation (IDF) has recommended more than one culture medium for detection and enumeration of bifidobacteria [21,22]; in 1995 [23], it published the official method for enumeration of *L. acidophilus*, which recommended Bile-MRS agar and Trehalose-MRS agar to count *L. acidophilus* occurring in combination with yogurt bacteria and/or bifidobacteria (Table 24.3). Vinderola and Reinheimer [61,62] also elected Bile-MRS agar and Trehalose-MRS agar to selectively count *L. acidophilus* or *Lactobacillus casei*, and lithium propionate MRS to selectively count bifidobacteria when combined with other dairy starter cultures (including *L. casei*, because differential cell enumeration between both organisms was possible—see Table 24.3).

When evaluating 19 bacteriological media, Tharmaraj and Shah [57] proved that combination of selective media and incubation conditions (in terms of overhead atmosphere, temperature, and time) could selectively enumerate *Lactobacillus delbrueckii* ssp. *bulgaricus*, *Streptococcus thermophilus*, *L. casei*, *Lactobacillus rhamnosus*, *L. acidophilus*, bifidobacteria, and propionibacteria—directly, or resorting to subtracting methodologies (see Table 24.3).

More recently, Masco et al. [33] evaluated the efficacy of three media designed for a broad list of probiotic bacteria: dicloxacillin propionic acid medium (DP), *Bifidobacterium* medium (BFM), and Arroyo, Martin, and Cotton agar (AMC). The DP medium is based on Columbia agar—which is supplemented with dicloxacillin to inhibit the yogurt starter cultures, as well as the (sub)species *L. acidophilus* and *L. paracasei* subsp. *paracasei*; and with propionic acid, to stimulate bifidobacterial growth, *i.e.*, sustain growth of *Bifidobacterium animalis* subsp. *animalis*, *Bifidobacterium breve*, *B. animalis* subsp. *lactis* and *Bifidobacterium longum* biotype *longum* (however, it was not able to support growth of *Bifidobacterium adolescentis*, *B. bifidum*, and *B. longum* biotype *infantis*). BFM includes lactulose as the main carbon source, which allows growth of major bifidobacteria (except *B. bifidum* and *B. breve* strain LMG 11084)—and possesses propionic acid, methylene blue, and lithium chloride as inhibitory agents, to deliberately constrain growth of yogurt starter cultures and *L. acidophilus*. Finally, AMC is a reinforced clostridial basal agar added with supplements (*i.e.*, lithium chloride, sodium propionate, iodoacetate, and 2,3,5-triphenyltetrazolium) and antibiotics (nalidixic acid, polymyxin B sulfate, and kanamycin sulfate), designed to support growth of all *Bifidobacterium* strains; however, it fails to inhibit growth of several of the most important nonbifidobacteria, such as *S. thermophilus*. The DP medium is relatively easy to prepare—which makes it particularly suitable for routine enumeration of bifidobacteria in probiotic products. However, to guarantee isolation of the entire taxonomic range of currently used probiotic bifidobacteria, use of a second, complementary medium is unavoidable.

On the other hand, enumeration of probiotic yeasts in dairy products is easily done with YM agar, incubated aerobically at 25°C for 5 days [30,31].

### 24.4.2 Fluorescence Methods of Quantification

Besides the traditional methods of enumeration (as discussed earlier) and molecular biology techniques (presented in the following text), fluorescence methods have been frequently applied to quantify probiotic bacteria. As advantages, these methods circumvent the need of screening for optimal growth (as it is often not feasible to test all potential growth media) and reduce the underestimation of viable bacteria that occurs with conventional plate count methods. In certain probiotic products and dairy starter cultures, dormant populations may exist—*viz.* bile acid-stressed bifidobacteria or probiotic bacteria subject to prolonged storage; these dormant bacteria are unable to grow on conventional growth media, but may be assessed as viable using cytological viability assays.

Fluorescent stains can be applied to detect viable, damaged, and even dead bacterial cells in a sample; detection is via fluorescence microscopy, fluorometry, or flow cytometry, which also allow rapid enumeration of cells [13]. Fluorescent techniques usually involve two steps—first staining of viable cells with one dye, followed by counterstaining of dead (or all) cells with another stain, in order to obtain the total cell number [5].

Fluorescent probes for viability assessment of lactic acid bacteria include: nucleic acid probes—e.g., propidium iodide (PI), TOTO-1 (which is excluded by intact cells), SYTO9, and DAPI (which stains both viable and nonviable cells); and physiological indicators—e.g., 2,7-bis-(2-carboxyethyl)-5-(and-6)carboxyfluorescein (BCECF), carboxyfluorescein diacetate (CFDA), *N*-(fluorescein thio-ureanyl)-glutamate (FTUG), and bisoxonol (BOX) [35].

Quantification of strains of *B. longum* and *B. lactis* by plate counts was compared by Lahtinen et al. [25] with fluorescent *in situ* hybridization (FISH) and commercial LIVE/DEADs BacLight. In the latter case, the fermented product was centrifuged at 800×*g* at 4°C for 7 min, and the less turbid upper fraction (containing bacterial cells) was duly stained; green fluorescence of the samples was then analyzed, using a 515 nm filter. In the FISH technique, probiotic products diluted in phosphate-buffered saline (PBS) were subsequently fixed in a 4% (v/v) *p*-formaldehyde solution overnight at 4°C, washed twice, and resuspended in 1 mL of PBS:ethanol (1:1, v/v). A portion of the cell suspension was hybridized overnight at 50°C, in hybridization buffer (10 mM Tris–HCl, 0.9 M NaCl) containing a Cy3 indocarbocyanin-labeled genus-specific probe BIF164 (5'-CATCCGGCATTACCACCC); total cell numbers were then determined using 40,6-diamidino-2-phenylindole (DAPI). Cells were washed with hybridization buffer, applied to a 0.2 mm polycarbonate filter and mounted on a glass slide.

The plate counts of *B. lactis* were slightly, yet significantly lower than LIVE/DEAD counts—thus suggesting that those cells which were not able to grow on plates may have become dormant [25]; conversely, the plate counts of *B. longum* were several log units lower than LIVE/DEAD counts—hence implying that a remarkable part of the cells were indeed dormant. FISH proved suitable for quantification of the total amount of probiotic bifidobacteria in foods. Maukonen et al. [35] investigated the suitability of fluorescent techniques for microbiological quality assessment of probiotic nondairy drinks and probiotic pharmaceutical products—using seven different fluorescent viability stains (including ChemChrome and also LIVE/DEAD BacLight), combined with epifluorescence microscopy and flow cytometry. The results obtained with fluorescent stains were mostly in agreement with those obtained via culturing; fluorescence techniques were good alternatives for rapid viability assessment of probiotic products. The fluorometry assay with BacLight appeared as fast and accurate when compared with other techniques and stains. Those authors also tested several commercial probiotic products using ChemChrome and LIVE/DEAD BacLight stains—and a summary of their results is tabulated in Table 24.4.

**Table 24.4 Stainability and Fluorescence Results Obtained in Commercial Probiotic Products Stained by ChemChrome and LIVE/DEAD BacLight Viability Kit, as Observed by Microscopy**

Product Name	Composition of the Product (According to Manufacturer)	Bacterial Strain (According to Manufacturer)	Stainability with LIVE/DEAD BacLight Viability Kit		Stainability with ChemChrome	
			Cells	Background	Cells	Background
<b>Probiotic drinks</b>						
Gefilus-1	Fruit juice with five different fruits <sup>a</sup>	<i>L. rhamnosus</i> GG	Brightly fluorescing	Fluorescing particles (both red and green)	Brightly fluorescing but only a few cells	Weakly fluorescing
Gefilus-2	Apple-grape (dark grapes) juice	<i>L. rhamnosus</i> GG	Brightly fluorescing	No extra fluorescing particles	Brightly fluorescing	Weakly fluorescing
Proviva-3	Blueberry soup with oat	<i>L. plantarum</i> 299v	Cells clump	Fluorescing particles (both red and green)	Brightly fluorescing	Weakly fluorescing
Proviva-4	Raspberry soup with oat	<i>L. plantarum</i> 299v	Brightly fluorescing	Fluorescing particles (mainly red)	Brightly fluorescing	Weakly fluorescing
Rela-5	Fruit juice with fruits and carrot <sup>b</sup>	<i>L. reuteri</i>	Brightly fluorescing	Semi brightly fluorescing particles (mainly green)	Brightly fluorescing	Weakly fluorescing
	Supplemented with calcium and fiber		Brightly fluorescing	Fluorescing particles (mainly red)	Brightly fluorescing	Weakly fluorescing
Rela-6	Fruit juice with fruit and berries <sup>c</sup>	<i>L. reuteri</i>	Brightly fluorescing	Fluorescing particles (mainly red)	Brightly fluorescing	Weakly fluorescing
	Supplemented with calcium and fiber		Brightly fluorescing	Fluorescing particles (mainly red)	Brightly fluorescing	Weakly fluorescing

Source: Adapted from Maukonen, J. et al., *Food Res. Int.*, 39, 22, 2006.

<sup>a</sup> Contains orange, grape (green grapes), peach, mangos, and passion fruit juices.

<sup>b</sup> Contains orange, grape (green grapes), mango, and carrot juices.

<sup>c</sup> Contains apple, grape (dark grapes), raspberry, and elderberry juices.



Ammor et al. [1] proposed a novel method for identification of bifidobacteria species from the human gastrointestinal tract, based on measurement and statistical analysis of the intrinsic fluorescence of aromatic amino acids and nucleic acids—following excitation at 250 nm. The model was built via recording the fluorescence spectra of 53 *Bifidobacterium* strains of 10 different species—including the corresponding type strains, and validated by analyzing the spectra from nine further problem strains. The technique allowed resolution between isolates at the species level—and was accordingly considered as powerful, inexpensive, and convenient for rapid identification of intestinal bifidobacteria (especially within large probiotic surveys).

### 24.4.3 *Enzymatic Methods of Identification*

Several combinations of tests and ready-to-inoculate identification kits—such as API 50 CH, LRA Zym, and API Zym enzymatic tests, can be taken advantage of for rapid and (theoretically) reproducible phenotypic identification of pure cultures. They have been used in characterization and identification of lactobacilli in milk, yogurt, and other fermented milks, as well as in cheeses [8].

However, the reliability of the aforementioned tests has been questioned—especially in the case of API 50 CH, which was initially developed for identification of medical strains of the *Lactobacillus* genus. Further studies have shown that enzymatic tests are essentially accurate, in spite of their limitations; e.g., species-specific PCR techniques applied to the identification of isolated strains of *Bifidobacterium* from fecal samples of elderly subjects led to results similar to those obtained by enzymatic methods, with an agreement of 88.9% [71]. In this study, *Lactobacillus* strains were assessed by API 50 CHL, whereas their *Bifidobacterium* counterparts were characterized based on the enzymatic activity tested with Rapid ID 32 A combined with API 50 CH: the API CH 50 strip was inoculated with a medium based on that formulated by Hartemink [19], but deprived of agar and sodium thioglycollate—and with 0.17 g/L of bromocresol purple. The biochemical profiles produced by the *Bifidobacterium* strains were identified using a database available on the web (<http://kounou.lille.inra.fr/bifidAppl.html>).

In their attempt to characterize dairy-related *Bifidobacterium* spp., Roy et al. [42] proposed detection of  $\beta$ -galactosidase by electrophoresis as an effective tool to distinguish between dairy and nondairy bifidobacteria. The latter (i.e., *B. bifidum*, *B. breve*, *B. infantis*, *B. longum*, and *B. animalis*) could be better differentiated from other bifidobacteria via comparison of their  $\beta$ -galactosidase electrophoretic patterns than by numerical analysis of their phenotypic characteristics.

### 24.4.4 *Molecular Biology Methods of Identification*

Probiotic capacities are strain-dependent, so methods for reliable identification of probiotic bacteria at the strain level are of great importance, especially for quality control of approved strains—to prevent health risks and misleading claims, as well as to describe new strains. Nowadays, the main focus of identification efforts has turned from phenotypic to genotypic methods, because of the higher sensitivities and accuracy of the latter—*viz.* for lactic acid bacteria at large [33]; they consequently constitute a complementary approach in quality control of probiotic products [54,55], mainly because of the availability of online genomic sequence databases (and good exchangeability of generated data). These methods are based on use of synthetic 16S and 23S rRNA-targeted hybridization probes, and may not require cultivation. The specificity of the probe can be adjusted to fit any taxonomic ranking, from genus to genotype—and to detect, enumerate, and identify *in situ*, or after differential plating [72].

The aforementioned methods may be used in two basic ways: first, to determine the species to which a probiotic bacterium belongs—via DNA/DNA hybridization, sequencing, PCR, ribotyping, and PCR-restriction fragment length polymorphism (PCR-RFLP); and second, to permit strain differentiation via such techniques as restriction enzyme analysis (REA), randomly amplified polymorphic DNA (RAPD), repeated sequence extragenic palindrom PCR (REP-PCR), amplified fragment length polymorphism (AFLP), amplified ribosomal DNA restriction analysis (ARDRA), plasmid profiling, and pulsed field gel electrophoresis (PFGE). However, identification can be done to a high degree of confidence only if correct validation of the method (or probes or primers, for that matter) has been previously checked using close genera, species, or strains [8].

#### 24.4.4.1 Culture-Dependent Techniques

In a general way, cultivation-dependent detection and identification of isolates takes advantage of selective media and extraction of total bacterial DNA from the probiotic food product, followed by repetitive DNA element sequence-based (rep-)PCR fingerprinting and PFGE of a selection of isolates [33].

##### 24.4.4.1.1 Isolation of DNA

The first step in molecular identification of probiotic bacteria is the isolation of DNA from pure cultures or food products. When performing real-time PCR in a quantitative manner, differences in DNA extraction efficiency (including cell lysis and DNA elution) of the method selected will obviously influence the results, as well as the conclusions drawn therefrom. There are several methods described in the literature; Klijn et al. [73] initially developed a method to isolate small amounts of DNA from a single colony, but more detailed procedures are required to isolate DNA from mixed microbial communities—such as those found in food products [74].

In a recent study, Masco et al. [75] reported on the performance of five DNA extraction methods—on the basis of measurements of optical density (OD) and performance in real-time PCR analysis. DNA preparations of sufficient purity ( $1.8 \leq OD_{260/280} \leq 2.2$ ) were only obtained using the modified Pitcher method [76] and the phenol chloroform method [77]. However, when performing real-time PCR analysis with genus-specific 16S rRNA gene and *recA* primers, only the melting curves associated with extracts obtained via the DNA modified Pitcher method indicated that a *Bifidobacterium*-specific product had been amplified. Consequently, the latter method was considered as the best choice for DNA extraction from pure cultures and probiotic products. Temmerman et al. [55] have similarly claimed the Pitcher method—with slight modifications regarding concentration of lysozyme and an additional step involving RNase at the end of the procedure, as the most suitable for total DNA extraction for (rep-)PCR. The quality of the DNA extracts is verified by spectrophotometric measurements at 260, 280, and 234 nm; the DNA is then diluted to a working concentration of 50 ng/μL. The integrity of the DNA may then be ascertained by electrophoresis on a 1% (w/v) agarose gel in 1× TAE (0.04 M Tris–acetate, 0.001 M EDTA) buffer, followed by visualization under ultraviolet light after staining with ethidium bromide.

Alternative DNA isolation procedures include solid-phase techniques and employment of microparticles. One example of the latter was provided by Horak et al. [78]; they developed micrometer-sized magnetic poly(glycidyl methacrylate) (PGMA) microspheres containing carboxyl groups, via dispersion polymerization in the presence of polyethyleneglycol-coated iron oxide, followed by hydrolysis with aqueous perchloric acid and oxidation with potassium

permanganate. These microspheres were able to reversibly adsorb DNA from crude cell lysates of various dairy products (e.g., buttermilk, cheese, and yogurt, as well as probiotic tablets) or from cell lyophilizates. The amount of DNA adsorbed on the surface of the microspheres was directly proportional to the concentration of surface carboxyl groups. The DNA of *Bifidobacterium* and *Lactobacillus* spp. in samples was identified by PCR amplification. Application of the described magnetic PGMA-based microspheres eliminated the influence of PCR inhibitors, in contrast to use of samples without DNA separation—for which no PCR products were obtained from dairy product cell lysates. When a said microparticle technique is successful, the phenol extraction step for DNA separation may be omitted. Finally, it should be noted that quantitative separation of the magnetic microspheres from the DNA eluates is a prerequisite for high PCR sensitivity.

#### 24.4.4.1.2 Polymerase Chain Reaction

PCR is a rapid, reliable, and sensitive method to amplify DNA fragments from a known sequence—using two primers, sequenced from the 16S and 23S rDNA regions of the gene (that specifically code for the V1 and V2 variable regions), to generate the PCR fragment. The primers developed from such variable regions are specific to the extent that bacteria are to be identified—at the genus, species, or subspecies level. These primers are commercially available from several biotechnology suppliers.

Various studies have been carried out by multiplex PCR—in which a few primers are added to a given sample, thus making it possible to detect several microorganisms or species at the same time. Multiplex PCR is thus easy to use and cost-effective—since a simple reaction setup permits bacterial identification at the genus and species levels; and because it also allows internal controls to be coamplified, hence generating reliable and reproducible PCR amplifications. It has thus been employed and used as a rapid, simple, and reliable method to detect probiotic *Lactobacillus* in fecal samples [48,79], but extension to analysis of commercial dairy products is apparent. More recently, Kwon et al. [80] developed a multiplex PCR primer set (Table 24.5) to identify seven probiotic *Lactobacillus* spp.—viz. *L. acidophilus*, *L. delbrueckii*, *L. casei*, *L. gasseri*, *L. plantarum*, *L. reuteri*, and *L. rhamnosus*.

The primer set, comprising seven specific and two conserved primers, was derived from the integrated sequences of 16S and 23S rRNA genes, and their rRNA intergenic spacer region pertaining to each species. It was able to identify those seven target species at one time, with 93.6% accuracy; this feature exceeds that associated with biochemical methods, and accordingly suggests that such a multiplex primer is an efficient and trustworthy tool for those *Lactobacillus* species. Likewise, the presence of *B. animalis* subsp. *lactis* in 13 commercial fermented milks, available in the Spanish market, was confirmed by multiplex PCR as well—in agreement with the labeling of bacterial strains as conveyed by their manufacturers. The genomic homogeneity of all strains used in probiotic dairy products was consistent with observations reported elsewhere [17,54,55].

RAPD is a PCR-based method, in which a pattern of amplicons is produced via simultaneous amplification of many chromosomal sequences, mediated by annealing of short oligonucleotide primers. These primers are composed of random nucleotide sequences, and are not designed to match any specific sequence in the DNA of the target microorganism: however, by using a low annealing reaction temperature, binding will be promoted, and amplification will consequently be mediated. Although highly sensitive, this method is quite susceptible to interferences—e.g., variability in laboratory or reaction conditions [65]; previous tuning is thus required to obtain reproducible results. Nevertheless, RAPD has been selected by several workers for differentiation

**Table 24.5 Multiplex PCR Primers Used to Identify Probiotic *Lactobacillus* Species**

<i>Lactobacillus</i> Species	Primer	Sequence	Fragment Length (bp)
All <i>Lactobacillus</i>	IDL03R	CCACCTTCCTCCGGTTTGTC	—
All <i>Lactobacillus</i>	IDL04F	AGGGTGAAGTCGTAACAAGTAGCC	—
<i>L. casei</i> -group <sup>a</sup>	IDL11F	TGGTCGGCAGAGTAACTGTTGTCG	727
<i>L. acidophilus</i>	IDL22R	AACTATCGCTTACGCTACCACTTTC	606
<i>L. delbrueckii</i>	IDL31F	CTGTGCTACACCTAGAGATAGGTGG	184
<i>L. gasseri</i>	IDL42R	ATTTCAAGTTGAGTCTCTCTCTC	272
<i>L. reuteri</i>	IDL52F	ACCTGATTGACGATGGATCACCAGT	1105
<i>L. plantarum</i>	IDL62R	CTAGTGGTAAACAGTTGATTAACACTGC	428
<i>L. rhamnosus</i>	IDL73R	GCCAACAAGCTATGTGTTTCGCTTGC	448

Source: Adapted from Kwon, H.S. et al., *FEMS Microbiol. Lett.*, 239, 267, 2004.

<sup>a</sup> *L. casei*-group includes all *L. casei*-related *Lactobacillus* species, viz. *L. casei* and *L. rhamnosus*.

within *Lactobacillus* spp. [41,81], and has also been useful for rapidly differentiating and monitoring added probiotic strains in cheese [49] and yogurt [81].

Another technique that combines high taxonomic resolution (at the subspecies level) with acceptable reproducibility and low workload (and which also allows dereplication of the set of isolates) is REP-PCR. It is based on use of outwardly facing oligonucleotide PCR primers, complementary to interspersed repetitive sequences, which enable amplification of the differently sized DNA fragments lying between those elements. Examples of evolutionary conserved repetitive sequences are BOX, ERIC, REP, and (GTG)<sub>5</sub>; combined REP and ERIC fingerprints possess the advantage, over RAPD analysis, that the sequences considered are longer—and are, therefore, less sensitive to minor changes in reaction conditions. Hyytiä-Trees et al. [82] concluded that REP-PCR has a discriminating power similar to that of RAPD analysis, but weaker than that of PFGE. However, if the results of REP-PCR and RAPD analyses were combined, the discriminating power would (at least in some cases) be similar to that of PFGE; such an approach has led to the taxonomic alteration of *B. lactis* to *B. animalis* subsp. *lactis* [34]. Several primers and repetitive sequenced-based oligonucleotide primers can be used for REP-PCR, depending on the group of microorganisms and the desired degree of taxonomic resolution [55]. For all such assays, a universal PCR reaction mix can be used, in which the primer is interchangeable; annealing temperatures will vary according to the primer, from 40 (e.g., GTG5, REP1R, and REP2I) to 52°C (e.g., ERIC1R, ERIC2, and BOXA1R).

Another method applied for differentiation between strains is ARDRA—which involves amplification of 16S rDNA region, 16S–23S rDNA spacer region, or 23S rDNA, followed by digestion with one or more selected restriction enzymes; it thus has a potential to discriminate bacteria to the species level. Such a technique has been successfully applied in identification of *Lactobacillus* spp. [67] and *Bifidobacterium* spp. [83] used as starter and probiotic cultures; in the latter case, the procedure proposed was based on digestion of the PCR amplicon, amplified by PbiF1/PbiR2 primers [84], using a suitable set of six restrictases.

On the other hand, combination of techniques is a growing common trend; it has been claimed that *Lactobacillus*, *Streptococcus*, and *Bifidobacterium* species in dairy products can be identified to the genus level by ARDRA of the 16S rDNA gene, using the same PCR reaction and one *MwoI* restriction enzyme (distinctive profiles for each genus were indeed obtained); and that, upon combination with the RAPD technique, one could go one step further and eventually discriminate these bacteria to the strain level. Due to their rapidity, reliability, and level of differentiation, those authors recommended ARDRA and RAPD for routine use in combination with each other—as potentially valuable techniques for rapid and accurate identification, and differentiation of strains commonly used as probiotics in commercial dairy products.

PFGE encompasses restriction enzyme-mediated digestion, yet the enzymes specifically used for PFGE must have a low cutting frequency—as is the case of *SmaI* and *SgrAI*; these act at uncommon DNA sequences, and thus produce large restriction fragments that can be several hundred kilobases in length, which are resolved by PFGE. This technique—involving application of an alternating electric field in two defined directions, is used to separate very large fragments (from  $5 \times 10^4$  to  $2 \times 10^6$  bp). PFGE is highly discriminatory and reproducible, and generates a banding pattern that is easy to interpret; therefore, with two or three appropriate enzymes, it can be used as such toward reliable strain typing. A major drawback of this method is the limited number of samples that can be analyzed at one time. In terms of practical applications, Roy et al. [43] differentiated commercially available bifidobacterial strains by PFGE; Prasad et al. [85] and Weiss et al. [65] have also used it to determine the identity of *Lactobacillus* and *Bifidobacterium* strains bearing probiotic properties. Masco et al. [33] revealed a relatively high degree of genomic homogeneity among *Bifidobacterium* strains currently used in the probiotic food industry (*viz.* *B. animalis* subsp. *lactis* and *B. longum*) via PFGE as well.

#### 24.4.4.2 Culture-Independent Techniques

Although reliable in terms of discriminating capacity, culture-dependent approaches reveal several intrinsic limitations in terms of rapidity and reproducibility; besides, the isolates recovered may not always be representative of the actual microbial profile of the product. Although certain food products actually are claimed to contain only dead bacteria (and thus exploit only the endogenous enzyme inventory that has eventually been released upon lysis), methodologies are urged that can detect both viable and nonviable bacteria. Culture-independent methods constitute one such option: they involve extraction of nucleic acids (DNA or RNA) from probiotic products, followed by selective amplification of a specific part of the bacterial 16S rRNA gene and separation of the resulting amplicons by denaturing gradient gel electrophoresis (DGGE), temperature-gradient gel electrophoresis (TGGE), or single-strand conformation polymorphism (SSCP). These techniques can give a picture of the populations present in a complex matrix, and so bypass the problems related to injured, as well as viable but noncultivable bacteria [8].

The aforementioned analysis is based on the sequence-specific separation of amplified 16S rDNA fragments: separation is based on the lower electrophoretic mobility of a partially melted double-stranded DNA molecule in polyacrylamide gels—containing a linear gradient of DNA denaturants, usually urea and formamide (DGGE), or subjected to a linear temperature gradient (TTGE). The melting of fragments proceeds in discrete melting domain stretches of base pairs, with identical melting temperature; once the domain characterized by the lowest melting temperature reaches its melting temperature ( $T_m$ ) in the denaturing or temperature-gradient gel, the nucleic acid molecule undergoes a transition from a helical to a partially melted structure—so its

migration stops. Optimal resolution then occurs when amplicons are not completely denatured, and when the region to be screened is in the lowest melting domain; this is achieved by adding a 30–40 bp GC-rich clamp to one of the PCR primers, which generates sequence variants of particular fragments that cease to migrate at different positions in the denaturing gradient—hence facilitating their effective separation by TGGE or DGGE.

For each type of application desired, the appropriate denaturing gradient has to be prepared in advance by mixing the required volumes of a 100% and a 0% denaturing acrylamide solution (the former is typically 40% formamide and 7 M urea); this yields the commonly used 35%–70% denaturing gel recommended for detection of all probiotic lactic acid bacteria, or the 55%–75% gradient gel recommended for detection of bifidobacteria. Temmerman et al. [55] described a powerful strategy for identification of lactic acid bacteria included in probiotic products by the DGGE method, and made accordingly several recommendations (besides listing all materials required).

At present, DGGE analysis is one of the most suitable and widely used methods to study complex bacterial communities in various environments. In less than 30 h, a given probiotic product can be analyzed so as to check for the microbial composition stated on its label—provided that a database is available [55]. Such a family of techniques have been employed in the evaluation of microbial diversity—particularly of lactobacilli in cheeses and in the gastrointestinal tract [70], and in the identification of *Lactobacillus* spp.

A comparative qualitative assessment of culture-dependent and -independent analyses of 58 probiotic products obtained worldwide—and claimed to contain *Bifidobacterium* strains (including 22 yogurts, 5 dairy fruit drinks, 28 food supplements, and 3 pharmaceutical preparations) was published by Masco et al. [33]. Three isolation media were evaluated for suitability toward quality analysis of such products, followed by picking of bifidobacterial colonies from the most suitable medium and identification by REP-PCR fingerprinting using the BOX primer. *Bifidobacterium animalis* subsp. *lactis* was the most frequently found, but strains belonging to *B. longum* biotypes *longum* and *infantis*, *B. bifidum*, and *B. breve* were recovered as well; by conventional cultivation, 70.7% of the products analyzed were found to contain culturable bifidobacteria. Parallel culture-independent analysis—which involved a nested-PCR step on the total bacterial DNA extracted directly from the product, followed by separation of the amplicons by DGGE and subsequent identification of species from the band patterns, permitted detection of members of the genus *Bifidobacterium* in 96.5% of the products tested. DGGE has thus proven a fast and reproducible culture-independent approach for taxonomical analysis of probiotic products; it also exhibited a greater detection potential than conventional culture-dependent analyses. Nevertheless, DGGE is unable to provide information on the metabolic status or strain diversity of the microorganisms incorporated—which thus makes cultivation necessary for reliable qualitative analyses.

## 24.5 Overall Critical Assessment of Analytical Methods

Workload involved and equipment required for identification of strains are important issues for food manufacturers, as well as supervising authorities; therefore, it is useful to know which analytical methods can be routinely performed in a laboratory, and which types (and at which frequency) have to be confirmed by reference laboratories. Reuter et al. [40] conveyed an overview of the cost factors and the precision of phenotypic and genotypic methods used at their laboratory for identification of probiotic cultures in foods (Table 24.6); they also provided the efficiencies of those methods, based on the normal capacity of a laboratory with only one technician.

**Table 24.6 Workload and Identity Precision of Methods of Identification of Probiotic Bacteria**

Method	Workload			Level of Identity		
	Investment Costs	Material Required	Time	Genus	Species	Strain
<b>Phenotypic</b>						
Biochemical	±	±	±	++	+	±
Morphological	–	–	–			
Physiological	±	±	±	++	+	±
SDS-PAGE: soluble cell proteins	+	+	+	++	++	+
<b>Genotypic</b>						
Plasmid demonstration	–	–	–	–	±	+
REA	±	±	±	+	+	+
RAPD-PCR (primers at random)	+	+	++	–	+	++
DNA–DNA hybridization	+	+	±/+	++	++	–
PFGE	++	++	++	+	+	++

Source: Adapted from Reuter, G. et al., M., *Food Res. Int.*, 35, 117, 2002.

Note: ++, very high; +, high; ±, moderate; –, low.

It should be noted that the choice of an identification methodology depends on the goal of the investigation presumed—*viz.* whether characterization of a specific strain within the species level is needed, or whether identification at the species or even at the genus level is sufficient.

## 24.6 Conclusions

The reliable and reproducible identification of probiotic cultures in dairy food samples is nowadays essential—and requires standardized and accurate procedures, for both the isolation and the identification steps. Further differentiation at the individual strain level is also important—in terms of product safety and integrity assessment, and of functionality upon product ingestion. Classical methods allow characterization of isolates at a first stage, preferably in routine testing of products. In questionable cases and for confirmation purposes, application of additional genotypic methods becomes necessary.

The ultimate goal associated with determination of strains of probiotic cultures via gene probes then remains the identification without prior cultivation of strains—based on direct DNA-based

detection of strains. Development and optimization of culture-independent techniques have significantly increased the sensitivity of quality control of probiotic strains in food products; nevertheless, reliable quantification, as well as distinction between dead and live bacteria remains difficult.

Finally, the selection of strains for use as probiotic cultures should be based on ecological and metabolic criteria, besides mere assessment of viability.

## References

1. Ammor, M. S., Delgado, S., Álvarez-Martín, P., Margolles, A., Mayo, B. 2007. Reagentless identification of human bifidobacteria by intrinsic fluorescence. *Journal of Microbiological Methods* 69, 100–106.
2. Arroyo, L., Cotton, L. N., Martin, J. H. 1994. AMC agar—A composite medium for selective enumeration of *Bifidobacterium longum*. *Cultured Dairy Products Journal* 30, 12–15.
3. Beerens, H. 1990. An elective and selective isolation medium for *Bifidobacterium* spp. *Letters in Applied Microbiology* 11, 155–157.
4. Boylston, T. D., Vinderola, C. G., Ghoddusi, H. B., Reinheimer, J. A. 2004. Incorporation of bifidobacteria into cheeses: Challenges and rewards. *International Dairy Journal* 14, 375–387.
5. Breeuwer, P., Abee, T. 2000. Assessment of viability of microorganisms employing fluorescence techniques. *International Journal of Food Microbiology* 55, 193–200.
6. Calicchia, M. L., Wang, C. I. E., Nomura, T., Yotsuzuka, F., Osata, D. W. 1993. Selective enumeration of *Bifidobacterium bifidum*, *Enterococcus faecium* and streptomycin-resistant *Lactobacillus acidophilus* from a mixed probiotic product. *Journal of Food Protection* 56, 954–957.
7. Chevalier, P., Roy, D., Savoie, L. 1991. X-alpha-Gal-based medium for simultaneous enumeration of bifidobacteria and lactic acid bacteria in milk. *Journal of Microbiological Methods* 13, 75–83.
8. Coeuret, V., Dubernet, S., Bernandean, M., Gueguen, M., Vernoux, J. P. 2003. Isolation, characterisation and identification of lactobacilli focusing mainly on cheeses and other dairy products. *Le Lait* 83, 269–306.
9. Collado, M. C., Moreno, Y., Cobo, J. M., Hernández, M. 2006. Microbiological evaluation and molecular characterization of bifidobacteria strains in commercial fermented milks. *European Food Research Technology* 222, 112–117.
10. Collado, M. C., Hernández, M. 2007. Identification and differentiation of *Lactobacillus*, *Streptococcus* and *Bifidobacterium* species in fermented milk products with bifidobacteria. *Microbiological Research* 162, 86–92.
11. Dave, R. I., Shah, N. P. 1996. Evaluation of media for selective enumeration of *Streptococcus thermophilus*, *Lactobacillus delbrueckii* ssp. *bulgaricus*, *Lactobacillus acidophilus*, and bifidobacteria. *Journal of Dairy Science* 79, 1529–1536.
12. FAO/WHO. 2002. Guidelines for the evaluation of probiotics in food. Food and Agriculture Organization of the United Nations and World Health Organization Working Group Report. FAO/WHO, Geneva, Switzerland.
13. Fondén, R., Saarela, M., Matto, J., Mattila-Sandholm, T. 2003. Lactic acid bacteria (LAB) in functional dairy products (Chapter 10). In *Functional Dairy Products* (Mattila-Sandholm, T., Saarela, M., eds.), pp. 244–257. Woodhead Publishing, Cambridge, UK/CRC Press, Boca Raton, USA.
14. Gomes, A. M., Malcata, F. X. 1998. Development of probiotic cheese manufactured from goat milk: Response surface analysis via technological manipulation. *Journal of Dairy Science* 81, 1492–1507.
15. Gomes, A. M. P., Malcata, F. X. 1999. *Bifidobacterium* spp. and *Lactobacillus acidophilus*: Biological, biochemical, technological and therapeutical properties relevant for use as probiotics. *Trends in Food Science and Technology* 10, 139–157.



16. Gomes, A. M. P., Malcata, F. X., Klaver, F. A. M., Grande, H. J. 1995. Incorporation and survival of *Bifidobacterium* sp. strain Bo and *Lactobacillus acidophilus* strain Ki in a cheese product. *Netherlands Milk and Dairy Journal* 49, 71–95.
17. Gueimonde, M., Delgado, S., Mayo, B., Ruas-Madiedo, P., Margolles, A., de los Reyes-Gavilán, C. G. 2004. Viability and diversity of probiotic *Lactobacillus* and *Bifidobacterium* populations included in commercial fermented milks. *Food Research International* 37, 839–914.
18. Hamilton-Miller, J. M. T., Shah, S., Winkler, J. T. 1999. Public health issues arising from microbiological and labelling quality of foods and supplements containing probiotic microorganisms. *Public Health Nutrition* 2, 223–229.
19. Hartemink, R. 1999. *Prebiotic Effects of Non-Digestible Oligo and Polysaccharides*. Ponsen & Looijen, Wageningen.
20. Huys, G., Vancanneyt, M., d'Haene, K., Vankerckhoven, V., Goossen, H., Swings, J. 2006. Accuracy of species identity of commercial bacterial cultures intended for probiotic or nutritional use. *Research in Microbiology* 157, 803–810.
21. IDF. 1990. Culture media for detection and enumeration of bifidobacteria in fermented milk products. *Bulletin of the International Dairy Federation No. 252*. IDF Brussels, Belgium.
22. IDF. 1992. New technologies for fermented dairy products. *Bulletin of the International Dairy Federation No. 277*. IDF, Brussels, Belgium.
23. IDF. 1995. Detection and enumeration of *Lactobacillus acidophilus*. *Bulletin of the International Dairy Federation No. 306*. IDF, Brussels, Belgium.
24. Kneifel, W., Pacher, B. 1993. An X-Glu base agar medium for the selective enumeration of *Lactobacillus acidophilus* in yoghurt-related milk products. *International Dairy Journal* 3, 277–291.
25. Lahtinen, S. J., Gueimonde, M., Ouwehand, A. C., Reinikainen, J. P., Salminen, S. J. 2006. Comparison of four methods to enumerate probiotic bifidobacteria in a fermented food product. *Food Microbiology* 23, 571–577.
26. Lankaputhra, W. E. V., Shah, N. P. 1996. A simple method for selective enumeration of *Lactobacillus acidophilus* in yoghurt supplemented with *L. acidophilus* and *Bifidobacterium* spp. *Milchwissenschaft* 51, 446–451.
27. Lapierre, L., Undeland, P., Cox, L. J. 1992. Lithium chloride-sodium propionate agar for the enumeration of bifidobacteria in fermented dairy products. *Journal of Dairy Science* 75, 1192–1196.
28. Laroia, S., Martin, J. H. 1991. Effect of pH on survival of *Bifidobacterium bifidum* and *Lactobacillus acidophilus* in frozen fermented dairy desserts. *Cultured Dairy Products Journal* 26, 13–21.
29. Lim, K. S., Huh, C. S., Baek, Y. J., Kim, H. U. 1995. A selective enumeration medium for bifidobacteria in fermented dairy products. *Journal of Dairy Science* 78, 2108–2112.
30. Lourens-Hattingh, A., Viljoen, B. C. 2001a. Yoghurt as probiotic carrier food. *International Dairy Journal* 11, 1–17.
31. Lourens-Hattingh, A., Viljoen, B. C. 2001b. Growth and survival of a probiotic yeast. *Food Research International* 34, 791–796.
32. Madureira, A. R., Pereira, C. I., Truszkowska, K., Gomes, A. M., Pintado, M. E., Malcata, F. X. 2005. Survival of probiotic bacteria in a whey cheese vector submitted to environmental conditions prevailing in the gastrointestinal tract. *International Dairy Journal* 15, 921–927.
33. Masco, L., Huys, T. G., de Brandt, E., Temmerman, R., Swings, J. 2005. Culture-dependent and culture-independent qualitative analysis. *International Journal of Food Microbiology* 102, 221–230.
34. Masco, L., Ventura, M., Zink, R., Huys, G., Swings, J. 2004. Polyphasic taxonomic analysis of *Bifidobacterium animalis* and *Bifidobacterium lactis* reveals relatedness at the subspecies level: Reclassification of *Bifidobacterium animalis* as *Bifidobacterium animalis* subsp. *animalis* subsp. nov. and *Bifidobacterium lactis* as *Bifidobacterium animalis* subsp. *lactis* subsp. nov. *International Journal of Systematic and Evolutionary Microbiology* 54, 1137–1143.
35. Maukonen, J., Alakomi, H.-L., Nohynek, L., Hallamaa, K., Leppämäki, S., Mättö, J., Saarela, M. 2006. Suitability of the fluorescent techniques for the enumeration of probiotic bacteria in commercial non-dairy drinks and in pharmaceutical products. *Food Research International* 39, 22–32.

36. McCann, T., Egan, T., Weber, G. H. 1996. Assay procedures for commercial probiotic cultures. *Journal of Food Protection* 59, 41–45.
37. Morelli, L. 2007. *In vitro* assessment of probiotic bacteria: From survival to functionality. *International Dairy Journal* 17, 1278–1283.
38. Pimentel, L. L., Semedo, T., Tenreiro, R., Crespo, M. T. B., Pintado, M. M., Malcata, F. X. 2007. Assessment of safety of enterococci isolated throughout traditional Terrincho cheesemaking: Virulence factors and antibiotic susceptibility. *Journal of Food Protection* 70, 2161–2167.
39. Rasic, J. L. and Kurmann, J. A. 1983. *Bifidobacteria and their Role*. Birkhäuser-Verlag-Basel, Basel, Switzerland.
40. Reuter, G., Klein, G., Goldberg, M. 2002. Identification of probiotic cultures in food samples. *Food Research International* 35, 117–124.
41. Roy, D., Ward, P., Vincent, D., Mondou, F. 2000. Molecular identification of potentially probiotic lactobacilli. *Current Microbiology* 40, 40–46.
42. Roy, D., Berger, J. L., Reuter, G. 1994. Characterization of dairy-related *Bifidobacterium* spp. based on their  $\beta$ -galactosidase electrophoretic patterns. *International Journal of Food Microbiology* 23, 55–70.
43. Roy, D., Ward, P., Champagne, G. 1996. Differentiation of bifidobacteria by use of pulsed-field gel electrophoresis and polymerase chain reaction. *International Journal of Food Microbiology* 29, 11–29.
44. Rybka, S., Kailasapathy, K. 1996. Media for the enumeration of yoghurt bacteria. *International Dairy Journal* 6, 839–850.
45. Saarela, M., Mogensen, G., Fonden, G., Mättö, J., Mattila-Sandholm, T. 2000. Probiotic bacteria: Safety, functional and technological properties. *Journal of Biotechnology* 84, 197–215.
46. Shah, N. P. 2000. Probiotic bacteria: Selective enumeration and survival in dairy foods. *Journal of Dairy Science* 83, 894–907.
47. Shah, N. P. 2007. Functional cultures and health benefits. *International Dairy Journal* 17, 1262–1277.
48. Song, Y., Kato, N., Liu, C., Matsumiya, Y., Kato, H., Watanabe, K. 2000. Rapid identification of 11 human intestinal *Lactobacillus* species by multiplex PCR assays using group and species-specific primers derived from the 16S-23S rRNA intergenic spacer region and its flanking 23S rRNA. *FEMS Microbiology Letters* 187, 167–173.
49. Sozzi, T., Brigidi, P., Mignot, O., Matteuzzi, D. 1990. Use of dicloxacillin for the isolation and counting of *Bifidobacterium* from dairy products. *Le Lait* 70, 357–361.
50. Stanton, C., Ross, R. P., Fitzgerald, G., Collins, K., McBrearty, S., Gardiner, G., Desmond, C., et al., 2001. *Application of Probiotic Bacteria to Functional Foods*. Teagasc Report. MoorePark, Ireland.
51. Stanton, C., Desmond, C., Coakley, M., Collins, J. K., Fitzgerald, G., Ross, R. P. 2003. Challenges facing development of probiotic-containing functional foods. In *Handbook of Fermented Functional Foods* (Farnworth, E. R., ed.). pp. 27–58. CRC Press, Boca Raton, FL.
52. Tamime, A. Y., Marshall, V. M., Robinson, R. K. 1995. Microbiological and technological aspects of milks fermented by bifidobacteria. *Journal of Dairy Science* 62–151.
53. Temmerman, R., Masco, L., Vanhoutte, T., Huys, G., Swings, J. 2003a. Development and validation of a nested-PCR-denaturing gradient gel electrophoresis method for taxonomic characterization of bifidobacterial communities. *Applied and Environmental Microbiology* 69, 6380–6385.
54. Temmerman, R., Scheirlinck, I., Huys, G., Swings, J. 2003b. Culture-independent analysis of probiotic products by denaturing gradient gel electrophoresis. *Applied and Environmental Microbiology* 69, 220–226.
55. Temmerman, R., Masco, L., Huys, G., Swings, J. 2006. Application of repetitive element sequence-based (rep-) PCR and denaturing gradient gel electrophoresis for the identification of lactic acid bacteria in probiotic products. In *Probiotics in Food Safety and Human Health* (Goktepe, I., Juneja, V. K., Ahmedna, M., eds.). pp. 207–228. Taylor & Francis/CRC Press, Boca Raton, FL.
56. Teraguchi, S., Uehara, M., Ogasa, K., Mitsuoka, T. 1978. Enumeration of bifidobacteria in dairy products. *Japanese Journal of Bacteriology* 33, 753–761.

57. Tharmaraj, N., Shah, N. P. 2003. Selective enumeration of *Lactobacillus delbrueckii* ssp. *bulgaricus*, *Streptococcus thermophilus*, *Lactobacillus acidophilus*, Bifidobacteria, *Lactobacillus casei*, *Lactobacillus rhamnosus*, and Propionibacteria. *Journal of Dairy Science* 86, 2288–2296.
58. Vasiljevic, T., Shah, N. P. 2008. Probiotics - from Metchnikoff to bioactives. *International Dairy Journal* 18, 714–728.
59. Ventura, M., Meylan, V., Zink, R. 2003. Identification and tracing of *Bifidobacterium* species by use of enterobacterial repetitive intergenic consensus sequences. *Applied and Environmental Microbiology* 69, 4296–4301.
60. Viková, E., Rada, V., Trojanová, I. 2004. Enumeration, isolation and identification of bifidobacteria from dairy products. *Acta Agriculturae Slovenica* 84, 31–36.
61. Vinderola, C. G., Reinheimer, J. A. 1999. Culture media for the enumeration of *Bifidobacterium bifidum* and *Lactobacillus acidophilus* in the presence of yoghurt bacteria. *International Dairy Journal* 9, 497–505.
62. Vinderola, C. G., Reinheimer, J. A. 2000. Enumeration of *Lactobacillus casei* in the presence of *L. acidophilus*, bifidobacteria and lactic starter bacteria in fermented dairy products. *International Dairy Journal* 10, 271–275.
63. Vinderola, G., Capellini, B., Villarreal, F., Suárez, V., Quiberoni, A., Reinheimer, J. 2008. Usefulness of a set of simple *in vitro* tests for the screening and identification of probiotic candidate strains for dairy use. *LWT-Food Science and Technology* 1, 1–11.
64. von Hunger, W. 1986. Asculin-cellobiose-agar für die keimzahlbestimmung von *Lactobacillus acidophilus*. *Milchwissenschaft* 41, 283–285.
65. Weiss, A., Lettner, H. P., Kramer, W., Mayer, H. K., Kneifel, W. 2005. Identification of probiotic *Lactobacillus reuteri* strains. *Food Technology and Biotechnology* 43, 295–300.
66. Gurr, M. I. 2006. Nutritional aspects of fermented milk products. *FEMS Microbiology Letters* 46(3), 337–342.
67. Roy, D., Sirois, S., Vincent, D. 2001. Molecular discrimination of lactobacilli used as starter and probiotic cultures by amplified ribosomal DNA restriction analysis. *Current Microbiology* 42(4), 282–289.
68. Facher, B., Kneifel, W. 1996. Development of a culture medium for the detection and enumeration of bifidobacteria in fermented milk products. *International Dairy Journal* 6(1), 43–64.
69. Charteris, W. P., Kelly, P. M., Morelli, L., Collins, J. K. 1997. Selective detection, enumeration and identification of potentially probiotic *Lactobacillus* and *Bifidobacterium* species in mixed bacterial populations. *International Journal of Food Microbiology* 35(1), 1–27.
70. Walter, J., Tannock, G. W., Tilsala-Timisjarvi, A., Rodtong, S., Loach, D. M., Munro, K., Alatosava, T. 2000. Detection and identification of gastrointestinal *Lactobacillus* species by using denaturing gradient gel electrophoresis and species-specific PCR primers. *Applied and Environmental Microbiology* 66(1), 297–303.
71. Silvi, S., Verdenelli, M. C., Orpianesi, C., Cresci, A. 2003. EU project Crownalife: Functional foods, gut microflora and healthy ageing Isolation and identification of *Lactobacillus* and *Bifidobacterium* strains from faecal samples of elderly subjects for a possible probiotic use in functional foods. *Journal of Food Engineering* 56(2–3), 195–200.
72. Amann, R., Springer, N., Ludwig, W., Görtz, H. D., Schleifer, K.-H. 1991. Identification *in situ* and phylogeny of uncultured bacterial endosymbionts. *Nature* 351, 161–164.
73. Klijn, N., Weerkamp, A. H., de Vos, W. M. 1991. Identification of mesophilic lactic acid bacteria by using polymerase chain reaction-amplified variable regions of 16S rRNA and specific DNA probes. *Applied and Environmental Microbiology* 57(11), 3390–3393.
74. Kok, R. G., de Waal, A., Schut, F., Welling, G. W., Weenk, G., Hellingwerf, K. J. 1996. Specific detection and analysis of a probiotic *Bifidobacterium* strain in infant feces. *Applied and Environmental Microbiology* 62(10), 3668–3672.
75. Masco, L., Vanhoutte, T., Temmerman, R., Swings, J., Huys, G. 2007. Evaluation of real-time PCR targeting the 16S rRNA and *recA* genes for the enumeration of bifidobacteria in probiotic products. *International Journal of Food Microbiology* 113(3), 351–357.

76. Masco, L., Huys, G., de Brandt, E., Temmerman, R., Swings, J. 2005. Culture-dependent and culture-independent qualitative analysis of probiotic products claimed to contain bifidobacteria. *International Journal of Food Microbiology* 102(2), 221–230.
77. Gevers, D., Huys, G., Swings, J. 2001. Applicability of rep-PCR fingerprinting for identification of *Lactobacillus* species. *FEMS Microbiology Letters* 205, 31–36.
78. Horak, D., Petrovsky, E., Kapicka, A., Frederichs, T. 2007. Synthesis and characterization of magnetic poly(glycidyl methacrylate) microspheres. *Journal of Magnetism and Magnetic Materials* 311(2), April 2007, 500–506.
79. Luchini, F., Kmet, V., Cesena, C., Coppi, L., Bottazzi, V., Morelli, L. 2006. Specific detection of a probiotic *Lactobacillus* strain in faecal samples by using multiplex PCR. *FEMS Microbiology Letters* 158(2), 273–278.
80. Kwon, H. S., Yang, E. H., Yeon, S.-W., Kang, B.-H., Kim, T.-Y. 2004. Rapid identification of probiotic *Lactobacillus* species by multiplex PCR using species-specific primers based on the region extending from 16S rRNA through 23S rRNA. *FEMS Microbiology Letters* 239(2), 267–275.
81. Schillinger, U., Nuha, M. K., Yousif, N., Lilijana Sesar, L., Franz, C. 2003. Use of group-specific and RAPD-PCR analyses for rapid differentiation of *Lactobacillus* strains from probiotic yogurts. *Current Microbiology* 47(6), 453–456.
82. Hyttiä-Trees, E., Lyhs, U., Korkeala, H., Björkroth, J. 1999. Characterisation of ropy slime-producing *Lactobacillus sakei* using repetitive element sequence-based PCR. *International Journal of Food Microbiology* 50(3), 215–219.
83. Krizova, J., Spanova, A., Rittich, B. 2006. Evaluation of amplified ribosomal DNA restriction analysis (ARDRA) and species-specific PCR for identification of *Bifidobacterium* species. *Systematic and Applied Microbiology* 29(1), 36–44.
84. Roy, D., Siroisa, S. 2006. Molecular differentiation of *Bifidobacterium* species with amplified ribosomal DNA restriction analysis and alignment of short regions of the *ldh* gene. *FEMS Microbiology Letters* 191(1), 17–24.
85. Prasad, J., Gill, H., Smart, J., Gopal, P. K. 1998. Selection and characterisation of *Lactobacillus* and *Bifidobacterium* strains for use as probiotics. *International Dairy Journal* 8(12), 993–1002.



## *Chapter 25*

---

# **Determination of Water- and Fat-Soluble Vitamins in Infant Formulae**

---

Olivier Heudi

### **CONTENTS**

25.1	Introduction.....	531
25.2	Forms of Vitamins .....	532
25.2.1	Forms of Water-Soluble Vitamins .....	532
25.2.2	Forms of Fat-Soluble Vitamins.....	533
25.3	Vitamins Extraction and HPLC Quantification .....	533
25.3.1	Water-Soluble Vitamin Extraction and HPLC Quantification .....	533
25.3.2	Fat-Soluble Vitamin Extraction and HPLC Quantification .....	535
25.4	Multivitamin Methods.....	536
25.5	Optical Biosensor Methods.....	536
25.6	Liquid Chromatography–Mass Spectrometry Methods .....	537
25.7	Conclusions.....	537
	References.....	538

### **25.1 Introduction**

As generally known, vitamins are essential substances, which are necessary for normal health and growth. Lack of vitamins in babies' diet can cause serious diseases even though only a small amount is required to maintain good health. Infant formulae (IF), such as cow milk, soy milk,

and derived products, are the principal sources of vitamins for babies; thus vitamin content in these types of products should be sufficient to achieve an adequate intake. The fortification of IF generally performed with premixes, which contain high concentration of vitamins is to ensure the required amount of vitamins in the products and also to anticipate or correct for losses that may occur during food processing. Hence accurate measurement of vitamins is needed for the quality control of IF during production and storage to guarantee the amount of vitamins at the end of the product shelf life. Several forms of vitamins are found in IF with amount varying between low  $\mu\text{g}/100\text{ g}$  (i.e., vitamin B<sub>12</sub> or vitamin D) and high  $\text{mg}/100\text{ g}$  (i.e., vitamin C). In this respect, sample preparation is a crucial step to address during the method development prior to the quantification of vitamins in IF. During the last 10 years, high-performance liquid chromatography (HPLC) methods coupled to different detection techniques such as UV, fluorescence, or electrochemical have been mostly applied to the quantification of vitamins in IF. The present chapter summarizes the basic and recent information about the (1) forms of vitamins, (2) vitamins extraction and HPLC quantification, (3) multivitamin methods, (4) biosensors assay, and (5) liquid chromatography–mass spectrometry (LC–MS) methods.

This chapter presents IF as examples of analysis methods of vitamins in dairy products. The different methods discussed generally remain the same for most dairy products.

## 25.2 Forms of Vitamins

### 25.2.1 Forms of Water-Soluble Vitamins

“Vitamin C” occurs in the form of ascorbic acid (AA) and dihydroascorbic acid (DHAA). The D-isomer of AA, i.e., isoascorbic acid (IAA), is not found in natural products but may be present in the so-called vitamin C-enriched products, where it is added as an antioxidant [1]. “Vitamin B<sub>1</sub>” exists in the form of thiamine phosphate [2], mono- and pyrophosphate esters. “Vitamin B<sub>2</sub>” exists in different foods in the forms of flavin mononucleotide (FMN) and flavin adenine dinucleotide (FAD), or as a glycoside or bound to the amino acids histidine, cysteine, and tyrosine [3]. IF are fortified with riboflavin phosphate [2]. “Vitamin B<sub>3</sub>” (niacin) is mainly present in the pyridine nucleotides nicotinamide adenine dinucleotide and nicotinamide adenine dinucleotide phosphate [4]. In manufactured foods, these bound forms could be partially hydrolyzed into nicotinamide and nicotinic acid [4]. “Vitamin B<sub>5</sub>” is generally present in the bound coenzyme form (coenzyme A) or acyl carrier protein, but free pantothenic acid dominates in human IF [5,6]. Generally, IF are supplemented with free pantothenate, as calcium pantothenate, which is less hygroscopic than the acidic form that is more stable. “Vitamin B<sub>6</sub>” consists of several active vitamers, namely, pyridoxine (PN), pyridoxal (PL), and pyridoxamine (PM). In plant tissues, an often considerable percentage of pyridoxol may also be linked to sugars to form conjugate glucosides [7]. Naturally active forms of “Vitamin B<sub>8</sub>” (biotin) in foodstuffs are d-biotin and d-biocytyl. These two forms should therefore be determined in order to estimate the biotin nutritional potency of foods. The d-biotin and d-biocytyl occur in food not only in the free form but also covalently bound to proteins of the food matrix [8]. “Vitamin B<sub>9</sub>” (folic acid) consists of a group of pteric acid polyglutamate compounds with similar biological activity as folic acid. Folic acid is a synthetic pteric acid monoglutamate, not naturally occurring in food [9,10]. “Vitamin B<sub>12</sub>” includes not only cyanocobalamin, but also other cobalamins: hydroxocobalamin, methylcobalamin, and 5-deoxyadenosylcobalamin [11]. Because of its stability, cyanocobalamin is the form that is typically used for the fortification of IF [11].

## 25.2.2 Forms of Fat-Soluble Vitamins

*Vitamins A and E*—the fortification of IF is generally achieved with vitamin esters, such as retinol acetate, retinol palmitate, and  $\alpha$ -tocopherol acetate, as these molecules are more stable and less susceptible to oxidation. IF also contain tocopherols such as  $\alpha$ -,  $\beta$ -,  $\gamma$ -, and  $\delta$ -tocopherols and their corresponding tocotrienol originating from the oils used in their manufacture. The major form of vitamin E in IF is  $\alpha$ -tocopherol [12,13]. Vitamin D fortification of IF is often achieved with either vitamin D<sub>3</sub> or vitamin D<sub>2</sub>. *Vitamin K*—all members of the vitamin K group of vitamins share a methylated naphthoquinone ring structure, and vary in the aliphatic side chain. Phylloquinone (also known as vitamin K<sub>1</sub>) invariably contains in its side chain four isoprenoid residues, one of which is unsaturated. Menaquinones (also known as vitamin K<sub>2</sub>) have side chains composed of a variable number of unsaturated isoprenoid residues. Vitamin K<sub>2</sub> is normally produced by bacteria in the intestine, and dietary deficiency is extremely rare unless the intestine is heavily damaged or is unable to absorb the molecule.

## 25.3 Vitamins Extraction and HPLC Quantification

### 25.3.1 Water-Soluble Vitamin Extraction and HPLC Quantification

The sample preparation is mostly simpler and less tedious for water-soluble vitamins (WSV) in IF as only the free or the added form of vitamins which represents the majority amount of vitamins is determined. The sample preparation generally consists of a direct extraction in heated acidic or alkali buffers. Vitamin C (acid ascorbic) is often extracted into buffers that contain compounds such as metaphosphoric or trichloroacetic acid. It has been reported that these acids could coelute or interfere with AA or IAA and thus generate inconsistency in their retention times [14]. Reducing agents such as homocysteine and dithiothreitol (DTT) are frequently used to convert DHA into its reduced form and to stabilize AA [14,15]. Recently, it has been demonstrated that (tris(2-carboxyethyl) phosphine [TCEP]) offers a more efficient reduction of DHA at low pH compared to that of DTT [16]. HPLC with a different combination of pre- or postcolumn derivatization is used to quantify individually AA and DHA. These approaches require a derivatization step, which makes the method time consuming and degradation of AA can occur during the procedure [1,17]. The most frequently utilized HPLC methods are based on a separation on a reversed-phase column using ion-exchange or ion-pair procedure with electrochemical or UV detection [1,2,14]. However, in these approaches, no attempts have been made to assess DHA and to discriminate between AA and IAA, a vitamin C isomer with no biological activity, which is sometimes used for IF fortification. A recent work has described a HPLC method for the separation and quantification of AA and IAA acids in IF with the use decylamine as ion-pairing agent [18]. “Vitamins B<sub>1</sub> and B<sub>2</sub>” are often analyzed simultaneously as a common sample preparation can be applied to their extraction in IF. The extraction procedure for vitamins B<sub>1</sub> and B<sub>2</sub> consists of an autoclaving process in a dilute hydrochloric acid solution followed by a takadiastase digestion [19–21]. Vitamin B<sub>1</sub> and vitamin B<sub>2</sub> (naturally fluorescent) are detected by fluorescence after pre- or postcolumn derivatization of vitamin B<sub>1</sub> to thiochrome with potassium hexacyanoferrate in alkaline media [19,20]. Commonly applied HPLC methods utilize ion-exchange or ion-pairing chromatography and reversed-phase chromatography with acetonitrile/phosphate or methanol/phosphate buffers as the mobile phase. More recently, reversed-phased amide-based endcapped column (RP-amideC<sub>18</sub>) was used for the separation of vitamin B<sub>1</sub> and vitamin B<sub>2</sub> in IF [21]. There is growing interest to know the composition of flavin in foods. Several methods usually proposed



the conversion of these coenzymes into free riboflavin before quantification of total riboflavin. In a recent study, Vinas et al. [22] achieved the separation of vitamin B<sub>2</sub> and the two coenzymes, FMN and FAD, using reversed-phase amide C<sub>16</sub> LC-column with fluorescence detection (FLD). “Vitamin B<sub>3</sub>” in IF has been determined by several LC methods using either UV detection after precolumn cleanup [23]. However, these approaches lead to poor resolution of vitamin B<sub>3</sub> peak in food matrices, due to the low specificity and the insufficient sensitivity of the detection mode. Fluorimetric detection, requiring a pre- or postcolumn derivatization of vitamin B<sub>3</sub> (because this vitamin is not fluorescent), appears to be more attractive for the quantification of low amount of vitamin B<sub>3</sub> in food. A LC method with a FLD involving hydrochloric acid hydrolysis of the sample, prior to the precolumn conversion of different vitamers (NAD, NADP, nicotinamide, and nicotinic acid) into nicotinic acid and separation on a C<sub>18</sub> stationary phase, has been developed [4]. The proposed method leads to a good recovery rate (90%–107%) and a satisfactory reproducibility (coefficient of variation less than 4%). “Vitamin B<sub>5</sub>” lacks chromophore and its HPLC-UV determination is performed at wavelength below 220 nm. This poses a problem for the determination of vitamin B<sub>5</sub> by UV, as the available methods suffer from selectivity and are not applicable to all kind of IF. One method was proposed for the determination of vitamin B<sub>5</sub> by UV detection at 220 nm in IF after acidic deproteinization of the sample and direct analysis by reversed-phase HPLC at a low pH [6]. However this method was not suitable for hypoallergenic IF owing to interfering peaks from peptides [24]. A simple ion-pair LC-UV method was developed for determining vitamin B<sub>5</sub> content of fortified IF after extraction with 20 mM potassium phosphate solution by sonication [25]. The recovery of spiked samples was 83%–110% and the limit of detection (LoD) by LC was 0.5 mg/kg. For the determination of total vitamin B<sub>5</sub> in IF, a procedure which involves simultaneous action of alkaline phosphatase and pigeon liver pantetheinase and a FLD after a postcolumn derivatization of vitamin B<sub>5</sub> has been developed [26]. “Vitamin B<sub>6</sub>” can be extracted from foods by heating the sample or with acidic buffers containing trichloroacetic, perchloric, or chlorhydric acids. HPLC quantification of vitamin B<sub>6</sub> is based on the measurement of the sum of PN, PL, and PM after converting the phosphorylated and free vitamers into PN which was determined by ion-pair reversed-phase LC with FLD [27–29]. In other methods the vitamers PN, PL, PM, and their corresponding phosphorylated forms are separated for the total determination of vitamin B<sub>6</sub> [30,31]. Vinas et al. [7] determine six vitamin B<sub>6</sub>-related compounds, three B<sub>6</sub> vitamers and their corresponding phosphorylated esters. The method employs reversed-phase chromatography with an amide stationary phase and a phosphate buffer mobile phase. In addition, a postcolumn derivatization using sodium hydrogen sulfite was used to enhance the fluorescence of the phosphate esters. “Vitamin B<sub>8</sub>” is found at low concentration in most foods and the absence of a strong chromophore in the molecule limits its determination by LC with UV detection. Postcolumn derivatization of the carboxylic group of d-biotin by avidin-FITC or streptavidin and FLD has been proposed for the determination of d-biotin and d-biocytyl in IF [8]. The sample preparation of the method was performed either by using an enzymatic digestion with papain and taka-diastase or acidic hydrolysis with sulfuric acid followed by autoclaving at 120°C for 2 h. Recently, a method describing an acidic hydrolysis of the sample in 6% metaphosphoric acid solution followed by extraction on a C<sub>18</sub> solid phase extraction (SPE) cartridge and a postcolumn reaction with streptavidin-fluorescein isothiocyanate (FITC) has been developed for IF [32]. The fluorescent derivative was detected at 518 nm (with 495 nm excitation) and biotin was separated in 8.5 min on a reversed-phase column. “Vitamin B<sub>9</sub>” exists in food at a low concentration. The multiplicity and diversity of natural folates and their possible instability under light, heat, and/or oxygen complicate the HPLC-UV determination. In fact the analytical protocols usually include a trienzyme (conjugase, protease, and  $\alpha$ -amylase) treatment of the sample, a purification of the extract by

affinity chromatography, and a separation of the folates monoglutamates by reversed-phase HPLC [33–36]. In some studies, the addition of AA and mercaptoethanol to the extraction buffer noticeably improved the stability of tetrahydrofolate making it also possible to analyze some of the most labile folate vitamers [33,36]. Ndaw et al. [37] proposed a simple, rapid, and quantitative precolumn chemical conversion of all the folates into 5-methyltetrahydrofolate (5-CH<sub>3</sub>-H<sub>4</sub>PteGlu) with sodium borohydride. This was followed by LC and the detection was achieved by fluorescence as 5-CH<sub>3</sub>-H<sub>4</sub>PteGlu is very stable in acidic medium, and possesses the highest fluorescence quantum yield among the folate vitamers. “Vitamin B<sub>12</sub>” exists in food in different forms and at very low concentration. LC determination of Vitamin B<sub>12</sub> is rather difficult and consists of multiple steps in the sample preparation for the isolation of the stable vitamin B<sub>12</sub> form. Some publications have reported the determination of vitamin B<sub>12</sub> by reversed-phase HPLC using either isocratic or gradient elution [38,39]. In these methods, vitamin B<sub>12</sub> is extracted by autoclaving the food samples in sodium acetate buffer containing sodium cyanide. The later is generally used to convert vitamin B<sub>12</sub> forms into a cyanocobolamin which is the more stable form and also used for the IF fortification. The detection was performed by UV, which is not sensitive enough to detect low levels of vitamin B<sub>12</sub>, namely, in nonfortified food products. SPE technique as cleanup and concentrating procedures prior to the analysis of vitamin B<sub>12</sub> by LC–UV have also been investigated, but this approach was not applicable to food samples due to insufficient selectivity [40]. The capture of vitamin B<sub>12</sub> on immunoaffinity column prior to its LC analysis in infant food was described in two recent studies. In the first study [11], an enzymatic hydrolysis with pepsin was performed to release protein-bound vitamin B<sub>12</sub>, followed by its capture on immunoaffinity column and a precolumn conversion of vitamin B<sub>12</sub> into  $\alpha$ -ribazole, which can be detected by fluorescence. In the second study [41], vitamin B<sub>12</sub> was extracted from food products by heating in sodium acetate buffer (pH 4.0) containing sodium cyanide, followed by enzymatic treatment and purification on an immunoaffinity column prior to LC-separation and UV detection. The LoQ of the two methods were below 0.3  $\mu$ g/100 g, which made these two approaches suitable for the analysis of vitamin B<sub>12</sub> in all types of IF.

### 25.3.2 Fat-Soluble Vitamin Extraction and HPLC Quantification

A common sample preparation is generally applied to the extraction of fat-soluble vitamin (FSV) (vitamin A, vitamin D, and vitamin E) from food products prior to their analysis by HPLC coupled to UV, fluorescence, or electrochemical detections. Traditionally, FSV extraction is performed by alkaline saponification of the entire sample matrix [42]. Saponification converts the tocopherol and retinol acetate to tocopherol and retinol, respectively, and cannot be differentiated from the naturally occurring vitamins [12,13,23]. In addition, saponification is also used to remove the bulk of fat (triacylglycerides) and facilitate their extraction by releasing carotenoids, retinoids, tocopherols, and vitamin D compounds from the sample matrix [23,42]. To avoid vitamin losses or degradation during the saponification procedure, antioxidants such as butylated hydroxytoluene (BHT) or pyrogallol are added to the sample extraction media [12,13,43]. The saponification step is always followed by the liquid–liquid extraction step with organic solvents such as diisopropyl ether, chloroform, hexane, or their mixtures [23,42]. The detection of FSV after HPLC separation can be accomplished by UV, fluorescence, electrochemical, or evaporative light-scattering detection methods. The most commonly used detector for vitamins A and E analysis is FLD, which is considerably more sensitive and selective than UV. Vitamins A and E can be determined simultaneously in the same run using normal-phase HPLC separation with FLD. However in samples with high content of vitamin A, UV detection can be also used for

the quantification [42]. The introduction of shorter narrow-bore columns (i.e., 50 mm × 2.1 mm; 3 μm particle size) in place of traditional columns (250 mm and 150 mm × 4.6 mm; particle size 5 μm) offers several advantages such as less solvent consumption and higher mass sensitivity [44]. An increase in mass sensitivity can permit the use of diode array detector (DAD) for determining both vitamins A and E. Recently, the simultaneous determination of vitamins A and E by HPLC with UV detection was achieved in IF on a short narrow-bore column after a direct-extraction method [45]. The concentration of vitamin D<sub>3</sub> in IF is very low. The determination is performed by reversed-phase HPLC (with UV detection) after semipreparative HPLC which is used for the cleanup of the samples and the vitamin concentration [46]. The use of reversed-phase chromatography enables the baseline separation of vitamins D<sub>3</sub> and D<sub>2</sub>, which is usually used as the internal standard. This fact allows vitamin D<sub>2</sub> to be used as an internal standard for quantifying the corresponding D<sub>3</sub> form, and makes it possible to correct potential vitamin D<sub>3</sub> losses during the tedious sample treatment process and increase the method accuracy [46]. A disadvantage of RP-LC is that it does not allow the direct injection of nonpurified vitamin D<sub>3</sub> extract, because the interfering fat-soluble compounds can affect efficiency, peak shape, and reproducibility [47]. The determination of vitamin K<sub>1</sub> is not performed simultaneously with other FSV (A, D, and E) as a common sample preparation is not applicable to the extraction of these four vitamins. It has been found that vitamin K is unstable under the alkaline conditions used for the saponification of FSV [42]. Vitamin K<sub>1</sub> is commonly determined by HPLC, which combines lipase digestion and solvent extraction with FLD after a postcolumn reduction with zinc, without the necessity for additional purification strategies [48] or with a procedure using extraction solid-phase dispersion [49].

## 25.4 Multivitamin Methods

Multivitamin methods have been recently developed for the quantification of WSV in food products, especially in IF. With this approach, different samples preparation that involves protein precipitation with zinc acetate and phosphotungstate [50], perchloric acid [51], or trichloroacetic acid [38,52] followed by centrifugation were tested. Klejduš et al. [39] described a LC–UV method for the simultaneous determination of 10 WSV on a MetaChem Polaris C<sub>18</sub> column, using combined isocratic and linear gradient elution with a mobile phase consisting of 0.01% trifluoroacetic acid and methanol at the flow rate of 0.7 mL/min. The analysis time was about 10 min and the most suitable detection wavelength for simultaneous vitamin determination was 280 nm. Zafra-Gomez et al. [50] published a method for the isolation and simultaneous determination of the vitamin B<sub>1</sub>, vitamin B<sub>2</sub>, vitamin B<sub>3</sub>, vitamin B<sub>5</sub>, vitamin B<sub>6</sub>, vitamin B<sub>9</sub>, vitamin B<sub>12</sub>, and AA. In this method, the chromatographic separation was carried out on a C<sub>18</sub> column with ion-pair reagent and the vitamins were monitored at different wavelengths by either fluorescence or UV visible detection. Recently, the separation of nine WSV: vitamin B<sub>1</sub>, vitamin B<sub>2</sub>, vitamin B<sub>3</sub>, nicotinic acid, PN, PL, vitamin B<sub>9</sub>, and vitamin B<sub>12</sub> was achieved by reversed-phase technique without ion-pair formation using a new amide-based stationary phase with the endcapping of the trimethylsilyl group [21]. The detection was optimized using a photodiode array detector. For all these methods, the sample preparation combined multiple extraction steps involving acid protein precipitation, enzymatic digestion to release protein-bound sample, and centrifugation prior to the LC analysis.

## 25.5 Optical Biosensor Methods

A biosensor is an analytical device that combines the specificity of a biological interaction with a transducer that produces a signal proportional to the target analyte concentration. The biological

recognition element (e.g., antibodies, enzymes, receptors, and microbial cells) is in close contact with a signal transducer (e.g., optical, amperometric, potentiometric, and acoustic) coupled to a data acquisition and processing system. An overview of the operating principles of a biosensor assays and their application in vitamins analysis in food have been reviewed recently [25,53]. Biacore AB, formerly Pharmacia Biosensor AB, was the first company to commercially develop surface plasmon resonance (SPR)-technology in 1990. During the last few years, Biacore technology has been used in approximately 90% of all work published in the optical biosensor field. Biacore assays have been developed for vitamin B<sub>2</sub> [54], vitamin B<sub>5</sub> [55], vitamin B<sub>8</sub> [56], vitamin B<sub>9</sub> [56,57], and vitamin B<sub>12</sub> [58]. The assays are sufficiently sensitive to enable the determination of low level of vitamins in food products and the performance parameters of these methods are comparable to those of the official methods. Since sample preparation and analysis time is exceptionally short, the new test can significantly increase the sample throughput capability of analytical laboratories when compared to other current testing methods, such as microbiological assay (MBA) and HPLC. The speed and sensitivity of the new test compared to traditional methods are high due to the use of Biacore's SPR technology. The Qflex Kit supports an automated inhibition assay for concentration analysis specifically designed for use with Biacore SPR instruments.

## 25.6 Liquid Chromatography–Mass Spectrometry Methods

Nowadays, there is a growing need for more rapid and specific methods for vitamin analysis. The introduction of atmospheric pressure ionization technique greatly expanded the number of compounds and matrices that can be analyzed by LC–MS. LC coupled to MS applications gain increasing attention because of their specificity. The lack of protonation sites on FSV makes their analyses by LC–MS with electrospray ionization (ESI) difficult. Therefore, LC–MS with atmospheric pressure chemical ionization (APCI) appears to be a promising alternative method. This technique was applied to the quantification of Vitamin E [13] and vitamin D<sub>3</sub> [59] in milk products and most recently, method for the simultaneous quantification of vitamins A, D<sub>3</sub>, and E in IF was developed [12]. For the determination of WSV, LC–MS with ESI is more often used as these vitamins can be easily ionized in solution at various pH values. Previous studies have demonstrated that the LC–MS/MS provides sufficient sensitivity and selectivity for the determination of vitamin B<sub>5</sub> [24,60–63], vitamin B<sub>9</sub> [60,61,64,65], and vitamin B<sub>12</sub> [66]. However only single vitamin was analyzed. Recently, a validated ultraperformance LC–ESI–MS/MS method for the simultaneous determination of four WSV, including vitamin B<sub>5</sub>, vitamin B<sub>8</sub>, vitamin B<sub>9</sub>, and vitamin B<sub>12</sub> in fortified infant foods was developed [67]. The separation of the four vitamins was achieved within 6 min on a reversed-phase UPLC ACQUITY UPLC BEH C<sub>18</sub> column (2.1 mm × 100 mm i.d., 1.7 μm) with a gradient acetonitrile–water mobile phase.

## 25.7 Conclusions

Accurate determination of vitamins is very important in food area. Many developed HPLC-based methods using conventional detectors are sensitive enough for the determination of vitamins in IF. Because of the complexity of the infant food, the sample preparation used for the vitamins extraction can be quite tedious and time consuming. This is a major hurdle to the simultaneous determination of vitamins. The Biacore SPR technique offers high sensitivity and selectivity for the detection of vitamins, but only WSV have been analyzed with this assay. LC–MS/MS can offer an alternative, but the problems associated to this technique such as the lack of suitable

internal standard and strong matrix effect especially with the ESI detection still limit the use of the technique.

## References

1. Kall, M. A.; Andersen, C. Improved method for simultaneous determination of ascorbic acid and dehydroascorbic acid, isoascorbic acid and dehydroisoascorbic acid in food and biological samples. *J. Chromatogr. B* **1999**, *730*, 101–111.
2. Konings, E. J. M. Committee on food nutrition—water-soluble vitamins. *J. AOAC Int.* **2006**, *89*, 285–288.
3. Sharpless, K. E.; Margolis, S.; Thomas, J. B. Determination of vitamins in food-matrix standard reference materials. *J. Chromatogr. A* **2000**, *881*, 171–181.
4. Lahely, S.; Bergaentzle, M.; Hasselmann, C. Fluorimetric determination of niacin in foods by high-performance liquid chromatography with post-column derivatization. *Food Chem.* **1999**, *65*, 129–133.
5. Gonthier, A.; Fayol, V.; Viollet, J.; Hartmann, D. J. Determination of pantothenic acid in foods: Influence of the extraction method. *Food Chem.* **1998**, *63*, 287–294.
6. Woollard, D. C.; Indyk, H. E.; Christiansen, S. K. The analysis of pantothenic acid in milk and infant formulas by HPLC. *Food Chem.* **2000**, *69*, 201–208.
7. Vinas, P.; Balsalobre, N.; Lopez-Erroz, C.; Hernandez-Cordoba, M. Determination of vitamin B<sub>6</sub> compounds in foods using liquid chromatography with post-column derivatization fluorescence detection. *Chromatographia* **2004**, *59*, 381–386.
8. Lahely, S.; Ndaw, S.; Arella, F.; Hasselmann, C. Determination of biotin in foods by high-performance liquid chromatography with post-column derivatization and fluorimetric detection. *Food Chem.* **1999**, *65*, 253–258.
9. Jastrebova, J.; Witthoft, C.; Grahn, A.; Svensson, U.; Jagerstad, M. HPLC determination of folates in raw and processed beetroots. *Food Chem.* **2003**, *80*, 579–588.
10. Kall, M. A.; Norgaard, P.; Pedersen, S. J.; Leth, T. Optimised extraction of folic acid from multivitamin-mineral preparations for liquid chromatographic analysis. *J. Pharm. Biomed. Anal.* **2000**, *23*, 437–445.
11. Pakin, C.; Bergaentzle, M.; Aoude-Werner, D.; Hasselmann, C. alpha-Ribazole, a fluorescent marker for the liquid chromatographic determination of vitamin B<sub>12</sub> in foodstuffs. *J. Chromatogr. A* **2005**, *1081*, 182–189.
12. Heudi, O.; Trisconi, M. J.; Blake, C. J. Simultaneous quantification of vitamins A, D<sub>3</sub> and E in fortified infant formulae by liquid chromatography-mass spectrometry. *J. Chromatogr. A* **2004**, *1022*, 115–123.
13. Kalman, A.; Mujahid, C.; Mottier, P.; Heudi, O. Determination of alpha-tocopherol in infant foods by liquid chromatography combined with atmospheric pressure chemical ionisation mass spectrometry. *Rapid Commun. Mass Spectrom.* **2003**, *17*, 723–727.
14. Brause, A. R.; Woollard, D. C.; Indyk, R. E. Determination of total vitamin C in fruit juices and related products by liquid chromatography: Interlaboratory study. *J. AOAC Int.* **2003**, *86*, 367–374.
15. Behrens, W. A.; Madere, R. A highly sensitive high-performance liquid-chromatography method for the estimation of ascorbic and dehydroascorbic acid in tissues, biological-fluids, and foods. *Anal. Biochem.* **1987**, *165*, 102–107.
16. Lykkesfeldt, J. Determination of ascorbic acid and dehydroascorbic acid in biological samples by high-performance liquid chromatography using subtraction methods: Reliable reduction with tris[2-carboxyethyl] phosphine hydrochloride. *Anal. Biochem.* **2000**, *282*, 89–93.
17. Bogner, A.; Daood, H. G. Simple in line postcolumn oxidation and derivatization for the simultaneous analysis of ascorbic and dehydroascorbic acids in foods. *J. Chromatogr. Sci.* **2000**, *38*, 162–168.

18. Fontannaz, P.; Kilinc, T.; Heudi, O. HPLC-UV determination of total vitamin C in a wide range of fortified food products. *Food Chem.* **2006**, *94*, 626–631.
19. Arella, F.; Lahely, S.; Bourguignon, J. B.; Hasselmann, C. Liquid chromatographic determination of vitamins B<sub>1</sub> and B<sub>2</sub> in foods. A collaborative study. *Food Chem.* **1996**, *56*, 81–86.
20. Ollilainen, V.; Finglas, P. M.; van den Berg, H.; de Froidmont-Gortz, I. Certification of B-Group vitamins (B<sub>1</sub>, B<sub>2</sub>, B<sub>6</sub>, and B<sub>12</sub>) in four food reference materials. *J. Agric. Food. Chem.* **2001**, *49*, 315–321.
21. Vinas, P.; Lopez-Erroz, C.; Balsalobre, N.; Hernandez-Cordoba, M. Reversed-phase liquid chromatography on an amide stationary phase for the determination of the B group vitamins in baby foods. *J. Chromatogr. A* **2003**, *1007*, 77–84.
22. Vinas, P.; Balsalobre, N.; Lopez-Erroz, C.; Hernandez-Cordoba, M. Liquid chromatographic analysis of riboflavin vitamers in foods using fluorescence detection. *J. Agric. Food Chem.* **2004**, *52*, 1789–1794.
23. Ball, G. *Bioavailability and Analysis of Vitamins in Foods*. Chapman & Hall, London, 1998.
24. Mittermayr, R.; Kalman, A.; Trisconi, M. J.; Heudi, O. Determination of vitamin B<sub>5</sub> in a range of fortified food products by reversed-phase liquid chromatography-mass spectrometry with electrospray ionisation. *J. Chromatogr. A* **2004**, *1032*, 1–6.
25. Blake, C. J. Analytical procedures for water-soluble vitamins in foods and dietary supplements: A review. *Anal. Bioanal. Chem.* **2007**, *389*, 63–76.
26. Pakin, C.; Bergaentzle, M.; Hubscher, V.; Aoude-Werner, D.; Hasselmann, C. Fluorimetric determination of pantothenic acid in foods by liquid chromatography with post-column derivatization. *J. Chromatogr. A* **2004**, *1035*, 87–95.
27. Bergaentzle, M.; Arella, F.; Bourguignon, J. B.; Hasselmann, C. Determination of vitamin-B<sub>6</sub> in foods by HPLC—a collaborative study. *Food Chem.* **1995**, *52*, 81–86.
28. Mann, D. L.; Ware, G. M.; Bonnin, E.; Eitenmiller, R. R. Liquid chromatographic analysis of vitamin B<sub>6</sub> in reconstituted infant formula: Collaborative study. *J. AOAC. Int.* **2005**, *88*, 30–37.
29. Reitzer-Bergaentzle, M.; Marchioni, E.; Hasselmann, C. HPLC determination of vitamin-B<sub>6</sub> in foods after precolumn derivatization of free and phosphorylated vitamers into pyridoxol. *Food Chem.* **1993**, *48*, 321–324.
30. Bitsch, R.; Moller, J. Analysis of B<sub>6</sub> vitamers in foods using a modified high-performance liquid-chromatographic method. *J. Chromatogr.* **1989**, *463*, 207–211.
31. Bognar, A. Determination of vitamin-B<sub>6</sub> in food by using high-performance-liquid-chromatography (HPLC). *Z. Lebensm. Unters. Forsch.* **1985**, *181*, 200–205.
32. Thompson, L. B.; Schmitz, D. J.; Pan, S. J. Determination of biotin by high-performance liquid chromatography in infant formula, medical nutritional products, and vitamin premixes. *J. AOAC. Int.* **2006**, *89*, 1515–1518.
33. Finglas, P. M.; Wigertz, K.; Vahteristo, L.; Witthoft, C.; Southon, S.; de Froidmont-Gortz, I. Standardisation of HPLC techniques for the determination of naturally-occurring folates in food. *Food Chem.* **1999**, *64*, 245–255.
34. Pfeiffer, C. M.; Rogers, L. M.; Gregory, J. F. Determination of folate in cereal-grain food products using trienzyme extraction and combined affinity and reversed-phase liquid chromatography. *J. Agric. Food Chem.* **1997**, *45*, 407–413.
35. Ruggeri, S.; Vahteristo, L. T.; Aguzzi, A.; Finglas, P.; Carnovale, E. Determination of folate vitamers in food and in Italian reference diet by high-performance liquid chromatography. *J. Chromatogr. A* **1999**, *855*, 237–245.
36. Vahteristo, L. T.; Ollilainen, V.; Koivistoinen, P. E.; Varo, P. Improvements in the analysis of reduced folate monoglutamates and folic acid in food by high-performance liquid chromatography. *J. Agric. Food Chem.* **1996**, *44*, 477–482.
37. Ndaw, S.; Bergaentzle, M.; oude-Werner, D.; Lahely, S.; Hasselmann, C. Determination of folates in foods by high-performance liquid chromatography with fluorescence detection after precolumn conversion to 5-methyltetrahydrofolates. *J. Chromatogr. A* **2001**, *928*, 77–90.

38. Albala-Hurtado, S.; Veciana-Nogues, M.; Izquierdo-Pulido, M.; Marine-Font, A. Determination of water soluble vitamins in infant milk by high-performance liquid chromatography. *J. Chromatogr. A* **1997**, *778*, 247–253.
39. Klejdus, B.; Petrlova, J.; Potesil, D.; Adam, V.; Mikelova, R.; Vacek, J.; Kizek, R.; Kuban, V. Simultaneous determination of water- and fat-soluble vitamins in pharmaceutical preparations by high-performance liquid chromatography coupled with diode array detection. *Anal. Chim. Acta* **2004**, *520*, 57–67.
40. Iwase, H.; Ono, I. Determination of cyanocobalamin in foods by high-performance liquid chromatography with visible detection after solid-phase extraction and membrane filtration for the pre-column separation of lipophilic species. *J. Chromatogr. A* **1997**, *771*, 127–134.
41. Heudi, O.; Kilinc, T.; Fontannaz, P.; Marley, E. Determination of vitamin B<sub>12</sub> in food products and in premixes by reversed-phase high performance liquid chromatography and immunoaffinity extraction. *J. Chromatogr. A* **2006**, *1101*, 63–68.
42. Jedlicka, A.; Klimes, J. Determination of water- and fat-soluble vitamins in different matrices using high-performance liquid chromatography. *Chem. Pap.* **2005**, *59*, 202–222.
43. Oliver, J.; Palou, A. Chromatographic determination of carotenoids in foods. *J. Chromatogr. A* **2000**, *881*, 543–555.
44. Ye, L.; Landen, W. O.; Eitenmiller, R. R. Comparison of the column performance of narrow-bore and standard-bore columns for the chromatographic determination of alpha-, beta-, gamma-, and delta-tocopherol. *J. Chromatogr. Sci.* **2001**, *39*, 1–6.
45. Chavez-Servin, J. L.; Castellote, A. I.; Lopez-Sabater, M. C. Simultaneous analysis of vitamins A and E in infant milk-based formulae by normal-phase high-performance liquid chromatography-diode array detection using a short narrow-bore column. *J. Chromatogr. A* **2006**, *1122*, 138–143.
46. Perales, S.; Delgado, M. M.; Alegria, A.; Barbera, R.; Farre, R. Liquid chromatographic determination of Vitamin D<sub>3</sub> in infant formulas and fortified milk. *Anal. Chim. Acta* **2005**, *543*, 58–63.
47. Perales, S.; Alegria, A.; Barbera, R.; Farre, R. Review: Determination of vitamin D in dairy products by high performance liquid chromatography. *Food Sci. Technol. Int.* **2005**, *11*, 451–462.
48. Indyk, H. E.; Littlejohn, V. C.; Lawrence, R. J.; Woollard, D. C. Liquid-chromatographic determination of vitamin-K<sub>1</sub> in infant formulas and milk. *J. AOAC Int.* **1995**, *78*, 719–723.
49. Chase, G. W.; Eitenmiller, R. R.; Long, A. R. Liquid chromatographic analysis of vitamin K<sub>1</sub> in milk-based infant formula with matrix solid-phase dispersion. *J. AOAC Int.* **1999**, *82*, 1140–1145.
50. Zafra-Gomez, A.; Garballo, A.; Morales, J. C.; Garcia-Ayuso, L. E. Simultaneous determination of eight water-soluble vitamins in supplemented foods by liquid chromatography. *J. Agric. Food Chem.* **2006**, *54*, 4531–4536.
51. Chase, G. W.; Landen, W. O.; Eitenmiller, R. R.; Soliman, A. G. M. Liquid-chromatographic determination of thiamine, riboflavin, and pyridoxine in infant formula. *J. AOAC Int.* **1992**, *75*, 561–565.
52. Woollard, D. C.; Indyk, H. E. Rapid determination of thiamine, riboflavin, pyridoxine, and niacinamide in infant formulas by liquid chromatography. *J. AOAC Int.* **2002**, *85*, 945–951.
53. Kalman, A.; Caelen, I.; Svorc, J. Vitamin and pseudovitamin analysis with biosensors in food products—a review. *J. AOAC Int.* **2006**, *89*, 819–825.
54. Caelen, I.; Kalman, A.; Wahlstrom, L. Biosensor-based determination of riboflavin in milk samples. *Anal. Chem.* **2004**, *76*, 137–143.
55. Haughey, S. A.; O’Kane, A. A.; Baxter, G. A.; Kalman, A.; Trisconi, M. J.; Indyk, H. E.; Watene, G. A. Determination of pantothenic acid in foods by optical biosensor immunoassay. *J. AOAC Int.* **2005**, *88*, 1008–1014.
56. Indyk, H. E.; Evans, E. A.; Caselunghe, M. C. B.; Persson, B. S.; Finglas, P. M.; Woollard, D. C.; Filonzi, E. L. Determination of biotin and folate in infant formula and milk by optical biosensor-based immunoassay. *J. AOAC Int.* **2000**, *83*, 1141–1148.
57. Caselunghe, M. B.; Lindeberg, J. Biosensor-based determination of folic acid in fortified food. *Food Chem.* **2000**, *70*, 523–532.

58. Indyk, H. E.; Persson, B. S.; Caselunghe, M. C. B.; Moberg, A.; Filonzi, E. L.; Woollard, D. C. Determination of vitamin B<sub>12</sub> in milk products and selected foods by optical biosensor protein-binding assay: Method comparison. *J. AOAC Int.* **2002**, *85*, 72–81.
59. Dimartino, G. Convenient analysis of vitamin D in cheese and other food matrixes by liquid chromatography/mass spectrometry. *J. AOAC Int.* **2007**, *90*, 1340–1345.
60. Rychlik, M.; Freisleben, A. Quantification of pantothenic acid and folates by stable isotope dilution assays. *J. Food Comp. Anal.* **2002**, *15*, 399–409.
61. Rychlik, M. Simultaneous analysis of folic acid and pantothenic acid in foods enriched with vitamins by stable isotope dilution assays. *Anal. Chim. Acta* **2003**, *495*, 133–141.
62. Rychlik, M. Pantothenic acid quantification by a stable isotope dilution assay based on liquid chromatography-tandem mass spectrometry. *Analyst* **2003**, *128*, 832–837.
63. Rychlik, M.; Roth-Maier, D. Pantothenic acid quantification: Method comparison of a stable isotope dilution assay and a microbiological assay. *Int. J. Vit. Nutr. Res.* **2005**, *75*, 218–223.
64. Freisleben, A.; Schieberle, P.; Rychlik, M. Specific and sensitive quantification of folate vitamers in foods by stable isotope dilution assays using high-performance liquid chromatography-tandem mass spectrometry. *Anal. Bioanal. Chem.* **2003**, *376*, 149–156.
65. Pawlosky, R. J.; Flanagan, V. P. A quantitative stable-isotope LC-MS method for the determination of folic acid fortified foods. *J. Agric. Food Chem.* **2001**, *49*, 1282–1286.
66. Luo, X. B.; Chen, B.; Ding, L.; Tang, F.; Yao, S. Z. HPLC-ESI-MS analysis of Vitamin B-12 in food products and in multivitamins-multimineral tablets. *Anal. Chim. Acta* **2006**, *562*, 185–189.
67. Lu, B.; Ren, Y.; Huang, B.; Liao, W.; Cai, Z.; Tie, X. Simultaneous determination of four water-soluble vitamins in fortified infant foods by ultra-performance liquid chromatography coupled with triple quadrupole mass spectrometry. *J. Chromatogr. Sci.* **2008**, *46*, 225–232.





## Chapter 26

# Minerals and Trace Elements

Amparo Alegría, Reyes Barberá,  
María Jesús Lagarda, and Rosaura Farré

### CONTENTS

Abbreviations.....	543
26.1 Introduction.....	545
26.2 Sample Treatment.....	546
26.3 Methods of Determination .....	549
26.3.1 Titrimetric Methods .....	549
26.3.2 Visible Spectrophotometric Methods .....	549
26.3.3 Spectrofluorometry.....	551
26.3.4 Neutron Activation Analysis .....	551
26.3.5 X-Ray Fluorescence.....	553
26.3.6 Ion Selective .....	555
26.3.7 Electroanalysis.....	556
26.3.8 Chromatographic Methods .....	557
26.3.9 Atomic Spectrometry Techniques .....	559
26.3.10 Speciation.....	570
26.4 Conclusions .....	571
References.....	571

### Abbreviations

AAS	atomic absorption spectrometry
AOAC	Association Official of Analytical Chemist
ASV	anodic stripping voltammetry

CEMAS	channel electron multiplier arrays
CINAA	cyclic instrumental neutron activation analysis
CSV	cathodic stripping voltammetry
DAB	3,3'-diaminobenzidine DPASV differential pulse anodic stripping voltammetry
DAN	2,3-diaminonaphthalene
DF/SFMS-ICP-MS	double focusing/sector field mass spectrometry inductively coupled plasma mass spectrometry
DF-ICP-MS	double focusing inductively coupled plasma mass spectrometry
DPASV	differential pulse anodic stripping voltammetry
DPCSV	differential pulse cathodic stripping voltammetry
DPP	differential pulse polarography
EDTA	ethylene diamine tetraacetic acid
ED-XRF	energy dispersion x-ray fluorescence
EGTA	ethylene glycol tetraacetic acid
EINAA	epithermal instrumental neutron activation analysis
ESMS	electrospray mass spectrometry
ETAAS	electrothermal atomic absorption spectrometry
ETV	electrothermal vaporization
ETV-RC-ICP-MS	electrothermal vaporization reaction cell inductively coupled plasma mass spectrometry
FAAS	flame atomic absorption spectroscopy
FAES	flame atomic emission spectrometry
FIA	flow injection analysis
FIA-ASV	flow injection analysis anodic stripping voltammetry
FI-HGAAS	flow injection hydride generation atomic absorption spectrometry
HG-AAS	hydride generation atomic absorption spectrometry
HG-AFS	hydride generation atomic fluorescence spectrometry
HPLC	high-performance liquid chromatography
HPLC-AAS	high-performance liquid chromatography atomic absorption spectrometry
HR-ICPMS	high-resolution inductively coupled plasma mass spectrometry
HR-ICP-SFMS	high-resolution inductively coupled plasma sector field mass spectrometry
IAEA	International Atomic Energy Agency
IC	ion chromatography
ICP	inductively coupled plasma
ICP-AES	inductively coupled plasma absorption emission spectroscopy
ICP-MS	inductively coupled plasma mass spectrometry
ICP-ORC-MS	inductively coupled plasma octopole reaction system mass spectrometry
ICP-QMS	inductively coupled plasma quadrupole mass spectrometry
IE	ion exchange
INAA	instrumental neutron activation analysis
MALDI-MS	matrix-assisted laser desorption ionization mass spectrometry
MS	mass spectrometry
NAA	neutron activation analysis
PIXE	particle-induced x-ray
PSA	potentiometric stripping analysis
PVC	polyvinyl chloride

RC	reaction cell
RP	reverse phase
RSD	relative standard deviations
SEC	size exclusion chromatography
SI	sequential injection
SV	stripping voltammetry
UV	ultraviolet
WD-XRF	wavelength dispersion x-ray fluorescent
XRF	x-ray fluorescence

## 26.1 Introduction

The mineral content constitutes a small part of milk (8–9 g/L), comprising mainly Ca, K, Mg, Na, chloride, sulfate, and phosphate—citrate being the most important of the organic anions. Some components, such as chloride, sodium, and potassium, are totally soluble, ionic, and fully available for absorption, whereas others such as Ca, Mg, sulfate, inorganic phosphorous, and citrate are in equilibrium between the liquid and colloidal phases [1]. The mineral content of milk varies widely due to several factors such as the lactation period, the breed of animal, the season of year, type of animal feed, and soil contamination [2].

The Ca concentration in bovine milk is relatively constant, about 1 g/L. Contents of Mg and Zn in milk also show only small variations. Mg is ubiquitous in foods, and milk is a good source, containing about 100 mg/L. Zn is an essential part of several enzymes and metalloproteins. Milk is a good Zn source, containing about 4 mg/L [3].

About one-third of Ca, half of the inorganic phosphate, two-thirds of Mg, and over 90% of citrate are found in the aqueous phase of milk. The major forms of Ca are as phosphate, phosphocaseinate, and citrate [1]. A small proportion of Ca is also bound to  $\alpha$ -lactoalbumin, with one atom of Ca per protein molecule [4].

Although minerals represent a small fraction of milk (compared to the lipid or protein fractions), they play important roles in the structure and stability of the casein micelles. All casein molecules contain phosphoserine residues in clusters (except for  $\kappa$ -casein, which has only one residue), while phosphate groups constitute the main binding sites of cations in caseins [1]. Sixty percent of the Ca in milk is associated with the colloidal suspension of casein micelles, which is why it does not precipitate and remains in solution. Calcium phosphate also may be ionically bound to casein carboxyl groups, and together with  $\text{Ca}^{2+}$  ions can promote cross-linking between casein micelles. Twenty percent of the P in milk occurs in ester linkages with the hydroxyl groups of serine and threonine residues of casein; 40% in inorganic phosphate in casein micelles; and the rest in lipids and water soluble esters. As regards Mg, one-third is found in colloidal suspension with casein micelles [5].

A large proportion of Cu, Zn, and Mn is bound to casein. Fe and Mn are partly bound to lactoferrin [5]. In addition, no macroelements are bound in important amounts to the fat globules and lactose [1].

It is often assumed that iodide is the only iodine species in milk [6]. Se is mainly found in the protein fraction (most probably as selenomethionine and selenocysteine), and is equally distributed within the casein and whey fractions [5].

The levels at which minerals are present in dairy products, and the dynamic equilibrium of mineral components between the aqueous and colloidal milk phases also depend on the technological treatment applied during the manufacture of these products [7].

Fermented milk can also be a good source of minerals in the human diet. The fermentation process has little effect on the content of minerals in fermented milk, though Yaman et al. [8] reported that undesirable metals may enter yogurt, and the levels of nutritional metals may increase in the fermentation procedure—depending on conditions such as the container material used (aluminum, plastic, or steel). The time of storage as well as transportation to the consumer may increase undesirable metals in yogurt, due to the probability of turning sour.

On the other hand, the contents of Ca and P are generally higher in hard cheeses (up to 10 times those found in milk). The same applies to Mg, though in this case the contents are only about five times higher in hard cheeses than in milk. Na contents depend on the amount of salt added. The levels of K are no higher in cheese than in milk. The contents of other minerals are extremely variable [9].

During cheese ripening, some of the mineral salts may migrate from the central part toward the external layer of the cheese block or vice versa, under a pH gradient effect, causing changes in the concentration of some elements in the final product. Therefore, the nutritional value of some dairy products may be different at various stages of the ripening period [7].

Mineral analyses (P, Ca, Na, K, Mg, Zn, Fe, Cu, and Mn) have been applied to differentiate cheeses according to the animal milk species used in their manufacture and according to the variety [10]. The application of multielement and multiisotope analysis for tracing the geographical origin of food has been reviewed [11].

Mineral determination is a component of the quality control of whey, milk, and their derivatives. It is a very demanding field, and the need to develop accurate, simple, and time-saving methods is pressing [12].

## 26.2 Sample Treatment

Sample preparations generally involve digestion, extraction, and preparation of the analytes before analysis. Accordingly, this is a time-limiting step requiring approximately 61% of the total time needed to perform the complete analysis, and is responsible for 30% of the total analytical error. Simplification in sample manipulation, the use of high-purity water and reagents in suitable amounts, correct cleaning of recipients, and blank preparation in parallel to the samples are desirable. Validation of the methodology is also important, and is usually based on certified reference samples [13].

The main problem in carrying out total multielement determinations in milk and dairy products is the nature of the matrix, which may interfere with the analytical technique applied for measurement. The main preparation procedures for milk and dairy products can be classified into complete oxidation procedures (dry ashing and wet digestion) and slurries.

Techniques for the measurement of trace elements suffer from a significant decrease in detection power due to matrix constituents. The potentially very low detection limits can only be achieved when the concentrations of dissolved inorganic and organic matrix compounds are kept to a minimum. Particularly, the presence of dissolved organic carbon may cause severe interferences in trace element determination via differential pulse anodic stripping voltammetry (DPASV), inductively coupled plasma mass spectrometry (ICP-MS), and atomic absorption spectrometry (AAS), for example. Thus, complete oxidation of organic matrix constituents of biological samples is strongly recommended to ensure accurate and reproducible analytical results [14].

In milk and dairy products, dry ashing is a successful way to totally decompose the organic matter, minimize matrix effects in elemental analysis, and secure trace element preconcentration during preparation of the sample, as well as reduced blank values. Thus, it is common practice to use dry ashing as a reference procedure [15].

Another frequently used procedure for organic matter destruction is carried out in closed, pressurized devices, either microwave or conventionally heated, applying concentrated mineral acids. A major drawback of this digestion procedure is the introduction of relatively high background levels due to acidic impurities. Even with the highest degree of purity in commercially available reagents and after additional subboiling distillation, the blank level of acids remains too high for certain ultratrace determinations [14]. Some mineral acids are not tolerated by many analytical methods. HCl is not recommended for electrothermal atomic spectrometry (ETAAS) as it can cause Cl interferences;  $\text{H}_2\text{SO}_4$  is not desirable for inductively coupled plasma atomic emission spectrometry (ICP-AES) or ICP-MS, because of transport interferences derived from its viscosity. With ICP-MS,  $\text{HNO}_3$ , and  $\text{H}_2\text{O}_2$  are preferred as polyatomic interference is minimal, and a high acid concentration above 10% can cause corrosion of the sampler and skimmer cones [16].

Digestion by microwave-assisted pressurized wet ashing has been optimized for Se, Te, As, and Sb determination in milk. The authors reported that HCl and  $\text{HNO}_3$  do not offer total destruction of fat, and HCl must be avoided because it can cause losses of volatile hydrochlorides. A mixture of  $\text{HNO}_3$  and  $\text{H}_2\text{O}_2$  and adding ascorbic acid for removing the nitrates generated from  $\text{HNO}_3$  is the most appropriate [17].

A microwave-assisted ultraviolet (UV) digestion process has been applied and validated for Cu, Fe, Cd, and Pb determination in skimmed milk. UV irradiation is generated by immersed electrodeless Cd discharge lamps operated by the microwave field in the oven cavity. Compared to open UV digestion devices, the decomposition time is reduced by a factor of 5, and the maximum initial concentration of dissolved organic carbon, can be raised by a factor of at least 50. Only minimum amounts of reagents are required when compared to conventional acid digestion procedures, and a potential source of contamination is eliminated. Furthermore, sample dilution is avoided after digestion, resulting in an improvement in the detection limit [14].

The use of two types of microwave oven—one domestic and the other especially designed for laboratory microwave-based digestions—for destroying the organic matter in milk and infant formulas, using closed Teflon bombs, prior to the fluorimetric determination of Se, has been studied by Alegría et al. [18]. In both systems, the best results were obtained with the acid mixture  $\text{HNO}_3$ – $\text{H}_2\text{O}_2$  and additional treatment with  $\text{HClO}_4$  in a thermoblock®. Both microwave ovens (laboratory and domestic) are also adequate.

A critical study comparing different procedures such as dry ashing (with or without the addition of  $\text{H}_3\text{BO}_3$ ,  $\text{Mg}(\text{NO}_3)_2$ , and  $\text{H}_2\text{SO}_4$ ) and wet dissolution procedures (hot plate, high-pressure asher, and open and closed microwave heated systems) for the decomposition of milk samples was made, taking into account zinc recovery and residual carbon content. Digestions yielding lower residual carbon content values can be obtained on a hot plate with a mixture of  $\text{HNO}_3$ ,  $\text{H}_2\text{SO}_4$ , and  $\text{H}_2\text{O}_2$ . The same mixture also provides maximum sample digestion in the open-vessel focused microwave system. In closed-vessel microwave systems, replacement of low by medium-pressure vessels, or the addition of  $\text{H}_2\text{O}_2$  or  $\text{H}_2\text{SO}_4$ , reduces the residual carbon content. High-pressure digestion together with a high-temperature program completely destroys the organic matter only with  $\text{HNO}_3$ . Similarly, the dry ashing procedure is simple and exhaustive. In summary, for the determination of Zn in milk by ICP-AES, all the evaluated procedures can be applied. The distinction among digestion approaches resides in the completeness of sample decomposition [19].

For Al, Fe, and Zn determinations in yogurts by AAS dry ashing (500°C, 3 h), wet ashing, and microwave digestions were compared. For the three elements, the lowest detection limit was obtained by microwave digestion, though iron in the yogurt samples was not completely released when microwave destruction was used [8].

Dry ashing or microwave-assisted acid digestion are time-consuming processes and require excessively hard sample treatments. Such methodologies are unsuitable for speciation studies. The use of slurries is an alternative and offers the advantages of the direct solid and liquid sampling methods. The conventional atomizers and injection systems used for liquid samples can also be used for slurry samples, thus allowing the use of samples of higher weight than in solid sample analysis. It is even possible to carry out dilutions. It is known that the stability of slurries depends on the type of matrix, on the particle size, and on the concentration of surfactants. Homogeneous suspensions that remain stable for long periods of time can be very easily prepared from dry milk, skimmed milk, and chocolate, and their stability does not significantly depend on particle size. In the case of white and yellow cheese, particle size is a very important parameter. A stable suspension can only be produced if the particle size is less than 40  $\mu\text{m}$ . Different solvents and stabilizers such as  $\text{HNO}_3$ ,  $\text{H}_2\text{O}_2$ , Triton X-100, ethanol, and the like, are used in the preparation of the slurries. Diluted  $\text{HNO}_3$  is the most commonly used option: it operates as an oxidizing agent and can be considered as a chemical modifier as well, which increases the sensitivity. Moreover, it can efficiently increase analyte extraction from the solid particles of the slurries, enhancing suspension stability and improving precision. The use of slurry sampling and ETAAS determination, involving ultrasonic homogenization devices, overcomes some of the inherent drawbacks of traditional sample decomposition methods [20,21]. A review of the use in the last decade of slurry sampling and ETAAS, including milk and dairy products, has been carried out by Cal-Prieto et al. [22].

The direct determination of Mo in milk and related samples by means of the slurry-ETAAS approach is hindered by the low amount of analyte and the high proportion of organic matter present in this type of samples. In some of them, such as breast milk, Mo contents are near the determination limit, and large quantities must be introduced in the atomizer. A previous preconcentration step could be useful, since this would allow partial matrix elimination and would facilitate determination of the different chemical forms of the analyte in milk. In this respect, López-García et al. [23] described two procedures using slurry samples: direct or simple preconcentration based on ion exchange (IE), for the ETAAS determination of Mo in milk, breast milk and powdered infant formulas. The method was validated using standard reference materials with different fat contents. For direct determination, slurries were prepared in a medium containing concentrated  $\text{H}_2\text{O}_2$  and HF, respectively, and introduced directly into the furnace.  $\text{H}_2\text{O}_2$  permits complete ashing of the organic matter reducing residue accumulation, being a more effective oxidant in acidic medium, because at lower HF concentrations the corrected signal deviated to negative values. The only problem in this procedure is the fact that some samples, such as breast milk, mineral contents are close to the detection limit ( $0.02 \mu\text{g/g}$ ). Therefore, to improve sensitivity, a preconcentration step is performed using a weak basic anion-exchange resin (Amberlite IRA 743). In both methods, slurries with or without preconcentration, no significant differences in Mo contents in different milk types and standard reference material were found, in comparison with a reference procedure using previous mineralization by calcination and acid digestion.

Three acid systems (HCl, HCl +  $\text{H}_2\text{O}_2$ , and aqua regia) were evaluated for the determination by hydride generation atomic fluorescence spectrometry (HG-AFS) of As, Sb, Se, Te, and Bi in milk. HCl treatment could leach the elements physically retained in the protein fraction, but was unable to recover the total amount of these elements present in the samples. HCl +  $\text{H}_2\text{O}_2$  improved the extraction of metal ions from their association with proteins by partial oxidation of the organic matter, though sonication times in excess of 15 min were required. The method of choice was found to be sonication (10 min) of milk with aqua regia [24].

In ETAAS, direct milk introduction in the graphite tube without any dilution is unsuitable, due to poor repeatability caused both by carbon residues in the graphite tube and fat residues in the

autosampler capillary tube. The dilution of milk samples in water using different dilution factors was not effective for overcoming these effects. The dilution of samples with 10% v/v water-soluble tertiary amines allows the direct analysis of milk without any digestion procedure by ETAAS. This sample preparation has been applied to the determination of Fe and Se in bovine milk [25]. Previously, the benefits of using tertiary amines in mineral milk analysis by ICP-AES (Ca, K, Mg, Na, and P) and ICP-MS (Al, Ba, Cu, I, Mn, Mo, Pb, Rb, Se, Sr, and Zn) [26] have been shown. The main advantage of this procedure is its simplicity and speed, since the slow sample digestion step is eliminated. In addition, major trace elements and iodine can be determined in the same solution, without precipitation or volatilization losses.

The comparison of three sample preparation methods (slurries, wet digestion ( $\text{HNO}_3 + \text{H}_2\text{O}_2$ ) in a microwave open and dry mineralization at  $450^\circ\text{C}$ ) has been carried out for Ca, Mg, Na, K, and Fe determination in infant formulas by AAS. Slurries represent the most simple procedure. The analytical parameters (detection limit, precision, and accuracy) showed the method to be adequate for application to routine controls of infant formulas [27].

Karadjova et al. [21] compared wet digestion ( $\text{HNO}_3 + \text{HClO}_4 + \text{H}_2\text{O}_2$ ) with slurries ( $\text{HNO}_3 + \text{H}_2\text{O}_2$ ) for the determination of Cd, Co, Cr, Cu, Fe, Ni, and Pb in milk, cheese, and chocolate by ETAAS, obtaining similar results via both sample preparations—though in cheese samples the relative standard deviation values were higher for slurries, probably because of some nonhomogeneity of the latter.

## 26.3 Methods of Determination

### 26.3.1 Titrimetric Methods

Precipitation titrations are commonly applied to foods rich in  $\text{Cl}^-$  due to salt addition during the manufacture of dairy products. The Association Official of Analytical Chemist (AOAC) methods [28] include several titration procedures with  $\text{AgNO}_3$  and potentiometric end-point detection for the determination of  $\text{Cl}^-$  contents in cheese, butter, and milk-based infant formulas.

Direct titration of calcium in dissolved cheese ash with ethylene diamine tetraacetic acid (EDTA) proved unsuccessful because magnesium interfered with titration endpoint recognition. However, in the presence of a known amount of calcium chloride after initial titration with EDTA, a reliable endpoint was achieved by Kindstedt and Kosikowski [29].

The application of this technique is shown in Table 26.1.

### 26.3.2 Visible Spectrophotometric Methods

Common ultraviolet–visible (UV–vis) spectrophotometry is often simpler and less expensive than atomic spectroscopic methods, but does not allow multielement analysis and requires derivatization processes for improving sensitivity and selectivity [30].

Total P content has been measured in milk, dairy products, and infant formulas through the formation of a complex with molybdate [28,31–35] or reduction of amidol [36] after digestion of the sample.

Spectrophotometric determination of P in dairy products following microwave digestion ( $\text{HClO}_4 + \text{H}_2\text{O}_2$ ) is a simple, rapid, and low-cost method when compared to ICP-AES, if only P is to be measured—thus making it a suitable procedure for routine determination [36].

A sequential injection (SI) system for online digestion (thermal/UV-induced digestion) and colorimetric determination of P in milk has been developed [32,33]. The detection limit was



**Table 26.1 Minerals Determination in Milk and Dairy Products by Titrimetric Methods**

<i>Element</i>	<i>Food</i>	<i>Reagents</i>	<i>Reference</i>
<b>Complexometric</b>			
Ca, Mg	Milk	EDTA, pH 7–9 (Ca and Mg), EGTA, pH 7 (Ca)	[86]
Ca	Milk	EDTA titration, indicator pthalein purple	[87]
Ca	Cheese	Addition of CaCl <sub>2</sub> and back-titration with Na <sub>2</sub> EDTA, indicator hydroxynaphthol blue	[29]
Cu, Fe	Milk	Titration with Na <sub>2</sub> EDTA by constant potential amperometry, pH 2	[88]
<b>Precipitation</b>			
Ca, Mg	Milk	Precipitated with salicylic acid, dissolution with water	[89]
		Ca: NaOH, pH 12, indicator palladiazo, murexide, or calcein; titration with Na <sub>2</sub> EDTA Ca and Mg: NH <sub>3</sub> pH 10.5, indicator palladiazo or eriochrome black; titration with Na <sub>2</sub> EDTA	
Cl	Cheese	Precipitated with AgNO <sub>3</sub> ; titration with KSCN (Volhard)	[28]
		(AOAC 935.43)	
	Infant formulas and cheese	Titration potentiometric with AgNO <sub>3</sub>	[28]
		(AOAC 986.26, 983.14)	
Cl	Butter	Titration with AgNO <sub>3</sub> (AOAC, 960.29)	[28]

2 mg P/L. The advantages of the method are speed, 3.5 min/sample (digestion and determination) versus 4 h for the classical procedures, and the possibility of total automatization—thereby eliminating human error and saving time.

A microdetermination of P in infant formulas based on the formation of a phosphomolybdate has been proposed and validated [35]. The detection limit, 0.04 μg in assay (1.1 mm P/100 g sample), is lower than that obtained in milk or infant formulas by techniques such as ETAAS, ICP-AES, or neutron activation analysis (NAA).

Iodine is an essential nutrient for which no AOAC [28] or other generally accepted standard assay has been proposed. A comparison was made between two colorimetric iodine assays based on different reactions, in samples previously subjected to alkaline dry ashing. One assay kinetically measured at 380 nm the initial iodine catalysis of the redox reaction between Ce<sup>4+</sup> and As<sup>3+</sup>. The other assay monitored iodine catalysis of the reaction between thiocyanate and nitrite by measuring absorbance at 450 nm after 20 min. Both methods were accurate when tested with a reference

sample of nonfat milk powder. The thiocyanate-nitrite assay consistently showed greater sensitivity and precision, and less variability [37].

Visible spectrophotometry has also been used to determine Fe in milk products, and the results have been compared with those recorded with AAS. In general, good agreement between both methods was obtained [38].

A flow injection manifold with a colorimetric detection system has been developed for Fe and Cu determination in milk samples, with a sampling rate of 120 determinations per hour. After digestion, the samples are inserted in the flow injection analysis (FIA) system without additional treatment and adjustment of the sample. The colorimetric measurement is carried out inside the system, thus reducing the duration of the analysis [39].

A novel and simple spectrophotometric method (based on the complexation reaction with bromopyrogallo) by ratio spectra-continuous wavelength transformation for the simultaneous determination of Ca, Mg, and Zn without prior separation steps has recently been applied to UHT cow's milk and milk powder [40].

A selective optical strip test based on an IE mechanism to determine calcium in milk has been developed. This test strip contains a polymeric film of plasticized polyvinyl chloride (PVC) that contains all the reagents necessary to produce a response to calcium, among them the new ionophore, 4,13-bis[(*N*-adamantylcarbamoyl) propionyl]-1,7,10,16-tetraoxa-4,13-diazacyclooctadecane, measuring the absorbance at 655 nm. The procedure was applied to the determination of calcium ion in different types of milks (whole, skimmed, skimmed with calcium added, and special types), validating the results against AAS as reference method [41].

Some of the spectrophotometric methods applied to milk and dairy products are reported in Table 26.2.

### 26.3.3 Spectrofluorometry

Fluorimetric methods proposed for determining the selenium content in milk and dairy products have been reviewed (see Table 26.3).

Generally, following wet digestion, Se is converted to Se (IV) by boiling with HCl acid and determined by measurement of the fluorescence of the selenenol formed upon reacting with 2,3-diaminonaphthalene (DAN) or 3,3'-diaminobenzidine (DAB). DAN is the reagent of choice, because the complex is extractable into an organic solvent, and the sensitivity of fluorescence is higher than that of the DAB complex [20].

The main problem encountered in Se fluorimetric determination is organic matter destruction. With foods that have a high protein content, such as milk or infant formulas, complete digestion is more difficult than with other biological samples. Organic matter destruction must be complete, without losses due to volatilization, and all Se must be reduced to the Se (IV) state [18].

Wet digestion with  $\text{HNO}_3\text{--HClO}_4$  is efficient, and did not cause any interferences with the spectrofluorimetric Se determination in foods, including milk products, while the mixture  $\text{HNO}_3\text{--H}_2\text{SO}_4$  is effective in decomposing resistant organic material—but  $\text{H}_2\text{SO}_4$  caused the formation of crystallized DAN [42]. The detection limit in Se spectrofluorometry determination ( $0.001\ \mu\text{g/g}$ ) is lower than that of hydride generation atomic absorption spectrometry (HG-AAS) ( $0.033\ \mu\text{g/g}$ ).

### 26.3.4 Neutron Activation Analysis

NAA techniques are especially adequate for element determination. These techniques offer high sensitivity, and there are no elemental interferences, because only the element of interest becomes radioactive. NAA methods offer specificity, freedom from blank errors, easy sample preparation,

**Table 26.2 Minerals and Trace Elements Determination in Milk and Dairy Products by Visible Spectrophotometric Methods**

<i>Element</i>	<i>Food</i>	<i>Method</i>	<i>Reference</i>
Fe	Milk products	1,10-Phenanthroline hydrochloride/510 nm	[38]
Fe	Milk	2-Carbomethoxy-1,3-indandione (sodium salt)/500 nm	[90]
Fe	Milks and infant formulas	1,10-Phenanthroline, 512 nm (Fe)/ 1,5-diphenylcarbazide/436 nm (Cu)	[39]
Cu			
P	Milk, nonfat milk powder, <sup>a</sup> and skim milk powder <sup>a</sup>	2,4-Diaminophenol dihydrochloride/750 nm	[36]
P	Infant formula and cheese, skimmed milk powder	Sodium molybdate/ascorbic acid/323 nm	[31]
P	Milk	Ammonium molybdate/710 nm	[32,33]
P	Infant formulas and cheese	Molybdovanadate/740 nm (AOAC 986.24, 991.25), 820 nm (990.24)	[28,34]
P	Infant formulas	Ammonium molybdate/ascorbic acid/820 nm	[35]
P	Herby dairy products	Molybdate-vanadate	[91]
I	Milk powder <sup>a</sup>	Iodine catalyzed the redox reaction between (a) Ce <sup>4+</sup> and As <sup>3+</sup> kinetically measured at 1 min (380 nm) or (b) thiocyanate and nitrite (450 nm)	[37]
Cu, Fe	Milk	1-2-(2-Quinolylazo)-2,4,5-trihydroxybenzene in presence of thiosemicarbazide /Fe 510 nm, Cu (550 nm)	[92]
Cu	Milk and milk products	Sodium diethyldithiocarbamate/ CCl <sub>4</sub> /400 nm (AOAC 960.40)	[28]
Ca, Mg, Zn	UHT cow's milk	Bromopyrogallo red/350–650 nm	[40]
	Milk powder		
Ca	Whole and skimmed milk	Diluted sample: Tris buffer solution pH 8.5	[41]
		Test strip: Polymeric film of plasticized PVC contains 4,13-bis[(N-adamantylcarbamoyl) propionyl]-1,7,10,16-tetraoxa-4,13-diazacyclooctadecane	

<sup>a</sup> Standard reference material.

**Table 26.3 Minerals and Trace Elements Determination in Dairy Products by Spectrofluorimetric Methods**

<i>Elements</i>	<i>Food</i>	<i>Method</i>	<i>Reference</i>
Se	Infant formulas and milk powdered <sup>a</sup>	EDTA/glycine buffer/DAN 60°C, 1 h/ cyclohexane extraction; excitation 378 nm, emission 525 nm	[93]
Se	Human milk and infant formulas	EDTA/glycine buffer/DAN 60°C, 1 h/ cyclohexane extraction; excitation 378 nm, emission 525 nm	[18]
Se	Goat milk	EDTA/DAN 60°C, 15 min cyclohexane extraction; excitation 377 nm, emission 516 nm	[2]
Se	Milk products and nonfat milk powder <sup>a</sup>	EDTA-HONH <sub>2</sub> · HCl/DAN 60°C, 20 min, cyclohexane extraction; excitation 382 nm, emission 522 nm	[42]

<sup>a</sup> Standard reference materials.

and relatively few interferences and matrix effects [43]. No grinding, mixing, or drying is performed, and so the chances for contamination are minimal. The sensitivity of instrumental NAA depends on the composition of the sample and the element being determined. In a favorable situation, it may reach the parts-per-billion level, but it is mostly operable at the ppm level [44].

With one short irradiation step and 5 min of counting it is possible to nondestructively determine Ca, Co, Br, Cl, and K in foods (including butter). Minimum handling and no chemistry was involved before irradiation, and the danger of contamination was therefore minimal [45].

The cyclic instrumental neutron activation analysis (CINAA) method for Se in foods (including cheese and milk) and the epithermal instrumental neutron activation analysis (EINAA) method for I in foods (applied to a reference material: nonfat milk powder) can yield results of high precision and accuracy, and are rapid. They are thus amenable to routine use [46].

The application of these techniques is shown in Table 26.4.

### 26.3.5 X-Ray Fluorescence

X-ray fluorescence (XRF) can provide simultaneous multielement analyses of foods. It is rapid compared to the multielement atomic spectrometry techniques, and is nondestructive and matrix independent, in the same way as NAA; thus, measurement can be carried out directly on solid samples. Although sample matrix effects can be significant in XRF, they are relatively constant for milk and dairy products, due to their predominant contents of carbon, oxygen, nitrogen, and hydrogen. An advancement for quantitative XRF analysis without standards is the use of channel electron multiplied arrays (CEMAS) quantitation, similar to NAA in that it does not require standards of similar physical and chemical form as the samples, and it relies on fundamental parameters of x-ray physics for quantitation of the x-ray intensities. This approach eliminates the need for calibration standards of composition similar to the samples, and allows the use of standard reference materials only for monitoring accuracy and precision [47,48].

The main limitations of the XRF methods are the reduced number of elements to which the method is applicable—only elements having an atomic number between 22 (titanium) and 55

**Table 26.4 Minerals and Trace Elements Determination in Milk and Dairy Products by Neutron Activation Analysis**

<i>Element</i>	<i>Food</i>	<i>Method</i>	<i>Reference</i>
Br, Ca, Cl, Co, K	Butter	NAA thermal neutron flux $5 \times 10^{11}$ n cm <sup>-2</sup> s <sup>-1</sup> ; irradiation time 60–200 s; detector Ge	[45]
Se	Cheddar cheese	CINAA: Se (irradiation time 20 s, decay time 10 s, counting time 20 s) number cycles 4. Thermal flux $5 \times 10^{11}$ n cm <sup>-2</sup> s <sup>-1</sup> ; detector Ge	[46]
	2% milk		
I	Nonfat milk powder <sup>a</sup>	EINAA: I (irradiation time 30 min, decay time 1–6 min, counting time 30 min); detector Ge (Li)	[46]
	2% milk		
Br, Ca, Cl, Cu, I, K, Mg, Na, Rb, S, Ti	Cheese	Neutron flux $5 \times 10^{11}$ n cm <sup>-2</sup> s <sup>-1</sup> ; irradiation (60–200 s); detector Ge	[44]
Se	Milk powder <sup>a</sup>	CINAA thermal neutron flux $5 \times 10^{11}$ n cm <sup>-2</sup> s <sup>-1</sup> . Irradiation time 20 s, decay time 10s, counting time 20 s; detectors Ge(Li)	[94]
Co, Cr, Fe, Rb, Se, Zn	Italian dairy products	INAA thermal neutron flux $2.6 \times 10^{12}$ n cm <sup>-2</sup> s <sup>-1</sup> for 14 h; detector Ge	[7]
Ca, Fe, k, Mg, Mn, Na, Zn	Chocolate milk, yogurt, and petit Suisse cheese	INAA thermal neutron flux $1 \times 10^{11}$ n cm <sup>-2</sup> s <sup>-1</sup> for 2 min; detector Ge	[95]
Al, B, Ba, Ca, Co, Cr, Cu, Fe, K, Li, Mg, Mn, Mo, Na, Ni, P, S, Sb, Sn, Sr, V, W, Zn	Milk powder	INAA thermal neutron flux $5.6 \times 10^{13}$ n cm <sup>-2</sup> s <sup>-1</sup> for 4 h; detector Ge	[96]

<sup>a</sup> Standard reference material.

(cesium)—and the need to work under special conditions or with low sensitivity, when light elements such as magnesium are to be measured. Other drawbacks of the XRF methods are high cost, important matrix effects when the salt contents are high, and the fact that the radiation intensity is not a lineal function of the element or element contents [20].

The CEMAS XRF method for multielement analysis of foods involving the determination of Mn, Fe, Cu, and Zn in eight standards (including powdered milk) and in a variety of food materials (without including milk products) by comparison with independent determinations by flame atomic absorption spectrometry (FAAS), following ashing, has been characterized and validated [47]. In relation to milk matrix, this study only includes Zn and Mn determination in powdered milk (SRM). The detection limits varied most for Mn, due to the variation in matrix composition of the standards; as a result, Mn in this sample was below the detection limits (1.4 µg/g). In a later

study, the analysis was extended to the determination of P, S, Cl, K, Ca, Mn, Fe, Zn, Br, Rb, and Sr in the same standard reference material, and the method was validated for the determination of these elements in five samples of milkshake, among other foods, by comparison with FAAS following ashing. Good agreement was obtained for both techniques, with correlation coefficients from XRF versus FAAS plots for Mn, Fe, and Zn of 0.94, 0.97, and 0.97, respectively [48].

The XRF technique shows a potential as an analytical tool to be used near food production lines, because direct analyses of solid samples can be performed without any pretreatment. In the field of dairy products, to ensure correct addition of mineral premixes during infant formula production, tracers (e.g., Fe) may be determined in final products. Accurate and rapid analysis of the Fe tracer can be used to modify the process parameters and thus to ensure that target concentrations of premixes added to the milk powders are achieved. When the target concentration is obtained, the infant formula production can be released.

Perring and Andrey [49] were the first to mention this potential of energy dispersive (ED)-XRF for quality control at production sites, in relation to the rapid determination of P, S, Cl, K, Ca, Fe, and Zn in milk-based products. Reference values measured by ICP-AES and by potentiometry for chloride were used to calibrate ED-XRF. Parameters such as pellet weight (4g powder) and pelletizing pressure (2 ton) were optimized. As ED-XRF was planned to be installed near the production lines of milk powders, the influence of environmental temperature was studied. No significant differences were observed between results at 20°C and at other temperatures. The use of XRF for Cl is interesting, because it cannot be determined by classical AAS or ICP (nonequipped with deep-UV optics: 120–180 nm). However, two major elements, Na and Mg, occurring in milk-based products, could not be analyzed by ED-XRF, due to insufficient detector sensitivity. At the present time, XRF cannot completely replace ICP-AES. The use of a liquid nitrogen cooled detector would be necessary, though it is only available in bigger and more expensive systems.

In a later study, these authors [50] measured the same elements in addition to Na and Mg in milk-based products by wavelength-dispersive (WD)-XRF, and compared the limits of detection of this technique with those obtained by ED-XRF. They concluded that the ED-XRF limits of quantification come closer to the WD-XRF values as the atomic number of the element increases. Furthermore, WD-XRF is able to quantify Na and Mg in milk-based products compared with ED-XRF.

In order to use ED-XRF near food production lines, the method has been proposed and validated for rapidly checking Fe, Cu, and Zn in pure mineral premixes and blends of mineral and vitamin premixes (all in powder form), used in the manufacture of infant formulas and instant milk powders [51]. Na, Mg, P, S, Cl, K, Ca, Mn, Fe, Cu, and Zn have been measured with the aim of identifying inorganic salts used as raw materials during food production [52]. In the first study, reference values measured by ICP-AES were used to calibrate ED-XRF.

The application of these techniques is shown in Table 26.5.

### 26.3.6 Ion Selective

Specific electrodes have been used to determine the salt content of butter, cheese, the Ca content in milk and cheese, and the Na content in ice creams [20].

The content of free Ca(II) in peptide fractions of  $\alpha$ - and  $\beta$ -casein from fresh skimmed milk in 50 nM Tris-HCl (pH 8 at 20°C) is measured using a Ca(II)-selective electrode [53]. Calcium distribution between the soluble and the colloidal phases of reconstituted skimmed milk supplemented with different salts (such as Ca chloride and Ca from milk) has been studied. Total Ca and soluble Ca were quantified by atomic absorption, but a Ca ion-selective electrode was used to measure ionized Ca concentration [54].

**Table 26.5 Minerals and Trace Elements Determination in Milk and Dairy Products by X-Ray Fluorescence Methods**

<i>Elements</i>	<i>Food</i>	<i>Technique</i>	<i>Reference</i>
Cu, Fe, Mn, Zn	Powdered milk (1549) <sup>a</sup>	XRF and CEMAS quatitation	[47]
Ca, Br, Cl, Fe, K, Mn, P, Zn, Rb, S, Sr	Powdered milk (1549) <sup>a</sup> and milkshake <sup>b</sup>	Lyophilized sample/ XRF and CEMAS quatitation	[48]
As, Br, Ca, Cu, Fe, K, Mo, Mn, Ni, Rb, Se, Sr, Zn	Milk, human milk, cow milk, and infant formulas	Bacterial decomposition of protein and fat (4–5 days) and freeze-dried/ PIXE and radioisotope-induced XRF	[97]
Ca, K	Milk powder, IAEA A-11 and 153 <sup>a</sup>	Pelletization/ED-XRF	[98]
As, Br, Fe, Rb, Zn	Milk powder, IAEA A-11 and 153 <sup>a</sup>	Pelletization/ED-XRF	[99]
Ca, Cl, Fe, K, P, S, Zn	Commercial milk-based powders	Pelletization (4 g 2 ton)/ ED-XRF	[49]
Ca, Cl, Fe, K, Mg, Na, P, S, Zn	Commercial milk-based powders	Pelletization (4 g 2 ton)/ WD-XRF	[50]
Cu, Fe, Zn	Pure mineral premixes and blends of mineral and vitamin premixes to manufactured infant formulae and instant milk powders	Pelletization (4 g 10 ton)/ ED-XRF	[51]
Al, Ba, Ca, Co, Cr, Cu, Fe, K, Mn, Ni, Sr, Ti, Zn	Skim milk powder	ED-XRF	[100]

<sup>a</sup> Standard reference materials.

Iodide is determined in ready-to-feed milk-based infant formulas using an ion-selective electrode; proteins are previously precipitated by adding acetic acid (3% v/v), and NiNO<sub>3</sub> is used to reduce the interferences due to the iodide electrode response (AOAC: 992.24) [28].

### 26.3.7 *Electroanalysis*

The determination of some minerals (mainly Cu, Zn, Se, Cd, and Pb) in milk or dairy products, based on voltammetric techniques such as anodic stripping voltammetry (ASV), cathodic

stripping voltammetry (CSV), or differential pulse polarography (DPP) is simple, rapid, and requires relatively inexpensive instrumentation, with good sensitivity (capable of determining elements accurately at trace to ultra-trace levels), and the possibility of multielement determination. Electroanalytical techniques provide an alternative to the use of atomic spectroscopic methods for heavy metal determinations, and are free of interferences detected by AAS procedures. The standard addition method must be used for quantification [55–57].

In Table 26.6 some of the applications of these techniques are shown.

An automatic-continuous method for the simultaneous determination of Cu and Pb based on FIA and stripping voltammetry (SV) was proposed by Izquierdo et al. [55] and applied to skimmed milk as reference material. The method affords the determination of the analytes at the ng/mL level with good precision, though the Cu content obtained in this reference material does not agree with the certified value. Continuing with FIA applications, Muñoz and Palmero [58] described a method for the determination of trace concentrations of Cd, Pb, and Cu by stripping potentiometry with a homemade flow cell, and applied it to powdered milk. Also to be noted is the determination by direct ASV application of Cu in powdered milk and breast milk, preceded by wet mineralization of the sample and solvent extraction of Cu(II)-acetylacetonate into chloroform. The linear range of the calibration plot was from  $5 \times 10^{-8}$  to  $10^{-6}$  M of Cu (II), and the limit of detection was  $1.4 \times 10^{-8}$  M of Cu (II) [59].

### 26.3.8 Chromatographic Methods

High-pressure liquid chromatography (HPLC) and ion chromatography (IC) have been widely recognized as versatile methods for multielement and sensitive analyses of metal ions using either pre or postcolumn derivatization. To be useful, postcolumn reactions must be rapid and generate low background signals. Dead volume associated with connecting tubing, detector, and mixing devices must be minimized to avoid unnecessary peak dispersion. The precolumn derivatization procedure ensures that the excess of reagent is completely separated from the chelates and does not actually contribute to the increase in baseline signals at the peak positions of the chelates. This fact indicates that the attainable sensitivity is determined only by the inherent signal/noise of the detector. Precolumn derivatization is normally performed offline (batch) because of instrumentation simplicity. But offline manipulation has proved to be laborious and time-consuming, especially if a number of samples are to be processed, and may result in low precision. On the other hand, online derivatization offers automation, ease, and a high sampling rate, thus providing an attractive alternative. Some developments have involved the coupling of FIA or SI with HPLC for online precolumn derivatization. FIA involves inexpensive hardware and a simple operational basis, while SI offers a high potential for higher degree performance in laboratory automation, with less sample/reagent consumption [30]. IC has drawn the attention of analysts due to its high sensitivity, rapidity, and ease of operation and relatively cheap and widely used instrumentation, coupled to the advantage of simultaneous anion and cation determinations [60].

IC is a routine technique for the analysis of inorganic ions in foods and beverages. The most widespread detection technique used with IC is conductimetry coupled to postcolumn suppression of eluent ions. The evolution of self-regenerating suppressors that minimize eluent conductivity while enhancing analyte conductivity allows parts-per-billion detection limits for anions and cations, without preconcentration. The general applicability of IC to milk, milk products, whey, and its derivatives offers a simple tool for the systematic study of these products [12].



**Table 26.6 Minerals and Trace Elements Determination in Milk and Dairy Foods by Electroanalytical Methods**

<i>Element</i>	<i>Food</i>	<i>Sample Treatment</i>	<i>Technique</i>	<i>Reference</i>
Cd, Cu, Pb, Zn	Infant formulas	HNO <sub>3</sub> -HClO <sub>4</sub> -H <sub>2</sub> SO <sub>4</sub>	DPASV	[101]
Cd, Cu, Pb	Milk, powdered milk, yogurt, concentrated cream, pudding, and cheese	Remove fat fraction by centrifugation	DPP	[57]
		Add HCl and centrifugation		
Cd, Cu, Pb	Milk	Dry ashing (450°C) and dissolution in acetic acid-acetate buffer (pH 3.4)	PSA	[58]
Bi, Cd, Cu, Pb, Sb, Zn	Milk, powdered milk, condensed or evaporated milk, and cream milk	HNO <sub>3</sub> -H <sub>2</sub> O <sub>2</sub> (pressurized Teflon bomb)	DPASV	[102]
Cu	Powdered milk and breast milk	HNO <sub>3</sub> -HClO <sub>4</sub> -H <sub>2</sub> O <sub>2</sub>	ASV	[59]
		Extraction solution: acetylacetonate 1 M in Cl <sub>3</sub> CH		
Co, Ni	Milk and cheese	HNO <sub>3</sub> -HClO <sub>4</sub> -H <sub>2</sub> O <sub>2</sub>	DPCSV	[21]
Se, Pb	Milk	HNO <sub>3</sub> -HClO <sub>4</sub> (1:1)	DPCSV	[103]
			DPASV	
Se	Milk	Wet ashing + Mg NO <sub>3</sub> followed of dry ashing Se (VI) is reduced to Se (IV) with HCl 6 M (85°C-90°C)	CSV	[104]
Pb	Skimmed milk powdered <sup>a</sup>	HNO <sub>3</sub> -H <sub>2</sub> SO <sub>4</sub>	FIA-ASV	[55]
Ni	Infant formulas	Dry ashing (450°C) dissolution in HNO <sub>3</sub>	DPCSV	[56]

<sup>a</sup> Standard reference material.

The AOAC proposed a method (992.22) for iodine (iodide) determination by IC with electrochemical detection following protein removal by passing through a membrane in pasteurized liquid milk and skimmed milk powder [28].

A review of the applications of IC to the determination of inorganic ions in food has been published by Buldini et al. [61]. The review includes applications to the determination in milk of inorganic anions (NO<sub>3</sub><sup>-</sup>, SO<sub>4</sub><sup>2-</sup>, PO<sub>4</sub><sup>3-</sup>, Br<sup>-</sup>, Cl<sup>-</sup>, and I<sup>-</sup>) or nitrogen, sulfur and phosphorus,

halides and oxyhalide species, by basically using a conductivity detector, while iodine and  $\text{IO}_3^-$  are usually determined by UV–vis and/or amperometric detection. The review also includes applications of the determination of other inorganic cations in milk such as total Se, Ca using UV–vis detection, and K by conductivity detection.

An IC method has been developed for the determination of total  $\text{Cl}^-$ ,  $\text{Br}^-$ ,  $\text{PO}_4^{3-}$ , and  $\text{SO}_4^{2-}$ , with conductimetric detection, and of Cu, Co, Fe, Ni, Pb, and Zn with spectrophotometric detection, after postcolumn derivatization in different types of milk (whole, skimmed, powdered, evaporated, etc.). The organic matrix was destroyed by oxidative photodegradation with  $\text{H}_2\text{O}_2$  in a UV digester, equipped with a high-pressure mercury lamp (500 W) at  $85^\circ\text{C} \pm 5^\circ\text{C}$ . It was found that recovery ranged from 97%–103%, while iodide, nitrite, nitrate, and sulfite were partially lost due to the influence of UV radiation, and Mn(II) was oxidized to a higher oxidation state. The procedure was compared to wet digestion in a closed system with  $\text{HNO}_3$ , providing an efficient alternative to conventional wet digestion methods, even though it is still a time-consuming option, because it is a simple procedure (in less than 2 h), has minimal reagent requirements, a very low blank value, and is completely automated [60].

In order to study the effect of the seasons, locality, and method of feeding on iodine levels in milk, and to provide an evaluation of iodine content in milk, Hejtmánková et al. [62] determined this element by HPLC with electrochemical detection on Nova-Pack C-18 reverse phase (RP) columns, following alkaline mineralization in the presence of KOH,  $\text{ZnSO}_4$ , and  $\text{KClO}_3$ . In the same way, Gambelli et al. [7] with the purpose of evaluating the contribution of some dairy products to the quality of diet, determined Na, K, Mg, and Ca in several varieties of Italian cheese and in some varieties of Quark cheese using IC with suppressed conductivity, following ashing mineralization ( $500^\circ\text{C}$  for 24 h). The method was standardized using a certified sample [International Atomic Energy Agency (IAEA), powder milk].

With simple preparation (clarification, dilution with water, and filtration), the soluble cations ( $\text{Na}^+$ ,  $\text{NH}_4^+\text{K}^+$ ,  $\text{Mg}^{2+}$ , and  $\text{Ca}^{2+}$ ) and anions ( $\text{Cl}^-$ ,  $\text{SO}_4^{2-}$ , and  $\text{PO}_4^{3-}$ ) contained in whey of different mammalian species were investigated by IC and electrochemical suppressed conductivity detection. There was very good repeatability of the retention for all cations, the relative standard deviations (RSD) ranging from 1.1% to 3.1%. The detection limits were found to be 10, 70, 70, 50, 40, and  $60\ \mu\text{g/L}$  for  $\text{Li}^+$ ,  $\text{Na}^+$ ,  $\text{NH}_4^+$ ,  $\text{K}^+$ ,  $\text{Mg}^{2+}$ , and  $\text{Ca}^{2+}$ , respectively. The limits of detection for the anions investigated were found to be 0.10, 0.17, and  $0.84\ \text{mg/L}$  for  $\text{Cl}^-$ ,  $\text{SO}_4^{2-}$ , and  $\text{PO}_4^{3-}$ , respectively. Precise retention times were achieved for all ions (0.15%–0.26% RSD) [12].

Applying a similar sample treatment (except for clarification), Burakham et al. [30] simultaneously determined some heavy metals, including Co(II), Ni(II), Cu(II), and Fe(II) in milk (powdered infant formulas) by online HPLC coupled with SI and precolumn derivatization 2-(5-nitro-2-pyridylazo)-5-[*N*-propyl-*N*-(3-sulfopropyl)amino]phenol (nitro). The system provides means for automation, with good precision and minimizing error in solution handling—with a RSD of less than 6%. The detection limits obtained were  $2\ \mu\text{g/L}$  for Cu(II) and Co(II), and  $1\ \mu\text{g/L}$  for Ni(II) and Fe(II). Some metal ions such as Co(II) and Ni(II) were not detectable in milk. However, the recoveries, assessed by experiment of known amounts of metal ions ( $0.020\ \text{mg/L}$  each) spiked in milk, were satisfactory (91%–99%).

### 26.3.9 Atomic Spectrometry Techniques

Atomic spectrometry techniques are the most widely used options for total elemental analysis in milk and dairy products. The choice of FAAS, ETAAS, or ICP-AES depends on the concentration

of the element sought, the required accuracy and precision, and the number of elements to be determined.

FAAS is a well-established method for the determination of the major elements such as Ca, Mg, K, and Na—though the latter two also can be determined by flame atomic emission spectrometry (FAES).

Milk and dairy products are complex matrixes that decrease the nebulization efficiency in mineral determination by FAAS. The use of a high-performance nebulizer (with a tantalum capillary, a ceramic impact bead, a body of the unattached plastic, a larger diameter, an impact bead nearest to the venturi, required for nebulization efficiency) is necessary to improve sensitivity for Zn and Fe determination—making it unnecessary to use surfactants, because important dilution of the sample is possible, thereby overcoming problems with the matrix [63].

Electrothermal AAS allow very small sample volumes to be used, and low detection limits allow the determination of trace and ultratrace elements (Al, Cd, Cu, Fe, Mn, Ni, Se, Zn, Co, Cr, Pb, and Cd). However, this technique is prone to spectral and matrix interferences.

In the determination of some elements by ETAAS, one of the problems found is volatilization loss (e.g., Se, Pb, and Cd), along with the formation of thermally stable compounds such as oxides and carbides—together with strong memory effects between injections (e.g., Mo, V). In order to reduce these undesirable effects, several modifiers jointly to mineralization temperatures have been proposed. Alegría et al. [64] evaluated different modifiers (Cu/Mg, Ni/Pd, and Pd/Mg) at different concentrations for the determination by ETAAS of selenium in infant formulas. Cu/Mg 5/10 µg yielded the lowest blanks and the highest absorbance values. A high mineralization temperature (>1800°C) in the presence of a modifier (Pd) has been proposed to determine Mo by ETAAS in slurries of milk and infant formulas [65]. The efficiency of the two types of atomizer, standard and standard with end cap, was compared—the latter yielding an increase in the peak area of approximately 30% and a delay in its appearance when compared with the standard atomizer. The second type of analyzer was thus selected.

Preheating of the graphite tube and the use of barium difluoride as a chemical modifier offers good stabilization of V up to 2000°C, allowing direct determination of vanadium in milk by ETAAS with preconcentration of the sample [66]. The use of Pd as modifier for the determination of Cd and Pb in slurries of milk, cheese, and chocolate with atomization temperatures of 2300°C has been proposed, obviating the need to use the modifier after wet digestion [21].

The use of different modifiers (Rh, Pd, Pt, Si, Au, W, Zr, Co, Ni, Cu, and H<sub>3</sub>BO<sub>3</sub>) was studied for Mo determination in milk slurries—the maximum sensitivity being obtained with Pd solution in concentrated HF [65].

Heterogeneous matrixes may affect the quality of sampling by changing the amount of analyte within the pipette of the spectrometer autosampler. As a result, the mass of analyte within the atomizer can vary randomly, and thus also the repeatability and/or accuracy of the measurements. Arsenic has been proposed as internal standard for direct determination of Se in foods by simultaneous multielement AAS using W/Rh or W with the coinjection of Pd(NO<sub>3</sub>)<sub>2</sub> as permanent modifier. The performance of this coating on the platform of the graphite tube improves the lifetime of the atomizer. The validation of the method (precision and accuracy studies) shows the adequacy of the procedure for the determination of Se in a wide variety of foods, because internal standardization is not limited to the selected analyte, internal standard, or samples used in the study [67].

A procedure for determining Se in cow's milk using HG-AAS following microwave-assisted acid digestion with HNO<sub>3</sub> + H<sub>2</sub>O<sub>2</sub>, and HCl to reduce Se (VI) to Se (IV), has been proposed. Nitrite, formed by oxidative decomposition with HNO<sub>3</sub>, causes severe signal depression due to its oxidative potential against hydrogen selenide. To avoid this problem, urea is added to eliminate

nitrogen oxides. The hydride generation conditions were optimized by experimental design, and the method was evaluated [68].

The methods of analysis used for the determination of Se in milk and infant formulas have been reviewed detailing detection limits, sensitivity, interferences, and matrix-related problems [69].

Inductively coupled plasma is a technique half-way between FAAS and ETAAS in terms of detection power. The main advantages are robustness against matrix effects and to the possibility of multielement analysis. Multielement analysis has been successfully used to determine contents and for the characterization of major and trace elements in milk and dairy products. Applications of this technique for elemental analysis in milk and dairy products are summarized in Table 26.7.

Inductively coupled plasma MS is currently the most powerful detector in atomic spectrometry, mainly due to its high sensitivity, multielement analytical capacity, and capability for measuring isotope ratios. Quadrupole mass, high mass resolution, and collision/dynamic reaction cell systems and their applications have recently been reviewed by De la Flor et al. [16].

The main limitations of ICP-MS are the spectral (isobaric and polyatomic) interferences, which cannot be resolved by low resolution quadrupole ICP-MS, and which lead to significant background equivalent concentration for important elements in milk and dairy products. Polyatomic interferences result from a combination of precursors in the Ar plasma, atmospheric gases, reagents, and sample matrix. Particularly, elements between 40 and 82 amu can suffer from these polyatomic interferences. In this sense, the use of double focusing/sector field mass spectrometry (DF/SFMS)-ICP-MS, operating at medium or high resolving power, allows reduction of the influence of spectral interferences by using measurements at medium resolution settings. Furthermore, DF-ICP-MS provides better sensitivity, superior by one or two orders of magnitude, compared with quadrupole ICP-MS. On the other hand, matrix interferences are also an important group of interferences that reduce and enhance the true analyte signals, in multielement analysis in milk and dairy products by using ICP-MS. Moreover, instrumental drift can occur due to changes in nebulization efficiency and slat deposition in the sampler and skimmer. Internal standardization is an extremely effective way of compensating for matrix effects and instrumental drift.  $^{45}\text{Sc}$ ,  $^{71}\text{Ga}$ ,  $^{89}\text{Y}$ ,  $^{103}\text{Rh}$ ,  $^{115}\text{In}$ ,  $^{159}\text{Tb}$ , and  $^{205}\text{Tl}$  were studied as possible candidates for use as internal standards [70,71].

Prohaska et al. [70] conducted a detailed study of spectral interferences in the milk matrix. In this sense, the use of different nebulizer systems, torch equipped with Pt-guard electrode and the use of  $\text{N}_2$  as make-up gas for the nebulizing system has been discussed in order to reduce interferences and enhance signals to Al, As, Co, Cr, Cu, Fe, Mn, Ni, Sc, Ti, and V. In order to remedy the nonspectral interferences produced by nitric acid, studies were made of the use of In, Re, Ru, and Rh as internal standards for determination of the aforementioned elements and Ag, Pt, Au, and Pb. Rivero Martino et al. [71] documented the most important interferences from polyatomic ions (Al, Ca, Cr, Cu, Fe, Mn, Ni, and Se) described in the literature, and Ga, Y, Rh, In, and Tl were tested as possible internal standards in the analysis of Al, Ca, Cd, Cr, Cu, Fe, Hg, Mg, Mn, Na, Ni, Pb Se, Sr, and Zn in digested milk samples.

Slurry sampling has been used together with electrothermal vaporization (ETV), one of the sample introduction techniques currently employed in ICP-MS, though it still suffers from spectroscopic and nonspectroscopic interferences, residue accumulation in the furnace, analyte loss during transportation, and poor reproducibility problems [72].

The reaction cell and/or collision cell technique can be an alternative to sector field spectrometers for alleviating spectroscopic interferences in ICP-MS analysis. The cells (quadrupoles, hexapoles, or octopoles) are pressurized with a gas or a mixture of gases in order to reduce or

**Table 26.7 Minerals and Trace Elements Determination in Milk and Dairy Products by Atomic Spectrometric Methods**

<i>Element/Food</i>	<i>Sample Treatment/Comments</i>	<i>Technique</i>	<i>Reference</i>
Ca, Mg, Fe, Zn, Cu, Mn, Na, K/infant formula	Dry ashing (525°C) (AOAC: 985.35)	FAAS	[28]
Ca, Mg/cheese	Dry ashing (525°C) (AOAC: 991.25)	FAAS	[28]
Se/whole milk, nonfat milk, whole milk powder, <sup>a</sup> nonfat milk powder, <sup>a</sup> soy bean milk	(a) Diluted (1 + 9 v/v) with HNO <sub>3</sub> 1% (v/v) (b) Diluted (1 + 4 v/v) with HNO <sub>3</sub> 1% (v/v) As (IS), Pd (NO <sub>3</sub> ) <sub>2</sub> modifier	ETAAS	[67]
Al, Ca, K, Mg, Na, P, Rb, S, Si Sr, Zn  As, Au, Ba, Bi, Cd, Ce, Co, Cr, Cs, Cu, Dy, Er, Eu, Fe, Ga, Gd, In, La, Lu, Mn, Mo, Nb, Nd, Pb, Pd, Pr, Re, Rh, Sb, Se, Sm, Tb, Te, TH, Ti, Tl, U, V, Y, Zr/cow's milk	Microwave digestion: HNO <sub>3</sub> + H <sub>2</sub> O <sub>2</sub>	ICP-AES  HR-ICPMS	[105]
Al, Ba, Co, Cr, Cu, Fe, Mg, Mn, Ni, Pt, Sr, Zn  Cd, Pb/raw milk, dairy products, skim milk powder <sup>a</sup>	Dry ashing (420°C)	ICP-AES  ETAAS	[106,107]
Al, Ba, Co, Cu, Fe, Mg, Mn, Sr, Zn  Cr, Ni, Cd, Pb/goat milk, dairy products  Pt/sheep milk, goat milk, dairy products, skim milk powder <sup>a</sup>	Dry ashing (420°C)	ICP-AES  ETAAS  ICP-MS	[108]
Cd, Cu, Pb  Fe/skimmed milk <sup>a</sup>	Microwave-assisted UV digestion: HNO <sub>3</sub> + HCl + H <sub>2</sub> O <sub>2</sub>	AAS  ICP-OES	[14]
Se <sup>c</sup> /cow's milk, whole milk powder <sup>a</sup>	Microwave digestion: HNO <sub>3</sub> + HCl + H <sub>2</sub> O <sub>2</sub> + urea	HG-AAS	[68,109]
Se (IV), Te (IV) total Se, Te/milk	(a) Slurry: aqua regia (Se (IV), Te (IV) + KBr (as reductant) (total Se, Te)  (b) Microwave digestion: HNO <sub>3</sub> + H <sub>2</sub> O <sub>2</sub>	HG-AFS  ICP-MS	[110]

**Table 26.7 (continued) Minerals and Trace Elements Determination in Milk and Dairy Products by Atomic Spectrometric Methods**

<i>Element/Food</i>	<i>Sample Treatment/Comments</i>	<i>Technique</i>	<i>Reference</i>
As, Sb/milk	(a) Microwave digestion: HNO <sub>3</sub> + H <sub>2</sub> O <sub>2</sub> (b) Dry ashing (450°C)	HG-AFS ICP-MS	[15]
Se, Te/cow milk	(a) Microwave digestion: HNO <sub>3</sub> + H <sub>2</sub> O <sub>2</sub> (b) Dry ashing (450°C)	HG-AFS ICP-MS	[17]
As, Sb, Se, Te, Bi/milk	Slurry. Aqua regia	HG-AFS	[24]
Fe, Se/milk, whole milk powder <sup>a</sup>	Direct determination: dilution of samples with water-soluble tertiary amines	ETAAS	[25]
Pb, Cd, Al, Cu, Cr, Mn, Se, Zn, Ni/milk	Slurries: Triton X-100	ETAAS	[111]
Zn/ human milk, bovine milk, infant formula, nonfat milk powder <sup>a</sup>	Comparison dry and wet digestion procedures	ICP-AES	[19]
Se/infant formulas	Microwave digestion: HNO <sub>3</sub> + H <sub>2</sub> O <sub>2</sub>	GFAAS	[93]
Ca, Mg Na, K Fe/infant formulas, skim milk powder <sup>a</sup>	Comparison dry, wet digestion methods and direct determination	FAAS FAES FAAS/ ETAAS	[27]
Se/human milk	Microwave digestion: HNO <sub>3</sub> + H <sub>2</sub> O <sub>2</sub>	FI-HGAAS	[112]
Cu, Fe, Zn/human milk	Microwave digestion: HNO <sub>3</sub> + H <sub>2</sub> O <sub>2</sub>	FASS	[113]
Pb/human milk	Slurries: Triton X-100 + Pd + HNO <sub>3</sub>	ETAAS	[114]
Ca, Mg/cheese	Dry ashing (525°C)	FAAS	[34]
Cr, Cu, Fe, Mn, Se, Zn/dairy products <sup>c</sup>	Slurries: Triton X-100	ETAAS	[115]
P/milk, infant formulas, skim milk powder <sup>a</sup> , nonfat milk powder <sup>a</sup> , whole milk powder <sup>a</sup>	Slurries: HNO <sub>3</sub> + H <sub>2</sub> O <sub>2</sub> + glucose + sucrose + KNO <sub>3</sub>	ETAAS	[65]

(continued)

**Table 26.7 (continued) Minerals and Trace Elements Determination in Milk and Dairy Products by Atomic Spectrometric Methods**

<i>Element/Food</i>	<i>Sample Treatment/Comments</i>	<i>Technique</i>	<i>Reference</i>
Ca, K, Mg, Na, P, Zn Al, Ba, Cu, I, Mn, Mo, Pb, Rb, Se, Sr/milk, nonfat milk <sup>a</sup> , whole milk <sup>a</sup>	Direct determination: dilution samples with water-soluble tertiary amines	ICP-AES ICP-MS	[26]
Fe/milk, whey milk, breast milk, <sup>b</sup> infant formulas <sup>b</sup>	Milk: dilution/without pretreatment  Whey milk without dilution: ultracentrifugation	FAAS  ETAAS <sup>b</sup>	[80]
Ca, Cu, Cr, Fe, Mg, Mn, Zn/milk powder <sup>a</sup>	Wet ashing: HNO <sub>3</sub> + H <sub>2</sub> O <sub>2</sub>  Dry ashing (480°C)	FAAS/ ETAAS	[116]
Mo/cow milk, breast milk, infant formulas, skim/nonfat, and whole milk powder <sup>a</sup>	Direct slurry: samples reconstituted with H <sub>2</sub> O <sub>2</sub> + HF  Preconcentration slurry: sample dilution with tetramethylammonium hydroxide  Adjusted pH 10.5/anion- exchange column (amberlite IRA 743)	ETAAS <sup>a</sup>	[23]
Al, Fe, Zn/yogurt and skim milk powder-BCR 151 <sup>a</sup>	(a) Dry ashing (Al, Zn)  (b) Wet ashing HNO <sub>3</sub> /H <sub>2</sub> O <sub>2</sub> (1:1) (Al, Zn)  (c) Microwave digestion (Al, Fe, Zn)	FAAS (N <sub>2</sub> O/ acetylene for Al)	[8]
Mg/milk and BCR 063 R <sup>a</sup>	(a) Wet ashing HNO <sub>3</sub> /HClO <sub>4</sub>  (b) Dry ashing AOAC 975.03 (550°C)  (c) Microwave digestion HNO <sub>3</sub>	FAAS	[117]
Al, Cr, Mn, Mo/milk	Slurry: sample + EtOH + HNO <sub>3</sub> + H <sub>2</sub> O <sub>2</sub>  NH <sub>4</sub> H <sub>2</sub> PO <sub>4</sub> as matrix modifier for Mn  Lactalbumin was added to the aqueous standards for Mo	ETAAS	[118]

**Table 26.7 (continued) Minerals and Trace Elements Determination in Milk and Dairy Products by Atomic Spectrometric Methods**

<i>Element/Food</i>	<i>Sample Treatment/Comments</i>	<i>Technique</i>	<i>Reference</i>
Pb, Hg/cow milk, human milk, infant formula	Wet ashing HNO <sub>3</sub>	ETAAS for Pb CV-AAS for Hg	[119]
Mn, Cr/milk products	Wet ashing HNO <sub>3</sub> -H <sub>2</sub> SO <sub>4</sub>	ETAAS	[120]
V/ Cow milk, infant formula	Preconcentration on graphite tube	ETAAS	[66]
Cd, Co, Cr, Cu, Fe, Ni, Pb/milk, cheese	Wet ashing (HNO <sub>3</sub> -HClO <sub>4</sub> -H <sub>2</sub> O <sub>2</sub> )  Slurry from milk, or freeze-dried cheese (HNO <sub>3</sub> -H <sub>2</sub> O <sub>2</sub> -Triton X-100)	ETAAS	[21]
Mn/human milk <sup>b</sup>	High-pressure ashing	ICP-AES ICP-AES + ICP-MS <sup>b</sup>	[76]
Ca, Cu, Fe, Mg, Mn, P, K, Na, Zn/infant formula	Wet ashing: HNO <sub>3</sub> + HClO <sub>4</sub> (AOAC: 984.27)	ICP-AES	[28]
Ca/human milk, cow milk, infant formulas <sup>c</sup>	Dry ashing (450°C)	FAAS	[121,122]
Fe, Cu, Zn/infant formulas <sup>c</sup>	Dry ashing (450°C)		[123]
Zn/infant formulas <sup>c</sup>	Dry ashing (450°C)		[124]
Ca, Fe, Zn/infant formulas <sup>c</sup>	Dry ashing (450°C)	FAAS	[125]
Ca, Cr, Cu, Fe, K, Mg, Mn, Na, P, Zn/dairy products	Wet digestion: HCl Dry ashing (450°C)	ICP-AES	[95]
Al, B, Ba, Ca, Co, Cr, Cu, Fe, K, Li, Mg, Mn, Mo, Na, Ni, P, S, Sb, Se, Sn, Sr, V, W, Zn/milk powder	Microwave digestion: HNO <sub>3</sub> + H <sub>2</sub> O <sub>2</sub>	ICP-AES	[96]
Al, Ca, Cd, Cu, Fe, K, Mg, Na, P, Pb S, Se, Zn/milk, cheese	Microwave digestion: HNO <sub>3</sub> + H <sub>2</sub> O <sub>2</sub>	ICP-AES	[126]
Zn, Cu Fe, Mn, Se/camel milk, cow milk, human milk, infant formulas	Wet digestion: HNO <sub>3</sub> + HClO <sub>4</sub>	FAAS ETAAS	[127]

(continued)



**Table 26.7 (continued) Minerals and Trace Elements Determination in Milk and Dairy Products by Atomic Spectrometric Methods**

<i>Element/Food</i>	<i>Sample Treatment/Comments</i>	<i>Technique</i>	<i>Reference</i>
Ca, Cd, Cu, Co, Cr, Fe, Na, Mg, Mn, Zn/herby dairy products	Dry ashing	AAS	[91]
Fe <sup>c</sup> /milk, dairy products, skim milk powder <sup>a</sup>	Wet digestion: HNO <sub>3</sub> + vanadium pentoxide + HClO <sub>4</sub>	ETAAS	[128]
Ca, Zn <sup>c</sup> /milk, infant formulas, dairy products	Dry ashing (450°C)	FAAS	[129,130]
Cu, Fe, Zn <sup>c</sup> /infant formulas	Microwave digestion: HNO <sub>3</sub> + H <sub>2</sub> O <sub>2</sub>	ICP-AES	[131]]
Cl, Br, I/milk	Microwave digestion: HNO <sub>3</sub> + H <sub>2</sub> O <sub>2</sub> + AgNO <sub>3</sub>  Precipitation of AgCl, AgBr, AgI  Redissolution with NH <sub>3</sub>	ICP-AES	[132]

<sup>a</sup> Standard reference materials (IS, Internal Standard).

<sup>b</sup> Speciation study.

<sup>c</sup> Bioavailability study.

eliminate the interfering polyatomic species by collisional dissociation and, mainly, by ion–molecule reactions. Helium is usually used as collision gas, while H<sub>2</sub>, NH<sub>3</sub>, Xe, and CH<sub>4</sub> are employed as possible reaction gases. The collision/dynamic reaction cell can also increase the ion transmission efficiencies by collision focusing [16,73]. In this sense, Ho and Jiang [72] have applied ultrasonic slurry sampling ETV reaction cell inductively coupled plasma mass spectrometry (ETV-RC-ICP-MS) to the determination of Cr, Zn, Cd, and Pb in milk powder samples. The slurry conditions (modifier, concentration, etc.), pyrolysis and vaporization temperatures, and RC-ICP-MS conditions have been optimized. De la Flor et al. [73] conducted a study to remove the spectral and nonspectral interferences in determining essential (Cr, Mn, Fe, Co, Cu, Zn, Se, and I) and toxic (Al, Cd, and Pb) elements in whole premature human breast milk, using quadrupole ICP-MS equipped with an octopole reaction cell. It was found that hydrogen was more efficient in reducing interference than helium as the reaction gas in the collision cell.

Haldimann et al. [74] proposed a new ICP-MS method for the determination of iodine in digests of nonfat and whole milk powder with nitric acid only, using a miniature cyclonic spray chamber and a concentric glass nebulizer that is designed for low sample uptakes and is operated in a self-aspirating mode. The wash-out was accelerated by this aspiration mode over conventional systems. The isotope dilution technique (<sup>129</sup>I) was applied to obtain freedom from matrix effects. The method was validated with reference material standard and by comparison with NAA.

The application of these techniques is shown in Table 26.8.

**Table 26.8 Minerals and Trace Elements Determination in Dairy Products by ICP-MS Methods**

<i>Element/Food</i>	<i>Sample Treatment/Comments</i>	<i>Determination Conditions</i>	<i>Reference</i>
Al, As, Co, Cr, Cu Fe, Mn, Ni, Sc, Ti, V Ag, Pt, Au, Pb/milk powder, <sup>a</sup> human milk, and infant formulas	Microwave wet digestion: HNO <sub>3</sub> + H <sub>2</sub> O <sub>2</sub>	HR-ICP-SFMS:	[70]
		Microconcentric nebulizer + membrane desolvation system Scott-type spray chamber, cooled to 4°C	
		Torch with Pt-guard electrode	
		Rf power: 1250W; plasma gas flow, 12 L/min; auxiliary gas flow, 0.9 L/min; sample gas flow, 1 L/min	
		Double focusing mass separator (magnetic and electric sector field)	
		Resolution settings ( $m/\Delta m = 400, 4000, 8000$ )	
		Ni sampler and skimmer cones: 1.1 mm and 0.8 mm id	
		Scans number 25; samples per peak: 50	
Al, Ca, Cd, Cr, Cu, Fe, Hg, Mg, Mn, Na, Ni, Pb, Se, Sr, Zn/skimmed milk powder, <sup>a</sup> whole milk, skimmed milk, milk whey of different milks (cow milk, human milk, infant formulas)	Microwave wet digestion: HNO <sub>3</sub> + H <sub>2</sub> O <sub>2</sub>	DF-ICP-MS:	[71]
		Meinhard (concentric nebulizer)	
		Rf power, 1240W; plasma gas flow, 15 L/min; auxiliary gas flow, 1.03 L/min; sample gas flow, 1.243 L/min	
		Ni sampler and skimmer cones	
		Double focusing mass separator (magnetic and electric sector field)	
		Resolution settings ( $m/\Delta m = 300, 3000, 7500$ )	
		Scans number 25; samples per peak: 30 ( $R = 3000$ ), 20 ( $R = 300$ )	
l/nonfat milk powder, <sup>a</sup> whole milk powder <sup>a</sup>	High-pressure asher-autoclave wet ashing: HNO <sub>3</sub>	ICP-MS	[74]
		Cinnabar mini-cyclonic spray chamber + micromist low-uptake nebulizer (concentric glass pneumatic nebulizer) vs. Scott spray chamber + slurry nebulizer	

(continued)

**Table 26.8 (continued) Minerals and Trace Elements Determination in Dairy Products by ICP-MS Methods**

<i>Element/Food</i>	<i>Sample Treatment/ Comments</i>	<i>Determination Conditions</i>	<i>Reference</i>
		Rf power, 1050W; plasma gas flow, 15 L/min; auxiliary gas flow, 0.8 L/min; sample gas flow, 1 L/min	
		Ni sampler and skimmer cones	
		Comparison with instrumental neutron activation analysis (INAA)	
Cr, Cd, Pb, Zn/milk powder <sup>a</sup> and whole milk powder	Ultrasonic slurry: ascorbic acid + Triton X-100 + HNO <sub>3</sub>	ETV-RC-ICP-MS	[72]
		ETV: 10 µL volume injection; 2500°C vaporization	
		RC, NH <sub>3</sub> cell gas; flow rate 0.4 mL/min; Rpa 0; Rpq 0.6	
		Rf power, 1100W; plasma gas flow, 15 L/min; auxiliary gas flow, 1.13 L/min; sample gas flow, 1.05 L/min	
		Pt sampler and skimmer cones	
Ca, Br, Cu, Fe, I, Mg, Mn, Sr, Zn/whey fractions of human milk, raw cow milk, UHT cow milk, and infant formulas <sup>b</sup>	Centrifugation (30,000g 60 min 5°C). Milk whey SEC	ICP QMS	[133]
		Meinhard (concentric nebulizer)	
		Double pass/Peltier spray chamber, cooled 2°C.	
		Rf power, 1300W; plasma gas flow, 14 L/min; auxiliary gas flow, 1 L/min; sample gas flow, 1 L/min	
		Ni sampler and skimmer cones	
As, Ca, Cu, Fe, K, Mg, Mn, Na, Pb, Se, Zn/Skim milk powder <sup>a</sup> and breast milk	Microwave wet digestion: HNO <sub>3</sub> + H <sub>2</sub> O <sub>2</sub>	ICP-MS	[134]
		Microconcentric nebulizer	
		Spray chamber 2°C	
		Rf power, 1350W; plasma gas flow, 14 L/min; auxiliary gas flow, 1 L/min; sample gas flow, 1 L/min	
		Ni sampler and skimmer cones	
Al, Cd, Cu, Co, Cr, Fe, I, Mn, Pb, Se, Zn/skimmed milk powder <sup>a</sup> and human milk	Microwave wet digestion: HNO <sub>3</sub> + H <sub>2</sub> O <sub>2</sub>	ICP-ORC-MS	[73]

**Table 26.8 (continued) Minerals and Trace Elements Determination in Dairy Products by ICP-MS Methods**

<i>Element/Food</i>	<i>Sample Treatment/Comments</i>	<i>Determination Conditions</i>	<i>Reference</i>
		Meinhard (concentric nebulizer)	
		Scott double pass/Peltier spray chamber, cooled 2°C	
		Rf power, 1500W; plasma gas flow, 15 L/min; auxiliary gas flow, 1.2 L/min; sample gas flow, 1.1 L/min	
		Ni sampler and skimmer cones: 1 mm and 0.4 mm id	
		RC, H <sub>2</sub> cell gas; flow rate 4 mL/min; octapole bias -13V; Qp bias -11.5V.	
l/nonfat milk powder <sup>a</sup>	Solid sample (0.5–2 g)	ETV-ICP-MS	[135]
		ETV: prerduced Pd (0.5 µg) (120°C/ 1000°C/ 20°C)/sample 0.5–2 g (120°C/ 700°C/2500°C/ 2700°C)	
		Interfaced to the argon plasma: 80 cm length (6 mm id) Teflon tubing.	
		Rf power, 1000W; plasma gas flow, 12 L/min; auxiliary gas flow, 1.2 L/min; sample gas flow, 1.1 L/min	
		Ni sampler and skimmer cones: 1.0 and 0.75 mm	
Li, Al, Ti, V, Cr, Mn, Fe, Co, Ni, Cu, Zn, As, Se, Rb, Sr, Y, Mo, Ag, Cd, In, Sn, U, Sb, Te, Cs, Ba, Hg, Pb, Bi, Th, La, Ce, Pr, Nd, Sm, Eu, Gd, Dy, Ho, Er, Tm, Yb, Lu, Hf, Ta/ nonfat milk powder, <sup>a</sup> cow milk, powdered milk	(a) Slurry sonication: aqua regia	ICP-MS	[136]
	(b) Microwave wet digestion: HNO <sub>3</sub> + H <sub>2</sub> O <sub>2</sub>	Cross flow nebulizer	
	(c) Direct analysis previous dilution with water.	Rf power, 1000–1200W; plasma gas flow, 14 L/min; auxiliary gas flow, 0.9 L/min; sample gas flow, 1.1 L/min	
	Comparison of digestion methods	Ni sampler and skimmer cones, 1.14 and 0.89 mm	

<sup>a</sup> Reference material standard.<sup>b</sup> Speciation studies.

### 26.3.10 Speciation

The first studies on the speciation of minerals in milk date from the late 1970s and early 1980s. In recent years, several studies on the speciation of mineral elements of nutritional interest (Ca, Cu, Cr, Fe, I, Mg, Mn, Mo, Se, and Zn) in milk have been published, mainly in human milk and infant formulas, and also comparisons have been made between human and cow milk. The hyphenated techniques such as liquid chromatography [RP, IE, and size exclusion chromatography (SEC)] jointly with detectors of the three major atomic spectrometric techniques—flame or ETAAS, NAA, ICP-AES, and ICP-MS—for trace element speciation in milk have been applied.

Mineral elements are added to infant formulas basically as inorganic salts, whereas in milk, these elements are bound to different compounds, which affects bioavailability. In order to ensure rational supplementation, breast milk is used as a reference to evaluate the nutritional content of infant formulas, assuming that the composition of breast milk may satisfy the growing demands of healthy infants during the early months of life. It is interesting to know how the highest breast milk bioavailability might depend on the distribution among the different milk proteins and how inorganic salts are found in infant formulas after being added.

Thus, the distribution of mineral elements in the fat fraction obtained by centrifugation or ultracentrifugation, and also in different fractions of fat globules, have been studied. In the same way, mineral speciation in different fractions of milk whey has been carried out. Protein fractions are separated/isolated by size-exclusion and IE chromatography with spectrophotometric detection at 280 nm. Dialysis and purification by SEC, HPLC are required if further separation by RP-HPLC is to be undertaken. Ultrafiltration using a 10 kDa cutoff filter is an alternative.

Casein (a mixture of  $\alpha$ -,  $\beta$ -, and  $\kappa$ -casein) and peptides released by enzymatic hydrolysis, lactoferrin, albumin, small complexes such as citrate and free amino acids can complex metal ions, and have been considered in the speciation studies.

As regards mineral determination, spectroscopic techniques, occasionally online with separation techniques, are the most widely used options because of their availability in most laboratories. HPLC-AAS reduces analysis time and sample size, and SEC HPLC with ICP-MS and ICP-AES detection are the principal analytical techniques used to study the speciation of trace elements in milk.

The main problems in mineral speciation are contamination, mineral losses, lack of stability of metal–protein complexes during the separation process, insufficient detection limits of the analyte element in the eluate, and identification problems [75]. Michalke and Schramel [76] suggested carrying out a quality control to avoid some distortions/alterations that can occur in metal speciation in milk, such as

- To use all contact surfaces of free metal to avoid contamination by simple contact and stainless steel for eluents.
- To carry out a mass balance to monitor losses, stability problems of species during the analytical procedure or identification problems.
- To use a series of standard proteins with different molecular weights, to calibrate the columns used in SEC, and clean these columns regularly.

A review of speciation analysis by hyphenated techniques has been published [75]. Separation mechanisms including size-exclusion, anion- and cation-exchange, and reversed-phase HPLC, and flat bed and capillary zone electrophoresis, are discussed. The advantages and the limitations of various element selective (e.g., AAS, ICP-AES, and ICP-MS) and molecule-specific (electrospray

MS/MS) detection techniques used on and off-line are commented. Attention is paid to sample preparation and the sources of error in bioinorganic speciation analysis.

An excellent review by Lobinski et al. [77] on the use of MS in bioinorganic analytical chemistry discusses recent developments in electrospray mass spectrometry (ESMS), ICP-MS, and matrix assisted laser desorption ionization (MALDI)-MS for metal speciation analysis.

Some studies as examples on the speciation of elements of nutritional interest in milk by using hyphenated techniques comprise the following:

1. Copper and Mn in milk by solid-phase extraction with a AG-1 X-8 anion-exchange column and a Chelex 100 cation-exchange column, elution with 2 M HCl, and detection by ICP-AES. The method separates cationic, anionic, and casein-bound Cu and Mn species [78].
2. The speciation of iodine species in milk and infant formulas by SEC with online selective detection by ICP-MS [79].
3. In breast milk and infant formulas, SEC coupled with ETAAS, FAAS, and hydride generation-ETAAS are used to speciate iron and copper, zinc, and selenium, respectively [80–83].
4. To determine the contents and protein binding of Ca, Cu, Fe, Mg, Mn, and Zn in human milk, SEC with ultrasonic nebulization ICP-MS is used [84].
5. Mn speciation in human milk using SEC combined with strong anion-exchange chromatography and ICP-MS/ICP-AES [76].
6. Speciation analysis of calcium, iron, and zinc in casein phosphopeptides fractions obtained by simulated gastrointestinal digestion from toddler milk-based formula by anion exchange and RP-HPLC and FAAS [85].
7. Iodine in three fractions (whey, fat, and caseins) of human milk and infant formulas using ICP-MS [6].
8. Speciation of Mo was studied in different protein fractions of cow and breast milk by a size exclusion-based separation procedure with Sephadex gel G25-150, and analyzed by ETAAS [65].

## 26.4 Conclusions

The key step in mineral element analysis in most of the techniques is sample preparation. Present and future practices tend toward minimal manipulation of samples, (e.g., in this sense, the analysis of slurries and determinations made in situ and online). The most widely used techniques for mineral determination of minerals in milk and dairy products are atomic absorption techniques, ICP-AES, and ICP-MS being the most reliable techniques for multielement analysis. Knowledge of the particular species in which a given element is present is very important, given that absorption and bioavailability depend on that particular chemical form—the hyphenated techniques being the most commonly used options for this purpose.

## References

1. Gaucheron, F. The mineral of milk, *Reprod. Nutr. Dev.*, 45, 474, 2005.
2. Rodríguez, E.M., Sanz, M., and Díaz, C. Mineral content in goats' milks, *J. Food Qual.*, 25, 343, 2002.
3. Haugh, A., Hostmark, A.T., and Harstad, O.M. Bovine milk in human nutrition—A review, *Lipids Health Dis.*, 6, 25, 2007.

4. Hiraoka, Y. et al.  $\alpha$ -Lactalbumin: A calcium metalloprotein, *Biochem. Biophys. Res. Commun.*, 95, 1098, 1980.
5. Renner, E., Schaafsma, G., and Scott, K.J. Micronutrients in milk, in *Micronutrients in Milk and Milk-Based Food Products*, Renner, E., Ed., Elsevier Applied Science, London, U.K., 1989, Chap. 1.
6. Fernández-Sánchez, L.M. et al. Determination of iodine in human milk and infant formulas, *J. Trace Elem. Med. Biol.*, 21, 10, 2007.
7. Gambelli, L. et al. Minerals and trace elements in some Italian dairy products, *J. Food Comp. Anal.*, 12, 27, 1999.
8. Yaman, M., Durak, M., and Bakirdere, S. Comparison of dry, wet, and microwave ashing methods for the determination of Al, Zn, and Fe in yogurt samples by atomic absorption spectrometry, *Spectrosc. Lett.*, 38, 405, 2005.
9. Scott, K.J. Micronutrients in milk products, in *Micronutrients in Milk and Milk-Based Food Products*, Renner, E., Ed., Elsevier Applied Science, London, U.K., 1989, Chap. 2.
10. Fresno, J.M. et al. Mineral content of some Spanish cheese varieties. Differentiation by source of milk and by variety from their content of main and trace elements, *J. Sci. Food Agric.*, 69, 339, 1995.
11. Kelly, S., Heaton, K., and Hoogewerff, J. Tracing the geographical origin of food: The application of multi-element and multi-isotope analysis, *Trends Food Sci. Technol.*, 16, 555, 2005.
12. Cataldi, T.R.I. et al. Ion-exchange chromatographic analysis of soluble cations, anions and sugars in milk whey, *Eur. Food Res. Technol.*, 216, 75, 2003.
13. Oliveira, E. Sample preparation for atomic spectroscopy: Evolution and future trends, *J. Braz. Chem. Soc.*, 14, 1, 2003.
14. Florian, D. and Knapp, G. High-temperature, microwave-assisted UV digestion: A promising sample preparation technique for trace element analysis, *Anal. Chem.*, 73, 1515, 2001.
15. Cava-Montesinos, P. et al. Determination of arsenic and antimony in milk by hydride generation atomic fluorescence spectrometry, *Talanta*, 60, 787, 2003.
16. De la Flor, R.R. et al. Total analysis and distribution of trace elements in human, cow and formula milk, in *The Determination of Chemical Elements in Food. Application for Atomic and Mass Spectrometry*, Caroli, S., Ed., Wiley-Interscience, a John Wiley & Sons Inc., New Jersey, 2007, Chap. 13.
17. Cava-Montesinos, P. et al. Hydride generation atomic fluorescence spectrometric determination of ultratracés of selenium and tellurium in cow milk, *Anal. Chim. Acta.*, 481, 291, 2003.
18. Alegría, A. et al. Effectiveness of microwave based digestion procedures for the demineralization of human milk and infant formulas prior to fluorometric determination of selenium, *Nahrung*, 40, 92, 1996.
19. Krushevska, A. et al. Comparison of sample decomposition procedures for the determination of zinc in milk by inductively coupled plasma atomic emission spectrometry, *J. Anal. At. Spectrom.*, 7, 851, 1992.
20. Alegría, A. et al. Inorganic Nutrients in *Handbook of Food Analysis*, 2nd ed., Vol. 1, Nollet, L.M.L., Ed., Marcel Dekker Inc., New York, 2004, Chap. 21
21. Karadjova, I. et al. Determination of Cd, Co, Cr, Cu, Fe, Ni and Pb in milk, cheese and chocolate, *Mikrochim. Acta*, 134, 185, 2000.
22. Cal-Prieto, M.J. et al. Slurry sampling for direct analysis of solid materials by electrothermal atomic absorption spectrometry (ETAAS). A literature review from 1990 to 2000, *Talanta*, 56, 1, 2002.
23. López-García, I. et al. Liquid chromatography-electrothermal atomic absorption spectrometry for the separation and preconcentration of molybdenum in milk and infant formulas, *Anal. Chim. Acta*, 597, 187, 2007.
24. Cava-Montesinos, P. et al. Determination of As, Sb, Se, Te, and Bi in milk by slurry sampling hydride generation atomic fluorescence spectrometry, *Talanta*, 62, 175, 2004.
25. Aleixo, P.C. and Nóbrega, J.A., Direct determination of iron and selenium in bovine milk by graphite furnace atomic absorption spectrometry, *Food Chem.*, 83, 457, 2003.
26. Nóbrega, J.A. et al. Direct determination and trace elements in milk by inductively coupled plasma atomic emission and mass spectrometry, *J. Anal. At. Spectrom.*, 12, 1243, 1997.

27. Ruiz, C. et al. Direct determination of calcium, magnesium, sodium, potassium and iron in infant formulas by atomic spectroscopy. Comparison with dry and wet digestion methods, *Nahrung*, 39, 497, 1995.
28. AOAC, *Official Methods of Analysis of AOAC International*, 17th ed., Vols. 1 and II, Horwitz, W., Ed., Gaithersburg, MD, AOAC, 2002.
29. Kindstedt, P.S. and Kosikowski, F.V. Improved complexometric determination of calcium in cheese, *J. Dairy Sci.*, 68, 806, 1985.
30. Burakham, R., Srijaranai, S., and Grudpan, K. High-performance liquid chromatography with sequential injection for online precolumn derivatization of some heavy metals, *J. Sep. Sci.*, 30, 2614, 2007.
31. Pulliainen, T.K., and Wallin, H.C. Determination of total phosphorus in foods by colorimetric measurement of phosphorus as molybdenum blue after dry-ashing: NMKL Interlaboratory Study, *J. AOAC Int.*, 77, 1557, 1994.
32. Reis, M.J., Fernandes, S.M.V., and Rangel, A.O.S.S. Colorimetric determination of phosphorus in milk by flow injection analysis using a thermal/UV induced digestion, *Ital. J. Food Sci.*, 14, 9, 2002.
33. Reis, M.J., Fernandes, S.M.V., and Rangel, A.O.S.S. A sequential injection system for the in-line digestion and colorimetric determination of phosphorus in milk, *J. Food Sci.*, 67, 3280, 2002.
34. Pollman, R.M. Atomic absorption spectrophotometric determination of calcium and magnesium and colorimetric determination of phosphorus in cheese: Collaboratory study, *J. Assoc. Off. Anal. Chem.*, 74, 27, 1991.
35. Miquel, E. et al. Microdetermination of phosphorus from infant formulas, casein and casein phosphopeptides, *Eur. Food Res. Technol.*, 219, 639, 2004.
36. De la Fuente, M.A. and Juarez, M. Determination of phosphorus in dairy products by sample wet digestion in a microwave oven, *Anal. Chim. Acta*, 309, 355, 1995.
37. Garwin, J.L., Rosenholtz, N.S., and Abdollahi, A. Two colorimetric assays for iodine in foods, *J. Food Sci.*, 59, 1135, 1994.
38. Siong, T.E., Choo, K.S., and Shahid, S.M. Determination of iron in foods by the atomic absorption spectrophotometric and colorimetric methods, *Pertanika*, 12, 313, 1989.
39. Lima, J.L.F.C., Delerue-Matos, C., and Vaz, M.C.V.F. Automation of iron and copper determination in milks using FIA systems and colorimetric detection, *Food Chem.*, 62, 117, 1998.
40. Afkami, A., Madrakian, T., and Abbasi-Tarighat, M. Simultaneous determination of calcium, magnesium and zinc in different foodstuffs and pharmaceutical samples with continuous wavelet transforms, *Food Chem.*, 109, 660, 2008.
41. Capitán-Vallvey, L.F. et al. Calcium selective test strip for water and milk, *Analyst*, 129, 783, 2004.
42. Tinggi, U., Reilly, C., and Patterson, C.M. Determination of selenium in foodstuffs using spectrofluorometry and hydride generation atomic absorption spectrometry, *J. Food Comp. Anal.*, 5, 269, 1992.
43. Conti, E.T. Use of nuclear techniques for the measurement of trace elements in foods, *J. Radioanal. Nucl. Chem.*, 243, 53, 2000.
44. Zikovskiy, I. and Soliman, K. Neutron activation analysis of cheese, eggs, fish, fowl and meats, *J. Radioanal. Nucl. Chem.*, 251, 507, 2002.
45. Zikovskiy, I. and Soliman, K. Determination of daily intakes of Br, Ca, Cl, Co and K in food in Montreal, Canada, by neutron activation analysis, *J. Radioanal. Nucl. Chem.*, 247, 171, 2001.
46. Chatt, A. et al. Determination of trace elements in foods by neutron activation analysis, *J. Radioanal. Nucl. Chem.*, 124, 65, 1988.
47. Nielson, K.K., Mahoney, A.W., and Rogers, V.C. X-ray fluorescence and atomic absorption spectrophotometry measurements of manganese, iron, copper, and zinc in selected foods, *J. Agric. Food Chem.*, 36, 1211, 1988.
48. Nielson, K.K. et al. Mineral concentrations and variations in fast-food samples analyzed by X-ray fluorescence, *J. Agric. Food Chem.*, 39, 887, 1991.
49. Perring, L. and Andrey, D. ED-XRF as a tool for rapid minerals control in milk-based products, *J. Agric. Food Chem.*, 51, 4207, 2003.



50. Perring, L. and Andrey, D. Wavelength-dispersive x-ray fluorescence measurements on organic matrices: Application to milk-based products, *X-Ray Spectrom.*, 33, 128, 2004.
51. Perring, L. et al. Rapid quantification of iron, copper and zinc in food premixes using energy dispersive x-ray fluorescence, *J. Food Comp. Anal.*, 18, 655, 2005.
52. Blanc J., Populaire, S., and Perring, L. Rapid identification of inorganic salts using energy dispersive x-ray fluorescence, *Anal. Sci.*, 21, 795, 2005.
53. Park, O., Swaisgood, H.E., and Allen, J.C. Calcium binding of phosphopeptides derived from hydrolysis of a  $\alpha_s$ -casein or  $\beta$ -casein using immobilized trypsin, *J. Dairy Sci.*, 81, 2850, 1998.
54. Canabady-Rochelle, L.S. et al. Influence of calcium salt supplementation on calcium equilibrium in skim milk during pH cycle, *J. Dairy Sci.*, 90, 2155, 2007.
55. Izquierdo, A., Luque de Castro, M.D., and Valcárcel, M. Automatic simultaneous determination of copper and lead in biological samples by flow injection/stripping voltammetric analysis, *J. Automat. Chem.*, 15, 121, 1993.
56. Barberá, R. et al. A DPCSV method for the determination of nickel in infant formulas, *Food Chem.*, 49, 427, 1994.
57. Tokusoglu, O. et al. Simultaneous differential pulse polarographic determination of cadmium, lead, and copper in milk and dairy products, *J. Agric. Food Chem.*, 52, 1795, 2004.
58. Muñoz, E. and Palmero, S. Determination of heavy metals in milk by potentiometric stripping analysis using a home-made flor cell, *Food Control*, 15, 635, 2004.
59. Pournaghi-Azar, M.H. and Ramazani, M.R. Selective determination of trace copper by extraction-anodic stripping voltammetry of copper (II) acetylacetonate in nonaqueous media, *Electroanalysis*, 14, 1203, 2002.
60. Buldini, P.L., Cavalli, S., and Sharma, J.L. Matrix removal for the ion chromatographic determination of some trace elements in milk, *Microchem. J.*, 72, 277, 2002.
61. Buldini, P.L., Cavalli, S., and Trifirò, A. State-of-the-art ion chromatographic determination of inorganic ions in food, *J. Chromatogr. A*, 789, 529, 1997.
62. Hejtmánková, A. et al. Iodine concentrations in cow's milk in Central and Northern Bohemia, *Čzech J. Anim. Sci.*, 51, 189, 2006.
63. Bermejo, P., Dominguez, R., and Bermejo, A. Direct determination of Fe and Zn in different components of cow milk by FAAS with a high performance nebulizer, *Talanta*, 45, 325, 1997.
64. Alegría, A. et al. GFAAS determination of selenium in infant formulas using a microwave digestion method, *Nahrung*, 38, 382, 1994.
65. López-García, I. et al. Fast determination of phosphorus in honey, milk and infant formulas by electrothermal atomic absorption spectrometry using a slurry sampling procedure, *Spectrochim. Acta B*, 62, 48, 2007.
66. Bermejo-Barrera, A. et al. Vanadium determination in milk by atomic absorption spectrometry with thermal atomisation using hot injection and preconcentration on the graphite tube, *J. Anal. Atom Spectrom.*, 15, 435, 2000.
67. Oliveira, A.P. et al. Determination of selenium in nutritionally relevant foods by graphite furnace atomic absorption spectrometry using arsenic as internal standard, *Food Chem.*, 93, 355, 2005.
68. Muñoz-Naveiro, O. et al. Determination of total selenium and selenium distribution in the milk phases in commercial cow's milk by HG-AAS, *Anal. Bioanal. Chem.*, 381, 1145, 2005.
69. Foster, I.H. and Sumar, S. Methods of analysis used for the determination of selenium in milk and infant formulae: A review, *Food Chem.*, 53, 453, 1995.
70. Prohaska, T. et al. Determination of trace elements in human milk by inductively coupled plasma sector field mass spectrometry (ICP-SFMS), *J. Anal. At. Spectrom.*, 15, 335, 2000.
71. Rivero Martino, F.A. et al. The potential of double focussing-ICP-MS for studying elemental distribution patterns in whole milk, skimmed milk and milk whey of different milks, *Anal. Chim. Acta*, 442, 191, 2001.
72. Ho, C.Y. and Jiang, S.J. Determination of Cr, Zn, Cd and Pb in milk powder by slurry sampling electrothermal vaporization inductively coupled plasma mass spectrometry, *J. Anal. At. Spectrom.*, 17, 688, 2002.

73. De la Flor, R.R. et al. Determination of essential and toxic total elements in premature human milk by inductively coupled plasma mass spectrometry (ICP-ORC-MS), using an octopole reaction cell, *J. Anal. At. Spectrom.*, 19, 616, 2004.
74. Haldimann, M. et al. Improved measurement of iodine in food samples using inductively coupled plasma isotope dilution mass spectrometry, *Analyst*, 125, 1977, 2000.
75. Szpunar, J. Bio-inorganic speciation analysis by hyphenated techniques, *Analyst*, 125, 963, 2000.
76. Michalke, B. and Schramel, P. Manganese speciation in human milk using size exclusion chromatography combined with strong anion exchange chromatography and inductively coupled plasma mass spectrometry detection, *J. Anal. At. Spectrom.*, 19, 121, 2004.
77. Lobinski, R., Schaumlöffel, D., and Szpunar, J. Mass spectrometry in bioinorganic analytical chemistry, *Mass Spectrom. Rev.*, 25, 255, 2006.
78. Abollino, O. et al. Speciation of copper and manganese in milk by solid-phase extraction/inductively coupled plasma-atomic emission spectrometry, *Anal. Chim. Acta.*, 375, 299, 1998.
79. Sánchez, L.F. and Spuznar, J. Speciation analysis for iodine in milk by size-exclusion chromatography with inductively coupled plasma mass spectrometric detection (SEC-ICP MS), *J. Anal. At. Spectrom.*, 14, 1697, 1999.
80. Bermejo, P. et al. Speciation of iron in breast milk and infant formulas whey by size exclusion chromatography-high performance liquid chromatography and electrothermal atomic absorption spectrometry, *Talanta*, 50, 1211, 2000.
81. Bermejo, P. et al. Copper fractionation by SEC-HPLC and ETAAS: Study of breast milk and infant formulae whey used in lactation of full-term newborn infants, *Analyst*, 126, 571, 2001.
82. Bermejo, P. et al. Speciation of zinc in low molecular weight proteins of breast milk and infant formulas by size exclusion chromatography/flame atomic absorption spectroscopy, *J. AOAC. Int.*, 84, 847, 2001.
83. Bermejo, P. et al. Determination of selenium in infant formulas whey fractions by SEC-HPLC-HG-ETAAS, *J. Anal. At. Spectrom.*, 16, 188, 2001.
84. Bocca, B. et al. Determination of the total content and binding pattern of elements in human milk by high performance liquid chromatography-inductively coupled plasma atomic emission spectrometry, *Talanta*, 53, 295, 2000.
85. Miquel, E. et al. Speciation analysis of calcium, iron and zinc in casein phosphopeptides fractions from toddler milk based formula by anion exchange and reversed phase high performance liquid chromatography-mass spectrometry/flame atomic absorption spectroscopy, *Anal. Bioanal. Chem.*, 381, 1082, 2005.
86. Le Meur, J.F., Le Noursand, H., and Senechal, M. Selective determination of calcium and magnesium by pH-Stat complexometric titration, *Analisis*, 17, 405, 1989.
87. Borus-Böszörményi, N. and Kovács, J. Complexometric method combined with precipitation by oxalate for the determination of the calcium content of samples of diverse origin, *Elelmiszervizsgálati-Közlemények*, 22, 93, 1976.
88. Rao, D.S. et al. Successive complexometric estimation of iron and copper in milk by constant potential amperometry, *J. Food Sci. Technol.*, 28, 164, 1991.
89. Alvarez, M.D. et al. Determination of calcium and magnesium in milk by complexometric titration using protein precipitation and complexation with palladizo or others indicators, *Analyst*, 113, 633, 1988.
90. Akl, M.A. Preconcentration extractive separation, speciation and spectrometric determination of iron (III) in environmental samples, *Microchem. J.*, 75, 199, 2003.
91. Tarakci, Z. and Kucukoner, E. Comparison of basic nutrients, mineral and heavy metal contents of herby dairy products, *Int. J. Food Sci. Technol.*, 43, 216, 2008.
92. Shingh, I., Poonam, M.R.S., and Kadyan, P.S. Spectrophotometric determination of iron and copper in milk foodstuffs and body tissues with 1-(2-Quinolylazo)-2,4,5-Trihydroxybenzene, *Talanta* 32, 387, 1985.
93. Alegría, A. et al. Selenium content of infant formulas and estimation of the intake of bottle fed infants, *Nahrung*, 39, 237, 1995.

94. McDowell, L.S., Giffen, P.R., and Chatt, A. Determination of selenium in individual food items using the short-lived nuclide  $^{77m}\text{Se}$ , *J. Radioanal. Nucl. Chem.*, 110, 519, 1987.
95. Kira, C.S. and Maihara, V.A. Determination of major and minor elements in dairy products through inductively coupled plasma optical emission spectrometry after wet partial digestion and neutron activation analysis, *Food Chem.*, 100, 390, 2007.
96. Sroor, A. et al. Major and trace element analysis in milk powder by inductively coupled plasma-optical emission spectrometry (ICP-OES) and instrumental neutron activation analysis (INAA), *J. Environ. Sci.*, 15, 570, 2003.
97. Khan, A.H. et al. The status of trace and minor elements in some Bangladeshi foodstuffs, *J. Radionucl. Nucl. Chem.*, 134, 367, 1989.
98. Alvarez, M. and Mazo-Gray. Determination of potassium and calcium in milk powder by energy-dispersive X-ray fluorescence spectrometry, *X-Ray Spectrom.*, 19, 285, 1990.
99. Alvarez, M. and Mazo-Gray. Determination of trace elements in organic specimens by energy-dispersive X-ray fluorescence using a fundamental parameters method, *X-Ray Spectrom.*, 20, 67, 1991.
100. Uson, S., Immoos, C., and Jiménez-Flores, R. Validation of ED-XRF as a reliable method for determining the mineral composition of skim milk powders, *J. Anim. Sci.*, Suppl. 89, 177, 2006.
101. Esteve, M.J., Farré, R., and Frigola, A. Determination of Cd, Cu, Pb and Zn content of infant formulas by differential pulse anodic stripping voltammetry (DPASV), *Nahrung*, 38, 386, 1994.
102. Guillain, G. and Rutagengwa, J. Determination of Zn, Cd, Pb, Cu, Sb, and Bi in milk by differential pulse anodic stripping voltammetry with a hanging mercury drop electrode following two independent mineralization methods, *Analisis*, 13, 471, 1985.
103. Inam, R. and Somer, G. A Direct method for the determination of selenium and lead in cow's milk by differential pulse stripping voltammetry, *Food Chem.*, 69, 345, 2000.
104. Filichkina, O.G., Zakharova, E.A., and Slepchenko, G.B. Determination of selenium in foodstuffs by cathodic stripping voltammetry at a mercury-graphite electrode, *J. Anal. Chem.*, 59, 541, 2004.
105. Hermansen, J.E. et al. Major and trace elements in organically or conventionally produced milk, *J. Dairy Res.*, 72, 362, 2005.
106. Coni, E. et al. A methodological approach to the assessment of trace elements in milk and dairy products, *Food Chem.*, 50, 203, 1994.
107. Coni, E. et al. Preliminary evaluation of the factors influencing the trace element content of milk and dairy products, *Food Chem.*, 52, 123, 1995.
108. Coni, E. et al. Minor and trace element content in sheep and goat milk and dairy products, *Food Chem.*, 57, 253, 1996.
109. Muñoz-Naveiro, O. et al. Study of the bioavailability of selenium in cows' milk after a supplementation of cow feed with different forms of selenium, *Anal. Bioanal. Chem.*, 385, 189, 2006.
110. Cava-Montesinos, P. et al. Speciation of selenium and tellurium in milk by hydride generation atomic fluorescence spectrometry, *J. Anal. At. Spectrom.*, 19, 696, 2004.
111. García, E.M. et al. Trace element determination in different milk slurries, *J. Dairy Res.*, 66, 569, 1999.
112. Alegría, A. et al. Optimization of selenium determination in human milk and whole blood by flow injection hydride atomic absorption spectrometry, *J. AOAC Int.*, 81, 457, 1998.
113. Silvestre, M.D. et al. Copper, iron and zinc determinations in human milk using FAAS with microwave digestion, *Food Chem.*, 68, 95, 2000.
114. Falomir, P. et al. Direct determination of lead in human milk by electrothermal atomic absorption spectrometry, *Food Chem.*, 64, 111, 1999.
115. Cabrera, C. et al. Chromium, copper, iron, manganese, selenium and zinc levels in dairy products: In vitro study of absorbable fractions, *Int. J. Food Sci. Nutr.*, 47, 331, 1996.
116. Miller-Ihli, N.J. Trace element determination in foods and biological samples using inductively coupled plasma atomic emission spectrometry and flame atomic absorption spectrometry, *J. Agric. Food Chem.*, 44, 2675, 1996.

117. Moreno-Torres, R. et al. A mineralization procedure for determining magnesium in milk, *Lebensm Wiss u. Technol.*, 33, 397, 2000.
118. Viñas, P. et al. Electrothermal atomic absorption spectrometric determination of molybdenum, aluminium, chromium and manganese in milk, *Anal. Chim. Acta*, 356, 267, 1997.
119. Gundacker, C. et al. Lead and mercury in breast milk, *Pediatrics*, 110, 873, 2002.
120. Tinggi, U., Reilly, C., and Patterson, C. Determination of manganese and chromium in foods by atomic absorption spectrometry after wet digestion, *Food Chem.*, 60, 123, 1997.
121. Roig, M.J. et al. Calcium bioavailability in human milk, cow milk and infant formulas—Comparison between dialysis and solubility methods, *Food Chem.*, 65, 353, 1999b
122. Roig, M.J. et al. Calcium dialysability as an estimation of bioavailability of human milk, cow milk and infant formulas, *Food Chem.*, 64, 403, 1999a
123. Garcia, R. et al. Dialysability of iron, zinc, copper of different types of infant formulas marketed in Spain, *Biol. Trace Elem. Res.*, 65, 1, 1998.
124. Guillem, A. et al. In vitro zinc dialysability of zinc salts added to milk and soy based infant formulas, *Biol. Trace Elem. Res.*, 72, 11, 2000.
125. Jovaní, M. et al. Calcium, iron and zinc uptake from digests of infant formulas by caco-2 cells, *J. Agric. Food Chem.*, 49, 3480, 2001.
126. Lante, A. et al. Content and characterisation of minerals in milk and in Crescenza and Squacquerone italian fresh cheeses by ICP-OES, *Food Control*, 17, 229, 2006.
127. Al-Awadi, F.M. and Srikumar, T.S. Trace elements and their distribution in protein fractions of camel milk in comparison to other commonly consumed milks, *J. Dairy Res.*, 68, 463, 2001.
128. Pérez, A. et al. Influence of enrichment with vitamins and minerals on the bioavailability of iron in cows' milk, *J. Dairy Res.*, 69, 473, 2002.
129. Perales, S. et al. Bioavailability of calcium from milk-based formulas and fruit juices containing milk and cereals estimated by in vitro methods (solubility, dialyzability, and uptake and transport by Caco-2 cells), *J. Agric. Food Chem.*, 53, 3721, 2005.
130. Perales, S. et al. Bioavailability of zinc from infant foods by in vitro methods (solubility, dialyzability and uptake and transport by Caco-2 cells), *J. Sci. Food Agric.*, 86, 971, 2006.
131. Dominguez, R. et al. Study of the effect of different iron salts used to fortify infant formulas on the bioavailability of trace elements using ICP-OES, *Int. Dairy J.*, 14, 1081, 2004.
132. Naozuka, J. et al. Determination of chlorine, bromine and iodine in milk samples by ICP-OES, *J. Anal. At. Spectrom.*, 18, 917, 2003.
133. Rivero Martino, F.A. et al. Multi-elemental fractionation in milk whey by size exclusion chromatography coupled on line to ICP-MS, *J. Anal. At. Spectrom.*, 17, 1271, 2002.
134. Yang, L. et al. Minor and trace element analysis in breast milk using inductively coupled plasma mass spectrometry (ICP-MS), *Microchim. Acta*, 142, 85, 2003.
135. Resano, M. et al. Solid sampling-electrothermal vaporization-inductively coupled plasma mass spectrometry for the direct determination of traces of iodine, *J. Anal. At. Spectrom.*, 20, 81, 2005.
136. Cava-Montesinos, P. et al. Room temperature acid sonication ICP-Ms multielemental analysis milk, *Anal. Chim. Acta*, 531, 111, 2005.



---

# **SENSORY QUALITY**

---

**IV**



# Chapter 27

---

## Color

---

Laurent Dufossé and Patrick Galaup

### CONTENTS

27.1	Introduction .....	582
27.2	Description of the Techniques in Use in Dairy Food Color Analysis .....	583
27.2.1	Color Determination Using Traditional Laboratory Visible Spectrophotometers .....	583
27.2.2	Visible and Near-Infrared Reflectance (VNIR) Spectrophotometry .....	583
27.2.3	Tristimulus Colorimetry.....	584
27.2.4	Spectrophotometers Dedicated to Color Analysis .....	584
27.2.5	Color Chart or Color Fan .....	585
27.2.6	Computer Vision, Digital Scanning, and Image Analysis .....	585
27.2.7	High-Performance Liquid Chromatography (HPLC) of Pigments .....	585
27.3	Practical Applications in Dairy Foods Analysis .....	586
27.3.1	Anteprocessing (i.e., Milk Production Related to Cattle/Cow Feeding) .....	586
27.3.2	Processing.....	588
27.3.2.1	Butter.....	588
27.3.2.2	Cheese-Making Process .....	589
27.3.2.3	Use of Technologies Such as High-Pressure Processing or Ultrafiltration.....	589
27.3.2.4	Modification of Dairy Food Composition (Substitution of Milk Powder by Whey Powder or Soy Proteins, Use of Fat Replacers, Addition of Chitosan or Orange' Fibers...) .....	590
27.3.2.5	Studies about the Whiteness of Mozzarella or Browning of the Same Cheese When Used in Pizza .....	591



27.3.2.6	Role of the Microflora in the Development of Color at the Surface of Soft Cheeses .....	591
27.4	Postprocessing .....	594
27.5	Quality Control.....	595
27.6	Conclusion .....	598
	References .....	599

## 27.1 Introduction

Even when we just look around, a wide variety of colors leap into our eyes. We are surrounded by an infinite variety of colors in our daily lives. An average person can distinguish as many as 350,000 different colors, among which are 5,000 distinguishable white colors, but the number of basic color terms is confined to not more than 11 basic expressions, regardless of cultures or languages [1]. However, unlike length or weight, there is no physical scale for measuring color, making it unlikely that everyone will answer in the same way when asked what a certain color is. For example, if we say “yellow butter” or “yellow cheddar” to people, each individual will imagine different yellow colors, because their color sensitivity and past experiences will be different. This is the problem with color [2].

Color is an important component of quality throughout the agricultural and food industries. Because color is closely associated with factors such as freshness, ripeness, desirability, and food safety, it is often a primary consideration for consumers when making purchasing decisions. For such reasons, color is an important grading factor of most food products. Color is also a criterium that could be monitored during production of milk related to animal feeding, processing of dairy products, or monitoring of such products during the shelf life.

Consumers rely primarily upon their vision to evaluate product color. Because color perception differs from person to person, and depends upon lighting and numerous other factors, many industries rely on human vision coupled with an instrumental system of color measurement. These instruments attempt to simulate the manner in which the average human eye sees the color of an object, under specified illumination conditions, and provide a quantitative measurement. The reflected spectral data are transformed or filtered to provide reproducible color values in accordance with the standards developed by the Commission Internationale de l'Éclairage (CIE). In the agricultural and food industries the most popular numerical color-space system is the  $L^*a^*b^*$ , which is also referred to as the CIELAB system, originally defined by the CIE in 1976 [3] ( $L^*$  indicates lightness and  $a^*$  and  $b^*$  are the chromaticity coordinates).

Hue, lightness, saturation, the world of color is a mixture of these attributes. Hue: butter is yellow, cheddar is orange, *Penicillium*-veined cheese is partly blue-green ... that is how we think of color in every day language. Hue is the term used in the world of color for the classifications of red, yellow, blue... The continuum of these hues results in a color wheel. Lightness: colors can be separated into bright and dark colors when their lightnesses (how bright they are) are compared. This lightness can be measured independently of hue. Saturation: vivid colors, dull colors, this attribute is completely separate from those of both hue and lightness.

The first part of this chapter presents a description of the techniques in use in dairy food color analysis. Then practical applications of color measurements are presented in anteprocessing (i.e., color of milk related to cattle feeding), processing (e.g., butter, cheese), postprocessing, and quality control of dairy food products.

## 27.2 Description of the Techniques in Use in Dairy Food Color Analysis

An object absorbs part of the light from the light source and reflects the remaining light. This reflected light enters the human eye, and the resulting stimulation of the retina is recognized as the object's "color" by the brain. Each object absorbs and reflects light from different portions of the spectrum and in different amounts; these differences in absorbance and reflectance are what make the colors of different objects different.

### 27.2.1 Color Determination Using Traditional Laboratory Visible Spectrophotometers

When a material is illuminated by light, specific wavelengths are absorbed depending on the molecular structure present. This is caused by electrons in the ground-state molecule absorbing light energy and moving to an excited state. The absorption intensity depends on the wavelength and the absorption spectrum (curve measuring absorption intensity changes accompanying wavelength changes for monochromatic light illuminating a material) is characteristic of a specific material.

Restricted to liquids, the color measurements are usually made on a UV–vis diode array spectrophotometer by using quartz cuvettes (width of cuvettes is subject to variation to prevent the apparatus from saturating). The entire visible spectra (380–770 nm) at 2 nm intervals are measured and recorded after zeroing the apparatus. The selection of the blank reference, which is of paramount importance to achieve a meaningful color specification, should be made very carefully. Absorbance values are then related to 10 nm bandwidths and subsequently referred to into transmittance. In conformity with the weighed-ordinate method, the transmittances of the samples along the spectrum are weighed considering the features of the visual reference conditions chosen: Standard Illuminant D65 (related to a color temperature of 6504 K) and CIE 1964 Standard Observer (vision angle of 10°) to obtain the tristimulus values. Furthermore, the color parameters more related to the psychophysical characteristics of color, which correspond to the angular coordinates of  $L^*a^*b^*$  (CIELAB) color space, i.e., lightness ( $L^*$ ), chroma ( $C^*ab$ ), and hue ( $h_{ab}$ ), are also calculated and taken into account. The calculations necessary to obtain all the relevant color parameters could be performed by means of softwares such as CromaLab® [4].

### 27.2.2 Visible and Near-Infrared Reflectance (VNIR) Spectrophotometry

Near-infrared reflectance (NIR) spectrophotometers are widely used throughout the food and agricultural industries [5] to measure chemical constituents such as protein, oil, starch, fiber, and moisture. NIR has been used to assess chemical quality of food products for which color is important. Approximately 20 years ago, NIR instruments became available with extended spectral range which included the visible region (VNIR instruments). The visible region allowed for the measurement of pigments such as carotenoids by measuring absorbances (reflectances) at specific wavelengths associated with the pigments. Although these analyses quantified the pigments that contributed to the color of the product, they did not provide the actual color of the product being examined. The feasibility of using a VNIR instrument to measure color, in accordance with the principles of the CIE, was then demonstrated, in comparison to the color values obtained from a colorimeter specifically designed to provide

color-space values. The VNIR instruments have excellent potential to provide color information to complement the biochemical information normally provided by the NIR region. To facilitate this in an efficient manner, the calculations should be incorporated as part of a standard software package, which would eliminate the tedious requirement to export the spectral data for each sample to a supplemental spreadsheet. The software should also provide a means of calibrating the color data to a set of standards. This calibration process for color would be quite distinct from the calibration normally associated with NIR work. The color calibration would primarily involve correcting the calculated  $L^*a^*b^*$  values for slight differences in optics and geometry among instruments, and would only need to be done occasionally with a set of color standards fitted to the appropriate sample cells. The software should also include the ability to provide  $L^*a^*b^*$  values based on different illuminants, and facilitate conversions to other color-space systems. Using VNIR instruments in this manner provides an efficient means of simultaneously providing chemical and color quality information about dairy products [6].

### **27.2.3 Tristimulus Colorimetry**

Although the human eye cannot quantify colors accurately, with a colorimeter it is simple. As seen previously, unlike the subjective expressions commonly used by people to describe colors verbally, colorimeters express colors numerically according to international standards. By expressing colors in this way, it makes it possible for anyone to understand what color is being expressed. Further, a person's perception of a single color may change depending on the background or on the light source illuminating the color. Colorimeters have sensitivities corresponding to those of the human eye, but because they always take measurements using the same light source and illumination method, the measurement conditions will be the same, regardless of whether it is day or night, indoors or outdoors. This makes accurate measurements simple [7]. The colorimeter is mainly used in production and inspection applications for the color difference measurements. Minute color differences can be expressed numerically and easily understood. In the  $L^*a^*b^*$  color space, color difference can be expressed as a single numerical value,  $\Delta E^*ab$ , which indicates the size of the color difference but not in what way the colors are different.

A tristimulus colorimeter is a combination of a sensor and a microcomputer. The "sensor" is a set of three filtered sensors to have nearly the same color sensitivity as the human eye [8]. They receive light from the object and transmit information to the microcomputer. The latter then determines numerical values that are delivered to the user.

A related problem is if, for example, the colors of two objects appeared to be the same under daylight but appeared to be different under indoor room lighting. Such a phenomenon, in which two colors appear the same under one light source but different under another, is called metamerism. For metameric objects, the spectral reflectance characteristics of the colors of the two objects are different, but the resulting tristimulus values are the same under one light source and different from each other under another. Tristimulus colorimeters can generally take measurements under only Standard Illuminant C and Standard Illuminant D65, both of which represent daylight and which have very similar spectral power distributions; because of this, tristimulus colorimeters cannot be used to measure metamerism.

### **27.2.4 Spectrophotometers Dedicated to Color Analysis**

In addition to displaying numerical color data, a spectrophotometer can also display a graph of the color's spectral reflectance (colors are created by mixing various wavelengths of light in appropriate

proportions). A spectrophotometer measures the light reflected from the object at each wavelength or in each wavelength range (up to 40 sensors); this data can then be displayed on a graph to provide more detailed information about the nature of the color. This device is used for high-precision analysis and accurate color management mainly in laboratories, and research and development applications. The spectrophotometer, on the other hand, is equipped with the spectral power distributions of a wide range of illuminants and thus can determine metamerism. Moreover, with the spectrophotometer's capability to display spectral reflectance graphs, you can see exactly how the spectral reflectances of the two colors are different.

### **27.2.5 Color Chart or Color Fan**

Color charts are well known in industries such as painting, home design, and car building but also in the food industry. For example these are used for determination of the color of egg yolk, salmon flesh... (Figure 27.1). The charts could be used alone in proprietary systems or could also be translated into  $L^*a^*b^*$  values. The charts on paper are then used to individually score the food products without using an expensive electronic device. The main drawbacks are the nonstandardized light environment and the subjectivity of the human sensory judgement.

### **27.2.6 Computer Vision, Digital Scanning, and Image Analysis**

Image analysis techniques using computer vision systems have been increasingly adopted for variety classification and quality evaluation of food materials and products. Wang and Sun [9] developed a computer vision method to evaluate the melting property of cheese. Researchers also used computer vision methods to analyze the color of pork, beer, and potato chips. A computer vision system includes a lens, a camera, a frame grabber, a monitor, a computer, and a software. The computer vision method provides noncontact measurement; therefore, there are no limitations on the temperature, size, and shape of samples. Compared with conventional methods using colorimeters, the computer vision method is efficient and provides more information on the color change of cheese by making continuous measurement possible. It also has the advantage of handling surfaces with uneven color distributions. Among the studies conducted is the influence of baking temperature and time on the browning property of cheese. Since Cheddar and Mozzarella cheeses are intensively used as toppings, the monitoring of the browning property of both cheeses is of high interest.

### **27.2.7 High-Performance Liquid Chromatography (HPLC) of Pigments**

All the methods presented previously mostly deal with direct measurement of color, not with the identification of the compounds that are responsible for that color. To resolve mixtures of colorants, the usual alternatives are chromatographic techniques, such as liquid chromatography (LC) or thin-layer chromatography, and capillary electrophoresis. LC is often the preferred choice as it provides unrivaled resolution and lends itself readily to easy coupling with sensitive and selective detectors. LC using UV-visible, fluorescence, mass spectrometry, or diode-array detection (DAD) has been used to determine natural and synthetic colorants in dairy foods [10].

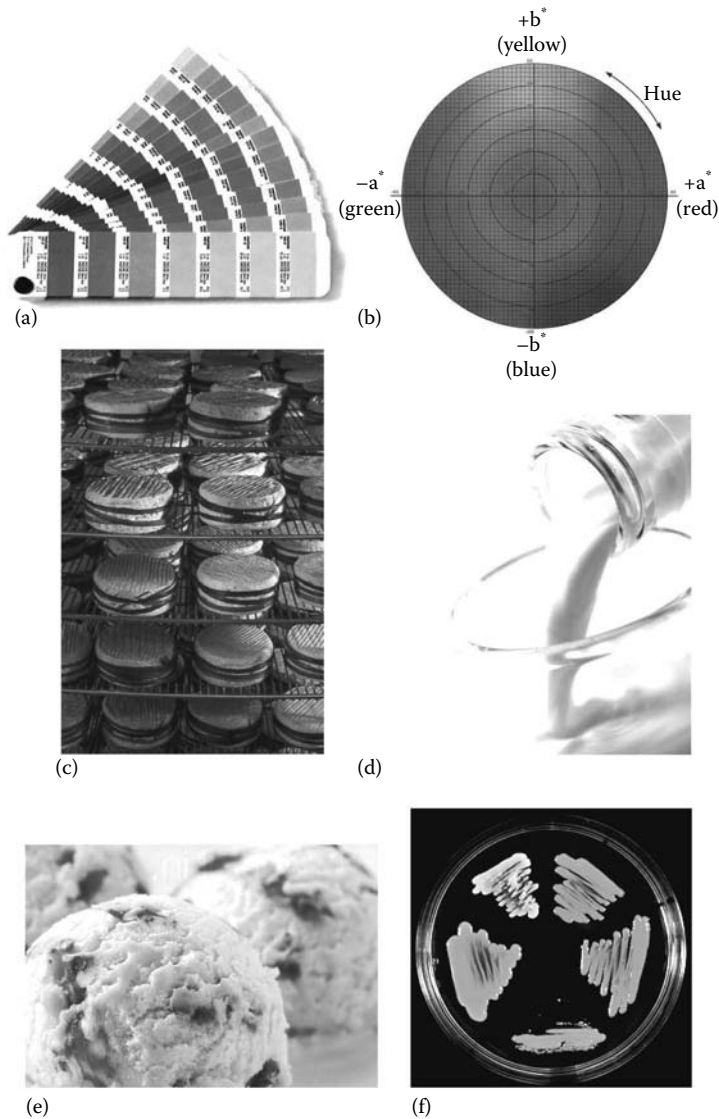


Figure 27.1 (a) Color fan; (b) CIE  $L^*a^*b^*$  color space; (c) Livarot cheeses on aging in a cellar; (d) milk, the color of which is due to light scattering or presence of pigments (e.g., carotenoids), (e) ice cream with added colorants; and (f) strains of *B. linens*, a bacteria used for surface ripening of soft cheeses. (From Anonymous, *Precise Color Communication. Color Control, from Perception to Instrumentation*, Konica-Minolta Sensing Inc., Japan, 1998. With permission.)

## 27.3 Practical Applications in Dairy Foods Analysis

### 27.3.1 Anteprocessing (i.e., Milk Production Related to Cattle/Cow Feeding)

The white appearance of milk results from its physical structure (i.e., the dispersion of both casein micelle and fat globules responsible for the diffusion of incident light and consequently of the

high  $L^*$  value of milk). All the measurement conditions such as temperature and composition parameters such as fat, protein, Ca, and P, as well as technological treatments that influence the physical structure of milk also modify the  $L^*$  component of the milk color measurement. Milk color assessment is mainly applied to identify technological parameters such as homogenization, thermal treatment (including Maillard reactions), fat concentration, photodegradation, storage conditions, or additives. The “ $a^*$ ” and “ $b^*$ ” components of the milk color are also influenced by a number of factors linked to milk’s natural pigment concentration. The main pigments are riboflavin, a green compound present in the aqueous phase which is a strong photosensitizer, and  $\beta$ -carotene and to a lesser extent lutein which have maximal absorbance at wavelengths 497–466 and 481–453 nm, respectively. Milk carotenoids are responsible for the yellow coloration (higher “ $b^*$ ” value) of cattle milks in comparison to sheep and goat milks which are devoid of  $\beta$ -carotene [11].

The components of milk color are linked to milk’s natural pigment concentration from carotenoids, protein, and riboflavin. Several studies have looked at the impact of feed on milk color pigments. Cows fed grass silage produced milk with fat that was more yellow than that produced by cows fed hay. Other scientists found that concentrations of riboflavin, tocopherols,  $\beta$ -carotene, lutein, and zeaxanthine in milk were higher in cows fed grass silage than those fed maize silage. In another study, milk from cows fed grass silage produced milk with higher  $\beta$ -carotene than those fed hay and a switch from grass silage to hay diet induced a rapid decrease in the concentration of  $\beta$ -carotene. The development of a reflectance method considers all of components that contribute to color in one measurement and enables the measurement of milk as an opaque food, addressing the limitations of other methods. However, limitations of measuring milk color to predict carotenoid content with spectrophotometry were described [12].

Carotenoids are involved in the nutritional and sensory characteristics of dairy products, and are potential biomarkers for traceability of cows’ feeding management. Nearly 10 carotenoids (i.e., xanthophylls and carotene) have been quantified in forages, and their concentrations vary highly according to the development stage and length of conservation. Sensitivity of  $\beta$ -carotene to ruminal degradation varies among studies, depending on its dietary source. Data suggest that carotenoid digestion would be linked to dietary lipids for transit, and to specific transporters of lipophilic molecules for absorption. Among ruminants, only bovines accumulate high concentrations of carotenoids, mainly  $\beta$ -carotene, possibly due to lower efficiency of vitamin A synthesis in enterocytes. Carotenoid flows in plasma and tissues in dairy cows remain to be investigated, especially the ability of adipose tissue to release  $\beta$ -carotene in depleted or underfed animals. Carotenoids in cows’ milk mainly consist of all-*trans*- $\beta$ -carotene and, to a lesser extent, lutein. In milk, concentration is more variable for  $\beta$ -carotene than for retinol, for which the plasma concentration is well regulated. Milk concentration of  $\beta$ -carotene depends on its dietary supply. Both animal and feeding factors that affect milk yield (i.e., breed, parity, physiological stage, level of intake) generally also control milk  $\beta$ -carotene concentration by concentration/dilution mechanisms, and by efficiency of extraction from plasma. The  $\beta$ -carotene concentration in cheese is highly linked to milk concentration, whereas high losses of retinol occur during cheese making. Feeding management of dairy cows allows efficient control of carotenoid concentration and color in dairy products [11]. Among the strangest supplementations of cow diet is the use of carrots [13] mixed with rapeseed to increase total carotene content (added value linked to color and biologically active compounds) together with unsaturated fatty acids (added value linked to spreadability and biologically active compounds). It was shown that the enrichment of carotene by feeding carrots counteracts the incorporation of unsaturated fatty acids.

Regarding the animal, the yellow coloration is higher in dairy products from cows than from ewes or goats (milk of goats and ewes, in contrast to that of cows, contains only retinol and xanthophylls and generally no  $\beta$ -carotene), and higher for cattle when breeds such as Jersey cows are used instead of Holstein or Montbéliarde.

The characteristics of the raw milk used play a major role, in particular in the case of products in which the modifications to the raw material during processing are restricted. The characteristics of raw milk used are dependent on factors linked to animal management (genetic, physiological, or dietary) that have increasingly been the focus of consumers' concern. These factors take special importance in the case of products with a protected designation of origin (PDO) or a protected geographical indication (PGI), which claims to have close links with milk production conditions.

### **27.3.2 Processing**

Research works are numerous in the field of dairy food processing and color. Normal processing of products such as butter, cheese [14], or yogurt has an impact on the final product color. Other points investigated that could have action on color are the followings: (i) use of technologies such as high-pressure processing or ultrafiltration, (ii) modification of dairy food composition (substitution of milk powder by whey powder or soy proteins, use of fat replacers, addition of chitosan or orange' fibers...), (iii) studies about the whiteness of mozzarella or browning of the same cheese when used in pizza, and (iv) role of the microflora in the development of color at the surface of soft cheeses.

As presented previously, carotenoids are important in dairy food color; however, these are sensitive to different physicochemical factors including air, oxidizing agents, and ultraviolet light. Their degradation is accelerated by increasing temperature and is catalyzed by mineral ions. Consequently, technological treatments such as heating and acidification applied when processing milk to produce dairy products, as well as the immediate processing and storage environment (i.e., light, temperature) are likely to degrade these micronutrients and influence the color and the vitamin potency of the resulting dairy products. Furthermore, processing of some milk products (e.g., cheese, butter) involves selective transfer of constituents from milk to milk products [11].

Milk carotenoids are transferred into butter and cheeses with minimal losses and thus contribute to their yellow coloration. Depending on the specific target market, the yellow color may be perceived as a positive or negative attribute. For instance, it is considered as negative for the color-sensitive markets of the Middle East. The marked yellow color of New Zealand milk fat resulting from the use of Jersey cows fed diets consisting predominantly of fresh grass raises problems for exportation. In contrast, in Europe, the yellow color of dairy products is generally seen as a positive trait that contributes to consumers' preference for dairy products produced in summer (e.g., derived from fresh grass-based diets). The hedonic preference of consumers for summer butter and cheese produced from pasture-fed cows is more marked when the sensory assessment is made under daylight in comparison to red light which masks the natural color differences.

The yellow coloration of dairy products is generally a more important issue in high-fat dairy products such as butter and full-fat cheeses. Because carotenoids are fat soluble, the yellow coloration is a function of both fat color and concentration, and fat color is a function of the carotenoid concentration in the fat.

#### **27.3.2.1 Butter**

Butter is a product that consists of roughly the same constituents as milk [15], but their distribution is different. In butter making, the fat content of the milk is concentrated approximately 20 times. The natural yellow color of butter is mainly due to carotene dissolved in the fat. Therefore,

the natural butter color will vary with the carotene content in the feed of the dairy cattle [16]. Since lucerne, clover, and grass are rich in carotene, and beets, hay, and feed concentrates contain very little, the carotene content in butter will be highest in summer and autumn and lowest toward the end of winter and in early spring. It further depends on the ability of the cow to convert carotene into vitamin A, which strongly varies among breeds and individuals [17].

A butter color tone was developed by Meiji Dairies Corp., Tokyo, Japan and named as Japan Agriculture & Livestock Industries Corp. (ALIC) butter color tone. In Japan, the best quality dairy products, including milk, cream, butter, and cheese, have an ALIC category 1 butter color tone (pale yellow). Butter is melted, centrifuged, and 2 g of butter fat is accurately weighed into a 10 mL volumetric flask and made to volume with hexane. The sample is then filtered and the absorbance measured at 455 nm converted per gram of fat [12].

### 27.3.2.2 Cheese-Making Process

During cheese manufacturing, between 800 and 950 g/kg of the carotenoids in the original milk are recovered in the curd. In many studies, little or no change in the concentration of these components has been observed during ripening or storage of cheese for up to a year. In a recent study [18], the rate of transfer of  $\beta$ -carotene and xanthophylls from milk fat to cheese fat, considering four cheese-making technologies and original milks covering a large range of concentrations of these micronutrients in milk fat was examined. On an average, 950 g/kg of  $\beta$ -carotene, but only 640 g/kg, of xanthophylls originally present in milk fat were recovered in cheese fat. In addition, despite the varying heating temperatures, acidification levels, and ripening times among the cheese-making technologies studied, the rate of carotenoid loss did not vary with the cheese-making technology. These results suggest that  $\beta$ -carotene is very stable, whereas xanthophylls are partially damaged and/or lost into whey during cheese making.

### 27.3.2.3 Use of Technologies Such as High-Pressure Processing or Ultrafiltration

Processing of food with high pressure rather than by traditional heating technologies offers unique advantages to consumers and the food industry. This technology can destroy microorganisms without causing significant changes to the sensory and nutritional attributes of the processed foods. Accordingly, it can produce some interesting effects and food products which are not possible with other preservation technologies. High-pressure or hyperbaric treatment of food is usually carried out in the range 300–1000 MPa at room temperature or a little higher; the pressure itself causes only a slight rise in the temperature of the food. Process times are short, usually between 2 and 30 min [19]. Milk treated at pressures of up to 500 MPa for a few minutes has been shown to have a shelf life of at least equivalent to HTST-pasteurized milk. When milk was subjected to high-pressure (250, 450, and 600 MPa) treatments for 30 min at 4°C, 20°C, and 40°C, a decrease in lightness ( $L^*$ ) was observed for all, except for those at 250 MPa.

High-pressure homogenization (HPH) is a combined pasteurization/homogenization of raw milk. This process was assessed for reducing the size of fat globules and inactivation of microorganisms. Raw and commercially pasteurized and homogenized (CPH) milk samples were analyzed as controls. Small but significant differences in  $L^*$ -values were observed between raw, CPH, and HPH milk samples. For example, CPH milk was significantly whiter ( $P < 0.05$ ) than raw milk, as expected; CPH and HPH samples had similar  $L^*$ -values. Differences in  $a^*$  and  $b^*$  values



following treatments were very small. Overall, differences in instrumental color measurements between CPH and HPH milks were not visually obvious [20].

In another study, high-pressure processing was applied to fresh goats' milk cheeses (500 MPa for 5, 15, and 30 min at 10°C or 25°C). Color parameters hardly changed in the inner part of cheeses. Modifications on the surface were more pronounced. In 500 MPa/10°C cheeses, all parameters changed. Total color difference ( $\Delta E^*$ ) values of 500 MPa/10°C cheeses were higher than  $\Delta E^*$  values of 500 MPa/25°C cheeses, mainly due to  $L^*$  value changes in samples treated at 10°C. The  $b^*$  value was the index that changed more with all treatments. It increased in pressure-treated cheeses, generally with increasing treatment times [21].

Protein, the most valuable component in milk, has increased in value over the past 20 years. Using ultrafiltration, fluid milks can be standardized to different protein percentages by separating skim milk into retentate and permeate fractions. These can then be combined and fat is added to produce milks with a 0%, 1%, 2%, or 3.3% fat and a range of true protein contents (usually lower protein contents compared to the starting milk). The target is to recover milk protein that could be sold as a food ingredient. Two studies [22,23] demonstrated that a modest protein standardization was feasible without noticeable color changes of the milks (a decrease in the protein content of 2% and 3.3% fat milks by ultrafiltration made them less white—lower  $L^*$  value).

#### 27.3.2.4 *Modification of Dairy Food Composition (Substitution of Milk Powder by Whey Powder or Soy Proteins, Use of Fat Replacers, Addition of Chitosan or Orange' Fibers...)*

Milk whey is an important source of lactose, calcium, milk proteins, and soluble vitamins, which make this product to be considered as functional food and a source of valuable nutrients. Whey powder was used to substitute partially the milk powder in yogurt fortification. Five different formulations were obtained and analyzed for color (CIE  $L^*a^*b^*$ ) after 1, 15, and 28 storage days at 5°C. Color was measured through surface reflectance of 55 mm high yogurt samples by using a spectrophotometer. In samples at 1 storage day, milk substitution implied a yellowing, with higher color purity and significant differences in brightness. The observed development was a decrease in color purity and an increase in yellowness after 15 days. Changes in color coordinates in line with milk substitution can be attributed to the different opacity level of gels, which increases with the casein proportion and their aggregation level. The greater the opacity the higher the sample brightness and the less pure the color [24].

A second example is the soy protein isolate (SPI) fortification of a low-fat dairy-based ice cream for the purpose of meeting any soy protein health claim labeling requirements. Low-fat ice cream mixes with 0% (control), 2%, and 4% (wt/wt) added SPI were made by substituting SPI for non-fat dried milk. Color differences among low-fat ice cream mixes with different levels of SPI were observed by instrumental analysis. The 4% SPI mix had a significantly lower  $L^*$  value than the control mix, indicating that ice cream mix fortified with SPI was less white in comparison to that of a typical low-fat ice cream. Values for  $a^*$ , which signify red (+) and green (-), were also significantly different among treatments. The  $a^*$  values for the low-fat ice cream mixes decreased with increasing SPI, demonstrating that the SPI mixes had more green color compared to the control. The  $b^*$  value, an indicator of blue (-) and yellow (+), was also different among treatments. The  $b^*$  value for the control increased with increasing levels of SPI, which demonstrates that the mixes increased from blue to yellow in color with increased SPI fortification [25]. Despite these data, low-fat dairy ice cream fortified with SPI may be a means of positively presenting soy protein to a broader market of consumers, among similar products, as they might appeal to a more traditional dairy consumer who could reject soy-based dairy analogs such as soymilk, soy yogurt, and soy ice cream.

Among additional studies, some focused on the effect of fat replacer on color of reduced fat mozzarella cheese [26] or ice cream [27], properties of low-fat Cheddar cheese manufactured with chitosan [28], or the impact of orange fiber addition on yogurt color during fermentation and cold storage [29].

### 27.3.2.5 *Studies about the Whiteness of Mozzarella or Browning of the Same Cheese When Used in Pizza*

The ever increasing pizza popularity has led to the tremendous growth of cheese products, especially Cheddar and Mozzarella cheeses, which are the two major varieties of cheese used as toppings for pizza and some other prepared consumer foods. In order to achieve desirable quality of these consumer foods, the cheese products used are required to have certain functional properties such as melting, browning, oiling-off, shredability, and stretchability. Browning is a property of cheese that results in patches of darkened color on the cheese surface during baking before consumption. It is of high commercial interest to the manufacturers of both pizza and cheese because about 50% of pizza restaurants reported quality problems in cheese browning. It is widely believed that the browning of cheese during baking is mainly caused by Maillard reaction, which involves an interaction between reducing sugars and amino compounds. As a heat-induced process, the browning of cheese starts to occur during processing and slow cooking after processing. Attempts have been made to analyze the browning of cheese during baking to improve the quality of cheese used as toppings. Researchers have investigated the influence of different starter cultures on the residual sugar in cheese and thus on cheese browning. A strong correlation was found between the darkness of cheese color and galactose content for processed cheese and Mozzarella cheese. Though browning is considered as a defect in cheese whey [30] or processed cheese [31], for cheese used as toppings, browning may be considered as a desirable property. For the evaluation of cheese color, in addition to qualitative sensory evaluation, instrumental methods involving colorimeters/spectrophotometers, or image analysis techniques/computer vision are employed [9].

Mozzarella cheese undergoes significant change in temperature during baking on a pizza. A cheese temperature of 60°C–70°C is usually observed at the end of baking. After baking, the cheese begins to cool and is normally consumed at 40°C–50°C. Before measurements, the spectrophotometer is calibrated with a white reference tile. The  $L$ -value corresponds to whiteness, and higher  $L$ -values indicate whiter products (white = 100, black = 0). With products showing heterogeneous surface aspects (e.g., dark or brown patches), it is very important to increase the measurement area (cm<sup>2</sup>). Manufacturers usually provide many measurement areas with increasing diameters. In one of the studies assessing this process [32], the  $L^*$ -value of Mozzarella increased dramatically during heating to 60°C and decreased during the subsequent cooling. The formation of a gel during heating increases light scattering, which increases  $L^*$ -value. During cooling, the gel dissociates and no longer scatters light, which decreases  $L^*$ -value. Similar results were obtained in Cheddar-like and Colby-like cheeses made with caprine milk [33] or processed cream cheese [34].

### 27.3.2.6 *Role of the Microflora in the Development of Color at the Surface of Soft Cheeses*

For the so-called smeared cheeses like Maroilles, Munster, Livarot, Epoisses, Limburger, Herve, Gubbeen, Taleggio, or Tilsit, a good aspect is mostly characterized by the occurrence of an orange-brown, sticky surface [35]. Since it is due to the development of cheese-ripening flora and to

the interactions within this microflora (especially bacteria from the *Brevibacterium linens* group, *Arthrobacter* sp., *Microbacterium* sp., and coryneform bacteria), these typical dark yellow, orange, pink, or red-brick colors related to carotenoids such as isorenieratene and other pigments ensure that the cheese has developed aromas and melted texture. As knowledge of the representatives of the cheese-surface bacterial flora is quite limited, industrial manufacturers may sometimes encounter quality problems and the sole ripening pigmented microflora is not sufficient to give a nice color. In this case, colorants such as annatto, paprika, or  $\beta$ -carotene are spread on the surface of the cheese during processing, as a means to produce standard and attractive products. Objective measurement of the smear color can be provided using a spectrophotometer ( $L^*a^*b^*$  colorimetric system). The spectrophotometry can be used for the description of (i) the rind's color among various PDO cheeses (Figure 27.2), (ii) the relative heterogeneity observed for “on shelf cheeses” color in a specific PDO area, (iii) the assessment of color development on the surface of cheese versus time (quality control), and (iv) a screening technique for pigmented strains isolated from red-smear cheese rinds (biodiversity criteria) [36]. Concerning the latter item, up to now very few pigmented bacteria are available as commercial cultures for manufacturing of red-smear cheese. Traditionally, growth of the surface microflora is initiated with the help of mature cheeses, which release part of their microorganisms into the brine that is used to wash the young curds. Only about 15 different strains of *B. linens* group are present on the market with various orange hues [37]. Intensive use of

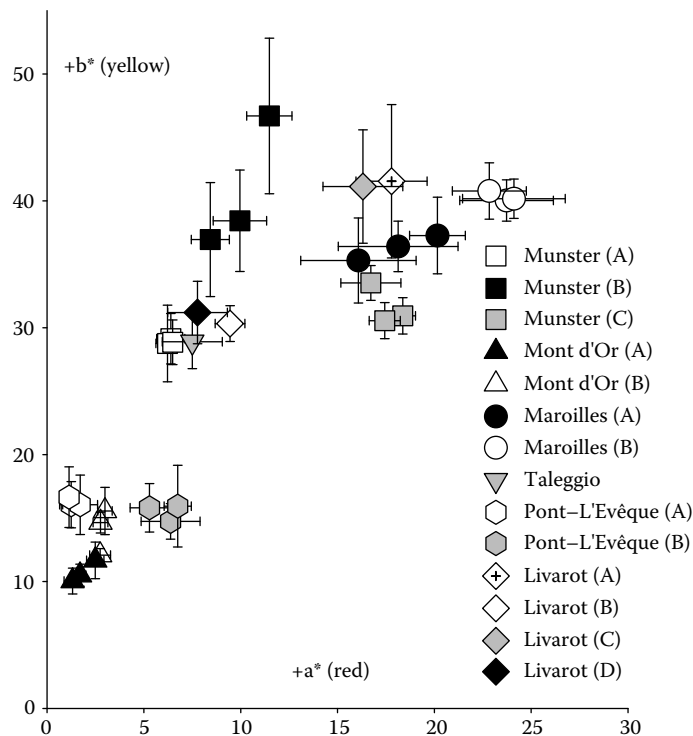
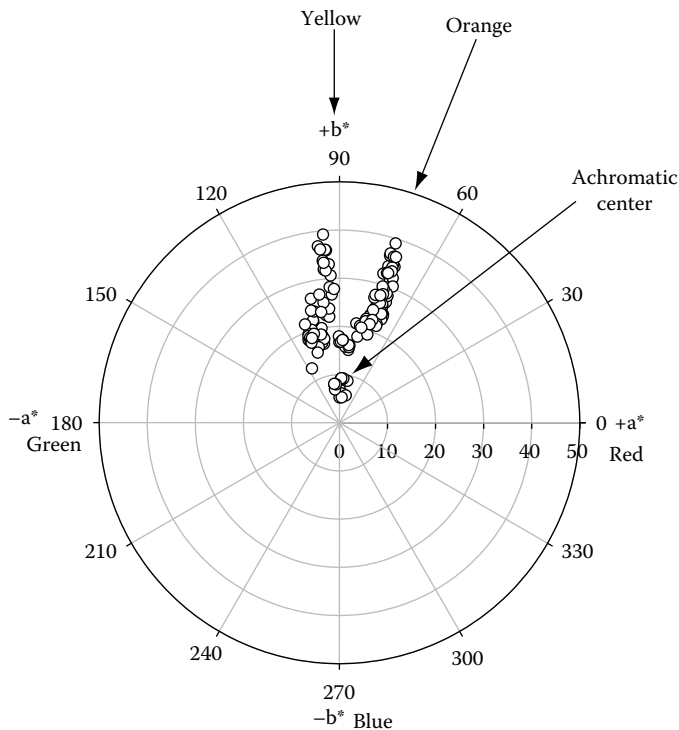


Figure 27.2 Color distribution among various PDO cheeses (10 measurements per cheese, letters A–D: cheese manufacturing plants, one distinct letter series within one PDO). (From Dufossé, L. et al., *Food Res. Int.*, 38, 919, 2005. With permission.)

these strains may contribute to a decrease in microbial diversity observed within the PDO cheeses, contributing to the loss of typicality for products proposed to the European consumers. Bacteria belonging to species other than *B. linens* group are also lacking in commercial offers made by microbial culture companies and this should be corrected as many authors emphasized their contribution in the ripening of smear cheese rind, e.g., *Microbacterium gubbeenense*, *Corynebacterium casei*, *Arthrobacter bergerei*, and *A. arilaitensis*. In order to be able to supply new pigmented strains to cheese producers, a screening experiment was conducted for 2 years [38] and 364 strains were isolated from Munster cheese (219 coryneform bacteria, 32 *Micrococcus*, 30 *Staphylococcus*, and 83 *B. linens*). Color coordinates were determined for each of them and the two dominant colors were orange and yellow (Figure 27.3 for a sample of 29 strains projected within the  $L^*a^*b^*$  system). All the orange strains were easily identified as strain members of the *B. linens* group (positive reaction with KOH, HPLC analysis of the pigments, 16S DNA sequencing). The technological important group of yellow pigmented coryneform flora of the smear cheese is quite homogeneous in colony morphology and physiological characteristics. Besides orange and yellow, a lot of strains were light colored (cream, beige) such as *Corynebacterium mooreparkense* sp. nov., five were pink but a total of 29 hues were described.

Other studies in the same field evaluated the influence of the yeast used for deacidification on the color of the bacterial biofilm [39–41]. For each bacterial biofilm, color was monitored by



**Figure 27.3** Position of 29 pigmented bacteria isolated from Munster cheeses in the CIE  $L^*a^*b^*$  colorimetric system. (From Dufossé, L. et al., *Food Res. Int.*, 38, 919, 2005. With permission.)

$L^*C^*h^*$  (brightness, chroma, hue angle) spectrophotometry. Color intensity (function of chroma only) was higher when *Debaryomyces hansenii* was used, compared to deacidification with *Kluyveromyces marxianus*.

## 27.4 Postprocessing

Dairy foods are exposed to light from both natural and artificial sources throughout processing, packaging, and distribution, as well as at the retail level. Light-induced degradation of lipids, proteins, and vitamins in dairy foods causes both formation of off-flavors and color changes, which rapidly impair product quality and marketability and eventually may lead to loss in nutritional value and formation of toxic products (e.g., cholesterol oxides). Today, consumers make greater demands on packaging, including transparent packaging, in order to better appraise the product prior to purchase. Furthermore, environmental concerns have caused a reduction in the use of aluminum and metallized foils. These factors have led to increased use of transparent packaging materials within the entire food sector. However, packaging of dairy products in transparent materials greatly increases the risk of light-induced oxidation [42]. It is normally accepted that light-induced oxidation in dairy products is the result of the presence of riboflavin as a photosensitizer. The action of riboflavin is not clearly photodynamic, since riboflavin itself is photooxidized.

For purposes of convenience, many cheese varieties, including Cheddar or Parmigiano Reggiano [43,44], are available in a preshredded form in translucent modified atmosphere packaging [45]. Transparent films transmitting more than 80% of the incident light in the wavelength range 400–800 nm are generally used [46]. High-intensity light has been reported to have negative effects on the color stability of natural yellow cheeses. In addition, shredded Cheddar cheese stored under high-intensity fluorescent light may be susceptible to light-induced oxidation reactions. Color data for shredded Cheddar cheeses packaged under  $N_2$  and  $CO_2$  and stored under light or dark conditions were monitored [47]. Approximately 10 g of cheese shreds was compressed into a  $50 \times 50 \times 10$  mm optical cell. Reflectance values were obtained using a 25 mm view area aperture.  $L^*$  values were significantly higher in cheeses packaged under  $CO_2$  and exposed to fluorescent light, whereas  $a^*$  and  $b^*$  values were significantly lower. The shredded cheeses packaged under  $CO_2$  and exposed to fluorescent light experienced obvious color alterations during storage, shifting from the traditional orange of colored Cheddar cheese to a definite white hue. One possible explanation for the color shift in the shredded Cheddar cheese packaged under  $CO_2$  and exposed to fluorescent light is related to annatto, the pigment commonly used in the production of natural yellow cheeses such as Cheddar. Annatto extracts are obtained from the seeds of *Bixa orellana*. The carotenoid that is mainly responsible for the coloring properties of annatto is bixin, which contains numerous conjugated double bonds. Conjugated double bonds are the target of free radical molecules, leading to oxidation reactions in lipids and probably in the carotenoid, bixin. It is proposed that the color loss was due to bixin oxidation which resulted from  $CO_2$ -derived free radical species generated under light exposure.

In another study [48], salted sweet cream dairy spread was found to have better oxidative stability compared to salted sour cream dairy spread when evaluated by color changes that are measured as tristimuli  $L^*$ ,  $a^*$ ,  $b^*$  values. Results showed that the storage temperature ( $-18^\circ C$ ,  $5^\circ C$ , or  $20^\circ C$ ) was most important as the product surface was found darker and more yellow and greenish.

Regarding yogurt color modification during postprocessing, a first study investigated the relationship between color parameters and the syneresis and titrable acidity [49]. Regardless of storage time, yogurts with an initial pH of 4.35 had the lowest  $L^*$  values, while the yogurts with an initial pH of 4.45 had the highest. Storage time exerted a significant influence on the decrease in the

color lightness value. A second study dealt with the use of bio-based material polylactate (PLA) for packaging of plain yogurt [50]. Plain yogurt (3.5% fat) was stored for 5 weeks in PLA or polystyrene (PS) cups under fluorescent light (3500 lux) or in darkness. Quality changes were studied by determination of color stability and degradation of  $\beta$ -carotene. For light-exposed yogurts, PLA was at least as effective in preventing color changes as PS. Furthermore, losses of riboflavin and  $\beta$ -carotene were less in light-exposed yogurt that was packed in PLA than in PS. Thus, it was concluded that light exposure reduced the quality of plain yogurt and that PLA provided a better protection against photodegradation processes than PS.

## 27.5 Quality Control

The color is one of criteria which the food industry controls to make sure that the food product meets the demand of consumption and that the product is produced in a reproducible way. In some cases, the industry use indices to monitor and to control the color of the product.

For butter, the yellowness index (YI) is a dimensionless number obtained from the tristimulus primaries  $X$ ,  $Y$ , and  $Z$ , data available from many instrumental devices, together with the appropriately derived  $L^*$ ,  $a^*$ , and  $b^*$  coordinates. YI is calculated as follows:

$$YI = 100(C_X X - C_Z Z)/Y$$

where  $X$ ,  $Y$ , and  $Z$  are the CIE tristimulus values and the coefficients depend on the illuminant and observer. YI may only be calculated for illuminants D65 and C. (illuminant D65 and observer 10°, then  $C_X = 1.3013$ ,  $C_Z = 1.1498$ ) – [ASTM Method E313].

As examples, the YI was 47.7 and 57.8 in case of Sommerbutter (Austria) and Kerrygold (Ireland) butter, respectively [51]. Between the butter samples, the CIELAB color difference  $\Delta E$ , representing the pythagorean distance between the two data points in the  $L^*$ ,  $a^*$ ,  $b^*$  system according to  $\Delta E = [(\Delta L^*)^2 + (\Delta a^*)^2 + (\Delta b^*)^2]^{1/2}$ , was found to be 5.9. This  $\Delta E$  value is far above the sensory threshold of  $\sim 0.7$ , which is relevant in the range of the butter color coordinate. Quality control is important in butter production as consumers link more yellowish butter with “easier-to-spread” [52].

Determination of food authenticity and geographic origin is a crucial issue in food quality control. Adulterations are known for dairy products. The geographic origin of butter and milk, the addition of cow’s milk to ewe’s or goat’s milk or other dairy products, and the use of added whey solids or processed cheeses in grated cheese have been reported. The originality of a cheese depends on several factors such as milk and cheese-making procedures (including microbiology and technology), which are both dependent on the geographic origin. The determination of origin is a key component of PDO products and, where industrial copies exist, of goods manufactured by a traditional method. Emmenthal (Emmentaler) cheese, often called “Swiss cheese” is the example “par excellence” of a cheese variety that is widespread and very popular in many countries. Color measurement was included in a study that aimed to evaluate the potential of a large variety of analytical methods for determining the geographic origin of an Emmentaler cheese [53]. In Emmenthal cheeses collected in five countries (Germany, Austria, Finland, France, and Switzerland), the parameters  $a^*$  and  $b^*$  presented considerable differences. The Finnish Emmentaler was significantly redder and yellower than the others. “French Savoie,” on the other hand, was significantly less yellow than the others and “French Bretagne” more blue. A possible explanation may be found in the forage. “Finland” uses grass silage whereas “French Bretagne” feeds maize silage. In the other regions, silages are not permitted.

The control of the color of dairy products is particularly attractive with several dessert product varieties. Due to the possibility to vary the concentration of fruit preparations as well as natural and artificial dyes added, the color properties (hue, saturation, brightness) can be chosen deliberately within certain limits. As to yogurt-based desserts, color plays a dominant role in influencing the purchasing behavior of consumers. For example, a sharp drop of consumption was observed with fruit-flavored yogurts when they were marketed without added colorants, proving the influence of color on identification and acceptance of the product [54]. It is well documented that the color of fruit yogurts and related products may be influenced by several technological parameters such as fat content, heating and storage conditions and, basically, by the amount of fruits added. Recommendations concerning the concentration of fruit preparations as given by the manufacturers of these food ingredients are not only based on sensory attributes, but also aim at obtaining a distinct coloration of the final product [1]. With regard to the instrumental measurements of color, it can be reported that as the concentration of colorant increased, the  $L^*$  parameter decreased. In the case of a lemon-flavored yogurt,  $a^*$  decreased and  $b^*$  increased; in the yogurts with strawberry and fruit of the forest flavors,  $a^*$  increased and  $b^*$  decreased; and in the orange-flavored yogurts, both  $a^*$  and  $b^*$  increased as the concentration of colorant increased [55]. These results are as expected, since the parameter that determines red is  $a^*$  and the one that determines yellow is  $b^*$ . Colorant concentration may also have an influence on the perception of the intensity of flavor and sweetness and this is an additional reason to control this point.

In yogurts or other dairy foods, native natural and added natural or artificial colorants could be analyzed using HPLC with photodiode array detection. Carotenoids and other pigments have been extensively investigated, such as  $\beta$ -carotene (E160a(ii)),  $\beta$ -apo-8'-carotenal (E160e) [56], bixin and bixin derivatives [57], copper chlorophyll (E141(i)) and chlorophyllin (E141(ii)) [58], or synthetic colors [59]. Each pigment is then characterized by its retention time and absorption spectrum [38,60]. The main drawback with dairy foods is that they are quite rich in fat, so sample preparation is important and extraction of pigments requires either saponification step or treatment with enzymes such as lipase or phospholipase. Extraction and HPLC methods should also be able to estimate if the levels of colorants are well below the maximum levels specified in the European Council Directive (94/36 EC), linked, in some cases, to acceptable daily intakes.

A robust and automatic sample screening system that provides a reliable response to natural or synthetic colorants in dairy samples with minimal pretreatment of samples was developed; the binary response is related to the detection limit of the method (6–15 or 25–10 000 ng/mL for synthetic or natural colorants, respectively). If it gives a positive result, the sample is analyzed with the discrimination method. This method discriminates among mixtures of colorants of the same or different colors. In addition, each colorant can be identified by its absorption spectrum using the LC–DAD method [10] (Table 27.1). Another study focused on the use of HPLC for “carotenoid food additives” analysis [61].

Some pigments not only have coloring properties but could also have some beneficial impact on health. For example, lutein has been identified as a dietary factor that can delay the onset of age-related macular degeneration (AMD). Food fortification with lutein extract has been identified as a low-budget approach to prevent the onset or progression of AMD. Lutein was then incorporated in various amounts in Cheddar cheese [62] or strawberry yogurt [63], the color of the products monitored, and the stability of lutein during the process and maturation analyzed by HPLC. The results indicate that lutein, a functional additive with purported ability to prevent or reduce the onset of AMD, can be incorporated into dairy foods adding value to these products.

**Table 27.1 Application of the Screening and Discrimination LC–DAD Methods to Dairy Samples**

Sample	Colorants That Appear on Label		Screening Response <sup>a</sup>		Concentration Found by LC–DAD <sup>a</sup>
			Synthetic	Natural	
<b>Yogurt</b>					
Lemon	Natural yellow	Curcumin	Negative	Positive	172 ± 9
Peach	Natural yellow	Curcumin	Negative	Positive	205 ± 10
	Natural red	Carminic acid	Negative	Positive	18.5 ± 0.7
Strawberry	Natural red	Carminic acid	Negative	Positive	22 ± 1
Nuts and oats	Natural brown	Caramel	Negative	Positive	653 ± 40
Pineapple	Natural yellow	<i>Trans</i> -β-carotene	Negative	Positive	44 ± 2
Apricot and mango	Natural yellow	Curcumin	Negative	Positive	250 ± 12
	Natural yellow	<i>Trans</i> -β-carotene	Negative	Positive	42 ± 2
<b>Ice cream</b>					
Iced lemon fruit	Synthetic yellow	Tartrazine	Positive	Negative	6.8 ± 0.3
	Synthetic green	Lissamine green B	Positive	Negative	1.6 ± 0.1
Lemon	Synthetic yellow	Tartrazine	Positive	Negative	38 ± 2
Pistachio	Synthetic yellow	Tartrazine	Positive	Negative	28 ± 1
	Synthetic blue	Indigo carmine	Positive	Negative	14.8 ± 0.9
Vanilla	Natural yellow	Riboflavin	Negative	Positive	51 ± 2
	Natural yellow	<i>Trans</i> -β-carotene	Negative	Positive	30 ± 2

(continued)



**Table 27.1 (continued) Application of the Screening and Discrimination LC–DAD Methods to Dairy Samples**

Sample	Colorants That Appear on Label		Screening Response <sup>a</sup>		Concentration Found by LC–DAD <sup>a</sup>
			Synthetic	Natural	
Fruits	Natural yellow	Riboflavin	Negative	Positive	50 ± 2
	Natural yellow	<i>Trans</i> -β-carotene	Negative	Positive	37 ± 2
	Natural red	Carminic acid	Negative	Positive	26 ± 1
<b>Milk shake</b>					
Vanilla 1	Natural yellow	Curcumin	Negative	Positive	85 ± 4
	Natural red	Carminic acid	Negative	Positive	24 ± 1
Vanilla 2	Natural yellow	Riboflavin	Negative	Positive	66 ± 3
	Natural yellow	<i>Trans</i> -β-carotene	Negative	Positive	23 ± 1
Strawberry	Natural red	Carminic acid	Negative	Positive	24 ± 1
<b>Dairy dessert</b>					
Yogurt flavor	Synthetic yellow	Tartrazine	Positive	Negative	5.3 ± 0.3
	Synthetic blue	Indigo carmine	Positive	Negative	1.8 ± 0.1

Source: Adapted from Gonzalez, M. et al., *Anal. Chem.*, 75, 685, 2003. With permission.

<sup>a</sup> Average values ± standard deviation ( $n = 6$ ) in mg/kg food.

## 27.6 Conclusion

The purpose of this chapter was to demonstrate the potential inherent in objective color measurement of dairy products. The panel of methods is quite large and these methods are applied to numerous different dairy products, from the production of milk itself to the monitoring of the shelf life of yogurts or cheeses. Tristimulus color reflectance measurement is a tool which can be utilized to obtain well-defined physical data and such technique will see its use improved with some developments in metrology, in order to develop international standards or norms dedicated to milk and dairy products.

## References

1. Ulberth, F., Kneifel, W., and Schaffer, E. Colour intensity preferences observed with selected fruit yogurts. *Milchwissenschaft*, 48: 15–17, 1993.
2. Anonymous. *Precise Color Communication. Color Control, from Perception to Instrumentation*, Konica-Minolta Sensing Inc., Japan, 59 pp., 1998.
3. CIE. Compagnie Internationale de l'Eclairage, 1978. International Commission on Illumination, Recommendations on uniform color spaces. Supplement No. 2 to CIE Publication No. 15.2, Bureau Central, Paris.
4. Álvarez-Moro, C. and Heredia-Mira, F. J. PCROM: Cálculos colorimétricos, v.2.0. Spanish Patent SE-2374, 1994.
5. Pillonel, L. et al. Prediction of colour of European Emmental cheeses by using near infrared spectroscopy: A feasibility study. *Eur. Food Res. Technol.*, 226: 63–69, 2007.
6. McCaig, T. N. Extending the use of visible/near-infrared reflectance spectrophotometers to measure colour of food and agricultural products. *Food Res. Int.*, 35: 731–736, 2002.
7. Chatelain, Y. et al. La couleur du lait et des produits laitiers et sa mesure: un article de synthèse (1972–2002). *Mitt. Lebensm. Hyg.*, 94: 461–488, 2003.
8. Kneifel, W., Ulberth, F., and Chaffer, E. Tristimulus colour reflectance measurement in milk and dairy products. *Lait*, 72: 383–391, 1992.
9. Wang, H.H. and Sun D.W. Assessment of cheese browning affected by baking conditions using computer vision. *J. Food Eng.*, 56: 339–345, 2003.
10. Gonzalez, M., Gallego, M., and Valcarcel, M. Determination of natural and synthetic colorants in prescreened dairy samples using liquid chromatography-diode array detection. *Anal. Chem.*, 75: 685–693, 2003.
11. Nozière, P. et al. Carotenoids for ruminants: From forages to dairy products. *Anim. Feed Sci. Tech.*, 131: 418–450, 2006.
12. Solah, V. A. et al. Measurement of milk color and composition: Effect of dietary intervention on Western Australian Holstein-Friesian cow's milk quality. *J. Food Sci.*, 72: S560–S566, 2007.
13. Schreiner, M. and Windisch, W. Supplementation of cow diet with rapeseed and carrots: Influence on fatty acid composition and carotene content of the butter fat. *J. Food Lipids*, 13: 434–444, 2006.
14. Rohm, H. and Jaros, D. Color of hard cheese. 1: Description of color properties and effects of maturation. *Z. Lebensm. Unters. Forsch.*, 203: 241–244, 1997.
15. Casalis, J. Y. et al. Sur la relation entre la teneur en beta-carotene et la couleur des beurres français. *Lait*, 52: 28–42, 1972.
16. Berl, S. and Peterson, W. H. Distribution of carotene and vitamin A in butter-making. *J. Dairy Sci.*, 28: 103–107, 1945.
17. Gokturuk, S. et al. Effects of season on vitamins A and E contents and colour of Turkish butter. *Nahrung/Food*, 46: 54–55, 2002.
18. Lucas, A. et al. Respective effects of milk composition and the cheese-making process on cheese compositional variability in components of nutritional interest. *Lait*, 86: 21–41, 2006.
19. Datta, N. and Deeth, H.-C. High pressure processing of milk and dairy products. *Aust. J. Dairy Technol.*, 54: 41–48, 1999.
20. Hayes, M., Fox, P. F., and Kelly, A. L. Potential applications of high pressure homogenisation in processing of liquid milk. *J. Dairy Res.*, 72: 25–33, 2005.
21. Capellas, M. et al. Effect of high-pressure processing on physico-chemical characteristics of fresh goats' milk cheese (Mato). *Int. Dairy J.*, 11: 165–173, 2001.
22. Quinones, H.-J., Barbano, D. M., and Phillips, L. G. Influence of protein standardization by ultrafiltration on the viscosity, color, and sensory properties of skim and 1% milk. *J. Dairy Sci.*, 80: 3142–3151, 1997.
23. Quinones, H.-J., Barbano, D. M., and Phillips, L. G. Influence of protein standardization by ultrafiltration on the viscosity, color, and sensory properties of 2 and 3.3% milks. *J. Dairy Sci.*, 81: 884–894, 1998.

24. Gonzalez-Martinez, C. et al. Influence of substituting milk powder for whey powder on yoghurt quality. *Trends Food Sci. Tech.*, 13: 334–340, 2002.
25. Friedeck, K. G., Karagul-Yuceer, Y., and Drake, M. A. Soy protein fortification of a low-fat dairy-based ice cream. *J. Food Sci.*, 68: 2651–2657, 2003.
26. Rudan, M. A., Barbano, D. M., and Kindstedt P. S. Effect of fat replacer (Salatrim®) on chemical composition, proteolysis, functionality, appearance, and yield of reduced fat Mozzarella cheese. *J. Dairy Sci.*, 81: 2077–2088, 1998.
27. Roland, A. M., Phillips, L. G., and Boor, K. J. Effects of fat replacers on the sensory properties, color, melting, and hardness of ice cream. *J. Dairy Sci.*, 82: 2094–2100, 1999.
28. Aryana, K. J. and Beck, M. C. Properties of low fat Cheddar cheese manufactured with chitosan. *Milchwissenschaft*, 62: 39–43, 2007.
29. Garcia-Perez, F. et al. Effect of orange fiber addition on yogurt color during fermentation and cold storage. *Color Res. Appl.*, 30: 457–463, 2005.
30. Bertelli, L., Torreggiani, D., and Bertolo, G. Non-enzymatic browning in hydrolysed concentrated cheese whey permeate. *Food Chem.*, 55: 353–358, 1996.
31. Yann, D., Didier, H., and Daniel, B. Utilisation of the experimental design methodology to reduce browning defects in hard cheeses technology. *J. Food Eng.*, 68: 481–490, 2005.
32. Metzger, L. E. et al. Whiteness change during heating and cooling of Mozzarella cheese. *J. Dairy Sci.*, 83: 1–10, 2000.
33. Agabriel, C. et al. Tanker milk variability according to farm feeding practices: Vitamins A and E, carotenoids, color, and terpenoids. *J. Dairy Sci.*, 90: 4884–4896, 2007.
34. Kristensen, D. et al. Influence of light and temperature on the colour and oxidative stability of processed cheese. *Int. Dairy J.*, 11: 837–843, 2001.
35. Dufossé, L. et al. Spectrocolorimetry in the CIE L\*a\*b\* color space as useful tool for monitoring the ripening process and the quality of PDO red-smear soft cheeses. *Food Res. Int.*, 38: 919–924, 2005.
36. Dufossé, L., Mabon, P., and Binet, A. Assessment of the coloring strength of *Brevibacterium linens* strains: Spectrocolorimetry versus total carotenoid extraction/quantification. *J. Dairy Sci.*, 84: 354–360, 2001.
37. Guyomarç'h, F., Binet, A., and Dufossé, L. Characterization of *Brevibacterium linens* pigmentation using spectrocolorimetry. *Int. J. Food Microbiol.*, 57: 201–210, 2000.
38. Galaup, P. et al. HPLC analysis of the pigments produced by the microflora isolated from the “Protected Designation of Origin” French red-smear soft cheeses Munster, Epoisses, Reblochon and Livarot. *Food Res. Int.*, 38: 855–860, 2005.
39. Leclercq-Perlat, M. N., Corrieu, G., and Spinnler, H.E. The color of *Brevibacterium linens* depends on the yeast used for cheese deacidification. *J. Dairy Sci.*, 87: 1536–1544, 2004.
40. Masoud, W. and Jakobsen, M. Surface ripened cheeses: The effects of *Debaryomyces hansenii*, NaCl and pH on the intensity of pigmentation produced by *Brevibacterium linens* and *Corynebacterium flavescens*. *Int. Dairy J.*, 13: 231–237, 2003.
41. Mounier, J. et al. Growth and colour development of some surface ripening bacteria with *Debaryomyces hansenii* on aseptic cheese curd. *J. Dairy Res.*, 73: 441–448, 2006.
42. Mortensen, G. et al. Light-induced changes in packaged cheeses: A review. *Int. Dairy J.*, 14: 85–102, 2004.
43. Romani, S. et al. Physical, chemical, textural and sensorial changes of portioned Parmigiano Reggiano cheese packed under different conditions. *Food Sci. Technol. Int.*, 8: 203–211, 2002.
44. Severini, C. et al. Physical and chemical changes in vacuum packaged Parmigiano Reggiano cheese during storage at 25, 2 and -25°C. *J. Food Qual.*, 21: 355–367, 1998.
45. Juric, M. et al. Light-induced colour and aroma changes in sliced, modified atmosphere packaged semi-hard cheeses. *Int. Dairy J.*, 13: 239–249, 2003.
46. Mortensen, G., Sorensen, J., and Stapelfeldt, H. Light-induced oxidation in semihard cheeses. Evaluation of methods used to determine levels of oxidation. *J. Agric. Food Chem.*, 50: 4364–4370, 2002.

47. Colchin, L. M. et al. Modified atmosphere packaged Cheddar cheese shreds: Influence of fluorescent light exposure and gas type on color and production of volatile compounds. *J. Agric. Food Chem.*, 49: 2277–2282, 2001.
48. Kristensen, D. et al. Oxidative and colour stability of salted sour cream dairy spread compared to salted sweet cream dairy spread. *Milchwissenschaft*, 55: 504–507, 2000.
49. Cais-Sokolinska, D. and Pikul, J. Use of colour measurement to evaluate yoghurt quality during storage. *Ital. J. Food Sci.*, 18: 63–71, 2006.
50. Strand-Frederiksen, C. et al. Light-induced quality changes in plain yoghurt packed in polylactate and polystyrene. *Eur. Food Res. Technol.*, 217: 61–69, 2003.
51. Rohm, H., Strobl, M., and JAROS, D. Butter colour affects sensory perception of spreadability. *Food Res. Technol.*, 205: 108–110, 1997.
52. Krause, A. J., Lopetcharat, K., and Drake, M. A. Identification of the characteristics that drive consumer liking of butter. *J. Dairy Sci.*, 90: 2091–2102, 2007.
53. Pillonel, L. et al. Analytical methods for the determination of the geographic origin of Emmentaler cheese. Main framework of the project: Chemical, biochemical, microbiological, colour and sensory analysis. *Eur. Food Res. Technol.*, 215: 260–267, 2002.
54. Calvo, C., Salvador, A. and Fuszman, S. M. Influence of colour intensity on the perception of colour and sweetness in various fruit-flavoured yoghurts. *Eur. Food Res. Technol.*, 213: 99–103, 2001.
55. Gambaro, A., Gimenez, A., and Burgueno J. Sensory and instrumental evaluation of strawberry yogurt color. *J. Sens. Stud.* 16: 11–22, 2001.
56. Scotter, M. J. et al. Method development and analysis of retail foods and beverages for carotenoid food colouring materials E160a(ii) and E160e. *Food Addit. Contam.*, 20: 115–126, 2003.
57. Lancaster, F. E. and Lawrence, J. F. Determination of annatto in high-fat dairy products, margarine and hard candy by solvent extraction followed by HPLC. *Food Addit. Contam.*, 12: 9–19, 1995.
58. Scotter, M., Castle, L., and Roberts, D. Method development and HPLC analysis of retail foods and beverages for copper chlorophyll (E141[i]) and chlorophyllin (E141[ii]) food colouring materials. *Food Addit. Contam.*, 22: 1163–1175, 2005.
59. Tripathi, M. K., Khanna, S. K., and Das, M. A novel method for the determination of synthetic colors in ice cream samples. *J. AOAC Int.*, 87: 657–663, 2004.
60. Galaup P. et al. First pigment fingerprints from the rind of French PDO red-smear ripened soft cheeses Epoisses, Mont D'Or and Maroilles. *Innovat. Food Sci. Emerg. Technol.*, 8: 373–378, 2007.
61. Breithaupt, D. E. Simultaneous HPLC determination of carotenoids used as food coloring additives: Applicability of accelerated solvent extraction. *Food Chem.*, 86: 449–456, 2004.
62. Jones, S. T., Aryana, K. J., and Losso J. N. Storage stability of lutein during ripening of Cheddar cheese. *J. Dairy Sci.*, 88: 1661–1670, 2005.
63. Aryana, K.-J. et al. Lutein is stable in strawberry yogurt and does not affect its characteristics. *J. Food Sci.* 71: S467–S472, 2006.



# Chapter 28

---

## Texture

---

Kasiviswanathan Muthukumarappan and  
Chinnadurai Karunanithy

### CONTENTS

28.1	Introduction.....	603
28.2	Factors Affecting Texture of Dairy Foods.....	604
28.3	Definitions of Texture Parameters.....	605
28.4	Texture Profile Analysis .....	606
28.5	Texture Measurement of Dairy Foods .....	607
28.5.1	Cheese.....	607
28.5.2	Butter.....	607
28.5.3	Yogurt.....	608
28.6	Sensory Measurements.....	609
28.7	Viscosity Measurement of Dairy Foods .....	609
28.7.1	Capillary Tube Viscometer .....	611
28.7.2	Rotational Viscometer.....	611
28.8	Selection of Suitable Test for Dairy Foods .....	611
	References.....	612

### 28.1 Introduction

Texture of any dairy food is highly subjective. “Eating quality” of foods encompasses many properties of foods that excite our senses of sight, touch, and sound. Texture plays a key role in consumer acceptance and market value of many foods. There are several definitions available in the literature to define “texture.” For example, The International Organization for Standardization [1]

defines food texture as “all the rheological and structural (geometric and surface) attributes of the product perceptible by means of mechanical, tactile, and, where appropriate, visual and auditory receptors.” There is a vast range in textural characteristics of different dairy foods: the firmness, graininess, and spreadability of butter; firmness, cohesiveness, and springiness of cheese; coarseness, butteriness, sandiness, and crumbliness of ice cream; stickiness of milk powder; viscosity of yogurt and many others. This great range of types of textural properties found in dairy foods arises from the human demand for variety in the nature of their food.

Texture means different things to different people, and the perceived textural characteristics expected from different dairy foods vary widely. In general, the food texture is evaluated using instrumental and sensory methods [2,3]. The perceived textural attributes of a given dairy food are influenced by a variety of factors such as how we chew the food and how much chewing force is applied. Given this complexity, it is very difficult, if not impossible, to objectively measure and characterize texture. Therefore, human sensory evaluation has been the cornerstone of food texture characterization. Humans are particularly sensitive in identifying textural differences between two samples, whereas instruments can quickly provide a quantitative measurement on an absolute scale. Owing to limitations of cost and variety of new dairy food, efforts are continually made in designing instrumental methods for texture evaluation. These range from simple penetrometers to measure firmness to sophisticated texture analyzers/rheometers to characterize different dairy foods. In this chapter, our focus is primarily on the measurement of perceived textural attributes of different dairy foods.

## 28.2 Factors Affecting Texture of Dairy Foods

Texture is the primary quality attribute of any dairy food. In most cases, the overall appearance and texture (mouthfeel) of dairy foods are appreciated ahead of other attributes such as flavor. Microstructure of dairy foods plays a key role in forming the texture [4]. The texture is a reflection of its structure at the molecular level. Casein matrix is the major structure-forming constituent in most of the dairy foods in which fat globules are entrapped and serum or water is both bound to casein and fills interstices of the matrix [5]. This matrix structure is critically affected by the relative content of protein, fat, and water, as well as by the biochemical activities that occur during storage.

All the dairy foods are manufactured from milk. During their manufacture, several factors can contribute to the texture such as temperature, process time, acidity, and pH. Low acidity weakens the protein bonds through charge repulsion, as the negative charges on casein molecules increase with pH. The hydrophobic interactions, important for a stable casein matrix structure, are weakened by adsorption of water by proteins to solvate the ionic charges.

Different cheese varieties have a wide range of textural characteristics, and these also greatly change with aging owing to proteolysis, moisture loss, salt uptake, pH change, and the slow dissolution of residual Ca associated with casein particles. Cheese composition (i.e., moisture, protein, fat, NaCl, milk salts, and pH) has a major impact on the body and texture of cheese. Cheese composition is mainly controlled by the initial composition of the cheese milk (which is modified by the method used for milk standardization) and the manufacturing protocols (e.g., pH at renneting and draining, size of curd particles, cooking temperature, method of salting) used for cheese-making. Factors such as species and breed of animal, stage of lactation, and seasonality can all affect the initial milk composition and alter the texture of cheese [6]. It is worth taking a look at

different reviews on the texture, rheology, and fracture properties of cheese by International Dairy Federation [7], Prentice et al. [8], and Fox et al. [9].

When it comes to yogurt, various factors such as total solids, milk composition, homogenization, type of culture, acidity, degree of proteolysis, and heat pretreatment of milk influence the rheological properties of yogurt [10–13]. Yogurt is a non-Newtonian pseudoplastic material, with a highly time-dependent behavior. Texture is one of the most important characteristics that define the quality of yogurt and affects its appearance, mouthfeel, and overall acceptability. The most frequent defects related to yogurt texture, leading to consumer rejection, are apparent viscosity variations and the occurrence of syneresis [14]. These changes may be due to variations in milk composition, as well as changes in processing, incubation, and storage conditions. Yogurt texture characterization is important for product and process development, quality control, and to ensure consumer acceptability [15]. This characterization can be done using either instrumental or sensory measurements.

### 28.3 Definitions of Texture Parameters

Texture, which comes from Latin *textura* (cloth), was used initially to describe the cross-linking style of weave threads. It now defines disposition and arrangement for the different parts of a system. Texture can be defined as the sensory manifestation of structure of the food and manner in which this structure reacts to the applied forces, the specific senses involved being vision, kinesthetics, and hearing [16]. Rheology and structure of a product evaluated by instrumental methods also give relevant information on its textural properties, even if sensory and instrumental data are not always easily correlated [17]. Dairy products have several important textural properties as listed in Table 28.1.

**Table 28.1** Definitions of Textural Properties Pertaining to Dairy Foods

<i>Textural Properties</i>	<i>Definition</i>
Adhesiveness	Work necessary to overcome the attractive forces between the dissimilar materials, i.e., food surface and the food contact surface.
Chewiness	Energy required for masticating a solid food material until it is ready for swallowing.
Cohesiveness	The strength of the internal bonds making up the body of the product or degree to which the sample deforms before rupture.
Gumminess	Energy required to disintegrate a semisolid food material to a state of ready for swallowing.
Hardness	Force necessary to attain a given deformation.
Resilience	How well a product fights to regain its original position.
Springiness	Degree or rate at which the sample returns to its original shape/size after partial compression between tongue and palate.



## 28.4 Texture Profile Analysis

The first texturometer was developed at General Food Corporation. This texturometer comprises a reciprocating motion that imitates the action of jaw, i.e., biting the food twice. Technology development and understanding of the food materials lead to the development of the present-day texture analyzer, which is essentially a uniaxial compression test. A number of textural parameters can be extracted from the resulting force–time curve, which correlates well with the sensory evaluation of those parameters [18]. To simulate the first two bites taking place during the chewing of food, texture profile analysis (TPA) test is performed by subjecting a cylindrical or cube specimen to a two-step compression.

A typical TPA curve of a reduced fat cheese obtained from texture analyzer (TA.XT plus Stable Micro System, New York) is used to illustrate the principles involved in TPA test (Figure 28.1). A cylindrical cheese sample (20 mm height and 17 mm diameter) was placed on the base plate, compressed, and decompressed twice by a probe attached to the drive system at 50 mm/min crosshead speed and 70% compression. Textural parameters such as hardness, springiness, cohesiveness, and gumminess were determined from the TPA curve. Hardness ( $F_2 = 10.49$  N) is determined as the peak force in the first bite curve. Springiness (4.88 mm) is calculated as the distance recovered by the sample during the time between the end of the first bite and the start of the second bite. Cohesiveness (0.674) is calculated as the ratio of the positive areas under the second bite to the first bite (area 4–6/area 1–3). Gumminess (7.07 N) is defined as the product of hardness and cohesiveness. Generally, gumminess and chewiness are derived from the measured parameters. Chewiness is defined as the product of gumminess and springiness. Either chewiness or gumminess should be reported depending on the type of dairy product [19]. Resilience (0.57) is calculated as the ratio of positive area under 1–2 to 2–3 in the first bite.

Fracturability is defined as the force of a significant break in the first bite curve (not shown in Figure 28.1). Adhesiveness is defined as the work necessary to overcome the attractive forces

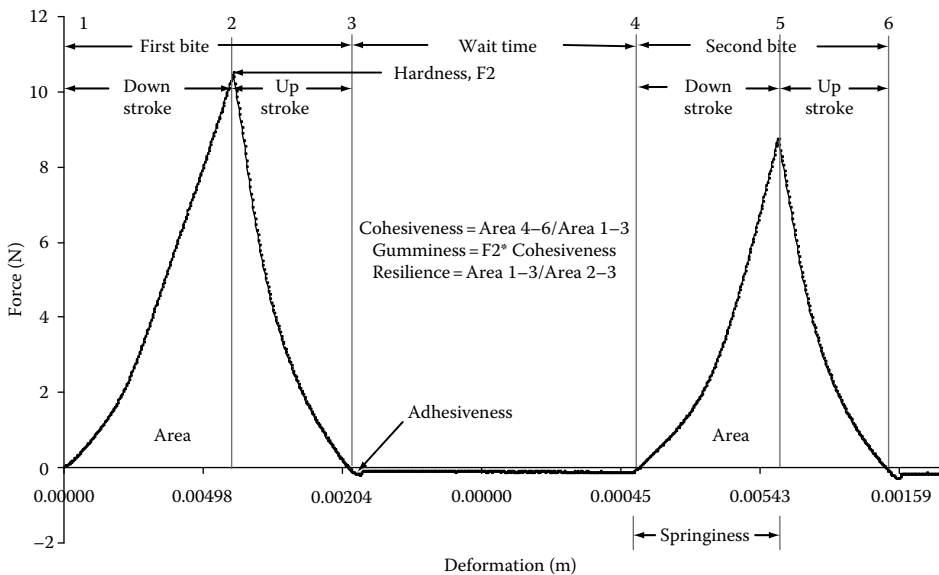


Figure 28.1 TPA of reduced fat cheese.

between the surface of the dairy product and the surface of the probe, and it is calculated from the negative force area of the first bite, which can be observed from the TPA curve of cheese.

## 28.5 Texture Measurement of Dairy Foods

Texture measurement techniques are either subjective by trained panel or objective using an instrument, i.e., fundamental, empirical, or imitative. Fundamental tests measure well-defined textural/rheological parameters. They are generally slow to perform and use expensive equipment. Empirical tests are the most commonly used that measure poorly defined parameters. These are rapid, easy to perform, and use inexpensive equipments. Fundamental tests are generally restricted to homogeneous and isotropic materials. In contrast, empirical tests place fewer restrictions on geometry and composition of the material. The choice between fundamental or empirical test depends on the purpose of the experiment. Imitative tests imitate the condition to which the food material is subjected to in a real situation. An ideal texture measurement technique may include some aspects of fundamental, empirical, and imitative methods [20].

Among the several testing methods, uniaxial testing is the most popular instrumental method used for evaluating mechanical and rheological properties of solid dairy foods. International Dairy Federation [7] developed a standard for testing and reporting uniaxial test results of cheese. Uniaxial compression testing conditions of dairy foods should include shape, size (aspect ratio >1), crosshead speed, compression rate, and the temperature of sample and environment. It is better to report all original and derived results along with complete force–deformation curve [21,22]. Testing methods for cheese, butter, and yogurt are discussed here.

### 28.5.1 Cheese

Texture is the primary quality attribute of cheeses. For each cheese type, there is an expected dominant textural attribute: ex Mozzarella cheese is stretchy or stringy and Parmesan cheese is crumbly. Cheese is a viscoelastic material, so the rate of compression and wait time between the first and second bite will affect the results. Brennan et al. [23] was the first to perform TPA on Cheddar cheese using the General Food Texturometer. The TPA is the most widely used instrumental measurement for cheese texture evaluation [24,25], which is also an imitative test. To imitate the chewing action more closely, Bourne [26] suggested a 90% compression for the TPA of cheese. However, Table 28.2 shows the variation in sample shape, size, compression rate, compression percentage, and test temperature as reported by various researchers. Viñas et al. [27] reported an increase in the hardness of Artisanal cheese during ripening time from 2 to 12 months. Nonfat process cheese hardness varied from 1.76 to 6.67 N depending on pH and the emulsifying agents used during manufacturing [28]. The hardness, springiness, and gumminess depend on the type of acid (lactic, citric, and acetic) used during manufacturing of Queso Blanco-type cheese [30].

### 28.5.2 Butter

Texture is one of the four quality factors that determine acceptability of butter [2]. It influences spreadability, taste, mouthfeel, appearance, and suitability of butter for various uses. The most commonly used test to evaluate butter texture has been penetrometry [31]. Cone penetrometry with constant load is still widely used to evaluate butter texture. It offers simple and economical

**Table 28.2 Variation in Cheese Texture Measurement Conditions**

Measurement Conditions	Vinas et al. [27]	Brickley et al. [28]	Everard et al. [29]	Farkye et al. [30]
Sample size, mm			25 × 25 × 25	20 × 20 × 20
Height	20	17.5		
Diameter	15	16.0		
Shape	Cylinder	Cylinder	Cube	Cube
% Compression	80	80	70	50
Crosshead speed, mm/min	50	60	60	75
Wait time, s	NR	NR	3	NR
Test temperature, °C	20	4	4	NR

NR, not reported.

methods, and the results obtained correlate well with the sensory evaluation [32]. Apart from penetrometry, compression, sectility, and extrusion are other methods to evaluate the texture of butter. Spreading, biting, and chewing involve breaking down butter's structure, so large deformation tests are useful in understanding the textural properties [17]. Large deformation techniques are generally simple and rapid, and require a relatively inexpensive equipment. Mickle et al. [33] reported butter hardness as 12.16–13.53 N. Hardness and adhesiveness of butter can be determined using a TA-XT2 texture analyzer (Stable Micro Systems, London, United Kingdom). Bobe et al. [34] lowered a 40° conical probe at 1 mm/s to a depth of 12 mm from the sample surface and then withdrawn at the same speed. They reported the penetration force (in G) as hardness and the negative force–time value (in G × s) generated during probe withdrawal as adhesiveness.

### 28.5.3 Yogurt

Texture is a critical aspect of consumer acceptability of yogurt [35,36]. Rheological properties of yogurt have been empirically evaluated by measuring gel hardness and viscosity of stirred products. The application of nondestructive dynamic rheological methods for yogurt gels has also been reported [37–39]. Fundamental rheological testing has the advantage over empirical methods in that it reveals structural characteristics of yogurt gels, especially in set-type yogurt. Hardness of yogurt varies between 0.15 N and 0.30 N depending on the type of yogurt. A penetration test was performed to determine the gel force by Salvador and Fiszman [40] using a TA.XT. Plus Texture Analyzer (Stable Micro Systems, Godalming, United Kingdom). They made a 20 mm penetration with a 12.5 mm diameter probe with a flat base (TA/0.5) at a speed of 1 mm/s. Firmness is recorded as the force at breaking (in N), defined as the first significant discontinuity produced in the curve as the plunger penetrated the gel during a total displacement of 20 mm, and the distance at which breaking took place (in mm).

The gel strength of yogurt made from conventionally treated milk and UHT milk fortified with low-heat skimmed milk powder was compared by Krasaekoopt et al. [41] using a texture

analyzer (TA-XT2 Stable Micro Systems, United Kingdom) with 20 mm diameter perspex probe (CodeP/20P) at a speed of 1 mm/s in compression mode. A combination of back extrusion, i.e., a 35 mm diameter solid rod (A/BE35) can be thrust into the cylindrical containers holding the yogurt for texture measurements using texture analyzer TA-XT2i (Texture Technologies Corp., White Plains, New York). Sandoval-Castilla et al. [42] conducted two cycle tests on reduced fat yogurt at a constant crosshead speed of 1 mm/s to a sample depth of 30 mm depending on the fat replacers used; springiness ( $29.56\text{--}29.79 \times 10^{-3}$  m), adhesiveness ( $140\text{--}1076 \times 10^{-6}$  Nm), and cohesiveness (0.77–0.91) were reported in addition to tension ( $87\text{--}145.69 \times 10^{-3}$  N—the first drop in force during sample penetration) and firmness ( $112\text{--}177.33 \times 10^{-3}$  N—maximum force as the test cell penetrated 30 mm of penetration into the sample) as described by Mohamed and Morris [43].

Ozer et al. [44] compared the effectiveness of destructive (conventional rheological techniques) and the nondestructive (oscillatory dynamic) test for the study of the physical properties of concentrated yogurt (labneh). Dynamic rheological studies revealed that labneh is a viscoelastic system in which its elastic characteristic is more dominant than its viscous properties. The elastic and viscous attributes of the control labneh were significantly different from the rest of the test samples. The destructive techniques (penetrometer and viscometer) failed to reveal the expected differences between the samples, and the results did not correlate with the oscillatory dynamic tests. They suggested that dynamic studies are much more reliable than the destructive rheological techniques for the study of the physical properties of labneh.

## 28.6 Sensory Measurements

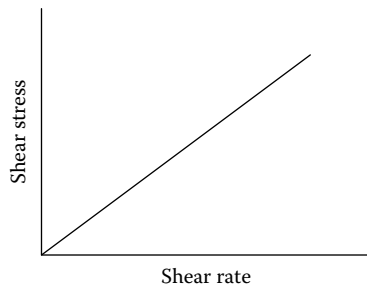
Sensory measurements are classified as consumer acceptance taste tests and trained panel taste tests. The consumer acceptance taste tests are frequently conducted in shopping malls, supermarkets, laboratory, and other areas having a large number of consumers. The purpose of these tests is to obtain a general evaluation of consumer acceptance or rejection of a dairy product. On the other hand, the trained panel taste tests are conducted by professionals with experience in sensory evaluation techniques. The panelists are trained to detect specific food characteristics such as firmness, flavor, graininess, spreadability, cohesiveness, springiness, coarseness, butteriness, sandiness, crumbliness, and stickiness with high degree of reproducibility. There is a wide variation between trained panels in their ability to detect individual food characteristics. In general, the results from consumer acceptance taste tests are essentially qualitative and the results from the trained panel tests are quantitative. Often the results from the trained panel tests are correlated with those obtained from instrumental methods as means of comparison.

## 28.7 Viscosity Measurement of Dairy Foods

The viscosity describes the resistance of the internal liquid layers to shear. From everyday use, we know that “thick” liquids like grease and glycerin have a high viscosity, whereas “thin” liquids like milk and water have a low viscosity. Usually, fluids obey the following law:

$$\text{shear stress} = -\text{viscosity} \times \text{shear rate}$$

Fluids that obey this relationship are called “Newtonian fluids.” In other words, Newtonian fluids are fluids in which the shear rate is directly proportional to the shear force (Figure 28.2). To

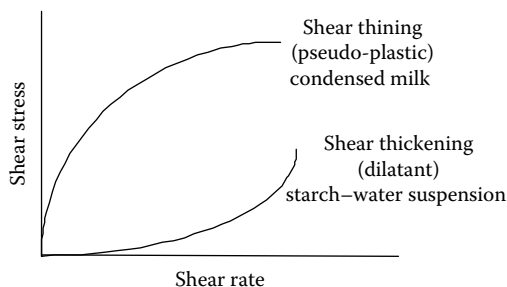


**Figure 28.2** Relationship between shear stress and shear rate for Newtonian liquids.

simplify things, consider that when liquid flows, the liquid layers are actually sliding against one another. The shear stress is a measure of the forces breaking the liquid layers apart, while the shear rate is a measure of how fast the liquid layers slide against one another. Viscosity is usually represented by the symbol  $\mu$ .

The fluids that do not obey the above relationship are called non-Newtonian fluids, so the viscosity is a variable, not a constant. For non-Newtonian fluids, the relationship between shear stress and shear rate is nonlinear, as shown in Figure 28.3. There are two important types of non-Newtonian liquids, namely shear-thinning liquids and shear-thickening liquids. The differences between these two types of liquids can be understood easily by the term “apparent viscosity.” For a shear-thinning liquid, as the shear rate increases the corresponding apparent viscosity decreases; therefore, the name shear thinning is used to describe the behavior of these liquids. On the other hand, if the increase in shear rate results in an increase in apparent viscosity, then the liquid is called a shear-thickening liquid. Non-Newtonian fluids are of great interest as they encompass almost all dairy fluids of industrial value. In the dairy industry, even a natural product such as milk is non-Newtonian.

To successfully measure non-Newtonian fluids, a known shear field (preferably constant) must be generated in the instrument. Generally, this situation is known as steady simple shear. There are two types of instruments typically used to measure the apparent viscosity of different dairy products that are non-Newtonian. They are



**Figure 28.3** Relationship between shear stress and shear rate for non-Newtonian liquids.

### 28.7.1 Capillary Tube Viscometer

In this instrument, the fluid flows inside a tube of known length. The decrease in the fluid pressure over the specified length is used to calculate the viscosity. For liquids with high viscosity, the pressure drop is high, whereas for liquids with low viscosity, the pressure drop is low.

### 28.7.2 Rotational Viscometer

Rotational viscometers are the most commonly used. To meet the criterion of steady simple shear, cone and plate, parallel plates, or concentric cylinders are used. The concentric cylinders instrument has two cylinders, one placed inside the other so that there is a narrow fixed gap between them. The liquid whose viscosity is to be measured is placed in the gap. One of the cylinders is rotated, the force required to rotate it is measured and related to the viscosity. If the fluid has a high viscosity, the force needed for rotation will be high; if the viscosity is low, the force will be low. Rotational viscometers generally have a fixed range of measurement owing to the limitations of their drive systems (motors). Viscometers typically generate viscosity data over a linear range of one to three orders of magnitude of shear rate and a specialized viscometer is called a rheometer. This special device is used to characterize viscoelasticity of any dairy product such as cheese, yogurt, ice cream, butter, and whipped cream. But this device can be used to measure viscosity alone. These devices are more expensive than normal viscometers, but can measure viscosity over wider ranges of shear rate or shear stress. This means that the processing engineer or new product developer has access to more information.

## 28.8 Selection of Suitable Test for Dairy Foods

A number of factors should be considered before setting up a new test procedure. They are: nature of the product, purpose of test, accuracy required, destructive or nondestructive, cost, time, and location. The first decision is whether to use an instrument or sensory test. Instruments have advantages being more reproducible, and use less time and labor. There are different kinds of dairy products—liquid, solid, homogeneous, heterogeneous, and plastic or viscoelastic, which affects the type of instrument selection [26].

The purpose of test may be for basic research, quality control, new product development, or legal standards, which influences the selection process. Single or multipoint measurement should be selected based on the purpose of test. Sophisticated instrument is required for new product development or research laboratory, which deals with difficult problems. Generally, large sample size gives a value closer to true mean than the small sample size. However, higher accuracy is obtained as the number of replications is more. Large sample size means higher forces are needed, which dictates the force capacity of the instrument [26].

Basically, destructive tests ruin the structure of the sample, making it unsuitable to repeat the test with the same sample. Nondestructive test offers the advantages of the same sample being used for repeated testing. Dairy food textural parameters are sensed in mouth, and mastication is a destructive process; so it is logical that destructive tests are the predominant test types.

Wide range of test accessories such as easily mountable probes, grips, anvils, and fixtures (penetration, cylinders, compression platform, warner bratzler blade, krammer shear cell, pasta hardness and stickiness rigs, dough stickiness, kieffer dough extensibility rig, etc.) should be available. User-friendly software that allows stand-alone programs to run all standard tests on foods and allow flexibility for changing test and measurement of configurations should be considered [45].

Cost per sample analysis is another factor in test selection process. It is normally arrived from initial instrument cost, maintenance, and operating costs. One has to strike a balance between automatic/sophisticated or manually operated; again it depends on the volume of the sample. In an industry, quick or timely sample analysis is required, whereas in a research laboratory, time is not a critical factor. The place of instrument location influences the test selection process. If the instrument is to be used in plant condition, it should withstand steam, water, dust, vibration, etc. If the industry has a plan to expand its product range in future, additional fixtures may be considered during the selection process. Each of these principles has been successful in quantifying the texture of some products but none of them has been successful with all the products.

## References

1. ISO 5492. *Sensory Analysis—Vocabulary*. International Organization for Standardization, Geneva, Switzerland, 1992.
2. Bourne, M.C. *Food Texture and Viscosity: Concept and Measurement*. Academic Press. New York, 2002.
3. Rosenthal, A.J. Relation between instrumental and sensory measures of texture, in Rosenthal, A.J., (ed.), *Food Texture, Measurements and Perception*. Aspen Publishers, Inc., Gaithersburg, MD, 1999, pp. 1–17.
4. Aguilera, J.M. and Stanley, D.W. *Microstructural Principles of Food Processing and Engineering*, 2nd edn. Aspen Publishers, Inc., Gaithersburg, MD, 1999.
5. Hort, J. and Grys, G.L. Developments in the textural and rheological properties of UK Cheddar cheese during ripening. *Int. Dairy J.*, 11(4–7), 475, 2001.
6. Lucey, J.A., Johnson, M.E., and Horne, D.S. Perspectives on the basis of the rheology and texture properties of cheese. *J. Dairy Sci.*, 86, 2725, 2003.
7. International Dairy Federation. *Rheological and Fracture Properties of Cheese*. Bull. IDF No. 268, International Dairy Federation, Brussels, Belgium. 1991.
8. Fox, P.F. et al. *Fundamentals of Cheese Science*. Aspen publishers, Inc., Gaithersburg, MD, 2000.
9. Prentice, J.H., Langley, K.R., and Marshall, R.J. Cheese rheology, in Fox, P.F., (ed.), *Cheese: Chemistry, Physics and Microbiology*. Elsevier Applied Science Publishing Co., London, U.K., 1993, vol. 1, pp. 303–340.
10. Harwalkar, V.R. and Kalab, M. Relationship between microstructure and susceptibility to syneresis in yogurt made from reconstituted nonfat dry milk. *Food Microstruct.*, 5, 287, 1986.
11. Heertje, I., Visser, J., and Smits, P. Structure formation in acid milk gels. *Food Microstruct.*, 4, 267, 1985.
12. Kalab, M., Allan-Wojtas, P., and Phipps-Todd, B.E. Development of microstructure in set-style nonfat yogurt—A review. *Food Microstruct.*, 2, 51, 1983.
13. Biliaderis, C.G., Khan, M.M., and Blank, G. Rheological and sensory properties of yogurt from skim milk and ultrafiltered retentates. *Int. Dairy J.*, 2, 311, 1992.
14. Kroger, M. Quality of yogurt. *J. Dairy Sci.*, 59, 344, 1975.
15. Benezech, T. and Maingonnat, J.F. Characterization of the rheological properties of yoghurt—A review. *J. Food Eng.*, 21, 447, 1994.
16. Szczesnaik, A.S. Texture: It is still an overlooked food attribute? *Food Technol.*, 44(9), 86, 1990.
17. Borwankar, R.P. Food texture and rheology: A tutorial review. *J. Food Eng.*, 16, 1, 1992.
18. Friedman, H.H., Whitney, J.E., and Szczesnaik, A.S. The texturometer—A new instrument for objective texture measurement. *J. Food Sci.*, 28, 390, 1963.
19. Szczesnaik, A.S. Texture profile analysis—Methodology interpretation clarified. *J. Food Sci.*, 60(6), vii, 1995.

20. Bourne, M.C. Method for obtaining compression and shear coefficients of foods using cylindrical punches. *J. Text. Stud.*, 5, 459, 1975.
21. Masi, P. The collaborative compression tests on cheeses, in Jowitt, R., Escher, F., Kent, M., McKenna, B., and Roques, M. (eds.), *Physical Properties of Foods-2*. Elsevier Applied Science Publishing Co., London, U.K., 1987, pp. 383–401.
22. McKenna, B. Overall survey of the COSTbis work on the solid properties of foods, in Jowitt, R., Escher, F., Kent, M., McKenna, B., and Roques, M., (eds.), *Physical Properties of Foods-2*. Elsevier Applied Science Publishing Co., London, U.K., 1987, pp. 367–382.
23. Brennan, J., Jowitt, G.R., and Mugali, O.A. Some experiments with general foods texturometer. *J. Text. Stud.*, 1, 167, 1970.
24. Emmons, D.B. et al. Milk gel structure X. Texture and microstructure in Cheddar cheese made from whole and homogenized low fat milk. *J. Text. Stud.*, 11, 15, 1980.
25. Bryant, A., Ustunol, Z., and Steffe, J. Texture of Cheddar cheese as influenced by fat reduction. *J. Food Sci.*, 60(6), 1216, 1995.
26. Bourne, M.C. *Food Texture and Viscosity: Concept and Measurement*, 2nd edn. Academic Press, San Diego, CA, 2002.
27. Viñas, M.A.G. et al. Relationship between sensory and instrumental measurements of texture for artisanal and industrial Manchego cheeses. *J. Sensory Stud.*, 22, 462, 2007.
28. Brickley, C.A. et al. Influence of emulsifying salts on the textural properties of nonfat process cheese made from direct acid cheese bases. *J. Dairy Sci.*, 91, 39, 2008.
29. Everard, C.D. et al. A three-point bending test for prediction of sensory texture in processed cheese. *J. Text. Stud.*, 38, 438, 2007.
30. Farkye, N.Y. et al. Sensory and textural properties of Queso Blanco-type cheese influenced by acid type. *J. Dairy Sci.*, 78, 1649, 1995.
31. DeMan, J.M. and Beers, A.M. Review: Fat crystal networks: Structure and rheological properties. *J. Text. Stud.*, 18, 303, 1987.
32. Dixon, B.D. Spreadability of butter: Determination. Description and comparison of five methods of testing. *Aust. J. Dairy Tech.*, 29, 15, 1974.
33. Mickle, J.B., Von Gunten, R.L., and Morrison, R.D. Rearrangement of milk fat as a means for adjusting hardness of butterlike products. *J. Dairy Sci.*, 46, 1357, 1963.
34. Bobe, G. et al. Texture of butter from cows with different milk fatty acid compositions. *J. Dairy Sci.*, 86, 3122, 2003.
35. Muir, D.D. and Hunter, E.A. Sensory evaluation of fermented milks: Vocabulary development and the relations between acceptability and sensory properties. *J. Soc. Dairy Technol.*, 45, 73, 1992.
36. Cobos, A., Horne, D.S., and Muir, D.D. Rheological properties of acid milk gels. 1. Effect of composition, process and acidification conditions on products from recombined milks. *Milchwissenschaft*, 50, 444, 1995.
37. Xiong, Y.L. and Kinsella, J.E. Influence of fat globule membrane composition and fat type on the rheological properties of milk based composite gels. I. Methodology. *Milchwissenschaft*, 46, 150, 1991.
38. Vlahopoulou, I. and Bell, A.E. Effect of various starter cultures on the viscoelastic properties of bovine and caprine yogurt gels. *J. Soc. Dairy Technol.*, 46, 61, 1993.
39. Rhom, H. and Kovac, A. Effects on starter cultures on linear viscoelastic and physical properties of yogurt gels. *J. Text. Stud.*, 25, 311, 1994.
40. Salvador, A. and Fiszman, S.M. Textural and sensory characteristics of whole and skimmed flavored set-type yogurt during long storage. *J. Dairy Sci.*, 87, 4033, 2004.
41. Krasaekoopt, W., Bhandari, B., and Deeth, H. Comparison of texture of yogurt made from conventionally treated milk and UHT milk fortified with low heat skim milk powder. *J. Food Sci.*, 69(6), E276, 2004.



42. Sandoval-Castilla, O. et al. Microstructure and texture of yogurt as influenced by fat replacers. *Int. Dairy J.*, 14, 151, 2004.
43. Mohamed, M.O. and Morris, H.A. Textural and microstructural properties of rennet-induced milk coagulum as affected by the addition of soy protein isolate. *J. Text. Stud.*, 18, 137, 1987.
44. Ozer, B.H. et al. Comparison of techniques for measuring the rheological properties of labneh (concentrated yogurt), *Int. J. Dairy Technol.*, 50(4), 129, 1997.
45. Gunasekaran, S. and Ak, M.M. *Cheese Rheology and Texture*. CRC Press, Washington DC, 2003.

# Chapter 29

---

## Flavor

---

Barbara d'Acampora Zellner, Paola Dugo,  
Giovanni Dugo, and Luigi Mondello

### CONTENTS

29.1	Brief Introduction to Dairy Flavor .....	616
29.2	Dairy Flavor Extraction Techniques.....	617
29.3	Analytical Methodologies for Dairy Products Flavor Investigation .....	619
29.3.1	Instrumental Techniques for Analytical Flavor Assessment .....	619
29.3.1.1	Gas Chromatography in Dairy Flavor Investigation .....	619
29.3.1.2	Gas Chromatography Coupled with Mass Spectrometry .....	621
29.3.1.3	Dairy Food Flavor Analysis by Means of Comprehensive Two-Dimensional Gas Chromatography.....	622
29.3.1.4	Odor-Activity Assessment by Means of Gas Chromatography-Olfactometry .....	624
29.3.1.5	Dairy Flavor Fingerprint Acquisition through Mass Spectrometry .....	630
29.3.1.6	Electronic Nose and Tongue in Dairy Flavor Analysis.....	632
29.3.2	Sensorial Dairy Flavor Analysis .....	633
29.3.2.1	Odor-Activity Value Determination .....	634
29.3.2.2	Analytical Sensory Tests .....	635
29.4	Characterization of Off-Flavors.....	637
29.5	General Considerations on Dairy Flavor .....	638
	References.....	639

## 29.1 Brief Introduction to Dairy Flavor

The consumption of dairy foods is strongly related to the stimulation of the human chemical senses, odor, and taste. The flavor of dairy products, along with its appearance and texture, is considered to be decisive for the consumer in its selection and ingestion. According to Laing and Jinks [1], food flavor is commonly defined as being the sensation arising from the integration or interplay of signals produced as a consequence of sensing smell, taste, and irritating stimuli from food or beverage. However, the term flavor is often inconsistently used, with regard to the above-mentioned biological receptor stimulation or to the chemicals responsible for the process.

With respect to the dairy food aroma, the sensation of odor is triggered by highly complex mixtures of volatile molecules, mostly hydrophobic and usually occurring in trace-level concentrations (ppm or ppb). These volatile molecules interact with a G protein-coupled odorant receptor (OR) of the olfactory epithelium located in the nasal cavity. Once the receptor is activated, a cascade of events is triggered to transform the chemical–structural information contained in the odorous stimulus into a membrane potential [2,3]. The latter is projected to the olfactory bulb, and then transported to higher regions of the brain [4], where the translation occurs.

The human nose perception of volatile compounds, released from dairy foods, depends on the extension of the release from the matrix and the odor properties of the compounds. It is known that only a small portion of the large number of volatiles occurring in a food matrix contributes to its overall perceived odor [5,6]. Further, these molecules do not contribute equally to the overall flavor profile of a sample; hence, the most abundant compound does not necessarily correspond to high odor intensities, owing to differences in intensity/concentration relationships.

Since the mid-1950s, volatile flavor components have been studied in dairy products, and the chemistry and identification of milk and cheese flavors have been widely described in literature. It is worth mentioning that one of the earliest applications of formal laboratory sensory analysis was carried out in the dairy-products industry. In the early 1990s, techniques for the judgment of these products were developed to stimulate the interest and educate consumers. The attributes considered were appearance, flavor, and texture, in relation to the presence or absence of predetermined defects. Over the last decades, flavor research has benefited from the improvements in the instrumental analytical chemistry, and a vast number of investigations have been carried out on dairy flavor compounds; many of these were investigated following the advent of gas chromatography (GC) that enabled component separation and identification, though requiring additional confirmatory evidence to avoid equivocated characterizations, such as by means of its coupling with mass spectrometry (MS) or olfactometry. It is worthwhile to highlight that GC combined with MS (GC/MS), marked a real turning point for dairy-foods research, and the introduction of GC with olfactometry (GC-O) was a breakthrough in the analytical aroma research, enabling the differentiation of a multitude of volatiles that are odor and nonodor active, according to their existing concentrations in a matrix. It is notable that the identification of flavor components of dairy products is generally very difficult, mainly owing to the tendency of these compounds to degrade or form artifacts during isolation processes, and also their presence in low concentrations with respect to other food matrices. However, nowadays, the number of known flavors has incredibly increased, with around 600 identified in cheese flavor [7].

In view of all the studies already performed on the flavor of several dairy products, it is possible to state that their profile comprises a large number of volatiles, which may include free carboxylic acids, sulfur compounds, alkaline nitrogen-containing substances such as amines and substituted pyrazines, pyridines, neutral compounds such as carbonyl compounds (e.g., methyl ketones and aldehydes), primary and secondary alcohols, esters, lactones, ethers, aliphatic and aromatic hydrocarbons, as well as multifunctional components [8].

Moreover, it is widely accepted that the flavoring chemicals profile vary according to the sample's state, and hence, raw milk elicits a distinct odor when compared with that of heated or processed milk, with different classes of compounds responsible for the characteristic odor of distinct samples. It is widely accepted that esters are responsible for the flavor of raw-milk samples, while lactones and heterocyclic compounds are responsible for that of heat-treated and pasteurized milk. On the other hand, fermented dairy products, such as cheese and yogurt, are characterized by the presence of fatty acids [9]. However, it is worth to point out that little is known about the characteristic impact of the flavor of most dairy products. Distinction has to be made between key odorants and odor-active compounds, as it is well known that only a small fraction of the volatile substances of a food matrix is responsible for its characteristic odor.

To attain a complete analysis of key odorants, sensorial analyses such as studies of recombination models and omission experiments, should be performed to increase the reliability of the achieved characterization. This chapter provides an overview on the most commonly applied analytical techniques to characterize the dairy food flavor. However, extended sample preparation theory will not be dealt with, and the diverse dairy products investigation methodologies will be outlined. On the other hand, analytical flavor assessment techniques will be focused on GC analyses, including theoretical principles and applications. Moreover, some aspects regarding the characterization of off-flavors will be briefly described.

## 29.2 Dairy Flavor Extraction Techniques

A significant but laborious step of dairy flavor analysis is sample preparation. The odor profile of a matrix is closely related to the isolation procedure that should yield a product that is representative of the sample; therefore, the choice of an appropriate sample preparation method becomes unprecedented.

According to the properties of the matrix, the preparation may include mincing, homogenization, centrifugation, steam distillation (SD), solvent extraction (SE), fractionation of solvent extracts, simultaneous distillation-extraction (SDE), supercritical fluid extraction (SFE), pressurized-fluid extraction, Soxhlet extraction, solvent-assisted flavor evaporation (SAFE), headspace techniques (HS), solid-phase microextraction (SPME), matrix solid-phase dispersion (MSPD), cryofocusing, and/or direct thermal desorption (DTD), among others. Attention should be given during sample preparation and treatment procedures to avoid the loss of highly volatile compounds and oxygen or heat-induced artifact formation.

Taking into consideration that, in general, volatile molecules contained in solid and semisolid dairy products are heterogeneously distributed, and, as previously cited, usually occur in trace-level concentrations, careful homogenization of the sample is required prior to flavor analysis. With regard to cheese samples, a commonly used, convenient, and mild technique is based on freezing, followed by grating of the sample at low temperature, and a powder is subsequently obtained in this process. According to the applied flavor investigation methodology, this powder may be dispersed using a high-speed homogenizer, e.g., in water. Furthermore, owing to the high diversity of volatile components of dairy food samples, a preliminary separation into acidic, alkaline, and neutral fractions can often be of great aid for instrumental and sensorial analysis [10].

In general, SD and SE methods are considered to yield the near-complete flavor of food extracts, which may not be of relevance for the determination of a characteristic odor profile. The extraction of the volatiles from a dairy matrix usually results in a dilute aqueous solution, and the volatiles have to be concentrated by liquid/liquid partitioning or cryoconcentration prior to GC analysis. Commonly, the extracts obtained by SE can be very complex, resulting in many

coelutions when analyzed by means of GC, making the identification of individual odor-active compounds difficult. The fractionation of these extracts is time-consuming, but is a useful method to overcome this limitation, e.g., by washing a food extract with dilute acid or base, even though multiple manipulations of the extract may cause loss of highly volatile compounds. Moreover, a possible loss of the more volatile compounds during solvent removal may occur, and hence, large amounts of sample are needed to attain concentrated extracts, which may represent a drawback, and the presence of nonvolatile and high-boiling compounds in the extract or impurities from the solvent may lead to unreliable flavor characterization. Furthermore, in GC-O analysis, the solvent peak may cover early eluting odor-active volatiles. On the other hand, by performing SD extractions, the presence of nonvolatile or high-boiling compounds in the dairy food extract is avoided, though poor extraction of highly polar or hydrophilic compounds (acids and alcohols) as well as artifact formation owing to thermal degradation may occur. However, concentrated sample may surely be advantageous, as it enables further detection of trace components. It is accepted that SD and SE, when combined with chromatography, are generally the best methods to isolate unknown components of dairy foods [9].

The technique SDE is also widely applied. The latter provides fast extractions, resulting in a fraction, which after concentration, can be readily injected into GC systems. In a continuous process, the condensing water vapor is extracted by the condensing vapor of the low-boiling solvent, resulting in a high extraction rate. However, the decomposition of labile compounds, loss of highly volatile compounds, and heat-induced artifact formation has often to be observed. A modified system, the SDE under static vacuum (SDE-SV) with continuous sample feeding, although being more time-consuming, may be used when heat-induced artifact formation has to be minimized. The latter method allows extractions at 30°C–35°C and eliminates the concentration step prior to GC analysis.

Another very popular extraction method is SAFE, which may be applied after SE techniques or be used as an individual extraction method for solvent extracts or food matrices. This technique, most commonly applied to aqueous foods such as milk, removes volatiles under low-temperature and high-vacuum conditions. The extract is then collected into flasks that are cryogenically cooled with liquid nitrogen. The attained product should be representative of the original sample, uncooked, but without high-boiling compounds and color.

The HS methods, which are also frequently applied, may be divided into static headspace (SHS) and dynamic headspace (DHS) analyses. The former is characterized by the sampling of the atmosphere, after equilibrium has been achieved, around the headspace of a matrix, located in a vial, while the latter removes larger amounts of volatiles by sweeping the matrix through a carrier gas flow, with a concentration step carried out prior to GC analyses. The HS techniques combine the solvent-free procedures and require small amounts of sample with no artifact formation. However, it is worth to highlight that the relative concentration of volatile components in the headspace does not correspond to the concentration in the sample, owing to the volatility differences of flavor compounds (vapor pressure), as well as to the extraction temperature. In addition, when HS techniques are utilized frequently, the pH level of the homogenate has to be adjusted to pH 7.5 to maintain the high concentration of volatile acids dissolved in the aqueous solution as salts, so that the fraction to be analyzed is mainly represented by the neutral and alkaline components [11]. However, preparation of an alkaline homogenate can cause the decomposition of some essential components, such as lactones [12]. On the other hand, volatile acids may be esterified in the gas phase prior to analysis [13].

A further technique worth mentioning is SPME, a widely applied solvent-free method, which exploits the high adsorption power of a fused silica fiber coated with a specific extraction phase,

selected according to the type of matrix [14,15]. However, the use of SPME as an isolation method for dairy flavor characterization presents some limitations owing to the possible nonrepresentative nature of the extracts, problematic quantification, prolonged heating of the samples during isolation to increase flavor volatility, and recovery. The chemical profile of the collected volatiles depends on the type, thickness, and length of the fiber, as well as on the sampling time and temperature.

Moreover, taking into consideration the demand to simulate the flavor released during the consumption of a food, sophisticated extraction techniques have been developed, such as the buccal headspace analysis (BHA) [16]. The latter is an *in vivo* extraction technique capable of extracting volatile compounds released during consumption in concentration ratios that stimulate the olfactory receptors.

To establish the most adequate extraction procedure, an analyst has to consider not only the low concentrations of the dairy flavor components, but also their tendency to degrade or form artifacts during the processes. Some frequently observed phenomena are: formation of methyl ketones owing to thermal decarboxylation of  $\beta$ -keto acids in dairy lipids, disulfide compound formation as the product of oxidation of mercaptans, and the activation of lipases and other enzymes by mild heating during milk storage, which subsequently react with the triglycerides producing increased amounts of free fatty acids. Furthermore, according to the applied extraction method, highly polar or semivolatile flavor chemicals, such as free fatty acids, vanillin, 2,5-dimethyl-4-hydroxy-3(2*H*)-furanone (DMHF) or furaneol, may present incomplete recovery.

Although a series of volatile isolation methods have been developed to enhance the quality of flavor analyses, none of the commonly used extraction methods is capable of faithfully reproducing a flavor's profile. Therefore, the application of diverse extraction procedures on an identical matrix is highly suggested to achieve a more extensive screening.

## 29.3 Analytical Methodologies for Dairy Products Flavor Investigation

### 29.3.1 Instrumental Techniques for Analytical Flavor Assessment

#### 29.3.1.1 Gas Chromatography in Dairy Flavor Investigation

After its introduction in 1952 by James and Martin [17], GC developed at a phenomenal rate, growing from a simple research novelty to a highly sophisticated instrument. In GC analysis, the compounds to be analyzed are vaporized and eluted by the mobile gas phase, i.e., the carrier gas, through the column that contains the stationary phase dispersed on a solid support. At the outlet of the analytical column, the analytes emerge separated on the basis of their relative vapor pressures and affinities for the stationary bed, and as a consequence, are separated in time. The analytes are then detected and a signal is recorded generating a chromatogram, i.e., a signal *vs.* time graphic, and ideally with peaks presenting a Gaussian distribution-curve shape. The peak area and height are a function of the amount of solute present, its width is a function of the band spreading in the column [18], and its retention time can be related to the solute's identity.

In general, the primary objective in any GC separation is always the complete resolution of the compounds of interest, at minimum time duration. To achieve this task, the most suitable analytical column (dimension and stationary-phase type) has to be chosen, and adequate chromatographic parameters must be applied to limit the peak enlargement phenomena. Furthermore, the constant requirements for high resolution and trace analysis are satisfied by modern column

technology; robust fused-silica open-tubular GC columns are available. In addition, the selective detectors and injection methods, which allow on-column injection of liquid and thermally labile samples, have also been developed.

The choice of the analytical column in dairy flavors GC analyses is of great importance for the overall characterization of the sample; the stationary-phase chemical nature and film thickness, as well as the column length and internal diameter, are to be considered. In general, dairy flavor GC analyses are carried out on 25–60 m columns, with 0.25–0.53 mm internal diameter and 0.25–5.00  $\mu\text{m}$  stationary-phase film thickness. Numerous stationary phases are available, but only some of them are commonly utilized, such as polyethylene glycol and its acid-modified phases (nitroterephthalic acid-modified polyethylene glycol), dimethylpolysiloxane (5% phenyl–95% dimethylpolysiloxane or 50% phenyl–50% dimethylpolysiloxane), and dimethylpolysiloxane copolymer (cyanopropyl-phenyl-methylpolysiloxane and 50% cyanopropyl-methylpolysiloxane). It is well known that the degree of separation of the two components on two distinct stationary phases can be drastically different; the nonpolar and polar columns produce boiling point- and polarity-based separations, respectively. As a consequence, it is highly advisable to use two analytical columns coated with stationary phases of distinct polarities to better characterize the sample and enhance the confidence in peak assignment.

An important study on the suitability and performance of various stationary phases and column dimensions for dynamic headspace GC of ripe Swiss Emmental cheese flavor was carried out by Imhof and Bosset [19]. The best performance was observed on a 30 m  $\times$  0.32 mm i.d., 4.0  $\mu\text{m}$   $d_f$ , 100% polydimethylsiloxane stationary phase (SPB-1 SULFUR, Supelco, Bellefonte, PA), which presented better resolution and higher loading capacity, separating the greatest number of compounds in the cheese sample, i.e., 58 components. On the other hand, on the 30 m  $\times$  0.32 mm i.d., 1.0  $\mu\text{m}$   $d_f$  and 60 m  $\times$  0.25 mm i.d., 1.0  $\mu\text{m}$   $d_f$  columns coated with identical stationary phase, respectively, 47 and 57 compounds were identified, respectively.

Moreover, dairy flavor GC analyses are commonly carried out using detection systems that do not provide structural information of the analyzed molecules, such as flame ionization detector (FID) or thermal conductivity detector (TCD), and also flame photometric detector (FPD) or pulsed FPD (PFPD); the latter two being selective for sulfur-containing compounds, such as hydrogen sulfide, carbonyl sulfide, and methanethiol. The use of an SPME–GC system equipped with a PFPD has been reported in a study performed over a period of 20 months on volatile sulfur compounds formed in heat-shocked and pasteurized milk cheese [20]. The authors were able to outline that only hydrogen sulfide and dimethyl disulfide increased in the initial stage of cheese-aging and reached a plateau, whereas methanethiol, dimethyl sulfide, and dimethyl trisulfide continued to develop as the cheese aged. Moreover, it could be observed that Cheddar cheese made from heat-shock milk developed higher concentrations of methanethiol, dimethyl sulfide, dimethyl disulfide, and dimethyl trisulfide than cheeses made from pasteurized milk. The simultaneous usage of FID and FPD has also been applied to the study of Cheddar [21] and Limburger cheeses [22]. A further detection system used for dairy flavor analysis is the nitrogen phosphorous detector (NPD), which, owing to its high selectivity for nitrogen-containing compounds, has been applied to investigate the presence of trimethylamine in cow milk samples; this compound, when present in high concentrations, is responsible for a fishy off-flavor [23].

When dairy flavor GC analyses are carried out using FID, TCD, or other detection systems that do not provide analytes structural information, retention indices are commonly used to assist peak assignment. The most thoroughly studied, diffused, and accepted retention index methods are based on the logarithmic-based equation developed by Kováts in 1958 [24] for isothermal conditions, and on the equation propounded by van den Dool and Kratz in 1963 [25], which does not

use the logarithmic form and is used in the case of temperature-programming conditions. Both the proposals are based on the fact that each analyte is cited in terms of its position between the two compounds in a homologous series (e.g., *n*-alkanes) that bracket its retention time. It shall be outlined that the index calculation is based on a linear interpolation of the carbon chain-length of these bracketing paraffins.

When *n*-alkanes are used, it is accepted that the reproducibility of the retention indices between different laboratories are comprised within an acceptable range of  $\pm 5$  units for methyl silicone stationary phases, and  $\pm 10$  units for polyethylene glycol phases. Moreover, in practice, any homologous series presenting a linear relationship between the adjusted retention time, being logarithmic-based or not, and the carbon number can be used; e.g., fatty acid ethyl esters (FAEEs) or fatty acid methyl esters (FAMEs), employed according to the stationary phase to be used.

### 29.3.1.2 Gas Chromatography Coupled with Mass Spectrometry

The advent of combined GC and MS marked a real turning point for flavor research, and during the past decade, tremendous growth in popularity of mass spectrometers as a tool for routine analytical experiments as well as fundamental research could be observed.

A mass spectrometer produces an enormous amount of data, especially in combination with chromatographic sample inlets [26]. Over the years, many approaches to the analysis of GC/MS data have been proposed including diverse library search algorithms, many of which are quite sophisticated, to detect, identify, and quantify all the chromatographic peaks. As a consequence, a large number of studies started to exploit the mass spectral information for peak identification; the most frequent and simple identification method comprises the comparison of the acquired unknown mass spectra with those contained in a reference mass spectral library. In addition, the use of retention indices, in conjunction with the structural information provided by the mass spectrometer, is widely accepted to increase the reliability of the analytical results and address the qualitative determination of the compositions of complex samples by GC/MS; it is widely accepted to use retention indices to confirm the identity of the compounds.

The GC/MS, one of the most popular techniques employed in the investigation of dairy food flavors, has been applied to a wide range of samples. Obviously, it is not feasible to report all the research works carried out on dairy flavor analysis, and hence, some examples were chosen to illustrate its usefulness.

Dirinck and De Winne made use of a GC/MS system to determine the flavor of Gouda and Emmental cheeses, aiming to establish the biotechnological process towards typical cheese-flavor characters [27]. The volatile fractions of three Gouda cheeses from different producers and three Emmental cheeses from different origins (Swiss, French, and Austrian) were isolated by SDE and analyzed, and the results were submitted to principal component analysis (PCA). It could be outlined that the Gouda cheeses from different producers presented similar flavor profile, while the Emmental cheeses presented origin-dependent profiles. However, the Austrian sample could be clearly differentiated from the French and the Swiss samples.

A further interesting example of the use of GC/MS for cheese flavor analysis was reported by Barbieri et al. [28], who studied the volatile profile of 21 Parmesan cheese samples of certified origin and aging. Prior to GC and GC/MS analyses, the flavor components were isolated by means of DHS and SDE. The former technique enabled the isolation of the most volatile compounds, whereas the latter was also suitable to extract other important flavor components, such as long-chain carbonyl derivatives, acids, esters, and lactones. A total of 167 compounds were identified, including hydrocarbons, aldehydes, ketones, alcohols, esters, and acids. Furthermore, free fatty



acids and volatile products of lactic fermentation (ethanol, acetaldehyde, diacetyl, and acetoin) were also determined. In addition, spray-dried skimmed milk flavor was investigated by means of GC/MS [29]. Prior to GC and GC/MS analyses, the sample was homogenized with water, and the volatiles were isolated by SDE using diethyl ether as solvent; a total of 187 out of 196 detected components could be identified by using mass spectral information and retention indices obtained in GC analysis.

Quantitative analyses of dairy flavors have also been performed using GC/MS, as reported by Fernández-García [30], who applied an automatic headspace injector connected to a GC/MS system to quantify the flavor of the Spanish artisanal Afuega'l Pitu cheese throughout ripening period. The standard addition method, using ethyl propionate, and camphor as internal standards, accompanied by standard addition calibration to compensate the matrix effect, was applied to quantify 17 of the 40 compounds identified in the cheese headspace profile. Moreover, within the concentrations used, most of the volatile compounds presented good linearity ( $r > 0.99$ ). According to the author, the cheese aroma profile changed qualitatively and quantitatively during the ripening period of 30 days. During the first two ripening weeks, ethanol, diacetyl, acetoin, 2-methyl-1-propanol, 3-methyl-1-butanol, and acetic acid were the major compounds, while in the following 2 weeks, the concentration of the ethyl esters of fatty acids, acetaldehyde, and sulfur compounds increased.

### 29.3.1.3 *Dairy Food Flavor Analysis by Means of Comprehensive Two-Dimensional Gas Chromatography*

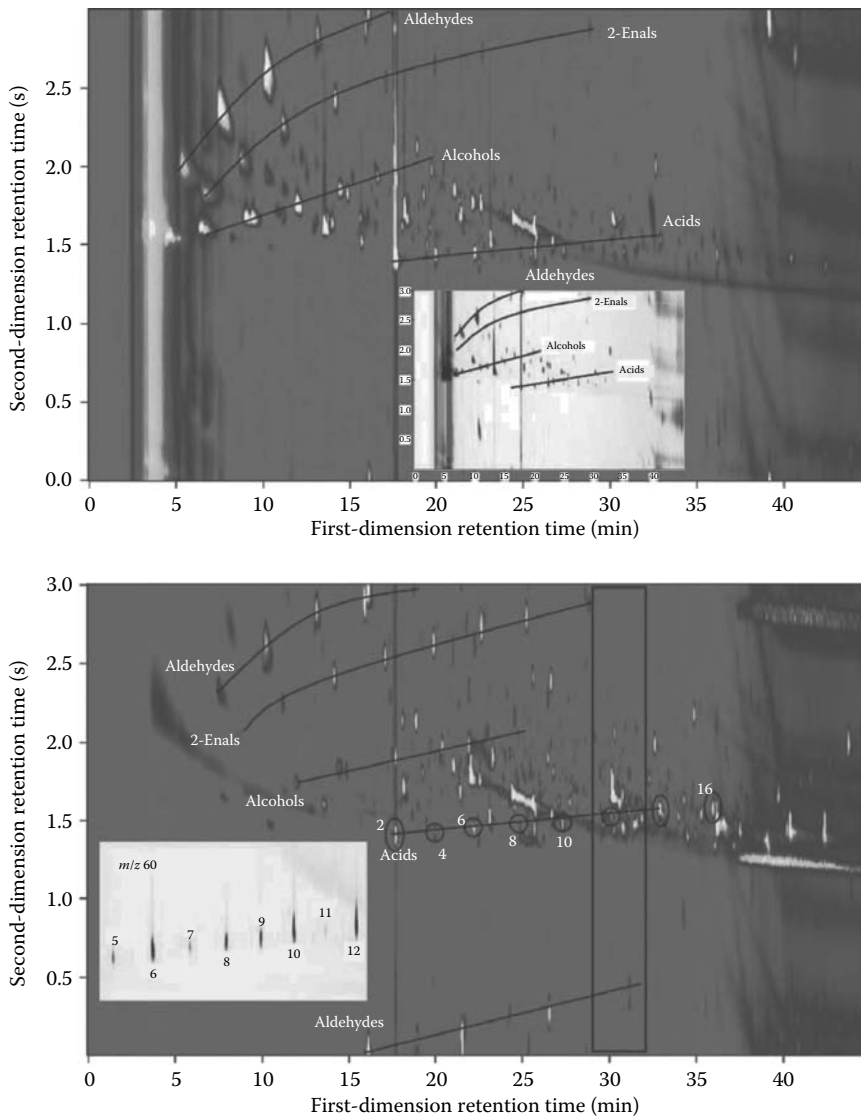
The butter flavor has been analyzed not only by GC/MS, but also by comprehensive two-dimensional GC (GC  $\times$  GC) and GC  $\times$  GC coupled with a time-of-flight mass spectrometer (GC  $\times$  GC-TOF-MS). The first approach was applied to characterize the polar flavor compounds of that matrix, which were collected from the aqueous fraction of butter by means of SPE, allowing the enrichment of the trace-level compounds [31]. Moreover, fresh and heated butter were analyzed on the polar stationary phase, and the identification and quantification of trace-level compounds were carried out. Significant changes in the flavor-compound pattern caused by thermal treatment could be observed; a 500–1000-fold increased concentration of maltol and substantial amounts of furaneol were detected.

The second technique, GC  $\times$  GC, also widely applied to food analysis, produces an orthogonal two-column separation, with the complete sample transfer achieved by means of a modulator; the latter entraps, refocuses, and releases fractions of the GC effluent from the first dimension ( $^1D$ ) onto the second dimension ( $^2D$ ) column, in a continuous mode. This method enables an accurate screening of complex matrices, offering very high resolution and enhanced detection sensitivity [32,33]. Moreover, the two columns must possess different separation mechanism. A two-dimensional separation can be considered as comprehensive, if the other two conditions are appreciated [34,35], *viz.*, equal percentages of all the sample components pass through both the columns and eventually reach the detector; and the resolution obtained in the first dimension is essentially maintained.

Adahchour et al. [36] applied GC  $\times$  GC to analyze butter flavor using the same general setup, as in the previously mentioned GC/MS study [31], with identical target analytes and experimental parameters (heat treatment and storage effects). The authors aimed to compare the two methods of the analysis, monodimensional GC and GC  $\times$  GC. For polar flavor compounds collected by means of SPE, GC  $\times$  GC using a polar–midpolar column set dramatically improved the overall separation, enabling a more reliable analysis of the target compounds, rapid recognition of

prominent classes of compounds on the basis of ordered structures, and provisional identification of a much larger number of unknown compounds.

In addition, the headspace of the butter samples, adjacent to the aqueous fraction, was analyzed by means of SPME. The butter volatile headspace was satisfactorily characterized by GC×GC. In Figure 29.1, the chromatograms of the heated grass butter flavors extracted with two different



**Figure 29.1** GC×GC-FID chromatograms of “grasboter” heated at 170°C and extracted by Carboxen/PDMS fiber (top); in the insert, the profile of the identical sample heated at 40°C is represented. In the chromatogram of the extraction at 170°C by Carbowax/DVB fiber (bottom), the numbers 2–16 indicate carbon numbers of the circled acids. In the insert part of GC × GC–TOF–MS, ion traces  $m/z$  60 showing both even- and odd-numbered fatty acids are presented. (Reprinted from Adahchour, M. et al., *J. Chromatogr. A*, 1086, 99, 2005. With permission.)

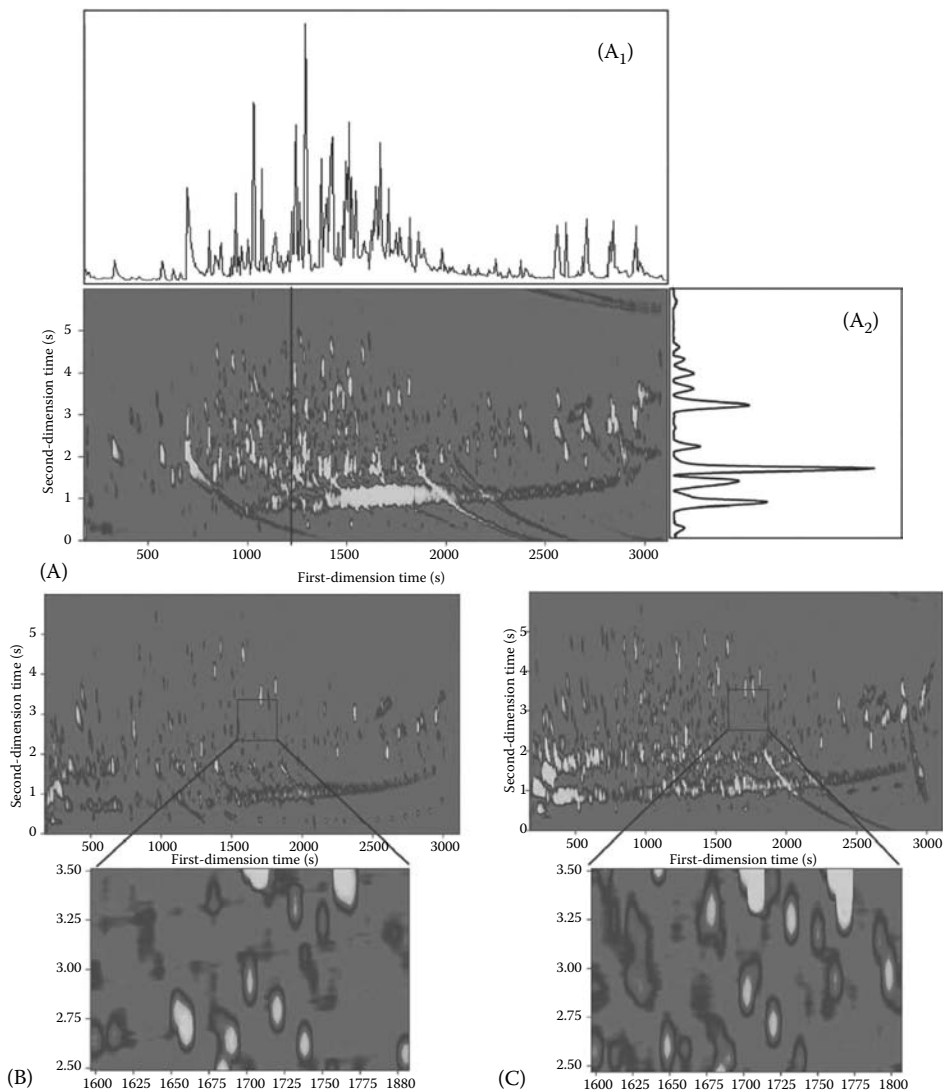
SPME fibers are shown. It could be observed that the Carboxen/polydimethylsiloxane (PDMS) fiber presented an increased affinity to more volatile compounds, while the Carbowax/divinylbenzene (DVB) fiber had an affinity to the less volatile flavors. It has to be pointed out that the complexity of the headspace increased at higher temperatures. As can be observed in the chromatograms, several classes of compounds, such as aldehydes, 2-enals, alcohols, and fatty acids form ordered structures in the GC  $\times$  GC plane. For illustration, some of the fatty acids are circled and indicated according to their carbon number in the bottom chromatogram in Figure 29.1. The acids detected in these samples ranged from formic ( $C_1$ ) to hexadecanoic ( $C_{16}$ ) acid, with dominant even-numbered carbons along with the odd-numbered fatty acids, which are indicated in the insert showing the GC  $\times$  GC-TOF-MS ion traces  $m/z$  60.

The improvement obtained by replacing the monodimensional GC by GC  $\times$  GC was considerable in the case of TOF-MS detection also, as illustrated by the high match factors generally obtained during identification. The results demonstrated that the two utilized sampling techniques are complementary; SPE gave more detailed results on the polar part of the sample, while SPME provided an overview of its headspace (including nonpolar analytes).

Furthermore, GC  $\times$  GC coupled with a time-of-flight mass spectrometer (GC  $\times$  GC-TOF-MS) has also been applied to investigate the dairy and nondairy sour-cream flavors [37]. The extracts were obtained by SAFE and cold-finger (CF) distillation, and were analyzed on a nonpolar-midpolar column set. As expected, the authors demonstrated improved separation and identification, and more importantly, the ng/g-level quantification was more reliably performed. Peak assignment was based on the peak table generated by the GC-TOF-MS software after data processing and the additional use of well-ordered patterns in the  $^2D$ -plane; moreover, information from  $^2D$  retention times helped in the identification of the unknowns. In Figure 29.2, full-scan GC  $\times$  GC chromatograms of the nondairy (Figure 29.2A and B) and dairy (Figure 29.2C) sour-cream extracts are represented as color plots in the elution ranges from *n*-octane to *n*-octadecane.

### 29.3.1.4 *Odor-Activity Assessment by Means of Gas Chromatography-Olfactometry*

The description of a gas chromatograph modified for sniffing its effluent to determine the volatile odor activity, was first published in 1964 by Fuller et al. [38]. The introduction and diffusion of GC-O proved to be vital for the development in the research field of odor-active compounds, providing valuable information on the chromatogram regions that required attention and resources. GC-O is a unique analytical technique which associates the resolution power of capillary GC with the selectivity and sensitivity of the human nose. Consequently, GC-O provides not only an instrumental, but also a sensorial analysis. The latter is defined as a science responsible for the quantification of the human responses to the stimuli perceived by the senses of sight, smell, taste, touch, and audition [39,40]. In addition, it is worth to highlight that the verbal expression of quality is of great importance in sensorial analysis, as well as in GC-O, to achieve normalized responses from the human perception. As a consequence, the development of glossaries of olfactive descriptors adequate for each food matrix is of great importance, and most commonly, the panels create their own list to describe the notes of the product under investigation. However, it is important to outline that in GC-O analysis, synergistic or suppressive effects of different odorants present in a dairy food matrix are not considered, and the sample preparation steps may deprive some of the characteristics of the real matrix. In general, the compounds detected as odor-active in GC-O are most likely to be significant. However, the investigated extract could be too concentrated and



**Figure 29.2** GC×GC–TOF–MS chromatograms of sour-cream extracts. (A) CF distillation of a nondairy sour-cream extract with its reconstructed <sup>1</sup>D chromatogram (A<sub>1</sub>) and the intersection across the second dimension of the plane of the marked region (A<sub>2</sub>); (B) SAFE of the same nondairy sour-cream extract, and (C) SAFE of a dairy sour-cream extract. (Reprinted from Adahchour, M. et al., *J. Chromatogr. A*, 1019, 157, 2003. With permission.)

hence, may present odor-active compounds in GC–O, but not in the dairy food, or the compounds might not be odor-active in GC–O owing to an insufficient concentration of the extract, but still contribute to the odor of the food matrix.

The training of panelists, more precisely of the human noses, and the data-handling methods began to include some of the practices commonly used in sensory testing. Over the last decades, GC–O has been largely used in combination with sophisticated olfactometric methods that were

developed to collect and process the obtained data, and thus, to estimate the sensory contribution of a single odor-active compound. The GC-O methods are commonly classified into four categories: dilution, time-intensity, detection-frequency, and posterior-intensity methods.

Dilution analysis, the most-commonly applied method, is based on the successive dilutions of an aroma extract, until no odor is perceived by the panelists. The dilution series of the original aroma extract are evaluated and the key odorants are ranked in the order of potency. This procedure, usually performed by a reduced number of assessors, is mainly represented by combined hedonic aroma response method (CHARM) [41], developed by Acree et al., and aroma extraction dilution analysis (AEDA), first presented by Ullrich and Grosch [42].

The dilution method CHARM has been applied to determine the key odorants of ovine milk, derived from animals subjected to distinct diets (natural pasture, grass meadow, and mixed grain rations), investigating the effects of the diet on milk flavor [43]. The key-odor notes were observed to be similar for all the three samples, although differing in intensity. Ethyl butanoate and ethyl hexanoate were reported as potent for all the three diet types, while heptanal, octanal, and nonanal were more relevant for the milk obtained after the mixed grain ration diet. Compounds, such as 1-octen-3-ol, dimethylsulfone, and indole presented higher odor potency in the milk produced by the ewes fed with natural pasture and grass meadow.

The AEDA is the most frequently reported GC-O method applied to dairy flavor investigations. An interesting application was carried out on the Cheddar cheese, one of the best studied varieties, analyzed for the first time by means of GC-O in 1995, when Christensen and Reineccius performed an investigation on the odor-impact compounds present in 3-year-old cheeses [44]. The components that presented a higher impact, based on their dilution factor were ethyl acetate, 2-methylbutanal, 3-methylbutanal, 2,3-butanedione,  $\alpha$ -pinene, ethyl butyrate, ethyl caproate, 1-octen-3-one, acetic acid, and methional, followed by several acids. However, it is important to outline that according to the authors, AEDA was not the optimal method as it did not enable a complete determination of the volatile odor fraction that would include the assessment of hydrogen sulfide, acetaldehyde, and methanethiol.

Another interesting research applying AEDA was performed on the volatile aroma fraction of the two sharp Cheddar cheeses of British Farmhouse origin [45]. The identification of some specific flavor notes was successfully carried out, and *p*-cresol was characterized to be chiefly responsible for the so-called cow-resembling and phenolic note, whereas an intense soil-like odor could be related to 2-isopropyl-3-methoxypyrazine. At a much lower odor intensity, 2-isobutyl-3-methoxypyrazine contributed to the earthy, bell pepper-like odor elicited by the samples. It must be noted that the concentrations of *p*-cresol and 2-isopropyl-3-methoxypyrazine were lower in the core than in the rind of the same wedge of cheese.

Furthermore, the time-intensity methods, such as OSME (Greek word for odor), are based on the immediate recording of the intensity as a function of time by moving the cursor of a variable resistor [46]. The OSME has been successfully applied to the analysis of mature Cheddar cheese flavor buccal headspace extracts, for the determination of its odor profile during human consumption [16]. The BHA extract, briefly described in Section 29.2, was compared with that obtained by vacuum distillation by means of OSME-based GC-MS-O investigations. However, it is worth to outline that vacuum distillation extracts do not necessarily represent the compounds that are perceived by a person during the eating process, while BHA extracts comprise volatile compounds that are displaced during the mastication of a food matrix, in concentration ratios that stimulate the olfactory epithelium. The GC-MS-O analyses and OSME, performed by two panelists, enabled the determination of the contribution of individual compounds to the aroma of the mature Cheddar cheese; the time-intensity data were then analyzed using PCA,

providing a so-called principal aromagram. The analytical column's effluent was split to the MS and sniffing port at a ratio of 1:20, respectively, and the time-intensity data were recorded on a module using a 100 mm unstructured line scale and a modified computer mouse that incorporated a resistance to movement. The modified mouse allowed the assessors to relate the perceived odor intensity to the physical stimulus of hand pressure. According to the principal aromagram intensity measurement, representing the weighted average of each assessor's time-intensity data, the BHA extract was characterized mainly by ethyl hexanoate, ethyl butyrate, methional, ethyl hexanoate, octanal, and dimethyl trisulfide. Furthermore, 11 unknown compounds were considered relevant to the odor of the matrix, giving an earthy, garlic-like, and raw mushroom contribution to the odor profile. On the other hand, by means of vacuum distillation, a near-complete volatile extract was obtained, which could be distinguished from the BHA extracts by the presence of low vapor pressure odor-active volatile compounds. The odor-potency of this fraction was mainly characterized by the presence of methional, ethyl butyrate, ethyl hexanoate, dimethyl trisulfide, and 3-methylbutanal. The contribution of the earthy note was likewise representative and also of a musty one.

Another approach, the detection frequency method [47,48], used the number of evaluators detecting an odor-active compound in the GC effluent as a measure of its intensity. This GC-O method was performed with a panel of numerous and untrained evaluators; 8–10 assessors were considered as a good agreement between low variation of the results and the analysis time. It must be added that the results attained were not based on real intensities, and were limited by the scale of measurement. The GC-O associated with the detection frequency method was applied in the investigation of yogurt flavor [49]. To extract the delicate and low intense flavor of yogurt, mild sample isolation methods were applied, such as combined SHS and DHS, and preparative SDE under vacuum. Out of the 91 compounds identified by means of GC/MS, 21 had relevant impact on the odor of the sample. These compounds were recorded by pressing a button during the whole sensory impression and the square signal was recorded by the software; each peak's odor description was registered on a tape. The obtained aromagrams were then averaged allowing the odor profile comparisons, and as peak intensities were related to the frequencies of the odor detection, the nasal impact frequency (NIF) profile was subsequently established. In the NIF approach, no intensity measurement was performed, and consequently, peak intensities were not related to the compound's odor intensity, but to their detection frequency. Commonly, peak heights and areas were defined as NIF and surface of NIF (SNIF), respectively. Each panelist participated in  $1/n$  of the final results ( $n$  stands for the number of panelists); if NIF was 100%, all  $n$  panelists detected the odorant [48]. One of these compounds, 1-nonen-3-one, was identified by GC/MS/MS for the first time in a food flavor. Its extremely low odor detection threshold of 8 pg/kg, makes it one of the most potent compounds identified in flavors and off-flavors. In addition, the authors analyzed a milk mixture composed of skimmed milk powder and pasteurized full fat milk, to identify whether flavor compounds are already present in the milk or are generated by the strains. The NIF profiles of the yogurt and milk extracts are illustrated in Figures 29.3 and 29.4, respectively. By considering that the peak areas take into account the possible minor variations of the retention for each of the eight assessors, the SNIF values were used to compare the yogurt and milk aromagrams. It could be observed that the SNIF values of several compounds, such as acetaldehyde, 2,3-butanedione, 2,3-pentanedione, methional, 2-methyltetrahydrothiophene-3-one, and (2*E*)-nonenal, were greatly increased by the fermentation step.

Another GC-O technique, the posterior intensity method [50], proposes the measurement of a compound's odor intensity and its posterior scoring on a previously determined scale. This posterior registration of the perceived intensity may cause a considerable variance among the assessors.

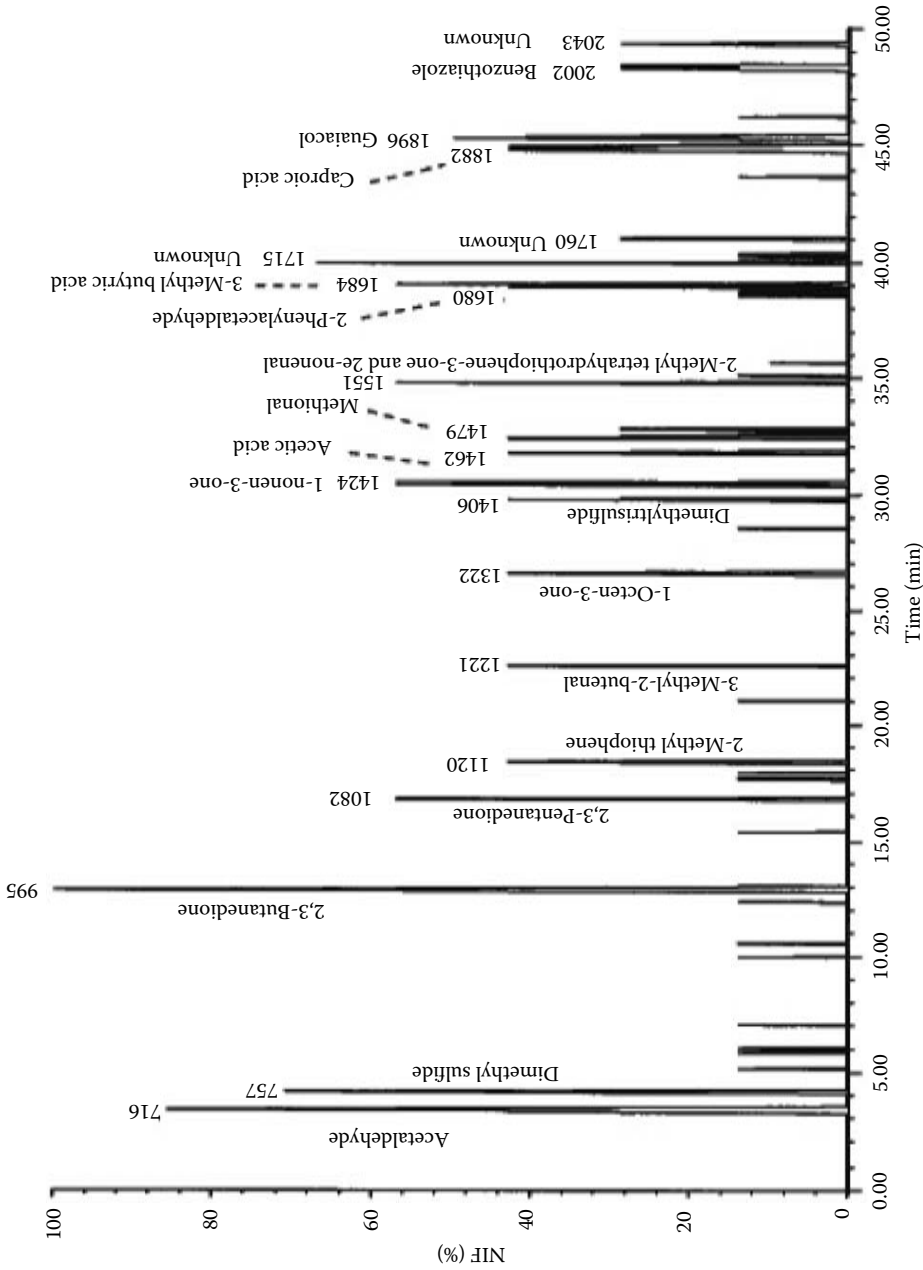
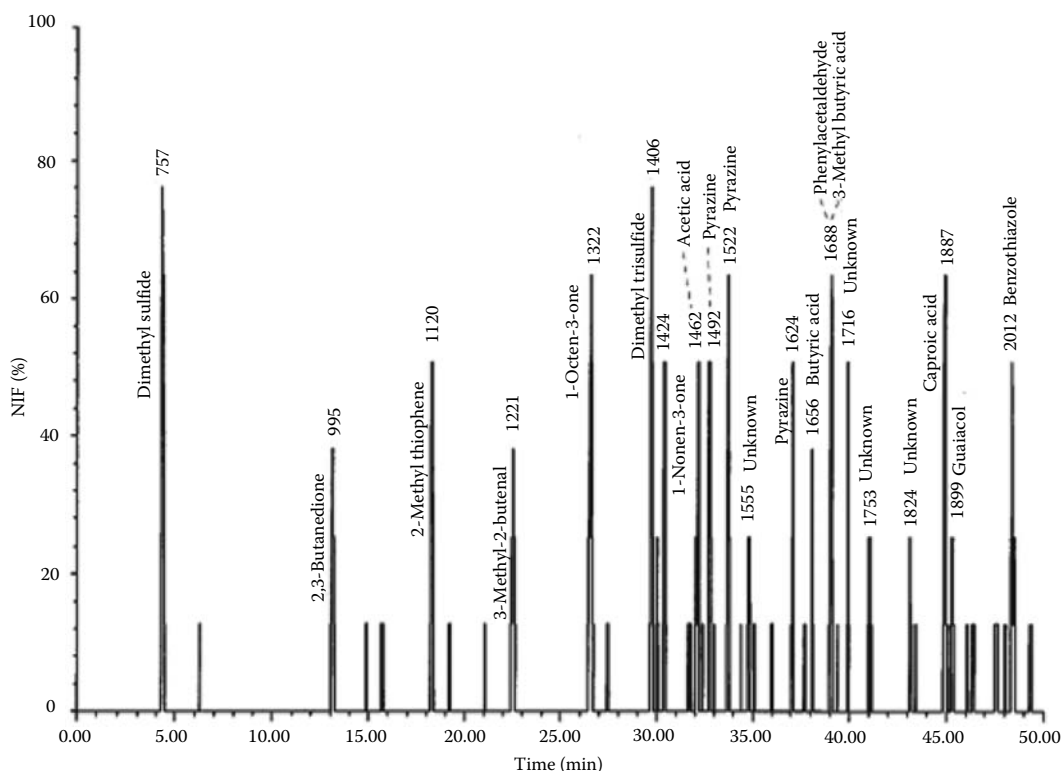


Figure 29.3 NIF profile of the headspace of a yogurt sample (retention indices are showed at the peak apex). (Reprinted from Ott, A. et al., *J. Agric. Food Chem.*, 45, 850, 1997. With permission.)



**Figure 29.4** NIF profile of the headspace of a milk sample (retention indices are shown at the peak apex). (Reprinted from Ott, A. et al., *J. Agric. Food Chem.*, 45, 850, 1997. With permission.)

The attained results may generally be well correlated with the results of the detection frequency method, and to a lesser extent, with dilution methods.

The posterior intensity method was applied for the investigation of a characteristic nutty flavor of some Cheddar cheeses, along with AEDA [51]. The solvent extracts and DHS sampling of young and aged, nutty and not nutty, cheese models were compared. The solvent extracts were analyzed on the capillary columns of distinct polarities, while the DHS samples were examined solely on a polar column. The DHS recovery technique enabled an optimized investigation, revealing that the Strecker aldehydes, such as 2-methylpropanal, 2-methylbutanal, and 3-methylbutanal, imparted a nutty note to that matrix, especially in aged cheeses. On the other hand, in Swiss-type cheese, also classified as a hard cheese, propionic acid was the key compound considered to be responsible for the nutty note [52].

With respect to AEDA, another method known as the aroma extract concentration analysis (AECA) [53], was developed and applied to Camembert cheese analysis [54]. Prior to AEDA, the extract is concentrated by distillation procedures, possibly leading to the loss of volatiles, which may represent a shortcoming of the method. On the other hand, in the AECA, the original volatile extract is first analyzed with GC-O analysis, which was then concentrated stepwise by distilling off the solvent, and subsequently, after each step, an aliquot was analyzed. The volatiles



2,3-butanedione, 1-octen-3-one, 1-octen-3-ol,  $\beta$ -phenethyl acetate, 2-undecanone,  $\delta$ -decalactone, butyric acid, and isovaleric acid were found to be fundamental for Camembert aroma. An interesting aspect was the coelution of 1-octen-3-one and 1-octen-3-ol on a nonpolar stationary phase, which could be separated on a polar phase and analyzed by AECA. The authors assumed that the odor intensity of 1-octen-3-ol might have been enhanced by the corresponding ketone, 1-octen-3-one, both eliciting a mushroom-like note. In addition, further GC-O analyses carried out on the SHS sample suggested that methanethiol and dimethyl sulfide might also play a significant role. The mushroom, floral, and garlic notes in Camembert aroma, as described by Dumont et al. [55], were related to 1-octen-3-ol,  $\beta$ -phenethyl acetate, and dimethyl sulfide, respectively.

A further method, the dynamic headspace dilution assay (DHDA), was applied by Zehentbauer and Reineccius on a mild Cheddar cheese variety [56]. Dilution was made through a stepwise decrease of the purge time, starting with 30 min, which was equivalent to a flavor dilution (FD) factor of 1, and ending with 20 s, corresponding to FD 64. Each dilution was sniffed by a single evaluator on three capillary columns coated with distinct stationary phases, and the identified odorants were then reported on at least two stationary phases. In addition to the compounds previously identified by means of GC-O analysis of the HS samples applying AEDA [57], namely, methional, 2(5)-ethyl-5(2)-methyl-4-hydroxy-3(2*H*)-furanone (homofuraneol), diacetyl, acetic acid, and butyric acid, by means of DHDA, other key aroma components were identified, such as (*Z*)-4-heptenal, 2-acetyl-1-pyrroline, dimethyl trisulfide, 1-octen-3-one, (*Z*)-1,5-octadiene-3-one, and (*E*)- and (*Z*)-2-nonenal. Moreover, as supported by other authors [16,58], it was pointed out that single volatiles eliciting characteristic Cheddar cheese notes were not identified. Similarly, for the other cheese types, a characteristic odor was defined by the so-called component balance theory [58], based on a wide range of parameters, such as cheese age, microflora, biochemistry, as well as odor extraction methods.

The choice of the GC-O method is extremely important for the correct characterization of a matrix, as the application of different methods to an identical real sample can distinctly select and rank the odor-active compounds according to their odor potency and/or intensity. Commonly, detection frequency and posterior intensity methods provide similar odor intensity/concentration relationships, while dilution analyses investigate and attribute odor potencies.

An example of the application of the two methods, OSME and AEDA, was reported to estimate the most potent odors of DHS samples [59]. The latter was carried out on both polar and nonpolar stationary phases, while the former was performed only on a polar stationary phase. Acetaldehyde, 2-methylpropanal, 3-methylbutanal, ethyl hexanoate, dimethyl trisulfide, and methional were identified as intense odorants by OSME, and were found to possess the highest FD values by AEDA. In addition, the latter method also enabled the determination of further potent odorants, such as ethyl butyrate, diacetyl, DMHF, 2-methylbutanal, 2,6-dimethylpyrazine, 2-heptanone, and 2,4-hexadienal.

An enormous number of dairy food matrices have already been studied by means of GC-O, and have been briefly reviewed by Friedrich and Acree in 1998 [9]. In addition, Curioni and Bosset published an overview focused on GC-O analysis of various types of cheeses [60].

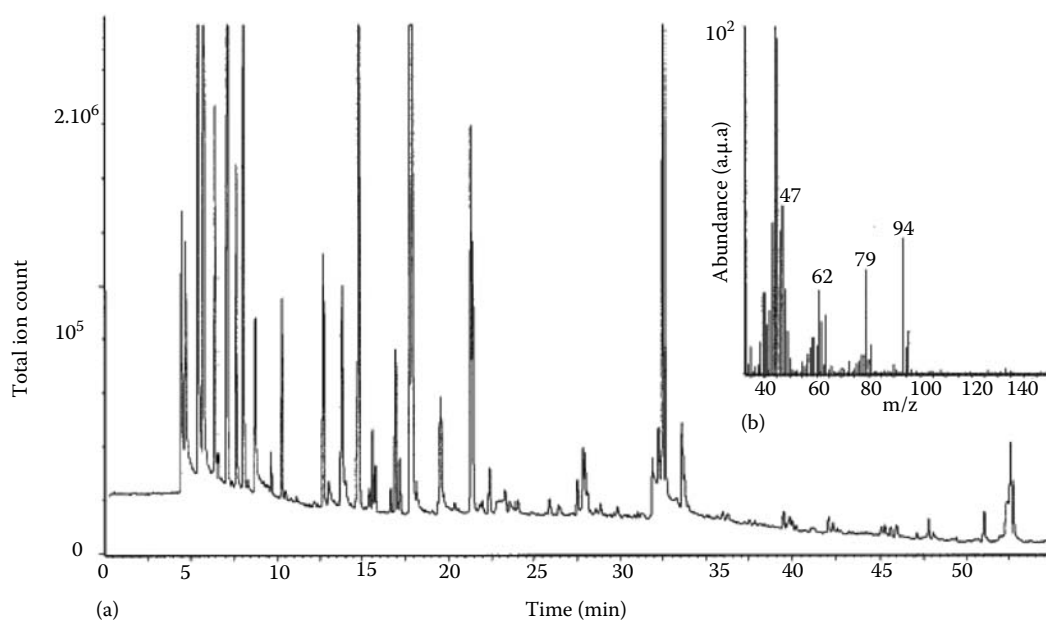
### 29.3.1.5 *Dairy Flavor Fingerprint Acquisition through Mass Spectrometry*

It has been demonstrated that the rapid analysis of the volatile fraction of food products by MS is a valuable approach to classify or predict quality features, and nonseparative methods, such as SPME-MS, DHS-MS, and SHS-MS, are useful in the acquisition of a sample's fingerprint.

In 1999, Marsili proposed the use of SPME–MS associated with multivariate analysis (SPME–MS–MVA) for the investigation of off-flavors in milk [61]. The system, also defined as the mass detection-based electronic nose, was composed of a GC/MS instrument, in which the GC injection port was used for the thermal desorption of the 75  $\mu\text{m}$  Carboxen/PDMS SPME fiber, and instead of an analytical column, an uncoated fused silica line (1 m  $\times$  0.25 mm i.d.), kept at 50°C, was used as a transfer line to the MS system. Mass fragmentation data derived from the unresolved milk volatile components were subjected to MVA. The PCA based on SPME–MS–MVA permitted the classification of the samples by the origin of off-flavors, and thus, the differentiation of the control reduced-fat milk (2% butterfat content) samples from those affected by light, heat, copper, and microbial contamination. The shelf-life prediction of the pasteurized and homogenized reduced-fat milk and whole-fat chocolate milk was also carried out by SPME–MS–MVA [62]. The SPME, using a Carboxen/PDMS fiber, enabled the extraction of volatile bacterial metabolites from the matrices, and both the milk types were sampled six times over a period of 7 months. Mass fragmentation profiles from the unresolved milk volatile components were normalized to the intensity of the internal standard mass peak (chlorobenzene,  $m/z$  112) and subjected to MVA. By using prediction models based on PLS regression of mass intensity lists, the samples' shelf-life prediction was established to be of about 1 day ( $r > 0.98$ ). Moreover, the use of two-dimensional PCA plots also made it possible to classify unpalatable samples affected by microbial as well as nonmicrobial sources, such as copper or sanitizer contaminations.

A similar approach was applied for the characterization of cheeses [63], but by using a narrower transfer line, i.e., 1 m  $\times$  0.10 mm i.d., heated to 210°C. Five samples of Camembert at different stages of ripening were investigated. For data analysis, the mass fragments of each spectrum, ranging from 45 to 150 amu, were considered as potential descriptors of the composition of the headspace of the cheeses. In Figure 29.5a, the SPME–GC/MS chromatographic profile of one of the samples is presented, while in Figure 29.5b, the reconstituted average spectrum obtained by SPME–MS is shown; fragments of  $m/z$  47, 62, 79, and 94 are the characteristic of compounds, such as methanethiol, dimethyl sulfide, dimethyl disulfide, and dimethyl trisulfide, respectively. The batches of investigated cheeses were then classified on the basis of a limited number of mass fragments selected by stepwise discriminative analysis. According to the authors, SPME–MS provided a rapid quality control with minimized thermal, mechanical, and chemical modifications of the matrix, thereby, reducing the risk of artifact formation.

Proton-transfer reaction-mass spectrometry (PTR–MS) is a relatively new technique, which allows fast and accurate determination of the concentration of volatile organic compounds down to the ppt range [64]. The PTR–MS was used along with GC–O to deduce the volatile profile of three Grana cheeses: Grana Padano, Parmigiano Reggiano, and Grana Trentino [65]. For GC–O analyses, the volatile compounds were extracted by DHS, while for PTR–MS, the headspace formed over the cheese was directly assessed. The PTR–MS analysis revealed that 50 masses (parent and fragment ions) gave a significant contribution, with at least 60 compounds being tentatively identified. On the other hand, GC–O analysis characterized 11–14 compounds being responsible for the basic odor profile of Grana cheeses, revealing ethyl butanoate, 2-heptanone, and ethyl hexanoate, all eliciting fruity notes, as the major contributors to the cheeses flavor. Other low-odor threshold compounds, such as methional and 1-octen-3-one were indicated as contributors to the characteristic flavor of the sample, although not being detected by the FID, but by PTR–MS. Thus, the successful use of GC–O to determine the odor-active compounds of the cheeses' headspace was confirmed, while PTR–MS presented to be a useful tool for the quantification of odor-active and nonactive compounds present in the cheeses' volatile fraction.



**Figure 29.5** SPME-GC/MS chromatogram of a Camembert cheese sample (extraction by Carboxen/PDMS fiber in the headspace at 20°C for 10 min) (a), and a reconstitution of an average spectrum obtained by SPME-MS (0–55 min) (b). (Reprinted from Pérès, C. et al., *Anal. Chem.*, 73, 1030, 2001. With permission.)

### 29.3.1.6 Electronic Nose and Tongue in Dairy Flavor Analysis

It is well-known that the flavor of dairy food is considered as an indicator of its quality and product conformity, though flavor quality-control assessments in food industries are difficult, owing to the lack of reliable odor-assessing instruments and the difficulty in using sensory panels for the continuous monitoring of a product's odor. Since 1991, research has been conducted to develop technologies that could detect and recognize odors and flavors using the so-called artificial senses, whose function is to reproduce human senses using sensor arrays and pattern-recognition systems. The first electronic system created to measure odors was the electronic nose (e-nose), whose name was derived from the fact that its main task is to mimic the human olfaction. The system is based on the combination of a gas-sensor array with broad and partly overlapping selectivity patterns and multivariate data analysis (MVDA). Nonseparative mechanisms are used to represent a perceived odor or flavor as a global fingerprint. A further system widely applied in food industries is the electronic tongue (e-tongue or taste sensor), based on the concepts similar to the e-nose, but in aqueous solution. While e-noses are related to olfaction, e-tongues are related to the sense of taste.

Moreover, it is worthwhile to point out that several e-nose sensors have already been reported in literature, such as metal oxide semiconductors (MOS), conducting polymers (CP), quartz crystal microbalance (QCM), surface acoustic wave (SAW), and field effect transistors (MOSFET) [66]. The recently developed e-nose techniques also use MS or ultrafast GC as the detection systems. The MS-based e-noses have already been mentioned in Section 29.3.1.5. On the other hand, e-tongues are generally based on potentiometry or voltammetry [67].

The utilization of e-noses have been reported in the investigations of several aspects of dairy flavor, such as for the early detection of spoilage bacteria and yeast in milk-based media using a system composed of 14 CP sensors [68], and also for the discrimination of three different resistant bacteria, occurring isolated or as a mixture of all the three strains cultured in milk utilizing an e-nose consisting of 10 MOSFET, 5 MOS, and an infrared-based CO<sub>2</sub> sensor [69]. An e-nose system, composed of 12 MOS sensors, has also been implemented to monitor flavor changes related to the maturation of Danish blue cheeses [70]. Though it is worth to highlight that the ripening process could be successfully monitored, this system presented some limitations in the determination of the cheeses' maturity stage owing to the similar flavor profile observed for 2- and 4-week-old cheeses. A similar investigation was performed by the same research group, but using a system equipped with 14 CP sensors [71]. In the latter work, the authors were able to classify the ripening age of the products from different units, as well as different products from the same unit. Furthermore, the infant milk-powder formulas, English Cheddar cheese, pasteurized whole milk, and butter were also subjected to e-nose studies [72]. The use of e-noses in dairy flavor analysis has been extensively reviewed by Ampuero and Bosset in 2003 [73].

The utilization of e-tongues in dairy products analysis is not often reported, mainly owing to the harsh conditions of the industrial processes, specially cleaning procedures and the large material restrictions in the dairy industry. Taking the latter aspect into consideration, Winquist et al. [67] described a voltammetric e-tongue, specially designed to monitor the sources of raw milk coming to an industrial dairy process, as well as the cleaning process. The e-tongue consisted of four working electrodes made of gold, platinum, rhodium, and stainless steel, embedded in polyetheretherketone (PEEK™) and mounted in a housing of stainless steel, which was inserted in the process line for direct online measurements. An e-tongue based on pulsed voltammetry was also applied in the study of milk-quality deterioration owing to microbial growth during storage at room temperature [74]. The system consisted of a reference, auxiliary, and working electrodes; the latter was represented by five wires of different metals (gold, iridium, palladium, platinum, and rhodium). The data obtained were examined with PCA and the deterioration process could be clearly observed; moreover, prediction models could be prepared by using projections to latent structure and artificial neural networks.

### 29.3.2 Sensorial Dairy Flavor Analysis

As previously defined in Section 29.3.1.4, sensorial analysis uses panels of human subjects to evaluate a material or product. In general, sensory testing may be divided into two categories: hedonic and analytical tests. Hedonic tests are designed to assess the effect caused by the material or product under investigation, such as pleasant or unpleasant, determining the consumers' preferences. Therefore, these tests are carried out using a large number of untrained panelists, selected to be the representative of the population as a whole. On the other hand, analytical tests preferentially use smaller panels composed of specially selected and trained evaluators, and can be divided into discriminative and descriptive tests. The former are designated to determine whether a perceptible sensory difference exists between the samples as well as to find the thresholds and sensitivity, while the latter are performed to describe a material or product in terms of a number of predetermined descriptors.

All the methods were carried out using an extensively trained panel to ensure that the descriptors in use are well understood and the quantitative score of the samples against different descriptors is reliable. The distinct classes of analytical tests aim to address different questions, and in

all cases, it is necessary to carefully select the individual panel members, ensuring appropriate sensitivity to a wide range of odorant types and normalized responses.

### 29.3.2.1 *Odor-Activity Value Determination*

The screening of significant odorants in food samples has not only been extensively studied by means of GC-O dilution methods, but also through the odor-activity value (OAV) concept. As previously described in Section 29.3.1.4, in dilution methods, the identified key odorants are ranked in the order of potency, and the highest dilution at which a substance is sniffed is represented by its FD value. The latter value is considered as proportional to the OAV evaluated in air [75]. Both the methodologies are applied for the determination of the flavor compounds that most likely contribute to the overall odor of a food.

In 1957, Patton and Josephson first proposed an estimation of the importance of a flavor chemical in a food, based on the ratio of its concentration in that food to its threshold concentration in that same matrix [76]. Based on this approach, in 1963, Rothe and Thomas derived the OAVs to better correlate the concentration of an odorant with its detection threshold value [77], defined as the lowest concentration or intensity that is perceived by the panelist [75]. Some flavor chemicals may present an increased intensity in odor activity according to a proportional increment of their concentration, while with regard to others, the change in intensity may be the opposite or just less marked. The theoretical intensity of an odorant under any specific set of conditions could be roughly expressed in terms of its OAV, also denoted as odor value, odor unit, flavor unit, and aroma value. However, the difficult and time-consuming determination of threshold values, which vary among and within the panelists [78], caused controversies related to the use of OAVs as indicators of the percent contribution to the overall intensity of a sample.

In addition, the synergistic or suppressive effects of different odorants in a food matrix are not considered in OAV determinations and GC-O analysis. The sample preparation steps may deprive the real food matrix of some of its characteristics. As previously mentioned, the compounds detected as odor-active by means of GC-O are most likely to be significant. However, the investigated extract may be too concentrated and hence, may present odor-active compounds in GC-O, but not in the food sample. On the contrary, it is also true that some compounds might not be odor-active in GC-O owing to an insufficient concentration in the extract, but may still contribute to the overall odor of the food matrix.

Recombined model systems are commonly applied in dairy flavor investigations to study and evaluate sample's characteristics or to confirm the instrumental results. In this respect, model systems for a specific food sample are commonly prepared based on the combination of previously achieved AEDA or CHARM values, and/or OAVs.

Odorants showing higher values are used to formulate the recombined model, which is then compared with the real food product for similarity or difference. The preparation of such models is simple for liquid food matrices, attaining a homogeneous blend of odorants, and satisfactory results were observed in the study of sour-cream butter flavor [78]. However, difficulties arise in the preparation of models for solid foods, as it is not simple to simulate the composition and structure of the nonvolatile fraction of the food and imitate their odorant's distribution. We can overcome this limitation by using suitable inert alternative bases, such as cellulose or sunflower oil.

In omission experiments, on the other hand, a recombined model system is prepared, in which one or more odorants are omitted. In this experiment, the panelists are asked to perform discriminative tests to compare the reduced model with the complete one, and indicate the perceived sensorial differences [79].

Milo and Reineccius [57] investigated and quantified the chemicals responsible for the flavor of regular-fat and low-fat Cheddar cheeses through GC-O analysis of their SHS. The gas chromatograph was connected to a purge and trap system, and equipped with a nonpolar column. The AEDA was also carried out on a cheese-flavor fraction isolated by high-vacuum distillation. The latter analyses were performed on three stationary phases of distinct polarities. Two panelists performed AEDA, and subsequently, the OAVs of the odorants described as potent were calculated on the basis of quantitative data and on sensory thresholds in oil and water. The authors suggested that acetic acid, butyric acid, methional, diacetyl, and homofuraneol were primarily responsible for the pleasant mild aroma of Cheddar cheese. In addition, highly volatile sulfur compounds, such as methanethiol and dimethyl sulfide, contributed significantly to the flavor. Furthermore, the meaty, brothy off-flavor of low-fat Cheddar was related to the high concentrations of methional, DMHF, and mainly, homofuraneol. The higher water content in low-fat cheese, combined with a possible increased microbial activity, was assumed to be the reason for the elevated concentrations of the latter compounds. However, a combination of methanethiol and decanoic acid or butanoic acid in all cheeses gave a better correlation with Cheddar flavor than methanethiol alone [80].

### 29.3.2.2 Analytical Sensory Tests

Analytical sensory tests, either discriminative or descriptive, are widely used in dairy flavor analysis. By definition, discriminative tests are applied to determine whether a perceptible sensory difference exists among the samples, and also to establish the thresholds and sensitivity. These tests are classified as paired comparison (or duo test), triangle, and duo-trio test. On the other hand, in descriptive tests, the lists of descriptors are adopted, which can be quite extensive, and therefore, a more accurate training of the panel is required to ensure that the descriptions are well understood, and the samples are reliably and quantitatively scored. The descriptive tests can be divided into flavor profile method (FPM), quantitative descriptive analysis (QDA), and the Spectrum™ method.

The simplest type of discriminative test, the paired comparison test, has been conducted in the evaluation of vanilla-flavored ice creams, to establish a relationship between perceived difference and expressed preference [81]. In this test, two ice-cream samples were presented to the evaluators and asked whether they preferred one or the other, or did not have any preference. The results were tentatively used to establish when a perceived difference might start translating into a change with regard to the acceptability of the original product, and possibly predict the consumers' perceptions from an in-house semitrained or trained panel, reducing the time duration and the relatively high-cost consumer testing.

Triangle tests have been reported in the study of Camembert cheese flavor [82]. In triangle tests, the panelists assess three samples, two of which are identical, and are asked to select the odd sample. First, the Camembert cheese samples were screened to establish the flavor compounds, subdivided into groups, which contribute to the sample's odor and taste. Subsequently, the intensities of various combinations of the groups were determined in the triangle tests, to identify the groups that contributed to the flavor of Camembert. The three groups described as salty, monosodium glutamate-like, and bitter were rated as very strong, while the amino acids groups defined as sweet and bitter were not found to contribute to the cheese's taste. This test has also been applied to evaluate the effect of lipases on the flavor of ultra heat treatment (UHT) milk [83]. However, in this case, the panelists were asked not only to indicate the sample that differed from the rest, but also to indicate when a rancid flavor was present. The results showed that added lipase had a pronounced effect on the development of rancid flavor.

In the duo-trio tests, a standard sample was presented to the panel, to compare it with the two unknown samples; one of the unknowns being identical to the standard. The panelists were asked to identify which unknown matched the standard. This test has been used in the evaluation of Cottage cheese samples treated with 0.025%–0.20% of potassium sorbate against a standard sample of untreated Cottage cheese [84]. For shelf-life evaluations, the samples were stored at 4°C or 7°C. The minimum level of potassium sorbate detected by the panel was of 0.10%. With regard to the shelf-life of cheeses, the results suggest that concentrations of potassium sorbate of 0.05%–0.10% by weight can be used advantageously to increase the shelf-life of commercial Cottage cheese. These quantities of potassium sorbate retarded the growth of bacteria responsible for the fruity and putrid odors as well as slime in Cottage cheese at refrigeration temperatures, as well as bacteria capable of producing sourness and molds.

The descriptive tests, either FPM or QDA, used a carefully selected and extensively trained panel to eliminate biological variations between the individual panelists. The FPM was developed in the 1950s, and is the first published descriptive sensory technique. Later, in the 1970s, QDA and the Spectrum™ descriptive analysis method [40] were proposed. The latter methods differ from the FPM in that they were developed to use the measurements determined by individual panelists and generate a panel average. On the other hand, in the FPM, a group consensus profile is generated. Moreover, FPM generally uses fewer panelists than the other two methods.

The FPM and its many derivatives have been successfully applied to dairy food analysis, e.g., in the evaluation of the optimal level of *Lactobacillus bulgaricus* to be added to milk to produce a Swiss cheese with more intense flavors, considered as desirable by the panel [85]. In another study, FPM was used in the evaluation of fruit-flavored dairy products, such as strawberry-blended yogurts and apricot-flavored fresh cheeses [86]. The FPM was compared with a recently developed technique known as Flash profile [87], which is based on the combination of free-choice profiling and a comparative evaluation of the whole product set. Analyses were performed using a panel comprising 10 evaluators, extensively trained for the evaluation of fruit flavor in blended fruit yogurt for 25–80 h. Both the fruity flavored dairy products had their flavor profile slightly more discriminated by the Flash profile.

Amongst the most widely applied descriptive tests is QDA, considered as one of the most important tools to study a sample's flavor, appearance, and texture. An example worth mentioning is the descriptive flavor analysis of two different Ragusano cheeses (pasture-fed and total mixed ration-fed) [88]. The analyses were carried out by a panel composed of 12 evaluators, with a glossary of descriptors generated over several training sessions and a score scale ranging from 1 to 15. The panelists were asked to rate the relative intensities of four different classes of attributes (aroma, taste and chemesthetic, consistency, and mouth structure). All data were subjected to PCA, and the significant differences in the sensory and chemical analyses could be observed between the cheeses. A further noteworthy application of QDA was performed in correlation with the PTR-MS spectral fingerprint for the characterization of Grana Trentino cheeses [89]. QDA was performed by eight panelists, trained with a glossary of descriptors containing 30 attributes, though only 6 related to odors and 6 to flavors were taken into consideration during the analyses. QDA and PTR-MS data correlation was made through multivariate calibration capable of modeling and predicting the sensory intensity of many sensory attributes. In conclusion, it is indicated that the information contained in PTR-MS spectra is enough to foresee the value of several QDA attributes and the variability of the overall flavor profile. Moreover, the authors highlighted that the correlation between the chemical indication and sensory data is not a causality, as it is known that more than one volatile compound contribute to the overall perceived complex cheese flavor, and not every measured peak necessarily correspond to a sensory effect.

The other descriptive test, the Spectrum method, was applied to study the flavor of fresh Chevre-style goat cheese [90]. First, the sensory descriptive evaluation was carried out by seven trained panelists. The cheeses were 2 cm<sup>2</sup> cubes with three digit codes, and during evaluation, the panelists had free access to water and unsalted crackers. Flavor and taste intensities were scaled using a 10-point intensity scale, and each cheese sample was evaluated in duplicate. The model system sensory evaluation was then performed to investigate the impact of selected acidic compounds on waxy/animal note of Chevre-style goat cheeses. Based on GC-O and quantification data, hexanoic, octanoic, decanoic, 4-methyl octanoic, and 4-ethyl octanoic acids were selected for the model system analysis. In a first step, these compounds were screened in an unripened cheese system (4% milk fat cottage cheese), then hexanoic acid was added, contributing to a sour, sweaty odor, and was not considered further. On the other hand, octanoic, decanoic, 4-methyl octanoic, and 4-ethyl octanoic acids contributed to waxy, animal, and soapy notes, and were included in the subsequent flavor evaluations. Moreover, the panelists established that a combination of 4-methyl and 4-ethyl octanoic acids at 143 and 187 ppb, respectively, gave the highest similarity to goat cheese, with a 9.5 on the 10-point scale, and that the octanoic and decanoic acids probably contributed to the waxy, animal note as well, but to a lesser degree than the branched-chain fatty acids.

## 29.4 Characterization of Off-Flavors

As previously mentioned, the main sensory attributes to be considered in the assessment of a dairy product are appearance, flavor, and texture, and these may vary in relation to the presence or absence of predetermined defects. It is obvious, therefore, that the dairy industry has acquired a broad knowledge on sensory defects, including their causes and consequences.

Off-flavors are widely defined as an unpleasant odor or taste imparted to a food sample through internal deteriorative change, while taints are imparted through external sources [91]. GC-O is a valuable technique to exploit off-flavors. Rychlik and Bosset [92] applied AEDA to investigate the origin of a potato-like flavor defect that was being observed in the Swiss Gruyère cheese produced by a Swiss village factory. The typical odor of that well-studied hard cheese could be attributed to a series of compounds, such as 2-methylbutanal, 3-methylbutanal, methional, dimethyl trisulfide, phenylacetaldehyde, 2-ethyl-3,5-dimethylpyrazine, 2,3-diethyl-5-methylpyrazine, methanethiol, as well as a variety of acids. The weak potato-like off-flavor could be detected, but the responsible compound was not identified. In another work carried out by the same researchers, the origin of this flavor defect was further investigated [93]. Methanethiol that exhibited the highest OAV in the sample was considered as a possible contributor. Moreover, methional was shown to have a significant impact on the potato-like flavor of the Gruyère cheese investigated. In addition, it could be observed that methional enhances the sweaty odor of 2-methyl butyric acid, 3-methyl butyric acid, and butyric acid, and masks the malty odor of 2-methylbutanal and 3-methylbutanal. It is interesting to highlight that cheese loaves produced in that cheese factory were subjected to different ripening schemes to identify if the defect could be related to ripening conditions or brine application. Finally, the brine and the brine bath were replaced and the defect no longer occurred. In this case the defect, previously defined as an off-flavor, was observed to be a taint.

Another curious off-flavor was the floral, rosy note identified in Cheddar cheese [94], which can be classified as an unclean off-flavor. The GC-O technique along with AEDA was applied, using both the polar and nonpolar capillary columns, and phenylacetaldehyde and phenylacetic acid from the catabolism of aromatic amino acids were reported to be responsible for that undesired note. The latter has also been previously reported in Camembert cheese [54].



The development of off-flavors in butter is a well-studied topic. Badings [95] detected a fishy off-flavor in a cold-stored butter sample. The defect was attributed to the presence of 1-octen-3-one, (*Z*)-4-heptenal, (*E,Z*)-2,6-nonadienal, hexanal, and (*E*)-2-nonenal, which presented high OAVs. On the other hand, Swoboda and Peers [96] indicated (*Z*)-1,5-octadien-3-one, formed by copper-catalyzed oxidation of butterfat, as a key contributor to a metallic odor defect in stored butterfat. Moreover, phospholipids were suggested as precursors in the formation of this metallic off-flavor in butter [97]. With regard to buttermilk odor, its typical mild, sweet-buttery odor is not stable, and during storage, a metallic off-flavor may also be generated; though little is known about the compounds causing this defect. A comparison was made between the impact of odor-active compounds present in fresh, fermented sweet-cream buttermilk and sour-cream buttermilk, on the basis of AEDA results [98]. The latter sample presented a metallic odor note which was formed after a storage period of 4 days at 8°C. In the sweet-cream buttermilk sample, 13 compounds revealed to be key odor compounds, and out of these, nine appeared with significantly higher FD factors in the sour-cream buttermilk, and the increase in FD factors of (*E,Z*)-2,6-nonadienol and the epoxyaldehydes 4,5-epoxy-(*E*)-2-decenal and 4,5-epoxy-(*E*)-2-undecenal, was considered to be the cause of the metallic off-odor developed in sour-cream buttermilk.

Furthermore, Mounchilli et al. [99] investigated the flavor of five milk samples (four off-flavored and one of good flavor quality), extracting the volatiles by HS-SPME and analyzing by GC/MS and GC-O. The composition of all the samples revealed to be nearly identical, differing in the concentration levels; the profile of odor-active compounds of all the four off-flavored samples was identical to those of the good-quality milk. Olfactometric analyses supported the hypothesis that off-flavors were probably caused by the concentration differences of a common subset of compounds, rather than from the absence or presence of specific compounds. Further milk off-flavors worth mentioning are those caused by volatile fatty acids (VFAs) generated as metabolites by the growth of lipolytic psychrotrophic bacteria [61], and the fruity off-flavor related to ppm-level concentrations of ethyl butyrate and ethyl hexanoate [100].

It must be noted that owing to the wide variety of substances belonging to several chemical classes, fresh milk flavor is an effective vehicle for off-flavors. The lability of some of the components triggers the immediate generation of flavor compounds by hydrolysis and oxidation, and also by enzymatic and microbial activities [101].

## 29.5 General Considerations on Dairy Flavor

As described in this chapter, numerous methodologies may be applied to dairy flavor investigation. Many isolation techniques have been developed to yield a product that is representative of the sample, promoting quality improvement of the obtained flavor profiles.

Several instrumental techniques may be utilized, and particularly, GC has evolved into a dominant analysis method providing the greatest resolving power for most of the dairy volatiles. The introduction of GC/MS technique that enables the characterization of structural compounds, and GC-O that permits the differentiation of a multitude of volatiles into odor- and nonodor-active ones, also marked a real turning point in the study of these volatile molecules. The application of MS to dairy food also contributed greatly towards the progress of the knowledge on those flavors being applied for fingerprint acquisition or as MS-based e-noses. Electronic sensors, such as e-noses and e-tongues, utilized for quality-control purposes also enabled the determination of sensory attributes associated with processing variables.

The application of sensorial analysis tests to dairy matrices also represents a breakthrough in the dairy flavor research, acting as a powerful tool for understanding the appearance, flavor, and texture attributes of dairy products, and capable of guiding the consumer's preference.

Moreover, the continuous need to understand the flavor developments owing to heat treatments, storage modalities, fermentation processes, hydrolysis and oxidation reactions, as well as enzymatic and microbial activities, has triggered the analytical and sensorial investigations of dairy matrices.

## References

1. Laing, D. G. and Jinks, A., Flavour perception mechanisms, *Trends Food Sci. Technol.*, 7, 387, 1996.
2. Firestein, S., Electrical signals in olfactory transduction, *Curr. Opin. Neurobiol.*, 2, 444, 1992.
3. Firestein, S., How the olfactory system makes sense of scents, *Nature*, 413, 211, 2001.
4. Malnic, B., Hirono, J., and Sato, T., Combinatorial receptor codes for odors, *Cell*, 96, 713, 1999.
5. van Ruth, S. M., Methods for gas chromatography-olfactometry: A review, *Biomol. Eng.*, 17, 121, 2001.
6. Grosch, W., Determination of potent odourants in foods by aroma extract dilution analysis (AEDA) and calculation of odour activity values (OAVs), *Flavour Fragr. J.*, 9, 147, 1994.
7. Maarse, H. and Visscher, C. A., *Volatile Compounds in Food. Qualitative and Quantitative Data*, 6th edn., Central Institute for Nutrition and Food Research TNO-CIVO, Zeist, 1989.
8. Mariaca, R. and Bosset, J., Instrumental analysis of volatile (flavour) compounds in milk and dairy products, *Lait*, 77, 13, 1997.
9. Friedrich, J. E. and Acree, T. E., Gas chromatography olfactometry (GC/O) of dairy products, *Int. Dairy J.*, 8, 235, 1998.
10. Cronin, D. A., Techniques of analysis of flavours, in *Food Flavours. Part A. Introduction*, Morton, I. D. and MacLeod, A. J., Eds., Elsevier, Amsterdam, 1982, pp. 15–48.
11. Imhof, R. and Bosset, J. O., Comparison of two systems for sample preparation and injection by dynamic headspace GC analysis, *J. High Resol. Chromatogr.*, 14, 621, 1991.
12. Urbach, G., Stark, W., and Forss, D. A., Volatile compounds in butter oil. II. Flavour and flavour thresholds of lactones, fatty acids, phenols, indole and skatole in deodorized synthetic butter, *J. Dairy Res.*, 39, 35, 1972.
13. Badertscher, R., Liniger, A., and Steiger, G., Bestimmung der flüchtigen Fettsäuren in Käse aus dem Wasserdampfdestillat mit "Headspace-GC/FID", *FAM Info*, 272w, 1, 1993.
14. Deibler, K. D., Acree, T. E., and Lanvin, E. H., Solid phase microextraction application in gas chromatography/olfactometry dilution analysis, *J. Agric. Food Chem.*, 47, 1616, 1999.
15. Wardencki, W., Michulec, M., and Curylo, J., A review of theoretical and practical aspects of solid-phase microextraction in food analysis, *Int. J. Food Sci. Technol.*, 39, 703, 2004.
16. O'Riordan, P. J. and Delahunty, C. M., Comparison of volatile compounds released during the consumption of Cheddar cheese with compounds extracted by vacuum distillation using gas chromatography-olfactometry, *Flavour Fragr. J.*, 16, 425, 2001.
17. James, A. T. and Martin, A. J. P., Gas-liquid partition chromatography: the separation and microestimation of volatile fatty acids from formic acid to dodecanoic acid, *Biochem. J.*, 50, 679, 1952.
18. Ettre, L. S. and Hinshaw, J. V., *Basic Relationships of Gas Chromatography*, 1st edn., Advanstar Data, Cleveland, OH, 1993, Chapter 4.
19. Imhof, R. and Bosset, J. O., The performance of various capillary columns for the analysis of volatile flavor compounds in dairy products by dynamic headspace gas chromatography, *J. High Resol. Chromatogr.*, 17, 25, 1994.
20. Qian, M. C. and Burbank, H., Development of volatile sulfur compounds in heat-shocked and pasteurized milk cheese, *Int. Dairy J.*, 18, 811, 2008.
21. Aston, J. W. and Douglas, K., Detection of carbonyl sulphide in Cheddar cheese headspace, *J. Dairy Res.*, 48, 473, 1981.
22. Parliament, T. H., Kolor, M. G., and Rizzo, D. J., Volatile components of Limburger cheese, *J. Agric. Food Chem.*, 30, 1006, 1982.
23. Lundén, A. et al., High trimethylamine concentration in milk from cows on standard diets is expressed as fishy off-flavour, *J. Dairy Res.*, 69, 383, 2002.

24. Kováts, E., Gas-chromatographische Charakterisierung organischer Verbindungen. Teil 1: Retention-sindices aliphatischer Halogenide, Alkohole, Aldehyde und Ketone, *Helv. Chim. Acta*, 51, 1915, 1958.
25. van den Dool, H. and Kratz, P. D., A generalization of the retention index system including linear temperature programmed gas-liquid chromatography, *J. Chromatogr.*, 11, 463, 1963.
26. Vékey, K., Mass spectrometry and mass-selective detection in chromatography, *J. Chromatogr. A*, 921, 227, 2001.
27. Dirinck, P. and De Winne, A., Flavour characterisation and classification of cheeses by gas chromatographic–mass spectrometric profiling, *J. Chromatogr. A*, 847, 203, 1999.
28. Barbieri, G. et al., Study of the volatile fraction of Parmesan cheese, *J. Agric. Food Chem.*, 42, 1170, 1994.
29. Shiratsuchi, H. et al., Volatile flavor compounds in spray-dried skim milk powder, *J. Agric. Food Chem.*, 42, 984, 1994.
30. Fernández-García, E., Use of headspace sampling in the quantitative analysis of artisanal Spanish cheese aroma, *J. Agric. Food Chem.*, 44, 1833, 1996.
31. Adahchour, M. et al., Trace-level determination of polar flavour compounds in butter by solid-phase extraction and gas chromatography–mass spectrometry, *J. Chromatogr. A*, 844, 295, 1999.
32. Liu, Z. and Phillips, J. B., Comprehensive 2-dimensional gas chromatography using an on-column thermal modulator interface, *J. Chromatogr. Sci.*, 1067, 227, 1991.
33. Phillips, J. B. and Beens, J., Comprehensive two-dimensional gas chromatography: A hyphenated method with strong coupling between the two dimensions, *J. Chromatogr. A*, 856, 331, 1999.
34. Schoenmakers, P., Marriott, P., and Beens, J., Nomenclature and conventions in comprehensive multidimensional chromatography, *LC-GC Eur.*, June, 1, 2003.
35. Adahchour, M. et al., Recent developments in comprehensive two-dimensional gas chromatography (GC × GC) IV. Further applications, conclusions and perspectives, *TrAC*, 25, 821, 2006.
36. Adahchour, M. et al., Improved determination of flavour compounds in butter by solid-phase (micro) extraction and comprehensive two-dimensional gas chromatography, *J. Chromatogr. A*, 1086, 99, 2005.
37. Adahchour, M. et al., Comprehensive two-dimensional gas chromatography with time-of-flight mass spectrometric detection for the trace analysis of flavour compounds in food, *J. Chromatogr. A*, 1019, 157, 2003.
38. Fuller, G. H., Steltenkamp, R. S., and Tisserand, G. A., The gas chromatograph with human sensor: perfumer model, *Ann. N. Y. Acad. Sci.*, 116, 711, 1964.
39. Richardson, A., Measurement of fragrance perception, in *The Chemistry of Fragrances*, 1st edn., Pybus, D. H. and Sell, C. S., Eds., Royal Society of Chemistry, Cambridge, 1999, Chapter 8.
40. Meilgaard, M., Civille, G. V., and Carr, B. T., *Sensory Evaluation Techniques*, CRC Press, Boca Raton, 1991.
41. Acree, T. E., Barnard, J., and Cunningham, D., A procedure for the sensory analysis of gas chromatographic effluents, *Food Chem.*, 14, 273, 1984.
42. Ullrich, F. and Grosch, W., Identification of the most intense volatile flavour compounds formed during autoxidation of linoleic acid, *Z. Lebensm. Unters. Forsch.*, 184, 277, 1987.
43. Moio, L. et al., Odorous constituents of ovine milk in relationship to diet, *J. Dairy Sci.*, 79, 1322, 1996.
44. Christensen, K. R. and Reineccius, G. A., Aroma extract dilution analysis of aged Cheddar cheese, *J. Food Sci.*, 60, 218, 1995.
45. Suriyaphan, O. et al., Characteristic aroma components of British Farmhouse Cheddar cheese, *J. Agric. Food Chem.*, 49, 1382, 2001.
46. McDaniel, M. R. et al., Pinot noir aroma: A sensory/gas chromatographic approach, in *Flavors and Off-Flavors (Developments in Food Science Vol. 24)*, Charalambous, G., Ed., Elsevier Science Publishers, Amsterdam, 1992, pp. 23–26.
47. Linssen, J. P. H. et al., Combined gas chromatography and sniffing port analysis of volatile compounds of mineral water packed in polyethylene laminated packages, *Food Chem.*, 46, 367, 1993.

48. Pollien P. et al., Hyphenated headspace-gas chromatography-sniffing technique: Screening of impact odorants and quantitative aromagram comparisons, *J. Agric. Food Chem.*, 45, 2630, 1997.
49. Ott, A., Fay, L. B., and Chaintreau, A., Determination and origin of the aroma impact compounds of yogurt flavor, *J. Agric. Food Chem.*, 45, 850, 1997.
50. Casimir, D. J. and Whitfield, F. B., Flavour impact values, a new concept for assigning numerical values for the potency of individual flavour components and their contribution to the overall flavour profile, *Ber. Int. Fruchtsaftunion.*, 15, 325, 1978.
51. Avsar, Y. K. et al., Characterization of nutty flavor in Cheddar cheese, *J. Dairy Sci.*, 87, 1999, 2004.
52. Vangtal, A. and Hammond, E. G., Correlation of the flavor characteristics of Swiss-type cheeses with chemical parameters, *J. Dairy Sci.*, 69, 2982, 1986.
53. Grosch, W. et al., Aroma extract dilution analysis versus aroma extract concentration analysis, in *Gas Chromatography-Olfactometry: The State of the Art, 1st edn.*, Leland, J. V., Schieberle, P., Buettner, A., and Acree, T. E., Eds., American Chemical Society, Washington, D.C., 2001, Chapter 12.
54. Kubíčková, J. and Grosch, W., Evaluation of potent odorants of Camembert cheese by dilution and concentration techniques, *Int. Dairy J.*, 7, 65, 1997.
55. Dumont, J. P., Rogger, S., and Adda, J., Neutral volatiles in Camembert cheese, *Le Lait*, 54, 501, 1974.
56. Zehentbauer, G. and Reineccius, G. A., Determination of key aroma components of Cheddar cheese using dynamic headspace dilution assay, *Flavour Fragr. J.*, 17, 300, 2002.
57. Milo, C. and Reineccius, A., Identification and quantification of potent odorants in regular-fat and low-fat mild Cheddar cheese, *J. Agric. Food Chem.*, 45, 3590, 1997.
58. Singh, T. K., Drake, M. A., and Cadwallader, K. R., Flavor of Cheddar cheese: A chemical and sensory perspective, *Compr. Rev. Food Sci. Food Saf.*, 2, 165, 2003.
59. Qian, M. and Reineccius, G., Potent aroma compounds in Parmigiano Reggiano cheese studied using a dynamic headspace (purge-trap) method, *Flavour Fragr. J.*, 18, 252, 2003.
60. Curioni, P. M. G. and Bosset, J. O., Key odorants in various cheese types as determined by gas chromatography-olfactometry, *Int. Dairy J.*, 12, 959, 2002.
61. Marsili, R. T., SPME-MS-MVA as an electronic nose for the study of off-flavors in milk, *J. Agric. Food Chem.*, 47, 648, 1999.
62. Marsili, R. T., Shelf-life prediction of processed milk by solid-phase microextraction, mass spectrometry, and multivariate analysis, *J. Agric. Food Chem.*, 48, 3470, 2000.
63. Pérès, C., Viallon, C., and Berdagué, J. -L., Solid-phase microextraction-mass spectrometry: A new approach to the rapid characterization of cheeses, *Anal. Chem.*, 73, 1030, 2001.
64. Lindinger, W., Hansel, A., and Jordan, A., On-line monitoring of volatile organic compounds at ppt level by means of proton-transfer-reaction mass spectrometry (PTR-MS): Medical application, food control and environmental research, *Int. J. Mass Spectrom. Ion Proc.*, 173, 191, 1998.
65. Boscaini, E. et al., Gas chromatography-olfactometry (GC-O) and proton transfer reaction-mass spectrometry (PTR-MS) analysis of the flavour profile of Grana Padano, Parmigiano Reggiano, and Grana Trentino cheeses, *J. Agric. Food Chem.*, 51, 1782, 2003.
66. Gardner, J. W. and Bartlett, P. N., *Electronic noses principles and applications, 1st edn.*, Oxford University Press, New York, 1999, Chapter 5.
67. Winquist, F. et al., An electronic tongue in the dairy industry, *Sens. Actuators B*, 111–112, 299, 2005.
68. Magan, N., Pavlou, A., and Chrysanthakis, I., Milk-sense: A volatile sensing system recognises spoilage bacteria and yeasts in milk, *Sens. Actuators B*, 72, 28, 2001.
69. Haugen, J. E., Electronic noses in food analysis, in *Headspace Analysis of Foods and Flavours: Theory and Practice, 1st edn.*, Rouseff, R. L. and Cadwallader, K. R., Eds., Plenum Press, New York, 2001, Chapter 4.
70. Trihaas, J., Vognsen, L., and Nielsen, P. V., Electronic nose: New tool in modelling the ripening of Danish blue cheese, *Int. Dairy J.*, 15, 679, 2005.

71. Trihaas, J., and Nielsen, P. V., Electronic nose technology in quality assessment: Monitoring the ripening process of Danish Blue cheese, *J. Food Sci.*, 70, E44, 2005.
72. Visser, F. R. and Taylor, M., Improved performance of the Aromascan A32S electronic nose and its potential for detecting aroma differences in dairy products, *J. Sensory Stud.*, 13, 95, 1998.
73. Ampuero, S. and Bosset, J. O., The electronic nose applied to dairy products: A review, *Sens. Actuators B*, 94, 1, 2003.
74. Winquist, F. et al., Monitoring of freshness of milk by an electronic tongue on the basis of voltammetry, *Meas. Sci. Technol.*, 9, 1937, 1998.
75. Audoin, V. et al., Limitations in the use of odor activity values to determine important odorants in food, in *Gas Chromatography–Olfactometry: The State of the Art, 1st edn.*, Leland, J. V., Schieberle, A., Buettner, A., and Acree, T. E., Eds., American Chemical Society, Washington, D.C., 2001, Chapter 14.
76. Patton, S. and Josephson, D., A method for determining significance of volatile compounds in foods, *Food Res.*, 22, 316, 1957.
77. Rothe, M. and Thomas, B., Aromastoffe des Brotes, *Lebensm. Unters. Forsch.*, 119, 302, 1963.
78. Schieberle, P. et al., Character impact odour compounds of different kinds of butter, *Lebensm. Wiss. Technol.*, 26,347, 1993.
79. Czerny, M., Mayer, F., and Grosch, W., Sensory study on the character impact odorants of roasted arabica coffee, *J. Agric. Food Chem.*, 47, 695, 1999.
80. Dimos, A., Urbach, G. E., and Miller, A. J., Changes in flavour and volatiles of full-fat and reduced fat Cheddar cheeses during maturation, *Int. Dairy J.*, 6, 981, 1996.
81. Ishii, R. et al., Relating consumer and trained panels' discriminative sensitivities using vanilla flavored ice cream as a medium, *Food Qual. Pref.*, 18, 89, 2007.
82. Kubíčková, J. and Grosch, W., Evaluation of flavour compounds of Camembert cheese, *Int. Dairy J.*, 8, 11, 1998.
83. Andersson, R. E. et al., Effect of a heat-resistant microbial lipase on flavor of ultra-high-temperature sterilized milk, *J. Dairy Sci.*, 64, 375, 1981.
84. Collins, E. B. and Moustafa, H. H., Sensory and shelf-life evaluations of Cottage cheese treated with potassium sorbate, *J. Dairy Sci.*, 52, 439, 1969.
85. Biede, S. L., Reinbold, G. W., and Hammond, E. G., Influence of *Lactobacillus bulgaricus* on commercial Swiss cheese, *J. Dairy Sci.*, 60, 123, 1977.
86. Delarue, J. and Sieffermann, J. -M., Comparison with a conventional descriptive method for the evaluation of the flavour of fruit dairy products, *Food Qual. Pref.*, 15, 383, 2004.
87. Dairou, V. and Sieffermann J. -M., A comparison of 14 jams characterized by conventional profile and a quick original method, the Flash profile, *J. Food Sci.*, 67, 826, 2002.
88. Carpino, S. et al., Chemometric analysis of Ragusano cheese flavor, *J. Agric. Food Chem.*, 50, 1143, 2002.
89. Biasoli, F. et al., Correlation of PTR-MS spectral fingerprints with sensory characterisation of flavour and odour profile of "Trentingrana" cheese, *Food Quality Pref.*, 17, 63, 2006.
90. Carunchia Whetstone, M. E. et al., Identification and quantification of character aroma components in fresh Chevre-style goat cheese, *J. Food Sci.*, 68, 2441, 2003.
91. Baigrie, B., Introduction, in *Taints and Off-Flavours in Food, 1st edn.*, Baigrie, B., Ed., Woodhead Publishing Ltd., Cambridge, 2003, Chapter 1.
92. Rychlik, M. and Bosset, J. O., Flavour and off-flavour compounds of Swiss Gruyère cheese. Evaluation of potent odorants, *Int. Dairy J.*, 11, 895, 2001.
93. Rychlik, M. and Bosset, J. O., Flavour and off-flavour compounds of Swiss Gruyère cheese. Identification of key odorants by quantitative instrumental and sensory studies, *Int. Dairy J.*, 11, 903, 2001.
94. Carunchia Whetstone, M. E., Drake, M. A., and Cadwallader, K. R., Characterization of aroma compounds responsible for the rosy/floral flavor in Cheddar cheese, *J. Agric. Food Chem.*, 45, 850, 1997.
95. Badings, H. T., Cold-storage defects in butter and their relation to the autoxidation of unsaturated fatty acids, *Ned. Melk Zuiveltijdschr.*, 24, 147, 1970.

96. Swoboda, P. A. T. and Peers, K. E., Metallic odor caused by vinyl ketones formed in the oxidation of butterfat. The identification of octa-1-cis-5-dien-3-one, *J. Sci. Food Agric.*, 28, 1019, 1977.
97. Huß, M. and Kessler, H. G., Einfluß des Butterungsrahmfettgehaltes auf die sensorischen Eigenschaften von Buttermilch, *Deutsche Molkerei-zeitung*, 49, 1570, 1989.
98. Heiler, C. and Schieberle, P., Studies on the metallic off-flavour in buttermilk: Identification of potent aroma compounds, *Lebensm.-Wiss. U.-Technol.*, 29, 460, 1996.
99. Mounchilli, A. et al., HS-SPME gas chromatographic characterization of volatile compounds in milk tainted with off-flavour, *Int. Dairy J.*, 15, 1203, 2005.
100. Wellnitz-Ruen, W., Reineccius, G. A., and Thomas, E. L., Analysis of the fruity off-flavor in milk using headspace concentration capillary column gas chromatography, *J. Agric. Food Chem.*, 30, 512, 1982.
101. Nursten, H. E., The flavour of milk and dairy products: I. Milk of different kinds, milk powder, butter and cream, *Int. J. Dairy Technol.*, 50, 48, 1997.



---

**SAFETY**

**V**

---





# Chapter 30

---

## Microbial Flora

---

Effie Tsakalidou

### CONTENTS

30.1	Introduction.....	647
30.2	Microbial Ecology of Dairy Products.....	648
30.3	Methods of Microbiological Analysis in Dairy Products.....	649
30.3.1	Culture-Dependent Methods.....	649
30.3.1.1	Classical and Advanced Phenotypic Methods .....	649
30.3.1.2	Molecular Methods .....	651
30.3.2	Culture-Independent Methods.....	654
	References.....	656

### 30.1 Introduction

The production of fermented dairy products, such as cheese, yogurt, and fermented milks is one of the oldest methods practiced by man for the preservation of a highly perishable and nutritional foodstuff like milk. The first fermented dairy products were produced by an accidental combination of events. The ability of a group of bacteria, now known as lactic acid bacteria (LAB), to grow in milk and produce enough acid to reduce the pH of milk, caused the coagulation of proteins, thus fermenting the milk. An alternative mechanism was also recognized from an early date, in which the proteolytic enzymes were observed to modify the milk proteins, causing them to coagulate under certain circumstances.

The need for an inoculum was understood and usually a sample from the previous production, also known as back-slopping, was retaining as an inoculum. With the discovery of microorganisms, it became possible to improve the products and the fermentation processes by using well-characterized starter cultures. LAB, yeasts, and molds are the dominant starter cultures used

in the production of fermented foods, in general, with a market size of approximately US\$ 250 million. Among them, LAB constitute the majority in volume and value of the commercial starter cultures, with the largest part being used in the dairy industry [68].

The primary metabolic actions of microorganisms in dairy fermentations include their ability to ferment carbohydrates and, to a lesser degree, to degrade the proteins and fats present in the raw material. This leads to the production of a broad range of compounds, such as organic acids, peptides, and free fatty acids, along with many volatile and nonvolatile low-molecular mass compounds. Other metabolites, such as antimicrobial compounds (e.g., bacteriocins), exopolysaccharides, bioactive peptides, vitamins, and enzymes are also often produced. In this way, the starter cultures enhance the shelf-life and microbial safety, improve the texture, and shape the nutritious properties and the pleasant sensory profile of the end product. This contribution is further responsible for the differences observed between the products of different brands and thereby adds significantly to the value of the product [95].

In a special category of the so-called “probiotic” cultures, the primary activity is a positive impact on the human health by promoting physiological processes and/or stimulating the host’s immune responses [155]. Over the past 15 years, considerable advances were made in the development and conceptualization of novel health-related functional dairy products. Scientific progress in the nutritional and biological sciences has been a major drive in these developments and has contributed significantly to an increase in the consumer awareness on the link between nutrition and health [61].

## 30.2 Microbial Ecology of Dairy Products

The transformation of milk to a fermented dairy product, especially to cheese, involves a complex and dynamic microbial ecosystem, in which numerous biochemical reactions occur.

LAB are the major microbial group involved in cheese manufacturing. These are divided into the starters and the secondary flora. The primary function of the starter bacteria that mainly belong to the genera *Lactococcus* and *Lactobacillus*, along with *Streptococcus thermophilus*, is to produce acid during the fermentation process. However, they also contribute to cheese ripening, where their enzymes are involved in proteolysis and conversion of amino acids into flavor compounds. The secondary flora consists of adventitious microorganisms from the environment, which contaminate the milk or cheese curd during manufacture and ripening. This group includes numerous species of LAB, such as *Lactobacillus*, *Enterococcus*, *Pediococcus*, and *Leuconostoc*. These microorganisms may become the dominant viable microorganisms in cheese. The numerous hydrolytic enzymes produced by both the starter and the secondary flora affect the proteolysis and lipolysis during cheese ripening and thus contribute to cheese maturation [11].

Propionic acid bacteria grow in many cheese varieties during ripening, and are the characteristic microflora associated with Swiss-type cheeses, such as Emmental, Gruyere, Appenzell, and Comte. The classical propionic acid bacteria are the most important with respect to cheese microbiology, and five species are currently recognized, namely *P. freudenreichii*, *P. jensenii*, *P. thoenii*, *P. acidipropionici*, and *P. cyclohexanicum* [157].

Smear-ripened cheeses are characterized by the development of a smear of bacteria and yeast on the surface of the cheese during ripening. It is generally believed that *Brevibacterium linens* is the major bacterium growing on the surface of the smear-ripened cheeses. Recent studies have indicated that several micrococci (*M. luteus*, *M. lylae*, *Kocuria kristinae*, and *K. roseus*), staphylococci (*St. equorum*, *St. vitulus*, *St. xylosus*, *St. saprophyticus*, *St. lentus*, and *St. sciuri*), and

coryneform bacteria (*Arthrobacter citreus*, *A. globiformis*, *A. nicotianae*, *B. imperiale*, *B. fuscum*, *B. oxydans*, *B. helvolum*, *Corynebacterium ammoniagenes*, *C. betae*, *C. insidiosum*, *C. variabilis*, *Curtobacterium poinsettiae*, *Microbacterium imperiale*, and *Rhodococcus fascians*) are also found on the surface of these cheeses. However, the stage of ripening at which these bacteria are involved is not yet clear [11].

In certain types of cheeses, molds comprise a major part of the cheese microbiota. The mold-ripened cheeses include the mold surface-ripened cheeses, mainly represented by the French varieties like Camembert and Brie, with *Penicillium camemberti* being the dominant microorganism, and the blue-veined cheeses, such as the French Roquefort and the Italian Gorgonzolla, where *Penicillium roqueforti* is grown within the cheese curd. The surface of the French cheeses, St. Nectaire and Tome de Savoie, is covered by a complex fungal flora containing *Penicillium*, *Mucor*, *Cladosporium*, *Geotrichum*, *Epicoccum*, and *Sporotrichum*, while *Penicillium* and *Mucor* have been reported on the surface of the Italian cheese, Taleggio, and *Geotrichum* on that of Robiola [66].

Yeasts are found in a wide variety of cheeses. However, in most cases, their role in cheese ripening is not fully understood [52]. Fox et al. [53] summarized the yeasts found in several different cheeses. They found that *Debaryomyces hansenii* is, by far, the dominant yeast occurring in nearly all the cheeses, including Weinkase, Romadour, Limburger, Tilsit, Roquefort, Cabrales, Camembert, and St. Nectaire. The next most-important species include *Kluyveromyces lactis*, *Yarrowia lipolytica*, and *Trichospora beigeli*. However, whether a progression in the species of yeast occurs during the ripening is not clear, as, in many of the relevant studies, the stage of ripening at which the yeasts were isolated was not defined. In addition, many commercial smear-cheese preparations were observed to contain yeast species, such as *Geotrichum candidum*, *Candida utilis*, *Debaryomyces hansenii*, and *Kluyveromyces lactis*.

Specific yeast species are essential for the typical characteristics of certain fermented milks, such as kefir, koumiss, viili, and longfil. The FAO/WHO food standards defines Kefir starter culture as being composed of Kefir grains, *L. kefiri*, species of the genera *Leuconostoc* (*L. mesenteroides* and *L. cremoris*), *Lactococcus* (*L. lactis*), *Streptococcus* (*S. thermophilus*), and the acetic acid bacterium, *Acetobacter* (*A. aceti*). It also contains *Kluyveromyces marxianus*, *Saccharomyces unisporus*, *S. cerevisiae*, *S. exiguus*, *Candida*, and *Torulopsis*. However, this definition does not cover the full composition of the Kefir grains' microbiota, and does not list *L. kefirianofaciens*, *L. kefirgranum*, *L. parakefir*, *L. brevis*, *L. acidophilus*, *L. casei*, *L. helveticus*, *L. lactis*, *L. bulgaricus*, and *L. cellobiosus*, which are thought to be present in a Kefir starter ([www.codexalimentarius.net](http://www.codexalimentarius.net)).

## 30.3 Methods of Microbiological Analysis in Dairy Products

### 30.3.1 Culture-Dependent Methods

#### 30.3.1.1 Classical and Advanced Phenotypic Methods

Routine methods to enumerate the microorganisms in dairy products are based on conventional microbial techniques. These rely on the enumeration of various microbial groups by using selective growth media and growth conditions. Several selective media have been developed and reported in the literature [29,35,147]. Moreover, some media have been established as international standards through a collaborative work between the International Organization of Standardization (ISO) and the International Dairy Federation (IDF) [78–81]. However, this approach has several drawbacks, such as the *de facto* limited selectivity of most growth media as well as the discrepancies between genotypic and phenotypic identifications [86]. A major disadvantage is the failure to

recover strains that cannot be cultured using existing methods, or strains that are metabolically active and viable, but have entered a nonculturable state.

The enumeration of microorganisms is generally followed by the random isolation of a representative number of colonies, usually by considering the appearance of the colonies. For bacterial identification, the basic techniques applied include gram staining, catalase and oxidase reactions, as well as cell morphology and physiology. The LAB can be divided into rods (*Lactobacillus* and *Carnobacterium*) and cocci (all other genera), while the genus *Weissella* includes both rods and cocci [6]. It should be stressed, however, that the growth conditions and the growth stage of the cells may seriously affect the cell morphology. The physiological tests include the ability of the isolates to produce CO<sub>2</sub> from glucose and the ability to grow at different temperatures, NaCl concentrations, and pH conditions [56,69,85]. Beyond this and despite a number of serious disadvantages, such as interlaboratory variation, strain-to-strain variation, and number of characteristics tested, carbohydrate fermentation patterns are still very useful as a classical phenotypic approach. Nowadays, well-standardized commercially available kits, such as API 20STREP, API 50CH, API ZYM, and Rapid ID32STREP (bioMérieux, Marcy-l'Étoile, France) or BIOLOG GP (BIOLOG Inc., Hayward, CA), usually accompanied with a database and the respective software, are available. Meanwhile, older phenotypic methods, like serological grouping as well as the determination of cell wall composition, chemotaxonomic markers, and electrophoretic mobility of lactic acid dehydrogenase, have been practically abandoned [123].

On the other hand, advanced phenotypic methods have been developed and successfully used for the identification down to species level. These include the sodium dodecyl sulfate-polyacrylamide gel electrophoresis (SDS-PAGE) of the whole cell proteins, the Fourier transform infrared (FT-IR) spectroscopy of intact cells, and the analysis of the cellular fatty acids. All these methods demand a well-structured database with patterns of well-characterized reference and type strains, and the appropriate mathematical device for the numerical analysis of the patterns obtained, especially when dealing with large numbers of isolates.

The comparison of the whole cell protein patterns obtained by SDS-PAGE offers the advantages of being a fairly fast and easy identification method, which when performed under highly standardized conditions, produces a good level of taxonomic resolution at species or subspecies level [120–122]. In the early days as well as when applied on LAB, it was possible to solve specific identification problems for lactococci [43,82], *Lactobacillus kefir* and *Lactobacillus reuteri* [36], and leuconostocs [8,37] using SDS-PAGE. The method has been widely used for studying the biodiversity of LAB in various dairy products [30,57,58,96,152,158].

Originally introduced by Naumann et al. [111], FT-IR spectroscopy is a vibrational spectroscopic technique with high resolution power, capable of distinguishing the microbial cells at different taxonomic levels [65,72,88,148], and acts a valuable tool for rapid screening of environmental isolates [149]. The identification is achieved by calculating the overall difference between a test spectrum and all the reference spectra. A test strain is assigned to the source of the nearest reference spectrum. However, such a procedure is univariate and does not consider the patterns of individual differences at different wavelengths, leaving lots of information stored in the spectra unused. Therefore, for the differentiation of closely related species within the same genus, advanced multivariate methods for data analysis are required [103,128]. The FT-IR spectroscopy and cluster analysis have been successfully applied to differentiate and identify LAB [2,3,41,64,91], to follow the evolution of *Lactococcus* strains during ripening in Brie cheese [93], and to identify yeast isolates from Irish smear-ripened cheeses [106].

The fatty-acid composition of the microorganisms depends on several factors, such as growth temperature, pH, oxygen tension, growth phase, medium composition, and salt concentration [142].

Under highly standardized growth conditions, gas chromatographic analysis of cellular fatty acids can be used in the chemotaxonomy of LAB [150]. Indeed, several studies have shown the validity of the method for distinguishing between different species of lactococci [83,140], lactobacilli [31,83,129,131], carnobacteria [25], leuconostocs [151], and *Weissella* [137].

### 30.3.1.2 Molecular Methods

As an alternative to the phenotypic methods, the need of molecular methods for taxonomic purposes was recognized early. The data of considerable taxonomic importance have been derived from the molecular biology studies of DNA, particularly the determination of DNA base composition and the percentage of the DNA similarity, using DNA–DNA hybridization. The latter technique has been extensively applied in the past for the taxonomy of LAB [122]. Although DNA–DNA hybridization values remain the “gold standard” for defining the bacterial species [159], nowadays, it is mainly applied to describe new species. Similarly, other early molecular techniques, such as DNA–rRNA hybridization and 16S rRNA cataloguing have been replaced by the rRNA sequence analysis and rRNA sequencing, respectively, owing to the fact that the earlier techniques are too laborious and time-consuming [123].

In recent years, the increasing availability of the sequences of the 16S rRNA, 23S rRNA genes, and the 16S–23S rRNA intergenic spacer regions or genes encoding enzymes [26,112] allowed the design of numerous primers and probes, and thus, the development of PCR-based, reproducible, easily automated, and rapid molecular methods for the identification of microbial species of interest in the field of dairy products. Although DNA-based methods provide complementary information on the biodiversity of dairy products as well as the temporal and spatial distribution, microbial ecology studies that compare the ratios of culturable cells with both total cells and active cells have indicated the usefulness of culturability in assessing the succession of microbial communities [55]. Furthermore, the importance of the information on the quantitative populations of microorganisms, furnished by culture-dependent methods resides on the fact that microorganisms affect the food ecosystem according to their biochemical reactivity and peak populations. Therefore, a combination of both types of methods, the so-called polyphasic taxonomy, would give more complete information on the microbial complexity of the fermented dairy products.

Table 30.1 gives a representative overview from recent taxonomical studies performed on the microbiota of various dairy products using PCR-based techniques. The overview certainly does not cover the numerous literature data accumulated so far. However, it tries to deal with the main genera/species found in the fermented dairy products. The molecular techniques that either serve as typing methods or culture-independent techniques are described in more detail in the subsequent paragraphs.

Among the PCR-based techniques, randomly amplified polymorphic DNA (RAPD)-PCR analysis is widely recognized as a rapid and reliable method for intra- and interspecific differentiation of most of the food-associated bacterial species. Moreover, its resolving power can be easily enhanced by increasing the number of primers used to randomly amplify the bacterial genome [145]. RAPD-PCR analysis has been used to estimate the diverse *Lactobacillus* strains in the Centre National de Recherches Zootechniques collection [145], to establish the correct nomenclature and classification of strains of *L. casei* subsp. *casei* [38], to type *L. plantarum* strains in Cheddar cheese [92], *Lactococcus lactis* isolated from raw milk used to produce Camembert [100], nonstarter LAB in mature Cheddar cheese [51] and Italian ewe’s milk cheeses [30], enterococci in Italian dairy products [105], natural whey starter cultures in Mozzarella cheese [32], bifidobacteria [156], and dairy propionic acid bacteria [135].

**Table 30.1 PCR-Based Techniques Used in the Identification of Microorganisms in Dairy Products**

<i>Product</i>	<i>Genus/Species</i>	<i>Identification Method</i>	<i>Reference</i>
Cheese	<i>Propionibacterium</i> species	Genus-specific PCR	[136]
Milk		Species-specific PCR	
Cheese	<i>Enterococcus</i> species	Specific and random amplification (SARA)-PCR	[87]
Cheese	<i>Enterococcus</i> species	Species-specific PCR	[101]
	<i>Lactobacillus</i> species		
	<i>Streptococcus thermophilus</i>		
Cheese	<i>Streptococcus macedonicus</i>	Species-specific PCR	[118]
Fermented milk	<i>Lactobacillus</i> species	Real-time quantitative PCR	[54]
	<i>Streptococcus thermophilus</i>		
Cheese	<i>Lactobacillus</i> species	Species-specific PCR	[116]
Cheese	<i>Enterococcus</i> species	Species-specific PCR	[134]
Raw milk	<i>Lactobacillus</i> species		
	<i>Lactococcus lactis</i>		
	<i>Streptococcus thermophilus</i>		
Cheese	<i>Enterococcus</i> species	(GTG) <sub>5</sub> -rep-PCR	[143]
Cheese	<i>Enterococcus</i> species	(GTG) <sub>5</sub> -rep-PCR	[158]
Fermented milk	<i>Lactobacillus</i> species		
Raw milk	<i>Lactococcus</i> species		
Sour cream	<i>Leuconostoc</i> species		
Fermented milk	<i>Lactobacillus</i> species	Amplified ribosomal DNA restriction analysis (ARDRA)	[24]
	<i>Bifidobacterium</i> species		
	<i>Streptococcus thermophilus</i>		
Fermented milk	<i>Bifidobacterium lactis</i>	Species-specific PCR	[144]
	<i>Lactobacillus</i> species		
	<i>Streptococcus thermophilus</i>		

Terminal restriction fragment length polymorphism (T-RFLP) is a method that analyzes the variation among 16S rRNA genes from different bacteria and gives information about the microbial community structure. It is based on the restriction endonuclease digestion of fluorescent end-labeled PCR products. The individual terminal restriction fragments (T-RFs) are separated by gel electrophoresis and the fluorescence signal intensities are quantified. Depending on the species composition of the microbial community, distinct profiles (T-RF patterns) are obtained, as each fragment represents each species present. A relative quantitative distribution can be obtained by this method, as the fluorescence intensity of each peak is proportional to the amount of genomic DNA present for each species in the mixture. Nevertheless, PCR bias could negatively affect the quantification of the real composition of the microbial community [62]. Although 16S rRNA offers the benefits of robust database and well-characterized phylogenetic primers, the T-RFLP approach should not be limited to ribosomal gene markers. The accumulating set of new sequences from various genes from less conserved DNA regions and the high quality of information provided, namely the exact base-pair length of the T-RFs generated, could allow the comparison of profiles for any gene system of interest. The method has been proven suitable for the rapid and routine identification of the classical propionibacteria [130], for the characterization of LAB in Kefir [99], and lactobacilli in Provolone del Monaco cheese [13]. Sánchez et al. [138] assayed the ability of the T-RFLP analysis coupled with RT-PCR in monitoring the population dynamics of the metabolically active fraction of well-defined microbial communities, such as dairy defined-strain starters.

Multilocus sequence-typing (MLST) has emerged as a new powerful DNA-typing tool for the evaluation of intraspecies genetic relatedness [98]. It relies on DNA sequence analysis of usually five to eight internal, ~500 bp fragments of housekeeping genes, and has shown a high degree of intraspecies discriminatory power for bacterial and fungal pathogens [21,132]. The overwhelming advantage of MLST over other molecular-typing methods is that sequence data are truly portable between laboratories, permitting a single expanding global database per species on the World Wide Web site, thus, enabling exchange of molecular-typing data for global epidemiology via the Internet [98]. MLST has been successfully applied for defining the genomic subpopulations within the species *Pediococcus acidilactici* [104], for the genotypic characterization of *Lactobacillus casei* strains isolated from different ecological niches, in cheeses from different geographical locations [19], and for the identification of *Enterococcus* [109] and *Lactobacillus* [15,110] strains derived from humans, animals and food products, in milk, yogurt, and cheese.

Standard gel electrophoresis techniques are not capable of effectively separating very large molecules of DNA, which, when migrating through a gel, essentially move together in a size-independent manner. Schwartz and Cantor [141] developed pulsed field gel electrophoresis (PFGE) by introducing an alternating voltage gradient to improve the resolution of larger DNA molecules. The analysis of chromosomal-DNA restriction-endonuclease profiles using PFGE, by either field-inversion gel electrophoresis or counter-clamped homogenous electric field electrophoresis, is currently considered as the most reliable typing method and the golden standard for epidemiological studies [48,146]. However, the need for specialized equipment and the lack of standardized electrophoresis conditions and interpretation criteria of the PFGE profiles still limit the more extensive application, especially in long-term studies. PFGE has been used for typing bacteria in smear cheeses [17,73,75,106], for elucidating the genotypic heterogeneity of enterococci [12,84,125,126,153], lactococci [34,124], lactobacilli [16,28,39,63], *Streptococcus thermophilus* [115], and *Staphylococcus* [74] in dairy products. Gelsomino et al. [59] applied PFGE to determine the impact of the consumption of cheese containing enterococci on the composition of



the enterococcal flora of the feces in healthy humans. Furthermore, Leite et al. [94] characterized *L. monocytogenes* from cheese and clinical isolates, which were collected in partially overlapping dates from the same geographical area, and using PFGE analysis, examined whether there was any clonal relationship between the cheese and the clinical isolates.

As far as taxonomic studies of cheese yeasts are concerned, a combination of physiological and morphological characteristics has been used traditionally [7,89]. However, in the last decade, molecular approaches have been developed that have overcome the inherent variability of phenotypic tests. Analysis of the coenzyme Q system and the monosaccharide pattern of cell walls [124], random amplification of polymorphic DNA (RAPD) microsatellite analysis [5,60,102,124], RFLP of transcribed and spacer sequences of ribosomal DNA [1,9,18,47,67], chromosome polymorphism determined by PFGE [119], and sequencing of the 18S rRNA gene [20,154] have been used in the classification and typing of yeast species.

### **30.3.2 Culture-Independent Methods**

In the last decade, it was shown that classical microbiological techniques do not accurately detect the microbial diversity. It is well documented, for example, that stressed or injured cells do not recover in the selective media and that cells present in low numbers are very often inhibited by microbial populations numerically more abundantly [77]. As a consequence, an increasing interest in the development and use of culture-independent techniques has emerged. A variety of new methods have been developed to directly characterize the microorganisms in particular habitats without the need for enrichment or isolation [70]. Typically, these strategies examine the total microbial DNA or RNA derived from mixed microbial populations to identify individual constituents. This approach eliminates the necessity for strain isolation, thereby negating the potential biases inherent to the microbial enrichment. Studies that employed such direct analysis have repeatedly demonstrated a tremendous variance between cultivated and naturally occurring species, thereby dramatically altering our understanding of the true microbial diversity present in various habitats [76].

A culture-independent method for studying the diversity of microbial communities is the analysis of PCR products generated with primers homologous to relatively conserved regions in the genome, by using denaturing-gradient gel electrophoresis (DGGE) or temperature-gradient gel electrophoresis (TGGE). These approaches allow the electrophoretic separation of DNA molecules that are of the same length, but have different nucleotide sequences. Hence, they have the potential to provide information about variations in the target genes in a bacterial population. By adjusting the primers used for amplification, both the major and minor constituents of microbial communities can be characterized, and were first used to detect single-base DNA sequence variations [50]. In DGGE, PCR-amplified double-stranded DNA is subjected to electrophoresis under denaturing conditions achieved by a solvent gradient, and migration depends on the degree of DNA denaturation. In TGGE, a temperature gradient rather than a solvent gradient is used to denature the DNA [14].

Although the techniques are reliable, reproducible, rapid, and inexpensive [108], their main limitation is that the community fingerprints they generate do not directly translate into taxonomic information, for which a comparative analysis of the sequences from excised and reamplified DNA fragments to 16S rDNA sequences reported in nucleotide databases, is necessary. More information about the identity of the community members could be obtained by

hybridization analysis of DGGE/TGGE patterns with taxon-specific oligonucleotide probes to the hypervariable regions of the 16S rRNA. Both DGGE and TTGE are now methods of choice for environmental microbiologists, and have been used to determine the genetic diversities of natural microbial communities, such as the communities in biofilms [107], hot springs [139], biodegraded wall painting [133], and fermented foods, such as fermented maize dough [4] and sausages [22].

Recent studies on the microbial diversity in different types of cheeses have made use of these culture-independent methods. The dynamics of bacterial communities have been analyzed using DGGE in evaluating the microbial diversity of natural whey cultures from water-buffalo Mozzarella cheese production [27,44], during the production of an artisanal Sicilian cheese [127], in the elucidation of the bacterial community structure and location in Stilton cheese [45], in studying the microbial succession during the manufacture of traditional water-buffalo mozzarella cheese [46], and in studying the microbial diversity and succession during the manufacture and ripening of the traditional, Spanish, blue-veined Cabrales cheese [10].

Ogier et al. [113] applied TTGE to describe the diversity of LAB in commercial dairy products by setting up a bacterial database that allows rapid identification of the unknown bands. This database essentially included bacteria with a low G + C content genome, i.e., numerous LAB and a few dairy *Staphylococcus* species. In 2004, Ogier et al. [114] modified their approach to expand the bacterial database to other species of dairy interest, including psychrotrophic and spoilage bacteria, pathogens, and bacteria present on the cheese surface. As one of the limitations of TTGE is poor resolution of species having high G + C content genomes, they combined TTGE and DGGE, which is more suitable for these bacterial species. Henri-Dubernet et al. [71] applied TGGE for the assessment of the lactobacilli-community biodiversity and evolution during the production of Camembert. Lafarge et al. [90] studied the evolution of the bacterial community in raw milk upon conservation at 4°C by using both TGGE and DGGE, and both the methods were also used for the elucidation of the bacterial biodiversity occurring in traditional Egyptian soft Domiati cheese [42].

Single-stranded conformational polymorphism analysis (SSCP) is the electrophoretic separation of single-stranded nucleic acids based on subtle differences in sequence, often a single base pair, which results in a different secondary structure and a measurable difference in mobility through an electrophoresis gel. However, similar to the DGGE/TGGE analyses, SSCP provides community fingerprints that cannot be phylogenetically assigned. SSCP analysis on gel has been successfully applied to monitor the dynamics of bacterial population in anaerobic bioreactor [160] or in hot composting [117], or to study the fungal diversity in soils [97]. Duthoit et al. [40] were the first to apply SSCP in a dairy product. Using this method, they effectively described the ecosystem of the registered designation of the origin of Salers cheese, an artisanal cheese produced in France. SSCP was also applied to investigate the microbial community composition and dynamics during the production of a French soft, red-smear cheese [49]. In addition, Delbès and Montel [33] designed and applied a *Staphylococcus*-specific SSCP-PCR analysis to monitor *Staphylococcus* populations' diversity and dynamics during the production of raw milk cheese.

Fluorescence *in situ* hybridization (FISH) represents a new non-PCR-based culture-independent technique in the field of food fermentations. Despite its considerable background knowledge, its application in studying the distribution of microbial populations in food has been limited. In the field of dairy products, this method was successfully used for elucidating the bacterial community structure and location in Stilton cheese [45] as well as other cheese varieties, such as cottage cheese, Kefalotiri, Hallumi, Stracchino, and Mozzarella [23].

## References

1. Alvarez-Martin P., A.B. Florez, T.M. López-Díaz, and B. Mayo (2007) Phenotypic and molecular identification of yeast species associated with Spanish blue-veined Cabrales cheese. *Int. Dairy J.* 17, 961–967.
2. Amiel C., L. Mariey, M.C. Curk-Daubie, P. Pichon, and J. Travert (2000) Potential of Fourier infrared spectroscopy (FTIR) for discrimination and identification of dairy lactic acid bacteria. *Le Lait* 80, 445–449.
3. Amiel C., L. Mariey, C. Denis, P. Pichon, and J. Travert (2001) FTIR spectroscopy and taxonomic purpose: Contribution to the classification of lactic acid bacteria. *Le Lait* 81, 249–255.
4. Ampe F., N. ben Omar, C. Moizan, C. Wachter, and J.P. Guyot (1999) Polyphasic study of the spatial distribution of microorganisms in Mexican pozol, a fermented maize dough, demonstrates the need for cultivation independent methods to investigate traditional fermentations. *Appl. Environ. Microbiol.* 65, 5464–5473.
5. Andrighetto C., E. Psomas, N. Tzanetakis, G. Suzzi, and A. Lombardi A (2000) Randomly amplified polymorphic DNA (RAPD) PCR for the identification of yeasts isolated from dairy products. *Lett. Appl. Microbiol.* 30, 5–9.
6. Axelsson L. (2004) Lactic acid bacteria: Classification and physiology. In *Lactic Acid Bacteria-Microbiological and Functional Aspects*, pp. 1–66, S. Salminen, A. von Wright, and A. Ouwehand, Eds., Marcel Dekker, New York.
7. Barnett J.A., R.W. Payne, and D. Yarrow (2000) *Yeasts: Characteristics and Identification*. Cambridge University Press, Cambridge, U.K.
8. Barreau C. and G. Wagener (1990) Characterization of *Leuconostoc lactis* strains from human sources. *J. Clin. Microbiol.* 28, 1728–1733.
9. Belen Florez A. and B. Mayo (2006) Microbial diversity and succession during the manufacture and ripening of traditional, Spanish, blue-veined Cabrales cheese, as determined by PCR-DGGE. *Int. J. Food Microbiol.* 110, 165–171.
10. Belén Flórez A., P. Álvarez-Martín, T.M. López-Díaz, and B. Mayo (2007) Morphotypic and molecular identification of filamentous fungi from Spanish blue-veined Cabrales cheese, and typing of *Penicillium roqueforti* and *Geotrichum candidum* isolates. *Int. J. Food Microbiol.* 17, 350–357.
11. Beresford T.P., N.A. Fitzsimons, N.L. Brennan, and T.M. Cogan (2001) Recent advances in cheese microbiology. *Int. Dairy J.* 11, 259–274.
12. Bertrand X., B. Mulin, J.F. Viel, M. Thouverez, and D. Talon (2000) Common PFGE patterns in antibiotic-resistant *Enterococcus faecalis* from humans and cheeses. *Food Microbiol.* 17, 543–551.
13. Blaiotta G., V. Fusco, D. Ercolini, M. Aponte, O. Pepe, and F. Villani (2008) *Lactobacillus* strain diversity based on partial *hsp60* gene sequences and design of PCR-restriction fragment length polymorphism assays for species identification and differentiation. *Appl. Environ. Microbiol.* 74, 208–215.
14. Børresen-Dale A.L., S. Lystad, and A. Langerød (1997) Temporal temperature gradient gel electrophoresis (TTGE) compared with denaturing gradient gel electrophoresis (DGGE) and constant denaturing gel electrophoresis (CDGE) in mutation screening. *Bioradiation* 99, 12–13.
15. Borgo F., G. Ricci, P.L. Manachini, and M. Grazia Fortina (2007) Multilocus restriction typing: A tool for studying molecular diversity within *Lactobacillus helveticus* of dairy origin. *Int. Dairy J.* 17, 336–342.
16. Bouton Y., P. Guyot, E. Beuvier, P. Tailliez, and R. Grappin (2002) Use of PCR-based methods and PFGE for typing and monitoring homofermentative lactobacilli during Comté cheese ripening. *Int. J. Food Microbiol.* 76, 27–38.
17. Brennan N.M., A.C. Ward, T.P. Beresford, P.F. Fox, M. Goodfellow, and T.M. Cogan (2002) Biodiversity of the bacterial flora on the surface of a smear cheese. *Appl. Environ. Microbiol.* 68, 820–830.
18. Caggia D., C. Restuccia, A. Pulvirenti, and P. Giudici (2001) Identification of *Pichia anomala* isolated from yoghurt by RFLP of the ITS region. *Int. J. Food Microbiol.* 71, 71–73.

19. Cai H., B.T. Rodríguez, W. Zhang, J.R. Broadbent, and J.L. Steele (2007) Genotypic and phenotypic characterization of *Lactobacillus casei* strains isolated from different ecological niches suggests frequent recombination and niche specificity. *Microbiology* 153, 2655–2665.
20. Cappa F. and P.S. Cocconchelli (2001) Identification of fungi from dairy products by means of 18S rRNA analysis. *Int. J. Food Microbiol.* 69, 157–160.
21. Chan M.S., M.C.J. Maiden, and B.G. Spratt (2001) Database-driven multi locus sequence typing (MLST) of bacterial pathogen. *Bioinformatics* 17, 1077–1083.
22. Cocolin L., M. Manzano, C. Cantoni, and G. Comi (2001) Denaturing gradient gel electrophoresis analysis of the 16S rRNA gene V1 region to monitor dynamic changes in the bacterial population during fermentation of Italian sausages. *Appl. Environ. Microbiol.* 67, 5113–5121.
23. Cocolin L., A. Diez, R. Urso, K. Rantsiou, G. Comi, I. Bergmaier, and C. Beimfohr (2007) Optimization of conditions for profiling bacterial populations in food by culture-independent methods. *Int. J. Food Microbiol.* 120, 100–109.
24. Collado M.C. and M. Hernández (2007) Identification and differentiation of *Lactobacillus*, *Streptococcus* and *Bifidobacterium* species in fermented milk products with bifidobacteria. *Microbiol. Res.* 162, 86–92.
25. Collins M.D., J.A.E. Farrow, B.A. Phillips, S. Ferusu, and D. Jones (1987) Classification of *Lactobacillus divergens*, *Lactobacillus piscicola* and some catalase-negative, asporogenous, rodshaped bacteria from poultry in a new genus, *Carnobacterium*. *Int. J. System. Bacteriol.* 37, 311–316.
26. Collins M.D., U. Rodriguez, C. Ash, M. Aguirre, J.E. Farrow, A. Martinezmurcia, B.A. Philips, A.M. Williams, and S. Wallbanks (1991) Phylogenetic analysis of the genus *Lactobacillus* and related lactic acid bacteria as determined by reverse-transcriptase sequencing of 16S ribosomal-RNA. *FEMS Microbiol. Lett.* 77, 5–12.
27. Coppola S., G. Blaiotta, D. Ercolini, and G. Moschetti (2001) Molecular evaluation of microbial diversity occurring in different types of Mozzarella cheese. *J. Appl. Microbiol.* 90, 414–420.
28. Christiansen P., M.H. Petersen, S. Kask, P.L. Møller, M. Petersen, E.W. Nielsen, F.K. Vogensen, and Y. Ardö (2005) Anticlostridial activity of *Lactobacillus* isolated from semi-hard cheeses. *Int. Dairy J.* 15, 901–909.
29. Dave R.I. and N.P. Shah (1996) Evaluation of media for selective enumeration of *Streptococcus thermophilus*, *Lactobacillus delbrueckii* ssp. *bulgaricus*, *Lactobacillus acidophilus* and bifidobacteria, *J. Dairy Sci.* 79, 1529–1536.
30. De Angelis M., A. Corsetti, N. Tosti, J. Rossi, M.R. Corbo, and M. Gobbetti (2001) Characterization of non-starter lactic acid bacteria from Italian ewe cheeses based on phenotypic, genotypic and cell wall protein analyses. *Appl. Environ. Microbiol.* 67, 2011–2020.
31. Decallonne J., M. Delmee, P. Wauthoz, M. El Lioui, and R. Lambert (1991). A rapid procedure for the identification of lactic acid bacteria based on the gas chromatographic analysis of the cellular fatty acids. *J. Food Prot.* 54, 217–224.
32. de Candia S., M. De Angelis, E. Dunlea, F. Minervini, P.L.H. McSweeney, M. Faccia, and M. Gobbetti (2007) Molecular identification and typing of natural whey starter cultures and microbiological and compositional properties of related traditional Mozzarella cheeses. *Int. J. Food Microbiol.* 119, 182–191.
33. Delbès C. and M.-C. Montel (2005) Design and application of a *Staphylococcus*-specific single strand conformation polymorphism-PCR analysis to monitor *Staphylococcus* populations diversity and dynamics during production of raw milk cheese. *Letts. Appl. Microbiol.* 41, 169–174.
34. Delgado S. and B. Mayo (2004) Phenotypic and genetic diversity of *Lactococcus lactis* and *Enterococcus* spp. strains isolated from Northern Spain starter-free farmhouse cheeses. *Int. J. Food Microbiol.* 90, 309–319.
35. de Man J.C., M. Rogosa, and M.E. Sharpe (1960) A medium for the cultivation of lactobacilli. *J. Appl. Bacteriol.* 23, 130–135.
36. Dicks L.M.T. and H.J.J. van Vuuren (1987) Relatedness of heterofermentative *Lactobacillus* species revealed by numerical analysis of total soluble cell protein patterns. *Int. J. Syst. Bacteriol.* 37, 437–440.

37. Dicks L.M.T., H.J.J. van Vuuren, and F. Dellaglio (1990) Taxonomy of *Leuconostoc* species, particularly *Leuconostoc oenos*, as revealed by numerical analysis of total soluble protein patterns, DNA base compositions and DNA-DNA hybridization. *Int. J. Syst. Bacteriol.* 40, 83–91.
38. Dicks L.M.T., E.M. Du Plessis, F. Dellaglio, and E. Lauer (1996) Reclassification of *Lactobacillus casei* subsp. *casei* ATCC 393 and *Lactobacillus rhamnosus* ATCC 15820 as *Lactobacillus zeae* nom. rev., designation of ATCC 334 as the neotype of *L. casei* subsp. *casei*, and rejection of the name *Lactobacillus paracasei*. *Int. J. Syst. Bacteriol.* 46, 337–340.
39. Dimitrov Z., M. Michaylova, and S. Mincova (2005) Characterization of *Lactobacillus helveticus* strains isolated from Bulgarian yoghurt, cheese, plants and human faecal samples by sodium dodecylsulfate polyacrylamide gel electrophoresis of cell-wall proteins, ribotyping and pulsed field gel fingerprinting. *Int. Dairy J.* 15, 998–1005.
40. Duthoit F., J.J. Godon, and M.C. Montel (2003) Bacterial community dynamics during production of registered designation of origin Salers cheese as evaluated by 16S rRNA gene single-strand conformation polymorphism analysis. *Appl. Environ. Microbiol.* 69, 3840–3848.
41. Dziuba B., A. Babuchowski, D. Nałęcz, and M. Niklewicz (2007) Identification of lactic acid bacteria using FTIR spectroscopy and cluster analysis. *Int. Dairy J.* 17, 183–189.
42. El-Baradei G., A. Delacroix-Buchet, and J.-C. Ogier (2007) Biodiversity of bacterial ecosystems in traditional Egyptian Domiati cheese. *Appl. Environ. Microbiol.* 73, 1248–1255.
43. Elliot J.A., M.D. Collins, Pigott N.E., and R.R. Facklam (1991) Differentiation of *Lactococcus lactis* and *Lactococcus garviae* from humans by comparison of whole cell protein patterns. *J. Clin. Microbiol.* 29, 2731–2734.
44. Ercolini D., G. Moschetti, G. Blaiotta, and S. Coppola (2001) The potential of a polyphasic PCR-DGGE approach in evaluating microbial diversity of natural whey cultures from water-buffalo Mozzarella cheese production: Bias of “culture dependent” and “culture independent” approaches. *Syst. Appl. Microbiol.* 24, 610–617.
45. Ercolini D., P.J. Hill, and E.R. Dodd (2003) Bacterial community structure and location in Stilton cheese. *Appl. Environ. Microbiol.* 69, 3540–3548.
46. Ercolini D., G. Mauriello, G. Blaiotta, G. Moschetti, and S. Coppola (2004) PCR-DGGE fingerprints of microbial succession during a manufacture of traditional water buffalo mozzarella cheese. *J. Appl. Microbiol.* 96, 263–270.
47. Esteve-Zarzoso B., C. Belloch, F. Uruburu, and A. Querol (1999) Identification of yeasts by RFLP analysis of the 5.8S rRNA gene and the two ribosomal internal transcribed spacers. *Int. J. Syst. Bacteriol.* 49, 329–337.
48. Facklam R., M.G. Carvallo, and L. Teixeira (2002) History, taxonomy, biochemical characteristics and antibiotic susceptibility testing of enterococci. In *The Enterococci: Pathogenesis, Molecular Biology and Antibiotic Resistance*, M. Gimore, Ed., ASM Press, Washington, D.C.
49. Feurer C., T. Vallaey, G. Corrieu, and F. Irlinger (2004) Does smearing inoculum reflect the bacterial composition of the smear at the end of the ripening of a French soft, red-smear cheese? *J. Dairy Sci.* 87, 3189–3197.
50. Fischer S.G. and L.S. Lerman (1983) DNA fragments differing by single base-pair substitutions are separated in denaturing gradient gels: Correspondence with melting theory. *Proc. Natl. Acad. Sci.* 80, 1579–1583.
51. Fitzsimons N.A., T.M. Cogan, S. Condon, and T. Beresford (1999) Phenotypic and genotypic characterization of non-starter lactic acid bacteria in mature cheddar cheese. *Appl. Environ. Microbiol.* 65, 3418–3426.
52. Fleet G.H. and M.A. Mian (1987) The occurrence and growth of yeasts in dairy products. *Int. J. Food Microbiol.* 4, 145–155.
53. Fox P.F., T.P. Guinee, T.M. Cogan, and P.L.H. McSweeney (2000) *Fundamentals of Cheese Science*. Aspen Publishers, Inc., Gaithersburg, MD.
54. Furet J.P., P. Quéneé, and P. Tailliez (2004) Molecular quantification of lactic acid bacteria in fermented milk products using real-time quantitative PCR. *Int. J. Food Microbiol.* 97, 197–207.

55. Garland J.L., K.L. Cook, J.L. Adams, and L. Kerkhof (2001) Culturability as an indicator of succession in microbial communities. *Microb. Ecol.* 42, 150–158.
56. Garvie E.I. (1986) Genus *Leuconostoc* van Tieghem 1878, 198<sup>AL</sup>, emend. Mut. Chat. Hucker and Peterson 1930, 66<sup>AL</sup>. In *Bergey's Manual of Systematic Bacteriology*, Vol. 2, pp. 1071–1075, P.A. Sneath, N.S. Mair, M.E. Sharpe, and J.G. Holt, Eds., The Williams and Wilkins Co., Baltimore, MD.
57. Gatti M., M.E. Fornasari, and E. Neviani (2001) Differentiation of *Lactobacillus delbrueckii* subsp. *bulgaricus* and *Lactobacillus delbrueckii* subsp. *lactis* by SDS-PAGE of cell-wall proteins. *Lett. Appl. Microbiol.* 32, 352–356.
58. Gatti M., C. Lazzi, L. Rossetti, G. Mucchetti, and E. Neviani (2003) Biodiversity of *Lactobacillus helveticus* strains present in natural whey starter used for Parmigiano Reggiano cheese. *J. Appl. Microbiol.* 95, 463–470.
59. Gelsomino R., M. Vancanneyt, T.M. Cogan, and J. Swings (2003) Effect of raw-milk cheese consumption on the enterococcal flora of human faeces. *Appl. Environ. Microbiol.* 69, 312–319.
60. Gente S., N. Desmasures, J.M. Panoff, and M. Gueguen (2002) Genetic diversity among *Geotrichum candidum* strains from various substrates studied using RAM and RAPD-PCR. *J. Appl. Microbiol.* 92, 491–501.
61. Gibney M.J., M. Walsh, L. Brennan, H.M. Roche, B. German, and B. van Ommen (2005) Metabolomics in human nutrition: Opportunities and challenges. *Am. J. Clin. Nutr.* 82, 497–503.
62. Giraffa G. and E. Neviani (2001) DNA-based, culture-independent strategies for evaluating microbial communities in food-associated ecosystems. *Int. J. Food Microbiol.* 67, 19–34.
63. Giraffa G., C. Andrighetto, C. Antonello, M. Gatti, C. Lazzi, G. Marazzan, A. Lombardi, and E. Neviani (2004) Genotypic and phenotypic diversity of *Lactobacillus delbrueckii* subsp. *lactis* strains of dairy origin. *Int. J. Food Microbiol.* 91, 129–139.
64. Goodacre R., E.M. Timmins, P.J. Rooney, J.J. Rowland, and D.B. Kell (1996) Rapid identification of *Streptococcus* and *Enterococcus* species using diffuse reflectance-absorbance Fourier transform infrared spectroscopy and artificial neural networks. *FEMS Microbiol. Lett.* 140, 233–239.
65. Goodacre R., E.M. Timmins, R. Burton, N. Kaderbhai, A.M. Woodward, D.B. Kell, and P.J. Rooney, P.J. (1998) Rapid identification of urinary tract infection bacteria using hyperspectral whole-organism fingerprinting and artificial neural networks. *Microbiology* 144, 1157–1170.
66. Gripon J.C. (1999) Mould-ripened cheeses. In *Cheese Chemistry, Physics and Microbiology*, Vol. 2, pp. 111–136, P.F. Fox, Ed., Chapman & Hall, London, U.K.
67. Guillamon J.M., J. Sabate, E. Barrio, J. Cano, and A. Querol (1998) Rapid identification of wine yeasts species based on RFLP analysis of ribosomal internal transcribed spacer (ITS) region. *Arch. Microbiol.* 169, 387–392.
68. Hansen E.B. (2002) Commercial bacterial starter cultures for 1 fermented foods of the future. *Int. J. Food Microbiol.* 78, 119–131.
69. Hardie J.M. (1986) Genus *Streptococcus* Rosenbach 1884, 22<sup>AL</sup>. In *Bergey's Manual of Systematic Bacteriology*, Vol. 2, pp. 1043–1071, P.A. Sneath, N.S. Mair, M.E. Sharpe, and J.G. Holt, Eds., The Williams and Wilkins Co., Baltimore, MD.
70. Head I.M., J.R. Saunders, and R.W. Pickup (1998) Microbial evolution, diversity and ecology: A decade of ribosomal RNA analysis of uncultivated microorganisms. *Microb. Ecol.* 35, 1–21.
71. Henri-Dubernet S., N. Desmasures, and M. Guéguen (2004) Culture-dependent and culture-independent methods for molecular analysis of the diversity of lactobacilli in “Camembert de Normandie” cheese. *Le Lait* 84, 179–189.
72. Holt C., D. Hirst, A. Sutherland, and F. MacDonald (1995) Discrimination of species in the genus *Listeria* by Fourier transform infrared spectroscopy and canonical variate analysis. *Appl. Environ. Microbiol.* 61, 377–378.
73. Hoppe-Seyler T.S., B. Jaeger, W. Bockelmann, W.H. Noordman, A. Geis, and K.J. Heller (2003) Identification and differentiation of species and strains of *Arthrobacter* and *Microbacterium barkeri* isolated from smear cheeses with amplified ribosomal DNA restriction analysis (ARDRA) and pulsed field gel electrophoresis (PFGE). *Syst. Appl. Microbiol.* 26, 438–444.

74. Hoppe-Seyler T.S., B. Jaeger, W. Bockelmann, W.H. Noordman, A. Geis, and K.J. Heller (2004) Molecular identification and differentiation of *Staphylococcus* species and strains of cheese origin. *Syst. Appl. Microbiol.* 27, 211–218.
75. Hoppe-Seyler T.S., B. Jaeger, W. Bockelmann, A. Geis, and K.J. Heller (2007) Molecular identification and differentiation of *Brevibacterium* species and strains. *Syst. Appl. Microbiol.* 30, 50–57.
76. Hugenholtz P. and N.R. Pace (1996) Identifying microbial diversity in the natural environment: A molecular phylogenetic approach. *Trends Biotechnol.* 14, 90–97.
77. Hugenholtz P., B.M. Goebel, and N.R. Pace (1998) Impact of culture-independent studies on the emerging phylogenetic view of bacterial diversity. *J. Bacteriol.* 180, 4765–4774.
78. ISO7889/IDF117 (2003) Yogurt – enumeration of characteristic microorganisms–colony count technique at 37°C.
79. ISO9232/IDF146 (2003) Yogurt – enumeration of characteristic microorganisms (*Lactobacillus delbreuckii* subsp. *bulgaricus* and *Streptococcus thermophilus*).
80. ISO17792/IDF180 (2006) Milk, milk products and mesophilic starter cultures–enumeration of citrate lactic acid bacteria – colony count technique at 25°C.
81. ISO20128/IDF192 (2006) Milk products – enumeration of presumptive *Lactobacillus acidophilus* on a selective medium – colony count technique at 37°C.
82. Jarvis A.W. and J.M. Wolff (1979) Grouping of lactic streptococci by gel electrophoresis of soluble cell extracts. *Appl. Environ. Microbiol.* 37, 391–398.
83. Johnsson T., P. Nikkil, L. Toivonen, H. Rosenqvist, and S. Laakso (1995) Cellular fatty acid profiles of *Lactobacillus* and *Lactococcus* strains in relation to the oleic acid content of the cultivation medium. *Appl. Environ. Microbiol.* 61, 4497–4499.
84. Jurkovič D., L. Križková, M. Sojka, M. Takáčová, R. Dušínský, J. Krajčovič, P. Vandamme, and M. Vancanneyt (2007) Genetic diversity of *Enterococcus faecium* isolated from Bryndza cheese. *Int. J. Food Microbiol.* 116, 82–87.
85. Kandler O. and N. Weiss (1986) Genus *Lactobacillus* Beijerinck 1901, 212<sup>AL</sup>. In *Bergey's manual of systematic bacteriology*, Vol. 2, pp. 1209–1234, P.A. Sneath, N.S. Mair, M.E. Sharpe, and J.G. Holt, Eds., The Williams and Wilkins Co., Baltimore, MD.
86. Kelly W. and L. Ward (2002) Genotypic vs. phenotypic biodiversity in *Lactococcus lactis*. *Microbiol.* 148, 3332–3333.
87. Knijff E., F. Dellaglio, A. Lombardi, S. Biesterveld, and S. Torriani (2001) Development of the specific and random amplification (SARA)-PCR for both species identification of enterococci and detection of the *vanA* gene. *J. Microbiol. Methods* 43, 233–239.
88. Kuemmerle M., S. Scherer, and H. Seiler (1998) Rapid and reliable identification of fermentative yeasts by Fourier-transform infrared spectroscopy. *Appl. Environ. Microbiol.* 64, 2207–2214.
89. Kurtzman C.P. and J.W. Fell (1998). *The Yeasts: A Taxonomic Study* (4th ed.), Elsevier Science Publishers, Amsterdam, The Netherlands.
90. Lafarge V., J.-C. Ogier, V. Girard, V. Maladen, J.-Y. Leveau, A. Gruss, and A. Delacroix-Buchet (2004) Raw cow milk bacterial population shifts attributable to refrigeration. *Appl Environ. Microbiol.* 70, 5644–5650.
91. Lai S., R. Goodacre, and L.N. Manchester (2004) Whole-organism fingerprinting of the genus *Carnobacterium* using Fourier transform infrared spectroscopy (FT-IR). *Syst. Appl. Microbiol.* 27, 186–191.
92. Lane C.N. and P.F. Fox (1996) Contribution of starter and added lactobacilli to proteolysis in Cheddar cheese during ripening. *Int. Dairy J.* 6, 715–728.
93. Lefier D., H. Lamprell, and G. Mazerolles (2000) Evolution of *Lactococcus* strains during ripening in Brie cheese using Fourier transform infrared spectroscopy. *Le Lait* 80, 247–254.
94. Leite P., R. Rodrigues, M. Ferreira, G. Ribeiro, C. Jacquet, P. Martin, and L. Brito (2006) Comparative characterization of *Listeria monocytogenes* isolated from Portuguese farmhouse ewe's cheese and from humans. *Int. J. Food Microbiol.* 106, 111–121.

95. Leroy F. and L. DeVuyst (2004) Lactic acid bacteria as functional starter cultures for the food fermentation industry. *Trends Food Sci. Technol.* 15, 67–78.
96. Lombardi L., M. Gatti, L. Rizzotti, S. Torriani, C. Andrighetto, and G. Giraffa (2004) Characterization of *Streptococcus macedonicus* strains isolated from artisanal Italian raw milk cheeses. *Int. Dairy J.* 14, 967–976.
97. Lowell J.L. and D.A. Klein (2001) Comparative single-strand conformation polymorphism (SSCP) and microscopy-based analysis of nitrogen cultivation interactive effects on the fungal community of a semiarid steppe soil. *FEMS Microbiol. Ecol.* 36, 85–92.
98. Maiden M.C.J., J.A. Bygraves, E. Feil, J. Morelli, J.E. Russell, R. Urwin, Q. Zhang, et al. (1998) Multilocus sequence typing: A portable approach to the identification of clones within populations of pathogenic microorganisms. *Proc. Nat. Acad. Sci.* 95, 3140–3145.
99. Mainville I., N. Robert, By. Lee, and E.R. Farnworth (2006) Polyphasic characterization of the lactic acid bacteria in kefir. *Syst. Appl. Microbiol.* 29, 59–68.
100. Mangin I., D. Corroler, A. Reinhardt, and M. Gueguen (1999) Genetic diversity among dairy lactococcal strains investigated by polymerase chain reaction with three arbitrary primers. *J. Appl. Microbiol.* 86, 514–520.
101. Mannu L., G. Riu, R. Comunian, M.C. Fozzi, and M.F. Scintu (2002) A preliminary study of lactic acid bacteria in whey starter culture and industrial Pecorino Sardo ewes' milk cheese: PCR-identification and evolution during ripening. *Int. Dairy J.* 12, 17–26.
102. Marcellino N., E. Beuvier, R. Grappin, M. Gueguen, and D.R. Benson (2001) Diversity of *Geotrichum candidum* strains isolated from traditional cheese making fabrications in France. *Appl. Environ. Microbiol.* 67, 4752–4759.
103. Marley L., J.P. Signolle, C. Amiel, and J. Travert (2001) Discrimination, classification, identification of microorganisms using FTIR spectroscopy and chemometrics. *Vibrat. Spectr.* 26, 151–159.
104. Mora D., M.G. Fortina, C. Parini, D. Daffonchio, and P.L. Manachini (2000) Genomic subpopulations within the species *Pediococcus acidilactici* detected by multilocus typing analysis: Relationships between pediocin ACh/PA-1 producing and non-producing strains. *Microbiology* 146, 2027–2038.
105. Morandi S., M. Brasca, C. Andrighetto, A. Lombardi, and R. Lodi (2006) Technological and molecular characterisation of enterococci isolated from north–west Italian dairy products. *Int. Dairy J.* 16, 867–875.
106. Mounier J., R. Gelsomino, S. Goerges, M. Vancanneyt, K. Vandemeulebroecke, B. Hoste, S. Scherer, J. Swings, G.F. Fitzgerald, and T.M. Cogan (2005) Surface microflora of four smear-ripened cheeses. *Appl. Environ. Microbiol.* 71, 6489–6500.
107. Muyzer G.E., C. de Waal, and A.G. Uitterlinden (1993) Profiling of complex microbial populations by denaturing gradient gel electrophoresis analysis of polymerase chain reaction-amplified genes coding for 16S rRNA. *Appl. Environ. Microbiol.* 59, 695–700.
108. Muyzer G. (1999) DGGE/TGGE a method for identifying genes from natural ecosystems. *Curr. Opin. Microbiol.* 2, 317–322.
109. Naser S.M., F.L. Thompson, B. Hoste, D. Gevers, P. Dawyndt, M. Vancanneyt, and J. Swings (2005) Application of multilocus sequence analysis (MLSA) for rapid identification of *Enterococcus* species based on *rpoA* and *pheS* genes. *Microbiology* 151, 2141–215.
110. Naser S.M., P. Dawyndt, B. Hoste, D. Gevers, K. Vandemeulebroecke, I. Cleenwerck, M. Vancanneyt, and J. Swings (2007) Identification of lactobacilli by *pheS* and *rpoA* gene sequence analyses. *Int. J. Syst. Evol. Microbiol.* 57, 2777–2778.
111. Naumann D., D. Helm, and C. Schultz (1994) Characterization and identification of micro-organisms by FT-IR spectroscopy and FT-IR microscopy. In *Bacterial Diversity and Systematics*, pp. 67–85, F.G. Priest, A. Ramos Cormenzana, and B.J. Tindall, Eds., Plenum, NY.
112. Nour M. (1998) 16S-23S and 23S-5S intergenic spacer regions of lactobacilli: Nucleotide sequence, secondary structure and comparative analysis. *Res. Microbiol.* 149, 433–448.



113. Ogier J.C., O. Son, A. Gruss, P. Tailliez, and A. Delacroix-Buchet (2002) Identification of the bacterial microflora in dairy products by temporal temperature gradient gel electrophoresis. *Appl. Environ. Microbiol.* 68, 3691–3701.
114. Ogier J.-C., V. Lafarge, V. Girard, A. Rault, V. Maladen, A. Gruss, J.-Y. Leveau, and A. Delacroix-Buchet (2004) Molecular fingerprinting of dairy microbial ecosystems by use of temporal temperature and denaturing gradient gel electrophoresis. *Appl. Environ. Microbiol.* 70, 5628–5643.
115. O'Sullivan T.F. and G.F. Fitzgerald (1998) Comparison of *Streptococcus thermophilus* strains by pulse field gel electrophoresis of genomic DNA. *FEMS Microbiol. Lett.* 168, 213–219.
116. Østlie H.M., L. Eliassen, A. Florvaag, and S. Skeie (2005) Phenotypic and PCR-based characterization of the microflora in Präst cheese during ripening. *Int. Dairy J.* 15, 911–920.
117. Peters S., S. Koschinsky, F. Schwieger, and C.C. Tebbe (2000) Succession of microbial communities during hot composting as detected by PCR-single-strand-conformation-polymorphism-based genetic profiles of small-subunit rRNA genes. *Appl. Environ. Microbiol.* 66, 930–936.
118. Papadelli M., E. Manolopoulou, G. Kalantzopoulos, and E. Tsakalidou (2003) Rapid detection and identification of *Streptococcus macedonicus* by species-specific PCR and DNA hybridisation. *Int. J. Food Microbiol.* 81, 233–241.
119. Petersen K.M. and L. Jesperen (2004) Genetic diversity of the species *Debaryomyces hansenii* and the use of chromosome polymorphism for typing of strains isolated from surface-ripened cheeses. *J. Appl. Microbiol.* 97, 205–213.
120. Piraino P., A. Ricciardi, G. Salzano, T. Zotta, and E. Parente (2006) Use of unsupervised and supervised artificial neural networks for the identification of lactic acid bacteria on the basis of SDS-PAGE patterns of whole cell proteins. *J. Microbiol. Methods* 66, 336–346.
121. Pot B., C. Hertel, W. Ludwig, P. Deschee-Maeker, K. Kersters, and K.H. Schleifer (1993) Identification and classification of *Lactobacillus acidophilus*, *L. gasseri* and *L. johnsonii* strains by SDS-PAGE and rRNA-targeted oligonucleotide probe hybridization. *J. Gen. Microbiol.* 139, 513–517.
122. Pot B., P. Vandamme, and K. Kersters (1994a) Analysis of electrophoretic whole-organism protein fingerprints. In *Chemical Methods in Prokaryotic Systematics*, pp. 493–521, M. Goodfellow and A.G. O'Donnell, Eds., Wiley, Chichester, U.K.
123. Pot B., W. Ludwig, K. Kersters, and K.-H. Schleifer (1994b) Taxonomy of lactic acid bacteria. In *Bacteriocins of Lactic Acid Bacteria*, pp. 13–90, L. De Vuyst and E.J. Vandamme, Eds., Blackie Academic and Professional Glasgow, U.K.
124. Prillinger H., O. Molnar, F. Eliskases-Lechner, and K. Lopandic (1999) Phenotypic and genotypic identification of yeasts from cheese. *Ant. Leeuwen.* 75, 267–283.
125. Psoni L., C. Kotzamanides, C. Andrighetto, A. Lombardi, N. Tzanetakis, and E. Litopoulou-Tzanetaki (2006) Genotypic and phenotypic heterogeneity in *Enterococcus* isolates from Batzos, a raw goat milk cheese. *Int. J. Food Microbiol.* 109, 109–120.
126. Psoni L., C. Kotzamanidis, M. Yiangou, N. Tzanetakis, and E. Litopoulou-Tzanetaki (2007) Genotypic and phenotypic diversity of *Lactococcus lactis* isolates from Batzos, a Greek PDO raw goat milk cheese. *Int. J. Food Microbiol.* 114, 211–220.
127. Randazzo C.L., S. Torriani, A.D.L. Akkermans, W.M. de Vos, and E.E. Vaughan (2002) Diversity, dynamics, and activity of bacterial communities during production of an artisanal Sicilian cheese as evaluated by 16S rRNA analysis. *Appl. Environ. Microbiol.* 68, 1882–1892.
128. Rebuffo C.A., J. Schmitt, M. Wenning, F. von Stetten, and S. Scherer (2006) Reliable and rapid identification of *Listeria monocytogenes* and *Listeria* species by artificial neural network-based Fourier transform infrared spectroscopy. *Appl. Environ. Microbiol.* 72, 994–1000.
129. Rementzis J. and J. Samelis (1996) Rapid GC analysis of cellular fatty acids for characterizing *Lactobacillus sake* and *Lact. curvatus* strains of meat origin. *Lett. Appl. Microbiol.* 23, 379–384.
130. Riedel K.-H.J., B.D. Wingfield, and T.J. Britz (1998) Identification of classical *Propionibacterium* species using 16S rDNA-restriction fragment length polymorphisms. *Syst. Appl. Microbiol.* 21, 419–428.

131. Rizzo A.F., H. Korkeala, and I. Mononen (1987) Gas chromatography analysis of cellular fatty acids and neutral monosaccharides in the identification of lactobacilli. *Appl. Environ. Microbiol.* 53, 2883–2888.
132. Robles J.C., L. Koreen, S. Park, and D.S. Perlin (2004) Multilocus sequence typing is a reliable alternative method to DNA fingerprinting for discriminating among strains of *Candida albicans*. *J. Clin. Microbiol.* 42, 2480–2488.
133. Roelleke S., G. Muyzer, C. Wawer, G. Wanner, and W. Lubitz (1996) Identification of bacteria in a biodegraded wall painting by denaturing gradient gel electrophoresis of PCR-amplified gene fragments coding for 16S rRNA. *Appl. Environ. Microbiol.* 62, 2059–2065.
134. Rossetti L. and G. Giraffa (2005) Rapid identification of dairy lactic acid bacteria by M13-generated, RAPD-PCR fingerprint databases. *J. Microbiol. Methods* 63, 135–144.
135. Rossi F., S. Torriani, and F. Dellaglio (1998) Identification and clustering of dairy propionibacteria by RAPD-PCR and CGE-REA methods. *J. Appl. Microbiol.* 85, 956–964.
136. Rossi F., S. Torriani, and F. Dellaglio (1999) Genus- and species specific PCR based detection of dairy propionibacteria in environmental samples by using primers targeted to the genes encoding 16S rRNA. *Appl. Environ. Microbiol.* 65, 4241–4244.
137. Samelis J., J. Rementzis, E. Tsakalidou, and J. Metaxopoulos (1998) Usefulness of rapid GC analysis of cellular fatty acids for distinguishing *Weissella viridescens*, *Weissella paramesenteroides*, *Weissella helenica* and some non-identifiable, arginine-negative *Weissella* strains of meat origin. *Syst. Appl. Microbiol.* 21, 260–265.
138. Sánchez J.I., L. Rossetti, B. Martínez, A. Rodríguez, and G. Giraffa (2006) Application of reverse transcriptase PCR-based T-RFLP to perform semi-quantitative analysis of metabolically active bacteria in dairy fermentations. *J. Microbiol. Methods* 65, 268–277.
139. Santegeods C.M., S.C. Nold, and D.M. Ward (1996) Denaturing gradient gel electrophoresis used to monitor the enrichment culture of aerobic chemoorganotrophic bacteria from a hot spring cyanobacterial mat. *Appl. Environ. Microbiol.* 62, 3922–3928.
140. Schleifer K.H., J. Kraus, C. Dvorak, R. Kilpper-Balz, M.D. Collins, and W. Fischer (1985) Transfer of *Streptococcus luctis* and related streptococci to the genus *Lactococcus* gen. nov. *Syst. Appl. Microbiol.* 6, 183–195.
141. Schwartz D.C. and C.R. Cantor (1984) Separation of yeast chromosome-sized DNAs by pulsed field gradient gel electrophoresis. *Cell* 37, 67–75.
142. Smith D.D. Jr. and S.J. Norton (1980) S-Adenosylmethionine, cyclopropane fatty acid synthase, and the production of lactobacillic acid in *Lactobacillus plantarum*. *Arch. Biochem. Biophys.* 205, 564–570.
143. Švec P., M. Vancanneyt, M. Seman, C. Snauwaert, K. Lefebvre, I. Sedláček, and J. Swings (2005) Evaluation of (GTG)<sub>5</sub>-PCR for identification of *Enterococcus* spp. *FEMS Microbiol. Lett.* 247, 59–63.
144. Tabasco R., T. Paarup, C. Janer, C. Peláez, and T. Requena (2007) Selective enumeration and identification of mixed cultures of *Streptococcus thermophilus*, *Lactobacillus delbrueckii* subsp. *bulgaricus*, *L. acidophilus*, *L. paracasei* subsp. *paracasei* and *Bifidobacterium lactis* in fermented milk. *Int. Dairy J.* 17, 1107–1114.
145. Tailliez P., P. Quenee, and A. Chopin (1996) Estimation de la diversité ' parmi les souches de la collection CNRZ: application de la RAPD a' un groupe de lactobacilles. *Lait* 76, 147–158.
146. Tanskanen E.I., D.L. Tulloch, A.J. Hillier, and B.E. Davidson (1990) Pulsed-field gel electrophoresis of *Sma*I digests of lactococcal genomic DNA, a novel method of strain identification. *Appl. Environ. Microbiol.* 56, 3105–3111.
147. Terzaghi B.E. and W.E. Sandine (1975) Improved medium for lactic streptococci and their bacteriophages. *Appl. Environ. Microbiol.* 29, 807–813.
148. Timmins E.M., S.A. Howell, B.K. Alsberg, W.C. Noble, and R. Goodacre (1998) Rapid differentiation of closely related *Candida* species and strains by pyrolysis-mass spectrometry and Fourier transform-infrared spectroscopy. *J. Clin. Microbiol.* 36, 367–374.

149. Tindall B.J., E. Brambilla, M. Steffen, R. Neumann, R. Pukall, R.M. Kroppenstedt, and E. Stackebrandt (2000) Cultivable microbial diversity: Gnawing at the Gordian knot. *Environ. Microbiol.* 2, 310–318.
150. Tornabene T.G. (1985) Lipid analysis and the relationship to chemotaxonomy. In *Methods in Microbiology*, Vol. 18, pp. 209–234, G. Gottschalk, Ed., Academic Press, London.
151. Tracey R.P. and T.J. Britz (1989) Cellular fatty acid composition of *Leuconostoc oenos*. *J. Appl. Bacteriol.* 66, 445–456.
152. Tsakalidou E., E. Manolopoulou, E. Kabaraki, E. Zoidou, B. Pot, K. Kersters, and G. Kalantzopoulos (1994) The combined use of whole-cell protein extracts for the identification (SDS-PAGE) and enzyme activity screening of lactic acid bacteria isolated from traditional Greek dairy products. *Syst. Appl. Microbiol.* 17, 444–458.
153. Vancanneyt M., A. Lombardi, C. Andrighetto, E. Knijff, S. Torriani, K.J. Björkroth, C.M.A.P. Franz, et al. (2002) Intraspecies genomic groups in *Enterococcus faecium* and their correlation with origin and pathogenicity. *Appl. Environ. Microbiol.* 68, 1381–1391.
154. Vasdinyei R. and T. Deák (2003) Characterization of yeast isolates originating from Hungarian dairy products using traditional and molecular identification techniques. *Int. J. Food Microbiol.* 86, 123–130.
155. Vasiljevic T. and N.P. Shah (2008) Probiotics—From Metchnikoff to bioactives. *Int. Dairy J.*, 18, 714–728.
156. Vincent D., D. Roy, F. Mondou, and C. Dery (1998) Characterization of bifidobacteria by random DNA amplification. *Int. J. Food Microbiol.* 43, 185–193.
157. Vorobjeva L.I. (1999). Economic and medical applications. In *Propionibacteria*, pp. 209–243, L.I. Vorobjeva, Ed., Kluwer Academic Publishers, The Netherlands.
158. Zamfir M., M. Vancanneyt, L. Makras, F. Vaningelgem, K. Lefebvre, B. Pot, J. Swings, and L. De Vuyst (2006) Biodiversity of lactic acid bacteria in Romanian dairy products. *Syst. Appl. Microbiol.* 29, 487–495.
159. Zeigler D.R. (2003) Gene sequences useful for predicting relatedness of whole genomes in bacteria. *Int. J. Syst. Evolut. Microbiol.* 53, 1893–1900.
160. Zumstein E., R. Moletta, and J.J. Godon (2000) Examination of two years of community dynamics in an anaerobic bioreactor using fluorescence polymerase chain reaction (PCR) single-strand conformation polymorphism analysis. *Environ. Microbiol.* 2, 69–78.

## *Chapter 31*

---

# Spoilage Detection

---

Maria Cristina Dantas Vanetti

### CONTENTS

31.1	Introduction .....	665
31.2	Detection of Microbial Spoilage of Milk and Dairy Products .....	666
31.2.1	Detection Methods of Spoilage Microorganisms .....	668
31.2.2	Sensorial Detection of Spoilage of Milk and Dairy Products.....	670
31.2.3	Microbial Metabolites as Markers of Milk and Dairy Products Spoilage .....	670
31.2.4	Volatile Compounds as Markers of Milk and Dairy Products Spoilage .....	671
31.3	Detection of Chemical and Physical Spoilage of Milk.....	672
31.4	Modeling Spoilage.....	672
31.5	Future Trends.....	673
	References.....	673

### 31.1 Introduction

With the current world production and distribution systems in the food industry, there is a real need for high-quality, extended shelf-life products. The dairy industry must optimize and improve the processes that result in products that meet the consumers' demands for foods having high quality, nutrition, with functionality, wholesomeness, with less fat and salt, and safe. Despite the development of the dairy industry in the last century, premature spoilage of milk continues to be a problem and causes considerable environmental and economic losses.

Spoilage is a subjective term used to describe the deterioration of foods' texture, color, odor, or flavor as well as the development of slime to the point where the foods are unsuitable for human consumption. Off-odors and off-flavors are a common cause of spoilage of dairy products, and the

economic consequences can be serious. Some spoilage is inevitable, and a variety of factors cause the deterioration of milk and dairy products, including some factors that are mainly physical or chemical, while others are due to the actions of enzymes or microorganisms. These factors are interrelated and dependent on intrinsic product properties, e.g., pH, water activity, endogenous enzymes, and starter cultures, cross-contamination during milking and processing in combination with the presence of oxygen and temperature abuse.

Modern dairy processing utilizes various preservation treatments that result in an assortment of dairy products having vastly different tastes and textures and a complex spoilage microbiota. Despite the complexity of spoilage, detection needs to be fast and accurate, and it may involve detailed microbiological, sensory, and chemical analysis to determine the specific spoilage organism or the actual cause. Rapid and effective means of identifying the potential of spoilage of milk and dairy products and being able to instigate remedial action with little delay are, therefore, essential and advantageous in reducing product food loss.

Numerous methods to detect spoilage have been proposed that aim to determine concentrations of spoilage microorganisms or compounds produced by them or by reactions of food components. However, many of these methods are considered inadequate because they are time-consuming, labor-intensive, and/or do not reliably give consistent results [14]. Sensory and microbiological analyses are most widely used to serve these purposes in today's industry. While sensory analysis is appropriate and, indeed, essential for product development, its reliance on highly trained panels to minimize subjectivity makes it costly and, therefore, unattractive for the other, more routine requirements [11]. It is essential to adopt objective techniques, such as microbiological or chemical analysis, that are less expensive and more convenient. Consequently, for a limited number of foods, various chemical and biochemical markers for spoilage have been proposed and used to measure the quality or degree of spoilage [50].

Microbiological methods, at least in their traditional form, give retrospective information that is satisfactory for product development, but less so for the other requirements [11]. Although traditional methods of estimating bacterial populations offer many advantages for quality control in the dairy industry, they do not provide results quickly enough to allow for intervention. Despite this, they are, to date, routinely used as the main means to detect spoilage of milk and dairy products. To understand the changes that occur in milk and dairy products due to the microbial growth and metabolism and, therefore, to establish the microbial survey for spoilage detection, it is necessary to know this microbiota in specific conditions of the product.

## **31.2 Detection of Microbial Spoilage of Milk and Dairy Products**

Numerous microorganisms, including bacteria, yeasts, and molds, constitute the complex ecosystem present in milk and dairy products, and, in most situations, they quite frequently are associated with product spoilage. Even before spoilage becomes obvious, microorganisms have begun the process of breaking down milk constituents for their own metabolic needs.

Microbial spoilage of milk often involves the degradation of carbohydrates, proteins, and fats by the microorganisms or their enzymes. The metabolic diversity of microorganisms associated with the complexity of food composition requires a more complete understanding of the chemical and physiological characteristics of these organisms in milk, which may lead to the development of better methods of detection and prevention.

Milk, as it leaves the udder of healthy animals, normally contains low numbers of microorganisms, typically ranging from several hundred to a few thousand colony-forming units per

milliliter (CFU/mL). This contaminant microbiota is quite limited and consists predominantly of gram-positive bacteria belonging to micrococci and lactococci groups and *Corynebacterium bovis* [43]. These bacteria are generally mesophilic, and their growth and concomitant spoilage of milk are inhibited if the milk is immediately refrigerated and stored at temperatures below 4°C. Without prompt refrigeration, milk spoilage occurs due to the conversion of lactose to lactic acid by mesophilic contaminants. The development of lactic acid in milk is accompanied by an odor usually described as “sour” due to the production of very small amounts of acetic and propionic acids [44]. Pasteurization will not improve the flavor of raw milk if acid has already developed. The acidity determination is a fundamentally important test for the industry because it indicates the convenience or inconvenience of using the milk. The AOAC official method of number 947.05 for determining the acidity of milk established the titrimetric procedure with 0.1 M NaOH and phenolphthalein as an indicator [1]. The spectrophotometric method (number 437.05) for lactic acid in milk is also described [1]. The acidity of the milk can also be determined routinely and quickly by the Alizarol test.

Nonaseptically drawn milk usually contains a diverse group of bacteria capable of growing over a wide range of storage temperatures. These contaminants originate from contact surface, soil, dust, water, bedding, manure, feed, milking equipment, and milk handlers. This contamination of raw milk will affect not only the shelf-life of dairy products but also the technological and economical aspects of milk processing. Refrigerating raw milk is universally acceptable for extending the shelf-life and eliminating spoilage by mesophilic bacteria. However, the growth of psychrotrophic microorganisms is permitted, mainly gram-negative bacteria, which produce heat-resistant extracellular enzymes such as proteases and lipases that further damage milk and milk products. Psychrotrophic microorganisms are defined as those that can grow at 7°C or below, within 7–10 days incubation, regardless of their optimal growth temperature [19]. In most countries, changes in the procedures for collecting milk on farms and in management practices at dairies lead to a fluid milk plant processing raw milk 2–5 days old. At this time, psychrotrophic bacteria will develop and generate a variety of defects in dairy products.

Although psychrotrophic bacteria are in a small part of fresh collected milk, they compose up to 80% of the population of raw refrigerated milk, and *Pseudomonas* spp. are the most important of the psychrotrophs that dominate the microbiota of raw or pasteurized milk at the time of storage. This genus is represented by species with the shortest generation times at 0°C–7°C. *Pseudomonas fragi*, *Pseudomonas fluorescens*, and *Pseudomonas putida* are the most common species, and they are recognized as producers of proteolytic and lipolytic thermostable enzymes. Other genera of gram-negative psychrotrophic bacteria include *Achromobacter*, *Aeromonas*, *Alcaligenes*, *Chromobacterium*, *Flavobacterium*, *Serratia*, and *Enterobacter*. Thermotolerant bacteria are those that survive pasteurization, and they are represented mainly by gram-positive bacteria in the genera *Bacillus* and *Clostridium* spp. and the nonsporeformers genera *Arthrobacter*, *Microbacterium*, *Streptococcus*, and *Corynebacterium* that are involved in spoilage. Some psychrotrophic *Bacillus* spp. secrete heat-resistant extracellular proteases, lipases, and phospholipases (lecithinase) that are of comparable heat resistance as those of pseudomonas. *Bacillus cereus* frequently isolated from milk has been examined carefully because of its “bitty cream” defect and potential enterotoxin production. Some *Enterococcus* isolates can grow at 7°C and have demonstrable proteolytic activity. These bacteria constitute only a minor population of the microbiota in raw milk, but their number may be proportionally higher in pasteurized milk because of their resistance to pasteurization temperatures.

Yeasts and molds are a common cause of spoilage of fermented dairy products because of the low pH usually found in these products. Low water activity in some hard cheeses, sweetened condensed milk, and butter can also favor yeasts and molds spoilage.

### 31.2.1 Detection Methods of Spoilage Microorganisms

Once they are of crucial importance in milk spoilage, psychrotrophic populations could be determined for milk shelf-life prediction or to determine spoilage. Standard plate count procedures are traditionally used to detect psychrotrophic bacteria in milk and milk products, but these techniques require plates to be incubated at 7°C for 7–10 days [19]. This method is time-consuming, labor-intensive, and does not leave time for intervention, but it is still applicable to raw and pasteurized milk, cream, and cottage cheese [19]. Several variations of time and temperature of incubation of the conventional plate count procedure were proposed as 16 h at 17°C followed by 3 days at 7°C [10] and 25 h at 21°C for milk and cream [29].

These quantitative methods for psychrotrophs require careful interpretation, since there is no agreement about the number of this group of bacteria that cause milk spoilage. The number of psychrotrophs required to produce off-flavors varies among species, and it is determined not only by the growth rate at the storage temperature but also by the proteolytic and lipolytic activity and heat resistance of the enzymes. Some authors defend the theory that there is a significant correlation between the initial count of psychrotrophs and the storage life of raw milk at refrigeration temperatures. Generally, high levels of psychrotrophic bacteria in raw milk are required to contribute sufficient quantities of heat-stable proteases and lipases to cause the breakdown of protein and fat after pasteurization. The number of psychrotrophs generally required to initiate spoilage in milk is about  $10^6$  CFU/mL [4,39]. For *Pseudomonas* sp.,  $2.7 \times 10^6$  to  $9.3 \times 10^7$  CFU/mL were required to produce off-flavors, while for *Alcaligenes* sp.,  $2.2 \times 10^6$  to  $3.6 \times 10^7$  CFU/mL were needed [5]. The development of off-flavors, including bitterness and texture problems in cheese caused by proteases from psychrotrophs, has been reported, but only when psychrotroph counts in milk were  $2 \times 10^6$  to  $5 \times 10^8$  CFU/mL. However, milk spoilage by psychrotrophs was reported in the range of populations of  $10^2$ – $10^9$  per mL [46]. Gelation of UHT milk can result from the activity of proteolytic enzymes of psychrotrophs at counts from  $10^4$  to  $10^8$  CFU/mL [5]. Milk spoilage observed in counts as low as  $10^2$  CFU/mL makes it unclear whether psychrotroph counts can be used as an index in the determination of milk quality or shelf-life from a sensory standpoint. The results of Duyvesteyn et al. [15] showed that the psychrotrophs count at the sensory end of shelf-life is poorly correlated with the sensory shelf-life of milk; therefore, they suggest that the best way to determine the sensory endpoint of milk is by sensory testing and not by plate count method.

Despite this controversy regarding the number of microbial contaminants for milk spoilage, *Pseudomonas* spp. are considered the most important causative agent, and detection and enumeration of these bacteria is useful to establish contamination and potential spoilage microbiota. Current methods of identification and enumeration of *Pseudomonas* spp. in milk involve plating milk or dairy samples onto *Pseudomonas* selective media, e.g., cetrimide, fucidin, cephaloridine (CFC) agar [17], and confirmation of well-isolated colonies by biochemical methods. One major problem associated with commercially available *Pseudomonas* selective media is insufficient selectivity for the genus *Pseudomonas* [17]. Indeed, culture and identification assay require time to produce results, and underestimation of bacterial numbers sometimes occurs because the conventional techniques could not recover sublethally injured cells that may occur in heat-treated products such as pasteurized milk.

Another alternative is to test for groups of microorganisms that are of particular significance in milk spoilage such as proteolytic and lipolytic bacteria or yeasts and molds in fermented milk and hard cheeses. Proteolytic bacteria can be determined by plating samples on skim milk agar or standard caseinate agar and lipolytic bacteria on spirit blue agar [19].

Enumeration of lipolytic microorganisms is not usually performed as a routine analysis but only when a problem arises, and the results can indicate whether the particular lipid-related problem

is of microbial or nonmicrobial origin. Considering that microbial lipases are often heat-resistant while the producer microorganisms are not, enzymes of microbial origin can be found in the absence of viable cells.

Count of yeasts and molds by conventional plating method using agar media added to antibiotic or acid for bacteria inhibition is time-consuming and at least 5 days incubation is suggested [19].

Although conventional microbiological methods can identify the spoilage potential of the microbiota found in milk and dairy products, they are time-consuming. To overcome these limitations, molecular biological, biochemical, and immunological techniques have been applied for the rapid and specific detection of microorganisms [21]. Rapid and simple culture-independent methods are required for the detection of proteolytic psychrotrophic bacteria in milk, once it is considered the most important spoilage microbiota. Several culture-independent methods are used for the detection of bacteria in food. Molecular approaches based on direct analyses of DNA or RNA in its environment without microbial enrichment has allowed more precise descriptions of microbial dynamics in complex ecosystems [31]. PCR is one of the most useful techniques because of its high sensitivity, and most research that has applied PCR to milk analysis has focused on pathogen detection [2,13,20,32,40].

Improvements in molecular diagnostic methods are largely dependent on the identification of suitable DNA sequences to use as targets for species' identification and enumeration [35]. The *apr* gene encodes for alkaline metalloprotease in *Pseudomonas* and other related bacteria and was used to detect proteolytic *Pseudomonas* in milk by PCR [37]. A detection limit assay indicated that the *apr* gene could be directly amplified from pasteurized milk contaminated with  $10^8$  CFU/mL of *P. fluorescens* and with  $10^5$  CFU/mL in reconstituted skim milk powder if cells were recovered for DNA extraction before amplification [37]. This could reduce the time for detection of proteolytic bacteria in raw milk, allowing the processor to decide about the best use of raw milk during processing. However, an improvement in sensitivity of the assay and a reduction in the cost of the reagents and equipments would seem to be required before this goal could be achieved. Moreover, the sensitivity of PCR assays may be further improved when combined with immunocapture.

Total cell numbers in milk can be obtained with flow cytometry analysis, and this method is currently used by many dairies to determine milk quality [51]. The currently applied flow cytometry techniques do not provide information about the number and identity of potential pathogens or spoilage microorganisms that might be present in milk. This limitation could be eliminated by combining flow cytometry with fluorescent in situ hybridization (FISH) that utilizes fluorescently labeled DNA oligonucleotide probes to detect specific sequences of ribosomal RNA (rRNA) [24]. FISH is another rapid technique considered for the detection and enumeration of *Pseudomonas* spp. in milk [24,30]. The numbers of respiring *Pseudomonas* cells as determined by FISH using fluorescent redox dye 5-cyano-2,3-ditoly tetrazolium chloride (CTC) staining (CTC-FISH) were almost the same or higher than the numbers of colony counts as determined by the conventional culture method.

New highly sensitive and specific microbial methods based on immunological assay have already been developed for the detection of pathogenic microorganisms, and many are available commercially. Enzyme-linked immunosorbent assay (ELISA) was used to detect *P. fluorescens* in milk and has a sensitivity of  $10^5$  CFU/mL [22]. Polyclonal antibodies were produced against a pool of *P. fluorescens* strains isolated from milk and, using immunodot blot, the limit of detection was  $10^5$  CFU/mL [34]. However, more research needs to be done to develop a polyclonal antibody to recognize many genera of psychrotrophs associated with milk spoilage.

More rapid techniques to detect spoilage microorganisms in foods continue to be evaluated (e.g., epifluorescent microscopy and electrical impedance). Like the traditional methods, they also presuppose that the specific spoilage organisms are known and detectable by the chosen technique.



### **31.2.2 Sensorial Detection of Spoilage of Milk and Dairy Products**

Despite the importance of microorganisms in food spoilage, the definition and assessment of spoilage relies on sensory evaluation [23]. A sensory evaluation technique, such as descriptive analysis, is useful in obtaining objective data from human subjects and can be used to characterize aromas and differentiate milks on quality aspects [8]. Although suitable panel methods and statistical examination by humans are fairly reliable, daily and real-time tasting of foods is very laborious.

The most common defect observed in milk and associated with psychrotrophs is an “unclean” flavor, but aroma characteristics of spoiled milk differ by the specific spoilage microorganisms and fat content of the milk. Milks containing *P. fragi* were high in fruity attributes, while those with *P. fluorescens* and *P. putida* exhibited proteolytic aromas. Whole milks were high in rancid/cheesy aromas regardless of the organism. Unpleasant aromas are characteristic of spoiled milk, and a more complete understanding of bacteria-induced spoilage is necessary for the development of shelf-life prediction procedures.

### **31.2.3 Microbial Metabolites as Markers of Milk and Dairy Products Spoilage**

An alternative or ancillary method to microbiological and sensorial analyses involves the measurement of chemical changes associated with microbial spoilage of foods [11]. However, its application has not been as intensively researched as the microbiological and sensory methods in routine use today.

Growth of psychrotrophic bacteria in raw milk during cold storage results in simultaneous production of various heat-stable proteolytic and lipolytic enzymes that are resistant to pasteurization and ultrahigh temperatures used to treat UHT milk. Many enzymes resistant to the heat processes applied in the manufacture of processed milk and dairy products, particularly proteases and lipases, are from *Pseudomonas* and *Bacillus* species. These enzymes may, therefore, cause spoilage of the final products during storage.

Proteolysis in milk occurs also due to the activity of the native milk's proteases such as plasmin, a serine protease that enters milk from the blood in the form of plasminogen. Other proteases may be secreted from mammary tissue cells, blood plasma, or leucocytes.

The peptides produced as a result of proteolysis usually give rise to bitter flavors, and reactions of the released amino acids produce browning on heating. Furthermore, proteolytic enzymes strongly contribute to spoilage off-flavor development, decreased yield during the cheese production, milk heat-stability loss, gelation of UHT-sterilized milk, and reduced shelf-life of dairy products [6,12,16]. Proteolytic activity is the main cause of UHT milk spoilage, causing bitterness and gelation problems [12]. As low levels of this enzyme are sufficient to cause undesirable amounts of protein degradation in UHT milk during storage at room temperature, sensitive methods for their detection have been sought by the dairy industry. However, no method has been universally adopted for this purpose [12].

Methods for measuring the extent of proteolysis in milk by bacterial proteases include analysis of the peptides produced and/or quantifying them by the external standard. Early methods for the detection of protease activity in milk were based on measuring increases in the levels of tyrosine- or tryptophan-containing peptides using the Folin–Ciocalteu reagent [26]. Later, methods using reagents, such as fluorescamine, trinitrobenzene sulfonic acid (TNBS), and *o*-phthaldialdehyde (OPA), were developed to detect changes in the levels of  $\alpha$ -amino groups [7,27,38]. In the last

decade, more sensitive assays have been developed, such as enzyme-linked bioluminescent, fluorescent, immunological, and radiometric assays. The possible responsible proteases could be indicated by examining the peptide cleavage by capillary reversed-phase high-performance liquid chromatography (RP-HPLC) and identified by matrix-assisted laser desorption/ionization-time of flight tandem mass spectrometry (MALDI-TOF MS/MS) [52].

Other products resulting from protein catabolism are the biogenic amines such as putrescine, cadaverine, histamine, and tyramine, which are commonly produced during fermentation or spoilage of high protein products by decarboxylation of the amino acids through substrate-specific enzymes produced by microorganisms. Starter cultures or contaminant microorganisms in milk and cheese production processes can present decarboxylase activity. At higher concentrations, biogenic amines may have unwanted health consequences for consumers. Several methods to analyze biogenic amines in food based on thin layer chromatography, liquid chromatography, gas chromatography (GC), biochemical assays, and capillary electrophoresis have so far been described, but the complexity of the real matrices is the most critical in terms of obtaining adequate recoveries for all amines [41]. In cheese, a direct correlation between microorganism counts and the content of biogenic amines is difficult to find because the amine-producing abilities of different bacteria differ widely [25,28,48]. However, a positive correlation between the concentration of the biogenic amine cadaverine and Enterobacteriaceae counts in hard and semihard cheeses was determined [36], but, at this time, this analysis is not adopted as a definitive test for spoilage detection in this product.

As proteolysis can be due to the presence of native protease plasmin and other proteases liberated from somatic cells, the count of somatic cells (SCC) is indicated as a marker for proteolytic potential present in milk. In the past, fluid milk processors have not focused much on milk SCC, but now this view is changing, as it is known that increased SCC is correlated with increased amounts of the heat-stable protease plasmin and lipase in milk. When processing raw milk that has a low bacterial count, and in the absence of microbial growth in pasteurized milk, enzymes associated with high SCC will cause protein and fat degradation during refrigerated storage and produce off-flavors [3]. Using high SCC milk for cheese-making causes compromised sensory quality. The detected sensory defects were predominantly “rancid” and “bitter,” which were consistent with the increased proteolysis and lipolysis observed in the high SCC milks [33]. Somatic cells in milk have been determined by using direct microscopic count or electronically by flow cytometry [19].

Lipolysis occurs due to the action of natural or microbial lipolytic enzymes that are able to hydrolyze triglycerides, a milk fat constituent, in the fatty acids of small chains such as butyric, caproic, caprylic, and capric acid, which are mainly responsible for off-flavors in milk and for rancidity in cheese [6]. Free fatty acids with short chain acids (C4–C8) give rise mainly to rancid flavors, while the middle length chains (C10–C12) give rise to most of soapy, unclean, or bitter flavors. Microorganisms that produce lipolytic enzymes are important in the dairy industry because they can produce rancid flavors and odors in milk and dairy products that make these foods unacceptable to consumers [9]. Lipolytic enzymes produced by psychrotrophs are more important than proteases in relation to the development of defects of flavor in cheese because proteases are soluble in water and lost in the whey, while lipases are adsorbed in the fatty globules and retained in cheese mass [18].

### **31.2.4 Volatile Compounds as Markers of Milk and Dairy Products Spoilage**

All the analyses described so far require extracts of foods. A less invasive and more rapid means for monitoring spoilage is the detection of volatile compounds produced by spoilage bacteria. At

least some of the problems inherent in sampling are thereby avoided, and the food itself is not disturbed. Specific volatile compounds have been identified and related to the growth of several microorganisms in biological samples, and these results promise to be useful for early diagnosis of food spoilage. To identify the individual volatile components, the headspace sampling techniques are usually coupled to GC/MS. Thus, a relatively simple, rapid technique with great resolving power is available for routine troubleshooting of spoilage problems.

The range of end-products of microbial growth that have the potential for use in the determination of shelf-life is far wider than that for substrates. Of particular interest in the determination of volatile biomolecules is the commercial availability of the so-called “electronic noses.” The electronic nose instrumentation was developed in the early 1980s, and it can perform odor detection continually without being subject to individual sensitivity. Since then, the analyses of volatile compounds have been of increasing interest, and many studies have been dedicated to the improvement of odor measurements. This technology aims to mimic the mammalian sense of smell by producing a composite response unique to each odorant. It consists of an array of gas sensors with different selectivity patterns, a signal-collecting unit, and pattern recognition software applied to a computer. Multivariate statistics were used to create models that detect the spoilage markers.

With this technique, volatiles are detected, but not identified, through their relatively non-specific adsorption to electronic sensors (e.g., gas-sensitive metal oxide semiconductor field effect transistors and conducting organic polymers). The responses are analyzed within the instrument using pattern recognition techniques such as artificial neural networks and results printed out in real time [11]. The electronic nose system could distinguish among the volatile profiles of different microbial species inoculated in milk-based media after 2 and 5 h of incubation.

A high correlation was established between the complex mixtures of volatile compounds formed and the shelf-life of the refrigerated milk as determined by sensory analysis [49].

In the last years, there has been interest in using similar concepts of the electronic nose in aqueous solutions. This system, denominated of “electronic tongue,” is related to the sense of taste in similar ways as the electronic nose is related to olfaction, and it is composed of several kinds of lipid/polymer membranes for transforming information about taste substances into electric signals, which are analyzed by a computer [47]. The taste sensor may be applicable for quality control in the food industry and help assess taste objectively.

### **31.3 Detection of Chemical and Physical Spoilage of Milk**

Milk has a high content of both protein and reducing sugar, and its close-to-neutral pH favors the occurrence of the Maillard reaction that causes the formation of off-flavor and color changes during storage that impair product quality. Additionally, dairy products, in particular, are very sensitive to light oxidation that results in the development of off-flavors, discoloration and, the decrease in nutritional quality. Products of Maillard reaction and oxidation are measured by chemical means (e.g., GC and HPLC, loss of lysine availability, advanced glycosylation end-products, and fluorescence spectroscopy).

### **31.4 Modeling Spoilage**

Several intrinsic and extrinsic factors determine whether spoilage microorganisms will be successful in utilizing the nutrients in a food. These include water activity and types of solutes, pH,

storage, and processing temperature, oxygen and carbon dioxide levels, solid or liquid state of food, available nutrients and preservatives, and competing microbiota [14]. The knowledge of microbial responses to these conditions enables objective evaluation and prediction of the spoilage process. Predicting spoilage involves the accumulation of knowledge on microbial behavior in foods and its distillation into mathematical models, based on and validated by actual experimental data. These models can provide useful information for product development and modification, shelf-life estimates, processing requirements, and quality assurance programs. Depending on their objective, models are constructed to focus on the probability of growth/no growth, time required to initiate growth, growth rate, or survival of spoilage organisms under a particular set of parameters. Inactivation and destruction of microbes exposed to different preservatives or preservation techniques can also be modeled. However, models cannot incorporate every factor that may affect the spoilage process, and processors should validate models for their own products to account for different variables [14].

### 31.5 Future Trends

Although food spoilage is a huge economical problem worldwide, it is obvious that the mechanisms and interaction leading to food spoilage are very poorly understood. Understanding microbial food spoilage is a multidisciplinary task that is required to provide a scientific basis for better preservation methods. The spoilage of some foods is not just a function of cell biomass but a complex process whereby the spoilage may be regulated by bacterial communication signals such as acylated homoserine lactones (AHLs). These molecules allow cells to control many of their functions such as surface colonization and motility, production of exopolymers, production of antibiotics, biofilm development, bioluminescence, cell differentiation, competence for DNA uptake, growth, pigment production, conjugal plasmid transfer, sporulation, toxin production, virulence gene expression, and production of a range of hydrolytic enzymes [45]. AHL-production is common among psychrotrophic bacteria isolated from milk, and indicate that quorum sensing may play an important role in the spoilage of this product [42]. However, our knowledge about the influence of the different spoilage organisms and bacterial pathogens is still very limited from a microbial cell-signaling point of view. Such understanding of spoilage processes and their regulation may allow the development of more targeted, and often milder, food preservation techniques.

Another future application of particular interest is food spoilage detection by sensors integrated into the food packaging. These sensors would eliminate the need for inaccurate expiration dates and provide real-time status of food freshness. Furthermore, it is expected that some advances in nanotechnology will improve the portability, sensitivity, and speed of detection of food spoilage.

### References

1. AOAC—Association of Official Analytical Chemists. 2006. *Official Methods of Analysis*, 18th edn., Washington, DC.
2. Aurora, R., Prakash, A., Prakash, C., Rawool, D.B., Barbuddhe, S.B. 2008. Comparison of PI PLC based assays and PCR along with *in vivo* pathogenicity tests for rapid detection of pathogenic *Listeria monocytogenes*. *Food Control*, 19:641–647.
3. Barbano, D.M., Ma, Y., Santos, M.V. 2006. Influence of raw milk quality on fluid milk shelf life. *Journal of Dairy Science*, 89(E. Suppl.):E15–E19.

4. Birkeland, S.E., Stepaniak, L., Sørhaug, T. 1985. Quantitative studies of heat-stable proteinase from *Pseudomonas fluorescens* P1 by the enzyme-linked immunosorbent assay. *Applied and Environmental Microbiology*, 49:382–387.
5. Champagne, C.P., Laing, R.R., Roy, D., Mafu, A.A., Griffiths, M.W. 1994. Psychrotrophs in dairy products: their effects and their control. *Critical Reviews in Food Science and Nutrition*, 34:1–30.
6. Chen, L., Daniel, R.M., Coolbear, T. 2003. Detection and impact of protease and lipase in milk and milk powders. *International Dairy Journal*, 13:255–275.
7. Church, F.C., Swaisgood, H.E., Porter, D.H., Catignani, G.L. 1983. Spectrophotometric assay using *o*-phthaldialdehyde for determination of proteolysis in milk and isolated milk proteins. *Journal of Dairy Science*, 66:1219–1227.
8. Claassen, M., Lawless, H.T. 1992. Comparison of descriptive terminology systems for sensory evaluation of fluid milk. *Journal of Food Science*, 57: 596–600.
9. Cousin, M.A. 1982. Presence and activity of psychrotrophic microorganisms in milk and dairy products: A review. *Journal of Food Protection*, 45:172–207.
10. Cousin, M.A., Jay, J.M., Vasavada, P.C. 2001. Psychrotrophic microorganisms. In Dowes, F.P. and Ito, K. (eds.), *Compendium of Methods for the Microbiological Examination of Foods*, 4th edn., American Public Health Association, Washington, DC, pp. 159–166.
11. Dainty, R.H. 1996. Chemical/biochemical detection of spoilage. *International Journal of Food Microbiology*, 33:19–33.
12. Datta, N., Deeth, H.C. 2001. Age gelation of UHT milk—A review. *Institution Chemical of Engineers*, 79:197–210.
13. Desmarchelier, P.M., Bilge, S.S., Fegan, N., Mills, L., Vary J.C. Jr., Tarr, P.I. 1998. A PCR specific for *Escherichia coli* O157 based on the *rfb* locus encoding O157 lipopolysaccharide. *Journal of Clinical Microbiology*, 36:1801–1804.
14. Doyle, E.M. 2007. *Microbial Food Spoilage—Losses and Control Strategies A Brief Review of the Literature*, University of Wisconsin, Madison, WI.
15. Duyvesteyn, W.S., Shimoni, E., Labuza, T.P. 2001. Determination of the end of shelf-life for milk using Weibull hazard method. *Lebensm.-Wiss. u.-Technology*, 34:143–148.
16. Fairbairn, D.J., Law, B.A. 1986. Proteinases of psychrotrophic bacteria: Their production, properties, effects and control. *Journal of Dairy Research*, 53:139–177.
17. Flint, S., Hartley, N. 1996. A modified selective medium for the detection of *Pseudomonas* species that cause spoilage of milk and dairy plants. *International Dairy Journal*, 6:223–230.
18. Fox, P.F. 1989. Proteolysis during cheese manufacture and ripening. *Journal of Dairy Science*, 72:1379–1400.
19. Frank, J.F., Yousef, A.E. 2004. Tests for groups of microorganisms. In Wehr, H.M and Frank, J.F. (eds.), *Standard Methods of the Examination of Dairy Products*, 17th edn., American Public Health Association, Washington, DC, pp. 227–247.
20. Gao, A., Mutharia, L., Raymond, M., Odumeru, J. 2007. Improved template DNA preparation procedure for detection *Mycobacterium avium* subsp. *paratuberculosis* in milk by PCR. *Journal of Microbiological Methods*, 69:417–420.
21. Giraffa, G., Neviani, E. 2001. DNA-based, culture-independent strategies for evaluating microbial communities in food-associated ecosystems. *International Journal of Food Microbiology*, 67:19–34.
22. González, I., Martin, R., Garcia, T., Morales, P., Sanz, B., Hernández, P.E. 1994. Detection of *Pseudomonas fluorescens* and related psychrotrophic bacteria in refrigerated meat by sandwich ELISA. *Journal of Food Protection*, 57:710–714.
23. Gram, L., Ravn, L., Rasch, M., Bruhn, J.B., Christensen, A.B., Givskov, M. 2002. Food spoilage-interactions between food spoilage bacteria. *International Journal of Food Microbiology*, 78:79–97.
24. Gunasekera, T.S., Dorsch, M.R., Slade, M.B., Veal, D.A. 2003. Specific detection of *Pseudomonas* spp. in milk by fluorescence in situ hybridization using ribosomal RNA directed probes. *Journal of Applied Microbiology*, 94:936–945.

25. Halasz, A., Barath, A., Simon-Sarkadi, L., Holzhapeel, W. 1994. Biogenic amines and their production by microorganisms in food. *Trends in Food Science and Technology*, 5:42–46.
26. Hull, M.E. 1947. Studies on milk proteins. II. Colorimetric determination of the partial hydrolysis of the proteins in milk. *Journal Dairy Science*, 30:881–894.
27. Humbert, G., Guingamp, M.F., Kouomegne, R., Linden, G. 1990. Measurement of proteolysis in milk and cheese using trinitrobenzene sulphonic acid and a new dissolving reagent. *Journal of Dairy Research*, 57:143–148.
28. Innocente, N., D'Agostin, P. 2002. Formation of biogenic amines in a typical semihard Italian cheese. *Journal of Food Protection*, 65:1498–1501.
29. IDF—International Dairy Federation. 1991. Determination of free fatty acids in milk and milk products. Brussels: IDF (*FIL-IDF Standard no. 265*).
30. Kitaguchi, A., Yamaguchi, N., Nasu, M. 2005. Enumeration of respiring *Pseudomonas* spp. in milk within 6 hours by fluorescence in situ hybridization following formazan reduction. *Applied and Environmental Microbiology*, 71:2748–2752.
31. Lafarge, V., Ogier, J.C., Girard, V., Maladen, V., Leveau, J.Y., Gruss, A., Delacroix-Buchet, A. 2004. Raw cow milk bacterial population shifts attributable to refrigeration. *Applied and Environmental Microbiology*, 70:5644–5650.
32. Lindqvist, L., Norling, B., Thisted Lambertz, S. 1997. A rapid sample preparation method for PCR detection of food pathogens based on buoyant density centrifugation. *Letters in Applied Microbiology*, 24:306–310.
33. Ma, Y., Ryan, C., Barbano, D.M., Galton, D.M., Rudan, M., Boor, K. 2000. Effects of somatic cell count on quality and shelf-life of pasteurized fluid milk. *Journal of Dairy Science*, 83:1–11.
34. Machado, A.D.S. 2006. Atividade proteolítica de *Pseudomonas fluorescens* em biofilmes e detecção das células por anti-soro policlonal. DSc Tese. Departamento de Microbiologia, Universidade Federal de Viçosa.
35. Marco, M.L., Wells-Bennik, M.H.J. 2008. Impact of bacterial genomics on determining quality and safety in the dairy production chain. *International Dairy Journal*, 18:486–495.
36. Marino, M., Maifreni, M., Moret, S., Rondinini, G. 2000. The capacity of Enterobacteriaceae species biogenic amines in cheese. *Letters in Applied Microbiology*, 31:169–173.
37. Martins, M.L., Araújo, E.F., Mantovani, H.C., Moraes, C.A., Vanetti, M.C.D. 2005. Detection of the *apr* gene in proteolytic psychrotrophic bacteria isolated from refrigerated raw milk. *International Journal of Food Microbiology*, 102: 203–211.
38. McKellar, R.C. 1981. Development of off-flavors in ultra-high temperature and pasteurized milk as a function of proteolysis. *Journal of Dairy Science*, 64:2138–2145.
39. Matta, H., Punj, V., Kanwar, S.S. 1997. An immuno-dot blot assay for detection of thermostable protease from *Pseudomonas* sp. AFT-36 of dairy origin. *Letters in Applied Microbiology*, 25:300–302.
40. O' Gradya, J., Sedano-Balba, S., Maherb, M., Smith, T., Barry, T. 2008. Rapid real-time PCR detection of *Listeria monocytogenes* in enriched food samples based on the *ssrA* gene, a novel diagnostic target. *Food Microbiology*, 25:75–84.
41. Önal, A. 2007. Current analytical methods for the determination of biogenic amines in foods. *Food Chemistry*, 103:1475–1486.
42. Pinto, U.M., Viana, E.S., Martins, M.L., Vanetti, M.C.D. 2007. Detection of acylated homoserine lactones in gram-negative proteolytic psychrotrophic bacteria isolated from cooled raw milk. *Food Control*, 18:1322–1327.
43. Ryser, E. 1999. Microorganisms of importance in raw milk. *Michigan Dairy Review*, 8:7–9.
44. Shipe, W.F., Bassette, R., Deane, D.D., Dunkley, W.L., Hammond, E.G., Harper, W.J., Kleyn, D.H., Morgan, M.E., Nelson, J.H., Scanlan, R.A. 1978. Off flavors of milk: Nomenclature, standards, and bibliography. *Journal of Dairy Science*, 61:857–858.
45. Smith, J.L., Fratamico, P.M., Novak, J.S. 2004. Quorum sensing: A primer for food microbiologists. *Journal of Food Protection*, 67:1053–1070.

46. Tekinson, O.C., Tothwell, J.A. 1974. A study on the effect of storage at 5°C on the microbial flora of heat-treated marked cream. *Journal of Society of Dairy Technology*, 27:57–59.
47. Toko, K. 1996. Taste sensor with global selectivity. *Materials Science and Engineering C* 4:69–82.
48. Valsamaki, K., Michaelidou, A., Polychroniadou, A. 2000. Biogenic amine production in Feta cheese. *Food Chemistry*, 71:259–266.
49. Vallejo-Cordoba, B., Nakai, S. 1994. Keeping quality assessment of pasteurized milk by multivariate analysis of dynamic headspace gas chromatographic data. 1. Shelf life prediction by principal component regression. *Journal of Agricultural and Food Chemistry*, 42: 989–993.
50. Velt, J.H.J.H. 1996. Microbial and biochemical spoilage of foods: An overview. *International Journal of Food Microbiology*, 33:1–18.
51. Walte, H.G., Suhren, G., Reichmuth, J. 2005. Bacteriological raw milk quality: Factors influencing the relationship between colony forming units and Bactoscan-FC counts. *Milchwissenschaft-Milk Science International*, 60:28–31.
52. Wedholm A., Møller, H.S., Lindmark-Mansson, H., Rasmussen, M.D., Andrén, A., Larsen, L.B. 2008. Identification of peptides in milk as a result of proteolysis at different levels of somatic cell counts using LC MALDI MS/MS detection. *Journal of Dairy Research*, 75:76–83.

## Chapter 32

---

# PCR-Based Methods for Detection of Foodborne Bacterial Pathogens in Dairy Products

---

Ilex Whiting, Nigel Cook, Marta Hernández,  
David Rodríguez-Lázaro, and Martin D'Agostino

### CONTENTS

32.1	Introduction.....	677
32.2	PCR: Principles and Applications .....	678
32.3	Critical Features of a PCR-Based Method .....	678
32.4	PCR Methods for Foodborne Pathogens in Dairy Products.....	679
32.4.1	<i>Salmonella</i> .....	680
32.4.2	<i>Listeria monocytogenes</i> .....	681
32.4.3	<i>Enterobacter sakazakii</i> .....	682
32.4.4	<i>Mycobacterium avium</i> subsp. <i>paratuberculosis</i> .....	683
32.5	Future Perspective.....	684
	References.....	685

### 32.1 Introduction

Microbiological quality control programs are being increasingly applied throughout the milk production chain to minimize the risk of infection in the consumer. The benefits of adopting the



latest advancements of molecular microbial diagnostics in routine food analysis are becoming increasingly apparent [32], as they possess inherent advantages over the traditional microbiological culturing techniques, such as shorter time to results, excellent detection limits, specificity, and potential for automation. Several molecular detection techniques have been devised in the last two decades, such as nucleic acid sequence-based amplification (NASBA) [12,31]. The technique that has had the maximum development as a practical food analytical tool is the polymerase chain reaction (PCR) [16,24]. A number of PCR-based methods for detection of pathogens in dairy products have been published; there are also methods marketed commercially. This chapter will focus only on open-formula methods published in the scientific literature. Because of their transparency, such methods have the potential for adoption as international standards [16].

## 32.2 PCR: Principles and Applications

Kleppe et al. first described in 1971 the principles of PCR, but it was in 1985, with the introduction of thermostable DNA polymerase [35,36], when the first experimental data were published in collaboration with Dr. Kary Mullis who was awarded the Nobel Prize in Chemistry in 1993. This technique has been applied in different areas owing to its versatility, specificity, and sensitivity and has b32 [32]. PCR is a simple, versatile, sensitive, specific, and reproducible technique that amplifies a DNA fragment exponentially, and its principle is based on the mechanism of DNA replication *in vivo*: double-stranded DNA (dsDNA) is denatured to single-stranded DNA (ssDNA), duplicated, and this process is repeated along the reaction.

A subsequent advancement in PCR has been the development of real-time (RTi) PCR in 1996. It allows monitoring of the synthesis of new amplicon molecules by using fluorescence during the cycling that can be used to quantify the initial amounts of template DNA molecules. Data are therefore collected throughout the PCR process and not just at the end of the reaction (as it occurs in conventional PCR). The major advantages of RTi-PCR are the closed-tube format (that avoids risks of carryover contamination), fast and easy-to-perform analysis, the extremely wide dynamic range of quantification (more than eight orders of magnitude), and the significantly higher reliability of the results when compared with conventional PCR. Fluorescence can be produced during RTi-PCR by an unspecific detection strategy independent of the target sequence using unspecific fluorescent molecules when bound to dsDNA (e.g., ethidium bromide, YO-PRO-1, or SYBR Green I), or by sequence-specific fluorescent oligonucleotides (hydrolysis and hybridization probes). The hydrolysis probes are cleaved by 5'-3' exonuclease activity during the elongation phase of primers. One of the most used are the TaqMan<sup>®</sup> probes that are double-labeled oligonucleotides with a reporter fluorophore at the 5' end and a quencher internally or at the 3' end, which absorbs the fluorescence of the reporter dye because of its proximity allowing the physical phenomenon defined as "fluorescence resonance energy transfer" (FRET). In contrast to hydrolysis probes, hybridization probes are not hydrolyzed during PCR and the fluorescence is generated by a change in its secondary structure during the hybridization phase, which results in an increase in the distance separating the reporter and the quencher dyes.

## 32.3 Critical Features of a PCR-Based Method

The main features that an ideal PCR-based analytical method should possess are defined high-performance characteristics, efficient sample preparation, and appropriate controls.

The principal criteria and parameters for PCR performance as a diagnostic tool are defined in the International Standard ISO 22174 “Microbiology of food and animal feeding stuffs—Polymerase chain reaction (PCR) for the detection of food-borne pathogens—General requirements and definitions” [5]. The ideal PCR assay should be fully specific (able to detect only the desired targets) and possess an excellent analytical sensitivity, e.g., be able to detect  $10^0$ – $10^1$  targets per reaction. In addition, there are some other critical parameters for food analysts: accuracy, precision, and robustness. Accuracy describes the veracity of the test results [38], and can be defined as closeness of agreement between a test result and the accepted reference value [1,28]. Similar terms are trueness and relative accuracy [2]. Precision describes the reproducibility of the test results [38], and can be defined as the closeness of agreement between independent test results obtained under stipulated conditions of repeatability and reproducibility [1,40]. Finally, robustness is the reproducibility by other laboratories using different batches and brands of reagents and validated equipment [17].

The most critical aspect for a PCR-based method is appropriate sample preparation. Bacterial pathogens need in many instances only to be present in low numbers in a foodstuff to pose a hazard to the consumer. The target pathogen or its nucleic acid must be concentrated out of the foodstuff (normally 25 mL or g) into an appropriate volume for a PCR (usually 1–10  $\mu$ L). This is normally achieved by increasing the number of target cells by incubating the food sample in a nutrient broth (enrichment), and chemical extraction of target nucleic acids. In many foods, clinical and environmental matrices, some components may influence the effectiveness of a PCR [33], and can inhibit the reaction preventing a signal even when targets are present. The use of an enrichment step prior to bacterial nucleic acids extraction allows not only the concentration of target bacteria but also the dilution of inhibitory substances that can affect the subsequent analytical steps. In addition, as only living bacterial cells can grow, an enrichment step can be adapted for viability studies, and therefore can guarantee against false-positive results by residual nucleic acids. However, the accuracy of the use of enrichment for detecting only viable bacteria will depend on the background of DNA of dead cells in the food sample.

In PCR diagnostics, internal amplification controls (IACs) are essential to identify false-negative results [17,18]. The IAC is a nontarget nucleic acid sequence present in every reaction, which is coamplified simultaneously with the target sequence [32]. Few published noncommercial assays have included an IAC. The IAC is an absolutely essential feature [6], and any method that does not contain one has no practical value in actual food analysis, since without an IAC, negative results cannot be accepted as unambiguously signifying that the original sample did not contain the target microorganism. In a reaction with an IAC, a control signal will always be produced when there is no target sequence present. When no IAC signal is observed, this means that the reaction has failed. This review therefore will include only those published methods that contain an IAC.

## 32.4 PCR Methods for Foodborne Pathogens in Dairy Products

This section provides brief descriptions of a selection of the currently available PCR-based methods for detection of main foodborne pathogens in dairy products: *Salmonella*, *Enterobacter sakazakii*, *Mycobacterium avium* subsp. *paratuberculosis*, and *Listeria monocytogenes*. Other important microbial pathogens in dairy products such as *Staphylococcus aureus* do not have specific open-formula PCR-based methods including IAC, which is a principal control that should be included in each analytical method, and therefore they will not be discussed in this section. Table 32.1 summarizes the principal analytical features of all the described methods.

**Table 32.1 PCR-Based Methods for the Principal Foodborne Pathogens in Dairy Products**

Bacterium	Target Sequence	Matrix	Sample Preparation	LOD	Reference
<i>Salmonella</i>	<i>ttrRSBCA</i> gene	Milk	Enrichment	≈1 CFU/25 mL	[25]
	<i>invA</i> gene	Milk	Enrichment	≈1 CFU/25 mL	[29]
	<i>invA</i> , <i>prt</i> , <i>fliC-d</i> , and <i>viaB</i> genes	Milk	Enrichment	480 CFU/10 mL	[20]
<i>E. sakazakii</i>	tRNA-glu and 23S rRNA region	Infant formula	Enrichment	≈1 CFU/25 mL	[15]
	16S RNA	Pure culture	(Enrichment) chelex	5 genome equivalent/reaction	[21]
	<i>palE</i>	Infant formula	Enrichment	100 cells/mL	[19]
<i>M. avium paratuberculosis</i>	IS9000	Milk	Direct DNA extraction	100 cells/20 mL	[30]
<i>L. monocytogenes</i>	<i>prfA</i>	Milk	Enrichment	20 cells/20 mL	[13]
	<i>Prú</i>	Cheese and milk	Enrichment	≈1 CFU/25 mL	[34]
	<i>ssrA</i> gene	Soft cheese, milk	Enrichment	1–10 genome equivalents/reaction	[21]

### 32.4.1 *Salmonella*

Malorny et al. [25] developed a robust RTi-PCR method for detection of *Salmonella enterica* and *S. bongori* in different meat products. The target of the RTi-PCR assay was the *ttrRSBCA* gene, required for the tetrathionate respiration in this bacterium, which is located near the *Salmonella* pathogenicity island 2 at centisome 30.5. The platform used by the authors was the DNA Engine Opticon 2 System (MJ Research, South San Francisco, CA). This method was able to identify 110 *Salmonella* strains correctly, and not to detect 87 non-*Salmonella* strains. They sourced 46 raw milk samples obtained from one farm in France. The samples were cooled at 4°C for no longer than 24 h before investigation. The traditional enrichment method for the detection of *Salmonella* in artificially and naturally contaminated samples was performed according to International Standard ISO 6579:2003, which is the internationally accepted traditional culture method to detect *Salmonella* in foodstuffs [3]. A 25 mL sample of raw milk was homogenized in 225 mL of

buffered peptone water (BPW) by mixing. All samples were preenriched for 20 h at 37°C without shaking. DNA was extracted from 1 mL aliquots of the resulting cultures, by Chelex 100 resin (Biorad, Munich, Germany). The diagnostic sensitivity (the proportion of culture-positive samples that test positive in the PCR assay) was 100%, and the diagnostic specificity (the proportion of culture-negative samples that test negative in the PCR assay) was 100%. In addition, Malorny et al. [26] demonstrated the robustness of the assays based on amplification of *ttrRSBCA* and *invA* sequences, by validating them in a multicenter collaborative trial conducted in Germany. Thirteen laboratories analyzed samples of artificially contaminated milk powder by the PCR-based methods (using various thermocycling instruments) in parallel with the standard culture-based method EN ISO 6579:2003 [3]. The trial demonstrated that the PCR-based methods were repeatable, reproducible, and produced results, which were highly comparable with those obtained by the standard method. The work of Malorny and coworkers provides an excellent example of how to take a PCR-based method from development to implementation.

Malorny and coworkers had also previously devised a conventional PCR assay for *Salmonella* based on targeting sequences of the *invA* gene, and validated its analytical accuracy in two collaborative trials [22,23]. Perelle et al. [29] adapted this assay to RTi-format using the LightCycler platform (Roche Diagnostics, Basel, Switzerland). They evaluated the selectivity of the new RTi-PCR method using 84 *Salmonella* and 44 non-*Salmonella* strains, obtaining 100% selectivity with the RTi-PCR assay. Finally, they artificially contaminated 25 mL of milk with different concentrations of *Salmonella* (0, 1–5, 5–10, 10–20, 20–200 CFU/25 g), and diluted them tenfold in BPW, and subsequently they were incubated 18 h at 37°C. One milliliter of enrichment was used for the bacterial DNA extraction using the InstaGene Matrix (Bio-Rad Laboratories, Germany). Simultaneously, they analyzed the enrichments by the standard culture-based method ISO 6579 [4]. There was 100% agreement between the results obtained by the two methods.

Kumar et al. [20] devised a multiplex PCR method for detection of *S. typhi*, based on amplification of specific regions of the *invA*, *prt*, *fliC-d*, and *viaB* genes. An IAC, which coamplified with *prt* primers, was also included in the assay. They proposed that a multiplex format would mediate more reliable detection than uniplex PCR when analyzing food and environmental samples, where a range of bacterial types would be present. Detection of PCR products was performed conventionally by gel electrophoresis. 13 *Salmonella* and 16 non-*Salmonella* strains were used to evaluate the selectivity of the PCR assay. All *Salmonella* (*invA* PCR positive) and non-*Salmonella* strains (*invA* PCR negative) were identified correctly. In addition, only the *S. typhi* strains were PCR positive for the four genes tested (*invA*, *prt*, *fliC-d*, and *viaB*). The detection probability of the assay was found to be 20% at a concentration of 10<sup>3</sup> CFU/mL (50 CFU/reaction) and 100% at a concentration of 10<sup>4</sup> CFU/mL (500 CFU/reaction) when pure cultures were used. To evaluate the capacity of the system for the detection of *S. typhi* in food samples, 10 mL samples of milk were artificially contaminated with cultures of *S. typhi* containing various cell concentrations (10<sup>3</sup>–10<sup>-1</sup> CFU/mL). After 18 h enrichment in BPW (dilution 1:10) at 37°C, a 1 mL aliquot was taken for nucleic acid extraction by boiling. Detection of artificially contaminating *S. typhi* was achieved down to 480 CFU/10 mL original milk sample.

### 32.4.2 *Listeria monocytogenes*

D'Agostino et al. [13] developed a conventional PCR assay for *L. monocytogenes*, containing an IAC. The assay is based on amplification of *prfA* gene sequences [37]. It has a 99% detection probability of 7 cells per reaction. When tested against 38 *L. monocytogenes* strains and 52 non-target strains, the PCR assay was 100% inclusive (positive signal from target) and 100% exclusive

(no positive signal from nontarget). The assay was incorporated within a method for the detection of *L. monocytogenes* in raw milk. The method comprises 24 h enrichment in half-Fraser broth followed by 16 h enrichment in a medium, which can be added directly into the PCR. The performance characteristics of this PCR-based method were evaluated in a collaborative trial involving 13 European laboratories. A specificity value, or percentage correct identification of uncontaminated milk samples, of 81.8% was obtained. Sensitivity or correct identification of milk samples inoculated with between 20 and 200 *L. monocytogenes* cells per 25 mL was 89.4%. This method has the advantage of being fully compatible with the standard procedure for analysis of foodstuffs for *L. monocytogenes*, ISO 11290-1 [41], and is most suitable as a screening method. PCR-positive results can be confirmed by completing the standard procedure on the same sample, by following the steps after half-Fraser enrichment.

The *prfA* primer set was subsequently used in RTi-PCR format by Rossmanith et al. [34]. They tested the selectivity of the new method using 100 *L. monocytogenes* isolates, 30 non-*monocytogenes* *Listeria* spp. isolates, and 29 non-*Listeria* isolates, and they obtained that the method was 100% selective. The theoretical detection limit was 1 genome equivalent per PCR reaction and the practical detection limit was about 5 genome equivalents per PCR. The RTi-assay was incorporated in a method involving the ISO 11290-1 [41] primary and secondary enrichments followed by a DNA extraction step, to analyze samples of cheese and milk. It was able to detect down to 7.5 CFU/25 mL of artificially contaminated raw milk, and 1 CFU/15 g of artificially contaminated green-veined cheese.

O'Grady et al. [27] developed a RTi-PCR method for the detection of *L. monocytogenes* in naturally and artificially contaminated cheese and milk samples after 30 enrichment steps. Its target was the *srzA* gene encoding for tmRNA, which rescues stalled ribosomes and clears the cell of incomplete polypeptides. The detection strategy was based on FRET hybridization probes using the Lightcycler (Roche) as the RTi-PCR platform. The method was fully specific, with a limit of detection (LOD) of 1–10 genome equivalents. For its application in food analysis, in three independent experiments, 25 g or mL of different dairy products (soft cheese and milk) were independently added to 225 mL of half-Fraser broth (Oxoid, Hampshire, U.K.), and homogenized in a stomacher for 2 min. Subsequently, the samples were incubated at 30°C for 22 h with shaking, and then 100 µL were added to 10 mL Fraser broths, respectively, and incubated at 37°C for 4 h with shaking. Finally, 1.5 mL aliquots of the secondary enrichment cultures were used for the DNA isolation using the Bacterial Genomic DNA purification Kit (Edge BioSystems, Gaithersburg, MD). The PCR method detected *L. monocytogenes* in all artificially contaminated samples, and did not detect any in the control samples. These results were confirmed by culturing the samples.

### 32.4.3 *Enterobacter sakazakii*

Malorny and Wagner [21] developed and validated in-house a TaqMan RTi-PCR for the specific detection of *E. sakazakii*. The target of the RTi-PCR assay was *E. sakazakii*-specific region of the 16S rRNA gene and the platform used was DNA Engine Opticon 2 System (MJ Research). The specificity of the system was evaluated using 27 *E. sakazakii* and 141 non-*E. sakazakii* isolates, which were identified correctly. The RTi-PCR system can detect robustly as little as 10<sup>3</sup> *E. sakazakii* CFU/mL (corresponding to 5 genome equivalent per reaction). The authors did not evaluate the method using actual food samples, but they concluded that the assay could be a practical tool for the detection of *E. sakazakii* in powdered infant formula (PIF) after cultural enrichment.

The International Standard Organisation (ISO) and the International Dairy Federation (IDF) recently jointly adopted a technical specification [9], defining a method for the detection of

*E. sakazakii* in PIF. Derzelle and Dilasser [15] evaluated a RTi-PCR-based assay and an automated nucleic acid extraction method that can be used in combination with the ISO-IDF enrichment steps for the routine examination of naturally contaminated PIF. Infant formula powders from three different commercial brands were inoculated with *E. sakazakii* strains ATCC 29544 or ATCC 51329 at four levels of contamination (1–5, 5–10, 10–20, and 20–200 CFU/25 g) plus negative control. Twenty five grams of PIF were dissolved in 225 mL of BPW and then inoculated with diluted *E. sakazakii* culture. The artificial contaminations were carried out in triplicate, except the blank, which was in duplicate. Samples were analyzed in parallel by the conventional ISO-IDF (TS 22964/RM 210) method and by RTi-PCR after a common cultural enrichment. The DNA region located between the tRNA-glu and 23S rRNA genes was selected as a target for detecting the *E. sakazakii* species. Primers ESFor and ESRevB were demonstrated to amplify a 158 bp fragment in all 35 strains of *E. sakazakii* tested with no cross-reaction with other non-*E. sakazakii* bacterial strains. Exclusivity was performed on a total of 139 non-*E. sakazakii* *Enterobacteriaceae*. Forty-five non-*Enterobacteriaceae* strains were chosen. All 184 non-*E. sakazakii* strains tested were negative by PCR and/or RTi-PCR while a positive IAC signal was always detected. The FRET RTi-PCR was combined with a robust nucleic acid extraction procedure, the MagNA Pure LC automated DNA extraction system. A total of 41 samples were suspected to be naturally contaminated, with *E. sakazakii* including infant formulae and samples from the production environment of infant formulae factories. These were investigated using the ISO cultural method and RTi-PCR in parallel. Twenty-two samples were positive for *E. sakazakii* by the ISO-IDF method and 23 were positive by RTi-PCR, providing more than 97.5% concordance between methods. One sample tested positive by PCR and negative by the culture method and it had a very low amplification value (mean  $C_T$  cycle to threshold value above 35.00). This value, largely higher than those found for the other positive samples (i.e., 19.15–26.82 cycles), indicated a lower *E. sakazakii* cell density in the enriched sample. The detection limit was approximately 1–5 equivalent genome(s) per reaction for the strain ATCC 29544 (18 cells per PCR tube when combined with DNA extraction step), and was approximately 25 copies (180 cells per PCR tube when combined with DNA extraction step) for the phylogenetically more distinct strain ATCC 51329. The enrichment procedures recommended by the ISO-IDF (TS 22964/RM 210) method allowed detection of an initial contamination level of 1 cell per 100 g of PIF.

Krascenicsová and coworkers [19] have recently developed a RTi-5'-nuclease PCR for the specific detection and quantification of *E. sakazakii*. The PCR system targeted a sequence of *E. sakazakii*-specific *palE* gene and the platform used was the PTC-200 thermal cycler coupled to a Chromo 4 continuous fluorescence detector (MJ Research, Waltham, MA). It was 100% selective as determined using 54 *E. sakazakii* and 99 non-*E. sakazakii* strains. The analytical sensitivity was  $4 \times 10^1$  CFU/mL in 90% of the PCR replicates when pure cultures were used. In addition, the results obtained using the RTi-PCR system were highly linear in the range of  $1 \times 10^8$ – $1 \times 10^1$  CFU/mL. Finally, they artificially contaminated powdered infant milk formula with tenfold dilutions of *E. sakazakii*. Subsequently, they followed the two-step enrichment ISO standard [9]. The detection limit was  $1 \times 10^2$  CFU/mL.

#### 32.4.4 *Mycobacterium avium* subsp. *paratuberculosis*

Rodríguez-Lázaro et al. [30] developed a RTi-PCR assay for quantitative detection of *M. avium* subsp. *paratuberculosis*. The assay amplifies sequences from the IS900 insertion element, which is specific for this bacterium. The assay was tested against 18 isolates of *M. avium* subsp. *paratuberculosis*, 17 other mycobacterial strains, and 25 nonmycobacterial strains and was fully selective.

It was capable of detecting <3 genomic DNA copies with 99% probability or alternatively, using cells directly in the reaction, 12 cells can be detected with 99% probability. To allow the detection of *M. avium* subsp. *paratuberculosis* in milk, 20 mL samples were incubated at 37°C for 30 min with 11% Triton X-100 and 1% trypsin, followed by centrifugation at 2000 g for 30 min and subsequent nucleic acid extraction from the pellet. Harnessed to this sample treatment, the assay was able to consistently detect 10<sup>2</sup> *M. avium* subsp. *paratuberculosis* in 20 mL artificially contaminated semiskimmed milk.

Tasara and Stephan [39] developed a light cycler-based RTi-PCR assay that targets the F57 sequence for the detection of *M. avium* subsp. *paratuberculosis*. The system was 100% selective in correctly identifying 10 *M. avium* subsp. *paratuberculosis* and 33 non-*M. avium* subsp. *paratuberculosis* strains. The analytical sensitivity of the system was 100 *M. avium* subsp. *paratuberculosis* cells per ml when 10 mL of milk samples artificially contaminated was used. Finally, they evaluated the method in naturally contaminated milk. Eighty milk samples were collected from a dairy herd with a history of paratuberculosis. Sixteen pooled samples were prepared from the 80 raw milk samples; each 10 mL sample was made up of 2 mL samples from five different cows. Two of the 16 pooled samples were found to be positive for *M. avium* subsp. *paratuberculosis*. Later, the same research team analyzed a total of 100 individual farm raw milk bulk tank samples on three occasions during August and September 2005 [11]. Among the 100 bulk tank milk samples that were tested, three samples (3%) were positive for MAP F57.

Ayele and collaborators [10] did an extensive study of the presence of *M. avium* subsp. *paratuberculosis* in bottles and cartons (244) of commercially pasteurized cow's milk in retail outlets throughout the Czech Republic. Milk samples were brought to the Veterinary Research Institute in Brno, Czech Republic, processed, inoculated onto Herrold's egg yolk slants, and incubated for 32 weeks. Colonies were characterized by standard techniques and confirmed by PCR based on the IS900. *M. avium* subsp. *paratuberculosis* was cultured and confirmed by PCR from 4 of 244 units (1.6%) of commercially pasteurized retail milk.

## 32.5 Future Perspective

There needs to be a focused drive toward taking proven methods from the scientist's laboratory and implementing them in actual use in the analyst's laboratory. However, further developments are needed for an effective implementation of amplification techniques in food microbiology. Among the main issues that must be addressed for the effective adoption of molecular techniques by food analysis laboratories are the development of rational and easy-to-use strategies for sample treatment and greater automation of the whole analytical process.

Although most of the published molecular-based methods for foodborne detection in dairy products possess a very high potential for its application in routine food analysis laboratories and even for being adopted as standard methods, none of them have been implemented effectively in food microbiology so far. This is particularly surprising when the capacity of these technologies for screening and identifying new agents and specific forms found in food environments such as viable but not culturable forms or the high performance for bacterial typing (from a taxonomic point of view and from a capacity for drug resistance). However, there are multifaceted reasons for that: the classical reasons are based on the cost of the equipment and reagents required and the difficulty of finding adequately trained personnel. However, a wider offer for new platforms for RTi-PCR is available each day (from only two or three platforms in the late-1990s to more than 20 available in the market currently), and the ample number of different biotechnology companies offering

DNA polymerase and fluorescent probes. In addition, more than 10 years have passed since the first publication of RTi-PCR in 1996, and now there are many more and better trained analysts who can develop these methods.

Thus, the factors impairing the adoption of these methods principally include the lack of international validation of these methods in comparison with the microbiological standards and the lack of trust of these methods within the food industry. The absolute prerequisite for successful adoption of molecular-based diagnostic methodology is international validation and subsequent standardization [14,16,24]. Most analysts still regard the conventional “gold standard” culture-based methods as the only accepted method. Therefore, any molecular-based method should be shown to work at least as well as the corresponding conventional method, by direct comparison of the analytical performance of each, on identical food samples. There is an international standard guideline for performing this validation [4]. Standard guidelines regarding the use of PCR for the detection of foodborne pathogens have also been established [6–8].

A clear feedback obtained from the food industry is the lack of trust of molecular-based methods. This fact is exacerbated especially if the results are positive, as they need to wait for a classical confirmation. Therefore, the potential advantage of the molecular-based methods is lost in the waiting time. It is obvious that further steps need to be taken to guarantee and reinforce the value of the analytical results obtained using these methods.

Finally, a determined effort to communicate and promote dialog between the researcher and the analyst is necessary, to encourage and mediate adoption of fit-for-purpose methodology. Ideally, this effort requires the establishment of a solid international infrastructure for taking promising PCR-based analytical methods through development and validation and finally delivering them for use. The foundation of this scenario awaits support from international funding agencies.

## References

1. Anonymous. (1993). Statistics. Vocabulary and symbols. Part 1: Probability and general statistical terms (ISO 3534-1:1993). International Organization for Standardization, Geneva, Switzerland.
2. Anonymous. (1994). Accuracy (trueness and precision) of measurement and results (ISO 5725-1:1994). International Organization for Standardization, Geneva, Switzerland.
3. Anonymous. (2003a). Microbiology of food and animal feeding stuffs. Horizontal method for the detection of *Salmonella* (ISO 6579:2003). International Organization for Standardization, Geneva, Switzerland.
4. Anonymous. (2003b). Microbiology of food and animal feeding stuffs—Protocol for the validation of alternative methods (ISO 16140:2003). International Organization for Standardization, Geneva, Switzerland.
5. Anonymous. (2005a). Microbiology of food and animal feeding stuffs—Polymerase chain reaction (PCR) for the detection of food-borne pathogens—General requirements and definitions (ISO 22174:2005). International Organization for Standardization, Geneva, Switzerland.
6. Anonymous. (2005b). Microbiology of food and animal feeding stuffs—Polymerase chain reaction (PCR) for the detection of food-borne pathogens—Performance testing for thermal cyclers (ISO/TS 20836). International Organization for Standardization, Geneva, Switzerland.
7. Anonymous. (2006a). Microbiology of food and animal feeding stuffs—Polymerase chain reaction (PCR) for the detection of food-borne pathogens—Requirements for sample preparation for qualitative detection (ISO 20837). International Organization for Standardization, Geneva, Switzerland.
8. Anonymous. (2006b). Microbiology of food and animal feeding stuffs—Polymerase chain reaction (PCR) for the detection of food-borne pathogens—Requirements for amplification and detection for qualitative methods (ISO 20838). International Organization for Standardization., Geneva, Switzerland.



9. Anonymous. (2006c). Milk and milk products — Detection of *Enterobacter sakazakii* (ISO/TS 22964:2006). International Organization for Standardization, Geneva, Switzerland.
10. Ayele, W.Y., Svastova, P., Roubal, P., Bartos, M., and Pavlik, I. (2005). *Mycobacterium avium* subspecies *paratuberculosis* cultured from locally and commercially pasteurized cow's milk in the Czech Republic. *Applied and Environmental Microbiology* **71**, 1210–1214.
11. Bosshard, C., Stephan, R., and Tasara, T. (2006). Application of an F57 sequence-based real-time PCR assay for *Mycobacterium paratuberculosis* detection in bulk tank raw milk and slaughtered healthy dairy cows. *Journal of Food Protection* **69**, 1662–1667.
12. Cook, N. (2003). The use of NASBA for the detection of microbial pathogens in food and environmental samples. *Journal of Microbiological Methods* **53**, 165–174.
13. D'Agostino, M., Wagner, M., Vazquez-Boland, J.A., Kuchta, T., Karpiskova, R., Hoorfar, J., Novella, S. et al. (2004). A validated PCR-based method to detect *Listeria monocytogenes* using raw milk as a food model—towards an international standard. *Journal of Food Protection* **67**, 1646–1655.
14. D'Agostino, M. and Rodriguez-Lazaro, D. (2009) Harmonization and validation of methods in food safety – “FOOD-PCR” a case study. In: *Global Issues in Food Safety and Technology* (G. Barbosa-Canovas et al., Eds.), Academic Press, New York, Chapter 13.
15. Derzelle, S. and Dilasser, F. (2006). A robotic DNA purification protocol and real-time PCR for the detection of *Enterobacter sakazakii* in powdered infant formulae. *BMC Microbiology* **6**, 100.
16. Hoorfar, J. and Cook, N. (2003). Critical aspects of standardization of PCR. In: *Methods in Molecular Biology: PCR Detection of Microbial Pathogens* (K. Sachse and J. Frey, Eds.), Humana Press, Totowa, pp. 51–64.
17. Hoorfar, J., Cook, N., Malorny, B., Rådström, P., De Medici, D., Abdulmawjood, A., and Fach, P. (2003). Diagnostic PCR: Making internal amplification control mandatory. *Journal of Clinical Microbiology* **41**, 5835.
18. Hoorfar, J., Malorny, B., Abdulmawjood, A., Cook, N., Wagner, M., and Fach, P. (2004). Practical considerations in design of internal amplification control for diagnostic PCR assays. *Journal of Clinical Microbiology* **42**, 1863–1868.
19. Krascenicová, P., Trnčíková, T., and Kačíková, E. (2008). Detection and quantification of *Enterobacter sakazakii* by real-time 5'-nuclease polymerase chain reaction targeting the *palE* gene. *Food Analytical Methods* **1**, 85–94.
20. Kumar, S., Balakrishna K., and Batra, H.V. (2006). Detection of *Salmonella enterica* serovar Typhi (S. Typhi) by selective amplification of *invA*, *viaB*, *fljC-d* and *prt* genes by polymerase chain reaction in multiplex format. *Letters in Applied Microbiology* **42**, 149–154.
21. Malorny, B. and Wagner, M. (2005). Detection of *Enterobacter sakazakii* strains by real-time PCR. *Journal of Food Protection* **68**, 1623–1627.
22. Malorny, B., Hoorfar, J., Hugas, M., Heuvelink, A., Fach, P., Ellerbroek, L., Bunge, C., Dorn, C., and Helmuth, R. (2003a). Interlaboratory diagnostic accuracy of a *Salmonella* specific PCR-based method. *International Journal of Food Microbiology* **89**, 241–249.
23. Malorny, B., Hoorfar, J., Bunge, C., and Helmuth, R. (2003b). Multicenter validation of the analytical accuracy of *Salmonella* PCR: Towards an international standard. *Applied and Environmental Microbiology* **69**, 290–296.
24. Malorny, B., Tassios, P.T., Rådström, P., Cook, N., Wagner, M., and Hoorfar, J. (2003c). Standardization of diagnostic PCR for the detection of foodborne pathogens. *International Journal of Food Microbiology* **83**, 39–48.
25. Malorny, B., Paccassoni, E., Fach, P., Bunge, C., Martin, A., and Helmuth, R. (2004). Diagnostic real-time PCR for detection of *Salmonella* in food. *Applied and Environmental Microbiology* **70**, 7046–7052.
26. Malorny, B., Mäde, D., Teufel, P., Berghof-Jäger, C., Huber, I., Anderson, A., and Helmuth, R. (2007). Multicenter validation study of two blockcycler- and one capillary-based real-time PCR methods for the detection of *Salmonella* in milk powder. *International Journal of Food Microbiology* **117**, 211–218.

27. O' Grady, J., Sedano-Balbas, S., Maher, M., Smith, Y., and Barry, T. (2008). Rapid real-time detection of *Listeria monocytogenes* in enriched food samples based on the *ssrA* gene, a novel diagnostic target. *Food Microbiology* **25**, 75–84.
28. Paoletti, C. and Wighardt, F. (2002). Definition of pre-validation performance requirements. In: 4th Meeting of the European Network of GMO Laboratories – ENGL, April 29–30, 2002. Joint Research Centre, Ispra, Italy.
29. Perelle, S., Dilasser, F., Malorny, B., Grout, J., Hoorfar, J., and Fach, P. (2004). Comparison of PCR-ELISA and LightCycler real-time PCR assays for detecting *Salmonella* spp. in milk and meat samples. *Molecular and Cellular Probes* **18**, 409–420.
30. Rodríguez-Lázaro, D., D'Agostino, M., Herrewegh, A., Pla, M., Cook, N., and Ikonomopoulos, J. (2005). Real-time PCR-based methods for detection of *Mycobacterium avium* subsp. *paratuberculosis* in water and milk. *International Journal of Food Microbiology* **101**, 93–94.
31. Rodríguez-Lázaro, D., Hernández, M., D'Agostino, M., and Cook, N. (2006). Application of nucleic acid sequence-based amplification (NASBA) for the detection of viable foodborne pathogens: Progress and challenges. *Journal of Rapid Methods and Automation in Microbiology* **14**, 218–236.
32. Rodríguez-Lázaro, D., Lombard, B., Smith, H., Rzezutka, A., D'Agostino, M., Helmuth, R., Schroeter, A. et al. (2007). Trends in analytical methodology in food safety and quality: Monitoring microorganisms and genetically modified organisms. *Trends in Food Science and Technology* **18**, 306–309.
33. Rossen, L., Nøskov, P., Holmstrøm, K., and Rasmussen, O.F. (1992). Inhibition of PCR by components of food samples, microbial diagnostic assays and DNA-extraction solution. *International Journal of Food Microbiology* **17**, 37–45.
34. Rossmannith, P., Krassnig, M., Wagner, M., and Hein, I. (2006). Detection of *Listeria monocytogenes* in food using a combined enrichment/real-time PCR method targeting the *prfA* gene. *Research in Microbiology* **157**, 763–771.
35. Saiki, R.K., Scharf, S., Faloona, F., Mullis, K.B., Horn, G.T., Erlich, H.A., and Arnheim N. (1985). Enzymatic amplification of beta-globin genomic sequences and restriction site analysis for diagnosis of sickle cell anemia. *Science* **230**, 1350–1354.
36. Saiki, R.K., Gelfand, D.H., Stoffel, S., Scharf, S.J., Higuchi, R., Horn, G.T., Mullis, K.B., and Erlich, H.A. (1988). Primer-directed enzymatic amplification of DNA with a thermostable DNA polymerase. *Science* **239**, 487–491.
37. Simon, M.C., Gray, D.I., and Cook, N. (1996) DNA extraction and PCR methods for the detection of *Listeria monocytogenes* in cold-smoked salmon. *Applied and Environmental Microbiology* **62**, 822–824.
38. Skoog, D.A. and Leary, J.J. (1992). *Principles of Instrumental Analysis*, Saunders College Publishing, London, U.K.
39. Tasara, T. and Stephan, R. (2005). Development of an F57 sequence-based real-time PCR assay for detection of *Mycobacterium avium* subsp. *paratuberculosis* in milk. *Applied and Environmental Microbiology* **71**, 5957–5968.
40. Thompson, M., Ellison, S.L.R., and Wood, R. (2002), Harmonised guidelines for single-laboratory validation of methods of analysis (IUAPC Technical Report). *Pure and Applied Chemistry* **74**, 835–855.
41. Anonymous. (1997). Microbiology of food and animal feeding stuffs. Horizontal method for the detection and enumeration of *Listeria monocytogenes*. Detection method (ISO 11290-1:1997). International Organization for Standardization, Geneva, Switzerland.



## Chapter 33

---

# Mycotoxins and Toxins

---

Carla Soler, José Miguel Soriano, and Jordi Mañes

### CONTENTS

33.1	Mycotoxins in Dairy Food.....	690
33.1.1	Introduction .....	690
33.1.2	Mycotoxin Analysis .....	690
33.1.2.1	Analytical Quality Assurance.....	690
33.1.2.2	Laboratory Precautions.....	693
33.1.2.3	Sample Preparation.....	693
33.1.2.4	Extraction Procedures .....	693
33.1.2.5	Cleanup Methods.....	694
33.1.2.6	Screening Tests .....	694
33.1.2.7	Quantitative Methods .....	695
33.1.2.8	Detection Systems .....	695
33.2	Toxins in Dairy Food.....	704
33.2.1	Introduction .....	704
33.2.1.1	Principal Bacterial Toxins in Dairy Products.....	704
33.2.2	Analysis of Bacterial Toxins in Dairy Foods.....	708
33.2.2.1	Biological Assays.....	708
33.2.2.2	Immunological Tests .....	708
33.2.2.3	Phenotypic Assays .....	709
33.2.2.4	Biologic–Immunologic–Phenotypic Combination Studies .....	710
33.3	Future Trends .....	711
	References .....	712

## 33.1 Mycotoxins in Dairy Food

### 33.1.1 Introduction

Mycotoxins are products, together with antibiotics, of secondary metabolism of molds, with a molecular weight ranging from ca. 200 to 500 Da that cause undesirable effects, called mycotoxicoses, when animals or humans are exposed to them [1]. Many species of fungi produce mycotoxins in feedstuffs, either preharvest or postharvest, during storage, transport, processing, or feeding. Contamination of feeds with mycotoxins results in significant economic losses in animal husbandry, as well as in undesirable trade barriers [2]. Three sources of mycotoxins are identified in ruminant diets: (i) the contamination of energy-rich concentrates (cereal grains, corn gluten, etc.) with aflatoxins, ochratoxins, ergot alkaloids, and trichothecenes [3,4], (ii) exposition to different classes of mycotoxins (lolitrem–paxilline group, ergovaline, and other ergot alkaloids) that occur in forages [5], and (iii) the consumption of preserved feeding stuffs, such as silage, hay, and straw [6,7]. Kiessling et al. [8] observed that ruminant animals develop mycotoxicoses less frequently, as the rumen flora acts as a first line of defense against mycotoxins. However, various mycotoxins pass the blood–milk barrier or are converted into metabolites that retain their biological activity, and are till date very important because they might impair the milk quality and the use of milk for dairy products such as yoghurt and cheese [9–12]. Other mycotoxins analyzed in dairy and dairy products are zearalenone (ZEN),  $\alpha$ -zearalenol ( $\alpha$ -ZEL),  $\beta$ -zearalenol ( $\beta$ -ZEL),  $\alpha$ -zearalanol ( $\alpha$ -ZAL),  $\beta$ -zearalanol ( $\beta$ -ZAL), fumonisin B1 (FB1) and B2 (FB2), T-2 toxin and HT-2 toxin, T-2 triol, diacetoxyscirpenol (DAS), 15-monoacetoxyscirpenol (MAS), deoxynivalenol (DON), 3-acetyldeoxynivalenol (3-AcDON), 15-acetyldeoxynivalenol (15-AcDON), deepoxy-deoxynivalenol (DOM-1), cyclopiazonic acid, fusarenon-X (FUS-X), nivalenol (NIV), neosolaniol (NEO), ergovaline, and slaframine (alkaloidal compound produced by *Rhizoctonia leguminicola*) [16–21]. Figure 33.1 presents the chemical structures of several mycotoxins analyzed in dairy and dairy products. However, the number of studies about the mycotoxins in these matrices is limited than those with other foods. Figure 33.2 shows the percentages of articles cited from 1997 to 2007 related to mycotoxins in dairy and dairy products, and those obtained from the ISI Web of Science, mainly on aflatoxin M1 (AFM1) and ochratoxin A (OTA). AFM1 is a hydroxylated derivative of aflatoxin B1 (AFB1), which occurs in the milk of lactating animals. Several authors [13–15] reflected that the percentage range (1%–3%) of the AFB1 initially present in the animal feedstuff appearing as AFM1 in milk is not real, owing to the day-to-day variations among the animals and milking processes. Ochratoxins is a group of mycotoxins produced by some species of *Aspergillus* and *Penicillium*, and OTA is the most important toxin of this family. OTA is metabolized by rumen microorganisms into a less toxic metabolite called ochratoxin  $\alpha$  (OT $\alpha$ ) that is excreted in milk. The principal difference between OT $\alpha$  and other ochratoxins is the lack of phenylalanine group in the chemical structure.

### 33.1.2 Mycotoxin Analysis

#### 33.1.2.1 Analytical Quality Assurance

Basically, two components are used in the analytical quality assurance [34]. First, the use of certified reference materials (CRM) whenever possible, owing to the fact that they are stable and homogeneous products containing certified amounts of mycotoxin(s) of interest [35]. They should be routinely used as much as possible. These CRMs have developed with the coordination of the Standards, Measurements and Testing Programme (also called European Union's Community Bureau of Reference in the past) [36,37]. The characteristics of CRM for mycotoxins are shown in Table 33.1.

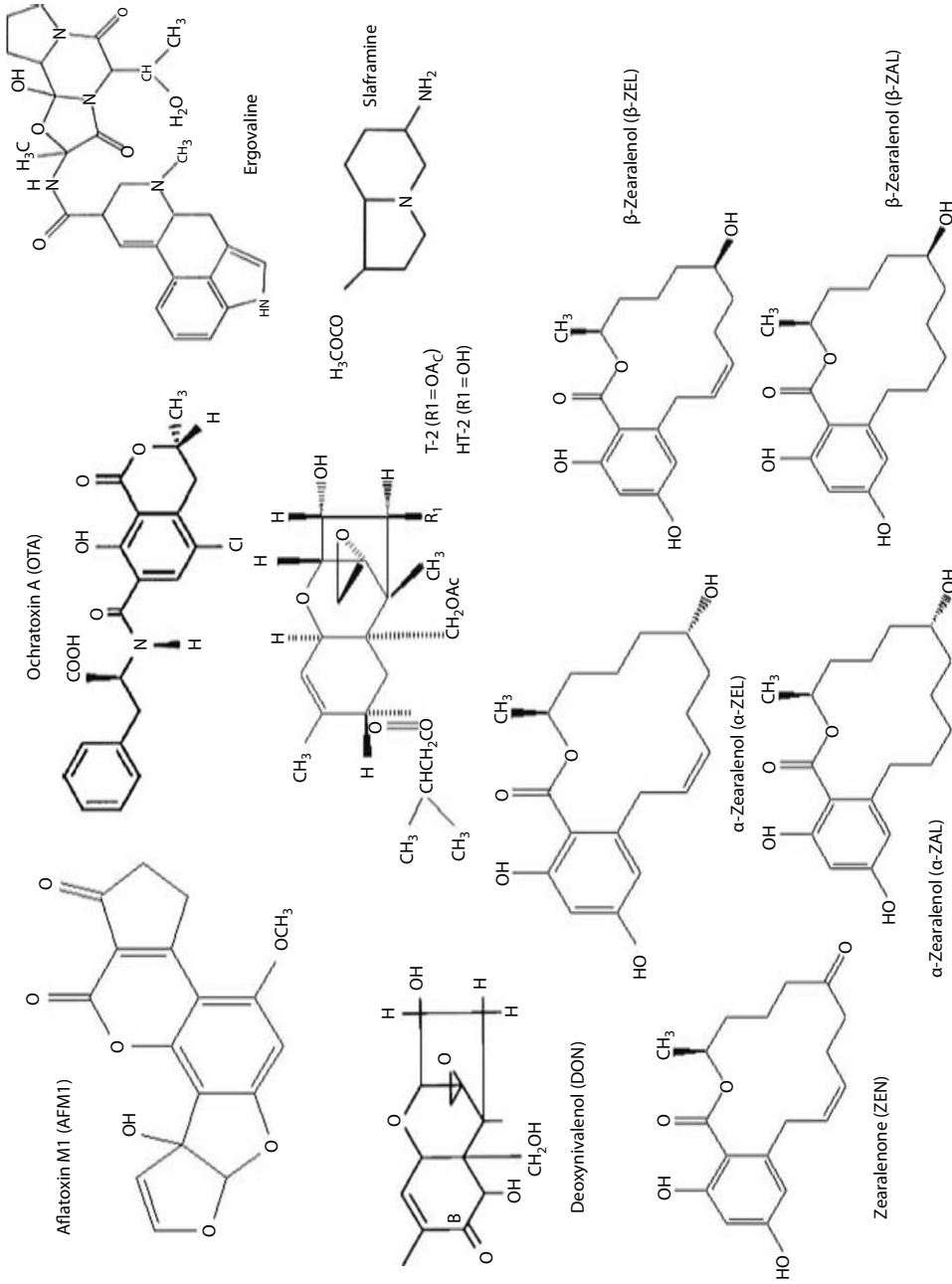
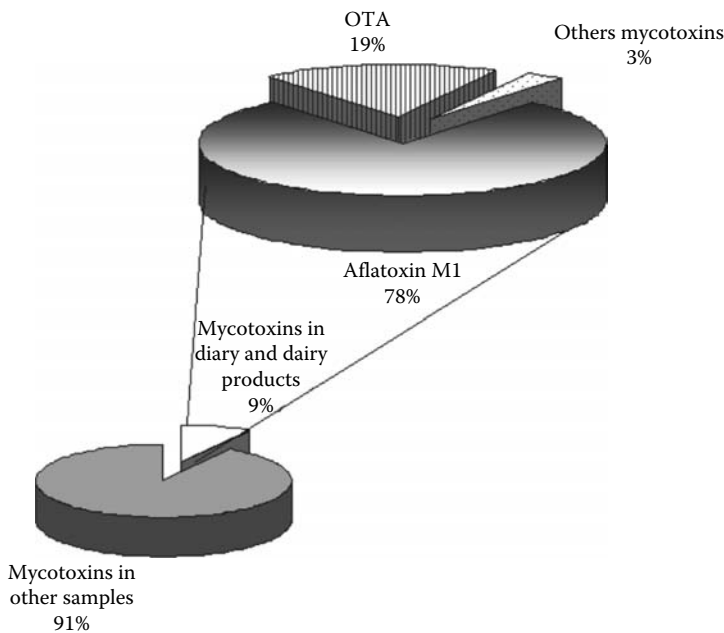


Figure 33.1 Chemical structures of several mycotoxins analyzed in dairy and dairy products.



**Figure 33.2** Percentages of articles published in the last 10 years about mycotoxins in dairy and dairy products. (Obtained from the ISI Web of Science.)

**Table 33.1** Certified Dairy and Dairy Products Reference Materials for AFM1

Number	Matrix	Certified Value ( $\mu\text{g}/\text{kg}$ )	Uncertainty ( $\mu\text{g}/\text{kg}$ )
CRM 282	Full-cream milk powder	<0.05	Not reported
CRM 283	Full-cream milk powder	0.09	+0.04; -0.02
CRM 285	Full-cream milk powder	0.76	$\pm 0.05$
RM	Chloroform	Information value: 9.93	Not reported

The second component in the analytical quality assurance is proficiency testing, a key issue in achieving external quality control for national reference laboratories conducted by the European Union's Community Reference Laboratory for Milk and Milk Products in France in 1996 [38] and 1998 [39]. Conclusion of the organizers demonstrated that the network of national reference laboratories had shown good analytical competency for the determination of AFM1 in milk, including the very low concentrations of this mycotoxin in the distributed samples. Furthermore, other body involved in proficiency testing is Food Analysis Proficiency Assessment Scheme (FAPAS), in the United Kingdom Ministry of Agriculture Fisheries and Food (UK MAFF).

### 33.1.2.2 Laboratory Precautions

There are several safety measures in the laboratory which include precautions in handling mycotoxins and in the decontamination and destruction of laboratory wastes. At the outset, mycotoxins are extremely toxic chemicals, while crystalline standards are highly electrostatic and can disperse in the work area. The handling of standards, either in powder or concentrated form and reference standard working solutions, must be carried out with extreme care under a hood, and the face of the operator should be protected with an appropriate mask and the operator's hands should be protected with latex gloves (and not vinyl gloves). Risk assessment should be carried out before any starting any work, as continuous exposure even to low concentrations of mycotoxins presents a potential chronic hazard to the analysts who may be working with these mycotoxins for many years, because they may be carcinogenic, genotoxic, or immunosuppressant. Working solutions should aim for zero-operator exposure. Furthermore, the glassware must be scrupulously cleaned by immersion into a powerful oxidant (bleach or sulfochromic mixture). A flask with 10%–20% aqueous solution of sodium hypochlorite must be kept near the bench in case of emergency, during the analysis. Also, it is recommended that the work areas be decontaminated overnight with sodium hypochlorite at the end of the workday and the surfaces should be thoroughly washed and checked for neutrality before starting a new analysis [34].

### 33.1.2.3 Sample Preparation

Liquid samples such as milk are usually more homogeneous; however, when these are cloudy, mycotoxins can be unequally distributed between the liquid and solid phases. In solid food commodities such as cheese, mycotoxins may be distributed in a very heterogeneous manner. According to the Directive and a Decision of the Commission of the European Union [40,41], a minimum of 9.5 kg should be collected from a batch of milk mixed by manual or mechanical means and should be composed of at least five increments, and the batch is accepted only if the concentration of AFM1 does not exceed the permitted limit. If the analysis is not carried out immediately, then the samples must be stored at 4°C–8°C, and never at frozen temperature, owing to the possibility, for example, of aflatoxins to bind to the milk proteins and other components, which could affect the mycotoxin recovery [28].

### 33.1.2.4 Extraction Procedures

The purpose of extraction is to remove as much of the mycotoxin from the dairy matrix as possible, into a solvent suitable for subsequent cleanup and determination. For AFM1 and OTA, the use of centrifugation and filtration is a key in the extraction to obtain defatted milk, while for other matrices, other options are used to extract these compounds. González-Osnaya et al. [31] proposed a methodology for the extraction of OTA in milk, which is short and easy to perform, based on the mix of 2 mL of milk and 2 mL of methanol. This helps the aggregation of the casein micelles by dehydration, and hence, structures of average sizes as large as 9 μm are precipitated [42,43]. With the separation of these particles, by filtration and/or centrifugation, the upper cream layers are discarded and the cleaner extracts are obtained. Seeling et al. [17] proposed a simple extraction for nine mycotoxins with a mixture of water and ethanol, and Sorensen et al. [19] applied a ternary mixture (sulfuric acid 18%, hexane, and acetonitrile) for the extraction of 18 mycotoxins. As dairy products are a more complex matrix, the addition of diatomaceous earth is required for the extraction of AFM1 [28].



### 33.1.2.5 Cleanup Methods

The cleanup step in the analysis of mycotoxins in dairy foods consists of one of the two following approaches: (a) the use of solid-phase extraction (SPE) columns or (b) the use of immunoaffinity columns (IACs).

Few articles have been published regarding SPE, reporting that the technique is useful to regenerate the cartridge for further analysis and is cheaper than IACs. However, the disadvantages of SPE are that it obtains low repeatability within a single batch and/or low reproducibility of different batches. For milk, a C18 Sep-Pak cartridge has been used by Imerman and Stahr [21] as well as Fremy and Chu [44] for the determination of slaframine and AFM1, respectively, and a silica gel cartridge Sep-Pak® has been used by Prasongsidh et al. [18], for the determination of cyclopiazonic acid. Durix et al. [20] used 100 mg of Ergosil® on a small column with the chloroform extract, the impurities were removed by washing the column with 3 mL of acetone–chloroform (75:25), and the ergovaline was eluted with 1.5 mL of methanol.

The use of IACs help to considerably increase the reliability of the results owing to its high selectivity, the possibility of analyzing more than one sample simultaneously, and reduce the time of analysis. The IACs must be stored between 4°C and 8°C, but brought to room temperature before analysis. The extract is purified with IAC-containing antibodies specific to mycotoxins and previously conditioned with phosphate-buffered saline (PBS). Subsequently, the IAC is washed with water primarily to remove the impurities and mycotoxin is separated from the antibody by passing methanol for OTA, and methanol, acetonitrile, or a mixture of both for AFM1 in dairy and dairy products. For milk, the IACs are used for AFM1 and OTA. In 1987, Mortimer et al. [45] applied IACs for the first time in the cleanup procedure of AFM1 in milk. Since then, it has been the election procedure for practically all laboratories.

### 33.1.2.6 Screening Tests

Five methods of screening tests have been used to analyze the presence of AFM1 in milk: thin-layer chromatography (TLC), radioimmunoassay (RIA), enzyme-linked immunoabsorbent assay (ELISA), electronic nose, and Charm Rapid One Step Assay (ROSA).

Screening methods based on TLC are available and applied for AFM1 in milk [45–48], but they are used in only a few laboratories, as they do not provide an adequate limit of quantification (LOQ). In 2004 [26], the Food and Agriculture Organization (FAO), as the collaborative center, the International Dairy Federation (IDF; Committee on Organic Contaminants E501), the International Union of Pure and Applied Chemistry (IUPAC; Commission on the Chemistry of Food), and the International Atomic Energy Agency (IAEA), with 14 laboratories representing 11 countries participating in the trial, validated a method combining immunoaffinity cleanup to TLC for the determination of AFM1 in milk. This study reflected a variation of the recovery rate, from 32% to 120%, and these were used to correct the data. This wide variation of the recovery rate suggested two crucial steps in the protocol, such as matrix sample reconstitution and extract evaporation. Nowadays, this method is the standard ISO/DIS 14674-IDF 190 entitled “Milk and milk powder-determination of aflatoxin M1 content-clean-up by immunoaffinity chromatography and determination by TLC” [49].

Saitanu [50] and Offiah as well as Adesiyun [51] used the RIAS technique for the routine investigations of AFM1 in milk from Thailand as well as Trinidad and Tobago, respectively.

ELISA has been more often used when compared with the other immunochemical procedures [52]. A review of the ELISA as a method for the detection of mycotoxins in dairy and dairy

products indicated that, till date, it has been applied mainly for AFM1 (Ridascreen®) [53,54], and Fast AFM1, produced by R-Biopharm (Germany), has been very frequently used in several studies [55–57]. Kim et al. [58] used a direct competitive ELISA for the determination of AFM1 in pasteurized milk, infant formula, powdered milk, and yoghurt. According to the kit supplier, the sample aliquot must be centrifuged and a little quantity of the supernatant is used in the Microplate Reader. The detection limit of this test is 245 ng/L [55].

Benedetti et al. [59] and Barbiroli et al. [53] applied a commercial electronic nose as an innovative screening methodology for simple and rapid detection of AFM1 in a large number of ovine and caprine milk samples, and confirmed that the analysis of the electronic nose data offered substantial assistance in creating clusters that allow recognition of samples at different contamination levels.

The use of ROSA Safe-Level AFM1 quantitative lateral-flow method has been validated in an interlaboratory study of 21 public health, state agriculture, and industry laboratories in the United States testing raw commingled bovine milk. The average intralaboratory repeatability was 11% and the average interlaboratory reproducibility was 13% for the fortified sample pairs. Liquid chromatography (LC) analysis of the study samples by five laboratories showed 38% false negatives with 500 and 550 ppt samples [60].

### 33.1.2.7 Quantitative Methods

Methods used for mycotoxin in dairy products are mainly based on LC with octadecyl as the stationary phase. Some mycotoxins in milk, such as cyclopiazonic acid [18] and trichothecenes [17] are analyzed by capillary electrophoresis (CE) and gas chromatography (GC), respectively (Table 33.2). The CE with diode array detector (DAD) has been used for the determination of cyclopiazonic acid in milk (absorbance at 220 nm wavelength) [18]. On the other hand, GC is used for trichothecenes, because they have nonfluorescent and weak UV–vis absorption properties that require derivatization to facilitate detection, and makes the determination of trace levels unreliable. For OTA and ergovaline, the method applied is LC followed by fluorescence detection (FLD) and mass spectrometry detection (MSD). For official controls, the analytical methods for determining AFM1 in milk should be able to detect traces of this mycotoxin, i.e., at the ng/kg level. This performance criterion is satisfied by the use of an immunoaffinity cleanup step, followed by LC and fluorimetric detection [61], standardized by the IDF (IDF 171:1995) [62] and ISO and CEN (EN ISO 14501:1998) [63], and validated by Dragacci et al. (2001) with minor modifications as the AOAC official method 2000.08 [38].

### 33.1.2.8 Detection Systems

To date, the use of a fluorescence detector is mainly applied for AFM1 and OTA owing to the fact that it is a more sensitive and selective technique. The operating conditions range from an excitation wavelength of 360–365 and 274–334 nm, respectively, and an emission wavelength of 430–440 and 440–464 nm, respectively (Table 33.3). The typical chromatograms of AFM1 by LC–FLD are shown in Figure 33.3. Some authors carried out the formation of the mycotoxin derivative to confirm AFM1 and OTA in several matrices including dairy and dairy products. The AFM1 in positive samples has been confirmed by the formation of the AFM1 hemiacetal derivative (AFM2a), as reported by Takeda [64]. This method is carried out as follows: 50 µL of the sample eluate is evaporated to dryness at 40°C under a gentle stream of nitrogen. Subsequently,

Table 33.2 Analysis of Mycotoxins in Milk

Mycotoxin	Extraction Technique	Cleanup Technique	Separation	Detection	Recovery (%)	LD (ng/L)	Reference
AFM1	Centrifugation to obtain defatted milk	IAC	LC	FLD	n.r.	n.r.	[22]
			C <sub>18</sub> -RP Select/B (250 × 4.6 mm, 5 μm), H <sub>2</sub> O/CH <sub>3</sub> CN/CH <sub>3</sub> OH (65:15:20) at 1 mL/min	λ <sub>exc</sub> 360 nm λ <sub>em</sub> 430 nm			
AFM1	Centrifugation to obtain defatted milk and filtration (Whatman No. 4)	IAC (Aflaprep) eluted with CH <sub>3</sub> CN/CH <sub>3</sub> OH (3/2), followed by H <sub>2</sub> O	LC	FLD	90.7–113.5	3	[23]
			Phenomenex Prodigy C <sub>18</sub> (250 × 4.6 mm, 3 μm), H <sub>2</sub> O/CH <sub>3</sub> CN/CH <sub>3</sub> OH (50:30:20) at 0.8 mL/min	λ <sub>exc</sub> 360 nm λ <sub>em</sub> 430 nm			
AFM1	Centrifugation with NaCl to obtain defatted milk	IAC (AflaM1) eluted with CH <sub>3</sub> OH	LC	FLD	68.3–90.1	250	[24]
			Bio-Sil C <sub>18</sub> (150 × 4.6 mm, 3 μm), CH <sub>3</sub> CN/H <sub>2</sub> O/CH <sub>3</sub> OH (25:50:25) at 1 mL/min	λ <sub>exc</sub> 360 nm λ <sub>em</sub> 440 nm			
AFM1	Centrifugation to obtain defatted milk and filter (Whatman No. 4)	IAC (AflaM1) eluted with CH <sub>3</sub> OH	LC	FLD	—	—	[25]

				Zorbax SB C <sub>18</sub> (150 × 4.6 mm, 3 μm), CH <sub>3</sub> CN/H <sub>2</sub> O/CH <sub>3</sub> COOH (25:75:1) at 1 mL/min			λ <sub>exc</sub> 365 nm λ <sub>em</sub> 435 nm		
AFM1	Centrifugation to obtain defatted milk and filter (Whatman No. 4)	IAC (AflaPrep) eluted with CH <sub>3</sub> CN/CH <sub>3</sub> OH (3/2) and CH <sub>3</sub> OH	—	TLC	IAC (AflaPrep) eluted with CH <sub>3</sub> CN/CH <sub>3</sub> OH (3/2) and CH <sub>3</sub> OH	—	UV 365 nm	32–120	[26]
AFM1	—	—	—	TLC	—	—	The presence was confirmed by derivative formation on TLC plates (hexane–trifluoroacetic acid) (4:1)	84.6–88.0	[27]
AFM1	—	IAC (AflaPrep) eluted with CH <sub>3</sub> OH	—	LC	IAC (AflaPrep) eluted with CH <sub>3</sub> OH	—	FLD	98.5	[28]
				C <sub>18</sub> (250 × 4.6 mm), CH <sub>3</sub> OH/CH <sub>3</sub> CN/H <sub>2</sub> O (20:20:60) at 0.8 mL/min			λ <sub>exc</sub> 366 nm λ <sub>em</sub> 440 nm	56	
AFM1	—	—	—	LC	—	—	FLD	68–81	[29]
				Column TSK-GEL® C <sub>18</sub> (250 × 4.6 mm, 3 μm), CH <sub>3</sub> CN/CH <sub>3</sub> OH/H <sub>2</sub> O (20:20:60) at 1 mL/min			λ <sub>exc</sub> 360 nm λ <sub>em</sub> 440 nm	50 (LOQ)	

(continued)

Table 33.2 (continued) Analysis of Mycotoxins in Milk

Mycotoxin	Extraction Technique	Cleanup Technique	Separation	Detection	Recovery (%)	LD (ng/L)	Reference
AFM1	Shaken with sulfuric acid 18% (v/v) (pH 2.0), hexane, and CH <sub>3</sub> CN, removed the organic layer	For nonbound mycotoxins, Oasis, eluted with CH <sub>3</sub> OH	LC	MS	76–108	20–150	[19]
OTA							
ZEN							
α-ZEL, β-ZEL							
α-ZAL, β-ZAL							
FB1, FB2							
T-2 toxin							
HT-2 toxin							
T-2 triol							
DAS							
MAS							
DON							
3-AcDON	Luna C <sub>18</sub> (150 × 4.6 mm, 5 μm) for ESI in NI mode, H <sub>2</sub> O, and CH <sub>3</sub> OH at 100 μL/min	Single quadrupole using ESI in PI mode (T-2 toxin, HT-2 toxin, T-2 triol, DAS, MAS, FB1, FB2, AFM1) and in NI mode (DON, DOM-1, 3-AcDON, 15-AcDON, OTA, ZEN, α-ZEL, β-ZEL, α-ZAL β-ZAL)					
15-AcDON							
DOM-1							

Cyclopiiazonic acid	Alkalinization with $\text{CH}_3\text{OH}$ – $\text{NaHCO}_3$ , acidified with $\text{HCl}$ , extraction with $\text{CHCl}_3$	Silica gel cartridge Sep-Pak® and eluted with $\text{CHCl}_3$ – $\text{CH}_3\text{OH}$	CE bare fused silica capillary-extended light path (50 $\mu\text{m}$ i.d. $\times$ 64.5 cm and 150 $\mu\text{m}$ i.d. bubble, 60 cm effective length and alignment interface)	DAD 220 nm	–	–	[18]
DON	$\text{H}_2\text{O}/\text{CH}_3\text{CH}_2\text{OH}$ (90/10)	ChemElut and Mycosep columns	GC	MS	91 (DON)	0.1 <sup>a</sup> (DON)	[17]
FUS-X					96 (FUS-X)	0.16 <sup>a</sup> (FUS-X)	
NIV					44(NIV)	0.25 <sup>a</sup> (NIV)	
3-AcDON					104 (3-AcDON)	0.22 <sup>a</sup> (3-AcDON)	
15-AcDON					97 (15-AcDON)	0.18 <sup>a</sup> (15-AcDON)	
DAS					104 (DAS)	0.30 <sup>a</sup> (DAS)	
NEO					109 (NEO)	0.33 <sup>a</sup> (NEO)	
HT2					106 (HT2)	0.22 <sup>a</sup> (HT2)	
T2					111 (T2)	0.16 <sup>a</sup> (T2)	

(continued)

Table 33.2 (continued) Analysis of Mycotoxins in Milk

Mycotoxin	Extraction Technique	Cleanup Technique	Separation	Detection	Recovery (%)	LD (ng/L)	Reference
Ergovaline	Deproteinization with acetone. Centrifuged. Acetone evaporated and aqueous residue adjusted to pH 9 and extracted with $\text{CHCl}_3$	100 mg Ergosil <sup>®</sup> , eluted with $\text{CH}_3\text{OH}$	LC Zorbax $\text{C}_{18}$ (150 × 4.6 mm, 3.5 $\mu\text{m}$ ), $\text{CH}_3\text{CN}-(\text{NH}_4)_2\text{CO}_3$ (2 mM) (36.5:63.5) at 1 mL/min	FLD	99.8	200	[20]
OTA	Shaken $\text{H}_3\text{PO}_4$ -NaCl solution and $\text{CHCl}_3$ , separated the organic layer, adjusted to pH 7.6 and separated the aqueous layer	IAC <sup>®</sup> , eluted with methanol	LC Nucleodur $\text{C}_{18}$ (125 × 4.6 mm, 5 $\mu\text{m}$ ), 10 mL/L of $\text{CH}_3\text{COOH}:\text{CH}_3\text{OH}$ at 1 mL/min	FLD $\lambda_{\text{exc}}$ 274 nm $\lambda_{\text{em}}$ 440 nm	89.4 (OTA)	5 (LOQ)	[16]
OTB					115 (OTB)		
OT $\alpha$					19.8 (OT $\alpha$ )		
OTA	Centrifugation to obtain defatted milk	OchraTest, IAC <sup>®</sup> , eluted with $\text{CH}_3\text{OH}$	LC Symmetry $\text{C}_{18}$ (150 × 4.6 mm, 3.5 $\mu\text{m}$ ), $\text{CH}_3\text{CN}:\text{H}_2\text{O}:\text{CH}_3\text{COOH}$ (55:45:0.5) at 0.6 mL/min	FLD $\lambda_{\text{exc}}$ 333 nm $\lambda_{\text{em}}$ 460 nm	34–47	—	[30]

OTA	Centrifugation to obtain defatted milk, diluted with water solution containing NaCl and NaHCO <sub>3</sub>	OchraTest IAC <sup>®</sup> , eluted with CH <sub>3</sub> OH	LC Symmetry C <sub>18</sub> (150 × 4.6 mm, 3.5 μm), CH <sub>3</sub> CN:H <sub>2</sub> O:CH <sub>3</sub> COOH (55:45:0.5) at 0.6 mL/min	FLD		75.6	—	[30]
				λ <sub>exc</sub> 333 nm	λ <sub>em</sub> 460 nm			
OTA	Centrifugation to obtain defatted milk, diluted with PEG 8000 (1%) and NaHCO <sub>3</sub> (2%) in water	OchraTest IAC <sup>®</sup> , eluted with CH <sub>3</sub> OH	LC Symmetry C <sub>18</sub> (150 × 4.6 mm, 3.5 μm), CH <sub>3</sub> CN:H <sub>2</sub> O:CH <sub>3</sub> COOH (55:45:0.5) at 0.6 mL/min	FLD		62.3	—	[30]
				λ <sub>exc</sub> 333 nm	λ <sub>em</sub> 460 nm			
OTA	Centrifugation to obtain defatted milk	OchraPrep IAC <sup>®</sup> , eluted with CH <sub>3</sub> OH	LC Symmetry C <sub>18</sub> (150 × 4.6 mm, 3.5 μm), CH <sub>3</sub> CN:H <sub>2</sub> O:CH <sub>3</sub> COOH (55:45:0.5) at 0.6 mL/min	FLD		89.8% (skimmed milk) 71.1% (whole milk)	0.5	[30]
				λ <sub>exc</sub> 333 nm	λ <sub>em</sub> 460 nm			
OTA	Shaken with CH <sub>3</sub> OH and filter a nylon acrodisk (0.45 μm)	—	LC Phenomenex C <sub>18</sub> (150 × 4.6 mm, 5 μm), CH <sub>3</sub> CN:H <sub>2</sub> O:CH <sub>3</sub> COOH (50:49:1) at 0.4 mL/min	FLD		93	10	[31]
				λ <sub>exc</sub> 334 nm	λ <sub>em</sub> 464 nm			

(continued)



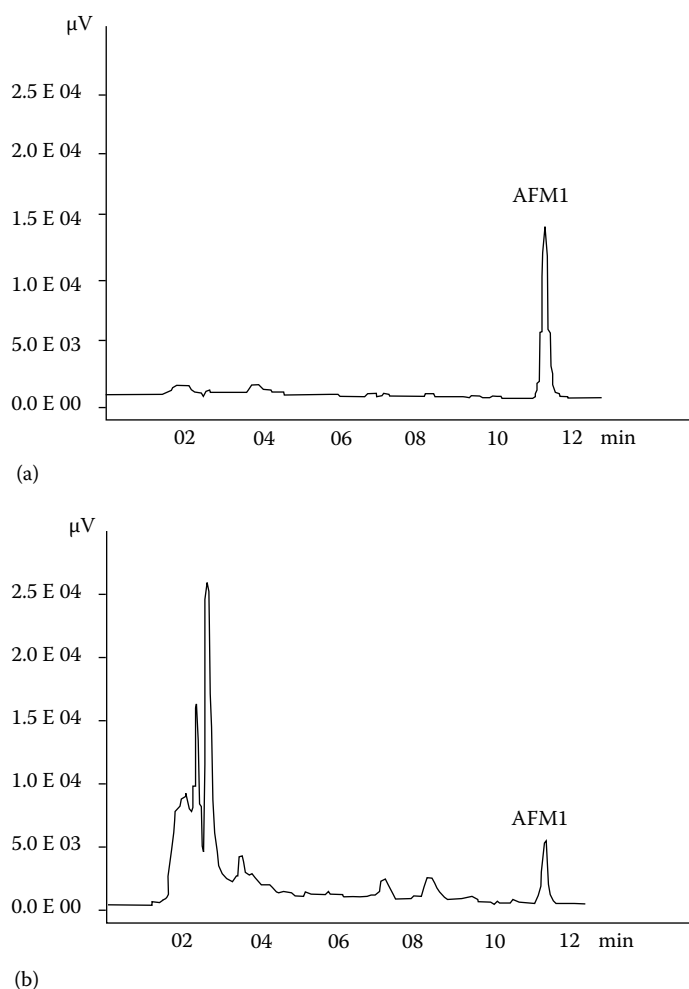
Table 33.2 (continued) Analysis of Mycotoxins in Milk

Mycotoxin	Extraction Technique	Cleanup Technique	Separation	Detection	Recovery (%)	LD (ng/L)	Reference
Slaframine	C <sub>18</sub> cartridge. After passing the sample, cleaned with water and eluted with CH <sub>3</sub> OH:H <sub>2</sub> O (75:25). Re-extracted with	—	LC	FLD	91	n.r.	[21]
	H <sub>2</sub> O NaCl + 10% Na <sub>2</sub> CO <sub>3</sub> (pH 10) +CH <sub>2</sub> Cl <sub>2</sub>						
			Hamilton PRP-1 (250 × 4.1 mm, 10 μm), CH <sub>3</sub> CN/20 mM NaH <sub>2</sub> BO <sub>3</sub> containing 10 mM triethylamine (35:65) at 1 mL/min	λ <sub>exc</sub> 365 nm λ <sub>em</sub> 400 nm			

See abbreviations of mycotoxins in the text.

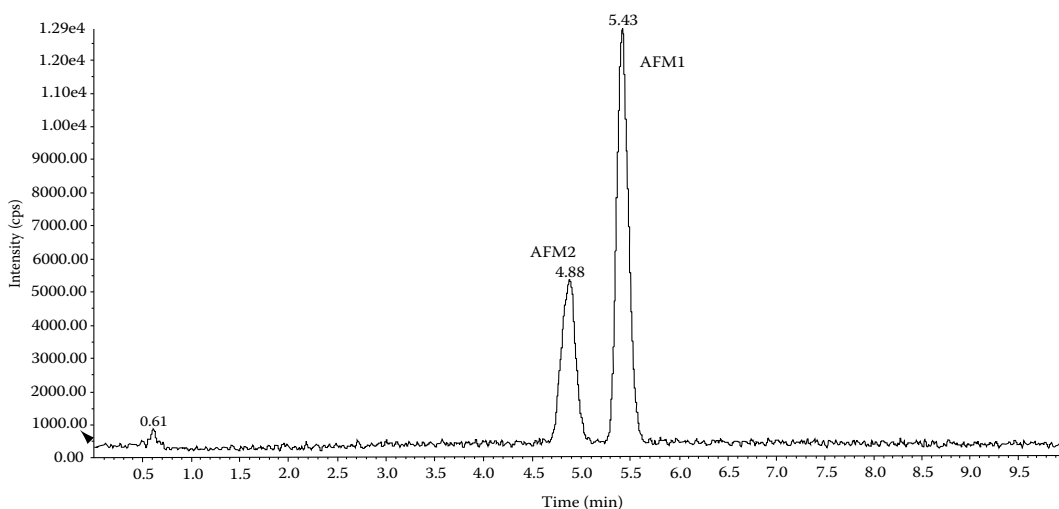
n.r., not reported; FLD, fluorescence detection; CE, capillary electrophoresis; DAD, diode array detector; LD, limit of detection; LOQ, limit of quantification; LC, liquid chromatography; GC, gas chromatography.

<sup>a</sup> μg/kg.



**Figure 33.3** LC-FLD chromatograms of (a) AFM1 standard solution at 0.004  $\mu\text{g/mL}$ ; (b) naturally contaminated pasteurized milk with an AFM1 concentration of 0.004  $\mu\text{g/L}$ . (Reprinted from Zinedine, A. et al., *Int. J. Food Microbiol.*, 114, 25, 2007. With permission.)

*n*-hexane (20  $\mu\text{L}$ ) and TFA (5  $\mu\text{L}$ ) are added to the residue and the mixture is vortexed and allowed to stand at 40°C for 20 min. The mixture is again evaporated to dryness under a gentle stream of nitrogen, reconstituted in 50  $\mu\text{L}$  of mobile phase, and reinjected into the LC system. For OTA, the method used is based on the methyl-ester formation according to Zimmerli and Dick [65]. The procedure consists of adding 2.5 mL of methanol and 0.1 mL of concentrated hydrochloric acid to 200  $\mu\text{L}$  of OTA residue. The vial is closed and kept overnight at room temperature, and the reaction mixture is evaporated to dryness and the residue is redissolved in mobile phase. The LC with MSD has been introduced for the analysis of mycotoxins in dairy and dairy products, but the number of articles published is limited when compared with the other detectors. Figure 33.4 demonstrates a chromatogram for AFM1 analyzed by LC–MS.



**Figure 33.4** LC/MS/MS chromatogram of an ewe-milk AFM1 contaminated sample. (Reprinted from Bognanno, M. et al., *Mol. Nutr. Food Res.*, 50, 300, 2006. With permission.)

## 33.2 Toxins in Dairy Food

### 33.2.1 Introduction

Food poisoning owing to bacterial toxins can be caused by the ingestion of exotoxins that are formed in the food, or by the ingestion of food containing large numbers of bacterial cells that subsequently release endotoxins in the gastrointestinal tract. Early methods for the assay of bacteria toxins were based on *in vivo* or *in vitro* tests. Later, immunological tests were developed based on techniques such as gel diffusion, but these tests were laborious and difficult to apply to foods. Now, a number of rapid test kits are available which give results within hours and are much simpler to perform and interpret, than bioassays.

#### 33.2.1.1 Principal Bacterial Toxins in Dairy Products

The high level of nutrients in milk makes it an especially suitable growth medium for various bacteria, including those belonging to the families of *Enterobacteriaceae*, *Streptococcaceae*, and *Bacillaceae*. In fact, these microorganisms can reach high population densities following contamination during milk processing in dairy farms and dairy industry [66]. In particular, bacterial toxins are an important cause of a variety of human and animal diseases.

The most important bacterial toxins involved in outbreaks or food poisonings from dairy products are as follows.

##### 33.2.1.1.1 *Staphylococcus aureus*

*Staphylococcus aureus* is considered as the third most important cause of diseases in the world among the reported foodborne illnesses [67–69]. This food poisoning is caused by consuming foods containing the enterotoxins produced by the strains of *S. aureus*.

Table 33.3 Analysis of Mycotoxins in Dairy Products

Mycotoxin	Sample	Extraction Technique	Cleanup Technique	Separation	Detection	Recovery (%)	LD (ng/L)	Reference
AFM1	Cheese	Centrifugation with CH <sub>2</sub> Cl <sub>2</sub> and celite, filter (Whatman No. 1), redissolved in CH <sub>3</sub> OH, H <sub>2</sub> O, and <i>n</i> -hexane (30:50:20), and the aqueous phase separated for cleanup technique	IAC (Aflaprep) eluted with CH <sub>3</sub> CN	LC	FLD	75.2–88.4	n.r.	[32]
				Column TSK-GEL C <sub>18</sub> (250 × 4.6 mm, 5 μm), CH <sub>3</sub> CN: CH <sub>3</sub> OH:H <sub>2</sub> O (20:20:60) at 1 mL/min	λ <sub>exc</sub> 360 nm λ <sub>em</sub> 440 nm			
AFM1	Cheese	Blended with CH <sub>2</sub> Cl <sub>2</sub> and diatomaceous earth, evaporated and redissolved with CH <sub>3</sub> OH, H <sub>2</sub> O, and <i>n</i> -hexane and, the aqueous phase separated for cleanup technique	IAC (AflaPrep) eluted with CH <sub>3</sub> OH	LC	FLD	98.5	56	[28]
				C <sub>18</sub> (250 × 4.6 mm), CH <sub>3</sub> OH/CH <sub>3</sub> CN/H <sub>2</sub> O (20:20:60) at 0.8 mL/min	λ <sub>exc</sub> 366 nm λ <sub>em</sub> 440 nm			

(continued)

Table 33.3 (continued) Analysis of Mycotoxins in Dairy Products

Mycotoxin	Sample	Extraction Technique	Cleanup Technique	Separation	Detection	Recovery (%)	LD (ng/L)	Reference
AFM1	Yoghurt	Extraction with CH <sub>2</sub> Cl <sub>2</sub> , evaporated and redissolved in CH <sub>3</sub> OH and water. <i>n</i> -Hexane is used to eliminate fat	IAC (Aflaprep) eluted with CH <sub>3</sub> CN	LC	FLD	88–99	10 ng/kg	[33]
				LiChrospher 100 RP-18 (250 × 4.6 mm, 5 μm), CH <sub>3</sub> CN/H <sub>2</sub> O (25:75) at 0.8 mL/min	λ <sub>exc</sub> 360 nm λ <sub>em</sub> 435 nm			
AFM1	Curd	Shaken CH <sub>3</sub> Cl, celite, and saturated NaCl and removed the organic layer	IAC (AflaM1) eluted with CH <sub>3</sub> OH	LC	FLD	n.r.	n.r.	[25]
				Zorbax SB C <sub>18</sub> (150 × 4.6 mm, 3 μm), CH <sub>3</sub> CN/H <sub>2</sub> O/CH <sub>3</sub> COOH (25:75:1) at 1 mL/min	λ <sub>exc</sub> 365 nm λ <sub>em</sub> 435 nm			

See abbreviations of mycotoxins in the text.

n.r., not reported; FLD, fluorescence detection; LC, liquid chromatography; IAC, immunoaffinity column; LD, limit of detection.

Staphylococci can multiply rapidly in many foods, but milk is a good substrate for *S. aureus* growth, and milk and milk products have been the source of many staphylococcal food poisonings [70,71]. *S. aureus* can gain access to milk either by direct excretion from udders with clinical or subclinical staphylococcal mastitis, or by the contamination from the environment during handling and processing of raw milk [72,73]. Although pasteurization kills *S. aureus* cells, the thermo-stable staphylococcal enterotoxins (SEs) remain and generally retain their biological activity [74].

Traditionally, classic SE-type antigens have been recognized: SEA, SEB, SEC1, SEC2, SEC3, SED, and SEE [75]. During the 1990s, new SEs (SEG, SHE, SEI, and SEJ) were reported and their genes described [76–78]. More recent data resulting from partial or complete genome sequence analyses have led to the description of further “new” genes: *sek*, *sel*, *sem*, *sen*, *seo*, *sep*, *seq*, *ser*, and *seu* [79–82].

Detection of SEs in implicated foods is essential to confirm staphylococcal food poisoning, but the detection of *S. aureus* and SEs in food is often difficult [83]. In an outbreak of gastroenteritis owing to chocolate milk, Evenson et al. [84] determined that ingestion of 100–200 ng of enterotoxins can induce symptoms of food poisoning, and foods implicated with staphylococcal food poisoning typically contain about 0.5–10 µg of toxin per 100 g of food. Therefore, the sensitivity of any detection method needs to be below this level.

### 33.2.1.1.2 Shiga Toxin-Producing *Escherichia coli*

*Escherichia coli* is a genetically heterogeneous group of bacteria whose members are typically non-pathogens that are a part of the normal microflora of the intestinal tract of humans and animals [85]. However, certain subsets of this bacteria cause enteric diseases. One of these subsets called Shiga toxin-producing *E. coli* (STEC) includes strains of *E. coli* that produce at least two potent phage-encoded cytotoxins called Shiga toxins (Stxs) [86]. The STEC are also called verotoxin (VT)-producing *E. coli*. The names Stx, derived from the similarity to a cytotoxin produced by *Shigella dysenteriae* serotype 1 [87], and VT, based on the cytotoxicity for Vero cells [88] are used interchangeably. In fact, STEC has emerged as an important global health threat and is recognized as an important pathogen of human diarrhea capable of causing life-threatening conditions, like hemolytic-uremic syndrome (HUS) [89].

Fecal contamination during the milking process, along with poor hygienic practices is known to account for the presence of STEC in raw milk [90]. The possibility of transmission through the consumption of raw milk [91] as well as raw-milk dairy products, such as cheese [92–94] and yoghurt [95], has been repeatedly documented as responsible for the outbreaks and sporadic cases of illnesses.

### 33.2.1.1.3 *Bacillus cereus*

*Bacillus cereus* is a ubiquitous spore-forming bacterium that is a common cause of food poisoning. Moreover, *B. cereus* is associated with spoilage problems in the dairy industry [96,97], including defects such as off-flavors, sweet curdling, and bitty cream [98]. In addition, *B. cereus* has been also associated with the outbreaks of food poisoning. This microorganism is responsible for 1% and 25% of food-poisoning outbreaks worldwide of known etiology. However, surprisingly, only few reports of food poisoning caused by *B. cereus* from milk and cream have been reported.

Their main contamination route to milk is via teats contaminated by soil and feces or bedding material, and to some extent via feed [99]. Milking equipment can also be a contamination source; silos tanks, pasteurizers, and packing machines may lead to further contamination of the milk and milk-containing products [100–105].

*Bacillus cereus* can cause two types of food-poisoning diseases: the diarrheal and emetic syndromes. The emetic syndrome is caused by only one heat-stable toxin (cereulide) that is formed in food [104]. The diarrheal syndrome is caused by several different heat-labile toxins formed by the vegetative bacteria [105]. Toxin production is strongly dependent on the culture medium and bacterial growth conditions, and the ability of toxin produced by *B. cereus* in milk under different dairy processing and storage conditions is not known.

The identification and widespread incidence of toxin-producing strains from a variety of food, including pasteurized dairy products led to renewed interest in methods for the detection of *B. cereus* toxins. The presence of diarrheal strains in milk is well known and there are several polymerase chain reaction (PCR) methods and immunological kits available for the detection of these strains [106,107]. However, the study of emetic strains in food chain has been hampered by the lack of suitable detection methods. In fact, at present, there are no commercially available rapid test kits for the detection of the emetic toxin, owing to difficulties in purification and characterization of the toxin [108].

### **33.2.2 Analysis of Bacterial Toxins in Dairy Foods**

#### **33.2.2.1 Biological Assays**

Although modern assay methods are a rapid and convenient means of testing for bacterial toxins, they do not provide information on the biological activity of the toxin. Rasooly et al. [109] studied the in-vitro T-cell proliferation of human and rat lymphocytes in response to the concentrations of SEA of *S. aureus*. They demonstrated that the T-cell response to SEA correlated well with increasing amounts of this toxin in the studied food matrix, with the exception of milk. In milk, proliferation at 10 ng/well was lower than that for the sample with 1 ng/well, but the difference between the two values was not statistically significant. This correlation may not be feasible because, the presence of milk in the SEA sample increased the efficiency of SEA heat inactivation. This suggests that the presence of SEA, even at low concentration levels, produces the T-cell proliferation, and this fact could be employed for the detection of this toxin in milk.

In the case of STEC, a range of in vivo and in vitro tests have been described including ileal loop [110], rabbit skin, Chinese hamster ovary (CHO) [111], and suckling mouse assay [112], but they were not suitable for routine use. Simpler alternatives to the biological assays based on immunological techniques and nucleic-acid hybridization were needed [108].

Owing to the difficulties in the determination of *B. cereus* emetic toxin, early biological assay methods for screening for *B. cereus* emetic toxin involved feeding to rhesus monkeys. However, by European legislation, effective from June 1, 2007, whole animals are not allowed for food testing. Consequently, in-vitro assays were used for toxin detection in food. Cereulide is observed to cause vacuolation of the mitochondria in HEp-2 [113]. Another biological technique to determine this emetic toxin is the sperm-based bioassay, which is based on the loss of mobility of boar sperm cells upon exposure to the emetic toxin [114]. Biological assays for the detection of *B. cereus* diarrheal toxin include the rabbit ileal loop test and the vascular permeability reaction test [108].

These methods are laborious and very expensive, and rather difficult to perform in food products on a routine basis, and thus, may not be easily accessible to food industry laboratories [115].

#### **33.2.2.2 Immunological Tests**

Immunological assays are much simpler and cheaper than biological assays, and have therefore been widely adopted [108]. The currently available methods for bacterial toxins detection are based

on microbiological cultures of milk and milk products, and have been developed according to three methods: ELISA, enzyme-linked immunofiltration assay (ELIFA), and reversed passive latex agglutination (RPLA) [116].

ELISA is probably the most widely used immunoassay. In ELISA, the target antigen is captured by incubating the test sample in specific antibody-coated wells. The bound antigen is detected by reacting with another enzyme-specific substrate to form a colored or fluorescent product. The amount of label present at completion of the assay (and color) is directly proportional to the target analyte concentration. A rapid alternative to ELISA is the ELIFA, in which the filtration of the test sample through a high-affinity membrane accelerates the reaction between the analyte and the ligand immobilized on the membrane, reducing the total assay time to 1 h [108].

The RPLA can be used to detect soluble antigens in food extracts or culture filtrates by a simple latex agglutination assay. The antibody is attached to the latex particles and allowed to react with the soluble antigen. If the antigen is present in the sample, agglutination occurs owing to the formation of molecular lattice and a diffuse layer is formed at the base of the well. The assay is simple and rapid to perform, but it is relatively expensive and gives only semiquantitative results. For example, the SET-RPLA kit (Oxoid) is one of the most widely used commercial kits for SEs. This kit is a latex-based immunological test, in which visible cross-linking of antibody-coated latex particles occurs in the presence of SEs, allowing simultaneous detection of SEs A, B, C, and D in food extracts and culture filtrates. The initial studies showed that nonspecific reactions were obtained when analyzing cheese, making the kit unsuitable for the analysis of dairy products [117,118]. However, Rose et al. [119] applied this test to a variety of dairy products, demonstrating that the nonspecific reactions could be reduced by the addition of 10 nmol/L of hexametaphosphate to the diluent, without affecting the ability to detect SEs in these products. The sensitivity of the SET-RPLA was demonstrated to be 0.25 ng/mL.

Several commercial immunoassays exist for the detection of STEC in pure cultures of *E. coli*, although there is limited literature based on this. As it will be described later, almost all the studies have been carried out by PCR.

However, there are several disadvantages associated with microbiological cultures, such as time consumption, cost, and detection limits higher than the level required for bacterial intoxications [116].

Two commercial kits also exist for the rapid detection of *B. cereus* diarrheal toxin in food and cultures. The BCET-RPLA kit was evaluated by Granum [106] in dairy products and compared with the results of Western immunoblot and vascular permeability reaction. They concluded that the BCET-RPLA is a very simple and reliable method for the detection of *B. cereus* diarrheal toxin. However, other authors obtained results referring that the immunological activity measured in BCET-RPLA does not correlate with the biological activity [119]. For example, Day et al. [120] detected the enterotoxin in the culture supernatants of 13 strains of *B. cereus* using the other commercial kit, TECRA-kit, but only 6 strains were detected with the BCET-RPLA. One of the seven strains that were negative in the BCET-RPLA had previously been shown to produce diarrheal toxin in monkey feeding test, and four of the other six had been implicated with food-poisoning outbreaks [121,122].

### 33.2.2.3 Phenotypic Assays

PCR is a highly specific and sensitive method for amplifying nucleic-acid sequences exponentially. PCR assays for the detection of the toxin-encoding genes in bacteria have been developed, but none have yet been commercialized [123].

This technique has been often experimented in milk and cheese for the direct detection of *S. aureus* [124,125] and has been introduced as a simple technique for the detection of enterotoxigenic strains [67,126]. Although the PCR-based approach is specific, highly sensitive, and rapid,



it can only demonstrate the presence of enterotoxin genes in *S. aureus* isolates rather than the production of the SEs protein [125].

A number of nucleic acid-based assays have been described for the detection of STEC. In fact, PCR is the method of choice to determine this type of bacterial toxins. Vivegnis et al. [127] achieved the growth of the bacteria on McConkey agar from raw milk cheese and used PCR to detect Stx genes. For each PCR-positive sample, isolated colonies were subsequently identified through a biochemical test (API 20) and a complementary indole production test. These authors concluded that the production of Stx was not sufficient to cause the disease, as other factors are thought to contribute to the virulence of this bacteria; Stx genes were detected in 17 cheese samples, but the toxin-producing strains could be isolated only from 5 of them. This low isolation level can probably be related to the loss of Stx genes in-vitro by some STEC strains or to the unfavorable proportion of STEC versus other *E. coli* strains. To overcome this difficulty, colony blot or DNA/DNA hybridization assay can be used to detect and isolate STEC [128]. Similarly, Rey et al. [129] and Caro et al. [130] determined the occurrence of STEC in different Spanish dairy products. In the first study [129], a total of 502 dairy products were examined for STEC using genotypic (PCR) methods. As in the previous work, the prevalence of STEC in milk was low, and the authors hypothesized that this circumstance would be related to the fact that milk carries a number of immune factors (principally IgA) and nonimmune factors (e.g., lactoferrin) that specifically hinder the adherence and subsequent proliferation of STEC on certain cell substrates. By contrast, serotype O157:H7 showed a high prevalence owing to its resistance and survival in refrigerated milk tanks, and resistance to acid pH and high NaCl concentrations.

In the second study [130], a total of 83 raw-milk cheese samples were examined for virulence genes using PCR. The obtained results and conclusions were similar to those obtained by the above-mentioned authors.

#### 33.2.2.4 *Biologic–Immunologic–Phenotypic Combination Studies*

Sometimes, the use of a combination of techniques is needed. The PCR demonstrates the presence of genes capable to produce the toxin, and the immunological methods indicate the serotype of the toxin. Hence, coupling of these two techniques can give the global information of a possible toxin outbreak.

To demonstrate the capability of the strain to produce an amount of SE protein sufficient to induce a disease, the bioassay or immunological methods for the detection of SEs protein must be used [116]. Some studies on this topic are reported in the literature. Morandi et al. [131] compared the results obtained by PCR and SET-RPLA, and concluded that the PCR technique revealed a higher number of potential enterotoxin-producing strains. Indeed, in a high percentage of isolates where classical SEs production was identified by SET-RPLA (A, B, C, and D), the presence of other strains (*g*, *j*, *i*, *h*, and *l*) was confirmed by PCR technique. Jørgensen et al. [72] isolated samples of bovine and caprine bulk milk and raw milk products, and tested these isolated samples for SEs production by SET-RPLA, and for SE genes by PCR. They concluded that the most commonly toxin detected in these products was SEC and *sec*.

In the same way, Normanno et al. [68] evaluated the occurrence of *S. aureus*, characterized the isolated strains based on their production of SEs and antimicrobial-resistance pattern, and biotyped the isolated strains from milk, dairy, and meat products. For these purposes, they used the SET-RPLA to detect the enterotoxin production (SEA to SED) and a PCR to screen from *sea* to *sed* genes. Loncarevic et al. [132] used SET-RPLA to test the SEA to SED of *S. aureus* from

raw milk and raw milk products, and PCR for the identification and characterization of the same isolates as tested with SET-RPLA.

Das et al. [133] determined the distribution, virulence-gene profile, and phenotypes of STEC strains within a dairy farm in India. The milk samples were inoculated into the EC medium, and after incubation, each enriched culture was directly tested by multiplex PCR. The colony that yielded a positive result was further confirmed for the presence of Stx by Stx-PCR. For a highly sensitive Stx detection, Bead-ELISA and Vero cells assay for determining cytotoxic effects were performed. As reported in other studies, the isolation rate of STEC from the PCR-positive samples was low (only two from the fresh milk). With regard to the virulence-gene profiles, most of the strains harbored only Stx1. Moreover, of the 30 strains examined, 27 were found to be cytotoxic to Vero cells. Out of these 27 strains, only 5 showed positivity for Stx in Bead-ELISA.

Borge et al. [134] investigated the growth, sporulation, and germination of a selection of toxin-producing *B. cereus* strains, isolated from dairy and meat products using PCR analysis of coding regions of enterotoxin genes, and evaluated the cytotoxicity to Vero cells. In the same way, Beattie and Williams [135] studied the factors that affect toxin formation by *B. cereus* in the fermentation process of dairy products. For this purpose, diarrheal enterotoxin was detected using CHO cells. The presence of the toxin in the culture's supernatant fluids could be detected by measurement of the total metabolic activity of the CHO cells. Enterotoxin was also determined using commercially available BCET-RPLA and TECRA immunoassays kits. These authors concluded that the immunological activity measured in BCET-RPLA did not correlate with the biological activity.

Furthermore, Arnesen et al. [136] employed the PCR technique to determine the genes encoding the enterotoxins of *B. cereus* in different dairies, and the cell cultures assays to measure the cytotoxicity toward Vero cells, to discriminate pathogenic *B. cereus* group strains from the non-pathogenic ones. Similarly, Te Giffel et al. [137] carried out an investigation to determine the level of *B. cereus* in pasteurized milk by sampling and testing the milk stored in household refrigerators. Using immunoblotting, Vero cells assays, and PCR, the samples were examined and were found to produce the toxin.

On the other hand, some authors combined PCR, to prove the presence of toxin genes, and immunoassays, to show the production of the toxin. For example, Svensson et al. [138], to characterize the hazard posed by *B. cereus* in the milk-production chain, tested the *B. cereus* group from farms, silo tanks, and production lines for pasteurized milk for toxin-production potential, using PCR to detect the presence of toxin genes. The toxin production was measured with the two commercial kits, TECRA and BCET-RPLA.

The study of Svensson et al. [139] went one step further in the analysis of *B. cereus* emetic toxin in dairy products, in which the phenotypic methods, RAPD-PCR, as well as the sperm test were applied to determine the cytotoxicity. The quantitative analysis for cereulide was carried out by liquid chromatography–ion trap-mass spectrometry (LC–IT-MS) at dairy farms and dairy plants.

### 33.3 Future Trends

Although immunoassay-based methods are sensitive and widely used for measuring protein toxins in food matrices, there is a need for the methods that can directly confirm the molecular identity of the toxin in situations where immunoassay tests yield a positive result.

The applications of the techniques, such as HPLC or GC coupled with MS have been scarcely applied to identify and characterize bacterial toxins and mycotoxins. The complicated food matrix, high cost of the equipments, low sample throughput, and amount of work involved, along with the

length of time taken to achieve a result and the level of experience needed for the analysis, preclude the use of these techniques as routine procedures [121].

A method using HPLC–MS/MS has been developed to identify SEB in apple juice. The approach employs ultrafiltration to remove low-molecular weight components from the sample, after which, the remaining high-molecular weight fraction, containing the protein, is digested with trypsin. The authors indicated that this analysis cannot be applied to a large number of foods. The results showed that it was probably generally applicable to food matrices with low concentrations of soluble proteins, but there were difficulties with high-protein matrices such as milk. Measurement of SEB in milk using this approach is limited at present to ppm levels, principally owing to the suppression by the large number of peptides produced upon digestion of the milk proteins. The authors proposed two possibilities: (i) more selective sample extraction approaches (immunomagnetic method using antibodies for SEB, followed by extraction/digestion, or (ii) direct digestion of the antibody beads and reduction of the suppression of the target analyte signals by milk peptides through the use of multidimensional separations (ion exchange combined with reversed-phase LC), to fractionate the sample further prior to MS analysis [140].

## References

1. Fink-Gremmels, F. Mycotoxins in cattle feeds and carry-over to dairy milk: A review. *Food Addit. Contam.* 25, 172, 2008.
2. Wu, F. Mycotoxin reduction in Bt corn: Potential economic, health, and regulatory impacts. *Transgenic Res.* 15, 277, 2006.
3. Nawaz, S., Scudamore, K.A., Rainbird, S.C. Mycotoxins in ingredients of animal feeding stuffs: I. Determination of *Alternaria* mycotoxins in oilseed rape meal and sunflower seed meal. *Food Addit. Contam.* 14, 249, 1997.
4. Scudamore, K.A., Nawaz, S., Hetmanski, M.T. Mycotoxins in ingredients of animal feeding stuffs: II. Determination of mycotoxins in maize and maize products. *Food Addit. Contam.* 15, 30, 1998.
5. Cheeke, P.R. Endogenous toxins and mycotoxins in forage grasses and their effects on livestock. *J. Animal Sci.* 73, 909, 1995.
6. O'Brien, M., O'Kiely, P., Forristal, P.D., Fuller, H.T. Fungi isolated from contaminated baled grass silage on farms in the Irish Midlands. *FEMS Microbiol. Lett.* 247, 131, 2005.
7. Mansfield, M.A., Kuldau, G.A. Microbiological and molecular determination of mycobiota in fresh and ensiled maize silage. *Mycologia.* 99, 269, 2007.
8. Kiessling, K., Pettersson, H., Sandholm, K., Olsen, M. Metabolism of aflatoxin, ochratoxin, zearalenone and three trichothecenes by intact rumen fluid, rumen protozoa and rumen bacteria. *Appl. Environ. Microbiol.* 47, 1070, 1984.
9. Prandini, A. et al. On the occurrence of aflatoxin M1 in milk and dairy products. *Food Chem. Toxicol.* 47, 984, 2009.
10. Fernández, M., Ferrer, E. Aflatoxin M1. In: *Food Mycotoxins*, Soriano, J.M., Ed. Díaz de Santos, Madrid, 2007, Chapter 9.
11. Henry, S.H. et al. Aflatoxin M1. In: *Safety Evaluation of Certain Mycotoxin in Food*, Joint FAO/WHO Expert Committee on Food Additives (JECFA), Ed. WHO, Geneva, 2001, Chapter 1.
12. Zinedine, A., González-Osnaya, L., Soriano, J.M., Moltó, J.C., Idrissi, L., Mañes, J. Presence of AFM1 in pasteurized milk from Morocco. *Int. J. Food Microbiol.* 114, 25, 2007.
13. Van Egmond, H.P. *Mycotoxins in Dairy Products*. Elsevier Science Publishing Co., Ltd., New York, 1989.
14. Veldman, A., Meijs, J.A.C., Borggreve, G.J., Heeresvan der Tol, J.J. Carry-over of aflatoxin from cows' food to milk. *Anim. Prod.* 55, 163, 1992.
15. Barbieri, G., Bergamini, C., Ori, E., Pesca, P. Aflatoxin M<sub>1</sub> in Parmesan cheese: HPLC determination. *J. Food Sci.* 54, 1313, 1994.

16. Boudra, H., Morgavi, D.P. Development and validation of a HPLC method for the quantification of ochratoxins in plasma and raw milk. *J. Chromatogr. B* 843, 295, 2006.
17. Seeling, K. et al. Effects of Fusarium toxin-contaminated wheat and feed intake level on the biotransformation and carry-over of deoxynivalenol in dairy cows. *Food Addit. Contam.* 23, 1008, 2006.
18. Prasongsidh, B.C., Kailasapathy, K., Skurray, G.R., Bryden, W.L. Stability of cyclopiazonic acid during storage and processing of milk. *Food Res. Int.* 30, 793, 1997.
19. Sorensen, L.K., Elbaek, T.H. Determination of mycotoxins in bovine milk by liquid chromatography tandem mass spectrometry. *J. Chromatogr. B*, 820, 183, 2005.
20. Durix, A. et al. Analysis of ergovaline in milk using high-performance liquid chromatography with fluorescence detection. *J. Chromatogr. B*, 729, 255, 1999.
21. Imerman, P.M., Stahr, H.M. New, sensitive high-performance liquid chromatography method for the determination of slaframine in plasma and milk. *J. Chromatogr. A*, 815, 141, 1998.
22. Decastelli, L. et al. Aflatoxins occurrence in milk and feed in Northern Italy during 2004–2005. *Food Control*, 18, 1263, 2007.
23. Diaz, G.J., Espitia, E. Occurrence of aflatoxin M1 in retail milk samples from Bogotá, Colombia. *Food Addit. Contam.* 23, 811, 2006.
24. Bognanno, M. et al. Survey of the occurrence of aflatoxin M1 in ovine milk by HPLC and its confirmation by MS. *Mol. Nutr. Food Res.* 50, 300, 2006.
25. Battaccone, G. et al. Transfer of aflatoxin B1 from feed to milk and from milk to curd and whey in dairy sheep feed artificially contaminated concentrates. *J. Dairy Sci.* 88, 3063, 2005.
26. Grosso, F., Fremy, J.M., Bevis, S., Dragacci, S. Joint IDF-IUPAC-IAEA (FAO) interlaboratory validation for determining aflatoxin M1 in milk by using immunoaffinity clean-up before thin-layer chromatography. *Food Addit. Contam.* 21, 348, 2004.
27. Atanda, O. et al. Aflatoxin M1 contamination of milk and ice cream in Abeokuta and Odeda local governments of Ogun State, Nigeria. *Chemosphere*, 68, 1455, 2007.
28. Elgerbi, A.M., Aidoo, K.E., Candlish, A.A.G., Tester, R.F. Occurrence of aflatoxin M1 in randomly selected North African milk and cheese samples. *Food Addit. Contam.* 21, 592, 2004.
29. Tajkarimi, M. et al. Seasonal study of aflatoxin M1 contamination in milk in five regions in Iran. *Int. J. Food Microbiol.* 116, 346, 2007.
30. Bascarán, V., Hernández de Rojas, A., Chouciño, P., Delgado, T. Analysis of ochratoxin A in milk after direct immunoaffinity column clean-up by high-performance liquid chromatography with fluorescence detection. *J. Chromatogr. A*, 1167, 95, 2007.
31. González-Osnaya, L., Soriano, J.M., Moltó, J.C., Mañes, J. Simple liquid chromatography assay for analyzing ochratoxin A in bovine milk. *Int. J. Food Microbiol.* 108, 272, 2008.
32. Kamkar, A., Karim, G., Shojaee Aliabadi, F., Khaksar, R. Fate of aflatoxin M1 in Iranian white cheese processing. *Food Chem. Toxicol.* 46, 2236, 2008.
33. Martins, L.M., Marina M.H. Aflatoxin M1 in yoghurts in Portugal. *Int. J. Food Microbiol.* 91, 315, 2004.
34. Gilbert, J. Validation of analytical methods for determining mycotoxins in foodstuffs. *Trends Anal. Chem.* 21, 468, 2002.
35. Van Egmond, H.P., Wagstaffe, P.J. Development of milk powder reference materials certified for aflatoxin M<sub>1</sub> content (Part 1). *J. AOAC Int.* 70, 605, 1987.
36. Boenke, A. BCR- and M&T-activities in the area of mycotoxin analysis in food and feedstuffs. *Nat. Toxins* 3, 243, 2006.
37. Standard Measurement and Testing (SMT). Standard Measurement Testing Project SMT-CT96-2045. European Communities, Brussels, 1996.
38. Dragacci, S., Grosso, F., Gilbert, J. Immunoaffinity column cleanup with liquid chromatography for determination of aflatoxin M1 in liquid milk: Collaborative study. *J. AOAC Int.* 84, 437, 2001.
39. Grosso, F., Dragacci, S., Lombard, B. Second community proficiency testing for the determination of aflatoxin M1 in milk (November 1998). Report aflatoxin SSA/TOMI/FG 9901, Paris, May 1999.
40. European Communities (EC). Commission Regulation No. 1525/98. *Off. J. Eur. Com.* L201, 93, 1998.

41. European Communities (EC). Commission Decision 91/180/EEC. *Off. J. Eur. Com.* L93, 1, 1991.
42. Agboola, S.O., Dalgleish, D.G. Enzymatic hydrolysis of milk proteins used for emulsion formation. 1. Kinetics of protein breakdown and storage stability of the emulsions. *J. Agric. Food Chem.* 44, 3631, 1996.
43. Huppertz, T., Fox, P.F., Kelly, A.L. Degradation of ochratoxin A by a ruminant. *Appl. Environ. Microbiol.* 32, 443, 2004.
44. Fremy, J.M., Chu, F.S. A direct ELISA for determining aflatoxin M<sub>1</sub> at ppt levels in various dairy products. *J. Assoc. Off. Anal. Chem.* 67, 1098, 1984.
45. Mortimer, D.N., Gilbert, J., Shepherd, M. J. Rapid and highly sensitive analysis of aflatoxin M<sub>1</sub> in liquid and powdered milks using an affinity column cleanup. *J. Chromatogr.* 407, 393, 1987.
46. de Sylos, C.M., Rodriguez-Amaya, D.B., Carvalho, P.R. Occurrence of aflatoxin M<sub>1</sub> in milk and dairy products commercialized in Campinas, Brazil. *Food Addit. Contam.* 13, 169–172, 1996.
47. Paul, P., Thurm, V. Determination and occurrence of aflatoxin M<sub>1</sub> in milk and dried milk products. *Nahrung.* 27, 877, 1983.
48. van Egmond, H.P., Stubblefield, R.D. Improved method for confirmation of identity of aflatoxins B<sub>1</sub> and M<sub>1</sub> in dairy products and animal tissue extracts. *J. Assoc. Off. Anal. Chem.* 64, 152, 1981.
49. International Organization for Standardization (ISO). Milk and milk powder-determination of aflatoxin M<sub>1</sub> content-clean-up by immunoaffinity chromatography and determination by TLC. ISO/DIS 14674-IDF 190, 2005.
50. Saitanu, K. Incidence of aflatoxin M<sub>1</sub> in Thai milk products. *J. Food Prot.* 60, 1010, 1997.
51. Offiah, N., Adesiyun, A. Occurrence of aflatoxins in peanuts, milk, and animal feed in Trinidad. *J. Food Prot.* 70, 771, 2007.
52. Frémy, J.M., Chu, F.S. Immunochemical methods of analysis for aflatoxin M<sub>1</sub>. In: *Mycotoxins in Dairy Products*, van Egmond, H.P., Ed., Elsevier Applied Science, London, 1989, pp. 97–125.
53. Barbiroli, A. et al. Binding of aflatoxin M<sub>1</sub> to different protein fractions in ovine and caprine milk. *J. Dairy Sci.* 90, 352, 2007.
54. Rodríguez V.M.L., Calonge D.M.M., Ordóñez E.D. ELISA and HPLC determination of the occurrence of aflatoxin M<sub>1</sub> in raw cow's milk. *Food Addit. Contam.* 20, 276, 2003.
55. Sassahara, M., Pontes Netto, D., Yanaka, E.K. Aflatoxin occurrence in foodstuff supplied to dairy cattle and aflatoxin M<sub>1</sub> in raw milk in the North of Paraná state. *Food Chem. Toxicol.* 43, 981, 2005.
56. López, C. et al. Distribution of aflatoxin M<sub>1</sub> in cheese obtained from milk artificially contaminated. *Int. J. Food Microbiol.* 64, 211, 2001.
57. Unusan, N. Occurrence of aflatoxin M<sub>1</sub> in UHT milk in Turkey. *Food Chem. Toxicol.* 44, 1897, 2006.
58. Kim, E.K., Shon, D.H., Ryu, D., Park, J.W., Hwang, H.J., Kim, Y.B. Occurrence of aflatoxin M<sub>1</sub> in Korean dairy products determined by ELISA and HPLC. *Food Addit. Contam.* 17, 59, 2000.
59. Benedetti, S., Iametti, S., Bonomi, F., Mannino, S. Head space sensor array for the detection of aflatoxin M<sub>1</sub> in raw ewe's milk. *J. Food Prot.* 68, 1089, 2005.
60. Salter, R., Douglas, D., Tess, M., Markovsky, B., Saul, S.J. Interlaboratory study of the Charm ROSA Safe Level Aflatoxin M<sub>1</sub> Quantitative lateral flow test for raw bovine milk. *J. AOAC Int.* 89, 1327, 2006.
61. Tuinstra, L.G., Roos, A.H., van Trijp, J.M. Liquid chromatographic determination of aflatoxin M<sub>1</sub> in milk powder using immunoaffinity columns for cleanup: Interlaboratory study. *J. AOAC Int.* 76, 1248, 1993.
62. International Dairy Federation (IDF). Protocol IDF study aflatoxin M<sub>1</sub>. IDF 171, 1995.
63. International Organization for Standardization (ISO). Milk and milk powder. Determination of aflatoxin M<sub>1</sub> content. Clean-up by immunoaffinity chromatography and determination by high-performance liquid chromatography. ISO 14501, 1998.
64. Takeda, N. Determination of aflatoxin M<sub>1</sub> in milk by reversed phase high performance liquid chromatography. *J. Chromatogr.* 288, 484, 1984.

65. Zimmerli, B., Dick, R. Determination of ochratoxin A at the ppt level in human blood, serum, milk and some foodstuffs by high-performance liquid chromatography with enhanced fluorescence detection and immunoaffinity column cleanup: Methodology and Swiss data. *J. Chromatogr. B.* 666, 85, 1995.
66. Bartoszewicz, M., Hansen, B.M., Swiecicka, I. The members of the *Bacillus cereus* group are commonly present contaminants of fresh and heat-treated milk. *Food Microbiol.* 25, 588, 2008.
67. Asperger, H., Zangerl, P. *Staphylococcus aureus*. In: *Encyclopaedia of Dairy Sciences*, Vol. 4, Roginsky, H., Fuquay, J.W., Fox, P.F., Eds, Academic Press, London, 2003, p. 2563.
68. Normanno, G. et al. Occurrence, characterization and antimicrobial resistance of enterotoxigenic *Staphylococcus aureus* isolated from meat and dairy products. *Int. J. Food Microbiol.* 115, 290, 2007.
69. Boerema, J.A., Clemens, R., Brightwell, G. Evaluation of molecular methods to determine enterotoxigenic status and molecular genotype of bovine, ovine and human and food isolates of *Staphylococcus aureus*. *Int. J. Food Microbiol.* 107, 192, 2006.
70. Davis, J.G. Microbiology of cream and dairy desserts. In: *Dairy Microbiology*, Vol. 2, R.K. Robinson, Ed., The Microbiology of Milk Products, Applied Science Publisher, Barking, 1981, p. 157.
71. De Buyser, M.L. et al. Implication of milk and milk products in food-borne diseases in France and in different industrialised countries. *Int. J. Food Microbiol.* 67, 1, 2001.
72. Jørgensen, H.J., Mørk, T., Rørvik, L.M. The occurrence of *Staphylococcus aureus* on a farm with small-scale production of raw milk cheese. *J. Dairy Sci.* 88, 3810, 2005.
73. Scherrer, D. et al. Phenotypic and genotypic characteristics of *Staphylococcus aureus* isolates from raw bulk-tank milk samples of goats and sheep. *Vet. Microbiol.* 101, 101, 2004.
74. Jablonsky, L.M., Bohach, G.A. *Staphylococcus aureus*. In: *Food Microbiology Fundamentals and Frontiers*, Doyle, M.P., Beuchat, L.R., Montville, T.J., Eds. American Society for Microbiology, Washington, DC, 1997, p. 353.
75. Bergedoll, M.S. et al. The staphylococcal enterotoxins: Similarities. *Contrib. Microbiol. Immunol.* 1, 390, 1973.
76. Munson, S.H. et al. Identification and characterization of staphylococcal enterotoxins type I and G from *Staphylococcus aureus*. *Infect. Immun.* 66, 3337, 1998.
77. Su, Y.C., Wong, A.C. Identification and purification of a new staphylococcal enterotoxins. *Appl. Environ. Microbiol.* 61, 1438, 1995.
78. Zhang, S., Iandolo, J.J., Steward, G.C. The enterotoxin D plasmid of *Staphylococcus aureus* encodes a second enterotoxin determinant (*sej*). *FEMS Microbiol. Lett.* 168, 227, 1998.
79. Fitzgerald, J.R. et al. Characterization of a putative pathogenicity island from *Staphylococcus aureus* encoding multiple superantigens. *J. Bacteriol.* 183, 63, 2001.
80. Jarraud, S. et al. *egc*, a highly prevalent operon of enterotoxin gene, forms a putative nursery of superantigens in *Staphylococcus aureus*. *J. Immunol.* 166, 669, 2001.
81. Letetre, C. et al. Identification of a new putative enterotoxin SEU encoded by the *egc* cluster of *Staphylococcus aureus*. *J. Appl. Microbiol.* 95, 38, 2003.
82. Omoe, K. et al. Detection *seg*, *seh* and *sei* genes in *Staphylococcus aureus* isolates and determination of enterotoxins productivities of *S. aureus* isolates harbouring *seg*, *seh* and *sei* genes. *J. Clin. Microbiol.* 40, 857, 2002.
83. Meyrand, A. et al. Evaluation of an alternative extraction procedure for enterotoxin determination in dairy products. *Lett. Appl. Microbiol.* 28, 411, 1999.
84. Evenson, M.L. et al. Estimation of human dose of staphylococcal enterotoxin A from a large outbreak of staphylococcal food poisoning involving chocolate milk. *Int. J. Food Microbiol.* 7, 311, 1988.
85. Gyles, C.L. Shiga toxin-producing *Escherichia coli*: An overview. *J. Anim. Sci.* 85, 45–62, 2007.
86. Doyle, M.P., Padhye, N.V. *Escherichia coli*. In: *Foodborne Bacterial Pathogens*, Doyle, M.P., Ed., Marcel Dekker, New York, 1989, p. 236.
87. O'Bryen, A.D. et al. Production of *Shigella dysenteriae* type 1-like cytotoxin by *Escherichia coli*. *J. Infect. Dis.* 146, 763, 1982.
88. Konowalchuk, J., Speirs, J.I., Stavric, S., Vero response to a cytotoxin of *Escherichia coli*. *Infect. Immun.* 18, 775, 1977.

89. Paton, J.C., Paton, A.W. Pathogenesis and diagnosis of Shiga toxin producing *Escherichia coli* infections. *Clin. Microbiol. Rev.* 11, 450, 1998.
90. Griffin, P.M., Tauxe, R.V. The epidemiology of infections caused by *Escherichia coli* O157:H7, other entero-hemorrhagic *E. coli* and associated haemolytic uremic syndrome. *Epidemiol. Rev.* 13, 60, 1991.
91. Lahti, E. et al. Use of phenotyping and genotyping to verify transmission of *Escherichia coli* O157:H7 from dairy farms. *Eur. J. Clin. Microbiol.* 21, 189, 2002.
92. Karmali, M.A. Infection by verocytotoxin-producing *Escherichia coli*. *Clin. Microbiol. Rev.* 2, 15, 1989.
93. Deschenes et al. Cluster of cases of haemolytic uremic syndrome due to unpasteurised cheese. *Pediatr. Nephrol.* 10, 203, 1996.
94. Altekruze, S.F. et al. Cheese-associated outbreaks of human illness in the United States, 1973 to 1992; sanitary manufacturing practices protect consumers. *J. Food Prot.* 61, 1405, 1998.
95. Morgan D. et al. Verotoxin producing *Escherichia coli* O157 infections associated with the consumption of yoghurt. *Epidemiol. Infect.* 111, 181, 1993.
96. Anderson, A., Rönner, U., Granum, P.E. What problems does the food industry have with the spore-forming pathogens *Bacillus cereus* and *Clostridium perfringens*? *Int. J. Food Microbiol.* 28, 45, 1995.
97. Larsen, H.D., Jørgensen, K. Growth of *Bacillus cereus* in pasteurized milk. *Int. J. Food Microbiol.* 46, 173, 1999.
98. Meer, R.R. et al. Psychrotrophic *Bacillus* spp. in fluid milk products: A review. *J. Food Prot.* 54, 969, 1991.
99. Christiansson, A., Bertilsson, J., Svensson, S., *Bacillus cereus* spores in raw milk: Factors affecting the contamination of milk during the grazing period. *J. Dairy Sci.* 82, 305, 1999.
100. Svensson, B. et al. Characterisation of *Bacillus cereus* isolated from milk silo tanks at eight different dairy plants. *Int. Dairy J.* 14, 17, 2004.
101. Svensson, B. et al. Involvement of pasteurizer in the contamination of milk by *Bacillus cereus* in a commercial dairy plant. *J. Dairy Res.* 67, 455, 2000.
102. Eneroth, Å. et al. Contamination of pasteurized milk by *Bacillus cereus* in the filling machine. *J. Dairy Res.* 68, 189, 2001.
103. Lin, A. et al. Identification of contamination sources of *Bacillus cereus* in pasteurized milk. *J. Food Microbiol.* 43, 159, 1998.
104. Melling, J. Capel, B.J. Characteristics of *Bacillus cereus* emetic toxin. *FEMS Microbiol. Lett.* 4, 133, 1978.
105. Granum, P.E., Brynestad, S., Kramer, J.M. Analysis of enterotoxin production by *Bacillus cereus* from dairy products, food poisoning incidents and non-gastrointestinal infections. *Int. Dairy J.* 17, 269, 1993.
106. Granum, P.E. *Bacillus cereus*. In: *Food Microbiology: Fundamentals and Frontiers*, M.P. Doyle, Ed. AMS Press, Washington, DC, 2001, p. 373.
107. In't Veld, P.H. et al. Detection genes encoding for enterotoxins and determination of the production of enterotoxins by HBL blood plates and immunoassays of psychrotropic strains of *Bacillus cereus* isolated from pasteurized milk. *Int. J. Food Microbiol.* 64, 63, 2001.
108. Pimbley, D.W., Patel, P.D. A review of analytical methods for the detection of bacterial toxins. *J. Appl. Microbiol. (Symp. Suppl.)* 84, 98, 1998.
109. Rasooly, L. et al. In vitro assay of *Staphylococcus aureus* Enterotoxin A activity in food. *Appl. Environ. Microbiol.* 63, 2361, 1997.
110. Burges, M.N. et al. Biological evaluation of a methanol soluble, heat stable *Escherichia coli* enterotoxin in the rabbit ileal loop. *Infect. Immun.* 21, 526, 1978.
111. Guerrant, R.L. et al. Cyclic adenosine monophosphate and alteration of Chinese hamster ovary cell morphology: A rapid, sensitive *in-vitro* assay for the enterotoxins of *Vibrio cholerae* and *Escherichia coli*. *Infect. Immun.* 10, 32, 1974.
112. Lovett, J., Peeler, J.T. Detection of *Escherichia coli* enterotoxins by mouse adrenal cells and suckling mouse assays: Collaborative study. *J. Assoc. Off. Anal. Chem.* 67, 946, 1984.

113. Ehling-Schulz, M., Fricker, M., Scherer S. Identification of emetic toxin producing *Bacillus cereus* strains by a novel molecular assay. *FEMS Microbiol. Lett.* 232, 189, 2004.
114. Anderson, M.A. et al. Sperm bioassay for rapid detection of cereulide-producing *Bacillus cereus* in food and related environments. *Int. J. Food Microbiol.* 94, 175, 2004.
115. Ehling-Schulz, M., Fricker, M., Scherer S. *Bacillus cereus*, the causative agent of an emetic type of food-borne illness. *Mol. Nutr. Food Res.* 48, 479, 2004.
116. Cremonesi, P. et al. Detection of enterotoxigenic *Staphylococcus aureus* isolates in raw milk cheese. *Lett. Appl. Microbiol.* 45, 586, 2007.
117. Park, C.E., Szabo, R. Evaluation of the reserved passive latex agglutination (RPLA) test kit for detection of staphylococcal enterotoxins A, B, C and D in food. *Can. J. Microbiol.* 32, 723, 1986.
118. Wieneke, A.A., Gilbert, R.J. Comparison of four methods for detection of staphylococcal enterotoxins in foods from outbreaks of food poisoning. *Int. J. Food Microbiol.* 4, 135, 1987.
119. Rose, S.A., Bankes, P., Stringer, M.F. Detection of staphylococcal enterotoxins in dairy products by the reversed passive latex agglutination kit. *Int. J. Food Microbiol.* 8, 65, 1989.
120. Day, T.L. et al. A comparison of ELISA and RPLA for detection of *Bacillus cereus* diarrhoeal enterotoxins. *J. Appl. Bacteriol.* 77, 9, 1994.
121. Brett, M.M. Kits for detection of some bacterial food poisoning toxins: Problems, pitfalls and benefits. *J. Appl. Microbiol. (Symp. Suppl.)* 84, 110, 1998.
122. McKillip, J.L. Prevalence and expression of enterotoxins in *Bacillus cereus* and other *Bacillus* spp., a literature review. *A. Van Leeuw.* 77, 393, 2000.
123. Hill, W.E., Olsvik, O. Detection and identification of foodborne pathogens by the polymerase chain reaction: Food safety applications. In: *Rapid Analysis Techniques in Food Microbiology*, Patel, P.D., Ed. Academic Press, London, 1994, p. 268.
124. Kim, C.H. et al. Optimisation of the PCR for detection of *Staphylococcus aureus nuc* gene in bovine milk. *J. Dairy Sci.* 84, 74, 2001.
125. Tamarapu, S., McKillip, J.L., Drake, M. Development of a multiplex polymerase chain reaction assay for detection and differentiation of *Staphylococcus aureus* in dairy products. *J. Food Protect.* 64, 664, 2001.
126. Know, N.H. et al. Application of extended single-reaction multiplex polymerase chain reaction for toxin typing of *Staphylococcus aureus* isolates in South Korea. *Int. J. Food Microbiol.* 97, 137, 2004.
127. Vivegnis, J. et al. Detection of Shiga-like toxin producing *Escherichia coli* from raw milk cheese produced in Wallonia. *Biotechnol. Agron. Soc. Environ.* 3, 159, 1999.
128. Padhyle, N.V., Doyle, P.M. *Escherichia coli* O157:H7: Epidemiology, pathogenesis, and methods for detection in foods. *J. Food Protect.* 55, 555, 1992.
129. Rey, J. et al. Prevalence, serotypes and virulence genes of Shiga toxin-producing *Escherichia coli* isolated from ovine and caprine milk and other dairy products in Spain. *Int. J. Food Microbiol.* 107, 212, 2006.
130. Caro, I., Garcia-Armesto, M.R. Occurrence of Shiga toxin-producing *Escherichia coli* in a Spanish raw ewe's milk cheese. *Int. J. Food Microbiol.* 116, 410, 2007.
131. Morandi, S. et al. Detection of classical enterotoxins and identification of enterotoxins genes in *Staphylococcus aureus* from milk and dairy products. *Vet. Microbiol.* 124, 66, 2007.
132. Loncarevic, S. et al. Diversity of *Staphylococcus aureus* enterotoxin types within single samples of raw milk and raw milk products. *J. Appl. Microbiol.* 98, 344, 2005.
133. Das, S.C. et al. Dairy farm investigation on Shiga toxin-producing *Escherichia coli* (STEC) in Kolkata, India with emphasis on molecular characterization. *Epidemiol. Infect.* 133, 617, 2005.
134. Borge, G.I. et al. Growth and toxin profiles of *Bacillus cereus* isolated from different food sources. *Int. J. Food Microbiol.* 69, 237, 2001.
135. Beattie, S.H., Williams, A.G. Growth and diarrhoeagenic enterotoxin formation by strains of *Bacillus cereus* in vitro in controlled fermentation and in situ in food products and a model food system. *Food Microbiol.* 19, 329, 2002.



136. Arnesen, L.P.S., O'Sullivan, K., Granum, P.E. Food poisoning potential of *Bacillus cereus* strains from Norwegian dairies. *Int. J. Food Microbiol.* 116, 292, 2007.
137. Te Giffel, M.C. et al. Isolation and characterization of *Bacillus cereus* from pasteurized milk in household refrigerators in the Netherland. *Int. J. Food Microbiol.* 34, 307, 1997.
138. Svensson, B. et al. Toxin production potential and detection of toxin genes among strains of the *Bacillus cereus* group isolated along the dairy production chain. *Int. Dairy J.* 17, 1201, 2007.
139. Svensson, B. et al. Occurrence of emetic toxin producing *Bacillus cereus* in dairy production chain. *Int. Dairy J.* 16, 740, 2006.
140. Callahan, J.H. et al. Detection, confirmation, and quantification of staphylococcal enterotoxin B in food matrixes using liquid chromatography-mass spectrometry. *Anal. Chem.* 78, 1789, 2006.

## *Chapter 34*

---

# Detection of Adulterations: Addition of Foreign Lipids and Proteins

---

Saskia M. van Ruth, Maria G. E. G. Bremer,  
and Rob Frankhuizen

### CONTENTS

34.1	General Introduction .....	720
34.1.1	Milk and Adulteration.....	720
34.1.2	Milk Products and Adulteration.....	720
34.1.3	Lipids, Proteins, and Authentication Testing.....	720
34.2	Lipids.....	721
34.2.1	Introduction .....	721
34.2.2	Authentication Testing .....	721
	34.2.2.1 Fatty Acid Analysis .....	721
	34.2.2.2 Triacylglycerol Analysis .....	723
34.3	Proteins.....	724
34.3.1	Introduction.....	724
34.3.2	Authentication Testing .....	724
	34.3.2.1 Immunoassays.....	724
	34.3.2.2 Mass Spectrometry .....	725
	34.3.2.3 Near-Infrared Spectroscopy .....	726
34.4	Conclusions .....	728
	References.....	729

## 34.1 General Introduction

Product authenticity and authentication are emerging topics in the food sector. It is a major concern not only for consumers, but also for producers and distributors. Regulatory authorities, food processors, retailers, and consumer groups are all interested in ensuring that foods are correctly labeled. Food adulteration has been practiced forever, but has become more sophisticated in the recent past. Foods or ingredients, most likely to be targets for adulteration, include those which are of high value and which undergo a number of processing steps before they appear on the market. With the European harmonization of the agricultural policy and the emergence of the international markets, authentication of such food products requires more attention. This trend is the result of efforts made by regional authorities, as well as producers to protect and support local productions [1].

### 34.1.1 *Milk and Adulteration*

Milk is a biologically complex fluid, constituted mainly of water, proteins, lactose, fat, and inorganic compounds. The majority of these substances have important nutritional and technological properties. According to its solubility at pH 4.6 and 20°C, the protein fraction can be divided into caseins that are insoluble at this pH, and whey proteins that are soluble. Caseins are, quantitatively, the most important protein components. This protein complex, known as a micelle, comprises four different caseins ( $\alpha_{s1}$ -,  $\alpha_{s2}$ -,  $\beta$ -, and  $\kappa$ -caseins) that are held together by noncovalent interactions, and appear as a highly stabilized dispersion in milk [2].

Adulteration of sheep's milk with cow's milk is relatively common owing to seasonal fluctuations of the availability of sheep's milk, the higher price of sheep's milk than cow's milk, and the opportunity to use the overproduction of cow's milk without loss of profit [3]. Consumers allergic to cow's milk may suffer severely if they ingest, e.g., ovine or caprine milk fraudulently extended with bovine milk or whey.

### 34.1.2 *Milk Products and Adulteration*

The quality of milk plays a very important role in the production of all types of cheeses, affecting both cheese yield and characteristics of the cheese. In regions with high production costs, agriculture must produce food of superior quality. The products can be labeled according to the specific conditions that characterize their origin and/or the processing technology. Animal feeding is one of the elements that are often considered as important by cheese-makers. The relationships between the origin of cheeses and the type of pasture have been extensively highlighted [4].

An example of a susceptible cheese product from an adulteration perspective is Italian Mozzarella. The seasonal increase in the market demand for Italian Mozzarella cheese occurring every summer and, on the other hand, the limited productions of buffalo milk may induce fraudulent addition of bovine milk during the manufacture of Mozzarella [5].

### 34.1.3 *Lipids, Proteins, and Authentication Testing*

The fat of milk is often regarded as superior to other fats, because of its sensory properties. Therefore, its adulteration has always been a serious problem because of the economic advantages taken by partly replacing the high-priced milk fat with low-priced fats without labeling the product accordingly.

Milk proteins are probably the best characterized of all the food proteins. However, the existence of genetic and nongenetic polymorphism as well as the application of technological treatments complicate their quantitative determination. Modifications such as heat denaturation or proteolysis, common in the manufacture of many dairy products, give rise to complex, insoluble, new compounds, and smaller peptides and amino acids, and their analysis is not easy to perform. In addition, information on the occurrence and amount of a particular protein or derived compound is extremely useful in the assessment of processing and adulterations [6].

Virtually, all components present in the complex physicochemical system of milk contribute information that is valuable for authentication testing. Traditional analytical strategies to uncover adulteration and guarantee quality have relied on wet chemistry to determine the amount of a marker compound or compounds in a suspected material and the subsequent univariate comparison of the value(s) obtained with those established for equivalent material of known provenance [7]. This approach suffers from a number of disadvantages, namely, the ever-increasing range of analytes that must be included in any test procedure and the limited knowledge of the range of each constituent in normal lots of the substance. Accordingly, these ranges may be expected to vary with the breed, feed, season, geographic source, dairy products processing procedure, etc. It is often not possible to make a definitive statement on the authenticity or otherwise of a material, even after its examination for a large suite of single marker compounds. Hence, there is a continuing demand for new, rapid, nondestructive, cost-efficient methods for direct quality measurements in food and food ingredients. Spectroscopic techniques, including the near-infrared (NIR), mid-infrared (MIR), front face fluorescence spectroscopy (FFFS), stable isotope, and nuclear magnetic resonance (NMR) have been examined to assess their suitability for the determination of the quality and/or geographical origins of dairy products [8]. This chapter presents a brief overview of the techniques for the detection of foreign lipids and proteins in milk and milk products. It includes some classical techniques, as well as some of the reported approaches adopted for the determination of the identity and quality of fats and proteins with application of a chemometric strategy.

## **34.2 Lipids**

### **34.2.1 Introduction**

Adulteration of butters has a history reaching back to ancient times. As early as in 1877, the bureau of the Leipzig Pharmaceutical Union, offered a prize of 800 marks for the discovery of a sure and practical method for the detection of adulteration of butter by other fatty substances [9]. In the following section, two widely applied approaches for the detection of milk fat adulteration are discussed. Alternatives to these techniques like differential scanning calorimetry, infrared (IR) spectroscopic techniques, proton-transfer reaction mass spectrometry (MS) were proposed, but have not yet found wide applications. These rapid techniques would be widely accepted, as they do not need lengthy sample preparations, have a high throughput, and are nondestructive testing methods.

### **34.2.2 Authentication Testing**

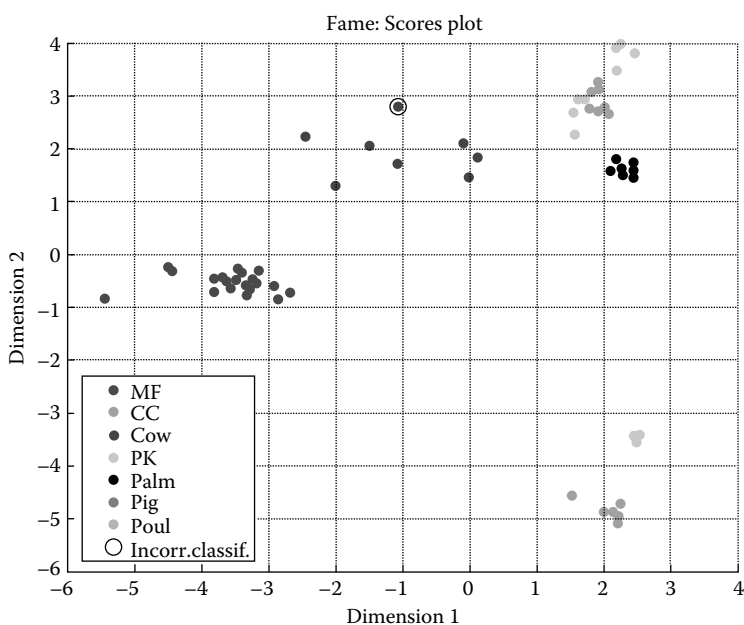
#### **34.2.2.1 Fatty Acid Analysis**

The fat of milk from all sources contains short-chain fatty acids, presumably because these are more easily absorbed by the young animal. The fatty acid profile is characteristic for each oil and

fat. It is influenced by several factors, such as breed, feeding, season, climate, geographical origin, and technological variables. The composition can be changed by refining and fat modifications like fractionation, hydrogenation, and interesterification. Furthermore, the fatty acid content has been modified over the years by using conventional methods of breeding [10]. Butyric acid (C4) is fairly the characteristic fatty acid of milk fat. Hence, methods for estimation of milk fat content have usually relied in some way on the amount of butyric acid (C4). This was initially by means of the Reichert value, where the water-soluble/steam-distillable acids are determined. Generally, the percentage of butyric acid present in milk fat is usually taken as about 3.6%. However, as the value can vary over a range (2.40%–4.22%, w/w [11]), this determination is of no use in finding the complete authenticity of the milk fat. Other traditional physicochemical methods to verify the authenticity of milk fat include the iodine value (a measure of the total unsaturation of a fat) or Polenske value (titrimetric determination of steam-volatile, but water-insoluble fatty acids). Unfortunately, these univariate, relatively simple methods are successful only in detecting massive adulteration of milk fat or even its substitution by another fat. James and Martin first determined the extended fatty acid composition of milk by packed column gas chromatography (GC) in 1956 [12]. The packed column GC was later replaced by capillary GC. The main problem concerning butter analysis is the reliable determination of the short-chain fatty acids (C4–C8), and this problem is more pronounced when split injection is used.

Multiple fatty acid analysis of a fat is nowadays a relatively routine analytical procedure. After methylation of the fat using reaction with boron trifluoride/methanol, boron trichloride/methanol, methanolic hydrogen chloride solution, diazomethane, or, if free fatty acids are not present, alkaline catalysts such as sodium methoxide/methanol, the prepared methyl esters are analyzed by GC on a polar column. The high polarity of the column is required to completely separate the saturated and unsaturated fatty acids. Milk fat does have a very characteristic fatty acid composition, and contains about 15 major fatty acids and several hundred minor fatty acids [13]. One might think that this would mean that authentication would be relatively easy from just the fatty acid composition. However, the fatty acid composition is not just complicated, but is also very variable.

Fatty acid compositions can be compared with univariate purity criteria specified by the FAO/WHO Codex Committee on Fats and Oils [14]. The admixture of a certain amount of foreign fat with a high concentration of a particular fatty acid in its spectrum would shift the concerned fatty acid out of the range, which is normally encountered in the genuine fat or oil. To increase the sensitivity of the fatty acid approach for the purity testing of milk fat various ratios of different fatty acids have been proposed as authenticity criteria. Antonelli et al. [15] suggested the use of the fatty acids, butyric acid and enanthic acid, for butter authentication in concentrated butters (butter oils). By using a combination of four fatty acid ratios ( $C18:0/C8:0 < 7.63$ ;  $C14:0/C18:0 > 1.02$ ,  $(C6:0 + C8:0 + C10:0 + C12:0)/C18:0 > 0.95$ ;  $C18:1/C18:0 < 2.34$  for genuine milk fat), the detection of an addition of 10% beef suet to milk fat was possible. Furthermore, differentiation of milk fat from different species based on fatty acid profiling is also possible. The ratio of C14:1/C15:0 is 1.00 in cow's milk fat while it is 0.20 in sheep [16]. Instead of using a univariate approach, the information content of the total fatty acid can be more efficiently explored by multivariate data analysis [17]. The art of extracting chemically relevant information from the data produced in chemical experiments by means of statistical and mathematical tools is called chemometrics. It is an indirect approach to the study of the effects of multivariate factors and hidden patterns in complex data sets. Chemometrics is routinely used for: (a) exploring patterns of association in data, and (b) preparing and using multivariate classification models. A partial least square-discriminant analysis (PLS-DA) plot (Figure 34.1) of the first two dimensions of a four-component model,



**Figure 34.1** Scores plot of the first two dimensions of PLS-DA on the fatty acid composition data of milk fat (MF) and six other fats and oils.

predicting the identity of a variety of animal fats and vegetable oils (including milk fat) by their fatty acid compositions illustrates this approach. This multivariate approach adopted by the authors shows that the milk fats are fairly separated from the other fats and oils, with beef tallow most closely positioned in the proximity of the milk fats.

#### 34.2.2.2 *Triacylglycerol Analysis*

When it was discovered that extreme variations of composition precluded the use of univariate fatty acid analysis for milk fat authentication, the possibility of analysis of whole triglycerides (TGs) was investigated. TGs are more difficult to separate and analyze satisfactorily by GC, owing to their high molecular weight and corresponding volatility. TG composition, as determined by measuring the carbon numbers of the TG fraction, is affected by many of the same factors as is fatty acid composition. Early attempts to detect certain foreign fats from TG analyses using regression procedures could theoretically detect the levels of 4%–7% of some oils, but could not handle mixtures [18]. Precht [19] subsequently developed a formula for detection of some adulterations in milk fat based on TG composition analysis. Pure milk was characterized by the presence of C40, C42, and C44 TGs. Again, the formula was limited to some potential adulterants and mixtures which increased the detection levels considerably. Furthermore, alternative computational models applied were equally effective [20].

Milk fat TGs can also be analyzed by other techniques. The application of high-performance liquid chromatography (HPLC) in normal and reversed-phase mode, thin-layer chromatography, and supercritical chromatography have been reported. Detection systems include ultraviolet (UV), refractive index (RI), and evaporative light-scattering detector (ELSD). The major advantage

of HPLC is that it is possible to separate TGs at ambient or slightly elevated temperatures, thereby obviating thermal stress on thermolabile long-chain polyunsaturated TGs. However, high-molecular mass TGs are not easy to elute from HPLC columns owing to their insolubility in a number of popular mobile phases. A further disadvantage is that commonly available HPLC detectors are only compatible with isocratic elution, or the detector response is influenced by the unsaturation of the separated substances which renders quantification unreliable. Today, GC using capillary columns coated with high-temperature polarizable phenylmethylsilicone stationary phases has been shown to be as effective as the other techniques. In comparison with HPLC, capillary GC yields higher resolution. However, to date, complete resolution of any molecular species is not attainable, neither by GC nor by HPLC. A combination of complementary chromatographic techniques would therefore be required to elucidate the entire TG pattern of milk fat [21].

## **34.3 Proteins**

### **34.3.1 Introduction**

For unethical farmers and dairy manufacturers, it may be attractive to adulterate high-priced milk products with less expensive protein sources, such as the low-priced soy, pea and soluble wheat proteins (SWPs), and bovine rennet whey (BRW). The latter is a low-priced by-product obtained during cheese production [22]. As mentioned earlier, apart from the economical/quality loss, adulteration of dairy products with other proteins can cause severe problems for allergic individuals as they are inadvertently exposed to allergenic proteins. Furthermore, when applied to feed, change in protein composition may affect digestibility. Therefore, detection methods for milk product adulteration which can be routinely employed by food/feed control authorities and food/feed processors are required. Several protein-targeted methods have been developed based on sodium dodecyl sulfate polyacrylamide gel electrophoresis (SDS-PAGE), capillary zone electrophoresis, colorimetry, chromatography, immunoassays and immunoblotting, biosensors, near-infrared spectroscopy (NIRS), and more recently MS. Immunoassays, MS, and NIRS will be described in greater detail in the following sections.

### **34.3.2 Authentication Testing**

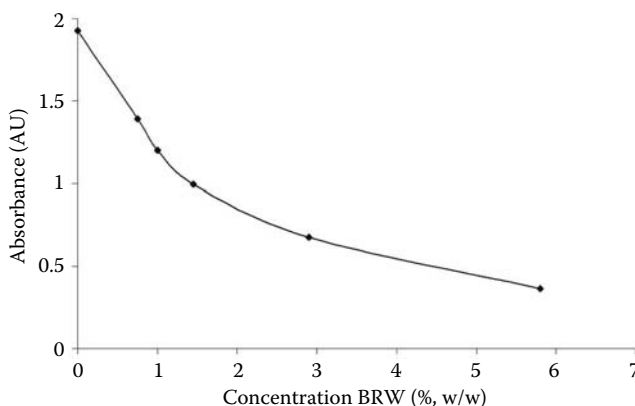
#### **34.3.2.1 Immunoassays**

In an immunoassay, the detection of a target molecule (antigen) is based on the specific antigen–antibody binding. The applied antibodies, Y-shaped 150 kDa proteins containing two antigen-binding sites, must possess high affinity and selectivity for the antigen to allow the detection of trace amounts of the antigen and to avoid false-positive test results, especially in complex matrices like dairy products. Nowadays, different immunoassay formats are available; classical formats like enzyme-linked immunosorbent assays (ELISA) and lateral flow devices (LFDs), and novel formats like biosensors and microsphere-based flow cytometric systems. The classical methods are relatively inexpensive, fast for small (LFDs) or large numbers of samples (ELISA), and easy-to-use without the need of expensive equipment. However, with these methods, only one target molecule can be detected simultaneously. Although biosensors and microsphere-based flow cytometric systems require relatively costly equipment (most of) these methods have the major advantage of the fact that they can detect several target molecules simultaneously. Furthermore, these new methods are time-efficient with sample analysis duration of a few minutes only.

For the detection of species adulteration, ELISA and biosensor applications based on the detection of caseins, whey proteins, or immunoglobulin G have been reported [23–25]. In addition, commercial immunoassays are also available (e.g., R-Biopharm AG, Darmstadt, Germany). For the detection of plant proteins in milk (powders), only an immunoblotting procedure [26], an ELISA [27], a biosensor application [28], and recently, a microsphere-based flow cytometric system [29], have been described. Both biosensor and microsphere-based methods can detect proteins from three different plants simultaneously. Until recently, only two biosensor immunoassays had been described for the immunochemical detection of the adulteration of milk powders with rennet whey [22,25]. Recent developments include a strip test (Operon S.A., Zaragoza, Spain) for the detection of BRW in milk and milk powders. Other new developments include an inhibition ELISA [30], reported by the authors recently. The inhibition ELISA is suitable for the detection of BRW in milk and milk powders with a detection limit of 0.1% (w/w), using a monoclonal antibody that recognizes caseinomacropptide (CMP) as a marker. The signal (absorbance) is inversely proportional to the CMP concentration in the sample. The CMP concentrations are calibrated against standards of known BRW concentrations. A typical calibration curve is shown in Figure 34.2.

#### 34.3.2.2 Mass Spectrometry

MS is an analytical technique used for the identification of analytes based on the accurate measurement of their molecular masses. Ionized analytes, produced in the ionization source of the mass spectrometer, are separated by their mass-to-charge ratio ( $m/z$ ). In a mass spectrum, the  $m/z$  values are plotted against their intensities to reveal the different (ionizable) components in the sample and their molecular masses. In general, proteins and peptides are ionized by electrospray ionization (ESI) and matrix-assisted laser desorption ionization (MALDI). These methods are “soft” ionization methods indicating that fragmentation of the protein or peptide ions scarcely occur, enabling the mass measurement of intact proteins and peptides. MALDI time-of-flight (TOF) MS is fast and relatively easy-to-use. However, online coupling to sample pretreatment and separation techniques is still a challenge. ESI-MS, on the other hand, can be conveniently coupled with liquid chromatography (LC), which greatly improves the quality of the spectra.



**Figure 34.2** Calibration curve of BRW powder in milk powder obtained with inhibition ELISA.



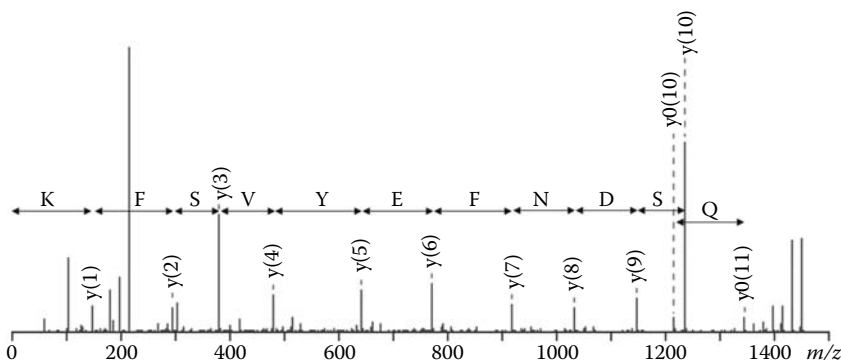
To obtain amino acid sequence information of peptides and proteins, after enzymatic digestion of proteins, tandem mass spectrometry (MS/MS) is used. Inside the mass spectrometer, the peptide ions are fragmented and the  $m/z$  values of the fragments are plotted in the MS/MS spectra. These spectra are compared with a spectra database and the amino acid sequence is confirmed when a good match between the measured and theoretical spectra is obtained.

In the field of dairy adulterations, MALDI-TOF MS has been used to identify the presence of cow's milk in ewe and water-buffalo milk, as well as in cheeses. Identification is based on the protein profiles of the samples [31] or the use of  $\alpha$ -lactalbumin and  $\beta$ -lactoglobulin as molecular markers [32,33]. However, Chen et al. [34] presented a more specific high-performance HPLC-ESI-MS method. The bovine milk protein identification procedure is based on the use of both retention time and molecular mass derived from multiple charged molecular ions. Furthermore, an HPLC-ESI/MS method was also developed for the detection of rennet whey in "traditional butter" based on the monitoring of two multicharged ions [35]. For a similar application, the detection of rennet whey in dairy powders, a more specific LC-ESI MS/MS method has been reported, which is based on the measurement of the fixed transition from a precursor ion (a specific CMP fragment) to a product ion [36].

For the identification of plant proteins in milk powder, a technique based on the determination of the amino acid sequence of the plant proteins by nano-LC ESI MS/MS has been developed [37]. Plant proteins are concentrated using a borate buffer and are subsequently digested with trypsin. The peptide mixture is analyzed using LC coupled with a quadrupole (Q) TOF MS instrument. Subsequently, the obtained tandem mass spectra are matched with those included in the National Center for Biotechnology Information (NCBI) database for identification purposes. An example of a tandem mass spectrum is shown in Figure 34.3.

### 34.3.2.3 Near-Infrared Spectroscopy

The IR is based on the concept of specific frequency vibration of atom-to-atom bonds within the molecules. Therefore, mid-IR absorption peaks are unique for specific bond pairs in a particular molecular environment. NIRS is based on the molecular overtone and combination vibrations of the fundamental vibrations occurring in the mid-IR region. Several molecular bonds (O-H in



**Figure 34.3** Tandem mass spectra of soy peptide SQSDNFEYVSFK. The corresponding amino acids are indicated.

water, C–H in carbohydrates and oils, and N–H in proteins) absorb NIR light (1100–2500 nm) at well-defined wavelengths. The absorbance level at these specific wavelengths is generally proportional to the quantity of that constituent in the material [38].

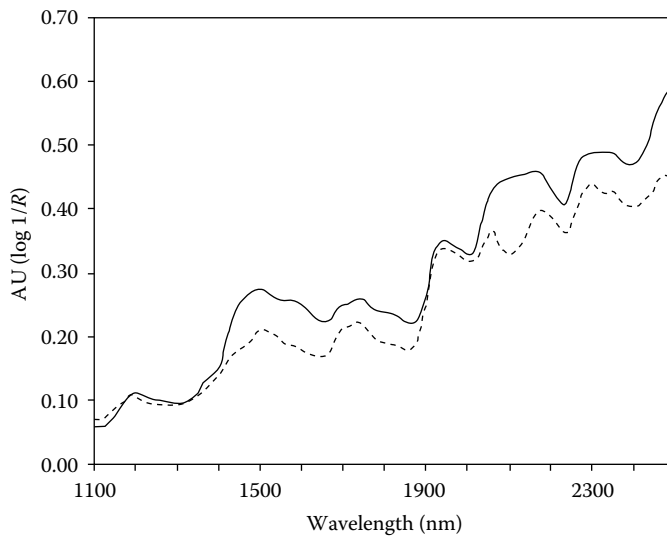
An advantage of NIR light is that it can be transmitted through a reasonably thick sample as the molar absorptivity in the NIR region is quite small. Such diffuse transmittance measurements have particularly proven to be useful in the analysis of liquids, slurries, suspensions, and pastes [39]. On the contrary, NIR absorption bands also often overlap and are strongly influenced by light-scattering effects. The latter is mainly caused by solid particles in a sample. Food materials are organically complex and are present in a multiplicity of physical forms. The complexity of the factors determining NIR spectra demand the use of mathematical models for NIRS data interpretation.

In combination with multiple linear regression (MLR) analysis, the NIRS technique was applied for the quantification of major food components in dairy products, as early as in the 1980s [40]. The NIRS spectra were calibrated against the data obtained by classical wet chemistry procedures. Precision of NIRS in this type of application is limited to a great extent to the precision of the reference methods used for calibration. The representativeness of the calibration sample sets is fairly challenging, which is partly owing to the sample preparation issues. Particle size, homogeneity, temperature, and presentation of the sample require standardization. From the calibration sets, regression equations can be generated to determine the major constituents of milk, milk powder, casein, butter, and cheese with an accuracy similar to that obtained with the wet chemistry methods [41].

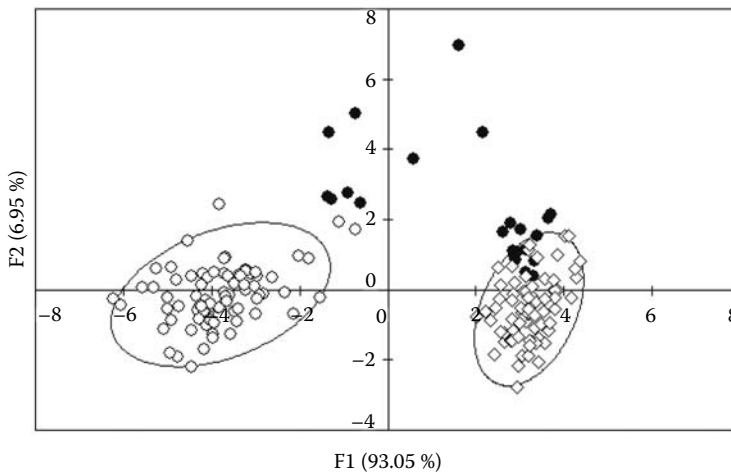
With the development of chemometrics, NIRS has received more scientific attention and has generally become more popular [42]. Over the last few years, many NIRS applications in the dairy field, including online applications, have been reported [43–50]. In 2006, the International Organization for Standardization (ISO) and the International Dairy Federation (IDF) jointly published an International Guidance for the application of NIRS to milk product analysis [51].

For authentication purposes, the full NIR spectral data set needs to be considered, as plant and milk protein spectra differ considerably (Figure 34.4). Multivariate data analysis techniques, such as PLS analysis, are employed to enable the complete use of the spectral data. DA and spectral matching methods are applied for discrimination the products that differ considerably, whereas principle component analysis (PCA) is used for spectral identification and differentiation of fairly similar products [52,53]. For detailed comparison of the spectra for the detection of adulterations, multivariate classification models have been established from the full spectra of training sets, considering the natural and processing-induced variance. The identity and authenticity of an unknown sample can subsequently be established in a single analysis by comparing their NIR fingerprint spectra with the collection of NIR spectra of training samples. An example of a plot of the first two dimensions of a PLS-DA model based on NIR spectra of pure skimmed milk powder and butter milk powder, predicting the identity of the samples is presented in Figure 34.5. When samples appear out of the range compared with their unadulterated counterparts, additional analyses can be carried out to determine the identity of the suspicious sample.

If the identity is determined, then a unique “databank” can be constructed which can be used with increasing certainty to authenticate the dairy products. Comprehensive descriptions and references on spectra–structure correlations and additional technical details of applications for NIR spectra have been reported extensively [54–58]. NIR continues to provide a valuable measurement technique, applicable to both quantification and identification of dairy products, for use as a control technique, as well as a real-time process-monitoring technique.



**Figure 34.4** Typical NIR absorbance spectra of skimmed milk powder (—) and soy powder (---) displayed in  $\log(1/R)$  form.



**Figure 34.5** Discriminant plot determined by discriminant factors 1 (F1) and 2 (F2) for calibration sets of skimmed milk powder (◊) and butter milk powder (○), and the scores of 16 suspicious samples (●). Five samples lie outside both the databases with 99% confidence limit and are highly suspected.

## 34.4 Conclusions

The brief overview on techniques being applied for the detection of foreign lipids and proteins in dairy products illustrates the complex task encountered in authentication. Approximately a few hundred of the thousands of chemical compounds identified in dairy products are used in

the authentication process. Although single analyte methods are suitable for particular purposes, the ultimate solution may be rather sought in a multivariate approach, combining information of several analytes in a multidimensional space.

## References

1. Karoui, R., Mazerolles, G., and Dufour, E., Spectroscopic techniques coupled with chemometric tools for structure and texture determinations in dairy products: A review, *Int. Dairy J.*, 13, 607, 2003.
2. Ausar, S.F. et al., Characterization of casein micelle precipitation by chitosans, *J. Dairy Sci.*, 84, 361, 2001.
3. Colak, H. et al., Detection of presence of cow's milk in sheep's cheeses by immunochromatography, *Food Control*, 17, 905, 2006.
4. Bosset, J.O. et al., Comparison of some highland and lowland Gruyère type cheese of Switzerland: A study of their potential PDO/AOC/AOP characteristics. Authenticity and adulteration of food—the analytical approach, *Proc. Eur. Food Chem.*, 220, 395, 1999.
5. Enne, G. et al., High-performance liquid chromatography of governing liquid to detect illegal bovine milk's addition in water buffalo Mozzarella: Comparison with results from raw milk and cheese matrix, *J. Chromatogr. A*, 1094, 169, 2005.
6. Recio, I., Amigo, L., and López-Fandiño, R., Assessment of the quality of dairy products by capillary electrophoresis of milk proteins, *J. Chromatogr. B*, 697, 231, 1997.
7. Downey, G., Authentication of food and food ingredients by near infrared spectroscopy, *J. Near Infrared Spectrosc.*, 4, 47, 1996.
8. Karoui, R. and De Baerdemaeker, J., A review of analytical methods coupled with chemometric tools for the determination of the quality and identity of dairy products, *Food Chem.*, 102, 621, 2007.
9. Prize for a method of detecting adulterations of butter, *Dingler's Polytech. J.*, 2, 223, 1877.
10. Kamm, W. et al., Authenticity assessment of fats and oils, *Food Rev. Int.*, 17, 249, 2001.
11. Jee, M., Milk fat and other animal fats, in *Oils and Fats Authentication*, Jee, M., ed., CRC Press, Boca Raton, FL, 2002, 115.
12. James, A.T. and Martin, A.J.P., Gas-liquid chromatography: The separation and identification of the methyl esters of saturated and unsaturated acids from formic acid to n-octadecanoic acid, *Biochem. J.*, 63, 144, 1956.
13. Hettinga, D., Butter, in *Bailey's Industrial Oil and Fat Products*, 5th edn., Hui, Y.H., ed., Wiley and Sons, New York, 1996, p. 1.
14. Codex Alimentarius Commission, Report of the Fourteenth Session of the Codex Committee on Fats and Oils, *Alinorm 95/17*, FAO/WHO, Rome, 1995.
15. Antonelli, A., Conte, L.S., and Lercker, G., Applications of capillary gas chromatography to the quality control of butter and related products, *J. Chromatogr.*, 552, 273, 1991.
16. Matter, L. et al., Characterization of animal fats via the GC patterns of FAME mixtures obtained by transesterification of the triglycerides, *Chromatographia*, 27, 31, 1989.
17. van Ruth, S.M. et al., Prediction of the identity of fats and oils by their fatty acid, triacylglycerol and volatile compositions using PLS-DA, *Food Chem.*, submitted.
18. Lercker, G. et al., Milk fat. Gas chromatographic analysis of triglycerides in assessment of authenticity of butter, *Scienza Tecnica Lattiero Casearia*, 43, 95, 1992.
19. Precht, D., Detection of foreign fat in milk fat, I. Qualitative detection by triacylglycerol formulae, *Z. Lebensm. Unters. Forsch.*, 194, 1, 1992.
20. Lipp, M., Determination of the adulteration of butter fat by its triglyceride composition obtained by GC. A comparison of the suitability of PLS and neural networks, *Food Chem.*, 55, 389, 1996.
21. Buchgraber, M. et al., Triacylglycerol profiling by using chromatographic techniques, *Eur. J. Lipid Sci. Technol.*, 106, 621, 2004.

22. Haasnoot, W., Detection of adulterants in milk products, *Biacore J.*, 5, 12, 2005.
23. Haasnoot, W. et al., Fast biosensor immunoassay for the detection of cows' milk in the milk of ewes and goats, *J. Dairy Res.*, 71, 322, 2004.
24. Hurley, I.P. et al., Application of immunological methods for the detection of species adulteration in dairy products, *Int. J. Food Sc. Technol.*, 39, 873, 2004.
25. Haasnoot, W., Marchesini, G.R., and Koopal, K., Spreeta-based biosensor immunoassay to detect fraudulent adulteration in milk and milk powder, *J. AOAC Int.*, 89, 849, 2006.
26. Ventling, B. and Hurley, W.L., Soy protein in milk replacers identified by immunoblotting, *J. Food Sci.*, 54, 766, 1988.
27. Hewedy, M.M. and Smith, C.J., Modified immunoassay for the detection of soy milk in pasteurized skimmed bovine milk, *Food Hydrocolloids*, 3, 485, 1990.
28. Haasnoot, W. et al., Direct biosensor immunoassay for the detection of nonmilk proteins in milk powder, *J. Agric. Food Chem.*, 49, 5201, 2001.
29. Haasnoot W. and Du Pré, J.G., Luminex-based triplex immunoassay for the simultaneous detection of soy, pea, and soluble wheat proteins in milk powder, *J. Agric. Food Chem.*, 55, 3771, 2007.
30. Bremer, M.G.E.G. et al., Enzyme-linked-immunosorbent-assay for the detection of bovine rennet whey powder in milk powder and buttermilk powder, *Int. Dairy J.*, 18, 294, 2008.
31. Fanton, C. et al., Matrix-assisted laser desorption/ionization mass spectrometry in the dairy industry. 2. The protein fingerprint of ewe cheese and its application to detection of adulteration by bovine milk, *Rapid Commun. Mass Spectrom.*, 12, 1569, 1998.
32. Cozzolino, R. et al., Identification of adulteration in milk by matrix-assisted laser desorption/ionization time-of-flight mass spectrometry, *J. Mass Spectrom.*, 36, 1031, 2001.
33. Cozzolino, R. et al., Identification of adulteration in water buffalo mozzarella and in ewe cheese by using whey proteins as biomarkers and by matrix-assisted laser desorption/ionization mass spectrometry, *J. Mass Spectrom.*, 37, 985, 2002.
34. Chen, R.-K. et al., Quantification of cow milk adulteration in goat milk using high-performance liquid chromatography with electrospray ionization mass spectrometry, *Rapid Commun. Mass Spectrom.*, 18, 1167, 2004.
35. De Noni, I. and Resmini, P., Identification of rennet-whey solids in "traditional butter" by means of HPLC/ESI-MS of non-glycosylated caseinomacropeptide A, *Food Chem.*, 93, 65, 2005.
36. Mollé, D. and Léonil, J., Quantitative determination of bovine k-casein macropeptide in dairy products by liquid chromatography/electrospray coupled to mass spectrometry (LC-ESI/MS) and liquid chromatography/electrospray coupled to tandem mass spectrometry (LC-ESI/MS/MS), *Int. Dairy J.*, 15, 419, 2005.
37. Luykx, D.M.A.M. et al., Identification of plant proteins in adulterated skimmed milk powder by high-performance liquid chromatography-mass spectrometry, *J. Chromatogr. A*, 1164, 189, 2007.
38. Stark, E., Luchter, K., and Margoshes, M., Near-infrared analysis (NIRA): A technology for quantitative and qualitative analysis, *Appl. Spectrosc.*, 22, 335, 1986.
39. Davies, A.M.C. and Grant, A., Near-infrared analysis of food, *Int. J. Food Sci. Technol.*, 22, 191, 1987.
40. Frankhuizen, R. and Veen van der, N.G., Determination of major and minor constituents in milk powders and cheese by near-infrared reflectance spectroscopy, *Neth. Milk Dairy J.*, 39, 191, 1985.
41. Frankhuizen, R., NIR analysis of dairy products, in *Handbook of Near-Infrared Analysis*, 2nd edn., Burns, D.A. and Ciurczak, E.W., eds., Marcel Dekker Inc., New York, 2001, Chapter 18.
42. Cen, H. and He, Y., Theory and application of near infrared reflectance spectroscopy in determination of food quality, *Trends Food Sci. Technol.*, 18, 72, 2007.
43. Rodriguez-Otero, J.L. et al., Determination of fat, protein and total solids in cheese by near-infrared reflectance spectroscopy, *J. AOAC Int.*, 78, 802, 1995.
44. Sørensen, L.K. and Jepsen, R., Detection of cheese batches exposed to clostrium tyrobutyricum spoilage by near infrared spectroscopy, *J. Near Infrared Spectrosc.*, 5, 91, 1997.

45. Laporte, M.F. and Paquin, P., Near-infrared analysis of fat, protein and casein in cow's milk, *J. Agric. Food Chem.*, 47, 2600, 1999.
46. Reeves, J.B. and Kessel van, J.S., Determination of ammonium-N, moisture, total C and total N in dairy manures using a near infrared fibre-optic spectrometer, *J. Near Infrared Spectrosc.*, 8, 151, 2000.
47. Blazquez, C. et al., Prediction of moisture, fat and inorganic salts in processed cheese by near infrared reflectance spectroscopy and multivariate data analysis, *J. Near Infrared Spectrosc.*, 12, 149, 2004.
48. Sinelli, N. et al., A preliminary study using Fourier transform near infrared spectroscopy to monitor the shelf-life of packed industrial ricotta cheese, *J. Near Infrared Spectrosc.*, 13, 293, 2005.
49. Feten, G. et al., Using NIR spectroscopy for the prediction of free amino acids during cheese ripening, *NIR News*, 18, 4, 2007.
50. Frankhuizen, R., Cruijssen, J.M.M., and Kok, H.L., On-line determination of moisture content during cheese processing, in *Book of Abstracts, Fourth International Workshop on Water in Food*, Bernreuther, A., ed., EC-DG JRC-IRMM, Brussels, 2006, 59.
51. Milk products—Determination of total solids, fat, protein and moisture contents—Guidance for the application of near infrared spectrometry, *ISO21543/IDF210*, 2006.
52. Martens, H. and Naes, T., *Multivariate Calibration*, John Wiley and Sons, Chichester, 1992, 1.
53. Mark, H. and Workman, J., *Statistics in Spectroscopy*, 2nd edn., Elsevier, Amsterdam, 2003, 1.
54. Weyer, L.G. and Lo, S.-C., Spectra-structure correlations in the near-infrared, in *Handbook of Vibrational Spectroscopy*, vol. 3, Chalmers, J.H. and Griffiths, P.R., eds., Wiley and Sons, New York, 2002, 1817.
55. Maraboli, A., Cattanea, T.M.O., and Giangiacomo, R., Detection of vegetable proteins from soy, pea and wheat isolates in milk powder by near infrared spectroscopy, *J. Near Infrared Spectrosc.*, 10, 63, 2002.
56. Pillonel, L. et al., Cheese Authenticity. Determining the geographic origin of emmental cheese, *NIR News*, 15, 14, 2004.
57. Tsenkova, R. et al., Near infrared spectra of cow's milk for milk quality evaluation: Disease diagnosis and pathogen identification, *J. Near Infrared Spectrosc.*, 14, 363, 2006.
58. Mouazen, A.M. et al., Feasibility study on using visible-near infrared spectroscopy coupled with a factorial discriminant analysis technique to identify sheep milk from different genotypes and feeding systems, *J. Near Infrared Spectrosc.*, 15, 359, 2007.



## *Chapter 35*

---

# Detection of Adulterations: Identification of Milk Origin

---

Golfo Moatsou

### CONTENTS

35.1	Introduction.....	733
35.2	Methods of Detection Based on Proteins .....	734
35.2.1	Electrophoretic Methods .....	734
35.2.1.1	Caseins.....	734
35.2.1.2	Whey Proteins .....	736
35.2.2	Chromatographic Methods .....	737
35.2.2.1	Caseins .....	737
35.2.2.2	Whey Proteins.....	737
35.2.3	Antibody-Based Analytical Methods.....	738
35.3	Methods of Detection Based on Milk Fat .....	742
35.4	DNA-Based Methods of Detection—Species-Specific PCR .....	742
	References.....	748

### 35.1 Introduction

The use of a nondeclared milk type in the manufacture of dairy products is characterized as a fraud. The most common practice is the partial or total substitution of a milk kind by another of lower commercial value. The adulteration of cheesemilk, related to both cheese quality and legal requirements, is a rather frequent problem. The increased demand for genuine and accurately labeled traditional products necessitates the protection against adulteration. Moreover, adulteration may affect the health of consumers with nondeclared allergic problems. Traditional cheeses



produced in the Mediterranean countries accepted by consumers worldwide, e.g., Feta, Manchego, and Pecorino, are made from ovine milk or from its mixtures with caprine milk. The composition of cheesemilk affects the characteristics and the organoleptic properties of the final product. The seasonal production and the higher prices of caprine milk, especially of the ovine milk, than the bovine milk are the main reasons for the admixture of cheesemilk with bovine milk. In addition, the existence of mixed flocks of goats and ewes can result in the accidental or fraudulent substitution of ovine milk by caprine. Fraudulent addition of bovine milk also occurs during the manufacture of “Mozzarella di Bufala” cheese that is normally made from raw water-buffalo milk. Cheesemilk adulteration is carried out using raw milk, heated, condensed milk, milk powder, or caseinates from milk kinds that are not declared on the product label.

The confirmation of the milk kinds used for the manufacture of dairy products and the determination of their relative percentages is based on milk components. The objective of the analytical methods used for this purpose is the detection of substances or the determination of abnormalities in the composition which cannot be assigned to any of the materials used during the manufacture of dairy products. Detection is based on milk constituents (protein, fat) or on DNA from the somatic-cell content of the milk. The analytical methods for the identification of milk origin in dairy products have been reviewed by Ramos and Juárez [1], and more recently by De la Fuente and Juárez [2]. There are also reviews regarding the immunological techniques [3,4] and polymerase chain reaction (PCR) techniques [5].

## 35.2 Methods of Detection Based on Proteins

Milk proteins are the basis of many analytical methods that have been applied successfully for the detection of adulteration. The objective of analyses is the separation and the subsequent detection and quantification of a homologous protein fraction from different milk kinds. Casein and whey proteins are analyzed for this purpose. It has to be taken into consideration that during cheese-making, a great part of whey proteins is removed from the cheese curd with the whey. Moreover, the thermal treatments applied to cheesemilk or cheese curd may denature part of them (e.g., immunoglobulins). Therefore, casein seems to be more appropriate than whey proteins in terms of the detection of cheesemilk adulteration. However, whey proteins are tolerant to hydrolysis during ripening. In addition, heat treatments applied in cheesemilk, usually lower than or equal to high-temperature short-time (HTST) pasteurization, do not affect them.

### 35.2.1 Electrophoretic Methods

#### 35.2.1.1 Caseins

Urea-polyacrylamide gel electrophoresis (PAGE) of milk caseins under alkaline conditions [6] is one of the oldest methods used for the detection of bovine milk in milk mixtures. Detection is based on the higher mobility of bovine  $\alpha_{s1}$ -casein than that of its ovine and caprine counterparts. It is a rather simple method, but its sensitivity is limited by the sensitivity of the staining techniques used for the visualization of protein bands. Urea-PAGE has been found appropriate for analyzing milk mixtures [7,8]. In the majority of cheese varieties,  $\alpha_{s1}$ -casein is hydrolyzed to a variety of smaller peptides during ripening, which are not retained in the polyacrylamide gel matrix. Therefore, this method is not always suitable for cheese fraud detection. It has been successfully applied in Halloumi cheese, a cheese variety with limited proteolysis [9]. More recently,

detection of the rather high percentages of 10% and 20% of bovine milk in ovine-milk cheeses by urea-PAGE has been reported [10]. Among the casein fractions of cheese, para- $\kappa$ -casein seems to be the most advantageous for the detection of cheesemilk origin, because it is not affected substantially by proteolysis during cheese ripening. However, the differences among the amino acid sequences of ovine, caprine, and bovine para- $\kappa$ -caseins are rather limited. Cationic PAGE of para- $\kappa$ -casein has been used for the detection and determination of bovine milk in ovine yoghurt after the treatment of yoghurt caseins with rennet. A detection limit of 1% of bovine milk has been reported [11].

Isoelectric focusing (IEF) methods have been proposed since 1986 for the detection of milk kind, especially for the detection of cheesemilk adulteration [12–14]. IEF of  $\gamma$ -caseins resulting from the hydrolysis of paracasein fraction of milk or cheese with plasmin is the basis of the official reference method of European communities, for the detection of bovine milk or caseinates in ovine and caprine milk products [15]. Detection is based on the different focusing points of bovine  $\gamma_2$ - and  $\gamma_3$ -caseins when compared with their ovine and caprine counterparts. Standard samples with 0% and 1% bovine milk are analyzed simultaneously with the unknown samples. The quantification of bovine milk is based on the intensity of  $\gamma_2$ - and  $\gamma_3$ -casein bands when compared with the respective bands of the standard samples. The method is sensitive and appropriate for cheese, as it is not affected by the thermal treatment of milk or cheese curd and by the extent of proteolysis. However, it cannot detect mixtures of ovine and caprine milk. Moreover, it is not accurate in quantitative terms, when the adulteration level is high, because there are declinations as the band intensity increases. The detection of  $\gamma$ -caseins and peptides along the IEF profiles using immunoblotting with polyclonal antibodies against  $\beta$ -casein has also been reported [16,17]. IEF of para- $\kappa$ -casein for the detection of ovine, caprine, and bovine protein in the cheesemilk was first used by Addeo et al., and it has also been applied in model cheeses [8,12,13,18]. In general, this method has been found suitable for the detection of bovine para- $\kappa$ -casein in hard-pressed and young mold-ripened cheeses. However, a peptide with  $pI$  similar to that of bovine para- $\kappa$ -casein in matured cheese profiles can cause false-positive results in Roquefort cheese. Moreover, a band with  $pI$  similar to caprine para- $\kappa$ -casein has been detected within the profile of ovine cheese. Therefore, IEF of para- $\kappa$ -casein has not been found suitable for the detection of small quantities of either ovine or caprine para- $\kappa$ -casein, but it could be used for the estimation of high percentages of adulteration (i.e., >10% of goat milk).

Capillary zone electrophoresis (CZE) has been extensively used since 1990. It is a rather fast, sensitive, and easily operated method used for the separation of casein fraction of both milk and cheese [19,20]. Following the studies about casein fraction and milk-protein polymorphism, and taking into consideration the different migration times of  $\alpha_{s1}$ -casein of different milk kinds [21,22], the presence of up to 8% of bovine casein in milk mixtures has been detected [23]. The detection limit has been effectively improved up to 1% of bovine milk in caprine milk by means of an uncoated capillary tube [24]. Identification and quantitative determination of milk kind in binary and ternary mixtures based on particular predictor variables, i.e., the peak areas of bovine and ovine  $\alpha_{s1}$ -casein, bovine, ovine and caprine  $\kappa$ -casein, bovine  $\beta$ -casein A1 and A2, and ovine and caprine  $\beta_1$ - and  $\beta_2$ -casein, has been reported [25]. This approach involves the principle component regression and partial least-squares regression with the mean square errors in prediction being <2.4% in all the cases. Characteristic capillary electrophoresis (CE) patterns of cheese from ovine, caprine, and bovine milk have been presented, considering the peaks of caprine para- $\kappa$ -casein and bovine  $\beta$ -casein as indicatives of the milk kind [26].

The quantification of  $\beta$ -lactoglobulin and para- $\kappa$ -casein in the capillary electropherograms has been related to the determination of milk origin in fresh cheeses [27]. Caprine para- $\kappa$ -casein and

bovine  $\alpha_{s1}$ -casein peaks have been used to detect caprine and/or bovine milk in ovine Halloumi cheese. The detection limit has been found to be 2% and 5% for caprine and bovine milk, respectively, by means of stepwise multiple linear regression analysis [28]. Similarly, multivariate statistical techniques have been utilized for the prediction of the percentages of ternary mixtures of bovine, ovine, and caprine milk using the areas of 13 selected peaks of the capillary electropherograms of an unripened cheese; the root square error has been estimated at 2.2% [29]. De la Fuente and Juárez [2] suggested that instrumental developments such as mass spectrometry (MS) detection and new injection devices will improve the performance of the CE technique.

### 35.2.1.2 *Whey Proteins*

Native PAGE of whey protein fraction has been found suitable for the detection of 10%–40% bovine milk in ovine or caprine milk submitted to thermal treatment commonly used in cheesemaking, i.e., at 74°C for 30 s [30]. The detection has been based on the greater electrophoretic mobility of bovine  $\beta$ -lactoglobulin when compared with that of ovine  $\beta$ -lactoglobulin. Native PAGE of whey proteins has also been used for the differentiation of bovine, ovine, caprine, and mare milk [8]. Technological parameters of cheesemaking, such as type of rennet, pressing, and ripening time have not interfered with the detection of bovine milk in ovine Machengo, Roquefort, and Serra da Estrella cheeses [31,32]. Stepwise multiple linear regression and principle components regression applied to the results of PAGE analysis of cheese whey fraction have been used for the prediction of the percentages of ovine, caprine, and bovine cheesemilk [33]. The addition of 1% ultrahigh temperature (UHT) bovine milk or heat-denatured bovine whey proteins in cheese made from ovine, caprine, and buffalo milk has been detected by means of immunoblotting [34]. Adequate sample preparation is necessary to obtain denatured whey proteins from the casein fraction, and polyclonal antibovine  $\beta$ -lactoglobulin antibodies against native and denatured  $\beta$ -lactoglobulin have been utilized.

Detection of adulteration by means of IEF of acid or cheese whey fraction has been reported, based on the different isoelectric point of bovine  $\beta$ -lactoglobulin when compared with the caprine and ovine counterparts [8,32–37]. The results were similar to that of the more simple native PAGE method.

There are several studies on the analysis of whey protein fraction of milk and cheese using CE with alkaline buffer, to detect nondeclared bovine milk in milk mixtures or cheeses. However, genetic variability of milk proteins and the possible heat treatment of one of the milk kinds used in the mixture can limit the efficacy of the method. The detection of 5% bovine milk in buffalo milk and buffalo mozzarella cheese has been based on bovine  $\beta$ -lactoglobulin A or  $\alpha$ -lactalbumin [38]. Bovine milk in ovine milk and cheese has been detected using the bovine  $\beta$ -lactoglobulin B as a marker, with a detection limit of 0.5% in milk mixtures and 2% in cheeses [39]. The same method has been used for the determination of bovine milk in caprine milk and cheese by means of the ratio of bovine  $\beta$ -lactoglobulin A to caprine  $\alpha$ -lactalbumin areas. Detection limits of 2% and 4% for milk and cheese, respectively, and the quantification results have been presented [40]. A quick CE procedure in isoelectric acidic buffers, not requiring coated capillaries, has been developed for the analysis of milk and cheese whey protein fraction. One percent of bovine milk has been detected using the ratios of areas of bovine  $\alpha$ -lactalbumin or  $\beta$ -lactoglobulin to those of their ovine or caprine counterparts [41]. Partial least-squares multivariate regression applied to the results obtained by CE analysis in isoelectric acidic buffers of an ethanol–water extract of cheese, has predicted the content of bovine milk in caprine and ovine cheeses with relative standard deviation of about 6%–7% [42].

In conclusion, electrophoretic methods are not always effective for the accurate quantification of adulteration in cheese. The main difficulties arise from the differences in the casein contents of the milk used in mixtures [43], as well as from the various technological conditions applied in cheese manufacture (i.e., cheesemaking conditions, heat treatment of cheesemilk, cheese ripening).

## 35.2.2 Chromatographic Methods

### 35.2.2.1 Caseins

The chromatographic methods for the identification of milk origin have the objective to separate individual caseins and whey proteins of different animal species which exist in a dairy sample. Despite the fact that many samples can be analyzed at the same time by means of PAGE or IEF, the chromatographic methods are more advantageous as they can be fully automated.

Anion-exchange fast protein liquid chromatography (FPLC®, Amersham Biosciences, part of GE Healthcare, Piscataway, NJ) or high-performance liquid chromatography (HPLC) methods have been applied for bovine milk detection in milk mixtures using the difference between elution times of bovine and ovine/caprine  $\alpha_{s1}$ -casein. A detection limit of about 2%–4% has been reported, similar to the electrophoretic detection [8,44]. However, the rapid hydrolysis of  $\alpha_{s1}$ -casein during cheese ripening limits the efficacy of these methods regarding cheesemilk adulteration. However,  $\alpha_{s1}$ -I peptide ( $\alpha_{s1}$ -CN f24-199) has been used as a marker for fraud detection in Gouda cheese; the quantification results depend upon the maturity of the cheese [44]. Addition of bovine milk as low as 1% in Halloumi cheese has been determined after casein hydrolysis by plasmin, by means of a strong anion-exchange HPLC column [45].

Reversed-phase HPLC (RP-HPLC) profiles have been used for the detection of bovine milk in ovine cheeses at different stages of ripening using the area of  $\alpha$ -casein peaks as a marker; the method has been found to be less sensitive than PAGE, as adulteration equal to or higher than 20% could be detected [10]. Hydrophobic interaction chromatography of the casein fraction has been applied for the analysis of binary mixtures of bovine/caprine and bovine/ovine milks and the cheeses subsequently made. The ratios of individual casein peaks have been proposed as possible markers for the detection of adulteration [46].

The cation-exchange HPLC method of para- $\kappa$ -casein of Mayer et al. [18] has given very promising semiquantitative results in model Camembert cheeses of different ages. The new element of this method is the differentiation between ovine and caprine cheesemilk using the para- $\kappa$ -casein peaks. The same method has been used for Tilsit and Halloumi cheese [8,47].

### 35.2.2.2 Whey Proteins

Chromatographic analysis of whey proteins has been extensively used for the detection of adulteration. Anion-exchange FPLC distinguishes  $\alpha$ -lactalbumin and  $\beta$ -lactoglobulin from bovine and ovine milk [48]. More promising results have been given by an RP-HPLC method, detecting 10% of bovine in ovine milk using bovine  $\beta$ -lactoglobulin A as indicator [49,50]. The RP-HPLC has been also applied successfully for whey protein separation, especially for  $\beta$ -lactoglobulin of Mozzarella cheese and pickle, and detection limits of 1% and 2% of bovine milk have been reported [51–53]. Nevertheless, ovine and caprine milks cannot be differentiated using these methods. Moreover, the chromatograms of whey fraction of cheese varieties with extended proteolysis are expected to be very complex, because they also include a variety of medium- and small-sized peptides resulting

from casein hydrolysis, apart from whey proteins. RP-HPLC of caseinomacropeptide (CMP) has been proposed for the detection of bovine milk in caprine milk after treatment with rennet. The detection limit of bovine milk in caprine milk has been found to be 2.5%, and the intensity of heat treatment does not affect the results [54].

Furthermore, new methods based on the determination of  $\alpha$ -lactalbumin and  $\beta$ -lactoglobulin masses by means of MS have been developed. Matrix-assisted laser desorption/ionization time-of-flight mass spectrometry (MALDI-TOFMS) analysis of whey fraction of Mozzarella cheese made from binary mixtures of buffalo, bovine, and ovine milk has resulted in detection limits of 2% and 5% for ovine and bovine milk, respectively [55]. The presence of 5% bovine milk in goat milk has been detected by means of RP-HPLC/electrospray ionization mass spectrometry (ESI-MS) using  $\beta$ -lactoglobulin as a molecular marker [56]. The high resolving power and the sensitivity of MS methods make them a very promising tool for the rapid detection of the adulteration of milk and dairy products.

### **35.2.3 Antibody-Based Analytical Methods**

Methods based on antigen–antibody precipitation reactions for differentiating the proteins in milk from different species have been presented since 1901 [1,3]. Initially, rabbit antisera to milk whey proteins or blood serum proteins were used for the detection of bovine milk. Subsequently, more specific antisera were prepared by elimination of cross-reacting antibodies. Leveux [57,58] prepared an antiserum against bovine immunoglobulin by immunizing goats or sheep to overcome the adsorption step. The methods of radial immunodiffusion or inhibition of hemagglutination were used with detection limits of about 1%. Both the methods have been commercialized as a patent (CV test for detection of bovine IgG<sub>1</sub> and BC test for caprine IgG<sub>1</sub>), and have been applied to many cheese varieties. The heat resistance of caseins makes them suitable for the elaboration of immunological methods, although preservation of their epitopes depends on protein hydrolysis during cheese ripening. A method that uses rabbit antiserum against whole bovine casein has been presented with a detection limit of 0.1% of bovine casein in ovine casein [59].

Since 1990, enzyme-linked immunosorbent assay (ELISA) has been the most frequently used immunoassay for the detection of milk from different species. It is a simple, sensitive, rapid, reliable, and versatile assay system for the quantifications of antigen and antibodies. Furthermore, ELISAs are usually performed in commercially available 96-well microtitre plates that allow the use of small sample volumes and the rapid simultaneous analysis of high sample numbers. A wide range of ELISA configurations have been developed for the detection of milk adulteration. Apart from the configuration of the assay, the methods are differentiated by the type of antibody used, i.e., monoclonal or polyclonal, and by the protein fractions used for the antibodies production, i.e., caseins or whey proteins or peptides corresponding to defined regions of milk proteins (Table 35.1).

Various ELISAs use polyclonal antibodies against whey proteins. The detection of bovine milk in ovine or caprine milk with detection limits of 0.1% [60], and the detection of caprine milk in ovine milk with detection limit of 0.5% have been reported [61,62]. The response of the assay has been found to be lower in sterilized milks. Polyclonal antibodies against heat-denatured  $\beta$ -lactoglobulin have been used for the detection of very low quantities, i.e., 0.1%–0.2%, of bovine milk in ovine and caprine cheese [63].

The high degree of identity among the homologous caseins from different species complicates their differentiation by immunological methods. Furthermore, proteolysis during cheese ripening

**Table 35.1 ELISA Methods Used for the Detection of Adulteration in Milk and Dairy Products**

Type of Antibodies	ELISA Format	Detection Limit	Quantitative Determination	Ref.
<b>Polyclonal antibodies against</b>				
Bovine whey proteins	Indirect	1% bovine milk in ovine milk	1%–50%	[60]
Caprine whey proteins	Sandwich	0.5% caprine milk in ovine milk	0.5%–100%	[61]
Caprine whey proteins	Indirect	1% caprine milk in ovine milk	1%–100%	[62]
Heat-denatured $\beta$ -lactoglobulin	Indirect competitive	0.1%–0.2% bovine milk in cheese	N/A	[63]
Bovine caseins	Indirect	1% bovine milk in ovine milk and cheese	1%–50%	[64]
Caprine caseins	Sandwich	1% caprine milk in ovine milk and cheese	1%–100%	[67]
Bovine $\gamma_3$ -casein	Indirect competitive	0.1% bovine milk in ovine and caprine cheese	N/A	[68]
Chemically synthesized bovine $\kappa$ -CN f139–152	Competitive	0.25% raw or heated bovine milk in ovine or caprine milk and cheese	0.25%–64%	[69]
Chemically synthesized bovine $\alpha_{s1}$ -CN f140–149	Competitive	0.125% raw or heated bovine milk in ovine milk	0.125%–64% for milk	[70]
			0.5%–25% for cheese	
<b>Monoclonal antibodies against</b>				
Bovine $\beta$ -lactoglobulin (MAbs 17 and 102)	Sandwich "two site"	10 ppm bovine milk in ovine or caprine milk	N/A	[73]
Bovine $\beta$ -lactoglobulin (MAbs 88N and 117N)	Sandwich "two site"	0.03% bovine milk in caprine milk	N/A	[74]
Bovine IgG (MAB BG-18)	Indirect competitive	0.1% bovine milk in caprine, ovine, or buffalo milk	0.1%–10%	[75]

(continued)

**Table 35.1 (continued) ELISA Methods Used for the Detection of Adulteration in Milk and Dairy Products**

Type of Antibodies	ELISA Format	Detection Limit	Quantitative Determination	Ref.
Bovine IgG (MAb BG-18)	Indirect competitive	0.001% bovine milk in ovine and buffalo milk	0.01%–100%	[76]
	Indirect sandwich	0.01% bovine milk in caprine milk		
Bovine $\beta$ -casein (MAb AH4)	Indirect	0.5% of raw bovine milk in ovine or caprine milk	0.5%–100%	[77]
		1% of thermal-treated bovine milk in ovine or caprine milk		
Bovine $\beta$ -casein (MAb AH4)	Immunostick	>1% of bovine milk in ovine milk	N/A	[78]
		>0.5% bovine cheese in ovine cheese		
Bovine $\beta$ -casein (MAb AH4)	Sandwich	0.5% bovine cheese in ovine cheese	0.5%–10%	[79]
Caprine $\alpha_{s2}$ -casein (MAb B2B)	Indirect	0.5% caprine milk in ovine milk	0.5%–15%	[81]
Caprine $\alpha_{s2}$ -casein (MAb B2B)	Competitive indirect	0.25% caprine milk in ovine milk	0.25%–15%	[82]
Caprine $\alpha_{s2}$ -casein (MAb B2B)	Indirect	1% caprine cheese in ovine cheese	1%–15%	[82]
Caprine $\alpha_{s2}$ -casein (MAb B2B)	Competitive indirect	0.5% caprine cheese in ovine cheese	0.5%–25%	[82]

N/A, not available.

can alter their antigenicity characteristics. However, the immunological reactivity of caseins is not affected by heat treatment. Therefore, they can be used in immunological methods for detecting milk mixtures in heat-treated products. Polyclonal antibodies against caseins have been used for the detection of 1% bovine milk or 1% caprine milk in ovine milk and in cheeses made from milk mixtures [64–67]. In addition, polyclonal antibodies against  $\gamma_3$ -casein have been used for the detection of 0.1% bovine milk in ovine or caprine cheese, and the method has not been affected by the intensity of heat treatment of bovine milk [68].

Polyclonal antibodies against synthetic peptides that correspond to defined regions of milk proteins and are conjugated to carriers have also been used as antigens. In addition, polyclonal antibodies against the chemically synthesized 139–152 peptide of bovine  $\kappa$ -casein ( $\kappa$ -CN f139–152) have been used for the detection of bovine CMP in milk and cheese made from mixtures of

ovine or caprine milk with raw or heated (115°C for 15 min) bovine milk; the detection limit has been estimated at 0.25% bovine milk [69]. Assays using polyclonal antibodies against the chemically synthesized bovine fragment  $\alpha_{s1}$ -CN f140–149, which is two amino acids longer than the ovine  $\alpha_{s1}$ -casein deletion, have detected the presence of bovine milk in ovine and caprine milk and cheese with detection limits of 0.125% and 0.5%, respectively [70,71]. Preliminary experiments have indicated that polyclonal antibodies raised against  $\beta$ -CN f1–28 4P phosphopeptide released from bovine  $\beta$ -casein by plasmin might be suitable for the detection of bovine casein in fresh dairy products of ovine and caprine milk [72].

Hybridoma technology for continuous production of monoclonal, monospecific antibodies (MAbs) of consistent specificity against milk proteins or against their fractions could eliminate cross-reactivity between the proteins from different species. Monoclonal antibodies against bovine  $\beta$ -lactoglobulin have been used in very sensitive ELISAs for the detection of bovine milk in ovine or caprine milk; very low detection limits ranging from 0.0001% to 0.03% have been reported [73,74]. Furthermore, very low levels of bovine milk, i.e., 0.1% in caprine, ovine, and buffalo milk can be detected by means of an ELISA that uses a commercial MAb against bovine IgG. However, the assay does not detect bovine IgG in UHT or in reconstituted nonfat dried milk, owing to the denaturation of the target epitope by heat treatment required to produce such products [75]. Using the same antibody, 0.001% bovine milk adulteration of ovine or buffalo milk, 0.01% bovine milk adulteration of goat milk, 0.001% bovine milk in caprine cheese, and 0.01% bovine in ovine and buffalo soft cheese have been detected [76]. A monoclonal antibody against bovine  $\beta$ -casein has been used for the detection of bovine milk in ovine and caprine milk, and for the detection of bovine cheese in ovine cheese. A detection limit of 0.5% bovine milk or cheese has been reported, which is not affected by the intensity of heat treatment of bovine milk [77–80]. The detection of 0.25% of caprine milk in ovine milk and 0.5% of bovine cheese in ovine cheese has been carried out by means of ELISAs that use an MAb against caprine  $\alpha_{s2}$ -casein [81–83].

Immunoassays using monoclonal antibodies against bovine  $\kappa$ -casein have been applied in an automated optical biosensor, for the detection of bovine milk in caprine and ovine milk with a detection limit of 0.1% and a measurement range of 0.1%–10% bovine milk. They are proposed as fast control system of raw milk prior to manufacture of milk products [84,85].

Furthermore, ELISA techniques for the detection of milk or cheese adulteration have been commercialized. Bovine IgG can be detected in milk and cheese (e.g., RIDASCREEN® CIS, R-Biopharm AG, Darmstadt, Germany; RC-BOVINO®, Zeu-Inmunotec SL, Saragosa, Spain) with detection limits of 0.1% and 0.5%, respectively. In addition, using a similar procedure, caprine IgG can be detected in ovine milk with a detection limit of about 1% (e.g., RIDASCREEN GIS, R-Biopharm AG; RC-CAPRINO®, Zeu-Inmunotec SL). However, these methods are not accurate, if bovine milk treated with UHT has been used. In this case, assays based on antibodies that recognize caseins are adequate. A test involving MAbs recognizing bovine  $\gamma_1$ -,  $\gamma_2$ -,  $\gamma_3$ -, and  $\beta$ -caseins (e.g., RIDASCREEN Casein, R-Biopharm AG) with a detection limit of 0.5% of bovine casein in cheese has also been commercialized. Another approach is the development of fast immunochromatographic tests that use antibodies against bovine IgGs and have a detection limit of 0.5% or 1% of bovine milk in milk or cheese, respectively (e.g., RIDA® QUICK CIS, R-Biopharm AG; IC-BOVINO, Zeu-Inmunotec SL). A similar commercial test detects caprine milk in ovine milk or cheese (IC-CAPRINO, Zeu-Inmunotec SL).

In conclusion, ELISAs can be applied for quantitative determination of adulteration. Their simplicity and sensitivity make them very practical for routine controls of dairy products.



### 35.3 Methods of Detection Based on Milk Fat

The genetically controlled biosynthesis of milk fat results in differences in the composition of milk fat triglycerides and fatty acid profiles of each milk kind. Gas chromatography methods have been applied for the determination of triglyceride profiles or the ratios of individual fatty acids. Relationships among particular fatty acids have been proposed since 1963, as indexes for the detection of bovine milk in ovine and caprine milk with a high detection limit of 15%–20% [1]. The ratio of lauric:capric fatty acids (12:10), which is much higher in bovine than in caprine or ovine milk has been used to determine the presence of bovine milk in ovine or caprine cheeses [86]. More recently, 10 NMR parameters of  $^{13}\text{C}$  NMR spectra of triglycerides have been used for distinguishing milks from different animal species [87].

However, detection based on milk fat composition is not reliable, as triglyceride profiles in milk fat are also affected by the environmental factors, such as animal nutrition and season of the year. Furthermore, the addition of skimmed milk from different animal species cannot be detected. Finally, fatty acids profiles can change during cheese ripening owing to their modifications resulting in various aromatic substances.

### 35.4 DNA-Based Methods of Detection—Species-Specific PCR

PCR is an amplification procedure for generating large quantities, over a million fold, of a specific DNA sequence *in vitro*. As described by Glick and Pasternak [88], a typical PCR process entails 30 or more successive cycles, each one consisting of three successive steps, i.e., denaturation at 95°C, renaturation at ~55°C, and *in vitro* DNA synthesis at ~75°C. The essential components are the target sequence in a DNA sample from 100 to ~35,000 bp in length, two synthetic oligonucleotide primers in a vast molar excess, which are complementary to regions on the opposite strand that flank the target DNA sequence, a thermostable DNA polymerase (e.g., Taq DNA polymerase), and four deoxyribonucleotides (dNTPs). Specific PCR procedures for the detection of a species-specific nucleotide sequence in food of animal origin have been developed. PCR techniques are more advantageous than ELISA techniques in terms of sensitivity and suitability for analyzing processed products. Accordingly, they have been considered as a promising tool of dairy research for the detection of milk adulteration.

Lipkin et al. [89] proved that milk samples can serve as a convenient source of purified DNA owing to their somatic-cell content, consisting mainly of leucocytes, as well as epithelial cells. This DNA can serve as a substrate for the amplification of specific DNA sequences using PCR. Milk and dairy products are subjected to various treatments and processes to have an extended shelf-life or to develop special characteristics. Heat treatments of various intensities, condensation, drying, rennet or acid coagulation, fermentation, and cheese ripening can substantially change the environment of the dairy food, whereas somatic cells and DNA molecules are relatively stable under these conditions. The PCR methods reported for the detection of adulteration in milk and dairy products are presented in Table 35.2.

The first step for the application of molecular genetic techniques is the isolation from dairy samples of genomic DNA, free of inhibitors. The adequate protocols have to be optimized to extract a high quantity of DNA efficiently without affecting its integrity. A cell pellet from milk samples is obtained by centrifugation [89,90]. The cell lysis is carried out with the appropriate extraction buffer, followed by treatment with chloroform/methanol, and finally, DNA can be concentrated by ethanol precipitation [80,91–96] or by adsorption on silica particles [97]. The DNA can be extracted from the cell pellet using silica spin columns [98]. A procedure based on

**Table 35.2 PCR Methods Used for the Detection of Adulteration in Milk and Dairy Products**

<i>PCR Format/Dairy Samples</i>	<i>Species Detection</i>	<i>Detection Limit</i>	<i>Quantitative Detection</i>	<i>Ref.</i>
<b>PCR-RFLP</b>				
Ovine and caprine cheese samples	Bovine DNA in cheese	0.5%	N/A	[97]
Commercial Mozzarella and Feta cheese samples	Bovine DNA in cheese	N/A	N/A	[103]
Commercial cheese samples	Bovine DNA in cheese	1%	N/A	[104]
Experimental Feta cheese and yoghurt prepared from binary mixtures of ovine and bovine milk	Bovine DNA in cheese and yoghurt	1% for cheese	N/A	[110]
		2.5% for yoghurt		
<b>PCR-LCR-EIA</b>				
Experimental binary mixtures of bovine milk with ovine, caprine, and buffalo milk	Bovine DNA in milk and cheese	5%	N/A	[116]
Commercial cheese samples				
<b>Species-Specific PCR (Simplex PCR)</b>				
Experimental mixtures of caprine and bovine milk	Bovine DNA in milk	0.1%	N/A	[91]
Commercial cheeses made with nonpasteurized, pasteurized, or UHT-treated milk mixtures (ovine/bovine/caprine), in different ripening stages	Bovine DNA in cheese	0.1%	N/A	[101]
Commercial cheese samples made from ovine, caprine, bovine milk, or milk mixtures (bovine/ovine, bovine/caprine)	Bovine DNA in cheese	N/A	N/A	[115]
Experimental Mozzarella cheese made from mixtures of bovine and buffalo milk	Bovine DNA in cheese	1.5%	N/A	[105]
Commercial Mozzarella cheese samples				
Experimental binary raw, pasteurized, and sterilized milk mixtures (bovine/caprine and ovine/caprine)	Bovine DNA in ovine or caprine milk	0.1%	N/A	[92]

(continued)

**Table 35.2 (continued) PCR Methods Used for the Detection of Adulteration in Milk and Dairy Products**

<i>PCR Format/Dairy Samples</i>	<i>Species Detection</i>	<i>Detection Limit</i>	<i>Quantitative Detection</i>	<i>Ref.</i>
Experimental binary mixtures of raw, pasteurized, and sterilized milk	Bovine DNA in buffalo milk and cheese	0.1%	N/A	[93]
Experimental binary mixtures of buffalo Mozzarella and bovine Mozzarella cheese				
Experimental binary mixtures of raw, pasteurized, and sterilized milk (caprine/ovine)	Caprine DNA in ovine milk	0.1%	N/A	[94]
Mozzarella cheese	Bovine DNA in buffalo cheese	0.5%	N/A	[108]
Experimental Camembert cheeses made from binary mixtures of bovine/caprine or bovine/ovine milk	Bovine DNA in ovine and caprine cheese	0.5%	N/A	[8]
Experimental binary mixtures of caprine and ovine cheese	Caprine DNA in ovine cheese	1%	N/A	[111]
Commercial cheese samples				
Experimental binary mixtures of bovine and caprine or ovine cheese	Bovine DNA in ovine and caprine cheese	1%	N/A	[80]
Reference cheese made from binary mixtures of cheesemilk				
Commercial cheese samples				
Experimental mixtures of bovine and buffalo milk	Bovine DNA in buffalo milk and cheese	0.1%	N/A	[112]
Commercial Mozzarella cheese samples				
<b>Duplex PCR</b>				
Experimental mixtures of bovine and buffalo milk and commercial buffalo Mozzarella samples	Simultaneous detection of bovine and buffalo DNA in cheese and milk	1% bovine milk or 1% buffalo milk	N/A	[102]

**Table 35.2 (continued) PCR Methods Used for the Detection of Adulteration in Milk and Dairy Products**

<i>PCR Format/Dairy Samples</i>	<i>Species Detection</i>	<i>Detection Limit</i>	<i>Quantitative Detection</i>	<i>Ref.</i>
Commercial Mozzarella cheese samples	Simultaneous detection of bovine and buffalo DNA in cheese	N/A	N/A	[107]
Experimental cheeses made from binary mixtures of bovine and ovine milk	Simultaneous detection of bovine and ovine DNA in cheese	0.1% bovine milk	1%–50%	[98]
Commercial cheese samples				
Experimental cheeses made from binary mixtures of bovine and caprine milk	Simultaneous detection of bovine and caprine DNA in cheese	0.1% bovine milk	1%–60%	[99]
Commercial cheese samples				
<b>Multiplex PCR</b>				
Experimental cheeses made from mixtures of bovine, ovine, and caprine milk	Simultaneous detection of bovine, ovine, and caprine DNA in cheese	0.5% bovine milk	N/A	[104]
Commercial cheese samples				
<b>RT-PCR</b>				
Experimental and commercial Mozzarella cheese	Bovine DNA in cheese	0.1%	0.6%–20%	[109]
Experimental binary mixtures of raw and pasteurized bovine and ovine milk	Bovine DNA in milk	0.5%	0.5%–10%	[95]
Experimental binary mixtures of raw and pasteurized caprine and ovine milk	Bovine DNA in milk	0.6%	0.5%–10%	[96]
Commercial bovine and caprine milk	Bovine DNA	35 pg bovine DNA	N/A	[100]
Commercial bovine, caprine, and water-buffalo cheese samples				

N/A, not available.

resin with selective affinity has been proposed, to avoid the step of purification of somatic cells from other milk components [90]. Several adequate protocols for DNA purification are provided with commercial kits. The DNA extraction from cheese starts with the preparation of a cheese homogenate in Tris-HCl buffer at pH 7.5–8.0, in the presence of guanidium isocyanate, EDTA, 2-mercaptoethanol, or sodium dodecyl sulfate. After addition of chilled ethanol, further purification is carried out by spin column or by adsorption to silica particles followed by repetitive washing steps [97–100]. Often, after cheese-sample digestion, lysis by proteinase K is carried out and the lysate can be purified by chloroform addition or ethanol precipitation, or/and by means of a spin column, according to the instructions of the kit manufacturer [93,101–105].

The second step is the efficient PCR amplification of an appropriate target DNA sequence. Initially, DNA-based methods used nuclear DNA. The target for PCR amplification was a *Bos taurus*  $\beta$ -casein region [97]. However, mitochondrial (mt) DNA has been found to be more suitable than nuclear DNA for PCR amplification. The reasons are that the copies of mt DNA in a cell are about 1000 times more than those of nuclear DNA, they have an appropriate length, and contain a great number of point mutations defining differences among the species [101,106]. Amplification of mitochondrial cytochrome *b* DNA sequences by PCR has been used for the identification of milk kind in dairy samples [8,91,100,102,103,105–107,109,110]. In addition, D-loop region [8,101], sequence of mitochondrial cytochrome oxidase I subunit [108], and cytochrome oxidase II [8] have been amplified. There are several reports about PCR targeting the mitochondrial-encoded gene for 12S rRNA [8,80,92–96,111]. In addition, PCR targeting both the mitochondrial 12S rRNA and 16S rRNA has been also reported [98,104]. Another procedure based on two targets, i.e., mitochondrial cytochrome *b* and nuclear growth hormone (GH) genes has been presented [109]. Single-copy nuclear genes can be used to avoid problems resulting from the large variability in mt DNA copy number among the species and individuals of the same species. Very recently, nuclear  $\kappa$ -casein gene has been used for the simultaneous detection of DNA from bovine, ovine, caprine, buffalo milk, and dairy products [112].

Various PCR formats have been put into practice for the detection of milk kind in dairy products (Table 35.2). PCR-restriction fragment length polymorphism analysis (PCR-RFLP), i.e., digestion of PCR products with restriction enzymes has been reported using  $\beta$ -casein [97] and cytochrome *b* primers [103,110], and it is proposed as a qualitative rather than quantitative method. Apart from simplex PCR, duplex PCRs have been configured with the objective to identify two milk kinds in a single PCR assay. For this purpose, specific primers for the two different targets are included in the reaction mixture [98–100,102,107]. Moreover, multiplex PCR using primers for the mitochondrial 12S and 16S rRNA genes of ewe's, goat's, and cow's milk in a single PCR assay has been presented [104].

The third step of molecular techniques is the detection of amplicons. Amplification products are resolved by agarose gel electrophoresis calibrated by simultaneous analysis of a molecular weight marker containing fragments of known sizes. Gels are stained with ethidium bromide, and UV light is used for their visualization. The quantification of milk kind in the dairy samples is based on the intensity of the relevant amplicon band. In the simplex PCR format, the quantification is related to one band that results from the amplification of the target sequence assigned to the nondeclared milk kind [92–94,101,111]. In the duplex PCR, the intensities of the bands of both the targets are used to normalize the calculation or to detect two milk kinds simultaneously in a dairy product. It is proposed as a simple and accurate quantitative approach to overcome variations that might occur during sample preparation, because the quantity of the target fragment is related to the sum of the quantity of the two targets [98,99].

Real-time PCR (RT-PCR) procedures have been successfully applied for the quantification of a target sequence in a dairy sample in a simplex [95,96,109] or a duplex format [100]. Detection is by fluorescence continuously monitored during PCR amplification. Therefore, gel electrophoresis is not required. For RT-PCR, a TaqMan® (Roche Molecular Systems, Inc, Pleasanton, CA) fluorogenic probe, labeled with a fluorophore (reporter) at the 5' end and a nonfluorescent chromophore (quencher) at the 3' end, is used. The middle nucleotides of the probe are complementary to the target DNA. As they hybridize to the target DNA sequence between the flanking primers, the exonuclease activity of the Taq DNA polymerase releases the reporter fluorophore molecule from the probe. As a result, fluorophore is not quenched, i.e., it fluoresces, and the fluorescence resulting from the accumulation of PCR product is continuously monitored. The increase in the fluorescence is proportional to the amount of amplicons produced during PCR [88,95,96,113]. The detection of adulterant species is based on the calculation of the threshold cycle (Ct), i.e., the cycle at which statistically significant fluorescence is detected above the background. López-Calleja et al. [95,96] have used a TaqMan probe, designed to hybridize in a mammalian PCR system as well, which serves as an endogenous control and amplifies any mammalian DNA from the sample. The Ct value in the mammalian PCR system is used to normalize the results. Loparelli et al. [109] have used the single-copy nuclear GH gene PCR system as a reference marker to check the reliability of RT-PCR quantification of species-specific DNA. The superiority of RT-PCR in terms of detection limit is shown in Table 35.2. Furthermore, RT-PCR does not require post-PCR processing steps and many samples can be analyzed in a single run. However, till date, there exist cost limitations with regard to instrumentation and TaqMan chemistry.

Another approach is the oligonucleotide microarray hybridization analysis of PCR products from the mitochondrial cytochrome *b* gene DNA that has been applied to cheese samples [114]. The fluorophor-labeled PCR products are detected by hybridization to an oligonucleotide microarray carrying a set of characteristic sequences covalently immobilized on the activated probe glass slides. When PCR products are hybridized to the immobilized probe set, distinct signals are detected assigned to the corresponding species-specific probes. The post-PCR procedure is short and the method has detected up to three different species in cheeses.

As somatic cell counts (SCC) of milk samples are the source of DNA for the various PCR approaches, the effect of processes such as thermal treatments of milk or cheese and cheese ripening has been examined. It is expected that DNA yield depends on the total number of somatic cells in the samples [102]. The SCC for raw milk has been found to be double the value than that of heat-treated milk, without affecting the sensitivity of PCR used [92–94]. The sensitivity of the methods is strongly influenced by the number of PCR cycles [90,91,99,106]. However, addition of preservatives in milk and refrigeration or freezing up to 200 days does not interfere with PCR amplification [89]. Furthermore, DNA suitable for PCR can be extracted from milk powder or even bovine caseinate [8].

As shown in Table 35.2, the results regarding cheese samples are very promising. Nevertheless, very low level of amplification of cheese DNA has been reported and has been attributed to the low integrity of the cheese DNA [99]. The presence of inhibitory substances can affect DNA amplification; the existence of such a problem can be checked using an internal control in each PCR reaction. Furthermore, calf rennet used in cheesemaking has not influenced the results regarding genuine ovine and caprine cheeses [80,110].

In conclusion, DNA-based techniques could be appropriate control methods for the detection of adulteration of milk and dairy products manufactured from adulterated milk. Their main advantage is that they can be applied in heat-treated milk and dairy products, in which particular

protein fractions may be denatured. The same is true for cheese. During cheese ripening, extensive proteolysis may occur but the mammary somatic cells are not affected. Molecular techniques have been found to be sensitive, whereas duplex and RT-PCR assays can provide reliable estimation of nondeclared milk kinds in dairy products. However, it has to be taken into consideration that SCC of milk, which is the source of DNA, is not controlled, as it is affected by the animal species, and by the genetic and physiological factors for the same species.

## References

1. Ramos, M. and Juárez, M., Chromatographic, electrophoretic and immunological methods for detecting mixtures of milk from different species, *IDF Bulletin No. 202*, Brussels: International Dairy Federation, 1986, pp. 175–187.
2. De la Fuente, M.A. and Juárez, M., Authenticity assessment of dairy products, *Crit. Rev. Food Sci. Nutr.*, 45, 563, 2005.
3. Moatsou, G. and Anifantakis, E., Recent developments in antibody-based analytical methods for the differentiation of milk from different species, *Int. J. Dairy Technol.*, 56, 133, 2003.
4. Hurley, I.P., Ireland, H.E., Coleman, R.C., and Willimas, J.H.H., Application of immunological methods for the detection of species adulteration in dairy products, *Int. J. Food Sci. Technol.*, 39, 873, 2004.
5. Mafra, I., Ferreira, I.M.P.L.V.O., and Oliveira, M.B.P.P., Food authentication by PCR-based methods, *Eur. Food Res. Technol.*, 227, 649, 2008.
6. Andrews, A.T., Proteinases in normal bovine milk and their action on caseins, *J. Dairy Res.*, 50, 45, 1983.
7. Furtado, M.M., Detection of cow milk in goat milk by polyacrylamide gel electrophoresis, *J. Dairy Sci.*, 66, 1822, 1983.
8. Mayer, H.K., Milk species identification in cheese varieties using electrophoretic, chromatographic and PCR techniques, *Int. Dairy J.*, 15, 595, 2005.
9. Kaminarides, S.E., Kandarakis, I.G., and Moschopoulou, E., Detection of bovine milk in ovine Halloumi cheese by electrophoresis of  $\alpha$ s1-casein, *Aust. J. Dairy Technol.*, 50, 58, 1995.
10. Veloso, A.C.A., Teixeira, N., Peres, A.M., Mendonça, A., and Ferreira, I.M.P.L.V.O., Evaluation of cheese authenticity and proteolysis by HPLC and urea-polyacrylamide gel electrophoresis, *Food Chem.*, 87, 289, 2004.
11. Kaminarides, S.E. and Koukiasa, P., Detection of bovine milk in ovine yoghurt by electrophoresis of para- $\kappa$ -casein, *Food Chem.*, 78, 53, 2002.
12. Addeo, F., Anelli, G., and Chianese, L., Gel isoelectric focusing of cheese proteins to detect milk from different species in mixture, In: *IDF Bulletin 202*, International Dairy Federation, Eds, Brussels, Belgium, 1986, pp. 191–192.
13. Addeo, F., Moio, L., Chianese, L., and Stingo, C., Improved procedure for detecting bovine and ovine milk mixtures in cheese by isoelectric focusing of para- $\kappa$ -casein, *Milchwissenschaft*, 45, 221, 1990.
14. Addeo, F., Moio, L., Chianese, L., Stingo, C., Resmini, P., Berner, I., Karause, I., Di Luccia, A., and Bocca, A., Use of plasmin to increase the sensitivity of the detection of bovine milk in ovine cheese by gel isoelectric focusing of  $\gamma$ <sub>2</sub>-caseins, *Milchwissenschaft*, 45, 708, 1990.
15. Commission Regulation, Reference method for the detection of cows' milk and caseinate in cheeses from ewes' goats' and buffaloes' milk, EC regulation No 213/2001 of 9 January 2001, *Off. J. Eur. Commun.*, L37, 51–60, 2001.
16. Addeo, F., Nicolai, M.A., Chianese, L., Moio, L., Spagna, M.S., Bocca, A., and Del Giovine, L., A control method to detect bovine milk in ewe and water buffalo cheese using immunoblotting, *Milchwissenschaft*, 50, 83, 1995.
17. Moio, L., Chianese, L., Rivemale, M., and Addeo, F., Fast detection of bovine milk in Roquefort cheese with Phastsystem<sup>®</sup> by gel electrophoretic focusing and immunoblotting, *Le Lait*, 72, 87, 1992.

18. Mayer, H.K., Heidler, D., and Rockenbauer, C., Determination of the percentages of cows', ewes' and goats' milk in cheese by isoelectric focusing and cation-exchange HPLC of  $\gamma$ - and para- $\kappa$ -caseins, *Int. Dairy J.*, 10, 619, 1997.
19. Recio, L., Amigo, L., and López-Fandiño, R., Assessment of the quality of dairy products by capillary electrophoresis of milk proteins, *J. Chromatogr. A*, 697, 231, 1997.
20. Corradini, C. and Cavazza, A., Application of capillary zone electrophoresis (CZE) and micellar electrokinetic chromatography (MEKC) in food analysis, *Ital. J. Food Sci.*, 4, 299, 1998.
21. De Jong, N., Visser, S., and Olieman, C., Determination of milk proteins by capillary electrophoresis, *J. Chromatogr. A*, 652, 207, 1993.
22. Cattaneo, T.M.P., Nigro, F., Toppino, P.M., and Denti, V., Characterization of ewe's milk by capillary zone electrophoresis, *J. Chromatogr. A*, 721, 345, 1996.
23. Cattaneo, T.M.P., Nigro, F., and Greppi, G.F., Analysis of cow, goat and ewe milk mixtures by capillary zone electrophoresis (CZE): Preliminary approach, *Milchwissenschaft*, 51, 616, 1996.
24. Lee, S.-J., Chen, M.-C., and Lin C.-W., Detection of cows' milk in goats' milk by capillary zone electrophoresis, *Aust. J. Dairy Technol.*, 56, 24, 2001.
25. Molina, E., Martín-Álvarez, J., and Ramos, M., Analysis of cows', ewes' and goats' milk mixtures by capillary electrophoresis: Quantification by multivariate regression analysis, *Int. Dairy J.*, 9, 99, 1999.
26. Molina, E., De Frutos, M., and Ramos, M., Capillary electrophoresis characterization of the casein fraction of cheeses made from cows', ewes' and goats' milks, *J. Dairy Res.*, 67, 209, 2000.
27. Miralles, B., Ramos, M., and Amigo, L., Characterization of fresh cheeses by capillary electrophoresis, *Milchwissenschaft*, 60, 278, 2005.
28. Recio, I., García-Risco, M.R., Amigo, L., Molina, E., Ramos, M., and Martín-Álvarez, P.J., Detection of milk mixtures in Halloumi cheese, *J. Dairy Sci.*, 87, 1595, 2004.
29. Rodríguez-Nogales, J.M. and Vázquez, F., Application of electrophoretic and chemometric analysis to predict the bovine, ovine and caprine milk percentages in Panela cheese, an unripened cheese, *Food Control*, 18, 580, 2007.
30. Calvo, M.M., Amigo, L., Olano, A., Martín, P.J., and Ramos, M., Effect of thermal treatments on the determination of bovine milk added to ovine or caprine milk, *Food Chem.*, 32, 99, 1989.
31. Amigo, L., Ramos, M., and Martín-Álvarez, P.J., Effect of technological parameters on electrophoretic detection of cow's milk in ewe's milk cheeses, *J. Dairy Sci.*, 74, 1482, 1991.
32. Amigo, L., Ramos, M., Calahau, L., and Barbosa, M., Comparison of electrophoresis, isoelectric focusing, and immunodiffusion in determination of cow's and goat's milk in Serra da Estrela cheeses, *Le Lait*, 72, 95, 1992.
33. Molina, E., Ramos, M., and Martín-Álvarez, P.J., Prediction of the percentages of cows', goats' and ewes' milk in "Iberico" cheese by electrophoretic analysis of whey proteins, *Z. Lebensm. Unters. Forsch.*, 201, 331, 1995.
34. Molina, E., Fernández-Fournier, A., De Frutos, M., and Ramos, M., Western blotting of native and denatured bovine  $\beta$ -lactoglobulin to detect addition of bovine milk in cheese, *J. Dairy Sci.*, 79, 191, 1996.
35. Addeo, F., Moio, L., Chianese, L., and Di Luccia, A., Detection of bovine milk in ovine milk or cheese by gel electrophoretic focusing of  $\beta$ -lactoglobulin: Applications and limitations, *Ital. J. Food Sci.*, 1, 45, 1989.
36. Rispoli, S. and Saugues, R., Isoélectroocalisation des lactosérums de fromages de mélange brebis-vache sur gel polyacrylamide—Application à la recherche et au dosage du lait de vache dans les fromages de brebis, *Le Lait*, 69, 211, 1989.
37. Rispoli, S., Rivemale, M., and Saugues, R., Mise en évidence et évaluation de la quantité de lait de vache dans les fromages de brebis par isoélectrofocalisation des lactosérums. Application au cas de fromages très protéolysés: fromages type Roquefort, *Le Lait*, 71, 501, 1991.
38. Cartoni, G.P., Caccioli, E., Jasionowska, R., and Masci, M., Determination of cow milk in buffalo milk and mozzarella cheese by capillary electrophoresis of the whey protein fractions, *Ital. J. Food Sci.*, 10, 127, 1998.



39. Cartoni, G.P., Coccioli, E., Jasionowska, R., and Masci, M., Determination of cow milk in ewe milk and cheese by capillary electrophoresis of the whey protein fractions, *Ital. J. Food Sci.*, 10, 317, 1998.
40. Cartoni, G.P., Coccioli, E., Jasionowska, R., and Masci, M., Determination of cows' milk in goats' milk and cheese by capillary electrophoresis of the whey protein fractions, *J. Chromatogr. A*, 846, 135, 1999.
41. Herrero-Martínez, J.M., Simó-Alfonso, E.F., Ramis-Ramos, G., Gelfi, C., and Righetti, P.G., Determination of cow's milk in non-bovine and mixed cheeses by capillary electrophoresis of whey proteins in acidic isoelectric buffers, *J. Chromatogr. A*, 878, 261, 2000.
42. Herrero-Martínez, J.M., Simó-Alfonso, E.F., Ramis-Ramos, G., Gelfi, C., and Righetti, P.G., Determination of cow's milk and ripening time in nonbovine cheese by capillary electrophoresis of the ethanol-water protein fraction, *Electrophoresis*, 21, 633, 2000.
43. Park, Y.W., Juárez, M., Ramos, M., and Haenlein, G.F.W., Physico-chemical characteristics of goat and sheep milk, *Small Ruminant Res.*, 68, 88, 2007.
44. Haasnoot, W., Venema, D.P., and Elenbaas, H.L., Determination of cow milk in the milk and cheese of ewes and goats by fast protein liquid chromatography, *Milchwissenschaft*, 41, 642–645, 1986.
45. Volitaki, A.J. and Kaminarides, S.E., Detection of bovine milk in ovine Halloumi cheese by HPLC analysis of cheese caseins hydrolysed by plasmin, *Milchwissenschaft*, 56, 207–210, 2001.
46. Bramanti, E., Sortino, C., Onor, M., Beni, F. and Raspi, G., Separation and determination of denatured  $\alpha_{s1}$ -,  $\alpha_{s2}$ -,  $\beta$ - and  $\kappa$ -caseins by hydrophobic interaction chromatography in cows', ewes' and goats' milk, milk mixtures and cheeses, *J. Chromatogr. A*, 994, 59, 2003.
47. Moatsou, G., Hatzinaki, A., Psathas, G., and Anifantakis, E., Detection of caprine casein in ovine Halloumi cheese, *Int. Dairy J.*, 14, 219, 2004.
48. Laezza, P., Nota, G., and Addeo, F., Determination of bovine and ovine milk in mixtures by fast ion-exchange chromatography of whey proteins, *Milchwissenschaft*, 46, 559–561, 1991.
49. De Frutos, M., Cifuentes, A., and Diez-Masa, J.C., Amigo, L and Ramos, M., Application of HPLC for the detection of proteins in whey mixtures from different animal species, *J. High Resolut. Chromatogr.*, 14, 289, 1991.
50. De Frutos, M., Cifuentes, A., Amigo, L., Ramos, M., and Diez-Masa, J.C., Rapid analysis of whey proteins from different animal species by reversed-phase high-performance liquid chromatography, *Z. Lebensm. Unters. Forsch.*, 195, 326, 1992.
51. Pellegrino, L., Tirelli, A., and Masotti, F, Detection of cow milk in non-bovine cheese by HPLC of whey proteins. Note 2: Application to ewe's milk cheeses, *Scienza e Tecnica Lattiero Casearia*, 43, 297, 1992.
52. Ferreira, I.M.P.L.V.O. and Cacote, H., Detection and quantification of bovine, ovine and caprine milk percentages in protected denomination of origin cheeses by reversed-phase high-performance liquid chromatography of beta-lactoglobulins, *J. Chromatogr. A.*, 1015, 111, 2003.
53. Enne, G., Elez, D., Fondrini, F., Bonizzi, I., Feligini, M., and Aleandri, R., High-performance liquid chromatography of governing liquid to detect illegal bovine milk's addition in water buffalo Mozzarella: comparison with results from raw milk and cheese matrix, *J. Chromatogr. A.*, 1094, 169, 2005.
54. Moatsou, G., Kandarakis, I., and Fournarakou, M., Detection of bovine milk in caprine milk by reversed-phase HPLC of caseinomaclopeptides, *Milchwissenschaft*, 58, 274, 2003.
55. Cozzolino, R., Passalacqua, S., Salerni, S., and Garozzo, D., Identification of adulteration in water buffalo mozzarella and in ewe cheese by using whey proteins as biomarkers and matrix-assisted laser desorption/ionization mass spectrometry, *J. Mass Spectrom.*, 37, 985, 2002.
56. Chen, R.K., Chang, L.-W., Chung, Y.-Y., Lee, M.-H., and Ling, Y.-C., Quantification of cow milk adulteration in goat milk using high-performance liquid chromatography with electrospray ionization mass spectrometry, *Rapid Commun. Mass Spectrom.*, 18, 1167, 2004.
57. Leveux, D., Detection immunologique des malanges de laits de diverses especes, *Proc. Int. Congr. Paris*, 15ST, 1978.
58. Leveux, D., The development of a rapid and sensitive method based on hemagglutination inhibition for the measurement of cows' milk in goats' milk, *Ann. Res. Vétérinaires*, 11, 151, 1980.

59. Aranda, P., Oría, R., and Calvo, M. Detection of cow's milk in ewe's cheese by an immunoblotting method, *J. Dairy Res.*, 55, 121, 1988.
60. García, T., Martín, R., Rodríguez, E., Morales, P., Hernández, P., and Sanz, B., Detection of bovine milk in ovine milk by an indirect enzyme-linked immunosorbent assay, *J. Dairy Sci.*, 73, 1489, 1990.
61. García, T., Martín, R., Morales, P., González, I., Sanz, B., and Hernández, P., Sandwich ELISA for detection of caprine milk in ovine milk, *Milchwissenschaft*, 48, 563, 1993.
62. García, T., Martín, R., Morales, P., González, I., Sanz, B., and Hernández, P., Detection of goats' milk in ewes' milk by an indirect ELISA. *Food Agric. Immunol.*, 6, 113, 1994.
63. Beer, M., Krause, I., Stapf, M., Schwarzer, C., and Klostermeyer, H., Indirect competitive enzyme-linked immunosorbent assay for the detection of native and heat-denatured bovine  $\beta$ -lactoglobulin in ewes' and goats' milk cheese, *Zeitschrift Lebensmittel Unters. Forsch.*, 203, 21, 1996.
64. Rodríguez, E., Martín, R., García, T., Hernández, P.E., and Sanz, B., Detection of cows' milk in ewes' milk and cheese by an indirect enzyme-linked immunosorbent assay (ELISA), *J. Dairy Res.*, 57, 197, 1990.
65. Rodríguez, E., Martín, R., García, T., Azcona, J.L., Sanz, B., and Hernández, P.E., Indirect ELISA for detection of goats' milk in ewes' milk and cheese. *Int. J. Food Sci. Technol.*, 26, 457, 1991.
66. Rodríguez, E., Martín, R., García, T., González, I., Morales, P., Sanz, B., and Hernández, P.E., Detection of cows' milk in ewes' milk cheese by a sandwich enzyme-linked immunosorbent assay (ELISA), *J. Sci. Food Agric.*, 61, 175, 1993.
67. Rodríguez, E., Martín, R., García, T., Morales, P., González, I., Sanz, B., and Hernández, P.E., Sandwich ELISA for detection of goats' milk in ewes' milk and cheese, *Food Agric. Immunol.*, 6, 105, 1994.
68. Richter, W., Krause, I., Graf, C., Sperrer, I., Schwarzer, C., and Klostermeyer, H., An indirect competitive ELISA for the detection of cows' milk and caseinate in goats' and ewes' milk and cheese using polyclonal antibodies against bovine  $\gamma$ -caseins. *Zeitschrift Lebensmittel Unters. Forsch.*, 204, 21, 1997.
69. Bitri, L., Rolland, M.P., and Besançon, P., Immunological detection of bovine caseinomacropptide in ovine and caprine dairy products, *Milchwissenschaft*, 48, 367, 1993.
70. Rolland, M.P., Bitri, L., and Besançon, P., Polyclonal antibodies with predetermined specificity against bovine  $\alpha$ s1-casein: Application to the detection of bovine milk in ovine milk and cheese, *J. Dairy Res.*, 60, 413, 1993.
71. Rolland, M.P., Bitri, L., and Besançon, P., Monospecificity of the antibodies to bovine  $\alpha$ s1-casein fragment 140–149: Application to the detection of bovine milk in caprine dairy products, *J. Dairy Res.*, 62, 83, 1995.
72. Pizzano, R., Nicolai, M.A., Padovano, P., Ferranti, P., Barone, F., and Addeo, F., Immunochemical evaluation of bovine  $\beta$ -casein and its 1–28 phosphopeptide in cheese during ripening, *J. Agric. Food Chem.*, 48, 4555, 2000.
73. Leveux, D. and Venien, A., Rapid, sensitive, two-site ELISA for the detection of cows' milk in goats' or ewes' milk using monoclonal antibodies., *J. Dairy Res.*, 61, 91, 1994.
74. Negroni, L., Bernard, H., Clement, G., Chatel, J.M., Brune, P., Frobert, Y., Wal, J.M., and Grassi, J., Two-site enzyme immunometric assays for determination of native and denatured  $\beta$ -lactoglobulin, *J. Immunol. Methods*, 220, 25, 1998.
75. Hurley, I.P., Coleman, R.C., Ireland, H.E., and Williams J.H.H., Measurement of bovine IgG by indirect competitive ELISA as a means of detecting milk adulteration, *J. Dairy Sci.*, 87, 543, 2004.
76. Hurley, I.P., Coleman, R.C., Ireland, H.E., and Williams J.H.H., Use of sandwich ELISA for the detection and quantification of adulteration of milk and soft cheese, *Int. Dairy J.*, 16, 805, 2006.
77. Anguita, G., Martín, R., García, T., Morales, P., Haza, A.I., González, I., Sanz, B., and Hernández, P.E., Indirect ELISA for detection of cows' milk in ewes' and goats' milks using a monoclonal antibody against bovine  $\beta$ -casein, *J. Dairy Res.*, 62, 655, 1995.
78. Anguita, G., Martín, R., García, T., Morales, P., Haza, A.I., González, I., Sanz, B., and Hernández, P.E., Immunostick ELISA for detection of cows' milk in ewes' milk and cheese using a monoclonal antibody against bovine  $\beta$ -casein, *J. Food Protection*, 59, 436, 1996.

79. Anguita, G., Martín, R., García, T., Morales, P., Haza, A.I., González, I., Sanz, B., and Hernández, P.E., Detection of bovine casein in ovine cheese using deoxygenated monoclonal antibodies and a sandwich ELISA, *Milchwissenschaft*, 52, 511, 1997.
80. López-Calleja, I.M., González, I., Fajardo, V., Martín, I., Hernández, P.E., García, T., and Martín, R., Application of an indirect ELISA and a PCR technique for detection of cows' milk in sheep's and goats' milk cheeses, *Int. Dairy J.*, 17, 87, 2007.
81. Haza, A.I., Morales, P., Martín, R., García, T., Anguita, G., González, I., Sanz, B., and Hernández, P.E., Development of monoclonal antibodies against caprine  $\alpha_{s2}$ -casein and their potential for detecting the substitution of ovine milk by caprine milk by an indirect ELISA, *J. Agric. Food Chem.*, 44, 1756, 1996.
82. Haza, A.I., Morales, P., Martín, R., García, T., Anguita, G., González, I., Sanz, B., and Hernández, P.E., Use of monoclonal antibody and two enzyme-linked immunosorbent assay formats for detection and quantification of the substitution of caprine milk for ovine milk, *J. Food Prot.*, 60, 973, 1997.
83. Haza, A.I., Morales, P., Martín, R., García, T., Anguita, G., González, I., Sanz, B., and Hernández, P.E., Detection and quantification of goat's cheese in ewe's cheese using a monoclonal antibody and two ELISA formats, *J. Sci. Food Agric.*, 79, 1043, 1999.
84. Haasnoot, W., Smits, N.G.E., Kemmers-Voncken, A.E.M., and Bremer, M.G.E.G., Fast biosensor immunoassays for the detection of cows' milk in the milk of ewes and goats, *J. Dairy Res.*, 71, 322, 2004.
85. Haasnoot, W., Marchesini, G.R., and Koopai, K., Spreeta-based biosensor immunoassays to detect fraudulent adulteration in milk and milk powder, *J. AOAC Int.*, 89, 849, 2006.
86. Iverson, J.L. and Sheppard, A.J., Detection of adulteration in cow, goat and sheep cheeses utilizing gas-liquid chromatographic fatty acid data, *J. Dairy Sci.*, 72, 1707, 1989.
87. Andreotti, G., Trivellone, E., Lamanna, R., Di Luccia, A., and Motta, A., Milk identification of different species: <sup>13</sup>C NMR Spectra of triglycerols from cows' and buffaloes' milks, *J. Dairy Sci.*, 83, 2432, 2000.
88. Glick, B.R., and Pasternak, J.J., PCR, In: *Molecular Biotechnology*, 3rd edn., Glick, B.R. and Pasternak, J.J., Eds, ASM Press, Washington, DC, 2003, Chapter 5.
89. Lipkin, E., Shalom, A., Khatib, H., Soller, M., and Friedmann, A., Milk as a source of deoxyribonucleic acid and as a substrate for the polymerase chain reaction, *J. Dairy Sci.*, 76, 2025, 1993.
90. Amills, M., Francino, O., Jansa, M., and Sanchez, A., Isolation of genomic DNA from milk samples by using Chelex resin, *J. Dairy Res.*, 64, 231, 1997.
91. Bania, J., Ugorski, M., Polanowski, A., and Adamczyk, E., Application of polymerase chain reaction for detection of goats' milk adulteration by milk of cow, *J. Dairy Res.*, 68, 333, 2001.
92. López-Calleja, I., González Alonso, I., Fajardo, V., Rodríguez, M.A., Hernández, P.E., García, T., and Martín, R., Rapid detection of cows' milk in sheep's and goats' milk by a species specific polymerase chain reaction technique, *J. Dairy Sci.*, 87, 2839, 2004.
93. López-Calleja, I., González Alonso, I., Fajardo, V., Rodríguez, M.A., Hernández, P.E., García, T., and Martín, R., PCR detection of cows' milk in water buffalo milk and mozzarella cheese, *Int. Dairy J.*, 15, 1122–1129, 2005.
94. López-Calleja, I., González Alonso, I., Fajardo, V., Martín, I., Hernández, P.E., García, T., and Martín, R., Application of polymerase chain reaction to detect adulteration of sheep's milk with goats' milk, *J. Dairy Sci.*, 88, 3115, 2005.
95. López-Calleja, I.M., González Alonso, I., Fajardo, V., Martín, I., Hernández, P.E., García, T., and Martín, R., Real-time TaqMan PCR for quantitative detection of cows' milk in ewes' milk mixtures, *Int. Dairy J.*, 17, 729, 2007.
96. López-Calleja, I., González Alonso, I., Fajardo, V., Martín, I., Hernández, P.E., García, T., and Martín, R., Quantitative detection of goats' milk in sheep's milk by real-time PCR, *Food Control*, 18, 1466, 2007.
97. Plath, A., Krause, I., and Einspanier, R., Species identification in dairy products by three different DNA-based techniques, *Z. Lebensm. Unters. Forsch. A*, 205, 437, 1997.

98. Mafra, I., Ferreira, I.M.P.L.V.O., Faria, M.A., and Oliveira, B.P.P., A novel approach to the quantification of bovine milk in ovine cheeses using duplex polymerase chain reaction method, *J. Agric. Food Chem.*, 52, 4943, 2004.
99. Mafra, I., Roxo, Á., Ferreira, I.M.P.L.V.O., Beatriz, M., and Oliveira, P.P., A duplex polymerase chain reaction for the quantitative detection of cows' milk in goats' milk cheese, *Int. Dairy J.*, 17, 1132, 2007.
100. Zhang, C.L., Fowler, M.R., Scott, N.W., Lawson, G., and Slater, A., A TaqMan real-time PCR system for the identification and quantification of bovine DNA in meats, milks and cheeses, *Food Control*, 18, 1149, 2007.
101. Maudet, C. and Taberlet, P., Detection of cows' milk in goats; cheeses inferred from mitochondrial DNA polymorphism, *J. Dairy Res.*, 68, 229, 2001.
102. Rea, S., Chikuni, K., Branciarri, R., Sangamayya, R.S., Ranucci, D., and Avellini, P., Use of duplex polymerase chain reaction (duplex PCR) technique to identify bovine and water buffalo milk used in making mozzarella cheese, *J. Dairy Res.*, 68, 689, 2001.
103. Branciarri, R., Nijman, I.J., Plas, M.E., Di Antonio, E., and Lenstra, J.A., Species origin of milk in Italian Mozzarella and Greek Feta cheese, *J. Food Prot.*, 63, 408, 2000.
104. Bottero, M.T., Civera, T., Nucera, D., Rosati, S., Sacchi, P., and Turi, R.M., A multiplex polymerase chain reaction for the identification of cows', goats' and sheeps' milk in dairy products, *Int. Dairy J.*, 13, 277, 2003.
105. Di Pinto, A., Conversano, C., Forte, V.T., Novello, L., and Tantillo, G.M., Detection of cow milk in buffalo "Mozzarella" by polymerase chain reaction (PCR) assay, *J. Food Qual.*, 27, 428, 2004.
106. Herman, L., Determination of the animal origin of raw food by species-specific PCR, *J. Dairy Res.*, 68, 429, 2001.
107. Bottero, M.T., Civera, T., Anastasio, A., Turi, R.M., and Rosati, S., Identification of cow's milk in "buffalo" cheese by duplex polymerase chain reaction, *J. Food Prot.*, 65, 362, 2002.
108. Feligini, M., Bonizzi, I., Curik, V.C., Parma, P., Greppi, G.F., and Enne, G. Detection of adulteration in Italian mozzarella cheese using mitochondrial DNA templates as biomarkers, *Food Technol. Biotechnol.*, 43, 91, 2005.
109. Lopparelli, R.M., Cardazzo, B., Balzan, S., Giaccone, V., and Novelli, E., Real-time TaqMan polymerase chain reaction detection and quantification of cow DNA in pure water buffalo mozzarella cheese: method validation and its application on commercial samples. *J. Agric. Food Chem.*, 55, 3429, 2007.
110. Stefanos, G., Argyrokastritis, A., Bizelis, I., Moatsou, G., Anifantakis, E., and Rogdakis, E., Detection of bovine mitochondrial DNA specific sequences in Feta cheese and ovine yogurt by PCR-RFLP, *Milchwissenschaft*, 59, 509, 2004.
111. Díaz, I.,L.-C., González Alonso, I., Fajardo, V., Martín, I., Hernández, P., García Lacarra, T., and Martín de Santos, R., Application of a polymerase chain reaction to detect adulteration of ovine cheeses with caprine milk, *Eur. Food Res. Technol.*, 225, 345, 2007.
112. Reale, S., Campanella, A., Merigioli, A., and Pilla, F., A novel method for species identification in milk and milk-based products, *J. Dairy Res.*, 75, 107, 2008.
113. Woolfe, M. and Primrose, S., Food forensics: Using DNA technology to combat misdescription and fraud, *Trends Biotechnol*, 22, 222, 2004.
114. Peter, C., Brünnen-Nieweler, C., Camman, K., and Borchers, T., Differentiation of animal species in food by oligonucleotide microarray hybridization, *Eur. Food Res. Technol.*, 219, 286, 2004.
115. Calvo, J.H., Osta, R., and Zaragoza, P., Species-specific amplification for detection of bovine, ovine and caprine cheese, *Milchwissenschaft*, 57, 444, 2002.
116. Klotz, A. and Einspanier, R., Development of a DNA-based screening method to detect cow milk in ewe, goat and buffalo milk and dairy products using PCR-LCR-EIA technique, *Milchwissenschaft*, 56, 67, 2001.



## Chapter 36

---

# Residues of Food Contact Materials

---

Emma L. Bradley and Laurence Castle

### CONTENTS

36.1	Introduction.....	756
36.2	Food Contact Materials and Chemical Migration .....	756
36.2.1	The Nature of the Food Contact Material.....	759
36.2.2	The Nature of the Foodstuff.....	759
36.2.3	The Nature of the Migrating Substance.....	759
36.2.4	The Extent of Contact with the Foodstuff.....	759
36.2.5	The Duration of the Contact .....	762
36.2.6	The Temperature of the Contact.....	762
36.3	Why Test for Residues of Food Contact Materials?.....	762
36.4	What Residues Need Testing?.....	762
36.5	Testing Strategies .....	763
36.5.1	Overall Migration and Total Extractables .....	763
36.5.2	Specific Migration Limits.....	763
36.5.3	Extraction Tests Followed by Estimation of Migration Levels .....	763
36.5.4	Using Food Simulants.....	764
36.5.5	Testing for the Unexpected .....	765
36.6	Packaging Formats of Relevance to Dairy Products.....	765
36.6.1	Plastics .....	765
36.6.2	Paper/Cartonboard .....	767
36.6.3	Metal Cans with Polymeric Internal Coatings .....	769
36.6.4	Multilayer Packaging Materials .....	771
36.6.5	Active and Intelligent Packaging.....	773

36.6.6 Surface-Active Biocides.....	774
36.7 Conclusion.....	775
Suggested Further Reading.....	775
References.....	775

## 36.1 Introduction

This chapter deals with the transfer of chemical residues from contact materials into dairy products. If chemicals are transferred to the products, they may cause taint or odor problems, and if the concentrations are high enough, it may even make the product unsafe to consume. Hence, it is important to understand how this can be tested and kept under control by the proper selection and use of packaging materials. This chapter aims to give the reader an understanding of this issue, and includes some examples that are illustrative of the main scientific and technical issues. First, the chemical and physical processes that underlie this transfer process, called chemical migration are described. This is because it is the migration phenomenon that makes the testing of dairy products for residues of food contact materials (FCMs) as well as the FCMs themselves, a special topic.

Thus, it is logical to first consider the range of dairy products involved. The characteristics of these dairy food products dictate the packaging materials that are suitable for them. There are many descriptions, divisions, and subdivisions of dairy products, and Table 36.1 gives a breakdown that will serve our purpose here. Obviously, the list would be practically endless, if we were to consider all the dairy-containing foodstuffs. Therefore, only the principle dairy foods are listed in Table 36.1. Table 36.2 describes some of the more common forms of packaging materials used for these dairy products.

## 36.2 Food Contact Materials and Chemical Migration

The term “food contact material” describes any material that may intentionally be placed in contact with a foodstuff. The most obvious examples are food packaging, but the term also encompasses materials (and articles) used in food processing, transport, preparation, and consumption. A distinction is often made by the cognoscenti between materials and articles. Materials such as films and sheets require fabrication into their final usable form, and articles such as boxes and pouches are the final form. In this chapter, we shall refer to both as “materials.” Packaging may be made from plastic, paper/board, rubber, metal or glass, etc. Chemicals are needed to make these materials with their desirable properties. Any chemical constituents present have the potential to transfer to the foods with which they come into contact. In addition, the chemicals present in any adhesives, coatings, or printing inks applied to these substrates also have the potential to transfer. This transfer is known as chemical migration. Chemical migration is defined as “the mass transfer from an external source into food by submicroscopic processes.” The extent to which any substance migrates into a foodstuff is controlled by the diffusion processes that are subject to both kinetic and thermodynamic control. These processes can be described by Fick’s second law, and the extent of any chemical migration is dependent on the

- Nature of the FCM
- Nature of the foodstuff
- Nature of the migrating substance
- Extent of direct or indirect contact between the FCM and the foodstuff
- Duration of the contact
- Temperature of the contact

**Table 36.1 A Description of the Dairy Items Considered for Their FCMs**

<b>Liquid milk, milk concentrate, cream, butter</b>
• Liquid milk—fresh, pasteurized, long-life/ultrahigh temperature (UHT)
• Flavored milk drinks—e.g., flavored with fruit juice
• Sour milk drinks—e.g., kefir, lassi, buttermilk, and whey drinks
• Ready-to-feed infant formula in liquid form
• Condensed/evaporated milk—plain, flavored, functional, etc.
• Cream—single, double, half-and-half, clotted, whipped, sour, crème fraîche, etc.
• Butter
<b>Dried milk powders</b>
• Powdered milk (dehydrated)
• Infant formula
<b>Dairy products and preparations with or without fruit</b>
• Yoghurt—plain/natural, flavored, fruited
• Drinking yoghurt—regular and probiotic
• Chilled and shelf-stable dairy-based desserts
• Chilled dairy snacks
<b>Cheese</b>
• Spreadable cheese—processed and natural, cream cheese, reconstituted cheeses made from “wastes”
• Unspreadable—processed and natural, reconstituted cheeses made from “wastes,” e.g., cheese slices, cheese sticks
• Soft and semihard natural cheese—e.g., Camembert, Brie, Mozzarella
• Hard cheese—e.g., Cheddar, Edam
• Fromage frais and quark—includes both spoonable or drinkable fromage frais and quark products
<b>Ice cream and frozen yoghurt</b>
• Dairy-based ice cream—both impulse-buys (snacks eaten from hand) and for home/meal use
• Frozen yoghurt—usually fruit flavored



**Table 36.2 Examples of Packaging Materials and Formats Used for Dairy Products (Illustrative, Not Exhaustive)**

<i>Food</i>	<i>Material</i>	<i>Format</i>
Milk, etc.	High-density polyethylene (possibly including recycled plastic)	Containers
	Board/metal foil/polyethylene laminates	Cartons
	Waxed board	Cartons
	Glass with metal or plastic closures	Returnable/reusable bottles
Infant formula/dried milk	Metal (largely unlacquered)	Cans
	Spiral-wound paperboard	Containers
	Glass or plastic with metal closures (liquid, ready-to-feed)	Bottles
Yoghurt, etc.	Polypropylene and polystyrene	Pots, tubs
Cream	Polypropylene and polystyrene	Pots, tubs
	Metal (lacquered)	Cans, aerosols
Butter	Grease-proofed paper	Wrapping
	Paper/foil laminates	Wrapping
	Polystyrene	Individual portion packs
Ice cream	Polypropylene or acrylonitrile–butadiene–styrene	Containers with resealable lids
	Cartonboard	Boxes
Cheese	Polyethylene/ethylene vinyl alcohol polymer	Wrapping and vacuum-pack films
	Plasticized polyvinyl chloride	Wrapping and tray overwrapping
	Polyvinylidene chloride	“Chub” packs (tubular casings)
	Paper	Wrapping
	Wax	Not considered as an FCM in many countries

The interplay of these different factors is illustrated using milk, butter, cheese, and cream as examples, in Table 36.3.

### **36.2.1 The Nature of the Food Contact Material**

Migration from a material occurs at the interface with the food. Chemical migration depends on the concentration of the substance in the FCM as well as on the diffusion characteristics of the substance within the material and away from the surface of the food into which it migrates. For a material with a low diffusivity, the rate at which the surface is replenished with the migrant will be slower than that of a high-diffusivity material. As a result, the rate of the migration will be reduced for the low-diffusivity material. Migration from materials, such as glass, ceramics, or metal occurs only from the surface of the material, and no diffusion of the substances will occur from within these materials to the surface. Plastic materials exhibit diffusivity of different extents depending on their structure, crystallinity, etc. However, in all cases, diffusion of migratable substances from within the plastic to the food contact surface can occur. More porous materials such as paper and board provide practically no resistance to the movement of some substances within the matrix, which is depicted in Figure 36.1. Multilayer packaging materials are also common where a barrier layer such as aluminum foil is included in the packaging structure. In these cases, any migratable substances on the nonfood side of the aluminum foil layer will not be able to pass through this barrier layer, and therefore, the migration of such substances into the foodstuff will not occur by this mechanism. However, if a material has been rolled (reeled) or stacked such that the food contact surface is stored in contact with the nonfood contact surface, then the transfer of the chemicals between the two can occur. In such cases, even the presence of a functional barrier such as a layer of aluminum foil is not sufficient to ensure that no migration will occur. This transfer process is known as set-off, and is especially important when evaluating inks.

### **36.2.2 The Nature of the Foodstuff**

When considering migration, foodstuffs are conventionally split into five categories, aqueous, acidic, alcoholic, fatty, and dry. The solubility of the migrating substance in the foodstuff will influence the extent of the migration. Lipophilic (fat-loving) substances have a greater solubility in fatty foods or foods with free fat on the surface, and hence, the migration of such substances into these food types will be greater than that into an aqueous foodstuff. Conversely, polar molecules are more soluble in aqueous media and less soluble in fatty foods.

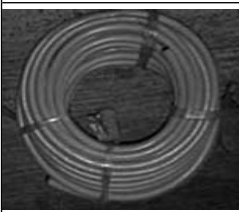





### **36.2.3 The Nature of the Migrating Substance**

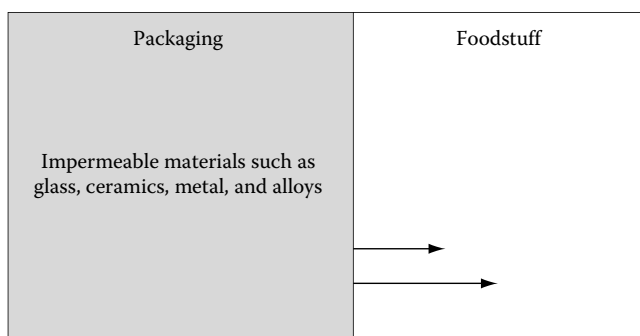
Any substance that is incompatible with the FCM type will “bloom” to the surface, thus readily available to get transferred to the foodstuff. Conversely, any strong interaction that occurs between a substance and the material containing it will slow down the mass transfer process.

### **36.2.4 The Extent of Contact with the Foodstuff**

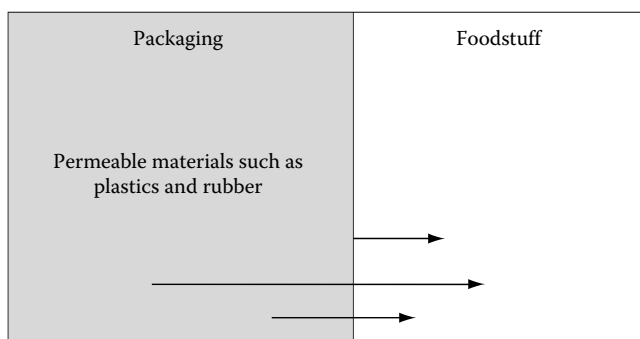
Both the nature of the FCM and that of the foodstuff will influence the partitioning between the two. If the foodstuff interacts strongly with the FCM, then it can cause swelling at the surface,

Table 36.3 The Range of Food Contact Applications Used and the Relative Demands Placed on Packaging with Respect to Chemical Migration

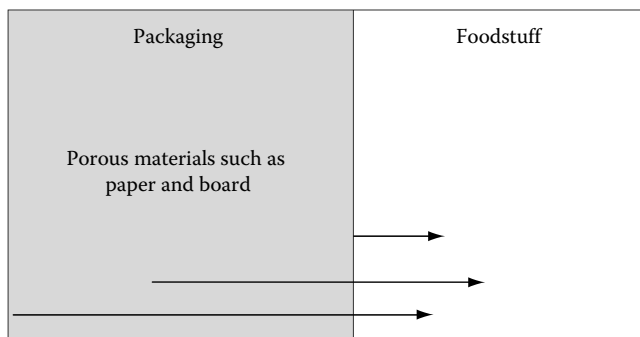
						
	Plastic or silicone milk hose (tubing) used to collect and transport fresh milk	Fresh milk in an HDPE container	Individual portions of UHT milk in polystyrene tubs with a heat-sealed plastic-foil laminate film lidding	Butter in a paper/foillink/over lacquer wrapping	Cheese vacuum-packed in a plastic film and with a printed adhesive label attached	Cream in a three-piece metal can with an internal polymeric coating and with a different coating on the easy-to-open end
Food mass	>1,000,000 g	3400 g	10 g	250 g	210 g	170 g
Contact area	(5 m × 2 cm i.d.)	1140 cm <sup>2</sup>	(a) 25 cm <sup>2</sup> with tub; (b) 7 cm <sup>2</sup> with lid	280 cm <sup>2</sup>	150 cm <sup>2</sup> (ignoring the wax that is not eaten)	155 cm <sup>2</sup> (body)
	3,000 cm <sup>2</sup>					55 cm <sup>2</sup> (end)
Area:mass ratio	0.003 cm <sup>2</sup> /g	0.34 cm <sup>2</sup> /g	(a) 2.5 cm <sup>2</sup> /g for tub; (b) 0.7 cm <sup>2</sup> /g for lid	1.1 cm <sup>2</sup> /g	0.7 cm <sup>2</sup> /g	0.9 cm <sup>2</sup> /g for coat. #1 0.3 cm <sup>2</sup> /g for coat. #2
Temperature (°C)	40°C (milking) to 4°C (chilled)	4°C	4°C—ambient	4°C	4°C	(a) Pasteurized at 121°C; (b) Stored at room temperature
Time	Many months service life, with cleaning in place	5 days or more	90 days	90 days	90 days	(a) 30 min, then; (b) 548 days



Migration can occur from the food contact surface only.



Migration of substances can occur from within the polymer as well as those at the surface.



Migration of substances occurs from the food contact surface, from within the material as well as any substances contained in inks and coating applied to the nonfood contact surface. Porous substrates offer practically no resistance to chemical migration.

**Figure 36.1** Depiction of chemical migration.

which increases the rate at which the chemicals are released. The greater the surface area of the material in direct contact with the foodstuff, the greater is the potential for migration. Similarly, when intimate contact is made as opposed to the point contact, e.g., liquid or semisolid foods, including sauces and pastes, when compared with solid foods, the potential for migration also increases.

### **36.2.5 *The Duration of the Contact***

The longer the material is in contact with the foodstuff, the greater is the extent of the migration that will occur. Migration kinetics is normally first-order, indicating that the extent of any migration increases relative to the square root of the contact time.

### **36.2.6 *The Temperature of the Contact***

As migration is a diffusion process that occurs more rapidly at elevated temperature, the extent of the migration increases with the increasing contact temperature.

## **36.3 Why Test for Residues of Food Contact Materials?**

By the diffusion processes described earlier, any substances present in a material placed in contact with a foodstuff can have the potential to migrate. This migration can have an impact on the safety of the food, because some substances used to make FCMs may be harmful if consumed in sufficient amounts. Migration can also impact on the quality of the food, because the transfer of sensorially active substances may impart a taint or odor to the foodstuff, such that it is no longer appealing to the consumer. The need to control the effects of FCMs on both these aspects is considered in legislation. Extensive references to the legislation in Europe, the United States, and other countries, can be found under the section “Suggested further reading.” For example, in the European Union, the Framework Regulation (EC) No. 1935/2004 covers all FCMs. It is stated in the general requirements of Article 3 that

Materials and articles, including active and intelligent materials and articles, shall be manufactured in compliance with good manufacturing practice so that, under normal or foreseeable conditions of use, they do not transfer their constituents to food in quantities which could: (a) endanger human health; (b) bring about an unacceptable change in the composition of the food; (c) bring about a deterioration in the organoleptic characteristics thereof.

A similar ideal on the need for controls is followed in the United States, Japan, and in other countries, although the detailed legislative and technical instruments used differ.

## **36.4 What Residues Need Testing?**

As mentioned previously, a range of different chemicals are needed to make materials intended for food contact. There are several thousands of chemicals in inventory lists used by producers, and of these, probably several hundred are regularly used. They include monomers and other starting substances needed to make plastics, catalysts, and production aids to make plastics and paper, additives to modify the properties of the finished products, ingredients of inks and adhesives, etc. As chemical migration is a diffusion phenomenon, it is the small, low-molecular weight substances that tend to migrate fastest. This is certainly true for the monomers used to make the high-volume plastics and coatings, such as vinyl chloride, 1,3-butadiene, acrylonitrile, and styrene. Additives, on the other hand, must remain in the finished material to have a technical effect, and hence, they

tend to be higher molecular weight substances to reduce their loss. Thus, the producers striving to make materials with lower migration properties, are turning to the so-called polymeric additives of molecular weight of 1000 Da or more. This indicates that the full range of the analytical methods is deployed in testing these residues; with headspace gas chromatography–mass spectrometry (GC–MS) for the volatiles, GC–MS for the semivolatiles, and increasingly, liquid chromatography (LC)–MS for the nonvolatiles and the polar residues. The detection level needed depends on the toxicological or organoleptic properties of the substances, but typically is in the range of a few parts per million (ppm, mg/kg) down to ca. 10 parts per billion (ppb, µg/kg) in the food.

## 36.5 Testing Strategies

The food itself can be tested for undesirable chemical residues. Alternatively, the packaging material can be tested before it is used, to ensure that it does not contain residues that could migrate at levels that could cause problems. Finally, uniquely for FCMs, the packaging can be tested for its suitability before use, by employing food simulants that are intended to mimic the migration properties of different categories of foods.

### 36.5.1 Overall Migration and Total Extractables

For example, the EU Plastics Directive has imposed an overall migration limit to ensure that materials do not transfer large quantities of substances that, even if safe, could bring about an unacceptable change in the food composition—amounting to adulteration. The total amount of all the migrating substances is limited to 60 mg/kg of food. This is tested for using food stimulants, and a set of test methods is available as European standards. Because a test for overall migration using food simulants is entirely conventional—i.e., the test result depends on the method used—the standard test procedures have to be used and followed exactly. In countries like the United States and Japan, suitability end tests of materials may use extraction solvents rather than food simulants.

### 36.5.2 Specific Migration Limits

Again by way of an example, the EU Plastics Directive 2002/72/EC as amended, contains a positive list of monomers and additives permitted for use in the manufacturing of plastics for food contact. This list contains various limits on the migration of individual substances—limits that have been assigned following the toxicological assessment of these substances. Similar lists exist as National Legislation in European and other countries, for the chemical ingredients used to make paper, silicones, inks, adhesives, coatings on metal, etc. The form of any restrictions—such as specific migration limits or limits on the extractable substance, or on the total content of the material—differs from country to country and for the different material types.

### 36.5.3 Extraction Tests Followed by Estimation of Migration Levels

Compliance of a material with a specific migration limit or some other migration restriction can be tested by extracting the material to determine the concentration of the substance(s) of interest. Subsequently, the migration expected in the food can be estimated either by assuming the

total mass transfer (worst-case 100% migration scenario) or by using mathematical models. The measured concentration in the packaging ( $c_{p,0}$ ) may also be available from the formulation details provided by the producer. A number of commercial software packages (e.g., Migratest© Lite, SMEWISE and EXDIF v 1.0) are available to predict the extent of migration from the  $c_{p,0}$  value. They have been validated mainly for plastics. All are based on the diffusion theory and partitioning effects. The underlying key parameters are the diffusion coefficient of the migrant in the plastic ( $D_p$ ) and the partition coefficient of the migrant between the plastic and the food or food simulant ( $K_{p,f}$ ). These models have been tuned to provide an overestimation of migration in the majority of cases, so that they can be used with confidence in compliance testing.

### 36.5.4 Using Food Simulants

Food simulants are an important tool for testing the suitability of materials for the foods that are intended to be placed in contact with the materials. Again, the EU system for plastics can be considered as an illustrative example. Simulants intended to mimic the migration from plastics into foods were introduced in the early 1980s (Directive 82/711/EEC, as amended), along with the rules for using simulants (Directive 85/572/EEC, as amended). The following are the simulants specified for the five food categories described earlier:

<i>Food Type</i>	<i>Food Simulant</i>
Aqueous foods of pH $\geq$ 4.5	A, distilled water
Acidic foods of pH < 4.5	B, 3% acetic acid solution
Alcoholic foods	C, 10% ethanol solution (or higher)
Fatty foods	D, rectified olive oil or similar oil
Dry foods and frozen foods	No migration testing is specified

Dairy products may be mimicked by using both simulant A (water; to represent the aqueous phase) and/or simulant D (oil; to represent the fatty phase of the food). Simulant B could be used in place of simulant A, if the pH of the dairy product is less than 4.5. The fat content and its form is an important attribute in dairy products, from milk to cream, cheese and butter, giving increasing fat contents. Also, low-fat versions (e.g., low-fat skimmed milk, low-fat yoghurts) are becoming more and more important to consumers. It is considered that the oil simulant is too severe when compared with fatty foods—i.e., it elicits higher migration levels. Hence, for example, for plastic packaging intended to be used for cheese, a reduction factor of 3 is applied to the test result using oil. Clearly, this is a conventional approach because a factor of 3 cannot be strictly correct for all the types of cheese, all the types of different plastics, different substances, etc. (e.g., see Section 36.2 describing the influence of these different parameters on the migration process).

Simulants were introduced at a time when analytical instrumentation and methods were not available to test the foods for all the substances of interest at ppm to ppb levels. Simulants also provide a means to test broad food categories, rather than individual food items. However, with the advancement in methodology and instrumentation, it has become clear that under certain circumstances, the simulants may not overestimate (as designed), but may underestimate migration into

foods. The recent case of 2-isopropylthioxanthone (ITX) migration illustrated that, for example, the organic particulate matter in cloudy fruit juices and the fat content of milk, gave these foods a greater solubility for ITX (the packaging–food partitioning dimension of kinetic migration, see earlier paragraphs) than the simulant specified for these products. This resulted in a widespread product recall in some European countries in late 2005. The case also illustrated that evaluation of the direct FCM is not the only factor to be examined. In this case, the ITX originated from an external printing ink on a paper/foil/plastic laminate, and it had set-off from the printed outer layer onto the inner food contact layer when the laminate was stored on reels.

Milk is a fat-in-water emulsion with water as the continuous phase. Consequently, the simulant specified for milk is currently distilled water and it seems likely that the packaging for the juice and milk had been tested for ITX migration using this simulant. It is clear, however, that the fat content of milk (3% fat) or even skimmed or semiskimmed milk, gives the food a far greater solubilizing power than plain water alone. This has now been recognized and a simulant of 50% ethanol may be introduced to mimic milk. Furthermore, a revision of the food simulants for other dairy products may also be needed.

### **36.5.5 Testing for the Unexpected**

Apart from testing for the known ingredients used to make FCMs, a proper safety assessment must go further. For example, the fourth amendment to Directive 2002/72/EC includes the explicit provision that there is a general requirement to assess the safety of all the potential migrants. This includes the non-intentionally added substances (NIAS), such as impurities, reaction, and breakdown products. The onus is placed on the business operator to make this assessment. Again, although this Directive is applicable to plastics, it can also be used as a guide for other FCMs. To demonstrate their safety, these “nonlisted substances” should be assessed in accordance with the international risk assessment procedures. According to the authors’ opinion, such a risk assessment should have three components: (a) the identification of the substances present in the material, (b) an estimation of their migration level leading to an estimate of possible consumer exposure, and (c) a risk assessment that considers the potential exposure in context with any hazard (nature and potency) posed by the chemical. This requirement to identify substances places emphasis on the information-rich separation techniques, using mass spectrometry as the detection system; i.e., GC–MS and LC–MS (/MS). Increasingly, testing laboratories have turned to LC–time-of-flight (TOF)–MS to get accurate mass information on molecular ions and fragment ions, to gain further confidence in substance identification.

## **36.6 Packaging Formats of Relevance to Dairy Products**

Table 36.3 gives some examples of packaging materials used for dairy products. Plastics are the dominant materials followed by paper/board and metal. Testing these packaging formats is described in more detail in the following sections using selected examples.

### **36.6.1 Plastics**

Plastics are the most commonly used material for packaging foodstuffs, and dairy products are no exception. Examples of plastics used to package chilled dairy foods include containers made



of high-density polyethylene, polypropylene, or polystyrene. The film-lidding materials used with these containers is usually polyester or ethylene vinyl acetate copolymer, often laminated with aluminum foil. The different types of plastics and the typical monomers and additives used in their production have been reviewed elsewhere [1]. Example 1 and Figure 36.2 describe a typical procedure for testing for a volatile migrant—in this case, styrene monomer from individual portion packs of milk or cream for tea or coffee drinks.

### Example 1: Testing for a Volatile Migrant Using Headspace-GC-MS

*Purpose:* Individual portion (serving) packs of dairy-based coffee creamers packed in polystyrene with a peelable film lidding, are tested for migration of styrene.

*Procedure:* The product is poured directly into a headspace vial (10 mL capacity). The samples are analyzed in three ways: (a) as received (no additions); (b) with  $d_8$ -styrene internal standard added at 200  $\mu\text{g}/\text{kg}$  (duplicates); and (c) with  $d_8$ -styrene internal standard added at 200  $\mu\text{g}/\text{kg}$  and with 100–600  $\mu\text{g}/\text{kg}$  spike of styrene added (all in duplicate). The specimens are incubated at 90°C for 30 min, and a portion of headspace gas (1 mL) is analyzed by GC-MS. Mass spectrometric detection is conducted in selected ion mode ( $m/z$  78 and 104 monitored for  $d_0$ -styrene and  $m/z$  84 and 112 monitored for  $d_8$ -styrene).

*Results:* The concentration of styrene was found to be up to 300  $\mu\text{g}/\text{kg}$ . Styrene was confirmed to be present on the basis of the GC retention time and by the ratio of the  $m/z$  78 and 104 ions in the coffee creamer samples. There was good agreement between the duplicate portions and the spikes.

*Interpretation:* The relatively high migration level of up to 300  $\mu\text{g}/\text{kg}$  is probably due to several factors: (1) the high ratio of surface area to volume for these small pack sizes (10 mL); (2) the fat content of the dairy product; (3) the long storage time (typically 90–120 day shelf-life) at ambient temperature; and (4) polystyrene plastics contain a rather high residual monomer content (ca. 500 mg/kg in the plastic) that cannot be removed completely by vacuum stripping, because styrene can be re-formed on thermal processing into materials and articles by unzipping of the polystyrene chain.

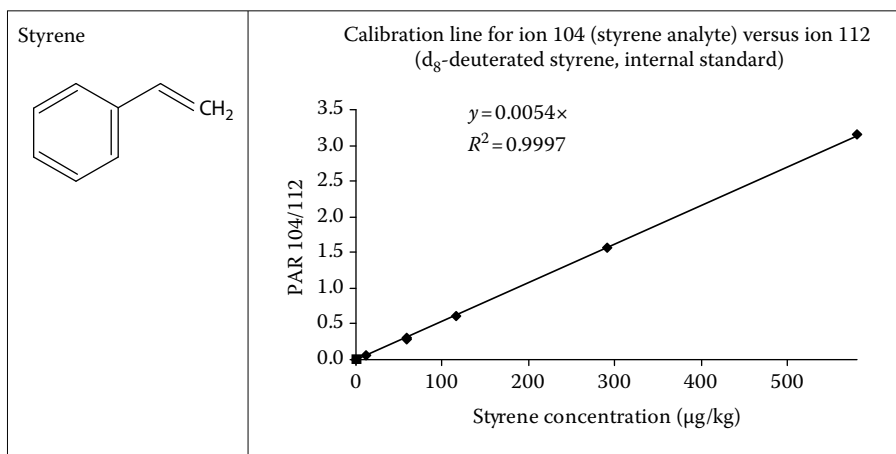


Figure 36.2 Styrene—HS-GC-MS calibration line.

### 36.6.2 Paper/Cartonboard

The fat and water content of dairy products make plain paper generally unsuitable for direct contact. The main exception is frozen ice cream that is sold in some markets packed in blocks in cartonboard. More normally, the paper/board needs to be protected from both the fat and the water component. Grease-proofed paper is used to wrap butter, and coated board or board laminated with plastic can be used for milk, cream, and ice cream. In such cases, the cartonboard provides the rigidity required for the packaging, and the polymer film protects the cartonboard from the foodstuff. The barrier properties of the laminated polymer will determine whether or not any migration of the chemicals derived from the cartonboard will occur. This includes any inks applied directly to the cartonboard or to self-adhesive labels attached. Paper and board materials are porous substrates within which the diffusion of low- and medium-molecular weight chemicals readily occurs, both originating from the paper/board itself as well as from any printing inks and coatings applied to the external (nonfood contact) surface (Figure 36.1). The migration of the printing-ink photoinitiator, benzophenone, through cartonboard substrates and through thin plastic films with a printed label attached, into foods including dairy foods, has been reported [2–3]. In such cases, the migration of small molecules such as benzophenone can occur by vapor-phase diffusion through and from the porous cartonboard with adsorption onto the surface of the foodstuff. Small molecules can also permeate through plastic films if they do not have good barrier properties. Example 2 and Figure 36.3 describe a typical procedure for testing dairy foods for a semivolatile migrant—the ink component, benzophenone.

#### Example 2: Testing for a Semivolatile Migrant Using GC-MS

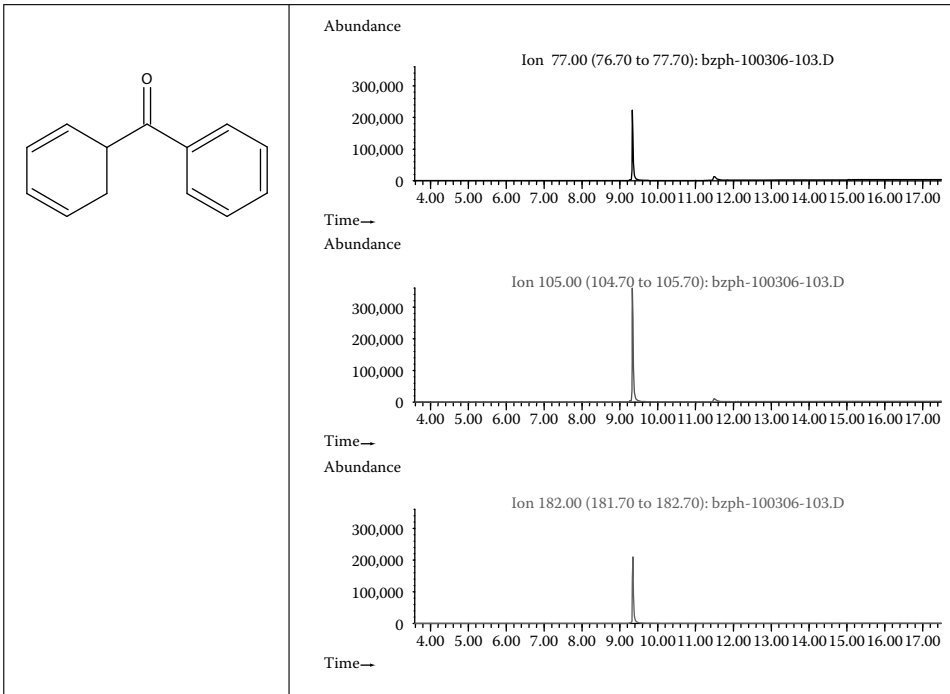
*Purpose:* Foods packaged in printed cartonboard or printed plastics or plastic films with a printed label attached, are tested for any migration of inks components—in this case, the UV-photoinitiator chemical, benzophenone.

*Procedure:* A specimen of the food (5.0 g) along with internal standard (1.5  $\mu\text{g}$   $d_{10}$ -benzophenone) is extracted twice by shaking with acetonitrile:dichloromethane (1:1, 10 mL). The extract is evaporated to dryness and then partitioned between hexane (5 mL) and acetonitrile (5 mL) to defat. The acetonitrile extract is analyzed using GC–MS, monitoring ions  $m/z$  77, 105, and 182 for benzophenone and  $m/z$  110 and 192 for the internal standard. Benzophenone is confirmed to be present if it meets the following three criteria: (a) ion ratios for  $m/z$  182/77 and 182/105 should be within  $\pm 20\%$  of the standards; (b) retention time relative to internal standard should be within  $\pm 2\%$  of the standards; and (c) the full-scan mass spectrum should contain no additional ions ( $< 20\%$ ) not seen in the standards.

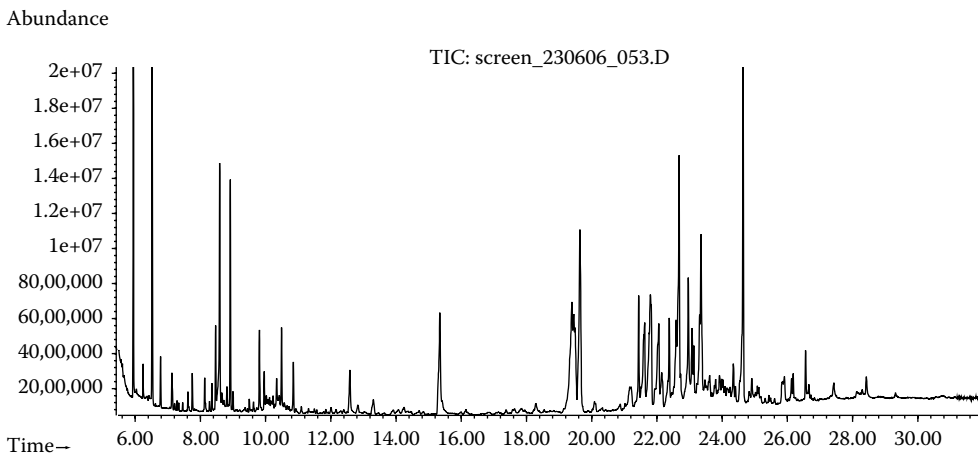
*Results:* The limit of detection was 0.04 mg/kg or better, depending on the food type. Benzophenone was present in 61 of the 350 samples (17%) packed in cartonboard [3]. The mean concentrations were in the range of 0.029–4.5 mg/kg. The highest level found was 4.5 mg/kg for a flavored jelly powder.

*Interpretation:* In the analysis of dairy products, the ability to isolate and preconcentrate the analyte(s) of interest is often limited by the fat content of the sample. In this example, the differential solubility of the analyte (benzophenone) and fat in the two immiscible liquids acetonitrile and hexane has been exploited. Most of the positive samples were in printed cartonboard and especially with long-term frozen storage. However, this type of printed packaging is not widely used for dairy products. Migration into cheese was observed when packaged in a thin plastic film with a label attached which had been printed using benzophenone photoinitiator.

Several standard methods have been published for the testing of paper and board intended to come into contact with foods. These include methods for paper-making chemicals, for contaminants such as those that may be introduced by recycling, and for taint and odor transfer. Paper and board materials are chemically complex systems posing special challenges regarding their safety evaluation. Figure 36.4 shows a GC–MS total-ion chromatogram of a solvent extract of a



**Figure 36.3** GC–MS traces for benzophenone in a cheese sample.



**Figure 36.4** GC–MS total ion chromatogram obtained from the analysis of an ethanol extract of a food contact paper/cartonboard.

food contact paperboard studied in our laboratory. Numerous peaks (individual substances) are detected, and limited peak identification can be performed by comparison of the mass spectrum of each peak with standard spectra contained in spectroscopic libraries. However, typically, many of the substances detected remain unidentified. This is because many are derived from the woods, rosins, additives and processing aids, etc., used to make paper, and they are not included in the standard spectral libraries. Laboratories specialized in paper analysis have, over the years, built their own libraries of commonly encountered substances to assist this identification process.

Given the natural source of paper, its variability (e.g., different wood species) and the use of recycled fibers with their attendant contaminants that a water-based recycling process may not remove completely, the safety evaluation of paper is difficult using chemical analysis alone. Therefore, an approach has been proposed to complement the chemical analysis. This involves the application of a battery of short-term bioassays to extracts of paper and board, to assess the toxicity of the total migrate. Within the BIOSAFEPAPER project (<http://www.uku.fi/biosafepaper>), a battery of cytotoxicity tests was applied to the extracts of paper and board materials. This approach, i.e., assessing the toxicity of the whole migrate, may also be applicable to other materials particularly in cases where a number of NIAS are present in the finished material and for which the toxicity of the individual substances is not known.

### 36.6.3 Metal Cans with Polymeric Internal Coatings

The use of metals to package dairy foods is rather limited. Examples include aluminum foil, either plain or varnished or laminated to plastic and paper films, metal closures for bottles and jars, and some food cans. In most cases, the metal is coated. This coating is intended to form a barrier between the food and the metal surface. The coating protects the food from the metal substrate as well as the metal substrate from the potentially corrosive foodstuff contained within.

The major types of can coatings are made from epoxy resins. These coatings exhibit a combination of toughness, adhesion, formability, and chemical resistance under the conditions that the coated metal is subjected to. In addition to the epoxy resins, hardeners such as acid anhydrides, aminoplasts, or phenoplasts may also be included in the formulation, as well as additives, such as pigments, fillers, wetting and flow aids, defoamers and lubricants, and any reaction/breakdown products formed from these starting materials. As mentioned previously, migration is influenced by both contact temperature and time. Most canned foods are sterilized (e.g., at 121°C for 1 h), although dairy products such as cream and evaporated milk may require a more gentle pasteurization temperature. Canned foods also have long shelf-lives (e.g., 18 months for cream), and hence, the migration conditions in canning are severe. Consequently, coatings manufacturers are constantly striving to produce “cleaner coatings” with fewer low-molecular weight migratable substances [4]. Example 3 and Figure 36.5 describe a method to test a specific substance of interest—bisphenol A (BPA).

#### Example 3: Testing for a Fluorescent Migrant Using HPLC–FLD

*Purpose:* The internal surface of metal food cans are commonly protected using an epoxy-phenolic coating (lacquer). Any residues of incomplete polymerization of this coating may migrate into the canned product. In this example, the migration of BPA is tested in dry infant-milk formula.

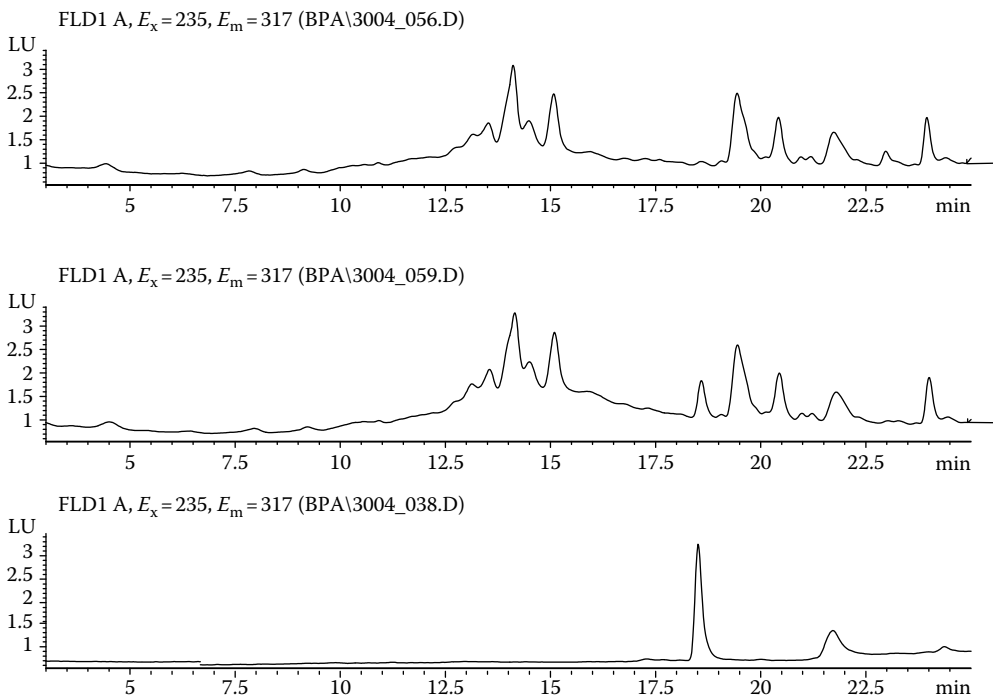
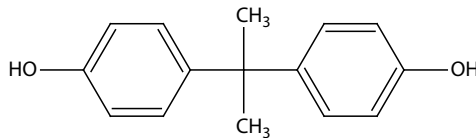
*Procedure:* A portion of the dry formula powder is extracted with acetonitrile, and evaporated to dryness under a gentle stream of nitrogen and reconstituted in a 1:1 mix of water:acetonitrile. The

extract is analyzed by high-performance liquid chromatography (HPLC) with fluorescence detection (FLD) (excitation 235 nm, emission 317 nm). Duplicate samples are extracted and analyzed. Overspiked samples, spiked with BPA at 0.5, 1, 2, and 20  $\mu\text{g}/\text{kg}$  (each in duplicate) are extracted and analyzed in the same way.

*Results:* In this example, the solvent standard establishes the retention time for BPA at 18.5 min (lower panel). However, the extract of milk formula powder shows no evidence of BPA at this retention time (upper panel). Adding BPA at a level of 2  $\mu\text{g}/\text{kg}$  dry powder demonstrates that the test method would detect BPA if it were present.

*Interpretation:* The detection limit is estimated to be 1  $\mu\text{g}/\text{kg}$  or better. With a 1 + 7 dilution of the powdered formula with water, the infant milk as consumed would contain no detectable BPA, no more than 0.1  $\mu\text{g}/\text{kg}$ .

#### Structure of BPA



**Figure 36.5** HPLC–FLD chromatograms of (a) infant formula extract, (b) infant formula spiked with BPA at 2 ppb, and (c) solvent standard of BPA.

### 36.6.4 Multilayer Packaging Materials

Many types of packaging materials consist of more than one layer. This is especially true for the flexible packaging films, where the combinations of toughness for protection, barrier properties against gases (e.g., modified atmosphere packaging [MAP]) or odor, printability, heat-sealability, economy, etc., can be provided by combining two and sometimes several layers in a multilayer structure. The layers may be joined by coextrusion processes or by lamination using adhesives. In addition to the potential migrants derived from the individual materials that make up the different layers, the potential migration of components present in any adhesive used is also possible. Typically, reactive adhesive systems are used for this purpose. These include polyurethanes and, to a lesser extent, epoxy adhesives that are polymerized *in situ*. A very common multilayer film would be nylon or polyester (for toughness and barrier properties), laminated using reactive polyurethanes to a polyethylene film (for heat-sealability) and printed on the outside or reverse-printed with inks inside the laminate sandwich (for decoration and consumer information). Any residues of incomplete polymerization of the adhesive or any reaction by-products may remain in the FCM, and may then migrate into a foodstuff on contact. Example 4 and Figure 36.6 outline testing for unknown migrants using a wide-ranging screening procedure.

#### Example 4: Identifying Potential Migrants Including Unknowns in an FCM

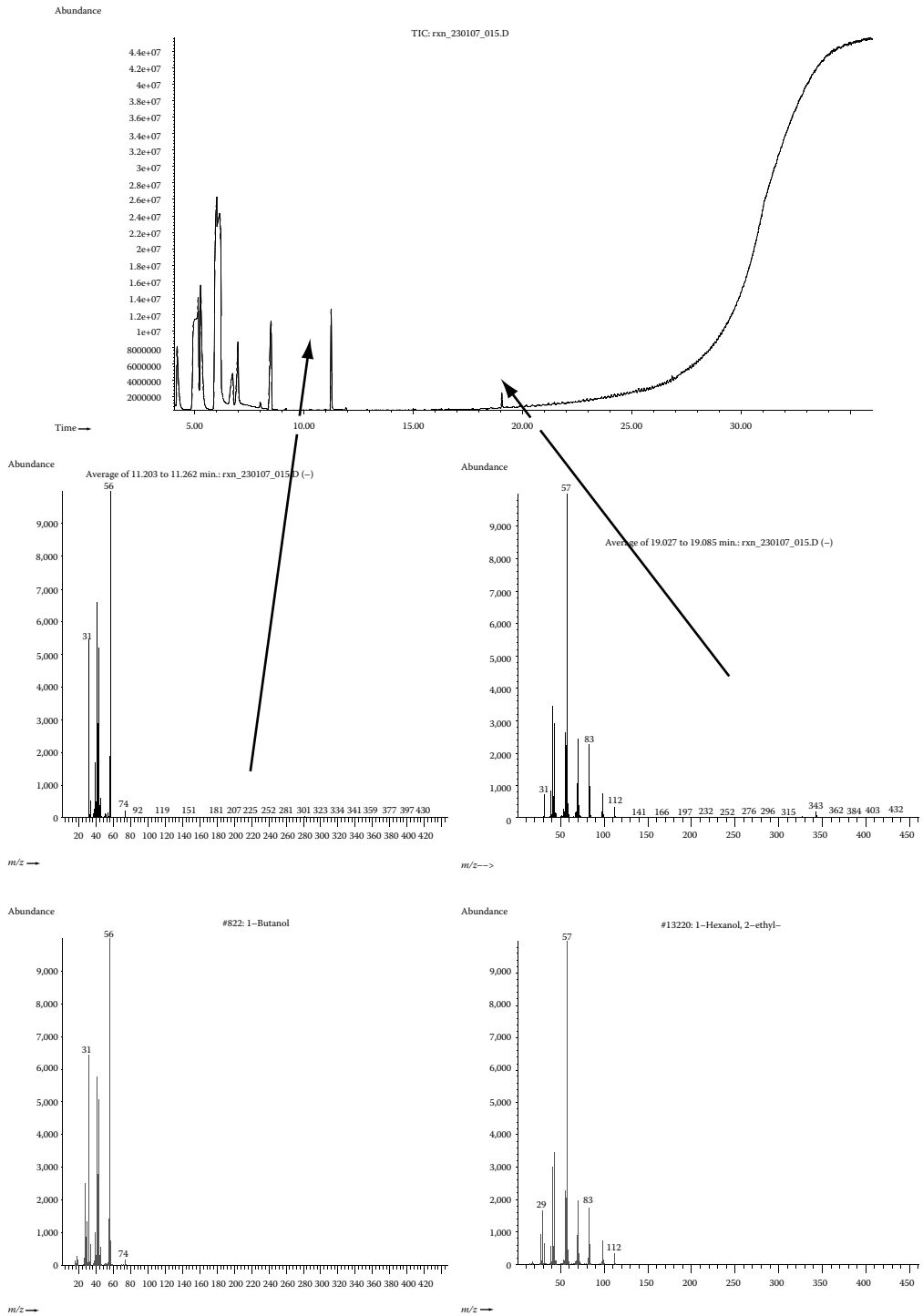
*Purpose:* When assessing the safety of FCMs, the concentrations of both known ingredients as well as any impurities, reaction products, or breakdown products (NIAS) migrating into the food or food simulant should be considered.

*Procedure:* Identification of the potential migrants in an FCM or article can be achieved through the application of a suite of analytical methods focusing on the analysis of substances with molecular weights below 1000 Da. This molecular weight cut-off is chosen in view of toxicological significance—larger molecules do not tend to be absorbed in the stomach or the GI tract. Analysis of the solvent extracts of an FCM is made using thermodesorption GC–MS, to detect very volatile substances, GC–MS and GC × GC–TOF–MS to detect semivolatile substances, and LC–TOF–MS or LC–Fourier transform (FT)–MS to detect more polar and nonvolatile substances.

*Results:* To assess the safety of an FCM, the analytical suite of methods described earlier was applied. A thermodesorption GC–MS chromatogram obtained from the analysis of the FCM is detailed in the following paragraphs. The GC–MS and LC–TOF–MS chromatograms obtained from the analysis of the solvent extracts of the same material were also obtained (not shown). Each peak in the chromatograms corresponded to the substances in the FCM. These can be identified using the library spectra for GC–MS, and by accurate mass determination for LC–TOF–MS.

*Interpretation:* In this example, many substances were detected and identified. For illustration, consider the following examples:

1. *Butanol:* This was detected at low levels. It was not a known ingredient of the plastic. It was attributed to either an impurity or a breakdown product derived from the additive, acetyltributylcitrate, used as a plasticizer in the plastic tested.
2. *2-Ethylhexanol:* Similarly, this was detected at low levels. It was attributed to either an impurity or a breakdown product derived from the additive, di-*n*-octyl-bis(ethylhexylthioglycolate), used in the plastic formulation as a stabilizer.



**Figure 36.6** Thermodesorption GC–MS chromatogram showing butanol (left-hand panel) and 2-ethylhexanol (right-hand panel).

### 36.6.5 *Active and Intelligent Packaging*

One of the most innovative developments in food packaging in recent years is the use of active and intelligent packaging. Active packaging materials can be defined as: “food packaging which has an extra function, in addition to that of providing a protective barrier against external influence.” It is intended to change the condition of the packed food, extend shelf-life, or improve the sensory properties while maintaining the freshness and the quality of the food. This can be achieved through the removal (scavenging) of substances that have a detrimental effect on the food quality. Examples of active absorbers and scavengers include:

- Oxygen scavengers
- Moisture absorbers
- Ethylene and off-flavor scavengers
- Acetaldehyde scavengers
- Amine scavengers
- Sulfide scavengers
- Bitter-taste removers

The main spoilage mechanism of dairy products is lipid oxidation leading to rancidity. Therefore, among the examples cited earlier, oxygen scavengers may have a role to play to supplement the existing use of gas barrier layers and light scavengers (to slow photoinitiated oxidation). The use of active packaging should not mislead the consumer. In other words, for example, using scavengers for aldehydes that are released as dairy spoils, would be unacceptable if it misleads the consumer into believing that the product is fresh and, more importantly, if it prevents the consumer from detecting if the product had been spoiled and therefore, may not be safe for consumption.

Active packaging systems can also aim to emit substances that improve the foodstuff. Examples of active releasing substances include:

- Carbon dioxide regulating systems
- Antimicrobial releasing systems
- Nitrogen releasers
- Antioxidant releasers
- Sulfur dioxide releasers
- Flavor releasers

Again, given that the main spoilage mechanism of dairy products is lipid oxidation, among the examples cited earlier, antioxidant releasers may have a role to play. Historically, storage vessels made of copper or even silver have been used for centuries to store water and wine, and in the early 1900s, people would put silver dollars into milk bottles to prolong the milk’s freshness. However, no modern counterparts of active packaging for dairy products are known at present.

Intelligent packaging materials can be defined as: “Concepts that monitor to give information about the quality of the packed food.” Examples of monitoring systems used in food contact applications include:

- Time and/or temperature indicators
- Freshness and ripening indicators
- Oxygen indicators
- Carbon dioxide indicators



Consequently, for active packaging, the packaging is intended to influence the food, and for intelligent packaging, the food is intended to influence the packaging. As many dairy products are perishable, they have a short shelf-life. Intelligent packaging systems to more closely monitor and indicate the freshness and shelf-life of packs, may have a role to play in ensuring freshness whilst reducing food waste.

In addition to using scavenging and releasing systems to maximize the shelf-life of dairy products, vacuum packaging, controlled atmosphere packaging (CAP), and MAP can also be used. Oxygen in the air increases the rate of both the chemical breakdown and microbial spoilage of many foods. Vacuum packaging removes air from packages and produces a vacuum inside. MAP and CAP help to preserve foods by replacing some or all of the oxygen in the air inside the package with other gases, such as carbon dioxide or nitrogen, thereby reducing the oxidative damage. These systems are often used alongside oxygen-absorbing, carbon dioxide-regulating systems, working together to maximize the products' shelf-life.

In most countries, any active substance(s) emitted into the food is considered to be a direct food additive, and food additive rules and regulations apply. Hence, the food should be tested for the additive using the available methods—e.g., preservatives (see Chapter 6), flavors (Chapter 8), or colors (Chapter 9). Any chemical migration of other components of the delivery system of the active ingredient (e.g., SO<sub>2</sub>/sulfite sorbed onto an inorganic reservoir), the holding system for the scavenging ingredient (e.g., a separate sachet of iron oxide as an O<sub>2</sub> scavenger), or the intelligent components (e.g., an impregnated plastic time/temperature strip) should be tested for the migration of ingredients, reaction products, breakdown products, and impurities, in the normal way for conventional packaging materials.

### 36.6.6 *Surface-Active Biocides*

A number of products have come to the market in recent years with surface biocidal properties. These include conveyor belts, cutting boards, and the inside linings of commercial and domestic refrigerators. These surface-active biocidal materials should not be confused with active packaging (see Section 36.6.5), because the biocidal agent does not have any preservative effect on the food. Rather, the intention is that the biocide remains in the FCM, perhaps concentrated at the surface, and improves the surface hygiene and cleanability. Surface-active biocidal materials may be particularly beneficial for food-processing machinery parts that are awkward to clean in place (*in situ*).

A common biocide used for this is silver in a number of chemical forms. It is generally accepted that silver ions are antimicrobial to all microbial species that are likely to be found in a food environment, including Gram-negative bacteria, Gram-positive bacteria, molds, and yeasts. Another biocide used is 2,4,4'-trichloro-2'-hydroxydiphenyl ether that seems to have a less uniform activity against bacteria, molds, and yeasts. Containers with silver incorporated for storage of food including cheese, can be found on sale in some countries.

Although these surface-active biocides are not intended to migrate into the food and exert any preservative effect, some level of migration is inevitable and should be tested for as for any other substances used in FCMs. In the two examples given, the inorganic silver compounds may be expected to migrate mostly into aqueous and acidic foods, whereas the organic substance, 2,4,4'-trichloro-2'-hydroxydiphenyl ether, is expected to migrate more into fatty foods.

The unavoidable migration level should not be high enough to exert any preservative effect on the food. This can be checked by calculation, i.e., by comparing the migration concentration against the minimum inhibitory concentration (MIC) values of common food-related microbes. However, these

calculations can be difficult to interpret because; first, the MIC values are usually recorded in pure buffer media and may change significantly in the presence of food components. This is especially true for silver ions that can be sequestered. Second, for solid and semisolid foods like full-fat cream and cheese, the migration will be concentrated at the food contact surface and obviously, the surface of the food is most prone to microbiological spoilage. Hence, the migration concentration at the surface could be much higher than that calculated as an average for the whole mass of the food. For these reasons, there is a need to conduct real food trials to ensure that there is no preservative effect exerted.

There does seem to be two areas where test methods are missing. The first is demonstration of whether these materials are really effective under the particular conditions of recommended use. Simple film tests examining surface inhibition against different organisms seem to be the only laboratory tool available at present. The alternative is real-life factory trials with full microbiological audit. As these materials are intended to complement and not replace the normal cleaning and hygiene procedures, hard facts and data are difficult to obtain. The second related area is to determine for how long these biocidal materials retain their efficacy. Again, laboratory tests seem to be inadequate to simulate the resistance of the biocidal agent to loss through repeated washing, exposure to caustic cleaning agents, repeated contacts with food, etc., during the service life of the material. Therefore, these research and development needs for appropriate test methods should be addressed.

## 36.7 Conclusion

Chemical residues in dairy products may occur as a result of chemical migration from FCMs, of which food packaging materials are the most important example. Analysis of the food for these chemical residues basically uses the same chemical analytical methods that are in the food analysts' armoury. However, what makes the topic special is the added dimension of needing to analyze the food packaging materials themselves (to indicate what chemical(s) may migrate) and the analysis of food simulants used to test the materials for their suitability for contact with different types of foods.

## Suggested Further Reading

Barnes, K. A., Sinclair, R., and Watson, D. (eds.) 2007. *Chemical Migration and Food Contact Materials*. Woodhead Publishing, Cambridge, U.K., ISBN-13: 978-1-84569-029-8.  
<http://crl-fcm.jrc.it/> (website for the EU Community Reference Laboratory for Food Contact Materials).  
<http://www.cfsan.fda.gov/~lrd/foodadd.html> (website for the US Food and Drug Administration Centre for Food Safety and Applied Nutrition), Food Ingredients and Food Packaging.

## References

1. Cooper, I., 2007. Plastics and chemical migration into food. In: *Chemical Migration and Food Contact Materials*. K. A. Barnes, R. Sinclair, and D. Watson, (eds.). Woodhead Publishing, Cambridge, U.K., pp. 228–250.
2. Johns, S. M., Jickells, S. M., Read, W. A., and Castle, L., 2000. Studies on functional barriers to migration. 3. Migration of benzophenone and model ink components from cartonboard to food during frozen storage and microwave heating. *Packaging Technology and Science*, **13**, 99–104.
3. FSIS, 2006. Food Survey Information Sheet 18/06: Benzophenone and 4-hydroxybenzophenone migration from food packaging into foodstuffs.
4. Stocker, J., 2007. New technologies and chemistries for can coatings. *New Food*, **3**, 46–81.



## Chapter 37

---

# Chemical Contaminants: Phthalates

---

Jiping Zhu, Susan P. Phillips, and Xu-Liang Cao

### CONTENTS

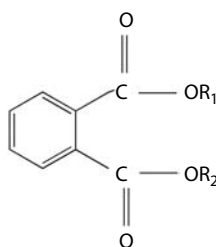
37.1	Introduction .....	777
37.2	Levels of Phthalates in Dairy Products and Other Foods .....	780
37.2.1	Phthalates in Infant Milk.....	780
37.2.2	Milk for General Consumption .....	786
37.2.3	Phthalates in Dairy Products .....	787
37.2.4	Phthalates in Nondairy Food Products .....	787
37.2.5	Phthalates in Total Diet .....	789
37.3	Migration of Phthalates into Milk and Other Dairy Products.....	790
37.4	Analytical Methods for the Detection of Phthalates in Dairy Products.....	792
37.4.1	Avoidance of Sample Contamination .....	792
37.4.2	Sample Pretreatment, Extraction, and Cleanup.....	792
37.4.3	Instrumental Conditions.....	795
37.5	Concluding Remarks.....	796
	References.....	797

### 37.1 Introduction

Without the naturally occurring chemicals that underlay all growth and development, there would be no life on our planet. Chemicals manufactured from combinations of the basic elements are inseparable from modern life. Society, as we know, would be unrecognizable without them. Many consumer products used daily contain or are made of synthetic materials. Food, itself, contains

many naturally occurring chemicals. Other chemicals, either natural or synthetic, are often added to food to modify or improve its quality or to preserve it. However, some chemicals that are not intended for consumption are being introduced into the food chain, and their presence is not desirable and can be harmful to consumers. They are called chemical contaminants. The source of these chemical contaminants in food are numerous and sometimes not apparent. Their presence could be a result of using contaminant-containing materials in food production (for example, the use of pesticides/fungicides), food handling (such as containers for food storage and food wrappings/packaging materials), or food preparation (such as heating). Among them, there is a class of chemical contaminants called phthalic acid diesters, commonly known as phthalates.

Structurally, phthalates are composed of a common basic moiety of 1,2-benzenedicarboxylic acid group, in which the two acidic groups are linked to two alcohols to form diesters (Scheme 37.1). The most well-known and widely used phthalate is di(2-ethylhexyl)phthalate (DEHP,  $R_1 = R_2 = -CH_2CH(CH_2CH_3)CH_2CH_2CH_2CH_3$ ). Other common phthalates being environmentally monitored include dimethyl phthalate (DMP,  $R_1 = R_2 = -CH_3$ ), diethyl phthalate (DEP,  $R_1 = R_2 = -CH_2CH_3$ ), di-*n*-butyl phthalate (DnBP,  $R_1 = R_2 = -CH_2CH_2CH_2CH_3$ ), benzylbutyl phthalate (BBzP,  $R_1 = -CH_2CH_2CH_2CH_3$ ,  $R_2 = -CH_2C_6H_5$ ), and di-*n*-octyl phthalate (DnOP,  $R_1 = R_2 = -CH_2CH_2CH_2CH_2CH_2CH_2CH_2CH_3$ ). Their physical properties are summarized in Table 37.1.



**Scheme 37.1** General structure of phthalates.

Phthalates are semivolatile organic compounds with vapor pressures of the six commonly monitored phthalate ranging from  $1.00 \times 10^{-7}$  Pa to  $2.63 \times 10^{-1}$  Pa and boiling points from 282°C to 428°C. Their other physical–chemical properties have been described by Cousins and Mackay [1]. Using a quantitative structure–property relationship (QSPR) method, air–water ( $K_{AW}$ ), octanol–water ( $K_{OW}$ ), and octanol–air ( $K_{OA}$ ) partition coefficients at 25°C were estimated. These coefficients represent the distribution of phthalates in air and water, in octanol and water, and in octanol and air under equilibrium conditions, respectively. The estimated coefficients of six commonly monitored phthalates are included in Table 37.1.

Among these coefficients,  $K_{OW}$  values are important for evaluating the distribution of a chemical in various tissues and organs in humans and animals. Octanol is a straight chain fatty alcohol with eight carbon atoms and a molecular structure of  $CH_3(CH_2)_7OH$ . It is lipophilic (“fat loving”) and is considered to be the representative of body’s fatty tissues and fluids such as milk, while water is hydrophilic (“water loving”) and represents the body’s less fatty fluids such as blood and urine. Log  $K_{OW}$  values of the six commonly monitored phthalates range from 1.61 to 9.46, of which DEHP has a value of 7.73 (Table 37.1). This means that for every molecule of DEHP stored in water, there will be  $10^{7.73}$  molecules in octanol. The fat-loving nature of phthalates such as DEHP is an important property explaining its presence in dairy products, particularly those with a relatively high fat content.

**Table 37.1 Physical Properties of Phthalates**

Name	<i>Dimethyl Phthalate</i>	<i>Diethyl Phthalate</i>	<i>Di-n-Butyl Phthalate</i>	<i>Butyl Benzyl Phthalate</i>	<i>Di(2-Ethylhexyl) Phthalate</i>	<i>Di(n-Octyl) Phthalate</i>
Abbreviation	DMP	DEP	DnBP	BBzP	DEHP	DnOP
CAS No.	131-11-3	84-66-2	84-74-2	85-68-7	117-81-7	117-84-0
Structural formula	C <sub>10</sub> H <sub>10</sub> O <sub>4</sub>	C <sub>12</sub> H <sub>14</sub> O <sub>4</sub>	C <sub>16</sub> H <sub>22</sub> O <sub>4</sub>	C <sub>19</sub> H <sub>20</sub> O <sub>4</sub>	C <sub>24</sub> H <sub>38</sub> O <sub>4</sub>	C <sub>24</sub> H <sub>38</sub> O <sub>4</sub>
Molecular weight	194.2	222.2	278.4	312.4	390.6	390.6
Melting point (°C)	5.5	-40	-35	-35	-47	-25
Boiling point (°C)	282	298	340	370	385	428
VP(Pa) (25°C)	2.63 × 10 <sup>-1</sup>	2.83 × 10 <sup>-3</sup>	2.17 × 10 <sup>-4</sup>	1.17 × 10 <sup>-4</sup>	1.19 × 10 <sup>-6</sup>	1.00 × 10 <sup>-7</sup>
Specific gravity (20°C)	1.192	1.118	1.042	1.111	0.986	0.978
Log K <sub>OW</sub> (25°C)	1.61	2.54	4.27	4.7	7.73	9.46
Log K <sub>OA</sub> (25°C)	7.01	7.55	8.54	8.78	10.53	11.52
Log K <sub>AW</sub> (25°C)	-5.4	-5.01	-4.27	-4.08	-2.8	-2.06

Source: Cousins, I. and Mackay, D., *Chemosphere*, 41, 1389, 2001.

Partition coefficients of air–water ( $K_{AW}$ ), octanol–water ( $K_{OW}$ ), and octanol–air ( $K_{OA}$ ) are from Cousins and Mackay [1].

Phthalates are widely used in today's society. DEHP is predominantly found in polyvinyl chloride (PVC), a thermoplastic polymer, to make it softer and more flexible. Besides being used in some food-packaging materials, DEHP is also a component of medical product containers, intravenous tubing, medical equipment, plastic toys, vinyl upholstery, shower curtains, adhesives, and coatings. Phthalates with smaller R<sub>1</sub> and R<sub>2</sub> groups such as DEP and DBP are mainly used as solvents in products such as perfumes and pesticides.

Extensive use of phthalate esters in both industrial processes and consumer products has resulted in the ubiquitous presence of these chemicals in the environment. They have been detected in water and soil [2–6], consumer products [7–10], medical devices [11], marine ecosystems [12], indoor air [13,14], and indoor dust [15,16]. Some phthalate esters and their monoester metabolites (called monophthalates) have also been detected in human urine [17–21] and amniotic fluid [22] samples.

Toxicology and epidemiology studies indicated that in animals and humans, phthalates can mimic hormones and have endocrine disrupting properties [23]. Studies on rodents have shown

that phthalate esters are estrogenic and are associated with adverse reproductive effects [24–27]. Phthalate esters have been linked to premature breast development observed in very young Puerto Rican girls [28]. An inverse linear association between phthalate metabolite levels in urine and observed mobility, concentration, and normal morphology of sperm in American men suggested that these chemicals have estrogen-like activity in humans [29]. In a case-controlled study, BBP in house dust was found to be associated with asthma and allergic symptoms in children [30].

## 37.2 Levels of Phthalates in Dairy Products and Other Foods

Dairy products are generally defined as foodstuffs produced from milk. These products include milk, milk powder, butter, cheese, and yoghurt among others. They are usually high-energy yielding food products. Raw milk used to make processed dairy products such as cheese generally comes from cows, but occasionally from other mammals such as goats or sheep. Owing to their large  $K_{OW}$  values, that is, their fat solubility, phthalates are found primarily in fat-containing dairy products. Table 37.2 summarizes the levels of phthalates reported in dairy products and other foods consumed by infants or the general population. The products are grouped into infant milk, general retail milk, dairy products, baby food, general food, and dietary food. DnBP and DEHP are the two most commonly detected phthalates in dairy products although other phthalates are occasionally present as well.

### 37.2.1 *Phthalates in Infant Milk*

Yano et al. [31] has measured 27 baby milk powders purchased from supermarkets or local open markets in several cities in 11 European, North American, and Asian countries for the presence of DnBP (15–77  $\mu\text{g}/\text{kg}$ ) and DEHP (34–281  $\mu\text{g}/\text{kg}$ ). Each sample was analyzed in triplicate and the average value of the three was used for reporting the concentrations. Infant exposure to these two phthalates was then estimated based on a daily intake of 700 mL of milk and was found to be below the European Commission Scientific Committee's tolerable daily intake. Although the authors did not report how the milk powder was mixed prior to analysis, based on the estimation of infant daily intake, we believe this study used reconstituted milk solutions.

Another study examined levels of five phthalates, namely DBP, BBP, DEHP, di-*n*-nonyl phthalate (DINP), and di-*n*-decyl phthalate (DIDP) in reconstituted infant formula ( $n = 6$ ) and liquid infant formula ( $n = 2$ ) [32]. Only DEHP was detected in the samples. The levels of DEHP in liquid infant formula were in the range of 10–23  $\mu\text{g}/\text{kg}$ ; however, DEHP levels in reconstituted infant formula (37–138  $\mu\text{g}/\text{kg}$ ) were much higher. The results from the latter study were in agreement with another earlier German study, which reported DnBP (<20–85  $\mu\text{g}/\text{kg}$ ) and DEHP (<50–196  $\mu\text{g}/\text{kg}$ ) in infant milk [33].

Casajuana and Lacorte reported mean values of five phthalates (DMP, DEP, DnBP, BBP, and DEHP) in one powdered infant formula packed in a metal can [34]. DEP, DnBP, and DEHP were the three major phthalates and the concentrations of DMP and BBP were much lower at 1–2  $\mu\text{g}/\text{kg}$ . While the levels of DnBP (18  $\mu\text{g}/\text{kg}$ ) and DEHP (20  $\mu\text{g}/\text{kg}$ ) were similar to or lower than those in other studies, the high DEP (76  $\mu\text{g}/\text{kg}$ ) levels reported in this study were rather surprising. In fact, this is the only study that reported the presence of DEP in commercial milk.

Owing to the importance of human milk in the early stage of infant growth and the potential health impact of chemical contaminants in human milk on infant development, several studies

Table 37.2 Levels of Phthalates ( $\mu\text{g}/\text{kg}$ ) in Dairy Products and Other Foods

Type of Dairy Products	Level ( $\mu\text{g}/\text{kg}$ )						Size (n=)	Country	Ref.	Year of Publication
	DMP	DEP	DnBP	BBP	DEHP	DnOP				
<b>Infant milk</b>										
Liquid infant formula			<9	<4	10–23	<5	6	Different countries	[32]	2006
Reconstituted baby formula			15–77		34–281		27	11 countries	[31]	2005
Reconstituted baby formula			<20–85		<50–196		8	Germany	[33]	1998
Reconstituted baby formula			<9	<4	37–138	<5	6	Different countries	[32]	2006
Reconstituted baby formula				Up to 10	Up to 60		11	Denmark	[43]	2000
Reconstituted baby formula			n.d. to 30		10–20		5	Germany	[35]	2000
Reconstituted baby formula <sup>a</sup>	1.4	76	18	1.2	20		2	Spain	[34]	2004
Human milk			<20–51		<50–160		5	Germany	[33]	1998
Human milk			10–50		10–20, 110		5	Germany	[35]	2000
Human milk <sup>a</sup>	n.d.	0.31	0.87	n.d.	222	n.d.	86	Canada	[36]	2006
Human milk <sup>a</sup>		0.3	2.8	0.75	17	1.1	50	Sweden	[37]	2008
<b>General retail milk</b>										
Raw milk			<9	<4	7–30	<5	18	Denmark	[32]	2006

(continued)



Table 37.2 (continued) Levels of Phthalates ( $\mu\text{g}/\text{kg}$ ) in Dairy Products and Other Foods

Type of Dairy Products	Level ( $\mu\text{g}/\text{kg}$ )							Size (n=)	Country	Ref.	Year of Publication
	DMP	DEP	DnBP	BBP	DEHP	DnOP					
Raw milk			n.d. to 30		100–150			3	Germany	[35]	2000
Raw milk (hand milking) <sup>a</sup>	n.d.	0.6	6.39	n.d.	16	n.d.		6	Canada	[49]	2005
Raw milk (machine milking) <sup>a</sup>	n.d.	0.63	5.79	n.d.	215	n.d.		6	Canada	[49]	2005
Retail milk			<9	<4	13–27	<5		4	Denmark	[32]	2006
Retail milk (<0.1%–3% fat)					<10–50			11	Spain	[41]	1994
Retail milk (<1% fat)					20–40			5	Norway	[41]	1994
Retail milk (1% fat)					50			3	Norway	[41]	1994
Retail milk (3% fat)					60–380			9	Norway	[41]	1994
Retail milk in glass bottle (2.3%–4.2% fat)					10–90			16	United Kingdom	[41]	1994
Retail milk			n.d. to 50		n.d. to 40			5	Germany	[35]	2000
Retail milk (container type 1) <sup>a</sup>	1.3–1.7	36–72	7.3–9.5	1.1–2.9	15–25			4	Spain	[34]	2004
Retail milk (container type 2) <sup>a</sup>	0.97–1.2	71–85	40–50	1.2–2.9	23–27			4	Spain	[34]	2004
Retail milk, skim (no fat)					20–25			2	Norway	[48]	1990
Retail milk, whole					50			1	United Kingdom	[48]	1990

Retail milk <sup>a</sup>		70		210		50	Italy	[44]	1986
Retail milk, skim (no fat)		n.d.	n.d.	10		1	Canada	[42]	1995
Retail milk, whole (3.3% fat)		n.d.	n.d.	100		1	Canada	[42]	1995
Retail milk (2% fat)		n.d.	n.d.	40		1	Canada	[42]	1995
<b>Dairy products</b>									
Yoghurt with fruit		<9	<4	15–37	<5	3	Denmark	[32]	2006
Retail butter				2500–7400		10	United Kingdom	[41]	1994
Retail butter spread/margarine				1200–2400		10	United Kingdom	[41]	1994
Retail cheese				200–16,800		25	United Kingdom	[41]	1994
Retail cream				200–2700		10	United Kingdom	[41]	1994
Retail cream (35% fat)				1060–1670		5	Norway	[41]	1994
Cream (31%–33% fat)				480, 550		2	Spain	[41]	1994
Retail cream (no %fat indicated)		n.d. to 70		180–320		6	Germany	[35]	2000
Retail milk, evaporated (7.6% fat)		n.d.	n.d.	130		1	Canada	[42]	1995
Ice cream (16.0% fat)		n.d.	n.d.	820		1	Canada	[42]	1995
Butter (80% fat)		1500	6400	3400		1	Canada	[42]	1995

(continued)

Table 37.2 (continued) Levels of Phthalates ( $\mu\text{g}/\text{kg}$ ) in Dairy Products and Other Foods

Type of Dairy Products	Level ( $\mu\text{g}/\text{kg}$ )						Size (n=)	Country	Ref.	Year of Publication
	DMP	DEP	DnBP	BBP	DEHP	DnOP				
Cheese, Cheddar (32.6% fat)			n.d.	1600	2200		1	Canada	[42]	1995
Cheese, cottage (3.0% fat)			n.d.	n.d.	70		1	Canada	[42]	1995
Cheese, processed (17.7% fat)			n.d.	n.d.	1100		1	Canada	[42]	1995
Cream (17.1% fat)			n.d.	n.d.	1200		1	Canada	[42]	1995
Yoghurt (8.6% fat)			n.d.	600	70		1	Canada	[42]	1995
<b>Baby food</b>										
Processed baby food			10–55		52–210		7	Germany	[33]	1998
Processed baby food			up to 40	up to 5	up to 630		11	Denmark	[43]	2000
Processed baby food			n.d. to 30		10–20		5	Germany	[35]	2000
Processed baby food <sup>a</sup>			n.d.		750		50	Italy	[44]	1986
<b>General food<sup>b</sup></b>										
Packaged food (nuts)			120–570		80–220		3	Germany	[35]	2000
Packaged food (cheese) <sup>a</sup>			840		1080		20	Italy	[44]	1986
Packaged food (fruit jam) <sup>a</sup>			n.d.		170		20	Italy	[44]	1986

Packaged food (potato chips) <sup>a</sup>		2800		350		20	Italy	[44]	1986
Packaged food (salted meat) <sup>a</sup>		1090		2380		20	Italy	[44]	1986
Packaged food (vegetable soups) <sup>a</sup>		2060		2090		20	Italy	[44]	1986
Cucumbers				242–347		30	China	[45]	2007
Tomatoes				311–517		30	China	[45]	2007
<b>Total diet</b>									
Energy equivalent diet		90–190	17–19	110–180		29	Denmark	[43]	2000
Hospital duplicate diet (7-day, 1999)		n.d. to 7	0.1–5.0	46–478		21	Japan	[46]	2003
Hospital duplicate diet (7-day, 2001)		2–7.1	0.6–2.8	77–103		21	Japan	[46]	2003

<sup>a</sup> Mean values.

<sup>b</sup> The data on general food in Canadian food basket survey [42] are not included. See Section 37.2.5 and Table 37.3.

have been conducted to measure various chemical contaminants in human milk [33,35–37] and to estimate the potential intake of these chemical contaminants by breast-fed infants [36,37]. A German study identified DnBP (10–50 µg/kg) and DEHP (10–20 µg/kg, except for one at 110 µg/kg) in five human milk samples [35]. Similar results were also obtained in an earlier German study in which ranges of DnBP (<20–51 µg/kg) and DEHP (<50–160 µg/kg) were reported from five human milk samples [33]. More extensive studies on phthalates in human milk have been recently reported from Canada [36] and Sweden [37]. The Canadian study analyzed 21 mothers during the first 6 months of their breast-feeding and collected a total of 86 milk samples. DnBP and DEHP were detected in almost all samples with a mean value of 0.87 and 222 µg/kg for DnBP and DEHP, respectively. DEP was only detected in 15 of the 86 samples, with a mean value of 0.31 µg/kg. The Canadian study also indicated that the levels of phthalates in human milk did not decrease during lactation as is the case for other persistent chemical contaminants [38–40]. The Swedish study reported measurements of phthalates in human milk samples collected from 42 breast-feeding women [37]. One milk sample was collected from each woman when her baby was 14–20 days old (median, 17 days). DEHP and BBP were detected in all samples, whereas a much lower detection frequency was obtained for DEP (8/42), DnBP (12/42), and DOP (10/42). Compared with the Canadian data, the Swedish data showed a lower mean value of DEHP (17 µg/kg). The higher mean value of DnBP (2.8 µg/kg) reported in the Swedish study might have contributed to the higher number of nondetectable (n.d.) values, where 1.5 µg/kg (half of the detection limit) was used to calculate the mean. Mean values of other phthalates were 0.30 µg/kg for DEP, 0.75 µg/kg for BBP, and 1.1 µg/kg for DOP, respectively.

### **37.2.2 Milk for General Consumption**

Besides the milk for consumption by infants, concentrations of phthalates in other milk and milk products have been reported. Measurements of 18 raw milk samples from Denmark showed the presence of DEHP in the range of 7–30 µg/kg, while DnBP, BBP, and DnOP were below the detection limit [32]. One hundred to 150 µg/kg of DEHP and up to 30 µg/kg of DnBP were detected in three raw milk samples from Germany [35]. The milking methods used in these two studies, however, were not specified.

The fat content in retail milk samples ranged from less than 0.1% in skim milk to approximately 3% in whole milk. Levels of phthalates in retail milk samples have been reported by various research groups in Spain, Norway, United Kingdom, Germany, Italy, and Canada. Again, DEHP was the most frequently detected major phthalate in these samples. The levels of DEHP in retail milk samples among the different studies ranged from a few µg/kg to several hundred µg/kg. The levels of DEHP in four Danish retail milk samples ranged from 13 to 27 µg/kg, similar to the levels in Danish raw milk samples measured in the same study [32]. However, the German study reported lower DEHP levels in retail milk (n.d. to 40 µg/kg) compared with raw milk (100–150 µg/kg) [35], most likely due to partial removal of fat in the production of retail milk. Sharman et al. have measured DEHP and total phthalates in a number of samples of retail milk from Norway (DEHP: 20–130 µg/kg), Spain (DEHP: up to 50 µg/kg), and United Kingdom (DEHP: up to 90 µg/kg) [42]. In addition to DnBP (7–50 µg/kg) and DEHP (15–27 µg/kg), the levels of DEP (36–72 µg/kg) and other phthalates were reported in another study on Spanish retail milk [34].

Phthalate levels in retail milk seem to vary considerably. In addition to the source and handling of the raw milk from which the retail milk is produced, packaging and manufacturing processes may be the contributing factors as well. Casajuana and Lacorte reported mean values of five

phthalates (DMP, DEP, DnBP, BBP, and DEHP) in retail milk packed in two types of containers (type 1: Tetra Brik and type 2: high-density polyethylene (HDPE)) [34]. DEP, DnBP, and DEHP were the three major phthalates identified. The concentrations of DMP and BBP were much lower at 1–3 µg/kg. There was a significant difference in DnBP levels (7–9 vs. 40–50 µg/kg) in the milk packed in Tetra Brik and HDPE, respectively.

### 37.2.3 Phthalates in Dairy Products

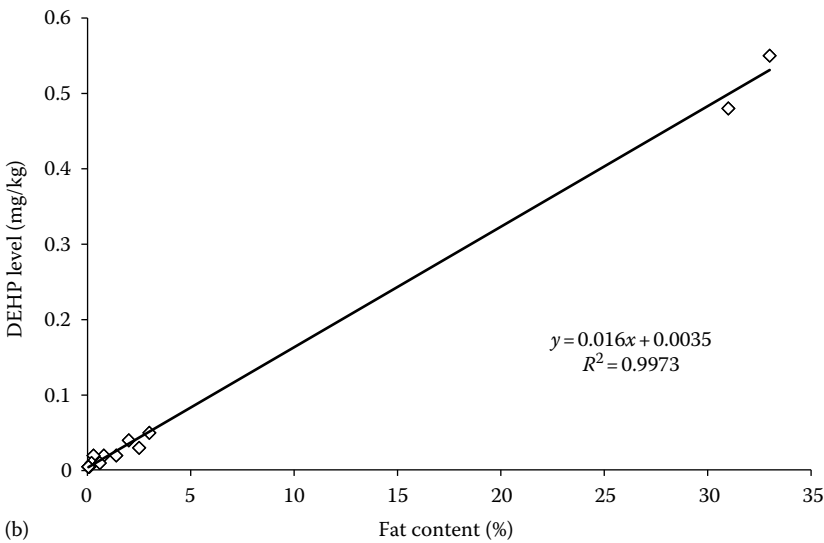
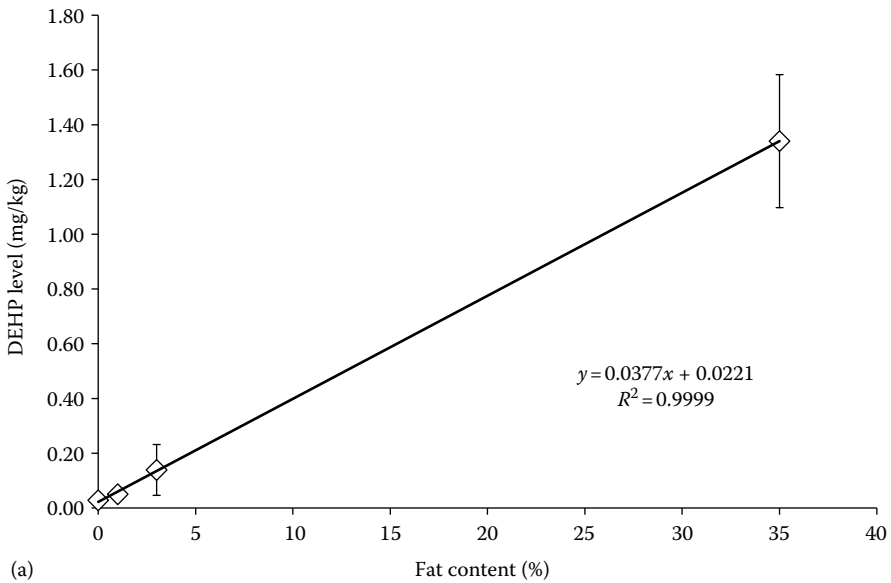
Many dairy products have been analyzed for phthalates. These have included yoghurt, butter, cheese, margarine, cream, and evaporated milk powder. The fat content in different milk products varies greatly, ranging from a few percent in yoghurt to 80% in butter. The levels of phthalates found in milk products are also listed in Table 37.2. The levels of phthalates in these dairy products were much higher on a per weight basis than those of milk owing to their higher fat content. For example, DEHP was found in 25 U.K. retail cheese samples at levels ranging from 200 to 16,800 µg/kg [41], among which, the highest DEHP levels were found in mild cheddar (16,800 µg/kg), Pompadom with herbs (14,900 µg/kg), and Old Amsterdam (7,500 µg/kg). DEHP levels in 10 U.K. cream samples were 200–2700 µg/kg, whereas in 10 butter samples their levels were 2500–7400 µg/kg [41]. The levels of DEHP in yoghurt were much lower [32,35]. DEHP is the predominant phthalate in milk products reported in these studies and DnBP was occasionally detected at low levels. The Canadian study, however, showed high levels of BBP in butter and Cheddar cheese at 6400 and 1600 µg/kg, respectively. The former product also contained a high level of DnBP (1500 µg/kg) [42].

The levels of DEHP in milk products such as cheese and butter were directly linked to their fat content. It was demonstrated that the levels of phthalates in retail milk were proportional to the percentage of fat in the milk [41]. For example, DEHP levels in the Norwegian retail milk (<1%, 1%, and 3%) and cream (35%) had a linear relationship with fat content (Figure 37.1a). Such fat dependency was also evident in the Spanish samples, where both DEHP and fat content were measured in dairy products (Figure 37.1b). The Canadian study on the measurement of phthalates in milk products provided further evidence of the relationship between DEHP levels in milk products and their fat content (Figure 37.1c) [42].

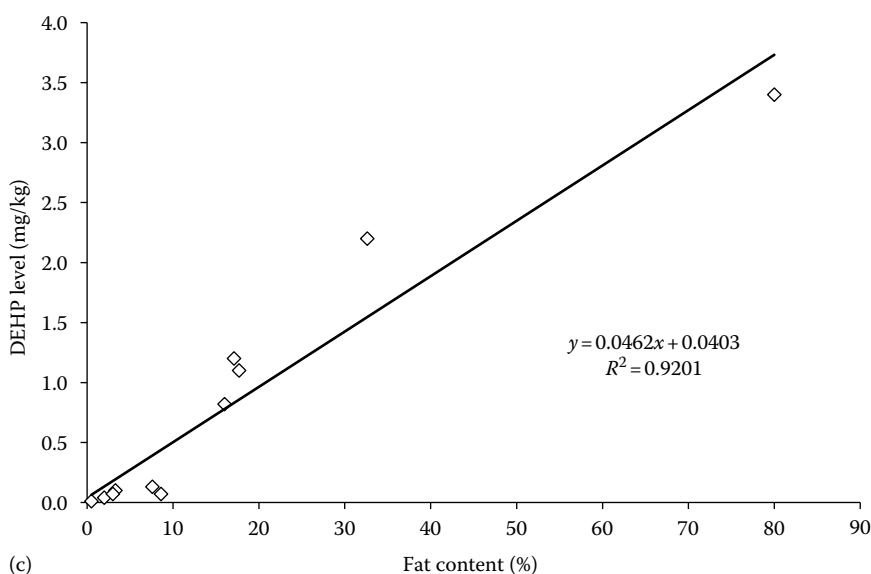
### 37.2.4 Phthalates in Nondairy Food Products

The presence of phthalates in foods extends well beyond the dairy products and includes baby food and packaged foods such as meats, vegetables, and fruits. Analysis of seven baby food samples sold in Germany revealed a concentration range of 10–55 µg/kg of DnBP and 52–210 µg/kg of DEHP, respectively [33]. A second German study also found phthalates in five baby food samples (DEHP in the range of 10–20 µg/kg and DnBP in the range of n.d. to 30 µg/kg) [35]. Eleven baby food samples sold in Denmark showed a maximum concentration of 40 µg/kg DnBP, 5 µg/kg BBP, and 360–630 µg/kg DEHP [43].

DEHP was detected in 93% of 50 Italian baby food samples with a mean value of 750 µg/kg and a maximum value of 3400 µg/kg; DnBP, on the other hand, was not detected in these samples. In general, as with dairy products, DEHP and DnBP are the two major phthalate congeners detected in baby foods. The only other phthalate detected in baby food is BBP, which is present at much lower concentrations (up to 5 µg/kg) [44]. The same Italian study also measured phthalates in several types of packaged foods including cheese, salted meat, vegetable soup, fruit jam, and



**Figure 37.1** Fat content and DEHP levels in dairy products. (a) Norwegian milk products collected at various points in the distribution chain [41]; error bar indicates one standard deviation obtained among samples at each fat content level, (b) retail milk and cream samples obtained from Spain [41], and (c) diary products of total diet samples in Canada [42].



**Figure 37.1 (continued).**

potato chips. The mean values of DEHP in these samples ranged from 170  $\mu\text{g}/\text{kg}$  in fruit jams to 2380  $\mu\text{g}/\text{kg}$  in salted meat, while the range of DnBP was in the range of n.d. to 1580  $\mu\text{g}/\text{kg}$ .

Measurement of phthalates in three different nut samples showed a range of DEHP levels at 80–220  $\mu\text{g}/\text{kg}$  and DnBP in the range of 120–570  $\mu\text{g}/\text{kg}$  [35]. A Chinese study on 30 cucumbers and 30 tomatoes purchased from the market detected 242–347  $\mu\text{g}/\text{kg}$  of DnBP and 311–517  $\mu\text{g}/\text{kg}$  of DEHP with a 100% detection frequency [45].

### 37.2.5 Phthalates in Total Diet

A total diet study consists of purchasing foods commonly consumed at the retail level, processing them for consumption, often combining the foods into food composites, homogenizing them, and analyzing them for the chemicals of interest. It is the most reliable way to estimate the dietary intake of chemicals by large population groups and is supported and recommended by the World Health Organization (WHO). Although total diet studies have been conducted in various countries for many different chemical contaminants, phthalates were determined in total diet samples only occasionally in a few countries. A total diet study conducted in Denmark based on 29 samples generated low to high ranges of mean values for DnBP (90–190  $\mu\text{g}/\text{kg}$ ), BBP (17–19  $\mu\text{g}/\text{kg}$ ), and DEHP (110–118  $\mu\text{g}/\text{kg}$ ), with a detection frequency of 8/29 for DnBP, 9/29 for BBP, and 6/29 for DEHP [43]. The diet sample in the study was not the second prepared portion of the food consumed, rather it was constituted from 24 h daily diet, and the phthalates levels were corrected to an equivalent of 10 MJ of energy, which is considered to be the mean energy intake for adults in Denmark. The Japanese duplicate diet studies conducted in three hospitals in 1999 and in 2001 yielded similar mean values of DEHP, i.e., 46–478  $\mu\text{g}/\text{kg}$  and 77–103  $\mu\text{g}/\text{kg}$  for the 1999 and 2001 samples, respectively, but much lower mean DnBP levels (n.d. to 7  $\mu\text{g}/\text{kg}$  in 1999 samples and 2–7.1  $\mu\text{g}/\text{kg}$  in 2001 samples) in the composite food [46].



In Canada, 99 of the 112 food-based total diet composites were collected in 1986 for the analysis of phthalates and other contaminants in 11 dairy products (Table 37.2) as well as 12 samples of meat, poultry, and fish, 19 cereal products, 18 vegetables, 16 fruits, and 23 miscellaneous [42]. Among meat, poultry, and fish products, DEHP was detected in ground beef (100 µg/kg), cured pork (500 µg/kg), poultry (2600 µg/kg), cold cut luncheon meat (200 µg/kg), canned luncheon meat (200 µg/kg), freshwater fish (100 µg/kg), and canned fish (100 µg/kg), whereas DnBP was detected in freshwater fish (500 µg/kg). Among vegetables and fruits, DEHP was detected in cabbage coleslaw (140 µg/kg), fresh tomato (90 µg/kg), cucumber and pickle (0.17 µg/kg), canned citrus fruit (50 µg/kg), and plum/prune (70 µg/kg), whereas DnBP was found in baked potato (630 µg/kg), banana (120 µg/kg), blueberry (90 µg/kg), and pineapple (50 µg/kg), and DEP in canned citrus fruit (40 µg/kg) and blueberry (730 µg/kg). Phthalates were also detected in 17 of the 19 cereal products (Table 37.3). In addition to DnBP and DEHP, a number of cereal products were found to contain DEP, while one product (crackers) contained BBzP (480 µg/kg). Other sampled foods that contained phthalates were margarine (DnBP, 640 µg/kg; DEHP, 1240 µg/kg), white sugar (DnBP, 200 µg/kg), instant pudding (410 µg/kg), chocolate bars (DnBP, 5300 µg/kg; DEHP, 510 µg/kg), soft drinks (90 µg/kg), muffins (1000 µg/kg), gelatin dessert (90 µg/kg), and canned meat soup (100 µg/kg). Levels of DEHP in the samples from the 1996 total diet study in Canada were in general lower or the same as those found in the 1986 study. For example, DEHP was not detected in 13 food composites compared with DEHP levels from 0.02 to 0.14 µg/g in the same food composites in 1986, while DEHP levels in butter (3.2 µg/g in 1996 vs. 3.4 µg/g in 1986) and ice cream (0.83 µg/g in 1996 vs. 0.82 µg/g in 1986) were about the same [47].

### 37.3 Migration of Phthalates into Milk and Other Dairy Products

Phthalates are not intentionally added to food but are there as contaminants from some other processes or sources. Phthalates in food may arise from contamination during the production and preparation of food. One of the main sources of such contamination results from the migration of phthalates from products that are in contact with food during food processing. A number of studies have been conducted on the migration of DEHP from PVC tubing in the machine milking used on dairy farms [48–51]. PVC tubing contains up to 40% DEHP by weight. A Norwegian study showed that there was a clear difference in DEHP levels between raw milk collected by hand milking (about 5 µg/kg) and by machine milking involving PVC tubing (30 µg/kg in milking chamber and 50 µg/kg in collection tank) [48]. This finding is corroborated by Canadian data showing that the average DEHP value in the raw milk collected by hand milking from six cows in a Canadian dairy farm was 16 µg/kg and this value increased to 215 µg/kg when the same cows were machine milked using PVC tubing. The DEP (0.6 µg/kg) and DnBP (6 µg/kg) values were not affected by the method of milking used [49].

These studies have demonstrated that although it is not the sole source of contamination, PVC tubing used on dairy farms contributes to the levels of DEHP in raw milk and ultimately in the retail milk and milk products. Both a clear time-dependent leaching of DEHP from PVC tubing into milk and a correlation between the leaching rate and the percentage of DEHP in the PVC tubes have been reported [50]. The same study also pointed out that retail milk from the United Kingdom still contained 35 µg/kg of DEHP after DEHP plasticizers were no longer used in milking machines. A feeding study on the postsecretory migration of DEHP from cows using

**Table 37.3 Phthalates Levels ( $\mu\text{g}/\text{kg}$ ) Found in 19 Cereal Products in a Canadian Total Diet Survey**

	<i>DEP</i>	<i>DBP</i>	<i>BBzP</i>	<i>DEHP</i>
White bread		90		680
Whole wheat bread	50	100		1500
Rolls and biscuits				1100
Wheat flour		1900		
Cakes				
Cookies		620		1500
Danish pastry and doughnut				3400
Crackers	1200	600	480	
Pancake				120
Cooked wheat cereal	170	300		
Cooked oatmeal cereal		100		
Corn cereal	40	100		820
Wheat and bran cereal	190	500		20
Rice				60
Apple pie	2200	40		80
Blueberry pie	1300			1000
Pizza				1200
Pasta		30		140

Source: Page, D.B. and Lacroix G.M., *Food Addit. Contam.*, 2, 129, 1995.

deuterated DEHP indicated that the secretory contamination of milk is negligibly low (3.2 ng/kg) compared with the ubiquitous background contamination [51].

Apart from the PVC tubing used in machine milking, other contamination sources must also be considered. Food-packaging materials have been evaluated for their contribution to the phthalate levels of foods they contain. Up to 11 mg/kg of DnBP and up to 61 mg/kg of DEHP in cardboard and paper used as food containers in four European countries were reported [7]. The migration of phthalates from packaging materials into food was also reported [52]. The paper bags intended for packaging and marketing sugar contained up to 450 mg/kg of DiBP and 200 mg/kg of DnBP, respectively; these phthalates were thought to originate from adhesives used in the joints of the packaging. The migration from packaging to sugar after 4 months storage was estimated at 74% for DiBP and 57% for DBP. Measurements of phthalates in retail packaging materials (plastic foil, paper, cardboard, and aluminum foil with color printing) used for various foods (sweets, wafers, meat, and milk products, frozen foods, vegetables, dry ready-to-cook products, and potato chips) were carried out in the Czech Republic. DnBP and DEHP were found in

all 42 tested materials at concentrations up to 1 g/kg [53]. A study of Brazilian food-packaging materials acquired on the retail market also showed the presence of DEHP and other plasticizers in PVC films manufactured for domestic use, squeeze bags for honey, and wrapping for soft milk candy at around 20%–35% (w/w). DEHP in packaging closure seals for fatty foods such as palm oil, coconut milk, and soft high-fat cheese was 18%–33% [53]. Page and Lacroix [42] have measured phthalates and di-2-ethylhexyl adipate (DEHA) plasticizers in Canadian food-packaging materials and food samples during the 1985–1989 survey. They showed wide use of DEHP-containing or DEHA-containing food-packaging materials and demonstrated the potential link between the presence of chemicals in packaging materials and in food. They also observed that some phthalates could migrate from aluminum foil paper laminates into foods wrapped with this packaging material. Retail samples of butter and margarine wrapped in aluminum foil paper laminate were found to contain DBP, BBP, and DEHP at levels up to 10.6, 47.8, and 11.9 µg/g, respectively [54].

## **37.4 Analytical Methods for the Detection of Phthalates in Dairy Products**

### **37.4.1 Avoidance of Sample Contamination**

The widespread presence of phthalates poses tremendous challenge to analytical chemists in their efforts to create contamination-free environment in the laboratory. Like the ubiquitous presence of phthalates in the environment, phthalates are common contaminants in the laboratory environment. They are present in air, solvents, and many tools and containers used in the laboratory. Among them, DEHP is usually the predominant phthalate in the blank. Various measures have been taken to reduce the phthalate contamination and achieve a low and stable blank level. The common precautions include rinsing all glassware coming in contact with samples with organic solvents such as methanol, acetone, and hexane [32,41–43], heating the glassware to a high temperature [31,35], or having the combination of heat treatment followed by solvent rinse [33,53]. In addition, septa, caps and sample vials [41], glass wool [52], and utensils for sample preparation [42] are generally solvent rinsed before use.

Other measures to reduce phthalate contamination include careful selection and prescreening of solvents [32], distillation of purchased solvents in an all-glass device [42,53], and avoiding using Latex or vinyl gloves when handling samples [33]. When adsorbent is to be used in sample clean up, it should be decontaminated by heating prior to use [32,54]. In some cases, sodium chloride for sample handling is heat-treated prior to use as well [55].

Another approach to reduce background levels of phthalates during sample treatment is solvent-less sample preparation such as use of solid-phase microextraction (SPME) techniques followed by gas chromatography/mass spectrometry (GC/MS) analysis [49]. In SPME, phthalates in the sample are pushed out into the headspace by heat in an enclosed vial. They are then adsorbed by the extraction fiber without involvement of any organic solvent in the sample treatment.

### **37.4.2 Sample Pretreatment, Extraction, and Cleanup**

Sample preparation methods employed in the analysis of milk and other products are summarized in Table 37.4. Liquid milk samples were processed as they were received. Powdered milk was first

**Table 37.4 Examples of Measurement Methods Employed in the Analysis of Phthalates in Dairy Products**

<i>Matrix</i>	<i>Preparation/Extraction</i>	<i>Clean Up</i>	<i>Analysis</i>	<i>Ref.</i>
Milk	Two grams of sample extracted with acetonitrile/hexane (not mixable)	Centrifuge, filtration	GC/MS	[31]
Milk	1.5 mL of milk mixed with 1.5 mL of methanol. Extracted with hexane/ <i>t</i> -butyl methyl ether	Shake with acetonitrile. Acetonitrile solution was cleaned up further with silica gel column eluted with ethyl acetate/hexane	LC/MS/MS	[32]
Milk	Ten milliliters of milk mixed with 10 mL of methanol and sonicated for 10 min afterwards, 80 mL of water were added	C-18 cartridge and further Florisil cartridge	GC/MS	[34]
Milk	Five grams of samples extracted using headspace SPME	Not needed	GC/MS	[49]
Milk and cream	Sample mixed with water and acetone, extracted with DCM, and filtered	DCM extract further cleaned up by GPC with cyclohexane	GC/MS	[35]
Milk, cream, butter, and cheese	Ten grams of sample mixed with 5 mL of methanol, 3 mL of hexane and ca 300 mg of KOH, and shaken well. Repeated two more times with hexane	Further cleaned up by GPC (Biobeads SX3) with DCM/cyclohexane 1:1	GC/MS	[41]
Milk, baby food	Ten grams of sample mixed with 20 mL of water. Extracted with cyclohexane	Further cleaned up by GPC (Biobeads SX3) with DCM/cyclohexane 1:1	GC/MS	[33]

reconstituted by mixing with water according to the manufacturer's instructions. For example, Casajuana and Lacorte reported mixing milk powder with water in a 1:10 ratio (3 g of powdered milk in 30 mL of water) [34]. Solid or semisolid samples such as baby food were also mixed with water before the extraction process [33].

Different combinations of organic solvents were used for the extraction of phthalates from milk. Owing to the presence of water content in the sample, generally a mixture of water-soluble solvents (methanol, acetonitrile) and water-insoluble solvents (hexane, dichloromethane [DCM],

cyclohexane) was used for the initial extraction. The extracts were then either centrifuged and filtered for subsequent instrumental analysis [31], or subjected to further clean up procedures, usually through an adsorbent column (C-18, silica gel, Florisil, etc.) for low fat milk samples [32,34] or a gel permeation column (GPC) in the case of samples with higher fat content such as cream and butter [33,35,41].

Feng et al. reported measurements of phthalates in milk using a headspace (HS) SPME technique, in which the adsorption fiber was suspended in the headspace of the vial containing milk samples allowing evaporated phthalates to be concentrated in the fiber [49]. Salt was added to the sample to aid the extraction efficiency.

The following paragraphs describe briefly some examples of extraction and cleanup methods for milk samples as examples.

Method 1 [31]: To 2 g of baby milk powder in a test tube, 1 mL of a mixture of isotope-labeled internal standards (DnBP- $d_4$  and DEHP- $d_4$ ) in acetonitrile (as internal standard) were added. The tube was capped and kept in a refrigerator overnight. The following day, 4.5 mL of acetonitrile, saturated with hexane, was added to the tube. After vigorous mixing (shaking and sonication), the mixture was centrifuged at 4000 rpm for 20 min and the upper solution was separated from the solid then filtered. The filtered solution was washed once with a small volume of hexane saturated with acetonitrile before undergoing GC/MS analysis.

Method 2 [32]: To 1.5 mL of milk in a 10 mL centrifuge tube, 50  $\mu$ L of internal standard mixture and 1.5 mL of methanol were added. After mixing, 2.0 mL of hexane and 2.0 mL of *tert*-butyl methyl ether were added and the mixture was shaken vigorously for 1 min followed by centrifugation at 1500 rpm for 2 min. The hexane/ether phase was transferred to another tube and the extraction was repeated once. The combined extract was evaporated to dryness at 70°C under nitrogen flow and redissolved in 3.0 mL of hexane. An aliquot (2.0 mL) of the hexane solution was shaken with 2.0 mL of acetonitrile for 1 min. The hexane phase was removed and the remaining acetonitrile phase was shaken with 1 mL of hexane. After removing the hexane phase completely, the acetonitrile solution was evaporated at 70°C under nitrogen flow and redissolved in 0.5 mL of acetonitrile for LC/MS/MS analysis.

Method 3 [33]: 10 g of sample spiked with internal standard DnBP- $d_4$  and DnOP- $d_4$  were mixed with 20 mL of water and 60 mL of cyclohexane. The mixture was shaken for 3 min and left to stand for at least 2 h. Afterwards, 60 mL of acetone were added to the mixture and again shaken for 3 min. The whole mixture was transferred to a centrifuge tube. The solution was carefully collected using a pipette and the residual was then mixed with 20 mL of cyclohexane once more. Both solutions were combined and evaporated to approximately 0.5–1 mL. The separation of phthalates from fat was achieved by GPC. The preparative GPC comprised of a Biobeds SX-3 column with an internal diameter of 16 mm and a length of 52 cm. The eluting solvent was a mixture of 50:50 cyclohexane/DCM at a flow rate of 3.0 mL/min. The phthalate fraction (eluting at 16–32 min) was collected and concentrated to 1 mL for GC/MS analysis.

Method 4 [34]: 10 mL of reconstituted milk spiked with 4-*n*-nonylphenol as surrogate was mixed with 10 mL of methanol and sonicated for 10 min. Afterwards, the mixture was diluted with 80 mL of high-performance liquid chromatography (HPLC) grade water and passed through a 0.5-g C-18 SPE cartridge that had been conditioned with 12 mL of 4:1 DCM/hexane, 12 mL of methanol, and 12 mL of water. After preconcentration, the adsorbent was rinsed with 15 mL of water and dried under vacuum. The trapped compounds were desorbed with 12 mL of 4:1 methylene chloride/hexane and the volume reduced for loading onto a 5 g Florisil cartridge that had been preconditioned with 60 mL of methanol and 60 mL of 4:1 DCM/hexane. The Florisil

cartridge was eluted with 40 mL of 4:1 DCM/hexane. Notice that the cartridge was further eluted with 40 mL of ethyl acetate to recover the more polar compounds (bisphenol A, nonylphenol, and bisphenol A diglycidyl ether) as the cotarget analytes under the same study. The eluent was evaporated to near dryness and reconstituted with ethyl acetate to a final volume of 0.3 mL with DEHP-*d*<sub>4</sub> being added as an internal standard.

Method 5 [49]: 5 g of milk were weighed into a 15 mL SPME vial using a pipette. A magnetic stirring bar and 2.5 g of sodium chloride were then added into the vial and the vial was closed with the vial cap. The vial was tightly closed to avoid possible leakage of gas when the vial was heated. The vial was then placed into a preheated oil bath (90°C) on a hot plate. The stirring speed was adjusted to ensure that the solution was well stirred. After 2 min, the SPME needle was punched through the cap into the headspace of the vial and the fiber (PDMS-100 μm) was pushed out from the protection needle to start headspace sampling. The SPME holder was placed at a height that would result in the tip of the inserted fiber being suspended about 1.5 cm above the milk sample. After the sampling was finished, the fiber was retracted into the protection needle. The needle was then removed from the sampling vial and inserted into a clean vial to protect the fiber from exposure to laboratory air. The needle was then immediately inserted into the GC injection port for GC/MS analysis.

### 37.4.3 Instrumental Conditions

Owing to the semivolatile nature of phthalates, instruments used in their analysis are either GC or HPLC. MS is almost a nominal detector nowadays for the measurements of phthalates. Although LC/MS is popular for the analysis of phthalate metabolites, such as the monoester of the phthalate, GC/MS is more common in the analysis of phthalates themselves.

For GC/MS analysis (Table 37.5), prepared samples were injected into the GC/MS at an injection temperature around 250°C (240°C–260°C reported from several studies). The commonly used GC capillary column for the separation of phthalates is a fused-silica capillary column containing 5% phenyl and 95% methyl polysiloxane with a column length of either 30 or 60 m. There are several different brands of such columns available including HP-5, DB-5, ZB-5, XTI-5, etc. The oven temperature programs varied greatly depending on the complexity of the samples and number of target analytes monitored. For example, the rise of oven temperature ranged from 6°C/min in one study to 15°C/min in another. Usually, the phthalates can be well separated under these oven temperature programs. Figure 37.2 shows a typical GC/MS chromatogram of six commonly monitored phthalates.

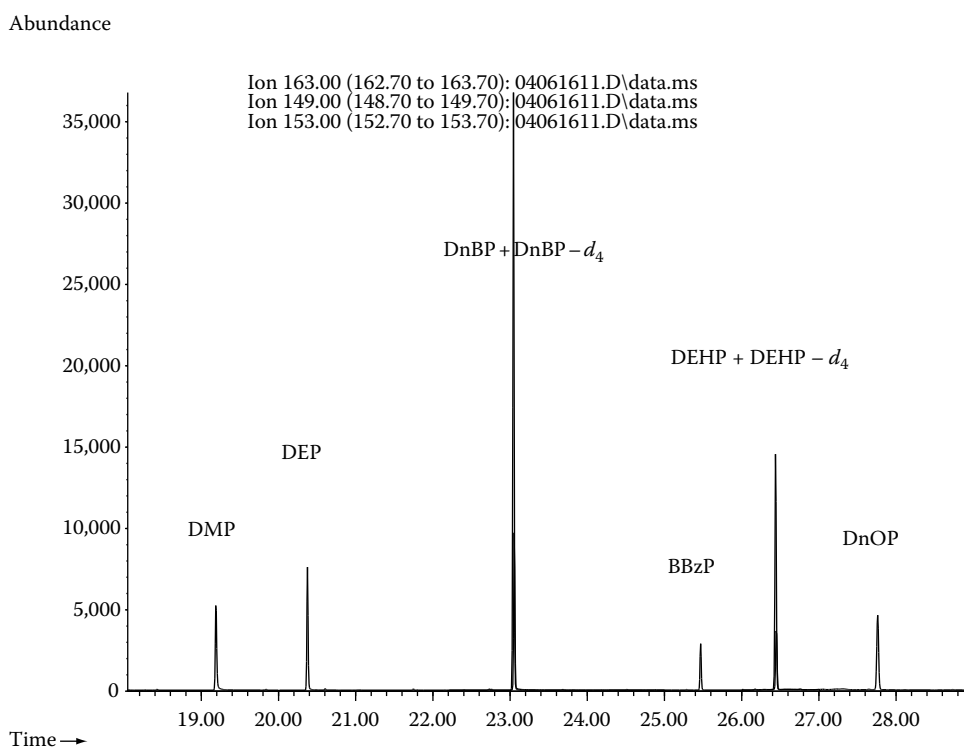
The separated phthalates were detected by a mass spectrometer usually operated under the selected ion-monitoring (SIM) mode. One target ion (T-ion) and two qualifier ions (Q-ion) were selected for each of the target phthalates. The base peak of *m/z* 149 was monitored as the T-ions for all phthalates except for DMP that had a base peak of *m/z* 163. The other characteristic fragments of phthalates are listed in Table 37.5. In practice, one has to consider the relative abundance of these fragments in selecting qualifier (Q-) ions. There were some variations in selecting Q-ions for phthalates among various studies. For example, Feng et al. selected Q-ions of *m/z* 77 and 194 for DMP; *m/z* 177 and 104 for DEP; *m/z* 223 and 104 for DBP; *m/z* 91 and 206 for BBP; *m/z* 167 and 279 for DEHP; *m/z* 279 and 104 for DOP [49], while Casajuana and Lacorte selected Q-ions of 77 and 135 for DMP, *m/z* 177 and 105 for DEP; *m/z* 223 and 76 for DBP; *m/z* 91 and 206 for BBP; and *m/z* 167 and 279 for DEHP [34].

**Table 37.5 GC/MS Operation Conditions for the Analysis of Phthalates in Dairy Products**

<i>Injection vol/temp</i>	<i>Column</i>	<i>Oven Temperature</i>	<i>MS</i>	<i>Quantification</i>	<i>Ref.</i>
1 $\mu$ L/260°C	ZB-05 (0.25 mm $\times$ 30 m $\times$ 0.25 $\mu$ m)	50°C (1 min), 15°C/min to 270°C (5 min)	NA	Comparing peak area with corresponding isotopic standard	[31]
1 $\mu$ L/NA	DB-5 (0.25 mm $\times$ 60 m $\times$ 0.25 $\mu$ m)	140°C (2 min), 10°C/min to 340°C	SIM	Relative response factor to $d_4$ -labeled standards	[33]
1 $\mu$ L/240°C	XTI-5 (0.25 mm $\times$ 30 m $\times$ 0.25 $\mu$ m)	90°C (1 min), 8°C/min to 250°C, 4°C/min to 280°C (5 min)	SIM	Relative response factor to $d_4$ -labeled standards	[43]
2 $\mu$ L/250°C	HP-5MS (0.25 mm $\times$ 30 m $\times$ 0.25 $\mu$ m)	60°C (1 min), 6°C/min to 175°C, 3°C/min to 280, 7°C/min to 300°C	SIM	Relative response factor to $d_4$ -labeled standards	[34]
SPME/280°C	DB-5 (0.25 mm $\times$ 30 m $\times$ 0.25 $\mu$ m)	55°C (1 min), 15°C/min to 280°C (15 min)	SIM	Relative response factor to $d_4$ -labeled standards	[49]

### 37.5 Concluding Remarks

Phthalates are present in foods and particularly in dairy products, owing to the high fat content of the latter. Oral intake is a major contributor to the total exposure of humans to this group of chemical contaminants. A recent study on sources of human exposure to phthalates among Europeans indicated a high proportion contributed by food, across all age groups, for DnBP and DEHP [56]. The contribution of foods to total DEHP exposure range from about 50% in infants and toddlers to almost 100% in teens and adults. The Canadian study on phthalates in human milk following a 6 month postpartum period also indicated a continuous human exposure to DnBP and DEHP, as there was no decrease in concentration levels in breast milk observed over the lactation period [36]. The migration of phthalates from phthalate-containing products and packages into food is one of the major sources of phthalates found in food. A reduction in phthalate concentrations in foods will significantly reduce the total human exposure to these chemicals.



**Figure 37.2** GC/MS chromatogram of six common phthalates and two isotope-labeled phthalates.

## References

1. Cousins, I. and Mackay, D. Correlating the physical–chemical properties of phthalate esters using the ‘three solubility’ approach. *Chemosphere*, 41, 1389, 2001.
2. do Nascimento Filho, I. et al. Identification of some plasticizers compounds in landfill leachate. *Chemosphere*, 50, 657, 2003.
3. Peñalver, A. et al. Determination of phthalate esters in water samples by solid-phase microextraction and gas chromatography with mass spectrometric detection. *J. Chromatogr. A*, 872, 191, 2000.
4. Fauser, P. and Thomsen, M. Sensitivity analysis of calculated exposure concentrations and dissipation of DEHP in a topsoil compartment: The influence of the third phase effect and dissolved organic matter (DOM). *Sci. Total Environ.*, 296, 89, 2002.
5. Suzuki, T. et al. Monitoring of phthalic acid monoesters in river water by solid-phase extraction and GC–MS determination. *Environ. Sci. Technol.*, 35, 3757, 2001.
6. Luke-Betlej, K. et al. Solid-phase microextraction of phthalates from water. *J. Chromatogr. A*, 938, 93, 2001.
7. Aurela, B., Kulmala, H., and Söderhjelm, L. Phthalates in paper and board packaging and their migration into Tenax and sugar. *Food Addit. Contam.*, 16, 571, 1999.



8. Uhde, E. et al. Phthalic esters in the indoor environment—Test chamber studies on PVC-coated wallcoverings. *Indoor Air*, 11, 150, 2001.
9. Wilkinson, C.F. and Lamb IV, J.C. The potential health effects of phthalate esters in children's toys: A review and risk assessment. *Regul. Toxicol. Pharmacol.*, 30, 140, 1999.
10. Bouma, K. and Schakel, D.J. Migration of phthalates from PVC toys into saliva simulant by dynamic extraction. *Food Addit. Contam.*, 19, 602, 2002.
11. Inoue, K. et al. The validation of column-switching LC/MS as a high-throughput approach for direct analysis of di(2-ethylhexyl) phthalate released from PVC medical devices in intravenous solution. *J. Pharmaceut. Biomed. Anal.*, 31, 1145, 2003.
12. Lin, Z.-P. et al. Determination of phthalate ester congeners and mixtures by LC/ESI-MS in sediments and biota of an urbanized marine inlet. *Environ. Sci. Technol.*, 37, 2100, 2003.
13. Otake, T., Yoshinaga, J., and Yanagisawa, Y. Analysis of organic esters of plasticizer in indoor air by GC-MS and GC-FPD. *Environ. Sci. Technol.*, 35, 3099, 2001.
14. Zhu, J. et al. Phthalates in indoor air of Canadian residences. In *Proceedings of the ISIAQ 7th International Conference*; 2003; Vol. 1, pp. 542–547.
15. Rudel, R.A. et al. Phthalates, alkylphenols, pesticides, polybrominated diphenyl ethers, and other endocrine-disrupting compounds in indoor air and dust. *Environ. Sci. Technol.*, 37, 4543, 2003.
16. Butte, W. and Heinzow, B. Pollutants in house dust as indicators of indoor contamination. *Rev. Environ. Contam. Toxicol.*, 175, 1, 2002.
17. Koch, H.M. et al. Internal exposure of the general population to DEHP and other phthalates—Determination of secondary and primary phthalate monoester metabolites in urine. *Environ. Res.*, 93, 177, 2003.
18. Brock, J.W. et al. Phthalate monoesters levels in urine of young children. *Bull. Environ. Contam. Toxicol.*, 68, 309, 2002.
19. Anderson, W.A.C. et al. Determination of isotopically labeled monoesterphthalates in urine by high performance liquid chromatography–mass spectrometry. *Analytes*, 127, 1193, 2002.
20. Blount, B.C. et al. Quantitative detection of eight phthalate metabolites in human urine using HPLC-APCI-MS/MS. *Anal. Chem.*, 72, 4127, 2000.
21. Blount, B.C. et al. Levels of seven urinary phthalate metabolites in a human reference population. *Environ. Health Persp.*, 108, 979, 2000.
22. Silva, M.J. et al. Determination of phthalate metabolites in human amniotic fluid. *Bull. Environ. Contam. Toxicol.*, 72, 1226, 2004.
23. Jobling, S. et al. A variety of environmentally persistent chemicals, including some phthalate plasticizers, are weakly estrogenic. *Environ. Health Persp.*, 103, 582, 1995.
24. Higuchi, T.T. et al. Effects of dibutyl phthalate in male rabbits following in utero, adolescent, or postpubertal exposure. *Toxicol. Sci.*, 72, 301, 2003.
25. Fukuwatari, T. et al. Elucidation of the toxic mechanism of the plasticizers, phthalic acid esters, putative endocrine disrupters: Effects of dietary di(2-ethylhexyl)phthalate on the metabolism of tryptophan to niacin in rats. *Biosci. Biotechnol. Biochem.*, 66, 705, 2002.
26. Lamb IV, J.C. et al. Reproductive effects of four phthalic acid esters in the mouse. *Toxicol. Appl. Pharmacol.*, 88, 255, 1987.
27. Poon, R. et al. Subchronic oral toxicity of di-*n*-octyl phthalate and di(2-ethylhexyl) phthalate in the rat. *Food Chem. Toxicol.*, 35, 225, 1997.
28. Colón, I. et al. Identification of phthalate esters in the serum of young Puerto Rican girls with premature breast development. *Environ. Health Persp.*, 108, 895, 2000.
29. Duty, S.M. et al. Phthalate exposure and human semen parameters. *Epidemiology*, 14, 269, 2003.
30. Bornehag, C.-G. et al. The association between asthma and allergic symptoms in children and phthalates in house dust: A nested case–control study. *Environ. Health Persp.*, 112, 1393, 2004.
31. Yano, K. et al. Phthalates levels in baby milk powder sold in several countries. *Bull. Environ. Contam. Toxicol.*, 74, 373, 2005.

32. Soerensen, L. Determination of phthalate in milk and milk products by liquid chromatography/tandem mass spectrometry. *Rapid Commun. Mass Spectrom.*, 20, 1135, 2006.
33. Gruber, L., Wolz, G., and Piringer, O. Analysis of phthalates in baby food. *Deutsche Lebensmittel-Rundschau*, 94, 177, 1998.
34. Casajuana, N. and Lacorte, S. New methodology for the determination of phthalate esters, bisphenol A, bisphenol A diglycidyl ether, and nonylphenol in commercial whole milk samples. *J. Agric. Food Chem.*, 52, 3702, 2004.
35. Bruns-Weller, E. and Pfordt, J. Determination of phthalic acid esters in foods, mother's milk, dust and textiles. *Umweltwissenschaften und Schadstoff-Forschung*, 12, 125, 2000.
36. Zhu, J. et al. Phthalate esters in human milk: Concentration variations over a six-month postpartum time. *Environ. Sci. Technol.*, 40, 5276, 2006.
37. Högberg, J. et al. Phthalate diesters and their metabolites in human breast milk, blood and urine as biomarkers of exposure in vulnerable populations. *Environ. Health Persp.*, in press.
38. Schecter, A., Ryan J.J., and Papke, O. Decrease in levels and body burden of dioxins, dibenzofurans, PCBS, DDE, and HCB in blood and milk in a mother nursing twins over a thirty-eight month period. *Chemosphere*, 27, 1807, 1998.
39. LaKind, J.S. et al. Methodology for characterizing distributions of incremental body burdens of 2,3,7,8-TCDD and DDE from breast milk in North American nursing infants. *J. Toxicol. Environ. Health Part A* 59, 605–639, 2000.
40. Yakushiji T. Contamination, clearance, and transfer of PCB from human milk. *Environ. Contam. Toxicol.*, 101, 139, 1988.
41. Sharman, M. et al. Levels of di-(2-ethylhexyl) phthalate and total phthalate ester in milk, cream, butter and cheese. *Food Addit. Contam.*, 11, 357, 1994.
42. Page, D.B. and Lacroix G.M. The occurrence of phthalate ester and di-2-ethylhexyl adipate plasticizers in Canadian packaging and food sampled in 1985–1989: A survey. *Food Addit. Contam.*, 2, 129, 1995.
43. Petersen, J.H. and Breindahl, T. Plasticizers in total diet samples, baby food and infant formulae. *Food Addit. Contam.*, 17, 133, 2000.
44. Cocchieri, R.A. Occurrence of phthalate esters in Italian packaged foods. *J. Food Protect.*, 49, 265, 1986.
45. Wang, M. et al. Matrix solid-phase dispersion and gas chromatography/mass spectrometry for the determination of phthalic acid esters in vegetables. *Chin. J. Chromatogr.*, 25, 577, 2007.
46. Tsumura, Y. et al. Estimated daily intake of plasticizers in 1-week duplicate diet samples following regulation of DEHP-containing PVC gloves in Japan. *Food Addit. Contam.*, 20, 317, 2003.
47. Castle, L., Gibert, J., and Eklund, T. Migration of plasticizer from poly(vinyl chloride) milk tubing. *Food Addit. Contam.*, 7, 591, 1990.
48. Feng, Y.L., Zhu, J., and Sensenstein, R. Development of a headspace solid phase microextraction method combined with gas chromatography mass spectrometry for the determination of phthalate esters in cow milk. *Anal. Chim. Acta*, 538, 41, 2005.
49. Ruuska, R.M. et al. Migration of contaminants from milk tubes and teat liners. *J. Food Protect.*, 50, 316, 1987.
50. Blüthgen, A. Organic migration agents into milk at farm level (illustrated with diethylhexylphthalate). *Bull. IDF*, 356, 39, 2003 [German].
51. Lopez-Espinosa, M.-J. et al. Oestrogenicity of paper and cardboard extracts used as food containers. *Food Addit. Contam.*, 24, 95, 2007.
52. Gajduskova, V., Jarosova, A., and Ulrich, R. Occurrence of phthalic acid esters in food packaging materials. *Potravinarske Vedy*, 14, 99, 1996.
53. de A. Freire, M.T., Santana, I.A., and Reyes, F.G.R. Plasticizers in Brazilian food-packaging materials acquired on the retail market. *Food Addit. Contam.*, 23, 93, 2006.
54. Page, B.D. and Lacroix, G.M. Studies into the transfer and migration of phthalate esters from aluminium foil paper laminates to butter and margarine. *Food Addit. Contam.*, 9, 197, 1992.

55. Tsumura, Y. et al. Eleven phthalate esters and di(2-ethylhexyl) adipate in one-week duplicate diet samples obtained from hospitals and their estimated daily intake. *Food Addit. Contam.*, 18, 449, 2001.
56. Wormuth, M. et al. What are the sources of exposure to eight frequently used phthalic acid esters in Europeans? *Risk Anal.*, 26, 803, 2006.

## Chapter 38

---

# Analysis of Antibiotics in Milk and Its Products

---

Jian Wang

### CONTENTS

38.1	Introduction.....	801
38.2	Analytical Methods .....	802
38.2.1	Screening Methods .....	803
38.2.2	Confirmatory Methods.....	804
38.2.2.1	Sample Preparation.....	804
38.2.2.2	Liquid Chromatography and Ultraperformance Liquid Chromatography Separation.....	805
38.2.2.3	Mass Spectrometry .....	810
38.2.2.4	LC–MS Confirmatory Criteria.....	811
38.3	Method Validation and Measurement Uncertainty.....	814
38.4	Conclusions .....	815
	References.....	815

### 38.1 Introduction

Antibiotics, also known as antimicrobial, antibacterial, or anti-infective agents, include synthetic compounds such as sulfonamides and natural compounds such as penicillins, tetracyclines, and

---

Disclaimer: The list of test kits, biosensors, SPE cartridges, and analytical columns described or mentioned in this chapter is by no means exhaustive and that any commercially available items cited do not in any way constitute an endorsement by the author.

some macrolides. The term antibiotics originally meant only natural substances produced by bacteria or fungi, but now it is often used to refer to both synthetic and natural compounds. Antibiotics are used in both human medicine and veterinary practice. In the livestock industry and fish farming, antibiotics are employed for therapeutic (disease control), prophylactic (disease prevention), and subtherapeutic (growth promotion) purposes. Consequently, if the withdrawal time after treatment is not respected, or if antibiotics are not used correctly, it could lead to the presence of antibiotic residues in foods of animal origin, which in turn may provoke allergic reactions in some hypersensitive individuals, or cause the problem of drug-resistant pathogenic bacterial strains [1–3]. Some antibiotics such as chloramphenicol, and nitrofurans and their metabolites are associated with serious toxic effects in humans causing bone marrow depression and aplastic anemia [4], and/or mutagenic and carcinogenic effects [5]. Therefore, they are not allowed to be present in food. To ensure the safety of food for consumers and to facilitate the interest of international trade, the U.S. Food and Drug Administration (FDA) [6], European Union (EU) [7,8], Canada [9], FAO/WHO [10], and other international regulatory bodies have established the relevant regulations and maximum residue limits (MRLs) to monitor the level of approved antibiotics present in food. For example, the EU Council Regulation (EEC) 2377/90 [7], which describes the procedure for the establishment of MRLs for veterinary medicinal products in food of animal origin, controls the use of veterinary drugs. The EU Council Directive 96/23/EC [11] regulates and implements the residue control limits, which are set under the EEC 2377/90, of pharmacologically active compounds, i.e., substances having anabolic effects, banned or unauthorized substances, veterinary drugs or antibiotics, environmental contaminants, etc. The Directive 96/23/EC divides all chemical residues into Group A compounds, which comprise banned substances such as chloramphenicol and nitrofurans, and Group B compounds, which comprise all registered veterinary drugs and other compounds with MRLs. Analytical methods often focus on the detection of antibiotic residues in raw materials, which serves as an effectively preventative measure to ensure that no residues beyond authorized or permitted levels are transferred into their end-products through food processing. However, this does not mean that there is no need to monitor antibiotic residues in final food products. Chloramphenicol and nitrofurans (Group A), and aminoglycosides,  $\beta$ -lactams, macrolides, sulfonamides, tetracyclines, quinolones, etc. (Group B) are common antibiotics that have been monitored and investigated actively in bovine, ovine, and/or caprine milk (raw material) [3,6,8,12–14], and occasionally in its products such as yogurt [15], cheese [16], and milk powder [17,18].

## 38.2 Analytical Methods

Analytical methods for the detection and/or determination of antibiotic residues in milk and its products fall in two categories: (1) screening methods such as microbial inhibition tests, rapid test kits, etc., and (2) confirmatory methods including gas chromatography with electron capture, flame ionization, or mass spectrometry (MS) detection; and liquid chromatography (LC) with ultraviolet (UV), fluorometric or electrochemical detection, or MS. Antibiotics are predominantly LC-amenable compounds, and therefore they are likely to be determined by LC techniques. According to the European Commission Decision 2002/657/EC, confirmatory methods for organic residues or contaminants shall provide information on the chemical structure of the analyte. Consequently, methods based only on chromatographic analysis without the use of spectrometric detection are not suitable on their own for use as confirmatory methods. However, if a single technique lacks sufficient specificity, the desired specificity shall be achieved by analytical

procedures consisting of suitable combinations of clean-up, chromatographic separation(s), and spectrometric detection [19].

### 38.2.1 Screening Methods

Common screening methods or techniques include microbial inhibition assay, rapid test kits, surface plasmon resonance (SPR) technology biosensor, enzyme-linked immunosorbent assay (ELISA), etc. Screening tests have advantages of easy-to-use, low cost, and high sample throughput, but they lack specificity and sometimes display a relatively high false-positive rate. There are numerous commercially available microbial inhibition and rapid test kits that are able to detect antibiotics in milk at or below the FDA safe tolerance levels or the EU MRLs. Those kits include various Charm test kits (both inhibition assay and rapid test) [20], Copan milk test (inhibition assay) [21], Delvotest SP and SP-NT (inhibition assay) [22], BetaStar and Penzym test kits (rapid test) [23], SNAP (rapid test) [24], etc. Microbial inhibition assays are nonspecific, and test for a broad spectrum of antibiotics. Microbial inhibition tests are time-consuming and it may take a few hours to complete a test. In contrast, rapid test kits, which are based on microbial receptor, enzymatic, or immunological assay, are fast and a test could be done in a few minutes [25]. The rapid test kits are somewhat selective, and can detect a specific family of antibiotics per kit or assay.

An SPR technology biosensor has proven to be a rapid and sensitive technique to detect chemical contaminants in food or milk. SPR biosensors are designed to be operated in real time and be able to detect single or multiple antibiotic residues in a sample with minimum sample preparation. A classical SPR device employs the immobilization of antibody, antigen, or other receptors to a sensor chip, and then measures the minute changes in the refractive index as a shift in the angle of total absorption of light incident on a metal layer carrying the receptors. An SPR biosensor has been investigated for its applications on the determination of sulfonamides [26], chloramphenicol [27], penicillins or beta-lactams [25,28,29], streptomycin [30], and tetracycline [31] in milk. Biacore Q with Qflex kits, which is dedicated for food applications, is capable of determining antibiotics including sulfadiazine (SDZ), sulfamethazine (SMZ), streptomycin, chloramphenicol, sulfonamides, and tylosin in various foods [32]. For example, the Qflex streptomycin kit can detect streptomycin and dihydrostreptomycin in bovine milk with limits of detection (LOD) at 28 µg/L. The Qflex chloramphenicol kit is validated for bovine milk to detect chloramphenicol with LOD at 0.03 µg/L (ppb). The test is straightforward with a relatively high sample throughput such that it may only take 8–10 h to analyze 40 milk samples. The Qflex kits are developed and validated for certain matrices, but there is the potential to validate the kit reagents for other matrices following certain method development and validation procedures.

ELISA that uses microtitration plates is a valuable technique to detect antibiotics in milk because of its high sensitivity, simplicity, and ability to screen a large number of small-volume samples. The test, however, could be time-consuming. Some studies have reported on the development of various ELISA kits for the detection of antibiotics in milk including tetracyclines [33], β-lactams or penicillins [34], aminoglycosides [35], chloramphenicol [36], fluoroquinolones [37], and sulfonamides [38]. A recent study demonstrated the applicability of a commercial ELISA kit to analyze 11 beta-lactams (nafcillin, ampicillin, amoxicillin, piperacillin, azlocillin, cloxacillin, penicillin G, dicloxacillin, oxacillin, metampicillin, and penicillin V) in milk with LOD below the EU MRLs [34].

### 38.2.2 *Confirmatory Methods*

Although LC with UV, fluorometric or electrochemical detection can be used to determine antibiotics, LC–MS has largely superseded other detection approaches and has become an important technique for quantifying and confirming antibiotic residues in milk and its products with respect to its sensitivity and specificity [3,12–14,39,40].

#### 38.2.2.1 *Sample Preparation*

Sample preparation serves as a critical step to extract and concentrate antibiotic residues into an aqueous buffer or solution that is suitable for LC–MS injection. Sample preparation for milk or its products with a sample size ranging from 1 to 5 g usually involves deproteinization and removal of fat and other interferences. Proteins can be precipitated using acetonitrile in a sample-to-solvent ratio of 1:2 to 1:5 [41–44], methanol [45], trichloroacetic acid (20% in water or methanol) [46–49], 5-sulfosalicylic acid [50], acetic acid [51], or sodium tungstate [52]. Deproteinization can also be achieved by means of ultrafiltration using a cut-off mass filter device [53–55]. Fat or lipids are removed using hexane and/or through centrifugation [3,14,52,54,56]. After deproteinization and/or removal of fat, further sample cleanup and/or concentration are necessary for reproducible chromatograms and improved mass spectrometric sensitivity using solid-phase extraction (SPE), liquid–liquid extraction (LLE) or liquid–liquid partitioning (LLP), matrix solid-phase dispersion (MSPD), etc. The SPE has been adopted as routine because of its advantage that sample extracts are further cleaned up, and therefore interferences are removed and matrix effects are reduced. Moreover, analytes are concentrated to achieve sensitivity with LODs at sub  $\mu\text{g}/\text{kg}$ . Commonly used SPE cartridges include hydrophilic–lipophilic balanced (HLB) [43,44,47,49,52,56], Strata-X [55], C18 [41,46,53], cation exchange (i.e., for aminoglycosides) [48,57], and anion exchange (i.e., for quinolone) [56]. The HLB cartridges, which are made from a copolymer of hydrophilic *N*-vinylpyrrolidone and lipophilic divinylbenzene reversed-phase sorbents, have been used widely as a result of its good retention and highly reproducible recoveries of acidic, basic, and neutral compounds, whether polar or nonpolar. Strata-X cartridges, which have functionality similar to HLB, provide comparable results in retaining these analytes. Generally, SPE is performed off-line by passing sample aqueous extracts through SPE cartridges (30–500 mg) that are placed onto a regulated vacuum manifold. Antibiotics are retained or trapped on the cartridges. After washing with water or buffer, they are eluted with a few milliliters of an appropriate organic solvent such as methanol or acetonitrile with or without pH adjustment, depending on the SPE binding mechanism. MSPD uses a solid supporting material such as sand mixed with samples that subsequently are packed into extraction cells, and antibiotics are extracted or eluted with heated water. MSPD has been recently reported to extract aminoglycosides, tetracyclines, quinolones, macrolides, and lincomycin from milk, yogurt, and cheese [15,16,58,59].

The adjustment of pH and/or addition of chelating agents prior to the SPE or during the extraction step are necessary to prevent the degradation of some antibiotics, and to enhance extraction efficiency based on antibiotic chemical properties and SPE bonding mechanism. For example, tetracyclines and sulfonamides require pH 2–4 [47,60,61], while macrolides and  $\beta$ -lactams prefer a slight basic buffer, i.e., pH 8 or 8.5 [40,43,44,52,53] to maintain the stability and/or to increase the hydrophobicity on reversed-phase SPE cartridges in relating to their  $pK_a$ s. Tetracyclines tend to form a strong complex with cations or metals ( $\text{Ca}^{2+}$  and  $\text{Mg}^{2+}$  ions), and bind to protein and silanol groups. Therefore, chelating agents such as McIlvain buffer or EDTA,  $\text{Na}_2\text{EDTA}$ , citric acid, oxalic acid, etc., are used to prevent the chelation of tetracyclines with metals or others to improve the extraction efficiency [16,47,60,62].

Under most circumstances, the respective parent antibiotics are targeted as marker residues; however, there are a few exceptions. First, nitrofurans including furazolidone, furaltadone, nitrofurazone, and nitrofurantoin are metabolized rapidly to 3-amino-2-oxazolidinone (AOZ), 3-amino-5-morpholinomethyl-2-oxazolidinone (AMOZ), semicarbazide (SC), and 1-aminohydantoin (AH) in animals, which are bound to proteins. Parent nitrofurans may not be detected in most food products. Therefore, an analytical method for the determination of nitrofurans often focuses on the detection of protein-bound residues or active side chains (Table 38.1). The extraction procedure requires an overnight acid hydrolysis and simultaneous derivatization of the released side chains with 2-nitrobenzaldehyde (2-NBA) to form their nitrophenyl derivatives that are able to be analyzed by LC-MS [5]. Second, when ceftiofur is administered parenterally to lactating dairy cattle, it is metabolized quickly to desfuoylceftiofur, which then forms a variety of metabolites and conjugates or is bound to proteins. Therefore, the EEC 2377/90 sets a MRL of 100 µg/kg for the sum of all residues retaining the β-lactam structure expressed as desfuoylceftiofur. The extraction involves the release of desfuoylceftiofur from the various conjugated forms with a reducing agent such as dithioerythritol followed by derivatization with iodoacetamide to form an acetamide derivative, i.e., desfuoylceftiofur acetamide, which is stable and suitable for LC-MS analysis [63,64]. Third, tetracyclines are susceptible to conformational degradation to their 4-epimers in aqueous solution and even during the sample preparation as a function of pH and temperature [16,47,49,60,62,65]. Therefore, quantification of both tetracyclines and their 4-epimers residues remains a challenge. Fourth, a few antibiotics are required to be monitored as the sum of the parent compound and its metabolite, examples of which include cephalixin and deacetylcephalexin, spiramycin and neospiramycin, enrofloxacin, and ciprofloxacin in milk [7,8].

### 38.2.2.2 *Liquid Chromatography and Ultraperformance Liquid Chromatography Separation*

Generally, the chromatographic separation of antibiotics relies on the use of reversed-phase columns prior to a mass spectrometer. A conventional LC with a C<sub>18</sub>-modified silica stationary phase is a practical choice [3,12–14], but more recently an ultraperformance liquid chromatography (UPLC) with sub-2 µm particle C18 columns has been reported with respect to its application for antibiotic analysis as well [66]. UPLC or other fast chromatography with sub-2 µm particle columns is a novel separation technology that has gained popularity in analytical chemistry. Particularly, when coupled with mass spectrometers capable of performing high-speed data acquisition, UPLC offers significant advantages in resolution, speed, and sensitivity [67,68]. The mobile phase composition, concentration, and pH are critical to the optimal ionization and chromatographic separation of antibiotics. Acetonitrile and methanol are two common organic solvents used as LC or UPLC mobile phases. Formic acid (0.1%), ammonium acetate, or ammonium formate (10–20 mM) can be employed as a mobile phase modifier. Heptafluorobutyric acid (HFBA, <20 mM), pentafluoropropionic acid (PFPA, <20 mM), or trifluoroacetic acid (TFA, <0.1%), which are ion-pair reagents, are used for the benefits of improved chromatographic peak shape and extended retention of polar analytes such as lincomycin and aminoglycosides on reversed-phased LC stationary phases [48,50,57,59]. However, it is known that ion-pair reagents such as HFBA, PFPA, and TFA could cause electrospray ionization (ESI) ion suppression, resulting in a significant loss in signal owing to ion-pairing effects in the ESI process, especially for compounds containing nitrogen atoms [69]. Therefore, ion-pair reagents should be avoided, if possible, to achieve better sensitivity for trace antibiotic detection. Alternatively, hydrophilic interaction chromatographic (HILIC) columns, which have the separation mechanism different from that of the reversed-phase



**Table 38.1 Examples of LC–MS Analysis of Antibiotic Residues in Milk and its Products**

Class	Compound	Matrix	Sample Preparation		LC	
			Extraction	Cleanup	Column	Mobile Phase
	Chloramphenicol	Milk	Deproteinization by acetonitrile	LLE with chloroform	Purospher Star RP-18 column, 55 × 4 mm, 3 μm	0.15% formic acid and methanol
Nitrofurans	Furazolidone (side chain: AOZ)	Milk	Overnight incubation and derivatization with 0.125 M HCl and 2-NBA	SPE with HLB and LLE with ethyl acetate	Inertsil ODS, 150 × 2.1 mm, 3.5 μm	20 mM ammonium acetate and methanol
	Furaltadone (side chain: AMOZ)					
	Nitrofurazone (side chain: SC)					
	Nitrofurantoin (side chain: AH)					
Aminoglycosides	Dihydrostreptomycin	Milk and milk powder	Deproteinization by 5% 5-sulfosalicylic acid		Alltima C18, 150 × 2.1 mm, 5 μm	6.4 mM ammonium formate, 1.9 mM pentafluoropropionic acid (PFPA) and acetonitrile
	Streptomycin					
β-Lactams	Amoxicillin	Milk	Deproteinization by acetonitrile and extraction with 0.1 M phosphate buffer (pH 8.5)	SPE with HLB	Luna C18(2), 250 × 4.6, 5 μm	1% acetic acid and methanol
	Ampicillin					
	Cephapirin					
	Cloxacillin					
	Penicillin G					
Macrolides	Spiramycin	Milk	Deproteinization by acetonitrile and extraction with 0.1 M phosphate buffer (pH 8)	SPE with HLB	Acquity UPLC BEH C18, 100 × 2.1 mm, 1.7 μm and YMC ODS-AQ S-3, 50 × 2 mm	UPLC: 10 mM ammonium acetate and acetonitrile. HPLC: 0.1% formic acid and acetonitrile
	Erythromycin					
	Neopsiramycin					

MS			Calibration	Sensitivity		Reference
Type	Ionization	Mass or Transitions		LOD or CC $\alpha$	LOQ or CC $\beta$	
QqLIT	ESI <sup>-</sup>	321 → 152, 194, 257	Matrix-matched. Deuterated (d5) chloramphenicol used as an internal standard	CC $\alpha$ = 0.02 µg/kg	CC $\beta$ = 0.04 µg/kg	Ronning et al. [4]
QqQ	ESI <sup>+</sup>	Monitored as nitrophenyl derivatives. 3-[(2-Nitrobenzylidene)-amino]-oxazolidin-2-one (NPAOZ). 236 → 134, 104, 149	Matrix-matched. SC hydrochloride- <sup>13</sup> C, <sup>15</sup> N <sub>2</sub> (SC + 3), 3-amino-2-oxazolidinone-d <sub>4</sub> (AOZ-d <sub>4</sub> ), and AMOZ-d <sub>5</sub> used as internal standards	0.1 ng/g		Chu and Lopez [5]
		Monitored as nitrophenyl derivatives. 5-Morpholin-4-ylmethyl-3-[(2-nitrobenzylidene)-amino]-oxazolidin-2-one (NPAMOZ). 335 → 128, 262, 291		0.1 ng/g		
		Monitored as nitrophenyl derivatives. 2-Nitrobenzaldehyde-semicarbazone (NPSC). 209 → 166, 192, 134		0.2 ng/g		
		Monitored as nitrophenyl derivatives. 1-[(2-Nitrobenzylidene)-amino]-imidazolidine-2,4-dione (NPAH). 249 → 104, 134, 178		0.2 ng/g		
QqQ	ESI <sup>+</sup>	584 → 263, 246	Matrix-matched.	CC $\alpha$ = 0.22 µg/kg	CC $\beta$ = 0.26 µg/kg	van Bruijnsvoort et al. [50]
		582 → 263, 246		CC $\alpha$ = 0.23 µg/kg	CC $\beta$ = 0.28 µg/kg	
QIT	ESI <sup>+</sup>	366 → 349	Matrix-matched	1 ng/mL		Holstege et al. [43]
		350 → 160, 191, 333		0.2 ng/mL		
		424 → 292, 320, 333		0.8 ng/mL		
		458 → 182, 299, 330		2 ng/mL		
		357 → 181, 198, 229		1 ng/mL		
QqTOF and QqQ	ESI <sup>+</sup>	Q-TOF: 843.5218 MS/MS: 843 → 174, 142	Matrix-matched. Roxithromycin used as an internal standard	UPLC/Q-TOF: 0.8–1.0 µg/kg. LC/MS/MS: 0.1–0.2 µg/kg		Wang and Leung [66]
		Q-TOF: 734.4690 MS/MS: 734 → 158, 576		UPLC/Q-TOF: 0.2–0.5 µg/kg. LC/MS/MS: 0.01 µg/kg		
		Q-TOF: 699.4432 MS/MS: 699 → 174, 142		UPLC/Q-TOF: 1.0 µg/kg. LC/MS/MS: 0.1–0.2 µg/kg		

(continued)

**Table 38.1 (continued) Examples of LC–MS Analysis of Antibiotic Residues in**

Class	Compound	Matrix	Sample Preparation		LC	
			Extraction	Cleanup	Column	Mobile Phase
	Oleandomycin					
	Tilmicosin					
	Tylosin A					
Sulfonamides	Sulfadiazine (SDZ)	Milk	Deproteinization by 20% trichloroacetic acid	SPE with HLB	SymmetryShield RP18, 150 × 2.1 mm, 3.5 μm	1 mM oxalic acid and acetonitrile
	Sulfathiazole (STZ)					
	Sulfamethazine (SMZ)					
	Sulfamethoxy-pyridazine (SMP)					
	Sulfamethoxazole (SMX)					
	Sulfadimethoxine (SDM)					
Tetracyclines	Tetracycline (TC) and 4-epi-tetracycline (4-epi-TC)	Milk	Deproteinization by 20% trichloroacetic acid	SPE with HLB	Alltima C18, 150 × 2.1 mm, 3 μm	1% formic acid and a mixture of acetonitrile and methanol
	Oxytetracycline (OTC) and 4-epi-oxytetracycline (4-epi-OTC)					
	Chlortetracycline (CTC) and 4-epi-chlortetracycline (4-epi-CTC)					
Quinolones	Ciprofloxacin	Milk	MSPD		Alltima C18, 250 × 4.6 mm, 5 μm	Water and methanol acidified with formic acid
	Danofloxacin					
	Enrofloxacin					
	Flumequine					
	Marbofloxacin					

## Milk and its Products

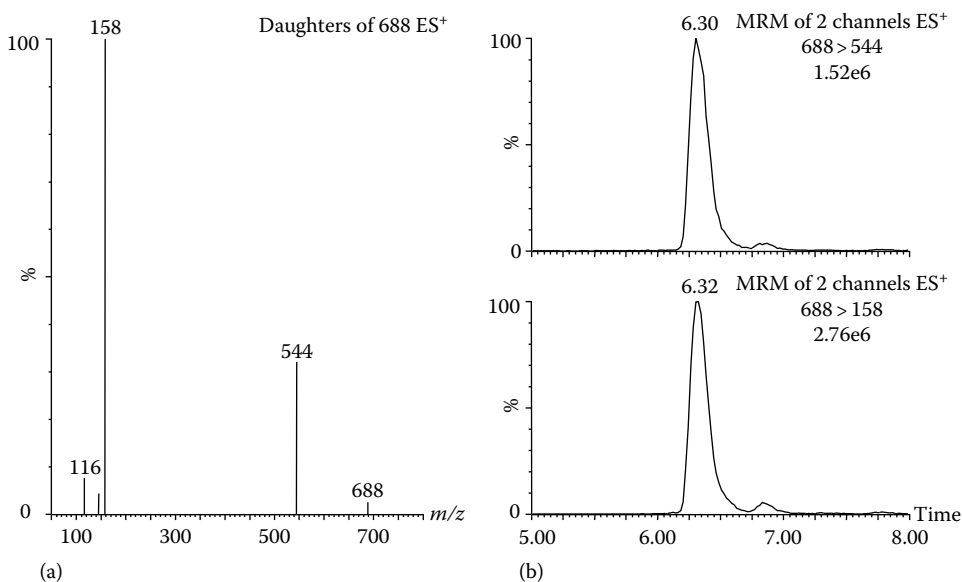
MS			Calibration	Sensitivity		Reference
Type	Ionization	Mass or Transitions		LOD or CC $\alpha$	LOQ or CC $\beta$	
		Q-TOF: 688.4272 MS/MS: 688 →158, 544		UPLC/Q-TOF: 0.2–0.5 $\mu$ g/kg. LC/MS/MS: 0.01 $\mu$ g/kg		
		Q-TOF: 869.5738 MS/MS: 869 →174, 132		UPLC/Q-TOF: 1.0 $\mu$ g/kg. LC/MS/MS: 0.2–0.5 $\mu$ g/kg		
		Q-TOF: 916.5270 MS/MS: 916 →174, 145		UPLC/Q-TOF: 0.2 $\mu$ g/kg. LC/MS/MS: 0.01–0.02 $\mu$ g/kg		
Q	ESI <sup>+</sup>	251, 156	Matrix-matched.	0.75 ng/mL	1.12 ng/mL	Koesukwiwat et al. [47]
		256, 108		1.27 ng/mL	4.16 ng/mL	
		279, 124		1.47 ng/mL	5.10 ng/mL	
		281, 126		0.87 ng/mL	3.00 ng/mL	
		254, 156		0.84 ng/mL	2.68 ng/mL	
		311, 156		0.48 ng/mL	0.61 ng/mL	
QqQ	ESI <sup>+</sup>	445 →410, 427	Matrix-matched. Demethylchlortetracycline used as an internal standard	TC: 7.8 $\mu$ g/L. 4-epi-TC: 10 $\mu$ g/L	TC: 8.8 $\mu$ g/L. 4-epi-TC: 12.2 $\mu$ g/L	De Ruyck and De Ridder [49]
		461 →426, 444		OTC: 25 $\mu$ g/L. 4-epi-OTC: 17.5 $\mu$ g/L	OTC: 29.4 $\mu$ g/L. 4-epi-OTC: 20.6 $\mu$ g/L	
		479 →444, 462		CTC: 7.5 $\mu$ g/L. 4-epi-CTC: 5 $\mu$ g/L	CTC: 9.1 $\mu$ g/L. 4-epi-CTC: 7.1 $\mu$ g/L	
QqQ	ESI <sup>+</sup>	332 →288, 314	Matrix-matched. Lomefloxacin used as an internal standard		Between 0.3 and 1.5 ng/mL	Bogialli et al. [58]
		358 →314, 340			Between 0.3 and 1.5 ng/mL	
		360 →316, 342			Between 0.3 and 1.5 ng/mL	
		262 →202, 244			1.5 ng/mL	
		363 →320, 72			0.3 ng/mL	

columns, can be used for better column retention of lincomycin and aminoglycosides without using any ion-pairing reagents [70]. Oxalic acid (1 mM), a chelating agent, is a mobile phase modifier for LC–MS analysis of tetracyclines to reduce peak tailing and to maintain their stability [47]. However, oxalic acid is not a good choice for ESI because of its low volatility, and therefore extra maintenance is needed to avoid clogging the capillary needle and to reduce ion source contamination through ion source cleaning, splitting the LC flow, and/or the use of a divert valve. It has been reported that some reversed-phase columns such as Alltima C<sub>18</sub> or Atlantis dC<sub>18</sub>, with the use of 0.1% formic acid and a mixture of methanol/acetonitrile as mobile phases, are suitable for LC–MS analysis of tetracyclines and their respective epimers where Gaussian distribution peak shape along with baseline resolution is able to be obtained [49,62].

### 38.2.2.3 *Mass Spectrometry*

Electrospray ionization (ESI) and atmospheric pressure chemical ionization (APCI) are two common LC–MS interfaces. ESI is applicable to polar and medium nonpolar analytes covering a very broad mass range, and therefore, it has become a popular LC–MS interface. Matrix effects can be a major challenge in LC–MS quantitative work, especially when ESI is used as the interface. Matrix can either enhance or suppress ionization of antibiotics, and its effects vary from sample to sample. Matrix effects are able to be estimated or determined by comparing the responses of analytes in the solvent or buffer to those in the presence of matrices [71]. The uses of isotopically labeled standards, matrix-matched standard calibration curves, and standard addition are general approaches utilized to overcome matrix effects and to improve accuracy of the method. Owing to a lack of deuterium-labeled standards for each individual antibiotic, matrix-matched standard calibration, with or without the use of a chemical analog as an internal standard, is the most common approach for reducing the matrix effects. The method of standard addition is effective in compensating for matrix effects, but the procedure can be very tedious and often requires additional sample preparation.

Mass spectrometers with various designs, performances, and functions that are currently available for the analysis of antibiotic residues include single quadrupole (Q), triple-quadrupole (QqQ), quadrupole ion trap (QIT), quadrupole linear ion trap (LIT), time-of-flight (TOF), and quadrupole time-of-flight (QqTOF) [3,12,14,39,40,72]. Examples of LC–MS analyses of antibiotic residues in milk and its products are presented in Table 38.1. A Q mass spectrometer is applicable for the analysis of antibiotics [47,73], but it has been replaced by a tandem mass spectrometer for improved sensitivity and specificity. A QqQ mass spectrometer operated in the multiple-reaction monitoring (MRM) mode is the most sensitive and common tool for quantifying and confirming antibiotics [5,15–17,42,44,49–54,58,59,66]. In general, a product ion spectrum (Figure 38.1a) is first acquired using a reference standard where MRM transitions are defined and selected to perform LC/MS/MS analysis (Figure 38.1b). A QIT mass spectrometer with its capability to perform MS/MS and MS<sup>n</sup> experiment and its relatively high sensitivity in scan mode makes it a valuable instrument to quantify and characterize antibiotics [41,43,48,57,74]. A triple-quadrupole linear ion-trap (QqLIT) mass analyzer has some novel functions that combine the advantages of a QqQ mass spectrometer and an ion-trap mass spectrometer within the same platform without compromising on the performance of either mass spectrometer [4]. A QqLIT mass spectrometer is very valuable for the determination of antibiotic residues because of its capability to perform MRM and acquire product ion scan spectra at low concentrations in one single run. TOF and QqTOF mass spectrometers, as a result of their high sensitivity in full-scan mode, medium-range high resolution, and accurate mass measurement capability, are emerging tools for screening, quantification, confirmation, and identification of antibiotics and their degradation products or

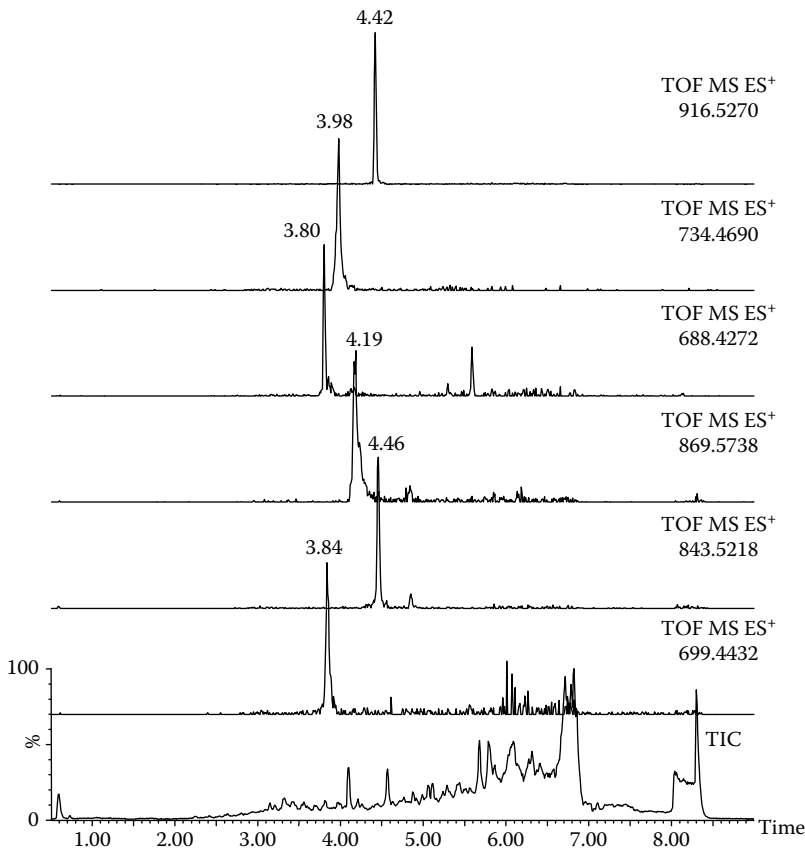


**Figure 38.1** (a) An ESI–MS/MS product ion spectrum of oleandomycin. (b) LC/MS/MS chromatograms of a blank raw milk sample fortified with oleandomycin (5 µg/kg). The mass spectrum and chromatograms are unpublished data and are obtained from the author’s previous research project, Calgary Laboratory, Canadian Food Inspection Agency. Instrumental parameters are described in the paper by Wang and Leung [66].

metabolites [66]. Figure 38.2 shows an example that uses the UPLC/QqTOF MS (full-scan) to screen six macrolides spiked in a blank milk sample, and extracted ion chromatograms are based on the accurate mass with the mass error window set at 50 mDa. Moreover, a QqTOF mass spectrometer can be operated in QqTOF MS/MS mode, which provides accurate mass product ion spectra for unequivocal confirmation of antibiotics in complex matrices, which eliminates false-positives and avoids ambiguous data interpretation. In general, QqQ, QIT, QqLIT, and TOF or QqTOF mass spectrometers are complementary to each other for the determination of antibiotic residues in milk and its products.

#### 38.2.2.4 LC–MS Confirmatory Criteria

LC–MS confirmatory criteria are well defined in the Decision 2002/657/EC [19] and the “Guidance for industry—Mass spectrometry for confirmation of the identity of animal drug residues” from the Center for Veterinary Medicine of the U.S. FDA [75]. The confirmatory characteristics generally include retention time and ion ratio with certain tolerances (Table 38.2). The retention time of an analyte in a chromatographic run should match that of the calibration standard within a specified relative retention time window, i.e., typically  $\pm 2.5\%$ . The relative abundances of two or more transitions should fall in the maximum permitted tolerances of the comparison standard. The FDA guidance recommends that the relative abundance ratio be within  $\pm 10\%$  absolute when two transitions are monitored. If three or more transitions are monitored, the relative abundance ratios should match the comparison standard within  $\pm 20\%$  absolute. The Decision 2002/657/EC has set relative abundance criteria that are dependent on the relative intensities of the two



**Figure 38.2** UPLC QTOF MS chromatograms of a blank milk sample fortified with six macrolides (5 µg/kg per analyte). TIC, total ion current. From bottom to top: 1, neospiramycin I; 2, spiramycin I; 3, tilmicosin; 4, oleandomycin; 5, erythromycin; 6, tylosin A. The chromatograms are unpublished data and are obtained from the author's previous research project, Calgary Laboratory, Canadian Food Inspection Agency. Instrumental parameters are described in the paper by Wang and Leung [66].

**Table 38.2** Maximum Permitted Tolerances for MS Relative Ion Intensity

Relative Intensity (% of Base Peak)	EU <sup>a</sup> (Relative) (%)	FDA <sup>b</sup> (Absolute)
>50	±20	
>20–50	±25	Two transitions: ±10%
>10–20	±30	More than two transitions: ±20%
≤10	±50	

<sup>a</sup> Criterion set by the Commission Decision 2002/657/EC [19].

<sup>b</sup> Criterion set by U.S. FDA [75].

transitions, and has also established an identification points (IPs) system to confirm organic residues and contaminants in live animals and animal products (Table 38.3) [19]. Regarding the assignment of IPs, for a low-resolution mass spectrometer (LRMS) with unit mass resolution such as QqQ, QIT, or QqLIT, one precursor ion and one transition product are assigned 1 and 1.5 IPs, respectively. According to the Decision 2002/657/EC, for the confirmation of substances such as chloramphenicol and nitrofurans listed in the Group A (banned substances) in the Directive 96/23/EC [11], a minimum of 4 IPs are required. For the confirmation of substances listed in the Group B (substances with established MRLs), a minimum of 3 IPs are required. Typically, two or three transitions (equivalent to 4 or 5.5 IPs), which are adequate for confirmation, are feasibly

**Table 38.3 Mass Resolution, Mass Accuracy, and IPs**

<i>MS Technique</i>	<i>IPs Obtained for Each Ion<sup>a</sup></i>
LRMS	1
LR-MS <sup>n</sup> precursor ion	1
LR-MS <sup>n</sup> product ion or transition products	1.5
HRMS	2
HR-MS <sup>n</sup> precursor ion	2
HR-MS <sup>n</sup> product ion or transition products	2.5
<i>Mass Accuracy</i>	
<i>IPs Obtained for Each Ion<sup>b</sup></i>	
Error higher than 10 mDa <sup>b</sup> or ppm <sup>c</sup>	
Single ion	1
Precursor ion	1
Product ion or transition products	1.5
Error between 2 and 10 mDa or ppm	
Single ion	1.5
Precursor ion	1.5
Product ion or transition products	2
Error below 2 mDa or ppm	
Single ion	2
Precursor ion	2
Product ion or transition products	2.5

<sup>a</sup> Criterion proposed by the Commission Decision 2002/657/EC [19].

<sup>b</sup> Criterion proposed by Hernandez et al. [76] and mass error in mDa.

<sup>c</sup> Criterion proposed by Wang and Leung [66] and mass error in ppm.



obtained using a low-resolution tandem mass spectrometer (Table 38.1). TOF and QqTOF are able to achieve as high as 15,000 FWHM resolution with mass accuracy less than 5 ppm, which provides specificity for target compound confirmation and permits assigning possible elemental compositions for unknown identification. In the Decision 2002/657/EC, high-resolution mass spectrometry (HRMS) is defined as the resolution that shall typically be greater than 10,000 for the entire mass range at 10% valley. This definition does not take into account mass accuracy and disadvantages TOF instruments for the confirmation of a chemical contaminant. Therefore, the criterion for IPs assignment (Table 38.3) based on mass measurement accuracy rather than on resolving power has been proposed, which uses either absolute [76] or relative mass errors [66]. The latter has an advantage that the IP rating criterion is consistent across a mass range or is independent of mass. Thus, for substances with established MRLs, at least two ions need to be monitored to achieve a minimum of 3 IPs for satisfactory confirmation of the compound's identity with mass errors that are between 2 and 10 mDa or ppm. Using in-source fragmentation or collision-induced dissociation with a low and high fragmentation or collision energy, a TOF or QqTOF instrument could acquire fragment-rich spectra, and therefore, additional IPs are able to be assigned for confirmation.

### 38.3 Method Validation and Measurement Uncertainty

Method validation is critical to ensure that a newly developed analytical method is reliable in routine practice. The method performance parameters that generally need to be evaluated include accuracy or recovery, trueness that uses certified reference materials, precision (repeatability, intermediate precision, and reproducibility), calibration curves or functions, analytical range, decision limit ( $CC\alpha$ ), detection capability ( $CC\beta$ ), LOD, limit of quantification (LOQ), specificity, ruggedness, analyte stability, estimation of measurement uncertainty, etc. The Decision 2002/657/EC [19] is a well-established EU legislative document that describes criteria and procedures for the validation of both screening and confirmatory methods to ensure the quality and comparability of analytical results generated by official laboratories. It is a guide that has been widely adopted and frequently cited in the food science community. In addition, there are many other scientific references [77–79] that can be followed for method validation.

Measurement uncertainty is an important aspect of an analytical method associated with its performance. It can be estimated using either in-house validation data or quality control data. Measurement uncertainty is defined as a parameter, associated with the result of a measurement, which characterizes the dispersion of values that could reasonably be attributed to the measurand [80]. It is commonly interpreted as an interval within which the true value lies with a probability. The measurement uncertainty associated with a result is an essential part of quantitative results. It provides comparability and reliability among accredited laboratories nationally and internationally. It is a root-cause analysis that helps one to identify the key factors contributing to large variations of a method. Many accreditation bodies have been requiring uncertainty values or estimations when a laboratory implements the ISO standard 17025 [81]. Uncertainty can be estimated either by calculating all the sources of uncertainty whenever possible using the “bottom-up” approach proposed by ISO [80] and EURACHEM/CITAC Guide [82], or through the commonly known “top-down” approach including the nested data analysis using information from interlaboratory study [83] and method validation results [44,84,85]. The main contributions of uncertainty for LC–MS analysis of antibiotics mainly result from the repeatability of the measurement and matrix effects [44].

## 38.4 Conclusions

Antibiotics have been widely used in veterinary practice, but are stringently controlled under regulations to ensure the safety of food supply. Antibiotic residues in milk and its products can be determined using either screening methods or confirmatory methods. Screening methods have advantages of easy-to-use, low cost, and high sample throughput, but they lack specificity. Confirmatory methods are required to confirm the positive findings, and LC–MS is the important technique for both quantification and confirmation. Organic solvents such as acetonitrile and methanol, and acids are often used to precipitate milk proteins. Hexane and/or centrifugation are employed to remove lipids and fat. Further sample cleanup and concentration through SPE, LLE, etc., are necessary to minimize interferences, to reduce matrix effects, and to improve sensitivity. Analytical methods are required to be validated, and measurement uncertainty should be estimated to ensure the quality and comparability of scientific data generated by analytical laboratories.

## References

1. Florea, N.F. and Nightingale, C.H., Review of the pharmacodynamics of antibiotic use in animal food production, *Diagn. Microbiol. Infect. Dis.*, 49, 105, 2004.
2. Mathur, S. and Singh, R., Antibiotic resistance in food lactic acid bacteria—A review, *Int. J. Food Microbiol.*, 105, 281, 2005.
3. Stolker, A.A.M. and Brinkman, U.A.T., Analytical strategies for residue analysis of veterinary drugs and growth-promoting agents in food-producing animals—A review, *J. Chromatogr. A*, 1067, 15, 2005.
4. Ronning, H.T., Einarsen, K., and Asp, T.N., Determination of chloramphenicol residues in meat, seafood, egg, honey, milk, plasma and urine with liquid chromatography-tandem mass spectrometry, and the validation of the method based on 2002/657/EC, *J. Chromatogr. A*, 1118, 226, 2006.
5. Chu, P.S. and Lopez, M.I., Determination of nitrofurans residues in milk of dairy cows using liquid chromatography-tandem mass spectrometry, *J. Agric. Food Chem.*, 55, 2129, 2007.
6. FDA Center for Veterinary Medicine: Database of Approved Animal Drug Products, <http://dil.vetmed.vt.edu/>.
7. Council Regulation (EEC) No 2377/90 of 26 June 1990 laying down a community procedure for the establishment of maximum residue limits of veterinary medicinal products in foodstuffs of animal origin, *Off. J. Eur. Communities*, L224, 18, 1990.
8. European Medicines Agency: Veterinary Medicines—Maximum Residue Limits (MRL), <http://www.emea.europa.eu/htms/vet/mrls/mrlop.htm>.
9. Health Canada, Drugs & Health Products, Veterinary Drugs, Maximum Residue Limits, [http://www.hc-sc.gc.ca/dhp-mps/vet/mrl-lmr/mrl-lmr\\_versus\\_new-nouveau\\_e.html](http://www.hc-sc.gc.ca/dhp-mps/vet/mrl-lmr/mrl-lmr_versus_new-nouveau_e.html).
10. FAO/WHO, CODEX alimentarius: Veterinary Drug Residues in Food Maximum Residue Limits, [http://www.codexalimentarius.net/mrls/vetdrugs/jsp/vetd\\_q-e.jsp](http://www.codexalimentarius.net/mrls/vetdrugs/jsp/vetd_q-e.jsp).
11. Council Directive 96/23/EC of 29 April 1996 on measures to monitor certain substances and residues thereof in live animals and animal products and repealing Directives 85/358/EEC and 86/469/EEC and Decisions 89/187/EEC and 91/664/EEC, *Off. J. Eur. Communities*, L125, 10, 1996.
12. Kennedy, D.G., McCracken, R.J., Cannavan, A., and Hewitt, S.A., Use of liquid chromatography-mass spectrometry in the analysis of residues of antibiotics in meat and milk, *J. Chromatogr. A*, 812, 77, 1998.
13. Schenck, F.J. and Callery, P.S., Chromatographic methods of analysis of antibiotics in milk, *J. Chromatogr. A*, 812, 99, 1998.
14. Di Corcia, A. and Nazzari, M., Liquid chromatographic-mass spectrometric methods for analyzing antibiotic and antibacterial agents in animal food products, *J. Chromatogr. A*, 974, 53, 2002.

15. Bogialli, S., Di Corcia, A., Lagana, A., Mastrantonio, V., and Sergi, M., A simple and rapid confirmatory assay for analyzing antibiotic residues of the macrolide class and lincomycin in bovine milk and yoghurt: Hot water extraction followed by liquid chromatography/tandem mass spectrometry, *Rapid Commun. Mass Spectrom.*, 21, 237, 2007.
16. Bogialli, S., Coradazzi, C., Di Corcia, A., Lagana, A., and Sergi, M., A rapid method based on hot water extraction and liquid chromatography-tandem mass spectrometry for analyzing tetracycline antibiotic residues in cheese, *J. AOAC Int.*, 90, 864, 2007.
17. Guy, P.A., Royer, D., Mottier, P., Gremaud, E., Perisset, A., and Stadler, R.H., Quantitative determination of chloramphenicol in milk powders by isotope dilution liquid chromatography coupled to tandem mass spectrometry, *J. Chromatogr. A*, 1054, 365, 2004.
18. Anderson, K.L., Lyman, R.L., Moats, W.A., Hansen, A.P., and Rushing, J.E., Comparison of microbial receptor assay and liquid chromatography for determination of penicillin G and amoxicillin in milk powder, *J. AOAC Int.*, 85, 546, 2002.
19. Commission Decision of 12 August 2002 implementing Council Directive 96/23/EC concerning the performance of analytical methods and the interpretation of results. 2002/657/EC., *Off. J. Eur. Communities*, L221, 8, 2002.
20. Charm Sciences Inc., <http://www.charm.com/>.
21. Copan Italia S.p.A., <http://www.copanswabs.com/>.
22. DSM Food Specialties, [http://www.dsm.com/en\\_US/html/dfs/dairy-products-tests-delvotest.htm](http://www.dsm.com/en_US/html/dfs/dairy-products-tests-delvotest.htm).
23. Chr. Hansen A/S, <http://www.chr-hansen.com/>.
24. IDEXX Laboratories, Inc., <http://www.idexx.com/dairy/snap/>.
25. Gustavsson, E. and Sternesjo, A., Biosensor analysis of beta-lactams in milk: Comparison with microbiological, immunological, and receptor-based screening methods, *J. AOAC Int.*, 87, 614, 2004.
26. Gaudin, V., Hedou, C., and Sanders, P., Validation of a Biacore method for screening eight sulfonamides in milk and porcine muscle tissues according to European decision 2002/657/EC, *J. AOAC Int.*, 90, 1706, 2007.
27. Gaudin, V. and Maris, P., Development of a biosensor-based immunoassay for screening of chloramphenicol residues in milk, *Food Agric. Immunol.*, 13, 77, 2001.
28. Gustavsson, E., Degelaen, J., Bjurling, P., and Sternesjo, A., Determination of beta-lactams in milk using a surface plasmon resonance-based biosensor, *J. Agric. Food Chem.*, 52, 2791, 2004.
29. Sternesjo, A. and Gustavsson, E., Biosensor analysis of beta-lactams in milk using the carboxypeptidase activity of a bacterial penicillin binding protein, *J. AOAC Int.*, 89, 832, 2006.
30. Ferguson, J.P., Baxter, G.A., McEvoy, J.D., Stead, S., Rawlings, E., and Sharman, M., Detection of streptomycin and dihydrostreptomycin residues in milk, honey and meat samples using an optical biosensor, *Analyst*, 127, 951, 2002.
31. Moeller, N., Mueller Seitz, E., Scholz, O., Hillen, W., Bergwerff, A.A., and Petz, M., A new strategy for the analysis of tetracycline residues in foodstuffs by a surface plasmon resonance biosensor, *Eur. Food Res. Technol.*, 224, 285, 2007.
32. General Electric Company, <http://www.biacore.com/>.
33. Zhang, Y., Lu, S., Liu, W., Zhao, C., and Xi, R., Preparation of anti-tetracycline antibodies and development of an indirect heterologous competitive enzyme-linked immunosorbent assay to detect residues of tetracycline in milk, *J. Agric. Food Chem.*, 55, 211, 2007.
34. Fitzgerald, S.P., O'Loan, N., McConnell, R.I., Benchikh el, O., and Kane, N.E., Stable competitive enzyme-linked immunosorbent assay kit for rapid measurement of 11 active beta-lactams in milk, tissue, urine, and serum, *J. AOAC Int.*, 90, 334, 2007.
35. Abuknesha, R.A. and Luk, C., Enzyme immunoassays for the analysis of streptomycin in milk, serum and water: Development and assessment of a polyclonal antiserum and assay procedures using novel streptomycin derivatives, *Analyst*, 130, 964, 2005.
36. Fodey, T., Murilla, G., Cannavan, A., and Elliott, C., Characterisation of antibodies to chloramphenicol, produced in different species by enzyme-linked immunosorbent assay and biosensor technologies, *Anal. Chim. Acta*, 592, 51, 2007.

37. Van Coillie, E., De Block, J., and Reybroeck, W., Development of an indirect competitive ELISA for flumequine residues in raw milk using chicken egg yolk antibodies, *J. Agric. Food Chem.*, 52, 4975, 2004.
38. Spinks, C.A., Schut, C.G., Wyatt, G.M., and Morgan, M.R., Development of an ELISA for sulfachlorpyridazine and investigation of matrix effects from different sample extraction procedures, *Food Addit. Contam.*, 18, 11, 2001.
39. Kotretsou, S.I., Determination of aminoglycosides and quinolones in food using tandem mass spectrometry: A review, *Crit. Rev. Food Sci. Nutr.*, 44, 173, 2004.
40. Gonzalez de la Huebra, M.J., and Vincent, U., Analysis of macrolide antibiotics by liquid chromatography, *J. Pharm. Biomed. Anal.*, 39, 376, 2005.
41. Heller, D.N. and Ngoh, M.A., Electrospray ionization and tandem ion trap mass spectrometry for the confirmation of seven beta-lactam antibiotics in bovine milk, *Rapid Commun. Mass Spectrom.*, 12, 2031, 1998.
42. Daeleire, E., De Ruyck, H., and Van Renterghem, R., Confirmatory assay for the simultaneous detection of penicillins and cephalosporins in milk using liquid chromatography/tandem mass spectrometry, *Rapid Commun. Mass Spectrom.*, 14, 1404, 2000.
43. Holstege, D.M., Puschner, B., Whitehead, G., and Galey, F.D., Screening and mass spectral confirmation of beta-lactam antibiotic residues in milk using LC-MS/MS, *J. Agric. Food Chem.*, 50, 406, 2002.
44. Wang, J., Leung, D., and Lenz, S.P., Determination of five macrolide antibiotic residues in raw milk using liquid chromatography-electrospray ionization tandem mass spectrometry, *J. Agric. Food Chem.*, 54, 2873, 2006.
45. Moats, W.A., Liquid chromatographic approaches to antibiotic residue analysis, *J. Assoc. Off. Anal. Chem.*, 73, 343, 1990.
46. Cinquina, A.L., Robertia, P., Giannettia, L., Longoa, F., Draiscib, R., Fagioloa, A., and Brizioli, N.R., Determination of enrofloxacin and its metabolite ciprofloxacin in goat milk by high-performance liquid chromatography with diode-array detection Optimization and validation, *J. Chromatogr. A.*, 987, 221, 2003.
47. Koesukiwat, U., Jayanta, S., and Leepipatpiboon, N., Validation of a liquid chromatography-mass spectrometry multi-residue method for the simultaneous determination of sulfonamides, tetracyclines, and pyrimethamine in milk, *J. Chromatogr. A.*, 1140, 147, 2007.
48. Cherlet, M., De Baere, S., and De Backer, P., Quantitative determination of dihydrostreptomycin in bovine tissues and milk by liquid chromatography-electrospray ionization-tandem mass spectrometry, *J. Mass Spectrom.*, 42, 647, 2007.
49. De Ruyck, H. and De Ridder, H., Determination of tetracycline antibiotics in cow's milk by liquid chromatography/tandem mass spectrometry, *Rapid Commun. Mass Spectrom.*, 21, 1511, 2007.
50. van Bruijnsvoort, M., Ottink, S.J., Jonker, K.M., and de Boer, E., Determination of streptomycin and dihydrostreptomycin in milk and honey by liquid chromatography with tandem mass spectrometry, *J. Chromatogr. A.*, 1058, 137, 2004.
51. Ghidini, S., Zanardi, E., Varisco, G., and Chizzolini, R., Residues of beta-lactam antibiotics in bovine milk: Confirmatory analysis by liquid chromatography tandem mass spectrometry after microbial assay screening, *Food Addit. Contam.*, 20, 528, 2003.
52. Dubois, M., Fluchard, D., Sior, E., and Delahaut, P., Identification and quantification of five macrolide antibiotics in several tissues, eggs and milk by liquid chromatography-electrospray tandem mass spectrometry, *J. Chromatogr. B.*, 753, 189, 2001.
53. Riediker, S. and Stadler, R.H., Simultaneous determination of five beta-lactam antibiotics in bovine milk using liquid chromatography coupled with electrospray ionization tandem mass spectrometry, *Anal. Chem.*, 73, 1614, 2001.
54. Riediker, S., Rytz, A., and Stadler, R.H., Cold-temperature stability of five beta-lactam antibiotics in bovine milk and milk extracts prepared for liquid chromatography-electrospray ionization tandem mass spectrometry analysis, *J. Chromatogr. A.*, 1054, 359, 2004.

55. Marazueta, M.D. and Moreno-Bondi, M.C., Multiresidue determination of fluoroquinolones in milk by column liquid chromatography with fluorescence and ultraviolet absorbance detection, *J. Chromatogr. A*, 1034, 25, 2004.
56. Lara, F.J., Garcia-Campana, A.M., Ales-Barrero, F., Bosque-Sendra, J.M., and Garcia-Ayuso, L.E., Multiresidue method for the determination of quinolone antibiotics in bovine raw milk by capillary electrophoresis-tandem mass spectrometry, *Anal. Chem.*, 78, 7665, 2006.
57. Heller, D.N., Clark, S.B., and Righter, H.F., Confirmation of gentamicin and neomycin in milk by weak cation-exchange extraction and electrospray ionization/ion trap tandem mass spectrometry, *J. Mass Spectrom.*, 35, 39, 2000.
58. Bogialli, S., D'Ascenzo, G., Di Corcia, A., Lagana, A., and Nicolardi, S., A simple and rapid assay based on hot water extraction and liquid chromatography-tandem mass spectrometry for monitoring quinolone residues in bovine milk, *Food Chem.*, 108, 354, 2008.
59. Bogialli, S., Curini, R., Di Corcia, A., Lagana, A., Mele, M., and Nazzari, M., Simple confirmatory assay for analyzing residues of aminoglycoside antibiotics in bovine milk: Hot water extraction followed by liquid chromatography-tandem mass spectrometry, *J. Chromatogr. A*, 1067, 93, 2005.
60. Anderson, C.R., Rupp, H.S., and Wu, W.H., Complexities in tetracycline analysis—chemistry, matrix extraction, cleanup, and liquid chromatography, *J. Chromatogr. A*, 1075, 23, 2005.
61. Wen, Y., Zhang, M., Zhao, Q., and Feng, Y.Q., Monitoring of five sulfonamide antibacterial residues in milk by in-tube solid-phase microextraction coupled to high-performance liquid chromatography, *J. Agric. Food Chem.*, 53, 8468, 2005.
62. Khong, S.P., Hammel, Y.A., and Guy, P.A., Analysis of tetracyclines in honey by high-performance liquid chromatography/tandem mass spectrometry, *Rapid Commun. Mass Spectrom.*, 19, 493, 2005.
63. Becker, M., Zittlau, E., and Petz, M., Quantitative determination of ceftiofur-related residues in bovine raw milk by LC-MS/MS with electrospray ionization, *Eur. Food Res. Technol.*, 217, 449, 2003.
64. Makeswaran, S., Patterson, I., and Points, J., An analytical method to determine conjugated residues of ceftiofur in milk using liquid chromatography with tandem mass spectrometry, *Anal. Chim. Acta*, 529, 151, 2005.
65. Blanchflower, W.J., McCracken, R.J., Haggan, A.S., and Kennedy, D.G., Confirmatory assay for the determination of tetracycline, oxytetracycline, chlortetracycline and its isomers in muscle and kidney using liquid chromatography-mass spectrometry, *J. Chromatogr. B*, 692, 351, 1997.
66. Wang, J. and Leung, D., Analyses of macrolide antibiotic residues in eggs, raw milk, and honey using both ultra-performance liquid chromatography/quadrupole time-of-flight mass spectrometry and high-performance liquid chromatography/tandem mass spectrometry, *Rapid Commun. Mass Spectrom.*, 21, 3213, 2007.
67. Churchwell, M.I., Twaddle, N.C., Meeker, L.R., and Doerge, D.R., Improving LC-MS sensitivity through increases in chromatographic performance: Comparisons of UPLC-ES/MS/MS to HPLC-ES/MS/MS, *J. Chromatogr. B*, 825, 134, 2005.
68. Guillaume, D., Nguyen, D.T., Rudaz, S., and Veuthey, J.L., Recent developments in liquid chromatography—Impact on qualitative and quantitative performance, *J. Chromatogr. A*, 1149, 20, 2007.
69. Gustavsson, S.A., Samskog, J., Markides, K.E., and Langstrom, B., Studies of signal suppression in liquid chromatography-electrospray ionization mass spectrometry using volatile ion-pairing reagents, *J. Chromatogr. A*, 937, 41, 2001.
70. Peru, K.M., Kuchta, S.L., Headley, J.V., and Cessna, A.J., Development of a hydrophilic interaction chromatography-mass spectrometry assay for spectinomycin and lincomycin in liquid hog manure supernatant and run-off from cropland, *J. Chromatogr. A*, 1107, 152, 2006.
71. Matuszewski, B.K., Constanzer, M.L., and Chavez-Eng, C.M., Strategies for the assessment of matrix effect in quantitative bioanalytical methods based on HPLC-MS/MS, *Anal. Chem.*, 75, 3019, 2003.
72. Gentili, A., Perret, D., and Marchese, S., Liquid chromatography-tandem mass spectrometry for performing confirmatory analysis of veterinary drugs in animal-food products, *Trends Anal. Chem.*, 24, 704, 2005.

73. Huang, J.F., Zhang, H.J., and Feng, Y.Q., Chloramphenicol extraction from honey, milk, and eggs using polymer monolith microextraction followed by liquid chromatography-mass spectrometry determination, *J. Agric. Food Chem.*, 54, 9279, 2006.
74. Klagkou, K., Pullen, F., Harrison, M., Organ, A., Firth, A., and Langley, G.J., Fragmentation pathways of sulphonamides under electrospray tandem mass spectrometric conditions, *Rapid Commun. Mass Spectrom.*, 17, 2373, 2003.
75. Guidance for industry. *Mass Spectrometry for Confirmation of the Identity of Animal Drug Residues. Final Guidance*. U.S. Department of Health and Human Services Food and Drug Administration Center for Veterinary Medicine. May 1 2003, <http://www.fda.gov/cvm/guidance/guide118.pdf>, 2003.
76. Hernandez, F., Ibanez, M., Sancho, J.V., and Pozo, O.J., Comparison of different mass spectrometric techniques combined with liquid chromatography for confirmation of pesticides in environmental water based on the use of identification points, *Anal. Chem.*, 76, 4349, 2004.
77. The Fitness for purpose of analytical methods. A laboratory guide to method validation and related topics, <http://www.eurachem.org/guides/valid.pdf>, 1998.
78. Guidance for industry. *Validation of Analytical Procedures: Methodology. Final Guidance*. U.S. Department of Health and Human Services, Food and Drug Administration, Center for Veterinary Medicine, <http://www.fda.gov/cvm/Guidance/guida64.pdf>, 1999.
79. Thompson, M., Ellison, S.L.R., and Wood, R., Harmonized guidelines for single-laboratory validation of methods of analysis, *Pure Appl. Chem.*, 74, 835, 2002.
80. *Guide to the Expression of Uncertainty in Measurement*, International Standards Organization (ISO), Geneva, 1993.
81. ISO/IEC 17025:2005, *General Requirements for the Competence of Testing and Calibration Laboratories*, 2005.
82. EURACHEM/CITAC Guide. *Quantifying Uncertainty in Analytical Measurement*, 2nd edn., <http://www.eurachem.org/guides/QUAM2000-1.pdf>, 2000.
83. Dehouck, P., Vander Heyden, Y., Smeyers Verbeke, J., Massart, D.L., Crommen, J., Hubert, P., Marini, R.D., Smeets, O.S.N.M., Decristoforo, G., Van de Wauw, W., De Beer, J., Quaglia, M.G., Stella, C., Veuthey, J.L., Estevenon, O., Van Schepdael, A., Roets, E., and Hoogmartens, J., Determination of uncertainty in analytical measurements from collaborative study results on the analysis of a phenoxymethylpenicillin sample, *Anal. Chim. Acta*, 481, 261, 2003.
84. Maroto, A., Boque, R., Riu, J., and Rius, F.X., Measurement uncertainty in analytical methods in which trueness is assessed from recovery assays, *Anal. Chim. Acta*, 440, 171, 2001.
85. Barwick, V. and Ellison, S.L.R., Measurement uncertainty: Approaches to the evaluation of uncertainties associated with recovery, *Analyst*, 124, 981–990, 1999.



## Chapter 39

# Environmental Contaminants

Sara Bogialli and Antonio Di Corcia

## CONTENTS

39.1	Introduction.....	821
39.1.1	Persistent Organic Pollutants .....	822
39.1.2	Pesticides .....	823
39.2	Regulations .....	824
39.3	Analysis of Pesticides and POPs in Dairy Foods .....	825
39.3.1	Extraction.....	825
39.3.1.1	Analyte Extraction from Liquid Foodstuff (Milk).....	825
39.3.1.2	Analyte Extraction from Semiliquid and Solid Matrices .....	827
39.3.2	Cleanup.....	833
39.3.3	Identification and Quantitation.....	835
39.3.3.1	Capillary GC with Selective Detectors.....	835
39.3.3.2	Selection of the HRGC Column.....	835
39.3.3.3	Injection Devices .....	836
39.3.4	Selective Detectors for HRGC.....	836
39.3.5	The Mass Spectrometric Detector.....	837
	References.....	838

## 39.1 Introduction

Milk may include more than the nutrients required for humans that are well studied and well documented. Less well-understood and less well-studied is the composition of milk as it reflects other ingestants of the cattle, such as environmental contaminants, that are ingested, inhaled, or absorbed through the skin or mucous membranes. This pool of substances is absorbed into the



bloodstream of lactating animals or stored in their bones or fat and reach the target organ, the breast, during active lactation.

Organic contaminants in dairy food can be divided into four categories:

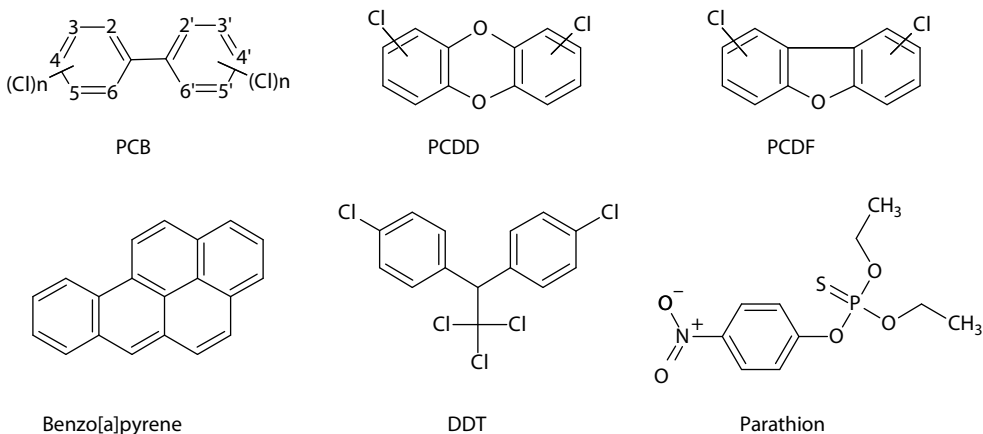
1. Veterinary drugs
2. Toxins produced by fungi and bacteria
3. Pesticides
4. Persistent organic pollutants (POPs)

In this chapter, we will illustrate analytical methodologies elaborated for detecting pesticide residues and POPs in milk and milk derivatives. Figure 39.1 shows the chemical structures of some representative environmental contaminants.

It is known that milk, like other fatty matrices, is one of the most important routes of excretion for lipophilic pesticides, i.e., organochlorine and organophosphorous insecticides, and POPs, like polychlorinated biphenyls (PCBs), polychlorinated dibenzodioxins (PCDDs), polychlorinated dibenzofurans (PCDFs), and polycyclic aromatic hydrocarbons (PAHs). In addition to the physiology of milk production, there are other factors that affect the body's burden of xenobiotics and the amount excreted in the milk; the influence of cattle residence, industrial or not industrial, and proximity to unusual exposures, spills, or accidents. When cattle live in a relatively clean environment, the diet may be the only source of contaminants.

### 39.1.1 Persistent Organic Pollutants

POPs include industrial chemicals and by-products of certain manufacturing processes and waste incineration such as PCBs, PAHs, and dioxins. The term "dioxins" is often used in a confusing way. In toxicological consideration, and also in the present chapter, the term is used to designate the PCDDs, the PCDFs, and the coplanar (dioxin-like) PCBs, since these classes of compounds show the same type of toxicity. In addition to environmental pollution, PAHs can contaminate



**Figure 39.1** General structures of PCBs, PCDDs, PCDFs, and chemical structures of some representative compounds belonging to the class of PAHs, benzo[a]pyrene, organochlorine insecticides (DDT) and organophosphate pesticides (parathion).

foods during smoking processes, and heating and drying processes that allow combustion products to come into direct contact with food.

The characteristics that make POPs chemicals unique also make them a serious global environmental pollutant because they (a) persist in the environment for decades; (b) concentrate in fatty tissues and bioaccumulate as they move up the food chain; (c) travel long distances in global area and water currents, generally moving from tropical and temperate regions to concentrate in the northern latitudes; (d) have been linked with serious health effects in humans and other living organisms, even at very low exposures.

In just a few decades, POPs have spread throughout the global environment to threaten human health and damage land and water ecosystems. All living organisms on the Earth now carry measurable levels of POPs in their tissues. POPs have been found in sea mammals at levels high enough to qualify their bodies as hazardous waste under U.S. law [1] and evidence of POPs contamination in human blood and breast milk has been documented worldwide.

Despite their hazards, these chemicals continue to be produced, used, and stored in many countries. Even where national bans or other controls exist, these restrictions are often poorly enforced, and, in any case, they cannot protect citizens from exposure to POPs who have migrated from other regions where these chemicals are still in use.

### 39.1.2 Pesticides

The term “pesticide” is used to indicate any substance, preparation, or organism used for destroying pests. This broad definition covers substances used for many purposes, including insecticides, herbicides, fungicides, nematocides, acaricides, and lumbricides. According to their chemical nature, the most important classes of pesticides are the following: organochlorines (OCs), organophosphates (OPs), carbamates, triazines, phenoxyacids, phenylureas and sulfonylureas, acetanilides, benzimidazoles, and pyrethroids.

Today, there are more than 1800 basic chemicals that are used as active ingredients of pesticides dispersed in approximately 33,600 formulations. Over the last 20 years, in the United States alone, about 15 Mton of pesticides were used for pest control. This situation has urged local governments to enact more and more restrictive regulations for banning some dangerous pesticides and lowering the maximum admissible concentrations of pesticides in drinking water and foodstuffs.

Possible sources of contamination of milk are (a) foodstuffs containing high levels of pesticide residues from postharvest treatment or contamination, for instance, by drift during commercial aerial application; (b) foodstuffs manufactured from plant material that has been treated during the growing season with insecticides; (c) use of insecticides directly on the animal against disease vectors; (d) use of insecticides in stables (treatment against flies); (e) hygienic treatments against insects in milk-processing factories.

Contamination of milk from source (a) and (b) with a pesticide depends on the stability of the compound, its mode of application, the duration of intake or exposure, and its metabolic fate in the animal. Contamination from source (c) is more important, especially in tropical countries where the use of insecticides (cattle dipping) is necessary to protect the health and productivity of animals. Spraying of stables frequently leads to contamination of the milking equipment, and treatment of factory premises against cockroaches and other insects may introduce significant quantities of pesticides into the milk products. Although ingested pesticides are not excreted as such in milk, some of the previously described routes can lead to contamination of milk and dairy

products by (bio)degradation products of pesticides. Indeed, maximum residue limits (MRLs) for transformation products of certain classes of insecticides have been set by several organizations such as FAO-Codex Alimentarius [1] and European Union (EU) [2].

Among pesticides, the class of OC insecticides, e.g., DDT, aldrin, dieldrin, toxaphene, chlordane, heptachlor, and others, has received special attention by regulatory laboratories entrusted to monitor contamination levels of dairy foods, especially milk. This is so because characteristics and fate of OCs in the environment are very similar to those of POPs.

## 39.2 Regulations

The Codex Alimentarius is the global reference point for consumers, food producers and processors, national food control agencies, and the international food trade. The Codex Alimentarius standards, guidelines, and recommendations are internationally acknowledged as the best-established measures to protect human health from risks arising from contaminants in foods. The respective committees in the Codex Alimentarius for chemical contaminants are the Codex Committee on Pesticide Residues (CCPR) and the Joint Meeting on Pesticide Residues (JMPR) for the pesticide residue monitoring, while the Codex Committee on Food Additives and Contaminants (CCFAC) and the Joint FAO/World Health Organization (WHO) Committee on Food Additives (JECFA) are charged with the management of other chemical contaminants.

To include a specific contaminant in a list of forbidden or regulated compounds in foodstuff, generally these Committees take into account the following criteria:

- The compound has been often detected in at least one commodity at a significant concentration by reliable analysis.
- The compound has proved or is suspected to be toxicologically adverse to human or animal health at the concentration observed in the foodstuff.
- The foodstuff is widespread and it shares in the total intake of the contaminant of interest.

Therefore, the proposed safety level is an arrangement among toxicological data, analytical performances, and trade demands. These threshold values in foodstuff are established by the Food and Drug Administration (FDA) in the United States and by the European Community (EC) in EU and are known as MRLs. In the case of contaminants that are considered to be genotoxic carcinogens or in cases where current exposure of the population is close to or exceeds the tolerable intakes, maximum levels should be set as the levels that are as low as reasonably achievable (ALARA).

With regard to dioxins and PCBs, in 2001 maximum levels were set on EC level only for dioxins and not for dioxin-like PCBs, given the very limited data available at that time on the prevalence of dioxin-like PCBs. Since 2001, however, more data on the presence of dioxin-like PCBs have become available; therefore, maximum levels for the sum of dioxins and dioxin-like PCBs have been set in 2006 [3], as this is the most appropriate approach from a toxicological point of view. Each congener of dioxins or dioxin-like PCBs exhibits a different level of toxicity. To enable the sum up of the toxicity of these different congeners, the concept of toxic equivalency factors has been introduced to facilitate risk assessment and regulatory control. This means that the analytical results relating to all the individual dioxin and dioxin-like PCB congeners of toxicological concern are expressed in terms of a quantifiable unit, namely the TCDD toxic equivalent (TEQ). On this basis, the Scientific Committee on Food fixed a tolerable weekly intake of 14 pg WHO-TEQ/kg bw for dioxins and dioxin-like PCBs.

Milk is the main feed for infants, a vulnerable group. As a consequence, EC has set very strict MRLs in this matrix [3,4]. No specific MRLs related to pesticide residues has been set by the FDA and the EC in dairy products, maybe because quality control tests are supposed to be carried out on raw milk. Conversely, MRLs of POPs have been set in some milk derivatives.

Some helpful databases are available on the websites of government agencies, i.e., FAO/WHO, FDA, or EC [5].

## 39.3 Analysis of Pesticides and POPs in Dairy Foods

### 39.3.1 Extraction

#### 39.3.1.1 Analyte Extraction from Liquid Foodstuff (Milk)

Methods for the extraction of toxicants in liquid foodstuffs exploit the partitioning of analytes between the aqueous phase and a water-immiscible solvent (liquid–liquid extraction [LLE]) or a sorbent material (solid-phase extraction [SPE]). Conventional LLE is still the most diffused in many laboratories. However, SPE and, to a lesser extent, solid-phase microextraction (SPME) are constantly gaining popularity in regulatory laboratories.

##### 39.3.1.1.1 Liquid–Liquid Extraction

Depending on the nature of the analytes, the methodology for their extraction from milk involves single organic solvents or mixtures of them.

After extraction and phase separation, the organic phase is often dried with  $\text{Na}_2\text{SO}_4$ . The extractant is then removed by using a rotary evaporator in a water bath. Often, solvent substitution is needed to make the final extract more compatible to gas chromatography (GC) or high-performance liquid chromatography (LC) analysis.

Table 39.1 shows some selected applications involving LLE for analyzing OCs and OPs insecticides and POPs in milk.

##### 39.3.1.1.2 Solid-Phase Extraction

The SPE technique was first introduced in the mid-1970s as an alternative to LLE. It became commercially available in 1978, and now SPE cartridges and disks are available from many suppliers. Conventional SPE is generally performed by passing liquid samples through a cartridge filled with a solid sorbent. Analytes are eluted from the cartridge with an appropriate organic solvent or mixture of solvents. Typical sorbents for SPE are silica chemically modified with a  $\text{C}_{18}$  alkyl chain, commonly referred to as C-18; highly cross-linked polystyrene-divinylbenzene copolymers (PS-DVB), commonly referred to as PRP-1, Envichrom P or Lichrolut; hydrophobic/hydrophilic copolymers, commercially referred to as Oasis; graphitized carbon blacks (GCBs), commonly referred to as Carbo-pack or Carbograph. All these materials are commercially available in medical-grade polypropylene housing and polyethylene frits. This technique is widely applied to low-viscosity liquid matrices. Depending on the type of the sorbent and the final destination of the extract, various solvents or solvent mixtures are used to re-extract pesticides from sorbent cartridges. For both C-18 and PS-DVB, methanol or acetonitrile is the eluent of choice, when analyzing using LC. With C-18 cartridges and GC instrumentation, ethyl acetate is usually preferred. With GCB cartridges, a  $\text{CH}_2\text{Cl}_2/\text{CH}_3\text{OH}$  (80:20, v/v) mixture offers quantitative desorption of base/neutral pesticides having a broad range of polarity.

**Table 39.1 Selected Applications Using LLE for the Analysis of Pesticides and POPs in Milk**

<i>Analytes</i>	<i>Solvent</i>	<i>Quantitation Technique</i>	<i>Ref.</i>
PCBs	Boiling hexane	GC-MS	[6]
PCBs	Acetone/hexane (2:1)	GC-MS	[7]
OP pesticides	ethylacetate	GC-PPD	[8]
OP pesticides	CH <sub>3</sub> CN	GC-PPD	[9]
OC pesticides	Acetone/CH <sub>3</sub> CN/hexane (2:2:15)	GC-ECD	[10]
OC pesticides	Conc H <sub>2</sub> SO <sub>4</sub> + hexane	GC-ECD	[11]
Dioxins	Methylene chloride/hexane (1:1)	GC-MS	[12]

PCBs, polychlorinated biphenyls; GC, gas chromatography; MS, mass spectrometry; OP, organophosphate; PPD, phosphorous photometric detector; OC, organochlorine; ECD, electron capture detector.

Table 39.2 lists some selected SPE-based methods for extracting pesticides and POPs from milk.

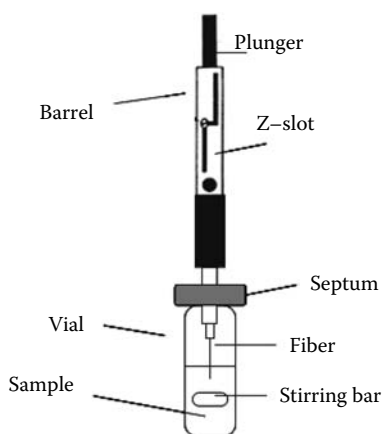
### 39.3.1.1.3 Solid-Phase Microextraction

In the early 1990s, a new technique for extracting analytes from liquid samples was introduced, the so-called SPME. Figure 39.2 shows a typical SPME device. A 0.05–1 mm i.d. uncoated fiber or coated with suitable immobilized liquid phase (in the second case, this technique should be more correctly called liquid-phase microextraction) is immersed into a continuously stirred liquid sample. After equilibrium is reached (a good exposure time takes 15–25 min), the fiber is introduced into the injection port of a gas chromatograph, where analytes are thermally desorbed and analyzed. Positive features of this technique are that the technique is rapid, very simple, and it

**Table 39.2 Selected Applications Using Solid-Phase Extraction for the Analysis of Pesticides and POPs in Milk**

<i>Analytes</i>	<i>Sorbent</i>	<i>Eluant</i>	<i>Ref.</i>
Dioxins	25 g C-18 cartridge	Hexane	[13]
OCs	0.5 g C-18 cartridge	CH <sub>3</sub> CN/light petroleum	[14]
Herbicides	0.5 g carbograph 4	CH <sub>2</sub> Cl <sub>2</sub> /MeOH (8:2)	[15]
Triazines	0.5 g carbograph 1	CH <sub>2</sub> Cl <sub>2</sub> /CH <sub>3</sub> CN (6:4)	[16]
OCs	1 g C-18	Hexane	[17]

OCs, organochlorines.



**Figure 39.2** SPME device.

does not use any solvent. In addition, this technique requires small sample volumes (2–5 mL) and all the sample extract is injected into the analytical column.

Table 39.3 lists some selected SPME-based methods for extracting pesticides and POPs from milk.

### 39.3.1.2 Analyte Extraction from Semiliquid and Solid Matrices

The extraction and recovery of trace organic material from semiliquid and solid matrices is often the slowest and the most error-prone step in an analytical method. The conventional liquid extraction techniques for solids and semisolid materials (Soxhlet) have two main disadvantages. The first, large volumes of organic solvent are required, which can lead to sample contamination and

**Table 39.3** Selected Applications of the Solid-Phase Microextraction Technique for Analyzing Pesticides and POPs in Milk

Analytes	Extractant	Method of Analysis	Ref.
Pesticides	PDMS/DVB-coated fiber	GC-ECD	[18]
PCBs	Uncoated fiber	GC-ECD	[19]
OP insecticides	Uncoated fiber	GC-NPD	[20]
Pesticides	Uncoated fiber	GC-MS/ MS	[21]
Triazine herbicides	PDMS/DVB-coated fiber	GC-MS	[22]

PDMS/DVB, polydimethylsiloxane/divinylbenzene; GC, gas chromatography; ECD, electron capture detector; PCBs, polychlorinated biphenyls; OP, organophosphate; NPD, nitrogen photometric detector; MS/MS, tandem mass spectrometer.

“losses” due to volatilization during concentration steps. The second, to achieve an exhaustive extraction may require several hours (6–14 h). With the development of sophisticated instrumentation with detection limits in the picogram and femtogram levels, pressure is finally felt within the analytical community to develop and validate sample preparation procedures that can be used to rapidly isolate trace level organics from complex matrices.

### 39.3.1.2.1 Soxhlet Extraction

In spite of being time-consuming, Soxhlet extraction still continues to be largely used, as it is included in several official methods. The most salient advantages of Soxhlet are that the sample is repeatedly brought into contact with fresh portion of the solvent, thereby aiding displacement of the distribution equilibrium, and that no filtration is needed. The drawbacks involved in the use of this traditional extraction technique are the inability to provide agitation, which would help process acceleration, and the constant heat applied to the leaching cavity. This heat is dependent on the solvent boiling point and could be insufficient to break some matrix–analyte bonds. A microwave-assisted Soxhlet extractor (Soxtec) has been proposed and commercialized without noticeable success, even though the literature quotes applications in which a saving time (1 instead of 4 h) is achieved using Soxtec instead of conventional Soxhlet.

Recently, Soxhlet extraction has also been applied to liquid dairy products (milk and yoghurt) after dispersing food sample on a suitable solid material following a procedure similar to that used with the matrix solid-phase dispersion (see later).

Table 39.4 lists some selected Soxhlet extraction-based methods for extracting pesticides and POPs from dairy products.

### 39.3.1.2.2 Liquid-Phase Extraction

Although manually shaking a finely dispersed solid sample with a suitable solvent can be effective in many cases, blending the sample in the presence of the solvent in high-speed homogenizer machines or ultrasonication baths ensures extensive sample disruption and a better analyte extraction. This technique is called liquid-phase extraction (LPE) or liquid–solid extraction (LSE). So

**Table 39.4 Selected Applications of Soxhlet Extraction for the Analysis of Pesticides and POPs in Solid Dairy Products**

<i>Analytes</i>	<i>Matrix</i>	<i>Extractant</i>	<i>Ref.</i>
Dioxins	Yoghurt, cheese, milk	Toluene, 24 h	[23]
Dioxins	Powder milk	Pentane/DCM (1:1), 12 h	[24]
OCs, PCBs	Yoghurt	Cyclohexane/acetone (1:1), 14 h	[25]
PAHs	Yoghurt, cheese, butter	Cyclohexane/DCM (1:1), 4 h	[26]
Dioxins	Powdered milk	Acetone/hexane (1:1), 16 h	[27]
PCBs, dioxins	Cheese, butter	Hexane/DCM (1:1), 16 h	[28]

DCM, methylene chloride; OCs, organochlorines; PCBs, polychlorinated biphenyls; PAHs, polycyclic aromatic hydrocarbons.

far, this technique is the most popular for extracting contaminants in foodstuffs. Water-miscible solvents, such as acetone, acetonitrile, and methanol, are now widely used as they are effective in extracting both polar and nonpolar toxicants. Ethyl acetate with added anhydrous sodium sulfate is an alternative extractant. Its use offers advantages in that no subsequent partition step is required and the extract can be used directly in gel permeation chromatographic (GPC) cleanup. Each extraction system offers distinct advantages, some of which depend on the way in which the extraction/partition steps are integrated into the cleanup/determination steps of the analytical method. Other factors that may influence the choice of one solvent over another is solvent consumption, which is related to cost, health, and disposal problems.

Table 39.5 shows selected extraction procedures for analyzing contaminants in solid foods by LPE.

### 39.3.1.2.3 Pressurized Solvent Extraction

This method, also called accelerated solvent extraction (ASE), has been used since 1995. Pressurized solvent extraction (PLE) is an extraction under elevated pressure and temperature (Figure 39.3). It represents an effective extraction technique with the advantages of shorter extraction times and lower consumption of solvents when compared with LPE and Soxhlet. It allows the universal use of solvents or solvent mixtures with different polarities and individually variable pressures of 5–200 atm to maintain the extraction solvent in a liquid state, and temperatures ranging from room temperature up to 200°C to accelerate extraction.

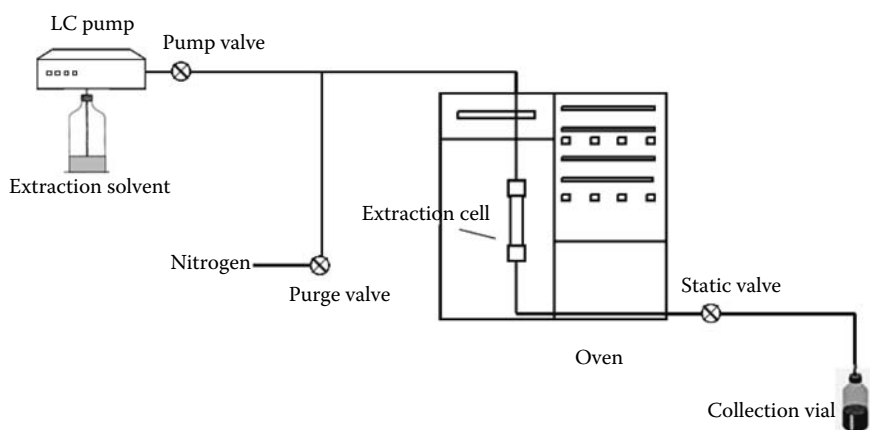
In general, the extraction efficiency of PLE is influenced by both extraction pressure and temperature, which are the operation parameters of PLE. The solvent volume can be reduced because the solubility increases with temperature. In addition, sample matrix effects also affect the extraction efficiency. Therefore, the extraction behavior of PLE is not plain and optimization of operating conditions is laborious. Another weakness of PLE is that, when using hydrophobic organic solvents, the presence of relatively high water percentages in the sample strongly decreases analyte extraction efficiency, as water hinders contact between the solvent and the analyte. When

**Table 39.5 Selected Applications of LSE for the Analysis of Pesticides and POPs in Solid Dairy Products**

<i>Analytes</i>	<i>Matrix</i>	<i>Extractant</i>	<i>Ref.</i>
PCBs, OCs	Butter	Boiling hexane	[29]
PCBs	Cheese	Petroleum ether	[30]
OCs	Cheese, butter	Chloroform	[31]
Dioxins	Cheese	Hexane/DCM	[32]
PAHs	Cheese	Cyclohexane	[33]
PAHs	Butter, cheese	Cyclohexane/DCM	[26]
PAHs	Smoked cheese	Cyclohexane	[34]

PCBs, polychlorinated biphenyls; OCs, organochlorines; DCM, methylene chloride; PAHs, polycyclic aromatic hydrocarbons.





**Figure 39.3** Schematic of a pressurized fluid extraction apparatus.

extracting analyte from food samples, a remedy adopted by many searchers is that of adding anhydrous sodium sulfate in the extraction cell or to adopt a preliminary lyophilization step.

Table 39.6 shows some PLE-based extraction procedures involved in the analysis of pesticides and POPs in milk, cheese, and butter.

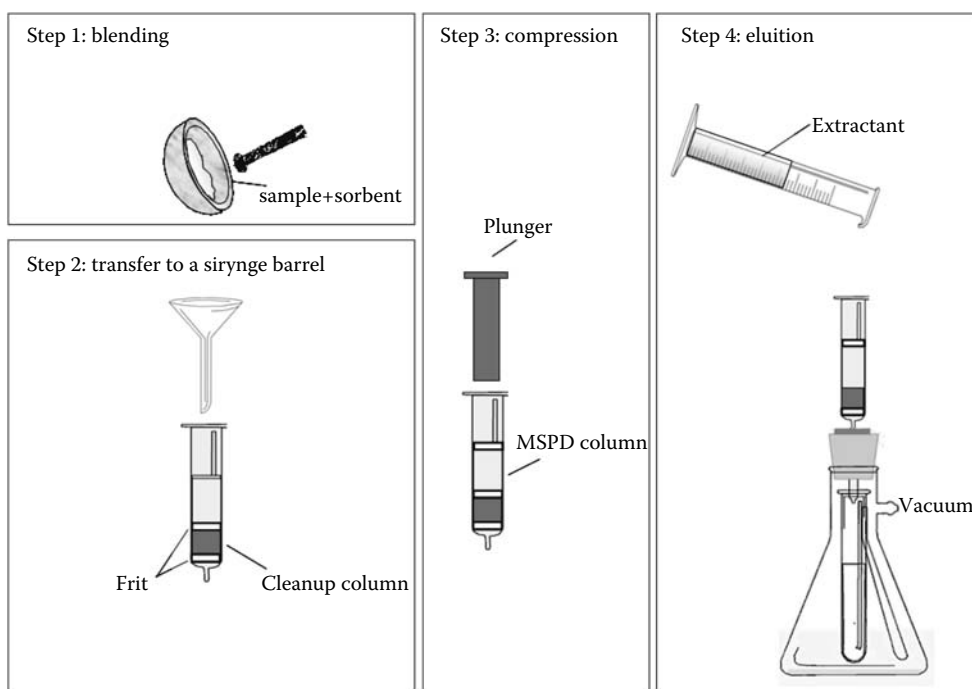
#### 39.3.1.2.4 Matrix Solid-Phase Dispersion

Matrix solid-phase dispersion (MSPD) is a process for the extraction of target compounds from solid matrices and was introduced in 1989. Later, this technique has been applied also to liquid and semisolid matrices. MSPD combines the aspects of several analytical techniques, performing sample disruption while dispersing the components of the sample on a solid support, thereby generating a chromatographic material that possesses a particular character for the extraction of compounds from the dispersed sample. The MSPD technique involves the use of abrasives blended with the sample by means of a mortar and pestle or by a related mechanical device (Figure 39.4). The shearing forces generated by the blending process disrupt the sample architecture and provide a more finely divided material for extraction. Some procedures use abrasives that also possess the properties of a drying agent, such as anhydrous  $\text{Na}_2\text{SO}_4$  or silica, producing a material that is finely divided but also quite dry for subsequent extraction as described.

**Table 39.6** Selected Applications of the Pressurized Liquid Extraction Technique to the Analysis of Pesticides and POPs in Solid Dairy Products

Analytes	Matrix	Extractant	Ref.
Dioxins	Cheese, butter	Hexane (P: 10 MPa)	[13]
Pesticides	Powdered milk	$\text{CH}_3\text{CN}$ (T: 100°C, P: 10 MPa)	[35]
PCBs	Powdered milk	Hexane (T: 100°C, P: 10 MPa)	[36]

PCBs, polychlorinated biphenyls.



**Figure 39.4** Schematic representation of a typical MSPD extraction procedure.

Once the MSPD process is complete, the material is transferred to a column generally consisting of a syringe barrel, with two frits inserted on the top and bottom of the MSPD column. The principles of performing good chromatography always apply: one should avoid channels in the column and not overcompress or compact the material. When 0.5 g of the sample is mixed with 2 g of the solid support, evidences from several studies indicate that most target analytes are eluted in the first 4 mL of extractant. Many MSPD procedures have also employed the use of co-columns to obtain further fractionation and to assist in extract cleanup. A co-column material (e.g., Florisil, silica, alumina) can be packed in the bottom of a cartridge containing usually C-18 as support material. Such columns may be literally stacked so as to collect and fractionate the sample as it elutes from the MSPD column.

Over classical sample treatment procedures, MSPD offers distinct advantages in that (a) the analytical protocol is drastically simplified and shortened; (b) the possibility of emulsion formation is eliminated; (c) last but not the least, the extraction efficiency of the analytes is enhanced as the entire sample is exposed to the extractant.

Recently, to achieve faster and more efficient extraction of target compounds from various biological matrices, MSPD with heated or pressurized extractants has been proposed by using PLE or laboratory-made instrumentations.

Recently, hot water has been successfully used for extracting target compounds from biological matrices by using an instrumentation similar to that for PLE. However, MSPD with heated water differs from PLE in that extraction can also be performed in the dynamic mode instead of only in the static one. Water is an environmentally acceptable solvent and it is cost-effective. The polarity of water decreases as the temperature is increased. This means that selective extraction of polar

and medium polar compounds can be performed by suitably adjusting the water temperature. In addition to the advantages mentioned earlier, heated water provides sufficiently clean extracts needing little manipulation (pH adjustment and filtration) before injection into a reversed-phase LC column.

Table 39.7 shows some selected applications of MSPD to the extraction of contaminants from dairy products.

### 39.3.1.2.5 Supercritical Fluid Extraction

Recently, supercritical fluid extraction (SFE) with CO<sub>2</sub> as extractant has been deployed in the analytical field for extracting a variety of pesticides from solid matrices. Over sonication, blending, and Soxhlet extraction, definite advantages of SFE are listed here:

1. A nontoxic, nonflammable, inexpensive fluid, such as CO<sub>2</sub>, is used.
2. Selective extraction can be performed by suitably modifying the density of the supercritical fluid. Increasing the density of the fluid increases the extraction yield of high-molecular weight compounds. The density of the fluid can be varied by varying its temperature and pressure.
3. Faster extraction: Extraction by SFE is a matter of minutes, instead of hours. Compared with the conventional solvents, the low viscosity of the supercritical fluid helps rapid penetration into the core of the solid matrix and extraction of analytes. In addition, the high-solute diffusivities into the supercritical fluid results in rapid removal of the analytes from the matrix by a decreased mass transfer resistance.

SFE is conceptually simple to perform. A pump is used to supply a known pressure of the supercritical fluid to an extraction vessel, which is thermostated at a temperature above the critical temperature of the supercritical fluid. During the extraction, the analytes are removed from the bulk sample matrix into the fluid and swept into a decompressing region. Here, the supercritical fluid becomes a gas and is vented, while analytes abandoning the gas are collected in a vial containing a

**Table 39.7 Selected Applications of MSPD for the Analysis of Pesticides and POPs in Liquid and Solid Dairy Products**

<i>Analytes</i>	<i>Matrix</i>	<i>Support</i>	<i>Extractant</i>	<i>Ref.</i>
OP insecticides	Milk	Hydromatrix	LP/MeCN/EtOH (100:25:5)	[37]
PCBs	Butter	Florisil	Hexane/DCM (9:1)	[38]
OP insecticides	Milk	C-18	CH <sub>3</sub> CN	[39]
Dioxins	Milk	Silica/Na <sub>2</sub> SO <sub>4</sub>	Hexane/acetone (1:1)	[26]
PCBs and PBBs	Cheese	Silica	Hexane/acetone (1:1)	[40]
PCBs	Powdered milk	Silica/Na <sub>2</sub> SO <sub>4</sub>	Hexane/acetone (1:1)	[41]
Carbamates	Milk	Crystobalite	Water heated at 90°C	[42]

OP, organophosphate; hydromatrix, diatomaceous earth. LP/MeCN/EtOH, light petroleum/CH<sub>3</sub>CN/ethanol. Florisil, magnesium silicate; DCM, methylene chloride; C-18, octadecyl-bonded silica; PCBs, polychlorinated biphenyls; PBBs, polybrominated biphenyls.

small volume of a suitable solvent. A variation of this scheme is that of substituting the collecting liquid at the outlet of the extractor with a sorbent cartridge.

The extraction of hydrophobic compounds from complex matrices containing sugar, proteins, and fat can be achieved almost quantitatively, but polar molecules give poor recovery rates. The recovery of these compounds can be improved significantly by the addition to CO<sub>2</sub> of a modifying solvent, such as methanol or acetonitrile.

In spite of its unique elevated sensitivity, the interest in SFE has substantially decreased in the last years. This is due to the high dependence of the extraction conditions on the sample, leading to fastidious optimization procedures and difficulty in using this technique routinely.

Table 39.8 shows some application of SFE to the analysis of contaminants in dairy products.

### 39.3.2 Cleanup

Once an extract has been obtained, a cleanup process for isolating the analytes from coextracted compounds is necessary prior to the final determination step. With liquid samples, simultaneous sample extraction and cleanup can be sometimes accomplished by a single SPE cartridge with a suitable washing step prior to analyte elution.

When extracting target compounds from food samples, sugars, pigments, lipids, denaturated proteins, and other naturally occurring compounds are typical interferences. These endogenous compounds are to be removed from the extracts, as they interfere with the analysis in the following ways:

1. Coextractives can produce large and tailed peaks overlapping those for the analytes.
2. Even when using specific detectors, the presence of great amounts of coextractives can saturate the detector or somehow modify the detector response.
3. With GC analysis, sugars, lipids, and proteins are thermally decomposed and the relative degradation products accumulate on the first part of the column provoking a rapid deterioration of the chromatographic performance.

These problems can be, in large part, resolved by an extract cleanup step. The techniques most frequently used are adsorption and GPC by using disposable high-efficiency cartridges filled with small particle size of the fractionating materials.

Adsorption chromatography: Adsorption chromatography on silica, alumina, Florisil (a synthetic magnesium silicate), carbon, C-18, and copolymer sorbents is widely used for cleanup of

**Table 39.8 Selected Applications of SFE for the Analysis of Pesticides and POPs in Liquid and Solid Dairy Products**

<i>Analytes</i>	<i>Matrix</i>	<i>Dispersant</i>	<i>Extractant</i>	<i>Ref.</i>
PCBs	Powdered milk	—	CO <sub>2</sub> (50°C, 13–23 MPa)	[43]
OCs and OPs	Cheese	Hydromatrix	CO <sub>2</sub> (80°C, 69 MPa)	[44]
OCs and OPs	Butter	Hydromatrix	CO <sub>2</sub> + 3% CH <sub>3</sub> CN (60°C, 28 MPa)	[45]

PCBs, polychlorinated biphenyls; OCs, organochlorines; OP, organophosphates; Hydromatrix, diatomaceous earth.

many pesticides in both official and proposed methods. The first three materials progressively retard elution according to the increasing polarity. The reverse occurs with the last three sorbents. For medium- and low-polar pesticides, Florisil and alumina have been largely used in older standard methods. However, these cleanup procedures fail to fractionate polar pesticides and pesticide metabolites from coextractives. Carbon columns are used in several European standard multiresidue methods. Carbon strongly adsorbs lipids abundantly present in dairy foods, which are low polar in nature. Thus, this sorbent is particularly well suited for the purification of medium and highly polar pesticides.

Many analytical procedures used for analyzing low-polarity target compounds, i.e., PCBs, dioxins, PAHs, and OCs, include a cleanup step using adsorption columns packed with polar sorbents, such as silica, alumina, and Florisil. These columns provide good cleanup only when they are eluted with solvent mixtures of low polarity, eluting nonpolar and low-polar analytes and leaving more polar coextractives in the column. The more the eluting solvent polarity is increased, the greater will be the portion of interfering compounds eluted and the less effective will be the cleanup.

GPC: In GPC, compounds are eluted according to their molecular sizes, the smallest ones being more retarded than the largest ones. GPC is especially used for separating pesticides and POPs from complex heavy molecules, such as lipids and proteins. The most used chromatographic material is Bio-Beads SX-3 (a styrene divinylbenzene resin). When GC analysis is the final determination step, cleanup by GPC is particularly attractive, as ethyl acetate can be used as the eluent. This solvent is well compatible with GC detectors.

Table 39.9 shows selected cleanup procedures used for analyzing contaminants in dairy foods.

**Table 39.9 Selected Cleanup Procedures Using Adsorption (AC) and GPC for the Analysis of Pesticides and POPs in Liquid and Solid Dairy Products**

<i>Analytes</i>	<i>Matrix</i>	<i>Sorbent(s)</i>	<i>Eluent</i>	<i>Ref.</i>
Dioxins	Yoghurt, cheese, milk	AC on silica and alumina columns	Hexane	[23]
Dioxins	Milk, cheese, butter	GPC on SX-3 Bio-Beads and AC on silica, alumina, and carbon columns	EtAc/cycloC <sub>6</sub> (GPC) toluene (AC)	[13]
OCs, PCBs	Yoghurt	AC on magnesium silicate	Hexane	[25]
OCs	Milk	AC on magnesium silicate	1% CH <sub>3</sub> OH in hexane	[10]
Dioxins	Cheese	AC on silica, alumina and carbon columns	Toluene	[32]
PCBs	Cheese	AC on magnesium silicate	Hexane	[30]
Dioxins	Milk	AC on carbon (Carbosphere)	EtAc/hexane (1:1)	[12]
PCBs	Dairy foods	GPC on SX-3 Bio-Beads	EtAc/CycloC <sub>6</sub> (1:1)	[46]

SX-3, polystyrene gel; EtAc/cycloC<sub>6</sub>, ethylacetate/cyclohexane; OCs, organochlorines; PCBs, polychlorinated biphenyls.

### 39.3.3 Identification and Quantitation

Once the final extract has been obtained, several chromatographic instrumentations are available for identifying and measuring analyte concentrations in the final extract:

1. GC with selective detectors
2. GC or LC coupled to mass spectrometry

GC is still the most commonly used technique for analyzing POPs and pesticides in dairy food. However, several classes of pesticides are thermally labile and thus not amenable to GC methods, unless affording not easily viable derivatization procedures. LC does not suffer from these limitations and can be used to analyze virtually any nongaseous analyte.

#### 39.3.3.1 Capillary GC with Selective Detectors

Before affording the final step of the analysis by GC instrumentation, reliable analysis can be achieved by adding an internal standard to the final extract. An internal standard is defined by U.S. Environmental Protection Agency (USEPA) as “(a) pure analyte(s) added to a solution in known amount(s) and used to measure the relative response of other method analytes that are components of the same solution. The internal standard must be an analyte that is not a sample component.” Almost all modern GC methods of analysis use internal standard calibration.

Although some methods still involves the use of packed columns, GC with capillary columns, commonly referred to as high resolution (HR) GC, with selective detectors or coupled to a specific detector, such as mass spectrometry, has become the staple for analyzing contaminants in food samples. Well-established advantages of this technique are

1. The high-resolution power of a 25 m length capillary column enables rapid screening of more than 100 analytes in less than 40 min.
2. The introduction of fused-silica capillary columns with bonded stationary phases has improved column inertness and ruggedness of HRGC.
3. Availability of cheaper, more reliable, stable highly selective detectors, such as electron capture detector (ECD), nitrogen–phosphorous thermoionic detector (NPD), and flame photometric detector (FPD).
4. The introduction of new injection devices has improved reproducibility and reliability of analyses by HRGC. Moreover, some injection systems allow introduction of large volumes of the final extract, thus improving the sensitivity of the analysis.
5. The low cost of GC instrumentation. The affordability of a benchtop HRGC/mass spectrometric (MS) equipment for unequivocal detection of target compounds has made this hyphenated technique very appealing to regulatory laboratories.

#### 39.3.3.2 Selection of the HRGC Column

Fused-silica capillary column with bonded liquid phases are by far the most preferred because of their higher inertness, stability, and flexibility. To a first view, the choice of the column appears difficult, since there are many manufacturers, each one producing many different columns differing in length, internal diameter, nature of the liquid phase, and film thickness coating the capillary wall. Indeed, only few liquid phases are of effective use for the analysis of contaminants in dairy foods. Columns coated with nonpolar liquid phases, such as 5% phenyl/95% methylsilicone

are usually the first choice. These columns offer low bleed and sufficient chemical inertness. For confirmational analysis, more polar columns (phenyl/cyanopropyl) should be used. Regarding the other parameters, a 25 m × 0.25 mm i.d. having a 0.15–0.33 μm film thickness is a good selection for screening purposes.

### 39.3.3.3 *Injection Devices*

Sample introduction in HRGC is a complex and critical process. An ideal injection device should have the following properties:

1. To focus analytes in the very first part of the column.
2. Do not discriminate compounds on the basis of their chemical and physical characteristics.
3. Do not decompose or adsorb any one of the mixture components.

Among the commercially available injection devices for introducing relatively large volumes (1–3 μL) of the final extract into a capillary column, the splitless/splitter and the programmed temperature vaporization devices [47] are the most used ones for detecting pesticides and POPs in food.

### 39.3.4 *Selective Detectors for HRGC*

Among the various commercially available selective GC detectors, the electron capture and the FPDs are largely the most used ones for detecting OC and OP insecticides, respectively, in dairy products.

*Electron capture detector.* The ECD is the oldest selective detector for GC analysis. Its fame relies on the fact that it was successfully used to demonstrate the ubiquitous distribution of chlorinated pesticides. These works had huge impact on the scientific world and on public opinion, giving rise to the great interest in the fate of the environment due to human activities. Over the past 40 years, the main modifications of the ECD have been that of (a) replacing tritium adsorbed on a palladium β-ray electron source with a <sup>63</sup>Ni source, which can be heated at elevated temperatures; (b) adopting pulsed voltage instead of constant voltage. The latter modification has greatly expanded the linear dynamic range of the detector (10<sup>4</sup> against 10<sup>2</sup>). The response mechanism and a sketch of this detector have been reported elsewhere [47].

The most positive feature of the ECD is its extreme sensitivity for compounds bearing more than one halogen atoms, such as organochlorine pesticides. For this class of pesticides, the ECD is the detector of choice. A defect of the ECD is its relatively poor selectivity. To a greater or lesser extent, the ECD responds to a wide range of compounds. Moreover, the ECD sensitivity for monohalogenated compounds is not higher than that of the popular flame ionization detector.

*Flame photometric detector.* The FPD is a selective detector for sulfur- and phosphorous-containing compounds. The response mechanism and a sketch of this detector have been reported elsewhere [47]. The FPD is a robust and reliable detector but suffers from some limitations and defects:

1. It is not very sensitive for sulfur compounds.
2. By operating the detector in the P-mode, large amounts of sulfur compounds that were coeluted can interfere with the analysis of phosphorous compounds.
3. The abundance of some coeluted or even nearby eluted coextractives able to absorb the radiations emitted by S or P can result in false-negative or, in the best case, in analyte underestimation.

While the FPD operating in the S-mode is of limited utility for pesticides, this detector is largely used for analyzing OP pesticides.

### 39.3.5 The Mass Spectrometric Detector

A serious weakness of chromatographic methods based on conventional detectors is that they lack sufficient specificity for identifying target compounds in complex biological matrices. Because of legal implications, health agencies in many countries rely on detection by MS for unambiguous confirmation of the presence of contaminants in food.

It is beyond the scope of this chapter to illustrate the principles and theory of mass spectrometry. Here, the authors will describe the information that can be obtained when using GC or LC coupled to a MS detector. Compounds eluted from the GC or LC column enter the MS ion-generating source, where molecules can be ionized by different mechanisms, according to the particular ion source adopted. Under certain conditions, a series of structure-significant fragment ions having characteristic mass-to-charge ( $m/z$ ) ratios can be formed, in addition to the “molecular ion.” By scanning the MS over a defined  $m/z$  range, these ions are recorded by a photomultiplier or an electron multiplier and a resulting mass spectrum is obtained, which displays  $m/z$  vs. relative abundance.

A GC–MS instrumentation is relatively inexpensive, as it requires only a source to ionize analytes. With LC–MS, both an interface and an ion source are needed to evaporate the liquid mobile phase and produce gas-phase ions. Although the youngest device introduced for LC–MS, the electrospray ion source (ESI) is today the only commercially available interface. Using GC as separation technique, MS acquisition data are usually obtained by electron impact (EI) ionization, a “hard” ionization technique able to produce several daughter ions, in addition to the molecular ion. With ESI, unlike EI ionization, gas-phase ions are softly generated, leading to the formation of  $[M + H]^+$  (or cationized ions, usually  $[M + Na]^+$ ) or  $[M - H]^-$ , even for the most labile and non-volatile compounds, and confirmatory daughter ions can be obtained by a subsequent collision-induced decomposition (CID) process either using a single quadrupole or a triple quadrupole.

When analyzing target compounds, MS data acquisition with a single-quadrupole mass spectrometer is usually performed in the selective ion monitoring by monitoring the molecular ion plus two characteristic fragment ions for each analyte. Under this condition, the MS instrument affords the maximum sensitivity as no detector time is wasted to collect any other ion formed.

Tandem mass spectrometry (MS/MS) is a method involving two stages of mass analysis in conjunction with a chemical reaction that causes a change in the mass of the molecular ion. This can be done by coupling two physically distinct parts of the instrument (triple quadrupole,  $Q_1q_2Q_3$ ). Briefly, the molecular ion of a given compound is selected by the first quadrupole ( $Q_1$ ), the second quadrupole ( $q_2$ ) drives the molecular ion into a cell where the collision of the molecular ion with an inert gas generates characteristic fragment ions that are monitored by the  $Q_3$ . This very selective acquisition mode is called selected reaction monitoring (SRM) and affords extremely high selectivity and sensitivity, especially when the MS/MS instrument is coupled to a fractionation device, such as a chromatographic column (LC or GC–tandem MS). The main advantage of using MS/MS in the SRM mode is the discrimination against the chemical noise, which can arise from different sources (matrix compounds, column bleed, and contamination from an ion source).

When analyzing extremely low amounts of dioxins in complex matrices, the low-resolution (unit mass) quadrupole may fail to detect one or more of the analyte ion signals if they are overlapped by those relative to abundant matrix components at concentrations several orders of magnitude higher than those of the analytes. The analysis of dioxins is further complicated by the



**Table 39.10 Selected Applications of GC and LC with Selective detectors to the Analysis of Pesticides and POPs in Dairy Products**

Analytes	Column/Stationary Phase	Detector	Ref.
Dioxins	HRGC (60 m × 0.25 mm i.d.) /DB 5	HRMS	[28]
Dioxins	HRGC (30 m × 0.25 mm i.d.)/ RTX-5SIL-MS	HRMS	[13]
OC pesticides	HRGC (30 m × 0.25 mm i.d.)/CP-Sil 5 CB	ECD	[25]
OC pesticides	PC (2 m)/1.5% OV-17 + 1.95% OV-210 on Chromosorb	ECD	[10]
PCBs, OC pesticides	HRGC (50 m × 0.25 mm i.d.)/CPSil8	MS	[29]
OP pesticides	HRGC (25 m × 0.2 mm i.d.)/HP-1	FPD	[8]
OP pesticides	HRGC (15 m × 0.53 mm i.d.)/SPB-608	FPD	[37]
Multiclass pesticides	HRGC (30 m × 0.25 mm i.d.)/HP-5MS	MS/MS	[35]
PAHs	HRGC (30 m × 0.25 mm i.d.)/HP-5MS	MS	[26]
Carbamate insecticides	LC (25 cm × 4.6 mm i.d.)/C-18	MS/MS	[42]

HRGC, gas chromatography with capillary column; DB 5, (5%-phenyl)-methylpolysiloxane; HRMS, high-resolution mass spectrometry with a magnetic sector; RTX-5-SIL-MS, 5% diphenyl 95% dimethylsiloxane; OC, organochlorine; Sil 5 CB, dimethylpolysiloxane; ECD, electron capture detector; PC, packed column; OV-17, phenyl methyl, 50% phenyl silicone; OV-210, 50% trifluoropropyl methylsilicone; PCBs, polychlorinated biphenyls; CPSil8, methylsiloxane; OP, organophosphates; HP-1, dimethylpolysiloxane; FPD, flame photometric detector; SPB-608, 65% dimethyl-35% diphenyl polysiloxane; HP-5MS, 5% diphenyl 95% dimethylsiloxane; PAHs, polycyclic aromatic hydrocarbons.

existence of many isomers (i.e., 75 PCDDs and 135 PCDFs). Since dioxins differ in toxicity by several orders of magnitude, the separation and positive identification/quantification of each dioxin in a biological matrix is a crucial task. Nevertheless, analysis of dioxin traces in biological matrices can be afforded only by coupling HRGC to a mass spectrometer equipped with a magnetic sector mass analyzer (mass resolution 10,000, HRMS). Compared with low-resolution MS (quadrupole), HRMS offers much higher selectivity and sensitivity.

Table 39.10 shows selected analytical methods based on GC or LC with selective detectors for detecting contaminants in dairy food.

## References

1. Joint FAO/WHO Food Standards Program—Codex Alimentarius Commission—Codex Alimentarius, Vol. II, Pesticide Residues in Food. Food and Agriculture Organization and World Health Organization, Rome, 1993.
2. European Union Council Directive 93/57/CEE of June 29, 1993, *Off. J. Eur. Commun.* N. L211/1 of 23/8/1993.

3. Commission Regulation (EC) No 1881/2006 of 19 December 2006 setting maximum levels for certain contaminants in foodstuffs (text with EEA relevance).
4. Commission Regulation (EC) No 178/2006 of 1 February 2006 amending Regulation (EC) No 396/2005 of the European Parliament and of the Council to establish Annex I listing the food and feed products to which maximum levels for pesticide residues apply.
5. FAO database: [http://www.codexalimentarius.net/mrls/pestdes/jsp/pest\\_q-e.jsp](http://www.codexalimentarius.net/mrls/pestdes/jsp/pest_q-e.jsp); EC portal on food-safety, [http://ec.europa.eu/food/food/chemicalsafety/contaminants/index\\_en.htm](http://ec.europa.eu/food/food/chemicalsafety/contaminants/index_en.htm)
6. Thomas, G.O. et al. Development and validation of methods for the trace determination of PCBs in biological matrices. *Chemosphere*, 36, 2447, 1998.
7. Newsome, W.H. and Davies, D. Determination of PCB metabolites in Canadian human milk. *Chemosphere*, 33, 559, 1996.
8. Salas J.H. et al. Organophosphorus pesticide residues in Mexican commercial pasteurized milk. *J. Agric. Food Chem.*, 51, 4468, 2003.
9. Fenske, R.A. et al. Assessment of organophosphorous pesticide exposures in the diets of preschool children in Washington State exposure. *J. Expo. Anal. Environ. Epidemiol.*, 12, 21, 2002.
10. John, P.J., Bakore, N., and Bhatnagar, P. Assessment of organochlorine pesticide residue levels in dairy milk and buffalo milk from Jaipur City, Rajasthan, India. *Environ. Intern.*, 26, 231, 2001.
11. Barkatina, E.N. et al. Organochlorine pesticide residues in breast milk in the Republic of Belarus. *Bull. Environ. Contam. Toxicol.*, 60, 231 1998.
12. Baars, A.J. et al. Dioxins, dioxin-like PCBs and non-dioxin-like PCBs in foodstuffs: Occurrence and dietary intake in the Netherlands. *Toxicol. Lett.*, 151, 51, 2004.
13. Focant, J.-F. et al. Levels and congener distributions of PCDDs, PCDFs and non-ortho PCBs in Belgian foodstuffs. Assessment of dietary intake. *Chemosphere*, 48, 167, 2002.
14. Di Muccio, A. et al. Selective, on-column extraction of organochlorine pesticide residues from milk. *J. Chromatogr. A*, 456, 143, 1986.
15. Bogialli, S. et al. Development of a multiresidue method for analyzing herbicide and fungicide residues in bovine milk based on solid-phase extraction and liquid chromatography–tandem mass spectrometry. *J. Chromatogr. A*, 1102, 1, 2006.
16. Laganà, A., Marino, A., and Fago, G. Evaluation of double solid-phase extraction system for determining triazine herbicides in milk. *Chromatographia*, 38, 88, 1994.
17. Pico, Y. et al. Determination of organochlorine pesticide content in human milk and infant formulas using solid phase extraction and capillary gas chromatography. *J. Agric. Food Chem.*, 43, 1610, 1995.
18. Fernandez-Alvares, M. et al. Development of a solid-phase microextraction gas chromatography with microelectron-capture detection method for a multiresidue analysis of pesticides in bovine milk. *Anal. Chim. Acta*, 617, 37, 2008.
19. Kowalski, C.H. et al. Neuro-genetic multioptimization of the determination of polychlorinated biphenyl congeners in human milk by headspace solid phase microextraction coupled to gas chromatography with electron capture detection. *Anal. Chim. Acta*, 585, 66, 2007.
20. De Lourdes Cardeal, Z. et al. Analysis of organophosphorus pesticides in whole milk by solid phase microextraction gas chromatography method. *J. Environ. Sci. Health*, 585, 66, 2006.
21. González-Rodríguez, M.J. et al., Determination of pesticides and some metabolites in different kinds of milk by solid-phase microextraction and low-pressure gas chromatography-tandem mass spectrometry. *Anal. Bioanal. Chem.*, 382, 164, 2005.
22. Basheer, C. and Lee, H.K. Hollow fiber membrane-protected solid-phase microextraction of triazine herbicides in bovine milk and sewage sludge samples. *J. Chromatogr. A*, 1047, 189, 2004, 189.
23. Bocio, A. and Domingo, J.L. Daily intake of polychlorinated dibenzo-*p*-dioxins/polychlorinated dibenzofurans (PCDD/PCDFs) in foodstuffs consumed in Tarragona, Spain: A review of recent studies (2001–2003) on human PCDD/PCDF exposure through the diet. *Environ. Res.*, 97, 1, 2005.

24. Focant, J.F. et al. Fast clean-up for polychlorinated dibenzo-*p*-dioxins, dibenzofurans and coplanar polychlorinated biphenyls analysis of high-fat-content biological samples. *J. Chromatogr.*, 925, 207, 2001.
25. Zhang, H. et al. A survey of extractable persistent organochlorine pollutants in chinese commercial yogurt. *J. Dairy Sci.*, 89, 1413, 2006.
26. Siegmund, B., Weiss, R., and Pfanhauser, W. Sensitive method for the determination of nitrated polycyclic aromatic hydrocarbons in the human diet. *Anal. Bioanal. Chem.*, 375, 175, 2003.
27. Ramos, L. et al. Comparative study of methodologies for the analysis of PCDDs and PCDFs in powdered full-fat milk. PCB, PCDD and PCDF levels in commercial samples from Spain. *Chemosphere*, 38, 2577, 1999.
28. Schecter, A. et al. Levels of dioxins, dibenzofurans, PCB and DDE congeners in pooled food samples collected in 1995 at supermarkets across the United States. *Chemosphere*, 34, 1437, 1997.
29. Kalantzi, O.J. et al. The global distribution of PCBs and organochlorine pesticides in butter. *Environ. Sci. Technol.*, 35, 1013, 2001.
30. Santos, J.S. et al. Assessment of polychlorinated biphenyls (PCBs) in cheese from Rio Grande do Sul, Brazil. *Chemosphere*, 65, 1544, 2006.
31. Barkatina, E.N. et al. Organochlorine pesticide residues in basic food products and diets in the Republic of Belarus. *Bull. Environ. Contam. Toxicol.*, 63, 235, 1999.
32. Hayward, D.G. Determination of polychlorinated dibenzo-*p*-dioxin and dibenzofuran background in milk and cheese by quadrupole ion storage collision induced dissociation MS/MS. *Chemosphere*, 34, 929, 1991.
33. Anastasio, A. et al. Levels of Benzo[*a*]pyrene (BaP) in “Mozzarella di Bufala Campana” cheese smoked according to different procedures. *J. Agric. Food Chem.*, 52, 4452, 2004.
34. Guillen, M.D. and Sopelana, P. Occurrence of polycyclic aromatic hydrocarbons in smoked cheese. *J. Dairy Sci.*, 87, 556, 2004.
35. Mezcua, M. et al. Determination of pesticides in milk-based infant formulas by pressurized liquid extraction followed by gas chromatography tandem mass spectrometry. *Anal. Bioanal. Chem.*, 389, 1833, 2007.
36. Müller, A., Björklund, E., and von Holst, C. On-line clean-up of pressurized liquid extracts for the determination of polychlorinated biphenyls in feedingstuffs and food matrices using gas chromatography–mass spectrometry. *J. Chromatogr. A*, 925, 197, 2001.
37. Di Muccio, A. et al. Selective solid-matrix dispersion extraction of organophosphate pesticide residues from milk. *J. Chromatogr. A*, 754, 497, 1996.
38. Ramil Criado, M. et al. Application of matrix solid-phase dispersion to the determination of polychlorinated biphenyls in fat by gas chromatography with electron-capture and mass spectrometric detection. *J. Chromatogr. A*, 1056, 187, 2004.
39. Schenck, F.J. and Wagner, R. Screening procedure for organochlorine and organophosphorus pesticide residues in milk using matrix solid phase dispersion (MSPD) extraction and gas chromatographic determination. *Food Addit. Contam.*, 12, 535, 1995.
40. Gómara, B. et al. Fractionation of chlorinated and brominated persistent organic pollutants in several food samples by pyrenyl-silica liquid chromatography prior to GC–MS determination. *Anal. Chim. Acta*, 565, 208, 2006.
41. Ramos, L. et al. Levels of PCDDs and PCDFs in farm cow’s milk located near potential contaminant sources in Asturias (Spain). Comparison with levels found in control, rural farms and commercial pasteurized cow’s milks. *Chemosphere*, 35, 2167, 1997.
42. Bogialli, S. et al. Simple and rapid assay for analyzing residues of carbamate insecticides in bovine milk: Hot water extraction followed by liquid chromatography–mass spectrometry. *J. Chromatogr. A*, 1054, 351, 2004.
43. Ramos, L. et al. Study of the distribution of the polychlorinated biphenyls in the milk fat globule by supercritical fluid extraction. *Chemosphere*, 41, 881, 2000.

44. Hopper, ML. Multivessel supercritical fluid extraction of food items in total diet study. *J. AOAC Int.* 78, 1072, 1995.
45. Hopper, ML. Automated one-step supercritical fluid extraction and clean-up system for the analysis of pesticide residues in fatty matrices. *J. Chromatogr. A*, 840, 93, 1999.
46. Zuccato, E. et al. Level, sources and toxicity of polychlorinated biphenyls in the Italian diet. *Chemosphere*, 38, 2753, 1999.
47. Di Corcia, A. Pesticide trace analysis, in *Encyclopedia of Environmental Analysis and Remediation*, Meyers, R.A., Ed., John Wiley & Sons, Inc., New York, 1998, pp. 3555–3598.



# Chapter 40

---

# Allergens

---

Virginie Tregoat and Arjon J. van Hengel

## CONTENTS

40.1	Introduction.....	844
40.2	Characteristics of Milk Allergy .....	844
40.3	Identification and Characterization of Milk Allergens .....	845
40.3.1	Double Blind Placebo-Controlled Food Challenge .....	845
40.3.2	Skin Prick Test, RAST/EAST Inhibition and Allergen Microarrays .....	845
40.3.3	Patch Tests .....	846
40.3.4	Allergen Recognition .....	846
40.4	Effects of Food Processing on Milk Allergenicity.....	846
40.4.1	Heat Treatment.....	847
40.4.2	Fermentation .....	848
40.4.3	Ripening.....	848
40.4.4	Enzymatic Hydrolysis .....	849
40.4.5	Homogenization .....	849
40.5	Analytical Tools for the Detection of Milk Allergens in Food Products.....	849
40.5.1	Immunodetection.....	850
40.5.1.1	Immunoprecipitation and Immunodiffusion .....	850
40.5.1.2	RAST/EAST Inhibition .....	850
40.5.1.3	Enzyme-Linked Immunosorbent Assay .....	850
40.5.1.4	Lateral-Flow Immunoassays (LFIA) or Dipsticks .....	851
40.5.1.5	Biosensor and Surface Plasmon Resonance .....	852
40.5.1.6	Western Blotting .....	852
40.5.2	Proteomic Techniques.....	853

40.6	Detection of Milk Allergens in Dairy Foods and Other Food Products: Hidden Allergens.....	853
40.7	Conclusion.....	854
	References.....	855

## 40.1 Introduction

Milk is one of the most widely consumed foods, especially during the earliest stages of our life. During later stages, both milk and milk-derived dairy products remain important for human nutrition. This nutritional value as well as the abundant functional properties (e.g., foaming, emulsifying) of milk constituents make them highly attractive ingredients for the food industry [1,2].

However, milk is also well known for being allergenic. Milk allergy affects around 2% of children and 0.1%–0.5% of the adult population [3,4]. Like the other food allergies, it can induce mild to severe reactions that can even be fatal [5]. Since no treatment exists to cure food allergy, only a strict avoidance of the offending food (in this case, milk and its derived forms) can prevent an allergic reaction from occurring [6]. This stresses the necessity for allergic individuals to be aware of the presence of allergenic ingredients in food products. Accurate labeling in combination with good manufacturing practices should help the allergic consumer to avoid unintended exposure to milk. To assist the allergic consumer, the European Commission issued directive 2007/68/EC [7], which stipulates that milk, as one of the major allergenic foods, has to be declared on the label of food products when used as an ingredient. This also holds true for milk-derived products. To support this legislation, accurate and sensitive analytical methods are required to detect milk allergens and to monitor their presence in food products even at trace levels [8].

This chapter focuses on the characteristics of milk allergy and the variety of allergens present in milk. In addition to this, the effects of food processing, as applied during the manufacture of dairy products, are discussed in relation to allergenicity and the detection of milk allergens. Finally, the techniques with which the detection of milk allergens can be achieved are described along with their application for the detection of hidden milk allergens in food products.

## 40.2 Characteristics of Milk Allergy

Milk allergy results from a hypersensitivity of the immune system to milk proteins that should normally be tolerated. This is potentially due to the immaturity of the immune system or its failure [9]. Sensitization occurs when the immune system reacts aberrantly during a primary contact with milk proteins by the production of specific antibodies (Immunoglobulin E or IgE) that bind to immune cells (mast cells, basophils). A second exposure to the allergic food results in an activation of the immune cells, which release inflammatory mediators leading to the allergic reaction. Milk allergy is characterized by two types of allergic reactions: (1) an immediate IgE-dependent reaction that occurs within minutes after contact with the allergen, and (2) a delayed reaction appearing after several hours and mainly mediated by immune cells (degranulation) [10]. Milk allergy induces a spectrum of clinical symptoms involving the skin (hives, eczema, and swelling), gastrointestinal tract (nausea, vomiting, diarrhea, and stomach cramps), respiratory tract (runny nose, nasal congestion, wheezing, and coughing), and in more severe cases, anaphylaxis [11]. Milk allergy should not be confused with milk intolerance that does not involve the immune system despite similar symptoms [12]. Milk intolerance refers mainly to lactose intolerance attributed to the lack of lactase, the enzyme needed for the digestion of the milk sugar lactose [13].

Milk allergy predominantly affects children, the majority of whom outgrow this allergy by the age of 5 years. However, around 20% of the affected children remain allergic (persistent allergic patients) and in some cases, milk allergy can develop after childhood [14]. More than 90% of children who are allergic to cow's milk also react to goat's milk and sheep's milk [15–17]. However, there are examples of isolated allergies to goat and sheep milk without cross-reaction to bovine milk [18,19] or vice versa [20].

## 40.3 Identification and Characterization of Milk Allergens

Typically, the allergenicity of milk is triggered by its proteins [21]. The identification of milk allergenic proteins is established by the determination of their reactivity toward milk allergic patients in *in vitro* as well as *in vivo* tests.

### 40.3.1 Double Blind Placebo-Controlled Food Challenge

The most reliable *in vivo* test to assess the capacity of milk proteins to trigger allergic reactions is the double blind placebo-controlled food challenge (DBPCFC) test [22]. The suspected milk allergic patients are orally challenged with milk protein extracts and the provocation symptoms emerging after the ingestion are studied under strict clinical conditions [23]. The power of this test resides in its capability to trigger allergic reactions in people; however, since this can threaten the health of the allergic individuals, it is tended to be supplanted by other tests. Defining the threshold at which milk proteins induce an allergic reaction is difficult, since this varies considerably from patient to patient and from protein to protein. For sensitive allergic individuals, tiny amounts, in the order of 5  $\mu\text{g}$  or 0.1 mL of milk, have been reported to trigger allergic reactions in DBPCFC tests [24,25]. A sorbet containing trace levels of whey proteins as low as 8.8  $\mu\text{g}/\text{mL}$  has been reported to elicit systemic reactions in a milk allergic individual after ingestion of only 120–180  $\mu\text{g}$  of the offending food [26].

### 40.3.2 Skin Prick Test, RAST/EAST Inhibition and Allergen Microarrays

Skin prick test and radio-allergosorbent/enzyme-allergosorbent (RAST/EAST) tests are among the most popular *in vivo* and *in vitro* assays for diagnosing a food allergy [27]. Those qualitative tests, which are based on the immunoreaction of food-specific IgE from the blood of allergic patients with the allergenic food, provide an identification of the allergenic compounds to which the individual reacts.

In skin prick tests, a very small amount of extracted cow's milk proteins (the allergens, e.g., caseins [CNs],  $\beta$ -lactoglobulin [ $\beta$ -LG], and  $\alpha$ -lactalbumin [ $\alpha$ -LA]) are introduced under the outer layer of the skin. The weal size of the localized reddening and swelling that develops when a milk allergic reaction occurs provides an indication of the severity of the allergic reaction [28].

RAST and EAST are *in vitro* tests that analyze the blood of individuals suspected to have a food allergy to assess the level of IgE antibodies that recognize milk proteins or their derived peptides [29]. Microarrays are emerging techniques based on the same principle as RAST, but offer the possibility to simultaneously measure the reaction of IgE antibodies from allergic patients with a battery of immobilized food allergens (proteins or derived peptides) on a chip [30]. Recently,



such a sensitive microarray assay was used to study the immune response to milk and purified milk proteins [31]. Also, a peptide microarray immunoassay has been developed for milk allergens (CNs and  $\beta$ -LG), which was used to map allergenic milk-derived peptide epitopes responsible for triggering the allergic responses [32]. This tool might be useful for developing hypoallergenic formulae, containing milk-derived ingredients devoid of epitopes that are known to trigger allergic reactions.

### 40.3.3 Patch Tests

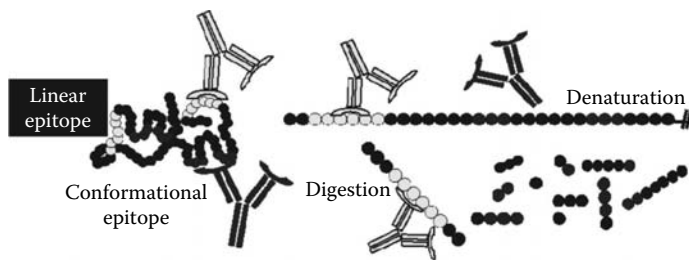
A number of infants and the majority of adults with milk allergy do not have freely circulating IgE specific to milk proteins that can be highlighted by skin prick tests and *in vitro* blood tests. Patch tests are employed in such cases, which are based on the application of a patch containing milk allergens on the skin of the patient's back [33]. Such a commercially available noninvasive epicutaneous delivery system has been designed to diagnose allergy to cow's milk protein in infants, children, or adults with delayed allergic reactions [34,35].

### 40.3.4 Allergen Recognition

Employing the *in vivo* and *in vitro* tests described earlier, it has become apparent that nearly all milk proteins (more than 30 so far, including all CNs and the whey proteins  $\beta$ -LG,  $\alpha$ -LA, bovine serum albumin [BSA], and lactoferrin [LF]) can trigger allergic responses [36]. However, the majority of allergic reactions are attributed to the most abundant milk proteins ( $\alpha$ s1-CN and  $\beta$ -LG) [37]. The allergenicity of milk proteins resides in specific amino acid sequences within the protein, called epitopes, which are recognized by IgE antibodies. Epitopes can be conformational (domains of proteins made up of nonadjacent amino acids that depend on the three-dimensional structure) or linear (continuous amino acid sequences, that only depend on the primary structure). Epitope mapping that has been performed for the main allergenic milk proteins revealed multiple allergenic epitopes within each protein as well as a high heterogeneity among allergic individuals concerning the epitopes to which they react [38–40]. While  $\beta$ -LG is likely to be the main elicitor of milk allergy (80%) in children and infants [40,41], CNs are apparently the major cause for allergic reactions in adults and persistent allergic patients [42] exposed to milk or to its derived products such as cheese [20,43]. This is potentially linked to the structural characteristics of the allergenic proteins. The poor three-dimensional structures of CNs favor the existence of linear epitopes that may participate in the persisting allergy, while whey proteins with their globular structure are characterized by conformational epitopes [43–45]. After denaturation or digestion of the protein into small fragments, the conformational epitopes can no longer bind the antibody in contrast to linear epitopes as depicted in Figure 40.1.

## 40.4 Effects of Food Processing on Milk Allergenicity

Milk is usually submitted to different technological processes to improve its safety and shelf-life before consumption. Alternatively, it is transformed into a variety of dairy products (e.g., yoghurts, cheese, ice cream, butter, and cream) [46]. Those manufacturing procedures can modify the structure of milk proteins, which might alter their immunodominant epitopes and thereby modulate allergenicity [47]. The effects are likely to be process dependent. Theoretically, allergenicity can



**Figure 40.1** Antibody detection of conformational and linear epitopes within a native, denatured, or digested allergenic protein.

decrease because of the destruction of epitopes or it can increase because of the formation of new epitopes or an improved accessibility of cryptic or hidden epitopes after allergen denaturation. From the large number of industrial processes used to manufacture dairy products or specialized foods, only few were investigated for their impact on allergenicity [9,48,49]. Heat treatment is a basic process that milk undergoes before its consumption or its transformation into derived products, while degradation of milk allergens occurs during fermentation, ripening, and enzymatic hydrolysis, which are all processes that are frequently employed by the food industry. All those processes are very likely to impact allergenicity and are discussed here.

#### 40.4.1 Heat Treatment

Thermal treatment is known to induce physicochemical changes in milk constituents [50]. The stability of milk allergenic proteins submitted to heat treatment differs according to the structure of the protein, the intensity of the thermal treatment [51], and the animal species the milk originated from. For instance, the heat stability of caprine and ovine milks is lower than that of bovine milk [52]. During heating, proteins with a globular tertiary structure (especially BSA, Ig, and  $\beta$ -LG) lose their conformational structure during unfolding. This is illustrated by the decrease in recognition by specific antibodies [53,54] or by the modification of the charge state distribution of  $\beta$ -LG as analyzed by electrospray ionization mass spectrometry (ESI-MS) [55]. Higher degrees of protonation were observed in whey protein solutions after increased heat exposure, reflecting the opening up of the molecule, but the presence of other components present in milk was shown to partly protect  $\beta$ -LG from denaturation [55]. The thermal treatment of BSA, Ig, and  $\beta$ -LG is associated with an alteration of their conformational epitopes that can no longer be recognized by IgE resulting in a reduction of allergenicity [56]. The antigenicity of milk allergens depends on the conditions of thermal treatment. Below 90°C, the allergenicity of milk proteins such as  $\beta$ -LG increases when submitted to pasteurization most likely caused by the unmasking of cryptic epitopes [57]. This is confirmed by the stronger allergic response after oral challenge (DBPCFC) of cow's milk allergic children and adults with pasteurized milks (15 s, 75°C) when compared with raw milk [58]. Inversely, heating at temperatures above 90°C drastically decreases the allergenicity of milk as shown by an impaired IgE binding [53], which is most likely to result from a combination of loss of conformational epitopes and a masking of sequential epitopes [59]. In fact, the denaturation of milk proteins that is relatively negligible with pasteurization (20% denaturation of whey proteins) is still incomplete after ultrahigh temperature (UHT) treatment (60% denaturation of whey proteins) and only boiling (100°C 10 min) represented a treatment strong enough

to annihilate prick test reactivity of BSA and  $\beta$ -LG. But, even this only partially reduces the allergenicity of  $\alpha$ -LA and CNs (50%–66% of IgE binding) [47]. The fact that CNs do not possess a highly structured configuration and that they have predominantly linear epitopes explains their thermostability and their persistence after thermal processing [60]. The maintenance of immunoreactivity of heat-treated milk can also be based on coaggregation and complexation of whey proteins with the CN micelles [61,62], or by the emergence of Maillard products (e.g., lactosylated milk proteins). Both processes might lead to the formation of neoepitopes [63,64].

#### 40.4.2 *Fermentation*

Other technological processes used in the manufacture of dairy products such as fermentation also affect the allergenicity of milk allergens [53]. Fermented milk products like yoghurt or kefir produced from cow's and ewe's milk are recognized to have beneficial effects on the immune system. Such effects are linked to the presence of viable bacteria that improve gastrointestinal immunity as well as to milk-derived bioactive peptides emerging during proteolysis [65]. Clinical reports have suggested that consumption of fermented foods, such as yoghurt, might reduce the development of allergies, possibly via a mechanism of immune regulation [66] and the presence of tolerogenic peptides emerging from the degradation of cow's milk proteins by lactic acid bacteria [67]. The changes of milk protein profiles by the action of yoghurt bacteria (*Lactobacillus delbrueckii* ssp. *bulgaricus* and *Streptococcus salivarius* ssp. *thermophilus*) were analyzed to identify the emerging peptides [68]. Proteolytic activity during fermentation in kefir manufacturing [69,70] involves the degradation of  $\beta$ -CN followed by  $\alpha$ s-CN, which is mediated by proteinases originating from lactic acid bacteria [71]. The extent of proteolysis of milk proteins varies according to the lactic acid bacteria employed for fermentation [72]. *L. delbrueckii* ssp. *bulgaricus* is able to eliminate more than 99% of the antigenicity of  $\alpha$ -LA and  $\beta$ -LG. However, despite this drastic diminution of IgE binding, the allergenicity of the product is maintained as observed by provocation tests [73]. *S. salivarius* ssp. *thermophilus* is also able to efficiently diminish the immunoreactivity of  $\alpha$ -LA (99.95%) and  $\beta$ -LG (91.26%). The same effect was observed for a whole panel of lactic acid bacteria where a remaining antigenicity of around 10% was detected [74]. Fermentation of milk from bovine species for the production of yoghurt yields a variety of peptides [75] some of which contain epitopes that are recognized by milk allergic patients [38–40]. Fermented milk products are therefore likely to remain allergenic for consumers with a milk allergy.

#### 40.4.3 *Ripening*

During cheese-making and ripening, proteolysis takes place to form free amino acids from large water-insoluble peptides, as well as medium-sized and small soluble peptides [76]. Currently, complex food matrices like cheese are subjected to proteomic analyses, which provide insight into the multitude of milk-derived proteins (e.g., CNs and whey proteins), their degradation products (peptides), and to the microbial-produced proteins (enzymes) in this type of food [77]. The proteolysis of milk proteins (mainly CNs) has also been monitored with capillary electrophoresis or HPLC techniques coupled to mass spectrometry aiming at the detection of bioactive peptides [78,79]. But, such studies do not report on the residual allergenicity of these products. Despite a continuous hydrolysis of milk proteins during cheese ripening, alteration of the allergenicity of cheese during ripening seems to be limited [80].

#### 40.4.4 Enzymatic Hydrolysis

The use of enzymatic hydrolysis of milk products is widespread within the food industry and often aims to reduce allergenicity by enzymatic degradation of milk proteins to obtain nutritional substitutes for milk allergic children [81]. In addition to this, it can be employed to generate milk protein-derived peptides with bioactive properties [82]. A variety of hydrolyzed milk formulae based on CNs or whey with different degrees of hydrolysis (partial or extensive) are commercially available. The antigenicity of those formulae is profoundly reduced [83]. But, even if the majority of the extensively hydrolyzed formulae developed for milk allergic children are well tolerated, their consumption is known to have triggered allergic reactions in several cases [84]. A study on different hypoallergenic formulae supposed to be deprived of “antigenic binding sites” has shown that  $\beta$ -LG traces could be detected in CN-based hydrolysates, indicating that during precipitation of CNs, contamination with whey proteins occur [85]. Caprine milk hydrolysates have also been developed and marketed since its proteins show a better gastrointestinal digestion than cow’s milk proteins. This faster and stronger degradation of caprine milk proteins, especially  $\beta$ -LG, is likely to be caused by differences in the tertiary structure and physicochemical properties [86,87]. New investigations to decrease the allergenicity of milk allergenic proteins have focused on enzymatic hydrolysis under high pressure, which is suggested to be more effective; but it seems that depending on the conditions, the antigenicity can be intensified [88].

#### 40.4.5 Homogenization

Homogenization is often employed for the manufacture of dairy products such as ice cream or fluid milk [89]. By destroying milk fat globules into smaller droplets under pressure, homogenization induces profound modifications in the structure of milk, which potentially affects allergenicity [90]. Homogenization of milk seems to increase its allergenicity, which is potentially due to the exposure of milk allergenic proteins at the surface of the fat globules [89].

### 40.5 Analytical Tools for the Detection of Milk Allergens in Food Products

The analytical tools that have been developed to detect milk allergens in food products either target (allergenic) proteins or DNA. DNA-based methods for the detection of milk traces in food products are hardly used, since milk contains relatively little DNA (compared with a rather high protein content) and such methods are not specific for milk, but would detect meat as well. A panel of screening methods available for the detection of milk allergen proteins in food products is based on immunoassays. Such assays usually employ animal-produced antibodies raised against the allergenic proteins [91]. Furthermore, proteomic techniques are used to confirm the presence of milk allergens in food products, and to identify milk protein/peptide sequences even after food processing [92]. Those analytical tools have been described extensively in several reviews that focus on the detection of food allergens [93,94]. The availability of methods capable of detecting milk allergen traces in food products at levels that are relevant to improve the protection of the health of allergic consumers is very important, and therefore an overview of commonly used methods is presented here.

### 40.5.1 Immunodetection

Immunochemical methods developed to detect traces of milk allergens and dairy products in food products are based on the recognition of milk allergenic proteins by specific antibodies raised against those milk proteins. Binding of allergens and antibodies leads to the formation of an allergen–antibody complex that is subsequently detected.

#### 40.5.1.1 Immunoprecipitation and Immunodiffusion

The detection and quantitation of milk allergenic proteins were initially assessed by radial immunodiffusion techniques [95]. The sensitivity of this methodology was subsequently improved and currently radial immunodiffusion kits are commercially available for the specific quantitative measurement of native  $\beta$ -LG,  $\alpha$ -LA, BSA, and LF in milk and dairy products from species like cow, goat, sheep, and camel.

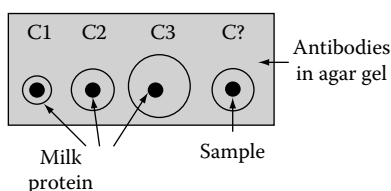
Briefly, as illustrated in Figure 40.2, fixed concentrations of anti  $\beta$ -LG,  $\alpha$ -LA, BSA, or LF antibodies are incorporated into an agar gel. Standards of diluted milk protein (C1, C2...) as well as test samples (C?) are deposited in holes in the gel and their proteins diffuse in the gel. The antibodies in the gel bind their target proteins and at the equilibrium, a precipitation ring is formed with a diameter that is proportional to the concentration of milk allergenic proteins present in the sample. Monitoring the progress of denaturation and hydrolysis of milk proteins during industrial processing (i.e., heat treatment and proteolysis) is feasible with a limit of detection (LOD) around 1  $\mu$ g/mL in a measurement range between 1.5 and 12  $\mu$ g/mL for  $\alpha$ -LA [96].

#### 40.5.1.2 RAST/EAST Inhibition

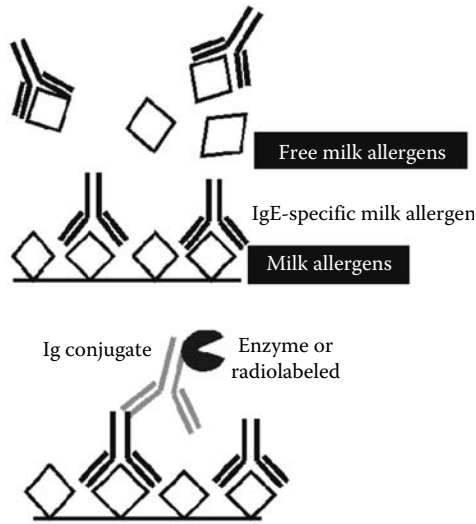
RAST and EAST have been utilized to estimate the presence and level of milk allergens in food products [18]. As illustrated in Figure 40.3, solid-phase-attached milk allergens and free milk allergens from the test sample compete for binding to human IgE. Subsequently, IgE bound to immobilized milk allergens is detected by labeled-antibodies (radiolabeled [RAST] or enzymatically labeled [EAST]). IgE binding of allergens from the test sample leads to the reduction of signal intensity, which is proportional to the level of milk allergenic protein present in the food sample. An LOD of around 1 mg/kg can be achieved with this methodology [8].

#### 40.5.1.3 Enzyme-Linked Immunosorbent Assay

Enzyme-linked immunosorbent assay (ELISA) is the type of method that is most commonly employed to detect trace amounts of food allergens in industrial food products. It is usually based



**Figure 40.2** Principle of radial immunodiffusion.

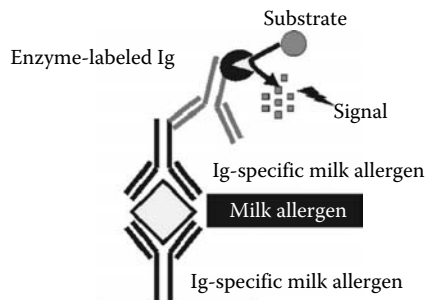


**Figure 40.3** Principle of EAST and RAST inhibition.

on immobilized antibodies of animal origin that were raised against milk proteins. The milk proteins in test samples are bound and immobilized, which allows their detection by means of a second (labeled) antibody (Figure 40.4). Several commercial kits as well as in-house developed ELISAs are available to detect and measure the amount of milk allergens present in a food matrix [97]. ELISAs for the detection of milk traces are usually directed against CNs,  $\beta$ -LG, or total milk and use either a sandwich configuration (as described earlier) or a competitive detection. LODs for such kits generally range from below 1 to 7.5 ppm [97].

#### 40.5.1.4 Lateral-Flow Immunoassays (LFIsAs) or Dipsticks

Lateral-flow immunochromatographic test systems, also called dipsticks, have been developed to provide food manufacturers with easy-to-use (on site) fast qualitative tests for the detection of milk proteins in food products. Specific antibodies (raised against milk proteins) are attached to stained



**Figure 40.4** Principle of sandwich ELISA.

latex beads and deposited at the extremity of a nitrocellulose membrane (Figure 40.5). They bind to milk proteins in a sample extract and migrate as a complex along the membrane driven by capillary forces (Figure 40.5). The complexes are captured by a secondary milk allergen-specific antibody immobilized on the test line of the membrane. This leads to the appearance of a colored line reflecting the presence of milk protein.

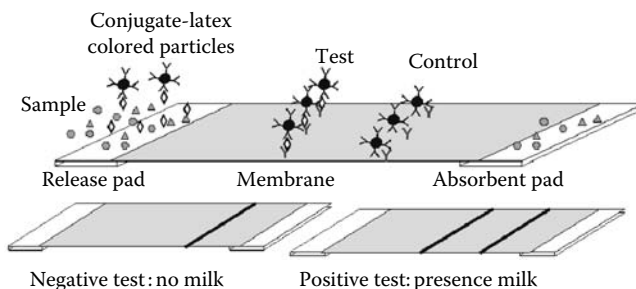
Dipsticks for the detection of milk traces are commercially available and claim to have a sensitivity of around 5 ppm.

#### 40.5.1.5 Biosensor and Surface Plasmon Resonance

Surface plasmon resonance (SPR) immunoassays represent an emerging and attractive technology for the food industry, since it monitors in real time the presence of milk allergen traces in food products. Also with this methodology, detection is based on recognition of milk proteins by antibodies. Binding of milk proteins to antibodies immobilized on a sensor chip leads to variation in the measurement of a refractive index that allows quantification of the milk content in the samples. Simultaneous quantification of CNs ( $\alpha_s$ ,  $\beta$ , and  $\kappa$ ) in dairy products [98] in their intact form can be assessed with an optical immunosensor technique in a fast and sensitive manner (LOD 0.87  $\mu\text{g}/\text{mL}$ ), and is adapted to the analysis of raw [99] and drinking milk [100]. The use of optical biosensors allows the detection of milk proteins at levels around 1–12.5 mg/kg in food samples [101]. The residual immunogenicity of food products submitted to different processes [102] such as heat treatment can be effectively estimated for the main whey proteins with LODs of 13, 27, and 20 ng/mL for  $\alpha$ -LA,  $\beta$ -LG A, and B, respectively [103]. In processed complex food matrices (baby food products like cr me dessert and fruit yoghurt),  $\beta$ -LG could be specifically and rapidly identified with a biosensor at concentrations ranging from 500  $\mu\text{g}/\text{mL}$  to 2 mg/mL, similar to the immunochemically detectable  $\beta$ -LG content of the products [104].

#### 40.5.1.6 Western Blotting

With this technique, milk allergens present in a sample are separated by gel electrophoresis in one or two dimensions and electrotransferred onto a membrane. Subsequently, specific antibodies are employed to reveal the presence of milk proteins. The antibodies employed can originate from serum of allergic patients [36], or can be raised in animals. The residual antigenicity of food and especially of hypoallergenic formulae can be assessed by this technique [105].



**Figure 40.5** Principle of dipstick device and interpretation.

### 40.5.2 Proteomic Techniques

Proteomic techniques are more and more used to detect and confirm the presence of milk allergens in food products. Indeed, this approach allows an unambiguous identification of milk proteins in food matrices, which cannot be achieved with immunological methods like ELISA owing to potential cross-reactivities of antibodies. Another advantage of proteomic techniques resides in their ability to detect potentially allergenic milk-derived peptides that emerge during food processing. Proteomic techniques are usually based on a combination of separation and identification techniques. Separation of milk protein or peptide mixtures (e.g., hypoallergenic formulae) is generally achieved either by electrophoresis or chromatography. This is then followed by their unambiguous amino acid sequence identification with mass spectrometry [106,107]. For this, the separated sample (milk proteins/peptides) entering in the mass spectrometer is ionized with matrix-assisted laser desorption/ionization (MALDI) or electrospray ionization (ESI) and the resulting ions are propelled into the mass analyzer by an electric field resolving the ions by their mass-to-charge ratio [108].

High-resolution two-dimensional gel electrophoresis (2-DE) resolves milk proteins according to their isoelectric point in a first dimension (isoelectric focusing [IEF]) and their relative molecular weight in a second dimension (SDS-PAGE) [109] before being digested *in situ* into peptides and identified by mass spectrometry [77]. This technique has been used for the detection and characterization of milk allergens in commercial milk powder [106] and for monitoring the proteolysis during cheese ripening [110,111].

Liquid separation techniques like liquid chromatography and capillary electrophoresis are applied as separation methods that offer a variety of separation principles (size exclusion, reverse phase, ion exchange, IEF, etc.). Reversed-phase chromatography constitutes the method of choice for the separation of allergens preceding mass spectrometry. Mass characterization of milk proteins and peptides and their sequence identification have been determined with LC-MS methodology, which allowed their detection in complex food matrices, after hydrolysis, fermentation [112], or during the cheese-making processes [79]. Capillary electrophoresis represents an alternative high-resolution separation technique for the analysis of milk proteins in food products and their quantification [113] and has been proven to be useful to rapidly resolve milk allergens from different matrices including milk, milk powders, hypoallergenic formulae, dairy products, and cheeses [114–118].

A limitation of proteomic techniques resides in the fact that the analysis of complex mixtures such as milk hydrolysates or cheese can be difficult to interpret without prefractionation steps. This is due to the relatively low number of allergen-derived ions compared with all detectable ions, but also to the fact that short peptides (below five amino acids) cannot be clearly attributed to their mother protein(s).

## 40.6 Detection of Milk Allergens in Dairy Foods and Other Food Products: Hidden Allergens

Milk and its derivatives (e.g., whey proteins and CNs) are more and more incorporated as ingredients into a wide range of nondairy food products because of their broad functional properties [119]. Whey proteins ( $\beta$ -LG and  $\alpha$ -LA), for instance, find their application in meat, reformed fish products as gelling additives, or can replace skim milk in ice cream, or even fat or whole egg in dairy and nondairy dessert products (e.g., meringue) owing to foaming and whipping properties

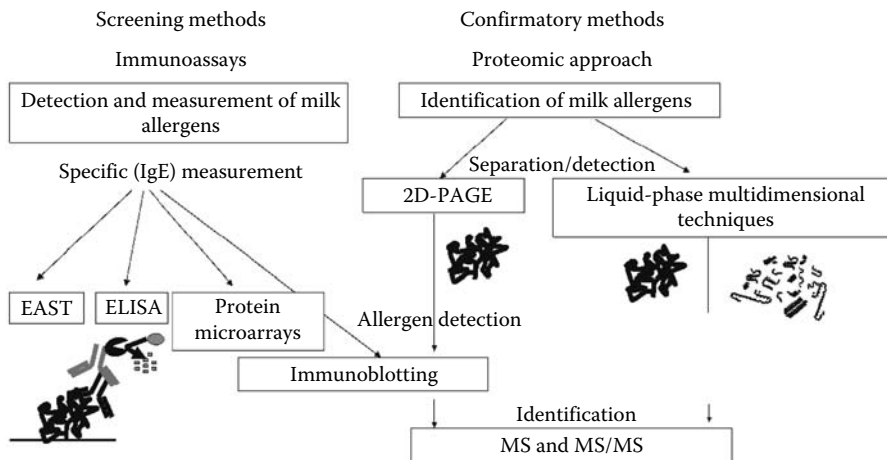


[2]. Milk powders having a high-nutritional value can supplement food, beverages, cereals, and specific nutritional products (e.g., sports drinks and infant formulae) [120,121]. A large variety of essentially nondairy products like bakery products, pastry, chocolate, sausages, hot dogs, tuna, ham, meringue, and many more products have been reported to trigger severe allergic reactions and were demonstrated to contain milk proteins by ELISA analyses [122,123]. Functional foods that are entering the market, products that contain milk protein-derived ingredients valued for their new functionalities (e.g., as biopreservative for fresh cut vegetables), or nutraceuticals could be threatening for the milk allergic population [124,125]. Probiotics that are added to food products for their potential ability to decrease allergy are also not always safe for milk allergic patients who can react to remains of the media on which the probiotics were grown (whey protein and CN) [126]. Furthermore, the ubiquity of milk proteins in food products will be reinforced by the appearance on the market of health benefit products supplemented with milk-derived peptides [127]. This strengthens the necessity to be able to detect the presence of milk proteins or milk-derived peptides in food products. Some of the methods mentioned above have been tested and optimized for this purpose. Immunological assays were applied for testing for traces of  $\beta$ -LG in infant formulae [128]. Furthermore, a series of nonmilk-containing products (fruit juices, fruit juice bars, sorbets, and dark chocolate) as well as food products that were suspected to have triggered allergic reactions were evaluated for the presence of CN employing a sandwich ELISA test, detecting CN levels that varied from 0.5 ppm (LOD) up to 40,000 ppm [129]. A competitive ELISA that is more suited to detect smaller proteolytic fragments was also successfully used to detect the presence of CN in foodstuffs (flour mix, instant potato, soup, and spice mix) with a limit of quantification (LOQ) around 1 mg/kg [130].

So far, only a single validation study of ELISA methods for the detection of milk proteins in food products has been reported. In Japan, an interlaboratory study investigating three types of ELISA kits reported the detection of milk proteins spiked into food products (sausages, sauces, cookies, and cereals) [131]. Besides immunochemical detection, proteomic techniques have been developed to assess and confirm the presence of milk allergens in food products. An LC-MS method has been set up for the detection and quantification of whey proteins ( $\beta$ -LG and  $\alpha$ -LA) in mixed fruit juices at concentrations ranging from 5 to 40  $\mu$ g/mL. This method was shown to have an LOD of 1  $\mu$ g/mL and an LOQ of 4  $\mu$ g/mL [132]. Another LC-MS method was developed to detect CNs in spiked cookies and was able to detect 1.25 ppm CN. This method is based on the detection of two peptides derived from  $\alpha$ s1-CN (FFVAPFPEVFGK; YLGYLEQLLR) that were identified as markers for the presence of milk in food matrices [133]. Techniques like capillary electrophoresis have been employed to detect whey proteins in soybean dairy-like products with an LOD of 0.6 and 1.0  $\mu$ g/g for  $\alpha$ -LA and  $\beta$ -LG, respectively [134]. The further development of methods based on capillary electrophoresis might advance the detection of milk and dairy traces in food products.

## 40.7 Conclusion

Milk proteins constitute a very rich source of nutrients with a wide variety of functional properties and are utilized to manufacture a multitude of food products. However, a proper assessment of the allergenicity and a correct declaration of milk-derived ingredients on the label of food products are of paramount importance to prevent a nightmare for milk allergic consumers [135]. The panel of technological treatments referred to in this chapter can unfortunately not guarantee the elimination of allergenic components, while contamination with milk allergens is also a cause for concern



**Figure 40.6** Analytical tools for the detection and identification of milk allergens.

[136]. It is therefore crucial that the labeling of food products is clear without ambiguity to help consumers to protect their health. To support this, a number of highly sensitive methods that are described earlier and depicted in Figure 40.6 are available to determine the presence of milk components in food matrices. The availability of such methods is crucial to detect and estimate the level of contamination of food products with allergenic ingredients, to identify mislabeling or adulteration practices, and finally to protect the allergic consumer.

## References

- Pihlanto, A. et al., Bioactive peptides and proteins, *Adv. Food Nutr. Res.*, 47, 175, 2003.
- Chatterton, D.E.W. et al., Bioactivity of [ $\beta$ ]-lactoglobulin and [ $\alpha$ ]-lactalbumin—Technological implications for processing, *Int. Dairy J.*, 16(11), 1229, 2006.
- Woods, R.K. et al., Prevalence of food allergies in young adults and their relationship to asthma, nasal allergies, and eczema, *Ann. Allergy Asthma Immunol.*, 88(2), 183, 2002.
- Pelto, L. et al., Milk hypersensitivity in young adults, *Eur. J. Clin. Nutr.*, 53, 620, 1999.
- Bock, S.A. et al., Fatalities due to anaphylactic reactions to foods, *J. Allergy Clin. Immunol.*, 107(1), 191, 2001.
- Isolauri, E., The treatment of cow's milk allergy, *Eur. J. Clin. Nutr.*, 49(Suppl. 1), 49, 1995.
- Kyprianou, M., Commission directive 2007/68/EC, *Off. J. Eur. Union*, 11, 11, 2007.
- Poms, R.E. and Anklam, E., Tracking and tracing for allergen-free food production chain, in *Allergy Matters—New Approaches to Allergy Prevention and Management*, Gilissen, L.J.W.J. et al., Eds., Wageningen UR Fontis Series. Springer, Wageningen, 2006, p. 79.
- El-Agamy, E.I., The challenge of cow milk protein allergy, *Small Ruminant Res.*, 68(1–2), 64, 2007.
- Crittenden, R.G. and Bennett, L.E., Cow's milk allergy: A complex disorder, *J. Am. Coll. Nutr.*, 24(Suppl. 6), 582, 2005.
- Sampson, H.A., Food allergy, *J. Allergy Clin. Immunol.*, 111(2, Suppl. 2), 540, 2003.
- Wilson, J., Milk intolerance: Lactose intolerance and cow's milk protein allergy, *Newborn Infant Nurs. Rev.*, 5(4), 203, 2005.
- Høst, A., Cow's milk protein allergy and intolerance in infancy. Some clinical, epidemiological and immunological aspects, *Pediatr. Allergy Immunol.*, 5(5 Suppl.), 1, 1994.

14. Olalde, S. et al., Allergy to cow's milk with onset in adult life, *Ann. Allergy.*, 62(3), 185a, 1989.
15. Spuerger, P. et al., Allergenicity of alpha-caseins from cow, sheep, and goat, *Allergy*, 52(3), 293, 1997.
16. Restani, P. et al., Cross-reactivity between milk proteins from different animal species, *Clin. Exp. Allergy.*, 29(7), 997, 1999.
17. Bellioni-Businco, B. et al., Allergenicity of goat's milk in children with cow's milk allergy, *J. Allergy Clin. Immunol.*, 103(6), 1191, 1999.
18. Lamblin, C. et al., Allergie aux laits de chevre et de brebis sans allergie associee au lait de vache, *Rev. Fr. Allergol.*, 41(2), 165, 2001.
19. Paty, E. et al., Allergie au lait de chevre et de brebis sans allergie associee au lait de vache, *Rev. Fr. Allergol.*, 43(7), 455, 2003.
20. Barnig, C. et al., Allergy to cow milk proteins without accompanying allergy to sheep milk proteins in an adult, *Rev. Fr. Allergol.*, 45(8), 608, 2005.
21. Wal, J.M., Bovine milk allergenicity, *Ann. Allergy Asthma Immunol.*, 93(Suppl. 3), 2, 2004.
22. Baehler, P. et al., Distinct patterns of cow's milk allergy in infancy defined by prolonged, two-stage double-blind, placebo-controlled food challenges, *Clin. Exp. Allergy*, 26(3), 254, 1996.
23. Ragno, V. et al., Allergenicity of milk protein hydrolysate formulae in children with cow's milk allergy, *Eur. J. Pediatr.*, 152(9), 760, 1993.
24. Bindslev-Jensen, C. et al., Can we determine a threshold level for allergenic foods by statistical analysis of published data in the literature? Hypothesis paper, *Allergy*, 57(8), 741, 2002.
25. Morisset, M. et al., Thresholds of clinical reactivity to milk, egg, peanut and sesame in immunoglobulin E-dependent allergies: Evaluation by double-blind or single-blind placebo-controlled oral challenges, *Clin. Exp. Allergy*, 33(8), 1046, 2003.
26. Laoprasert, N. et al., Anaphylaxis in a milk-allergic child following ingestion of lemon sorbet containing trace quantities of milk, *J. Food Prot.*, 61(1), 1522, 1998.
27. Majamaa, H. et al., Cow's milk allergy: Diagnostic accuracy of skin prick and patch tests and specific IgE, *Allergy*, 54(4), 346, 1999.
28. Mauro, C. et al., Correlation between skin prick test using commercial extract of cow's milk protein and fresh milk and food challenges, *Pediatr. Allergy Immunol.*, 18(7), 583, 2007.
29. Niggemann, B. et al., In vivo and in vitro studies on the residual allergenicity of partially hydrolysed infant formulae, *Acta Paediatr.*, 88(4), 394, 1999.
30. Zhu, H. and Snyder, M., Protein chip technology, *Curr. Opin. Chem. Biol.*, 7(1), 55, 2003.
31. Gaudin, J.C. et al., Assessment of the immunoglobulin E-mediated immune response to milk-specific proteins in allergic patients using microarrays, *Clin. Exp. Allergy*, 38(4), 686, 2008.
32. Wang, J. et al., Determination of epitope diversity in cow's milk hypersensitivity using microarray immunoassay, *J. Allergy Clin. Immunol.*, 117(2, Suppl. 1), S39, 2006.
33. de Boissieu, D., Comment utiliser le Diallertest(R)?, *Journal de Pediatrie et de Puericulture*, 19(4-5), 149, 2006.
34. de Boissieu, D. et al., The atopy patch tests for detection of cow's milk allergy with digestive symptoms, *J. Pediatr.*, 142(2), 203, 2003.
35. Kalach, N. et al., A pilot study of the usefulness and safety of a ready-to-use atopy patch test (Diallertest) versus a comparator (Finn Chamber) during cow's milk allergy in children, *J. Allergy Clin. Immunol.*, 116(6), 1321, 2005.
36. Natale, M. et al., Cow's milk allergens identification by two-dimensional immunoblotting and mass spectrometry, *Mol. Nutr. Food Res.*, 48(5), 363, 2004.
37. Bernard, H. et al., Specificity of the human IgE response to the different purified caseins in allergy to cow's milk proteins, *Int. Arch. Allergy Immunol.*, 115(3), 235, 1998.
38. Chatchatee, P. et al., Identification of IgE- and IgG-binding epitopes on alpha(s1)-casein: Differences in patients with persistent and transient cow's milk allergy, *J. Allergy Clin. Immunol.*, 107(2), 379, 2001.
39. Chatchatee, P. et al., Identification of IgE and IgG binding epitopes on beta- and kappa-casein in cow's milk allergic patients, *Clin. Exp. Allergy*, 31(8), 1256, 2001.

40. Jarvinen, K.M. et al., IgE and IgG binding epitopes on alpha-lactalbumin and beta-lactoglobulin in cow's milk allergy, *Int. Arch. Allergy Immunol.*, 126(2), 111, 2001.
41. Besler, M., Determination of allergens in foods, *Trends Anal. Chem.*, 20(11), 662, 2001.
42. Docena, G.H. et al., Identification of casein as the major allergenic and antigenic protein of cow's milk, *Allergy*, 51(6), 412, 1996.
43. Jarvinen, K.M. et al., B-cell epitopes as a screening instrument for persistent cow's milk allergy, *J. Allergy Clin. Immunol.*, 110(2), 293, 2002.
44. Vila, L. et al., Role of conformational and linear epitopes in the achievement of tolerance in cow's milk allergy, *Clin. Exp. Allergy*, 31(10), 1599, 2001.
45. Clement, G. et al., Epitopic characterization of native bovine  $\beta$ -lactoglobulin, *J. Immunol. Methods*, 266(1–2), 67, 2002.
46. Paschke, A. and Besler, M., Stability of bovine allergens during food processing, *Ann. Allergy Asthma Immunol.*, 89(6), 16, 2002.
47. Besler, M. et al., Stability of food allergens and allergenicity of processed foods, *J. Chromatogr. B. Biomed. Sci. Appl.*, 756(1–2), 207, 2001.
48. Sathe, S.K. et al., Effects of food processing on the stability of food allergens, *Biotechnol. Adv.*, 23, 423, 2005.
49. Heyman, M., Evaluation of the impact of food technology on the allergenicity of cow's milk proteins, *Proc. Nutr. Soc.*, 58, 587, 1999.
50. Iametti, S. et al., Modifications of high-order structures upon heating of  $\beta$ -lactoglobulin: Dependence on the protein concentration, *J. Agric. Food Chem.*, 43, 53, 1995.
51. Busti, P. et al., Thermal unfolding of bovine [beta]-lactoglobulin studied by UV spectroscopy and fluorescence quenching, *Food Res. Int.*, 38(5), 543, 2005.
52. Raynal-Ljutovac, K. et al., Heat stability and enzymatic modifications of goat and sheep milk, *Small Ruminant Res.*, 68(1–2), 207, 2007.
53. Ehn, B.M. et al., Modification of IgE binding during heat processing of the cow's milk allergen beta-lactoglobulin, *J. Agric. Food Chem.*, 52(5), 1398, 2004.
54. Chen, W.L. et al., A novel conformation-dependent monoclonal antibody specific to the native structure of {beta}-lactoglobulin and its application, *J. Dairy Sci.*, 89(3), 912, 2006.
55. Monaci, L. and van Hengel, A.J., Effect of heat treatment on the detection of intact bovine beta-lactoglobulins by LC mass spectrometry, *J. Agric. Food Chem.*, 55(8), 2985, 2007.
56. Kinsella, J. and Whitehead, D., Proteins in whey: Chemical, physical, and functional properties, *Adv. Food Nutr. Res.*, 33, 343, 1989.
57. Bleumink, E. and Young, E., Identification of the atopic allergen in cow's milk, *Int. Arch. Allergy Appl. Immunol.*, 24, 521, 1968.
58. Høst, A. and Samuelsson, E.-G., Allergic reactions to raw, pasteurized, and homogenized/pasteurized cow milk: A comparison. A double-blind placebo-controlled study in milk allergic children, *Allergy*, 43(2), 113, 1988.
59. Kleber, N. et al., The antigenic response of  $\beta$ -lactoglobulin is modulated by thermally induced aggregation, *Eur. Food Res. Technol.*, 219(2), 105, 2004.
60. Lee, Y.H. Food-processing approaches to altering allergenic potential of milk-based formula, *J. Pediatr.*, 121(5 Pt 2), 47, 1992.
61. Corredig, M. and Dalgleish, D.G., The mechanisms of the heat-induced interaction of whey proteins with casein micelles in milk, *Int. Dairy J.*, 9(3–6), 233, 1999.
62. Oldfield, D.J. et al., Effect of preheating and other process parameters on whey protein reactions during skim milk powder manufacture, *Int. Dairy J.*, 15(5), 501, 2005.
63. Bleumink, E. and Berrens, L., Synthetic approaches to the biological activity of [beta]-lactoglobulin in human allergy to cows' milk, *Nature*, 212(5061), 541, 1966.
64. Chen, W.L. et al., {beta}-Lactoglobulin is a thermal marker in processed milk as studied by electrophoresis and circular dichroic spectra, *J. Dairy Sci.*, 88(5), 1618, 2005.
65. Smacchi, E. and Gobetti, M., Bioactive peptides in dairy products: Synthesis and interaction with proteolytic enzymes, *Food Microbiol.*, 17(2), 129, 2000.

66. Cross, M.L. et al., Anti-allergy properties of fermented foods: An important immunoregulatory mechanism of lactic acid bacteria? *Int. Immunopharmacol.*, 1(5), 891, 2001.
67. Sutas, Y. et al., Suppression of lymphocyte proliferation in vitro by bovine caseins hydrolyzed with *Lactobacillus casei* GG-derived enzymes, *J. Allergy Clin. Immunol.*, 98, 216, 1996.
68. Fedele, L. et al., Matrix-assisted laser desorption/ionization mass spectrometry for monitoring bacterial protein digestion in yogurt production, *J. Mass Spectrom.*, 34, 1338, 1999.
69. Tamime, A.Y. and Deeth, H.C., Yogurt: Technology and biochemistry, *J. Food Prot.*, 43, 939, 1980.
70. Thomas, T.D. and Pritchard, G.G., Proteolytic enzymes of dairy starter cultures, *FEMS Microbiol. Lett.*, 46(3), 245, 1987.
71. Kabadjova-Hristova, P. et al., Evidence for proteolytic activity of Bacilli isolated from kefir grains, *Biotechnol. Biotechnol. Eq.*, 20(2), 89, 2006.
72. Wroblewska, B. et al., The effect of selected microorganisms on the presence of immunoreactive fractions in cow and goat milks, *Pol. J. Food Nutr. Sci.*, 4(3), 21, 1995.
73. Jedrychowski, L. and Wroblewska, B., Reduction of the antigenicity of whey proteins by lactic acid fermentation, *Food Agric. Immunol.*, 11(1), 91, 1999.
74. Kleber, N. et al., Screening for lactic acid bacteria with potential to reduce antigenic response of [beta]-lactoglobulin in bovine skim milk and sweet whey, *Innovat. Food Sci. Emerg. Tech.*, 7(3), 233, 2006.
75. Schieber, A. and Bruckner, H., Characterization of oligo- and polypeptides isolated from yoghurt, *Eur. Food Res. Technol.*, 210, 310, 2000.
76. Hau, J. and Bovetto, L., Characterisation of modified whey protein in milk ingredients by liquid chromatography coupled to electrospray ionisation mass spectrometry, *J. Chromatogr. A.*, 926(1), 105, 2001.
77. Manso, M.A. et al., Application of proteomics to the characterisation of milk and dairy products, *Int. Dairy J.*, 15(6–9), 845, 2005.
78. Alli, I. et al., Identification of peptides in cheddar cheese by electrospray ionization mass spectrometry, *Int. Dairy J.*, 8(7), 643, 1998.
79. Piraino, P. et al., Use of mass spectrometry to characterize proteolysis in cheese, *Food Chem.*, 101(3), 964, 2007.
80. Faccia, M. et al., Influence of type of milk and ripening time on proteolysis and lipolysis in a cheese made from overheated milk, *Int. J. Food Sci. Technol.*, 42(4), 427, 2007.
81. Høst, A. and Halcken, S., Hypoallergenic formulas—When, to whom and how long: After more than 15 years we know the right indication!, *Allergy*, 59(Suppl. 78), 45, 2004.
82. Korhonen, H. and Pihlanto, A., Bioactive peptides: production and functionality, *Int. Dairy J.*, 16(9), 945, 2006.
83. Chirico, G. et al., Immunogenicity and antigenicity of a partially hydrolyzed cow's milk infant formula, *Allergy*, 52(1), 82, 1997.
84. Wroblewska, B. et al., Immunoreactive properties of peptide fractions of cow whey milk proteins after enzymatic hydrolysis, *Int. J. Food Sci. Technol.*, 39(8), 839, 2004.
85. Puerta, A. et al., Immunochromatographic determination of [beta]-lactoglobulin and its antigenic peptides in hypoallergenic formulas, *Int. Dairy J.*, 16(5), 406, 2006.
86. Almaas, H. et al., In vitro digestion of bovine and caprine milk by human gastric and duodenal enzymes, *Int. Dairy J.*, 16(9), 961, 2006.
87. Park, Y.W. et al., Physico-chemical characteristics of goat and sheep milk, *Small Ruminant Res.*, 68(1–2), 88, 2007.
88. Bonomi, F. et al., Reduction of immunoreactivity of bovine beta-lactoglobulin upon combined physical and proteolytic treatment, *J. Dairy Res.*, 70(1), 51, 2003.
89. Michalski, M.-C. and Januel, C., Does homogenization affect the human health properties of cow's milk?, *Trends Food Sci. Technol.*, 17(8), 423, 2006.
90. Garcia-Risco, M.R. et al., Modifications in milk proteins induced by heat treatment and homogenization and their influence on susceptibility to proteolysis, *Int. Dairy J.*, 12(8), 679, 2002.

91. Steinhart, H. et al., Introducing allergists to food chemistry, *Allergy*, 56(Suppl. 67), 9, 2001.
92. Alomirah, H.F. et al., Applications of mass spectrometry to food proteins and peptides, *J. Chromatogr. A*, 893(1), 1, 2000.
93. Poms, R.E. et al., Methods for allergen analysis in food—a review, *Food Addit. Contam.*, 21, 1, 2004.
94. Van Hengel, A.J. et al., Analysis of food allergens and practical applications, in *Food Toxicants Analysis: Techniques, Strategies and Developments*, Pico, Y., Ed. Elsevier, Amsterdam, 2007, p. 189.
95. Guidry, A.J. and Pearson, R.E., Improved methodology for quantitative determination of serum and milk proteins by single radial immunodiffusion, *J. Dairy Sci.*, 62(8), 1252, 1979.
96. Leveux, D. et al., Caprine immunoglobulin G, beta-lactoglobulin, alpha-lactalbumin and serum albumin in colostrum and milk during the early post partum period, *J. Dairy Res.*, 69(3), 391, 2002.
97. Monaci, L. et al., Milk allergens, their characteristics and their detection in food: a review, *Eur. Food Res. Technol.*, 223(2), 149, 2006.
98. Muller-Renaud, S. et al., Quantification of beta-casein in milk and cheese using an optical immunosensor, *J. Agric. Food Chem.*, 52(4), 659, 2004.
99. Dupont, D. et al., Determination of the heat-treatment undergone by milk by following the denaturation of alpha-lactalbumin with a biosensor, *J. Agric. Food Chem.*, 52, 677, 2004.
100. Dupont, D. and Muller-Renaud, S., Quantification of proteins in dairy products using an optical biosensor detection of milk allergens-specific IgE in patient sera using biosensor techniques, *J. AOAC Int.*, 89(3), 843, 2006.
101. Malmheden Yman, I. et al., Food allergen detection with biosensor immunoassays, *J. AOAC Int.*, 89(3), 856, 2006.
102. Haasnoot, W. et al., Fast biosensor immunoassays for the detection of cows' milk in the milk of ewes and goats, *J. Dairy Res.*, 71(3), 322, 2004.
103. Karamanova, L. et al., Immunoprobes for thermally-induced alterations in whey protein structure and their applications to the analysis of thermally-treated milks, *Food Agric. Immunol.*, 15, 77, 2003.
104. Hohensinner, V. et al., A 'gold cluster-linked immunosorbent assay': Optical near-field biosensor chip for the detection of allergenic [beta]-lactoglobulin in processed milk matrices, *J. Biotechnol.*, 130(4), 385, 2007.
105. Restani, P. et al., Use of immunoblotting and monoclonal antibodies to evaluate the residual antigenic activity of milk protein hydrolysed formulae, *Clin. Exp. Allergy*, 26(10), 1182, 1996.
106. Galvani, M. et al., Two-dimensional gel electrophoresis/matrix-assisted laser desorption/ionisation mass spectrometry of a milk powder, *Rapid Commun. Mass Spec.*, 14(20), 1889, 2000.
107. O'Donnell, R. et al., Milk proteomics, *Int. Dairy J.*, 14(12), 1013, 2004.
108. Leonil, J. et al., Application of chromatography and mass spectrometry to the characterization of food proteins and derived peptides, *J. Chromatogr. A*, 881(1–2), 1, 2000.
109. Roncada, P. et al., Identification of caseins in goat milk, *Proteomics*, 2(6), 723, 2002.
110. Chin, H.W. and Rosenberg, M., Monitoring proteolysis during cheddar cheese ripening using two-dimensional gel electrophoresis, *J. Food Sci.*, 63(3), 423, 1998.
111. Molina, E. et al., Characterisation of the casein fraction of Ibérico cheese by electrophoretic techniques, *J. Sci. Food Agric.*, 82(10), 1240, 2002.
112. Hernandez-Ledesma, B. et al., Identification of bioactive peptides after digestion of human milk and infant formula with pepsin and pancreatin, *Int. Dairy J.*, 17(1), 42, 2007.
113. Veleo, M.T. et al., Development of a method for quantitative analysis of the major whey proteins by capillary electrophoresis with on-capillary derivatization and laser-induced fluorescence detection, *J. Sep. Sci.*, 28(9–10), 935, 2005.
114. Vallejo-Cordoba, B., Rapid separation and quantification of major caseins and whey proteins of bovine milk by capillary electrophoresis, *J. Capill. Electrophor.*, 4(5), 219, 1997.
115. Gutierrez, J.E. and Jakobovits, L., Capillary electrophoresis of alpha-lactalbumin in milk powders, *J. Agric. Food Chem.*, 51(11), 3280, 2003.

116. Veledo, M.T. et al., Analysis of trace amounts of bovine beta-lactoglobulin in infant formulas by capillary electrophoresis with on-capillary derivatization and laser-induced fluorescence detection, *J. Sep. Sci.*, 28(9–10), 941, 2005.
117. Miralles, B. et al., Improved method for the simultaneous determination of whey proteins, caseins and para-kappa-casein in milk and dairy products by capillary electrophoresis, *J. Chromatogr. A*, 915(1–2), 225, 2001.
118. Pappa, E.C. et al., Application of proteomic techniques to protein and peptide profiling of Teleme cheese made from different types of milk, *Int. Dairy J.*, 18(6), 605, 2008.
119. de Wit, J.N., Nutritional and functional characteristics of whey proteins in food products, *J. Dairy Sci.*, 81(3), 597, 1998.
120. Cantani, A., Hidden presence of cow's milk proteins in foods, *J. Investig. Allergol. Clin. Immunol.*, 9(3), 141, 1999.
121. Koppelman, S.J. et al., Anaphylaxis caused by the unexpected presence of casein in salmon, *Lancet*, 354(9196), 2136, 1999.
122. Gern, J.E. et al., Allergic reactions to milk-contaminated "nondairy" products, *N. Engl. J. Med.*, 324(14), 976, 1991.
123. Malmheden-Yman, I. and Eriksson, I., Analysis of food proteins for verification of contamination or mislabelling, *Food Agric. Immunol.*, 6, 167, 1994.
124. Martin-Diana, A.B. et al., Whey permeate as a bio-preservative for shelf life maintenance of fresh-cut vegetables, *Innovat. Food Sci. Emerg. Tech.*, 7(1–2), 112, 2006.
125. Semo, E. et al., Casein micelle as a natural nano-capsular vehicle for nutraceuticals, *Food Hydrocolloid.*, 21(5–6), 936, 2007.
126. Tiger Lee, T.-T. et al., Contamination of probiotic preparations with milk allergens can cause anaphylaxis in children with cow's milk allergy, *J. Allergy Clin. Immunol.*, 119(3), 746, 2007.
127. Lucas, A. et al., Probiotic cell counts and acidification in fermented milks supplemented with milk protein hydrolysates, *Int. Dairy J.*, 14(1), 47, 2004.
128. Mariager, B. et al., Bovine  $\beta$ -lactoglobulin in hypoallergenic and ordinary infant formulas measured by indirect competitive ELISA using monoclonal and polyclonal antibodies, *Food Agric. Immunol.*, 6, 73, 1994.
129. Hefle, S. and Lambrecht, D., Validated sandwich enzyme-linked immunosorbent assay for casein and its application to retail and milk-allergic complaint foods, *J. Food Prot.*, 67(9), 1933, 2004.
130. Sletten, G.B. et al., A comparison of time-resolved fluorimmunoassay and ELISA in the detection of casein in foodstuffs, *Food Agric. Immunol.*, 16(3), 235, 2005.
131. Akiyama, H. et al., Inter-laboratory evaluation studies for development of notified ELISA methods for allergenic substances (milk), *J. Food Hyg. Soc. Jpn.*, 45(3), 120, 2004.
132. Monaci, L. and van Hengel, A.J., Development of a method for the quantification of whey allergen traces in mixed-fruit juices based on liquid chromatography and mass spectrometry detection, *J. Chromatogr. A*, 1192(1), 113, 2008.
133. Weber, D. et al., Development of a liquid chromatography-tandem mass spectrometry method using capillary liquid chromatography and nanoelectrospray ionization-quadrupole time-of-flight hybrid mass spectrometer for the detection of milk allergens, *J. Agric. Food Chem.*, 54(5), 1604, 2006.
134. Garcia-Ruiz, C. et al., Analysis of bovine whey proteins in soybean dairy-like products by capillary electrophoresis, *J. Chromatogr. A*, 859(1), 77, 1999.
135. Henning, D.R. et al., Major advances in concentrated and dry milk products, cheese, and milk fat-based spreads, *J. Dairy Sci.*, 89(4), 1179, 2006.
136. Levin, M.E. et al., Anaphylaxis in a milk-allergic child after ingestion of soy formula cross-contaminated with cow's milk protein, *Pediatrics*, 116(5), 1223, 2005.

# Chapter 41

---

## Amines

---

Tomáš Komprda and Vlastimil Dohnal

### CONTENTS

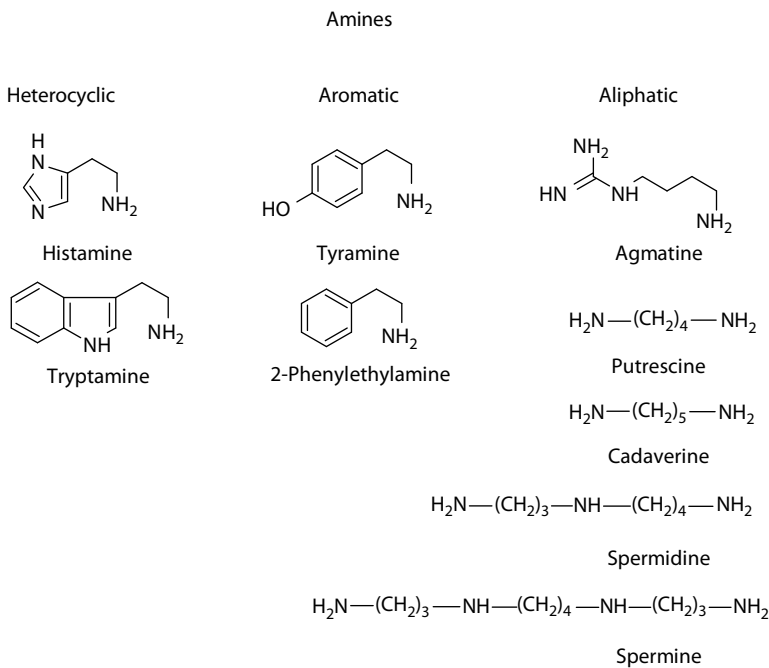
41.1	Structure .....	861
41.2	Toxicological Importance.....	862
41.3	Expected Amounts of Biogenic Amines and Polyamines in Dairy Foods.....	864
41.4	Current Analytical Methods for the Determination of Toxicologically Important Amines in Dairy Foods.....	864
41.4.1	Supplementary Analysis: Screening for Amine Producers .....	864
41.4.2	Overall Scheme of Biogenic Amines and Polyamines Analysis .....	867
41.4.3	Amines Extraction from the Matrix of Dairy Foods, Including Cleaning Procedures.....	867
41.4.4	Derivatization.....	869
41.4.5	Separation.....	870
41.4.6	Detection.....	872
41.4.7	Example of a Protocol.....	873
	References.....	875

### 41.1 Structure

Under the term “amines,” biogenic amines (BA) and polyamines (PA) will be recognized in this chapter. They are relatively simple organic nitrogenous bases, formed predominantly by the decarboxylation of their particular precursor amino acids.

Based on a purely chemical structure, three main groups of quantitatively important amines, which can occur in dairy foods, can be recognized: heterocyclic (histamine and tryptamine), aromatic (tyramine and 2-phenylethylamine), and aliphatic (agmatine, putrescine, cadaverine, spermidine, and spermine) amines (Figure 41.1).





**Figure 41.1** Chemical structure of BA and PA with likely occurrence in dairy foods.

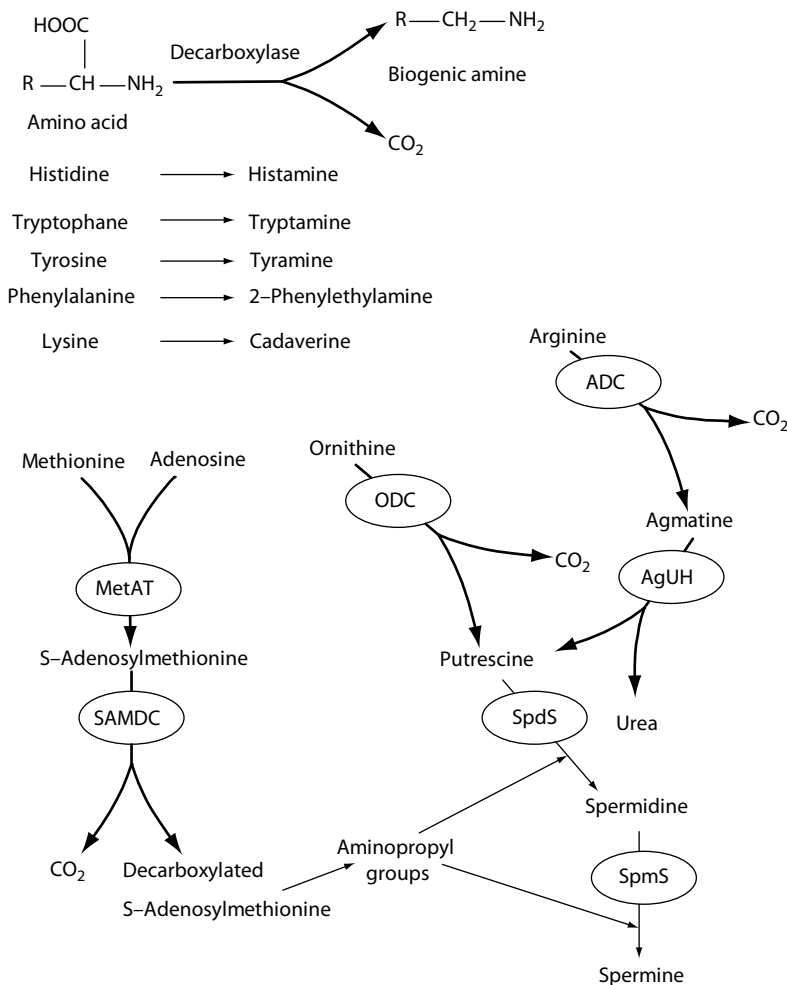
Some physiologically important bioactive substances, such as dopamine, adrenalin (epinephrine), noradrenalin (norepinephrine), and serotonin (5-hydroxytryptamine), also belong to the group of BA. However, these amines act as hormones and neurotransmitters in mammals and their presence cannot be expected at physiologically relevant levels in dairy foods, and therefore, these amines will not be taken into account from the analytical viewpoint in this chapter.

The decarboxylating enzymes are mainly of microbial origin. Therefore, BA are formed in dairy foods predominantly as a consequence of the presence of microorganisms (either starter or contaminant bacteria). However, PA (putrescine, spermidine, and spermine) have recently been recognized as a distinct group owing to the biochemical (they are also formed by an alternative metabolic pathway both in bacterial and mammalian cell) and toxicological (see Section 41.2) reasons [1]. The general scheme of BA formation and two alternative PA biosynthesis pathways are shown in Figure 41.2.

## 41.2 Toxicological Importance

Tyramine is not only quantitatively (see Section 41.3) but also toxicologically (together with histamine) the most important BA in dairy foods. Toxicological importance of tyramine is based on its effect similar to that of the indirect sympathomimetic drugs: vasoconstriction with a possible consequence of hypertension, migraine, brain hemorrhage, and heart failure in more sensitive individuals [2].

Histamine, an endogenous BA, can be released from the stores mainly by a reaction of IgE antibody with an antigen. In sensitive individuals, exogenous histamine in higher concentration



**Figure 41.2** General scheme of BA formation and alternative PA (putrescine, spermidine, spermine) biosynthesis pathways; ODC, ornithine decarboxylase; ADC, arginine decarboxylase; AgUH, agmatine ureohydrolase; SpdS, spermidine synthase; SpmS, spermine synthase; MetAT, methionine adenosyltransferase; SAMDC, S-adenosylmethionine decarboxylase. (Adapted from Wolter, F. et al., *J. Nutr.*, 134, 3219, 2004; Komprda, T. et al., *Eur. Food Res. Technol.*, 227, 29, 2008.)

(e.g., from dairy foods) can cause the same clinical symptoms as an early allergic reaction of endogenous histamine: asthma bronchiale, rhinitis, conjunctivitis, urticaria, edema, hypotension, headache, flushing, and abdominal cramps.

Toxicological importance of other BA present in dairy foods is based on their potentiation of the action of tyramine and/or histamine (via monoamine oxidase [MAO] saturation) rather than on their own adverse health effects.

PA that are physiologically required for the cell growth and proliferation are selectively taken up by the tumor cells and can consequently facilitate the growth of a tumor. Moreover,

putrescine stimulates tyrosine kinases and the expression of particular nuclear protooncogenes, and thus, is also involved in cancer pathogenesis [3]. PA are also able to form stable carcinogenic *N*-nitroso compounds and enhance the growth of chemically induced aberrant crypt foci in the intestine [4].

Amines are broken down in a mammal by the oxidative deamination catalyzed by MAO, diamine oxidase, or PA oxidase, resulting in the formation of aldehyde, ammonia, and hydrogen peroxide. However, human detoxification mechanisms are insufficient in the case of very high amine intake in the diet or in more sensitive consumers, such as allergic individuals and patients consuming drugs with an action of the MAO inhibitors (some antiparkinsonian drugs and some antidepressants).

Toxicological limits for tyramine or histamine are difficult to establish owing to the great differences between people regarding robustness of the detoxification system and the presence of various amounts of other amines in the food matrix. Nevertheless, the value above 100 mg tyramine and histamine, respectively, per one kg of food are supposed to be deleterious [5].

Concentrations of PA in dairy foods, especially ripening cheeses (see Section 41.3), cannot be properly assessed from the toxicological viewpoint, before further research elucidates both the recommended dietary intake (e.g., wound healing) and the limit which when exceeded would have deleterious effects in cancer patients.

### **41.3 Expected Amounts of Biogenic Amines and Polyamines in Dairy Foods**

Before beginning the analysis, it is useful to have some idea about the possible BA and PA content in dairy foods to be analyzed. According to the literature data, both BA and PA content in milk, curd, whey, yogurt, and unripened cheese is usually lower than 1 mg kg<sup>-1</sup> [6,7]. Therefore, the only dairy food important from the viewpoint of toxicologically relevant BA and PA content is ripening cheese. The recently published data regarding BA and PA content in various types of cheeses are presented in Tables 41.1 and 41.2, respectively.

### **41.4 Current Analytical Methods for the Determination of Toxicologically Important Amines in Dairy Foods**

#### **41.4.1 Supplementary Analysis: Screening for Amine Producers**

When analyzing BA and PA, it should be taken into account that these substances are formed in the dairy foods mainly by the following groups of bacteria possessing genes for particular decarboxylating enzymes: nonstarter lactic acid bacteria, other adventitious bacteria, and even starter bacteria [8,9]. Therefore, an integral part of BA/PA determination is often a microbiological analysis also [7,10,11].

A possible protocol for determining the amine-producing bacterial strains is as follows (the ability to decarboxylate amino acids is not genus- or species-specific, but it is a property of only a small number of strains within a given species [9,12]): cultivate the bacterial groups or genera with a presumed potential to decarboxylate amino acids in dairy foods (*Enterobacteriaceae*, lactic acid bacteria, genus *Enterococcus*); screen an aliquot of colonies in an appropriate decarboxylating medium (e.g., according to [13]); in the positive samples (change of color based on transition from

Table 41.1 Content of Quantitatively Important Biogenic Amines in Different Types of Cheeses

Cheese (Time of Ripening; Weeks)	Biogenic Amine (mg kg <sup>-1</sup> )					Reference
	Histamine	Tryptamine	Tyramine	Phenylethyl-amine	Cadaverine	
Swiss-type (24)	750–1290	—	64–910	—	—	[17]
Processed	n.d.	n.d.	4–160	8–400	12–120	[50]
Processed	1	1	1–29	1–2	1	[51]
Spanish retail cheeses (unripened)	n.d.	n.d.	<1	n.d.	<1	[19]
Spanish retail cheeses (ripened)	2–164	n.d.–45	n.d.–242	n.d.–29	4–215	[19]
Goat cheese (13)	10	22	68	37	4	[7]
Raw-milk goat cheese (13)	43–83	12	325–428	27–92	196–314	[52]
Semisoft cheese; pasteurized milk (20)	n.d.–124	—	39–770	5–179	6–109	[11]
Semisoft cheese; raw milk (20)	226–573	—	400–1478	29–223	280–2369	[11]
Semihard Italian; unpasteurized milk (21)	117–378	2–5	128–394	8–20	5–30	[53]
Greek ovine/goat brined Feta cheese; thermized milk (17)	85	6	246	5	83	[54]
Portuguese Azeitao cheese; raw ovine milk	644–682	—	358–445	—	161–231	[25]
Gouda (12)	178–418	—	337–776	—	—	[27]
Spanish traditional cheeses	n.d.–928	—	10–1807	—	—	[8]
Portuguese traditional; raw ovine milk (9)	16	56	176	9	207	[55]
Dutch-type hard; pasteurized milk (22)	2–17	1–2	3–310	1–54	1–2	[18]
Blue-vein; pasteurized milk (7)	n.d.–90	n.d.–6	10–185	n.d.	3–491	[56]

n.d., not detected.

**Table 41.2** Content of Polyamines in Different Types of Cheeses

Cheese (Time of Ripening; Weeks)	Polyamine (mg kg <sup>-1</sup> )			Reference
	Putrescine	Spermidine	Spermine	
Swiss-type (24)	17–360	—	—	[17]
Processed	4–60	8–100	n.d.	[50]
Processed	1–2	1	<1	[51]
Cheddar (young)	10–20	77–104	23–37	[1]
Cheddar (ripened)	650	190	22–38	[1]
Spanish retail cheeses (unripened)	n.d.–1	<1	<1	[19]
Spanish retail cheeses (ripened)	n.d.–612	n.d.–43	n.d.–19	[19]
Goat cheese (13)	34	1	5	[7]
Raw-milk goat cheese (13)	86–175	—	—	[52]
Semisoft cheese; pasteurized milk (20)	1–13	—	—	[11]
Semisoft cheese; raw milk (20)	76–308	—	—	[11]
Semihard Italian cheese; (unpasteurized milk) (21)	129–1105	—	—	[53]
Greek ovine/goat brined cheese; thermized milk (17)	193	—	—	[54]
Portuguese Azeitao cheese; raw ovine milk	110–137	—	17–49	[25]
Gouda (12)	4–42	—	—	[27]
Portuguese traditional; raw ovine milk (9)	218	—	—	[55]
Dutch-type hard; pasteurized milk (22)	6–61	<1	<1	[18]
Dutch-type semihard; pasteurized milk (25)	1–132	n.d.–4	2–9	[57]
Blue-vein; pasteurized milk (7)	n.d.–117	n.d.–29	n.d.–12	[56]

n.d., not detected.

an acidic [amino acid] to a basic [amine] form), confirm the presence of BA/PA in a medium by a chemical analysis (see Section 41.4.2); isolate the bacterial DNA from the positive colonies (procedure see [14]); and multiply a putative gene sequence for a given amino acid decarboxylase using PCR and a pair of corresponding primers [15].

### 41.4.2 Overall Scheme of Biogenic Amines and Polyamines Analysis

First, when analyzing the amines content in dairy foods, it is necessary to consider the number of samples for a proper statistical evaluation. It should be taken into account that in dairy food technology, the batch, e.g., the cheese vat, and not each single block of cheese obtained from it, is usually considered as the experimental unit [16].

It should also be noted that BA and PA can be distributed unevenly in dairy foods. This is evident especially in ripening cheeses, where conspicuous differences in amines concentration are observed between the core and the edge part [6,17,18]. When the goal is to determine the average amines content, the aliquot parts from several layers of the cheese should be taken and properly homogenized; on the other hand, sometimes, the outer and inner part of the cheese are analyzed separately.

BA/PA determination is analytically demanding owing to the high requirements for sensitivity and precision. In addition, the effect of the matrix is also very important. Dairy foods, especially cheeses, have a complex matrix because of their high proportion of fat and protein, which hinders the extraction of amines [19]. Therefore, the choice of an appropriate analytical method should consider precision and recovery data. The data for evaluation of precision (analytical repeatability) are obtained by measuring the BA/PA content in the same sample by a given method several times; precision is usually expressed as a relative standard deviation (RSD, in %), which numerically corresponds to the coefficient of variation. Recovery data are obtained by spiking the dairy food sample with mixed BA/PA standard at one or two concentration levels. The comparison of precision and recovery values of various analytical protocols differing in the method of extraction, derivatization, and separation of amines in different types of cheeses is presented in Table 41.3.

The general scheme of BA and PA determination is as follows: amines extraction ( $\text{CCl}_3\text{COOH}$ ;  $\text{HClO}_4$ ;  $\text{HCl}$ )  $\rightarrow$  derivatization (dansyl chloride; *o*-phthaldialdehyde)  $\rightarrow$  separation (chromatographic; electrophoretic)  $\rightarrow$  detection (UV; MS).

The consecutive steps of amine analysis are described in more detail in the following text.

### 41.4.3 Amines Extraction from the Matrix of Dairy Foods, Including Cleaning Procedures

Prior to the extraction, the exact amount of internal standard (1,7-diaminoheptane) is added to the sample to improve the reproducibility of amines determination. During the extraction, the samples are disintegrated and the amines are dissolved in the extraction solvent. Ultra-Turrax homogenizers are typically used for sample disintegration.

Apart from amines, the dairy food matrix includes other molecules containing amino groups, such as free amino acids or proteins (including enzymes) that can react with a derivatization agent with a consequence of nonquantitative derivatization of amines (derivatization see Section 41.4). Therefore, one of the main concerns of the cleaning procedure is the removal of amino acids to assure excess of derivatization agent (most of which reacts with the amino acids) to reach the quantitative derivatization of BA and PA. Amino acids can be removed prior or after the derivatization step. A frequently used method is the extraction of amine derivatives into diethylether [20].

Moreover, high content of free amino acids (especially in ripening cheeses) can cause problems in chromatographic determination owing to the elution of these amino acids in the first minutes of analysis, which can interfere with early eluted BA.

**Table 41.3 Precision and Recoveries of Various Methods Used for the Determination of Biogenic Amines/Polyamines in Cheeses**

Amine	Precision (Analytical Repeatability; RSD, %) <sup>a</sup> [Reference]						Recovery (%) [Reference]				
	[28] <sup>b</sup>	[29] <sup>c</sup>	[19] <sup>d</sup>	[18] <sup>e</sup>	[44] <sup>f</sup>	[20] <sup>g</sup>	[28] <sup>b,h</sup>	[29] <sup>c</sup>	[19] <sup>d</sup>	[18] <sup>e,i</sup>	[20] <sup>g,j</sup>
Histamine	1.3	6.1	1.1	5.8	9.4	2.7	100	67	97	94	78
Tryptamine	13.9	—	2.0	1.2	5.5	5.5	64	62	92	95	72
Tyramine	2.3	3.4	1.8	5.0	4.5	3.3	72	59	93	60	84
Phenylethylamine	2.2	—	1.0	6.8	—	4.5	72	79	91	90	58
Agmatine	12.1	—	1.2	—	4.7	—	57	—	96	—	—
Putrescine	1.6	6.1	1.3	3.0	6.6	2.0	70	2	97	65	98
Cadaverine	1.5	4.8	1.0	2.9	2.1	4.3	54	61	98	75	95
Spermidine	1.9	7.8	2.1	1.8	3.4	2.4	84	49	97	63	79
Spermine	2.4	12.5	1.6	5.4	9.0	21.0	63	44	97	67	62

<sup>a</sup> Relative standard deviation (numerically corresponds to the coefficient of variation).

<sup>b</sup> Parmesan cheese; HPLC determination after HCl extraction; based on three determinations of the same sample.

<sup>c</sup> Grana cheese; HPLC determination after HCl extraction; based on three determinations of the same sample.

<sup>d</sup> Unripened cheese, retail sample; extraction by perchloric acid, determination by ion-pair HPLC; based on eight determinations of the same sample.

<sup>e</sup> Dutch-type hard cheese; five HCl extracts of the cheese sample with low amines content, HPLC determination.

<sup>f</sup> Dessert Romadour-type cheese; trichloroacetic acid extraction followed by ion-exchange chromatography determination; based on five determinations of the same sample.

<sup>g</sup> Parmigiano Reggiano cheese; 0.1 M HCl extraction, HPLC determination; six repetitions.

<sup>h</sup> Parmesan cheese spiked with 10 mg of amines per 100 g of sample during extraction and purification.

<sup>i</sup> Dutch-type cheese spiked at the concentration level of 2 mg kg<sup>-1</sup>; measured five times.

<sup>j</sup> Parmigiano Reggiano cheese samples spiked with 1 mL of a standard amines solution (concentration of each amine, 1 mg mL<sup>-1</sup>); derivatization procedure with 20 mg mL<sup>-1</sup> of DCl.

On the other hand, when the content of free amino acids in the extract is low, it is possible to use the derivatized extract directly for the analytical determination of amines, without any other cleaning procedure, thus, avoiding the losses of amines in additional cleaning steps.

Another quantitatively important part of the dairy food matrix, which can interfere with the amines determination in dairy foods, is fat. The lipid fractions are removed from the extracts using low temperature in freezer or in a cooled (usually at 4°C) centrifuge [21–23].

The procedures for amines extraction and extract deproteinization prior to derivatization mainly use acids or organic solvents. Hydrochloric acid (0.1 M) or perchloric acid (0.2 and 0.6 M, respectively) is used most often for amines extraction from dairy products.

Typically, 25 or 50 mL of 0.1 M hydrochloric acid per 5.0–10.0 g of the sample is used for the extraction of amines from dairy foods. Extraction is commonly performed in a homogenizer, with an option of 1–2 repetitions [18], or using an ultrasonic bath [24].

Alternatively, the solution of 0.2 M perchloric acid can be used for amines extraction from dairy foods [25]. Lanciotti et al. [26] extracted amines from ovine and bovine Italian cheeses using 15 mL of 0.2 M HClO<sub>4</sub>/4 g of cheese. The extraction was performed in an Ultra-Turrax macerator at medium speed. The homogenate was then centrifuged at 10 000 rpm for 10 min at 4°C, the supernatant was removed, and the extraction of the solid part was repeated. The combined extracts were adjusted to 50 mL with 0.2 M perchloric acid. Leuschner et al. [27] used 0.6 M perchloric acid for amines extraction from cheeses in a ratio of 40 mL/10 g of cheese.

*Liquid–liquid extraction (LLE).* For LLE, the raw extract should be alkalized to transform BA/PA into neutral form in which they are extractable to nonpolar organic phase, such as butanol, butanol/chloroform mixture, or diethylether [28]. Despite the different dissociation constants of particular amines and therefore the different optimum pH for extraction of each of them, it is necessary to maintain and strictly control one fixed pH value during extraction to reach reproducible recovery for all amines [29].

*Solid-phase extraction (SPE).* Typically, the C18 sorbents are used for the extract purification [21,22]. It is necessary to adjust the pH of a solution to alkaline range (e.g., to 11.0 with NH<sub>4</sub>OH) to reach the neutral form of amines and to improve the amine retention. Subsequently, the acidified solution (e.g., pH 3.0 using formic acid) is applied for ionization of amines and their quantitative elution from the SPE column.

Calbiani et al. [30] introduced the method of matrix solid-phase dispersion (MSPD) for the determination of BA. MSPD is a relatively new extraction technique suitable for solid samples, which combines homogenization, analyte extraction, and purification in one step. An aliquot of the sample is placed into a mortar and pretreated C18 or CN-silica sorbent is added and blended. The homogenized sample is introduced into a cartridge, and MSPD column is eluted using formic-acid aqueous solution/methanol.

The recovery of amines extraction can be significantly enhanced by using surfactants [31].

#### 41.4.4 Derivatization

Chromatographic methods with UV/Vis or fluorometric detection are generally used (apart from electrophoretic methods) for the determination of amines (see Sections 41.5 and 41.6). The absence of chromophore or fluorophore group in BA/PA molecules (except tyramine and 2-phenylethylamine) has led to the need for the insertion of this group into the amine molecule using a derivatization step.

The applicable derivatization agents are as follows: dansyl chloride (DCl); dabsyl chloride; *o*-phthalaldehyde (OPA); derivatives of fluorescein (dichlorotriazinylamino-fluorescein); benzoyl chloride; 6-aminoquinolyl-*N*-hydroxysuccinimidyl carbamate; 9-fluorenylmethylchloroformate (9-fluorenylmethyloxycarbonyl chloride, Fmoc); phenylisothiocyanate [21]; 4-fluor-7-nitro-2,1,3-benzoxadiazole [32]; and 3-(2-furoyl)quinoline-2-carboxaldehyde [33]. Other derivatization agents used specifically in capillary electrophoresis are listed in the review by Oguri [34].

The difference in the use of the two most frequently applied derivatization agents, DCl and OPA, is as follows: dansyl derivatives allow rapid separation in combination with the UV detection (at 254 nm), while OPA derivatives require longer separation time and use fluorometric detection.

1-Dimethylaminonaphthalene-5-sulfonyl chloride (DCl) is the most common derivatization agent for amines determination in dairy food samples, especially cheeses [18,26]. It is the most widely used reagent for precolumn derivatization of amines prior to HPLC separation. However, some limitations in the use of DCl are its light sensitivity and limited stability.



The derivatization step is usually performed using DCI dissolved in acetone under slightly alkaline conditions ( $\text{NaHCO}_3$  solution) and at a higher temperature (typically  $40^\circ\text{C}$ – $60^\circ\text{C}$ ) for 20–60 min. Lower temperature ( $20^\circ\text{C}$ ) and shorter derivatization time (20 min) leads to poor reproducibility and derivatization recovery.

Dansyl derivatives are detected in the UV region of the spectra (at 254 nm).

The main limitation of OPA application is the fact that the derivatization is insufficient in the case of amines with secondary amino groups (spermidine, spermine). On the other hand, OPA was successfully applied as a derivatization agent for the determination of histamine, tyramine, tryptamine, putrescine, 2-phenylethylamine, and cadaverine in Dutch-type hard cheese [18]. The online derivatization with OPA can also be performed during capillary electrophoretic determination of amines [35].

The OPA derivatives of BA are usually quantified using a fluorometric detector. The excitation and emission wavelength for the detection of amine derivatives is 330 and 440 nm, respectively.

9-Fluorenylmethoxycarbonyl chloride is a derivatization agent for both amino acids and PA with secondary amino groups, spermine, and spermidine. The derivatives are stable at room temperature and in acidic conditions. The major advantage is a possibility to detect very low concentrations of the analytes. The derivatization is performed in sodium hydrogen carbonate/sodium carbonate buffer ( $\text{pH} = 10.2$ ) at  $40^\circ\text{C}$  for 10 min. The reaction is completed by the addition of concentrated hydrochloric acid, and the derivatives can be stored at  $4^\circ\text{C}$  until its use in the analysis. Fluorescence detection with excitation and emission wavelength 262 and 615 nm, respectively, is applied. The method has been used for the determination of putrescine, cadaverine, spermine, spermidine, and other amines in biological fluids [36], but can also be applied for dairy foods.

Dabsyl chloride (4-dimethylaminoazobenzene-4'-sulfonil chloride) was used by Bockhardt et al. [37] as a derivatization agent in connection with reversed-phase HPLC determination of BA in cheeses. Dabsyl chloride reagent ( $12.4 \text{ mmol L}^{-1}$ ) was prepared by dissolving 40 mg of dabsyl chloride in 10 mL of acetone. An automated precolumn device was used for the derivatization performed at  $70^\circ\text{C}$  for 15 min.

When the determination of both amino acids and amines with primary and secondary amino groups is required, the two-step derivatization can be performed using a combination of OPA, ethanethiol, and 9-fluorenylmethoxycarbonyl chloride. The primary amino groups are derivatized by OPA in the first step; while the derivatization of secondary amino groups by Fmoc is followed in the second step. Ornithine, lysine, putrescine, cadaverine, 1,7-diaminoheptane, spermidine, and spermine were determined by this approach by Körös et al. [38].

For the sake of completeness, one of the less frequently applied derivatization agents, 4-chloro-7-nitrobenzofurazan, was used for the determination of tyramine in cheese [39]. The derivatized product was detected at 458 nm using an UV detector.

### 41.4.5 Separation

Önal provided a review of the current methods for BA/PA determination in various foods, including dairy foods [40]. The analytical methods can be divided into screening, semiquantitative, and quantitative methods. Thin-layer chromatography is often used for screening or semiquantitative determination (densitometric quantification) of amines. Furthermore, chromatographic (gas chromatography [GC]; liquid chromatography equipped with various types of detectors, including mass spectrometric (MS) detection; ion-exchange chromatography) and electromigration (capillary electrophoresis, capillary electrochromatography, micellar electrokinetic chromatography with optical or contactless conductivity detectors) methods have been applied for more precise determination of BA/PA in dairy foods.

Thin-layer chromatography is a simple and fast separation method used for amines determination and semiquantification. The quantification is performed by densitometers. Owing to the absence of a chromophore in most amine molecules, it is necessary to use a sorbent with UV/Vis absorption properties or to derivatize the analyte [41].

GC is rarely used for the analysis of complex BA/PA mixtures. The volatility of amines is relatively low (GC is a separation method suitable for the determination of volatile analytes), and their direct determination by GC is complicated owing to the poor peak shapes (inherent tailing). To increase volatility, amines should be derivatized, e.g., with heptafluorobutyric anhydride [42].

Liquid chromatography of nonderivatized, precolumn, or postcolumn derivatized amines is the most frequently used separation method for amines determination in all types of dairy food samples. Precolumn derivatization directly influences the separation properties of the amines, while postcolumn derivatization allows only an increase in the sensitivity of the detection.

Reversed-phase HPLC is the most frequently applied method for the determination of derivatized BA. Both DCI [18,26] and OPA derivatives are less polar compounds than the original amines, and therefore, they can be easily separated using columns with nonpolar (reversed) stationary phase.

HPLC procedures were recently used for amines determination in cheeses (stationary phase, elution, mobile phase, flow rate [FR] in mL min<sup>-1</sup>): Phenomenex Luna RP-18, isocratic elution, methanol/H<sub>2</sub>O 70/30, FR 1 [39]; Luna C18, gradient elution, 0.1% TFA/methanol, FR 0.2 [30]; reversed-phase Kromasil KR 100-5 C18, acetonitrile/H<sub>2</sub>O, FR 0.8 [20]; Zorbax Eclipse XDB C18, gradient elution, H<sub>2</sub>O/acetonitrile, FR 0.8 [18].

Micellar liquid chromatography (MIC), an alternative to a conventional HPLC, uses a mobile phase with surface-active compounds. The application of micellar environment reduces the requirements for sample preparation. Moreover, it improves the chromatographic parameters, such as peak resolution and sensitivity of UV detection in determination of aromatic BA, owing to enhancement of benzene-ring absorption.

However, the problematical part of this method is the impossibility to use a MS detector owing to the very low ion production in ion source in the presence of surfactants, and consequently, low sensitivity of mass detection. MIC with electrochemical detection at 0.8 V with mobile phase of 0.15 M sodium dodecyl sulfate and 5% 1-propanol at pH 3 was used for the determination of tryptamine and tyramine in wine samples, but it can also be successfully applied for the determination of these BA in other food matrices, including dairy products [43].

Owing to the polar properties of BA, hydrophilic interaction liquid chromatography (HILIC) can be successfully used for their determination. The chromatographic column contains a polar stationary phase, which can interact with polar compounds, including BA that are protonized under acidic conditions. Using this approach, Gianotti et al. [22] determined cadaverine, histamine, spermidine, spermine, tryptamine, tyramine, and putrescine in Castemagno cheese.

The separation principle of ion chromatography (IC) is based on cation (or anion) exchange on the stationary phase. Because BA are present as cations in acidic conditions, the derivatization step can be omitted. The disadvantage of IC is strong retention of amines on a column owing to the strong hydrophobic interactions, with a consequence of long retention times and poor peak shapes. Traditionally used conductometric detection is not suitable, owing to the high content of acid in a mobile phase; and hence, amperometric detection should be preferred for amines determination.

Standara et al. [44] separated histamine, tyramine, putrescine, cadaverine, tryptamine, agmatine, spermidine, and spermine (after extraction from cheeses by trichloroacetic acid) using the ion-exchanger column and automatic amino acid analyzer.

Weak acidic ion exchangers have recently been developed, which minimize the hydrophobic interaction between amines and stationary phase, and mobile phase with better compatibility with conductometric detection can be used [45].

In contrast to the chromatographic methods, where the flow of the mobile phase is generated by a pump, the driving force in electrophoretic methods is electroosmosis. The wall of silica capillary contains dissociable siloxane groups that charge the wall negatively. The negative charge is compensated by ions from the solution, and when the electric potential is applied, the liquid moves as bulk to the oppositely charged electrode. The value and polarity of capillary surface charge can be modified by surface-active compounds, such as tensides.

Sun et al. [46] used capillary electrophoresis with pulsed amperometric detection for the determination of BA in milk. Furthermore, capillary zone electrophoresis, in combination with conductometric detection, was applied by Kvasnička et al. [24].

Oguri et al. [47] modified the above-mentioned method, capillary electrochromatography, as follows: they first formed a frit inside a capillary and then filled the rest of this capillary with the C18 stationary phase. This arrangement allowed separation of histamine, serotonin, tyramine, putrescine, and cadaverine as OPA derivatives in 23 min. In another modification, micellar electrokinetic chromatography, applied by Křížek and Pelikánová [48], an uncoated fused-silica capillary column was used for the separation of putrescine, cadaverine, spermidine, spermine, tryptamine, histamine, and tyramine as *N*-substituted benzamides.

#### 41.4.6 Detection

The most frequently used detection method for BA/PA is a measurement of absorbance in the UV range. The majority of amines do not contain chromophores allowing the detection by absorption in the UV/Vis area. Therefore, derivatization is necessary for introducing a chromophore into the amine molecule (for the list of applicable derivatization agents, see Section 41.4). Similarly, fluorometric detection is more selective and sensitive than the UV/Vis one.

As far as determination of BA/PA in dairy foods (cheeses) is concerned, the following combinations of derivatization/UV detection wavelength were recently applied: 4-chloro-7-nitrobenzofuran/458 nm [39]; DCI/254 nm [18,20].

Currently MS is being widely applied in chromatography of BA/PA. Amines can be detected as positively charged ions, either as derivatives (precolumn derivatization with DCI) or without previous derivatization. However, a disadvantage of the MS detection is the high cost of instrumentation.

Gosetti et al. [21] used electrospray ionization-tandem mass spectrometry (ESI-MS/MS) for the determination of amines in the three typical semihard Italian cheeses. Amines were detected in a positive-ion mode (ESI<sup>+</sup>) in the following parent → secondary ion mass/charge (*m/z*) ratios: cadaverine 103 → 86; histamine 112 → 95, 112 → 68; spermidine 146 → 129, 146 → 112; spermine 203 → 129, 203 → 112, 203 → 84; tryptamine 161 → 144, 161 → 117; and tyramine 138 → 121, 138 → 93. Similarly, Calbiani et al. [30] performed selected reaction-monitoring analyses of histamine, tyramine, and 2-phenylethylamine (extracted from cheese using the MSPD method, see Section 41.3) as follows: *m/z* 112 → 68 and 112 → 95, *m/z* 138 → 103 and 138 → 121, and *m/z* 122 → 77 and 122 → 130, respectively.

Finally, a possibility of detection of total BA content using an amperometric biosensor with commercial diamino oxidase (from porcine kidney) can be mentioned [49].

Limit of detection for individual BA and PA in a standard solution is usually in the range from 0.2 to 0.45 μg L<sup>-1</sup> (ion-pair chromatography using reversed-phase column with postcolumn OPA

derivatization and fluorometric detection [27]) to 5.1–35.0  $\mu\text{g L}^{-1}$  (HPLC followed by tandem MS detection [21]). The detection limits for amines extracted from cheeses vary between 0.05 and 0.25  $\text{mg kg}^{-1}$  (MSPD followed by LC–electrospray MS/MS [30]) and 0.7–1.5  $\text{mg kg}^{-1}$  [27].

#### 41.4.7 Example of a Protocol

*Sample.* One of the objectives of the analysis was to evaluate the amine distribution within the Dutch-type hard or semihard cheese produced from pasteurized milk [12,18].

*Laboratory equipment and apparatuses:*

1. Liquid chromatograph HP 1100 (Agilent Technologies, Wilmington, DE) consisting of a quaternary pump (G1311A), vacuum degasser (G1322A), automatic sampler (G1313A), and a photometric UV/Vis detector with the variable wavelength (G1314A).
2. Zorbax Eclipse XDB C18 column (150 mm  $\times$  4.6 mm, particle size of 5  $\mu\text{m}$ ; Agilent Technologies, Wilmington, DE).
3. Guard column Meta Guard ODS-2 (30 mm  $\times$  4.6 mm, particle size of 5  $\mu\text{m}$ ; MetaChem Technologies, Torrance, CA).
4. Disintegrator Heidolph Diax 900 (Heidolph Instruments, Germany).
5. Centrifuge Hettich Universal 32R (Hettich, Germany).
6. Minishaker MS2 IKA (IKA Werke GmbH, Staufen, Germany).
7. Thermostat EVATERM for 25 vials, volume of 4 mL (Labcicom, Olomouc, Czech Republic).
8. Compressed nitrogen container.
9. Nylon membrane filter, 13 mm, 0.45  $\mu\text{m}$  (Chromatography Research Supplies, Addison, TX).

*Reagents*

1. Internal standard: dissolve 100 mg of 1,7-diaminoheptane (Sigma-Aldrich, Prague, Czech Republic) in 100 mL of deionized water (concentration 1  $\text{mg mL}^{-1}$ ).
2. Amines standard stock solution: prepare the solution of the mixed standard of all BA and PA to be analyzed: dissolve 100 mg of each amine (use respective hydrochlorides as standards, Sigma-Aldrich, Prague, Czech Republic) in 100 mL of deionized water (concentration of each amine standard, 1  $\text{mg mL}^{-1}$ ).
3. Mixed working standard solution: mix 0.5 mL of amines standard stock solution with 0.5 mL of internal standard solution, and adjust the volume exactly to 50 mL; the final concentration of BA is 10  $\mu\text{g mL}^{-1}$ .
4. Extraction agent: 0.1 M HCl; dissolve 3.5 mL of 35% HCl in 1 L of deionized water.
5. Derivatization agent: dissolve 5 mg of DCl (5-dimethylaminonaphthalene-1-sulfonyl chloride) in 1 mL of 2-propanone (Sigma-Aldrich, St. Louis, MO).
6.  $\text{Na}_2\text{CO}_3$  (saturated solution; pH adjusted to 11.2).
7. 10 mM ammonia solution: dissolve 1.48 mL of 26% ammonia solution in 1 L of deionized water.
8. Diethylether (p.a., Sigma-Aldrich, Prague, Czech Republic).
9. Acetonitrile (ACN; HPLC gradient grade, Sigma-Aldrich, Prague, Czech Republic).

*Sample preparation.* Cross-cut each block of the cheese in the middle, and divide it into two parts: edge part, 3 cm thick, and the rest is the core part. Analyze each part separately.

*Extraction.* Grate or cut the cheese sample into small pieces. Weigh the sample (10 g), place it in the 85 mL plastic centrifuge tube, add 20 mL of 0.1 M HCl and 0.5 mL of an internal standard solution, and extract the sample for 2 min using a disintegrator. Centrifuge the suspension at  $755 \times g$  for 10 min at 4°C to separate the solid part and fats. Filter the supernatant through the paper filter (Filtrak, No. 390) and extract the solid residue for the second time following the same procedure as mentioned earlier, for the quantitative extraction of BA. Make the combined extracts up to 50 mL with deionized water and filter the extracts through a disposable nylon membrane filter.

*Derivatization.* Mix 1 mL of an extract (or standard) with 0.5 mL of saturated  $\text{Na}_2\text{CO}_3$  (pH adjusted to 11.2) in 4 mL amber vial for 1 min, add 1 mL of the derivatizing agent, and shake for 1 min in a shaker. Put the vials in a thermostat. Let the derivatization proceed for 1 h in dark at 40°C; shake the vial content repeatedly after 15 min. Let the mixture stay for 15 min after the derivatization reaction is completed, and subsequently, add 250  $\mu\text{L}$  of 10 mM ammonia solution to remove the excess of unreacted DCl, shake for 1 min and wait for 30 min. Extract the amine derivatives by diethylether ( $3 \times 1$  mL). Evaporate the organic phase to dryness under nitrogen, and dissolve the solid residue in 0.5 mL of acetonitrile. Filter the solution through the 0.45  $\mu\text{m}$  nylon membrane filter, and inject the aliquot onto the chromatographic column.

*Separation.* Carry out the separation of BA and PA by gradient elution with  $\text{H}_2\text{O}/\text{ACN}$  (time, 0–23 min:  $\text{H}_2\text{O}$ , 35%–0%; ACN, 65%–100%) on the Zorbax Eclipse XDB C18 column (150 mm  $\times$  4.6 mm, particle size of 5  $\mu\text{m}$ ) with the guard column Meta Guard ODS-2 (30 mm  $\times$  4.6 mm, particle size of 5  $\mu\text{m}$ ) at the FR 0.8 mL  $\text{min}^{-1}$ .

Identify the separated amines using a photometric UV/Vis detector at 254 nm by comparing the retention times of the particular BA/PA standards (an example of a chromatogram of the BA/PA standard and of amines separated from the typical Dutch-type semihard cheese after HCl extraction is presented in Figure 41.3). Express BA/PA concentrations after DCl derivatization in  $\text{mg kg}^{-1}$  of the original (fresh) cheese.

*Data evaluation.* Correct the concentration of BA in the sample ( $c_x$ ; in  $\text{mg kg}^{-1}$ ) according to the concentration of internal standard, based on the equation:

$$c_x = c_{\text{IS}} \times A_x / A_{\text{IS}} \times \text{RF}_x,$$

where

$c_{\text{IS}}$  is the concentration of an internal standard (in  $\text{mg kg}^{-1}$ )

$A_{\text{IS}}$  is the peak area of the internal standard (in area units)

$A_x$  is the peak area of the BA/PA (in area units)

$\text{RF}_x$  is a response factor of the amine:

$$\text{RF}_x = c_{\text{xr}} / c_{\text{ISr}} \times A_{\text{ISr}} / A_{\text{xr}},$$

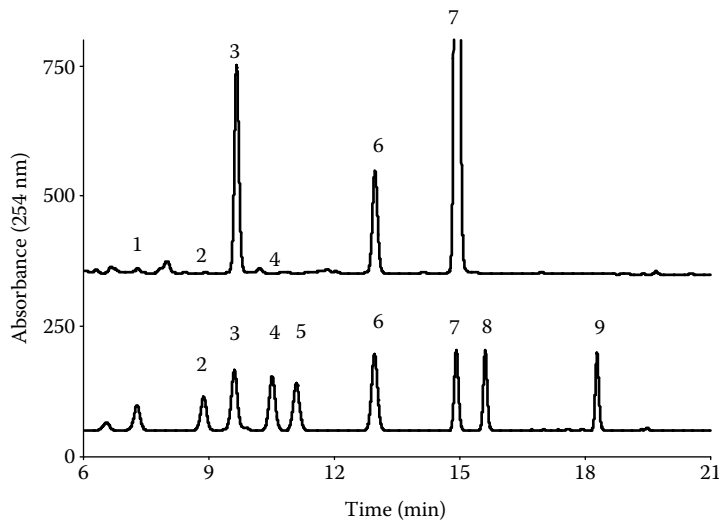
where

$c_{\text{xr}}$  is concentration of BA in the reference sample ( $\text{mg kg}^{-1}$ )

$c_{\text{ISr}}$  is the concentration of an internal standard added to the reference sample ( $\text{mg kg}^{-1}$ )

$A_{\text{ISr}}$  is the peak area of the internal standard in the reference sample (in area units)

$A_{\text{xr}}$  is the peak area of the BA in the reference sample (in area units)



**Figure 41.3** Separation of BA and PA by gradient elution with H<sub>2</sub>O/acetonitrile on the Zorbax Eclipse XDB C18 column (150 mm × 4.6 mm, particle size 5 μm) at the FR 0.8 mL min<sup>-1</sup> using photometric UV/Vis detector at 254 nm; bottom: standard mixture, top: HCl extract of the typical Dutch-type semihard cheese; 1, tryptamine; 2, 2-phenylethylamine; 3, putrescine; 4, cadaverine; 5, histamine; 6, internal standard (1,7-diaminoheptane); 7, tyramine; 8, spermidine; 9, spermine (for a better comparison, both the dependences are put in a single time-absorbance plot; therefore, the absolute values on the absorbance axis do not correspond, and only the values relative to the respective baseline are relevant).

Evaluate the repeatability of the analytical process (expressed as a RSD), by injecting a mixture of the BA/PA standards after derivatization for 10 times and injecting five extracts of the selected cheese sample with a low BA/PA content after derivatization, respectively.

Evaluate the recoveries by measuring a cheese sample five times with added mixture of BA/PA standards with the concentration level of 2 mg kg<sup>-1</sup>. Calculate the recovery (*R*) as

$$\% R = [(CF - CU)/CA] \times 100,$$

where

CU is the concentration in the original sample

CA is the concentration of the added analyte

CF is the concentration in the spiked sample (all concentrations in mg kg<sup>-1</sup>)

## References

1. Bardócz, S. et al., Polyamines in food—implications for growth and health, *J. Nutr. Biochem.* 4, 66, 1993.
2. Til, H.P. et al., Acute and subacute toxicity of tyramine, spermidine, putrescine, and cadaverine in rats, *Food Chem. Toxicol.* 35, 337, 1997.
3. Wolter, F., Ulrich, S., and Stein, J., Molecular mechanisms of the chemopreventive effects of resveratrol and its analogs in colorectal cancer: Key role of polyamines? *J. Nutr.* 134, 3219, 2004.

4. Paulsen, J.E. et al., Dietary polyamines promote the growth of azoxymethane-induced aberrant crypt foci in rat colon, *Carcinogenesis* 18, 1871, 1997.
5. Silla-Santos, M.H., Biogenic amines: Their importance in foods, *Int. J. Food Microbiol.* 29, 213, 1996.
6. Novella-Rodríguez, S. et al., Distribution of biogenic amines and polyamines in cheese, *J. Food Sci.* 68, 750, 2003.
7. Novella-Rodríguez, S. et al., Influence of starter and nonstarter on the formation of biogenic amine in goat cheese during ripening, *J. Dairy Sci.* 85, 2471, 2002.
8. Roig-Sagués, A.X., Molina, A.P., and Hernández-Herrero, M.M., Histamine and tyramine-forming microorganisms in Spanish traditional cheeses, *Eur. Food Res. Technol.* 215, 96, 2002.
9. Fernández-García, E., Tomillo, J., and Nunez, M., Formation of biogenic amines in raw milk Hispánico cheese manufactured with proteinases and different levels of starter culture, *J. Food Prot.* 63, 1551, 2000.
10. Rea, C.M. et al., Development of enterococci and production of tyramine during the manufacture and ripening of Cheddar cheese, *Irish J. Agric. Food Res.* 43, 247, 2004.
11. Schneller, R., Good, P., and Jenny, M., Influence of pasteurised milk, raw milk, and different ripening cultures on biogenic amine concentrations in semi-soft cheeses during ripening, *Z. Lebensm. Untersuch. Forsch. A* 204, 265, 1997.
12. Komprda, T. et al., Tyramine production in Dutch-type semi-hard cheese from two different producers, *Food Microbiol.* 25, 219, 2008.
13. Bover-Cid, S. and Holzapfel, W.H., Improved screening procedure for biogenic amine production by lactic acid bacteria, *Int. J. Food Microbiol.* 53, 33, 1999.
14. Sambrook, J. and Russel, D.W., *Molecular Cloning. A Laboratory Manual*, Vol. 1, 3rd edn., Cold Spring Harbour Laboratory Press, New York, 2001.
15. Landete, J.M. et al., Molecular methods for the detection of biogenic amine-producing bacteria on foods, *Int. J. Food Microbiol.* 117, 258, 2007.
16. Hunter, E.A., McNulty, D.A., and Banks, J.M., Statistical design and analysis of experiments in cheese technology, *Lebensm. Wiss. u. Technol.* 30, 121, 1997.
17. Petridis, K.D. and Steinhart, H., Biogene Amine in der Hartkäseproduktion: I. Einfluß verschiedener Parameter auf den Amingehalt im Endprodukt am Beispiel von Emmentaler Käse, *Deutsche Lebensmittel-Rundschau* 92, 114, 1999.
18. Komprda, T. et al., Content and distribution of biogenic amines in Dutch-type hard cheese, *Food Chem.* 102, 129, 2007.
19. Novella-Rodríguez, S., Veciana-Nogués, M.T., and Vidal-Carou, M.C., Biogenic amines and polyamines in milks and cheeses by ion-pair high performance liquid chromatography, *J. Agric. Food Chem.* 48, 5117, 2000.
20. Innocente, N. et al., Determination of biogenic amines in cheese using HPLC technique and direct derivatization of acid extract, *Food Chem.* 101, 1285, 2007.
21. Gosetti, F. et al., High performance liquid chromatography/tandem mass spectrometry determination of biogenic amines in typical Piedmont cheeses, *J. Chromatogr. A* 1149, 151, 2007.
22. Gianotti, V.U. et al., A new hydrophilic interaction liquid chromatography tandem mass spectrometry method for the simultaneous determination of seven biogenic amines in cheese, *J. Chromatogr. A* 1185, 296, 2008.
23. Martuscelli, M. et al., Production of biogenic amines during the ripening of Pecorino Abruzzese cheese, *Int. Dairy J.* 15, 571, 2005.
24. Kvasnička, F. and Voldřich, M., Determination of biogenic amines by capillary zone electrophoresis with conductometric detection, *J. Chromatogr. A* 1103, 145, 2006.
25. Pinho, O. et al., Effect of temperature on evolution of free amino acid and biogenic amine contents during storage of Azeitão cheese, *Food Chem.* 75, 287, 2001.
26. Lanciotti, R. et al., Effects of milk high pressure homogenization on biogenic amine accumulation during ripening of ovine and bovine Italian cheeses, *Food Chem.* 104, 693, 2007.

27. Leuschner, R.G.K., Kurihara, R., and Hammes, W.P., Effect of enhanced proteolysis on formation of biogenic amines by lactobacilli during Gouda cheese ripening, *Int. J. Food Microbiol.* 44, 15, 1998.
28. Vale, S. and Glória, M.B.A., Determination of biogenic amines in cheese, *J. AOAC Int.* 80, 1006, 1997.
29. Moret, S. and Conte, L.S., High-performance liquid chromatographic evaluation of biogenic amines in foods. An analysis of different methods of sample preparation in relation to food characteristics, *J. Chromatogr. A* 729, 363, 1996.
30. Calbiani, F. et al., Rapid assay for analyzing biogenic amines in cheese: Matrix solid-phase dispersion followed by liquid chromatography-electrospray-tandem mass spectrometry, *J. Agric. Food Chem.* 53, 3779, 2005.
31. Romero, L., Keunchkarian, S., and Reta, M., Extraction of biogenic amines and their dansyl derivatives with reverse microemulsions of bis [2-ethylhexyl] sulphosuccinate (AOT) prior to high-performance liquid chromatographic determination, *Anal. Chim. Acta* 565, 136, 2006.
32. Zhang, L.Y., Tang, X.C., and Sun, M.X., Simultaneous determination of histamine and polyamines by capillary zone electrophoresis with 4-fluor-7-nitro-2,1,3-benzoxadiazole derivatization and fluorescence detection, *J. Chromatogr. B* 820, 211, 2005.
33. Liu, X., Li-Xiang, Y., and Ying-Tang, L., Determination of biogenic amines by 3-(2-furoyl) quinoline-2-carboxaldehyde and capillary electrophoresis with laser-induced fluorescence detection, *J. Chromatogr. A* 998, 213, 2003.
34. Oguri, S., Electromigration methods for amino acids, biogenic amines and aromatic amines, *J. Chromatogr. B* 747, 1, 2000.
35. Oguri, S., Maeda, Y., and Mizusawa, A., On-column derivatization–capillary electrochromatography with o-phthalaldehyde/alkylthiol for assay of biogenic amines, *J. Chromatogr. A* 1044, 271, 2004.
36. Lozanov, V. et al., Liquid chromatography method for simultaneous analysis of amino acids and biogenic amines in biological fluids with simultaneous gradient of pH and acetonitrile, *J. Chromatogr. B* 860, 92, 2007.
37. Bockhardt, A., Krause, I., and Klostermeyer, H., Determination of biogenic amines by RP-HPLC of the dansyl derivatives, *Z. Lebensm. Unters. Forsch.* 203, 65, 1996.
38. Körös, A. et al., Analysis of amino acids and biogenic amines in biological tissues as their o-phthalaldehyde/ethanethiol/fluorenylmethyl chloroformate derivatives by high-performance liquid chromatography: A deproteinization study, *J. Chromatogr. A* 1149, 46, 2007.
39. Yigit, M. and Ersoy, L. Determination of tyramine in cheese by LC/UV, *J. Pharm. Biomed. Anal.* 31, 1223, 2003.
40. Önal, A., A review: Current analytical methods for the determination of biogenic amines in foods, *Food Chem.* 103, 1475, 2007.
41. Shalaby, A.R., Simple, rapid and valid thin layer chromatographic method for determining biogenic amines in foods, *Food Chem.* 65, 117, 1999.
42. Fernandes, J.O. and Ferreira, M.A., Combined ion-pair extraction and gas chromatography–mass spectrometry for the simultaneous determination of diamines, polyamines and aromatic amines in Port wine and grape juice, *J. Chromatogr. A* 886, 183, 2000.
43. Gil-Agustí, M. et al., Simultaneous determination of tyramine and tryptamine and their precursor amino acids by micellar liquid chromatography and pulsed amperometric detection in wines, *J. Chromatogr. A* 1156, 288, 2007.
44. Standara, S., Veselá, M., and Drdák, M., Determination of biogenic amines in cheese by ion exchange chromatography, *Nahrung* 44, 28, 2000.
45. De Borba, B.M. and Rohrer, J.S., Determination of biogenic amines in alcoholic beverages by ion chromatography with suppressed conductivity detection and integrated pulsed amperometric detection, *J. Chromatogr. A* 1155, 22, 2007.
46. Sun, X., Yang, X., and Wang, E., Determination of biogenic amines by capillary electrophoresis with pulsed amperometric detection, *J. Chromatogr. A* 1005, 189, 2003.



47. Oguri, S., Oga, C., and Takeda, H., Micro-magnetic particles frit for capillary electrochromatography, *J. Chromatogr. A* 1157, 304, 2007.
48. Křížek, M. and Pelikánová, T., Determination of seven biogenic amines in foods by micellar electrokinetic capillary chromatography, *J. Chromatogr. A* 815, 243, 1998.
49. Carelli, D. et al., An interference free amperometric biosensor for the detection of biogenic amines in food products, *Biosens. Bioelectron.* 23, 640, 2007.
50. El-Sayed, M.M., Biogenic amines in processed cheese available in Egypt, *Int. Dairy J.* 6, 1079, 1996.
51. Komprda, T. et al., Biogenic amine content in sterilized and pasteurized long-term stored processed cheese, *Czech J. Food Sci.* 23, 209, 2005.
52. Novella-Rodríguez, S. et al., Evaluation of biogenic amines and microbial counts throughout the ripening of goat cheeses from pasteurized and raw milk, *J. Dairy Res.* 71, 245, 2004.
53. Innocente, N. and D'Agostin, P., Formation of biogenic amines in a typical semihard Italian cheese, *J. Food Prot.* 65, 1498, 2002.
54. Valsamaki, K., Michaelidou, A., and Polychroniadou, A., Biogenic amine production in Feta cheese, *Food Chem.* 71, 259, 2000.
55. Pinho, O. et al., Interrelationships among microbiological, physicochemical, and biochemical properties of Terrincho cheese, with emphasis on biogenic amines, *J. Food Prot.* 67, 2779, 2004.
56. Komprda, T., Dohnal, V., and Závodníková, R., Biogenic amine and polyamine contents in a Czech blue-vein cheese, *Czech J. Food Sci.*, 26, 428, 2008.
57. Komprda, T. et al., Some factors influencing biogenic amines and polyamines content in Dutch-type semi-hard cheese, *Eur. Food Res. Technol.* 227, 29, 2008.

---

# Index

---

## A

- Acetobacter pasteurianus*, 314
- 3-Acetyldeoxynivalenol (3-AcDON), 690
- 15-Acetyldeoxynivalenol (15-AcDON), 690
- Acid degree value (ADV)
- definition, 434
  - in lipolytic activity, 433–434
- Acid hydrolysis, 13–14
- Acidification and diacetyl production, 454; *see also* Lactic acid bacteria (LAB)
- Active packaging materials, definition, 773
- 1-Adamantylamine (ADAM), 17
- Adulterations detection, in milk and dairy products, 720, 733–734
- antibody-based analytical methods, 738–741
  - chromatographic methods, 737–738
  - electrophoretic methods, 734–737
  - lipids, authentication testing, 721–724
  - lipids, proteins and authentication testing, 720–721
  - MALDI-TOF-MS, 726
  - milk fat, 742
  - proteins, authentication testing, 724–728
  - species-specific PCR, 742–748
- Advanced-glycation end products (AGEAs), 22
- Aflatoxin B1 (AFB1), 690
- Aflatoxin M1 (AFM1), 318–319, 690
- Agar plate assays, usage, 433
- Age-related macular degeneration (AMD), 596
- Agriculture & Livestock Industries Corp. (ALIC), 589
- Ag<sup>+</sup>-TLC, usage, 174–175
- Aldehydes formation, in milk, 280
- Alkaline hydrolysis, 14
- Alkaline phosphatase, biosensor techniques, 315
- Amines, in dairy foods, 861–862
- BA and polyamines, 864
  - determination
    - amines extraction, 866–869
    - BA and PA analysis, 866
    - derivatization, 869–870
    - detection, 872–873
    - protocols, 873–875
    - separation, 870–872
    - supplementary analysis, 864–866
    - toxicological importance, 862–864
- Amino acid
- and biogenic amines, biosensor techniques, 319–320
  - catabolism, 455–458 (*see also* Lactic acid bacteria (LAB))
  - in dairy foods, analysis, 9–12 (*see also* Milk products)
    - of lysine, 21–23
    - profile, 15–21
    - sample preparation
  - for free amino acid analysis, 12
  - hydrolyzed amino acid analysis, 13–15
    - of tryptophan, 23
    - whole amino acid content analysis, 15
  - profile, analysis
    - capillary zone electrophoresis, 21
    - gas-liquid chromatography, 19–20
    - high-performance liquid chromatography, 15–19
    - proteolysis and catabolism, in flavor formation, 284–286
- Aminoquinoline (AMQ), 18
- 6-Aminoquinolyl-N-hydroxysuccinimidyl carbamate (AQC), 18–19
- Ammonia production and cheese ripening, 409
- Amperometric biosensors, usage, 309
- Amplified fragment length polymorphism (AFLP), 519
- Amplified ribosomal DNA restriction analysis (ARDRA), 519
- Analytical sensory tests, in dairy flavor analysis, 635–637; *see also* Dairy flavor
- Angiotensin-I-converting enzyme (ACE) inhibitors, 43
- Anion-exchange fast protein liquid chromatography method, usage, 737
- Anodic stripping voltammetry (ASV), 556
- Antibiotics
- analysis, in milk and dairy products, 802–803
    - confirmatory methods, 804–814
    - method validation and measurement uncertainty, 814
    - screening methods, 803

- biosensor technique, 315–317
  - definition, 801–802
- Antibody-based analytical methods, in adulterations
  - detection, 738–741; *see also* Milk products
- Antihypertensive activity, of ACE-inhibitory peptides, 62
- Antimicrobial compounds, production, 460–461; *see also* Lactic acid bacteria (LAB)
- AOAC 985.29 method, usage, 487; *see also* Prebiotics
- AOAC 991.43 method, usage, 488; *see also* Prebiotics
- AOAC 2000.11 method, usage, 496–497
- AOAC 2001.03 method, usage, 498
- Aroma extract concentration analysis (AECA), 629–630
- Aroma extraction dilution analysis (AEDA), 626
- Aromatic amino acids, catabolism, 285–286
- Arroyo, Martin, and Cotton agar (AMC), 515
- Arthrobacter nicotianae*, 313
- Ascorbic acid (AA), 532
- Aspergillus oryzae*, 312
- Assize of Bread*, 4
- Association Official Analytical Chemists (AOAC), 233–235, 549
- Atmospheric pressure chemical ionization (APCI), 537, 810
- Atmospheric pressure chemical ionization mass spectrometry (APCI-MS), 352
- Atomic absorption spectroscopy (AAS), 199, 546
- Atomic force microscopy (AFM), 299, 460
- Atomic spectrometry techniques
  - in dairy products manufacture, 559–569
  - for elemental analysis, 559–561 (*see also* Milk products)
    - ICP-MS in minerals and trace elements determination, 567–569
    - in minerals and trace elements determination, 562–566
- Attenuated total reflectance (ATR), 241
- Autoxidation of milk lipids, in milk flavor development, 280–281; *see also* Flavor formation

## B

- Bacillus cereus*, 667, 707–708
- Bacillus coagulans*, 318
- Bacillus sphaericus*, 318
- Bacterial toxins, in dairy foods
  - analysis
    - biological assays, 708
    - biologic-immunologic–phenotypic combination studies, 710–711
    - immunological tests, 708–709
    - phenotypic assays, 709–710
  - Bacillus cereus*, 707–708
  - Escherichia coli*, 707
  - Staphylococcus aureus*, 704, 707
- Bacteria population determination, biosensors, 318
- Bacteriocin unit (BU), definition, 461; *see also* Lactic acid bacteria (LAB)
- Bacteriophage detection systems, in milk, 471
  - microbiological assays
    - conductance measurement, 473
    - electron microscopy, 473–474
    - flow cytometric detection, 475
    - growth test, 473
    - spot/plaque assay, 472–473
  - molecular methods
    - DNA-hybridization, 476
    - ELISA, 475
    - multiplex PCR, 477–478
    - PCR, 476
    - RT-qPCR, 478–479
- Bacteriophage problem, in dairy industry, 470–471
- Bacteriophage resistance analysis, 458–459; *see also* Lactic acid bacteria (LAB)
- BDI method, in lipolytic activity, 433–434
- Biacore technology, usage, 537
- Bifidobacterium animalis* subsp. *animalis*, 515
- Bifidobacterium animalis* subsp. *lactis*, 515
- Bifidobacterium bifidum*, 91
- Bifidobacterium breve*, 515
- Bifidobacterium longum*, 126
- Bifidobacterium longum* biotype *longum*, 515
- Bifidobacterium* medium (BFM), 515
- Bifidobacterium* strain, detection, 510–514
- Bifidus pathway, *see* Fructose-6P shuttle pathway, usage
- Biogenic amines (BA), 861
  - analysis, 866
  - in cheese, 865
  - chemical structure, 862
  - in dairy foods, 864
  - detection method, 872–873
  - determination in cheese, 868
- Biologically active peptides, usage, 51, 54–59
- Biomolecular interaction analysis (BIA), 310
- Biosensor techniques, for dairy products; *see also* Milk products
  - for alkaline phosphatase, 315
  - amino acids and biogenic amines, 319–320
  - for antibiotics, 315–317
  - bacteria population determination, 318
  - for carbohydrates determination
    - disaccharide determination, 312
    - for galactose determination, 312
    - glucose determination, 311
  - for drug residues, 317
  - hydrogen peroxide, 319
  - for lactic acid, 313–314
  - for lipids and fatty acids, 313
  - milk progesterone, 314

- for milk protein, 310–311
  - for pesticides, herbicides, phenols and dioxins, 317–318
  - principle, 308–310
  - toxins, 318–319
  - for vitamins, 313
  - Bixa orellana*, 594
  - $\beta$ -lactoglobulin ( $\beta$ -LG), 87–88; *see also* Milk protein
  - Bovine  $\kappa$ -casein ( $\kappa$ -CN), determination, 310
  - Bovine lactoferrin (BLF), 87; *see also* Milk protein
  - Bovine milk
    - detection
      - ESI-MS, 738
      - RP-HPLC, 737
    - fatty acids, 429
    - TAG composition, 170
  - Bovine serum albumin (BSA), 87, 111; *see also* Milk protein
  - Branched-chain amino acids, catabolism, 285
  - Brevibacterium linens*, 285, 648
  - Buccal headspace analysis (BHA), 619
  - Buffered peptone water (BPW), 681
  - Bureau of Dairy Industries (BDI), principle, 434
  - Butter oil, TAGs separation, 175
  - Butter, processing, 588–589; *see also* Dairy foods
  - Butylated hydroxytoluene (BHT), 535
- C**
- CAD, *see* Charged aerosol detector
  - Camembert-type-cheese ripening, monitoring, 372
  - Candida albicans*, 506
  - Candida utilis*, 649
  - Canonical correlation analysis (CCA), 372
  - Capillary electrophoresis (CE), 38
    - for carbohydrate determination, 160–161
    - in food analysis, 99
    - in organic acids determination, 270–271
    - for protein separation, 118–120
  - Capillary gas chromatographic method, for cholesterol determination, 237–239
  - Capillary isoelectric focusing (CIEF), 99
  - Capillary zone electrophoresis (CZE), 21, 271, 735
  - Carbohydrates, in milk, 139–140; *see also* Milk products
    - quantitation methods
      - capillary electrophoresis, 160–161
      - classical methods, 141–143
      - enzymatic methods, 143–145
      - flow-injection analysis, 145
      - gas chromatography, 147–150
      - HPLC, 150–160
      - infrared spectroscopic methods, 143
      - mass spectrometry, 161–162
      - NMR spectroscopy, 162
      - planar chromatography, 146–147
  - Carbon number, TAG classes separation, 171–173; *see also* Triacylglycerols (TAGs) composition
    - determination, in milk
  - Carbon paste electrode (CPE) biosensor, 319
  - Carboxymethyllysine (CML), 20
  - Carotenoids, usage, 588
  - Cartonboard, usage in dairy products, 767–769
  - $\alpha_{s1}$ -Casein A, amino acid sequence, 85
  - $\beta$ -Casein A<sup>2</sup>, amino acid sequence, 85
  - $\kappa$ -Casein A, amino acid sequence, 86
  - $\alpha_{s1}$ -Casein B, amino acid sequence, 81
  - Casein macropeptide (CMP), 39
  - $\kappa$ -Casein macropeptide (CMP), 57
  - Casein protein, 10; *see also* Milk protein
    - in adulteration detection, 734–737 (*see also* Adulterations detection, in milk and dairy products)
      - molecular properties, 80–81, 85–86
  - Cathodic stripping voltammetry (CSV), 556–557
  - Cation exchange HPLC (CE-HPLC), 19, 155
  - CE coupled to electrospray ionization mass spectrometry (CE-ESI-MS), 21
  - CEMAS XRF method, usage, 554
  - Certified reference materials (CRM), 690
  - Channel electron multiplied arrays (CEMAS), 553
  - Charged aerosol detector, 204, 442–443
  - Charge-state distribution (CSD) of milk proteins, 127–128
  - Cheese; *see also* Dairy foods
    - aroma release, 357
    - authenticity determination, 375–379
    - color, microflora role, 591–594
    - composition and rheology measurement, 373–375
    - expression of aqueous phase, 408
    - flavor formation
      - amino acids proteolysis and catabolism, 284–286
      - lactose fermentation and citrate conversion, 282–283
      - lipolysis and catabolism of fatty acids, 286–288
    - flavor generation, raw materials, 284
    - in food supply, 10
    - making process, 589
    - manufacture, 648
    - microstructure and microscopy techniques, 299–302
    - peptides analysis
      - mass spectrometry, 60–61
      - RP-HPLC, 42
    - proteolysis, 405–406
      - chemometric analysis, 414–417
      - chromatographic methods, 411–412
      - colorimetric and fluorimetric methods, 409–410
      - electrophoresis, 410–411
      - extraction methods, 406–408
      - MALDI-ToF-MS, 412–413

- methods, 409
- peptides fractionation, 408–409
- ripening
  - characterization, peptide analyses methods, 35–38
  - monitoring, 371–373
- technique for making
  - gas chromatographic techniques, 367
  - liquid chromatographic techniques, 365–366
  - physicochemical analyses, 364–365
  - rheological techniques, 367–368
  - sensory analysis, 368–369
- Chemical ionization (CI)-based methods, for TAGs
  - determination, 178
- Chemical migration, definition, 756; *see also* Food contact materials (FCM)
- Chemical wet methods, usage, 260–261
- Chemometric techniques
  - application, 42–43
  - usage, 330, 722
- Chewiness, definition, 606; *see also* Dairy foods
- Chinese hamster ovary (CHO), 708
- Chloramine-T method, for carbohydrate quantification, 141
- Chloramphenicol (CAP), determination, 316–317
- Cholesterol, in dairy products, 230–231; *see also* Milk products
  - analytical methods to determine
    - accuracy and precision, 247–252
    - advantages and disadvantages, 253–254
    - AOAC method, 233–235
    - capillary gas chromatographic method, 237–239
    - enzymatic methods, 244–245
    - FIL-IDF method, 236–237
    - FTIR and FT-NIR spectroscopic methods, 241–242
    - HPLC, 239–241
    - SFC, 245–246
    - spectrometric methods, 242–244
- Chromatographic methods
  - in adulterations detection, 737–738 (*see also* Adulterations detection, in milk and dairy products)
  - for carbohydrate determination
    - gas chromatography, 147–150
    - HPLC, 150–160
    - planar chromatography, 146–147
  - in dairy products manufacture, 557–559
  - for glycolysis determination, 395–396
  - in lipid research (*see also* Lipolytic determination, in milk and dairy products)
    - GC, 440–441
    - liquid chromatography, 441–443
    - TLC, 440
  - in milk and dairy products, 557–559 (*see also* Milk products)
    - peptide analysis, 40–45
    - for TAG composition determination, 170–171
- Chromogenic enzymatic method, 144
- Chromogenic substrates, usage, 435
- Citrate conversion, in flavor formation, 282–283
- Cluster analysis (CA), 44
- $\alpha_1$ -CN, structure examination, 81
- Codex Alimentarius standards, of foods, 824
- Codex Committee on Food Additives and Contaminants (CCFAC), 824
- Codex Committee on Pesticide Residues (CCPR), 824
- Colorimetric methods
  - for carbohydrate determination, 143
  - for free amino acids, 409–410
- Column chromatography, for lipid fractionation, 195, 197
- Combined hedonic aroma response method (CHARM), 626
- Commercially pasteurized and homogenized (CPH), 589–590
- Common component and specific weights analysis (CCSWA), 372
- Competitive enzyme-linked immunosorbent assay (C-ELISA), 100
- Computer vision systems; *see also* Imaging techniques, of dairy products
  - in cheese browning determination, 334
  - definition, 333–335
  - role, 334–335
- Conditionally essential, 10
- Conductance measurement method, usage, 473; *see also* Bacteriophage detection systems, in milk
- Conductivity detection, of organic acids, 264
- Confocal scanning laser microscopy (CSLM), 296–297
- Conjugated linoleic acid (CLA), 212
- Controlled atmosphere packaging (CAP), 774
- Conventional methods, in probiotics microorganisms, 509, 515; *see also* Probiotics
- Copper soaps, usage, 437–438
- Corynebacterium bovis*, 667
- Coryneform bacteria and cheese, 649
- Covalent adduct chemical ionization tandem mass spectrometry (CACI-MS/MS), 223
- Cream and butter, microstructure techniques, 304–305
- Cryo-scanning electron microscopy (Cryo-SEM)
  - technique, 296–297
- Culture-independent methods, for bacterial identification, 453–454; *see also* Lactic acid bacteria (LAB)
- Culture methods, for LAB measurement, 450–451; *see also* Starter cultures, LAB
- Custards; *see also* Dairy foods
  - aroma release, 355–356
  - microstructure techniques, 303
- Cyanopropyl polysiloxane capillary columns, usage, 216

Cyclic instrumental neutron activation analysis (CINAA), 553  
*Cynara cardunculus*, 39  
 Cysteine analysis, usage, 14

## D

Dabsyl chloride, usage, 870  
 Dairy desserts, microstructure techniques, 302–303  
 Dairy flavor, 616–617, 638–639  
   analytical methods  
     instrumental techniques, 619–633  
     sensorial analysis, 633–637  
   extraction techniques, 617–619  
   formation, 277–279  
   off-flavors, characterization, 637–638  
 Dairy foods  
   amines determination, 861–862  
     BA and PA analysis, 864, 866  
     derivatization, 869–870  
     detection, 872–873  
     extraction, 866–869  
     protocols, 873–875  
     separation, 870–872  
     supplementary analysis, 864–866  
     toxicological importance, 862–864  
   amino acids analysis, 9–12  
     free amino acid analysis, sample preparation, 12  
     hydrolyzed amino acid analysis, sample preparation, 13–15  
     lysine analysis, 21–23  
     profile analysis, 15–21  
     tryptophan analysis, 23  
     whole amino acid content analysis, 15  
   bacterial toxins, 704, 707–708  
     biological assays, 708  
     biologic-immunologic-phenotypic combination studies, 710–711  
     future perspectives, 711–712  
     immunological tests, 708–709  
     phenotypic assays, 709–710  
   biosensor techniques  
     for alkaline phosphatase, 315  
     amino acids and biogenic amines, 319–320  
     for antibiotics, 315–317  
     bacteria population determination, 318  
     for carbohydrates determination, 331–312  
     for drug residues, 317  
     hydrogen peroxide, 319  
     for lactic acid, 313–314  
     for lipids and fatty acids, 313  
     milk progesterone, 314  
     for milk protein, 310–311  
     for pesticides, herbicides, phenols and dioxins, 317–318  
     principle, 308–310  
     toxins, 318–319  
     for vitamins, 313  
   carbohydrates, quantitation methods  
     capillary electrophoresis, 160–161  
     classical methods, 141–143  
     enzymatic methods, 143–145  
     flow-injection analysis, 145  
     gas chromatography, 147–150  
     HPLC, 150–160  
     infrared spectroscopic methods, 143  
     mass spectrometry, 161–162  
     NMR spectroscopy, 162  
     planar chromatography, 146–147  
   cholesterol, determination, 230–231  
     AOAC method, 233–235  
     biosensor techniques, 313  
     capillary gas chromatographic method, 237–239  
     enzymatic methods, 244–245  
     FIL-IDF method, 236–237  
     FTIR and FT-NIR spectroscopic methods, 241–242  
     HPLC, 239–241  
     SFC, 245–246  
     spectrometric methods, 242–244  
   color analysis  
     color chart, 585  
     computer vision and digital scanning, 585  
     HPLC, 585–586  
     postprocessing, 594–595  
     quality control, 595–598  
     spectrophotometers, 584–585  
     traditional laboratory visible spectrophotometers, 583  
     tristimulus colorimetry, 584  
     VNIR spectrophotometry, 583–584  
   composition, modification, 590–591  
   dielectric spectroscopy, 338–340  
   factors affecting texture, 604–605  
   fatty acids, 211–212  
     determination, 221–222  
     GC analysis, 213–217  
     isolation and fractionation, 217–219  
     preparation of derivatives, 212–213  
     silver ion HPLC, 219–221  
     structure identification, 222–224  
   flavor formation  
     amino acids proteolysis and catabolism, 284–286  
     from autoxidation of milk lipids, 280–281  
     during heat treatment and storage, 279–280  
     lactose fermentation and citrate conversion, 282–283  
     light-induced, 281  
     lipolysis and catabolism of fatty acids, 286–288  
     package component migration, 281–282

- flavor release, rheological properties
  - cheeses, 357
  - custards, 355–356
  - gel model systems, 353–354
  - yoghurts, 354–355
- foodborne bacterial pathogens detection, PCR
  - methods, 677–680
  - Enterobacter sakazakii*, 682–683
  - future perspectives, 684–685
  - Listeria monocytogenes*, 681–682
  - Mycobacterium avium subsp. paratuberculosis*, 683–684
  - Salmonella*, 680–681
- glycolysis determination, 386–387
  - metabolic pathways, 387–394
  - metabolites detection, 396–399
  - methodologies, 394–396
- imaging techniques
  - computer vision systems, 333–335
  - hyperspectral imaging, 335–337
  - magnetic resonance imaging, 337–338
  - ultrasound imaging, 337
- infrared spectroscopy
  - mid-infrared spectroscopy, 331–332
  - near-infrared technology, 330–331
- limitations, 596
- mass spectrometry applications, 50–63
- microbial analysis, methods
  - culture-dependent methods, 649–654
  - culture-independent methods, 654–655
- microbial ecology, 648–649
- microbial flora, 647–648
- microstructure and microscopy techniques, 295–297
  - for cheese, 299–302
  - cream and butter, 304–305
  - for desserts, 302–303
- mycotoxins, analysis
  - analytical quality assurance, 690–692
  - cleanup methods, 694
  - detection systems, 695, 703–704
  - extraction procedures, 693
  - laboratory precautions, 693
  - quantitative methods, 695
  - sample preparation, 693
  - screening tests, 694–695
- organic acids determination, 259–260
  - individual organic acid, 260–262
  - instrument-based methods, 262–272
- packaging formats
  - active and intelligent packaging, 773–774
  - metal cans, 769–770
  - multilayer packaging materials, 771–772
  - paper/cartonboard, 767–769
  - plastics, 765–766
  - surface-active biocides, 774–775
- peptide analysis
  - applications to dairy peptides, 50–63
  - chromatographic techniques, 40–45
  - electrophoretic methods, 34, 38–40
  - future perspectives, 63
  - immunochemical methods, 46–47
  - instrumentation, 47–49
  - interpretation, 49–50
  - spectroscopic techniques, 45–46
  - tandem mass spectrometry, 49
- pesticides and POPs analysis
  - cleanup, 833–834
  - HRGC, selective detectors, 836–837
  - identification and quantitation, 835–836
  - liquid foodstuff and analyte extraction, 825–827
  - mass spectrometric detector, 837–838
  - semiliquid and analyte extraction, 827–833
- phthalates detection, 777–780, 787
  - in infant milk, 780, 786
  - instrumental conditions, 795–796
  - migration, 790–792
  - milk consumption, 786–787
  - in nondairy products, 787–789
  - sample contamination, 792
  - sample pretreatment, 792–795
  - total diet, 789–790
- polar lipids, 189–193
  - analysis, 199–205
  - sample preparation, 193–199
- processing analysis
  - anteprocessing, 586–588
  - butter, 588–589
  - cheese making, 589
  - dairy food composition, 590–591
  - high pressure, 589–590
  - microflora, role, 591–594
  - mozzarella cheese, 591
- protein
  - casein, molecular properties, 80–81, 85–86
  - characteristics of major bovine, 92–93, 95–98
  - electrophoretic methods, in analysis, 98–99
  - functional property, 88–89
  - hydrolysates peptides analysis, mass spectrometry, 60–61
  - Kjeldahl method, in analysis, 100
  - nutritional and functional roles, 43
  - proteolysis, 59
  - structure and properties changes, 90–92
  - system, types, 80
  - wey protein, molecular properties, 86–88
- proteomic technique, 110–111
  - future perspectives, 132
  - identification techniques, 124–132
  - sample preparation, 111–113
  - separation techniques, 113–124

- quality and identity determination
    - gas chromatographic techniques, 367
    - liquid chromatographic techniques, 365–366
    - physicochemical analyses, 364–365
    - rheological techniques, 367–368
    - sensory analysis, 368–369
    - spectroscopic techniques, 369–379
  - sensory measurements, 609
  - TAGs composition determination, 170
    - gas chromatography, 171–177
    - HPLC analysis, 177–180
    - positional distribution of FAs, 180–182
  - test, 611–612
  - texture, 603–604
    - parameters, definitions, 605
    - profile analysis, 606–607
    - properties, 605
    - variety, 346–347
  - texture measurement
    - butter, 607–608
    - cheese, 607
    - yogurt, 608–609
  - viscosity measurement, 340–341, 609–610
    - capillary tube viscometer, 611
    - rotational viscometers, 611
  - Dairy industry; *see also* Milk products
    - analysis, 3–8
    - bacteriophage problem, 470–471
    - industrialization, 5
  - Dairy peptides, mass spectrometric applications
    - biologically active peptides, 51, 54–59
    - milk proteomics, 50–51
    - proteolysis evaluation, 59
    - quantitative analysis, 59, 62–63
  - 1D discontinuous polyacrylamide gel electrophoresis (Disc-PAGE), 115
  - Debaryomyces hansenii*, 594, 649
  - Deepoxy-deoxynivalenol (DOM-1), 690
  - de Man, Rogosa, and Sharpe (MRS), 450, 509
  - Denaturing gradient gel electrophoresis, 453, 522–523, 654–655
  - Deoxynivalenol (DON), 690
  - Derivative spectrophotometric technique, 46
  - Derivatization, in amino acid analysis, 15–19
  - Deuterated triglycine sulfate (DTGS) detector, 241
  - DGGE, *see* Denaturing gradient gel electrophoresis
  - Diacetoxyscirpenol (DAS), 690
  - 40,6-Diamidino-2-phenylindole (DAPI), 516
  - 3,3'-Diaminobenzidine (DAB), 551
  - 2,3-Diaminonaphthalene (DAN), 551
  - Diarrheal syndrome, cause, 708
  - Dicloxacillin propionic acid medium (DP), 515
  - Dielectric spectroscopy, for dairy foods, 338–340; *see also* Milk products
  - Diethylaminoethyl (DEAE), 412
  - Di-2-ethylhexyl adipate (DEHA), 792
  - Di(2-ethylhexyl)phthalate (DEHP), 778–780, 786–787, 790
  - Differential pulse anodic stripping voltammetry (DPASV), 546
  - Differential pulse polarography (DPP), 557
  - Diffusion ordered spectroscopy (DOSY) technique, 349
  - Dihydroascorbic acid (DHAA), 532
  - 4-Dimethyl-aminoazobenzene-4'-sulfonyl chloride (dabsyl-Cl), 16
  - 1-Dimethylamino-naphthalene-5-sulfonyl chloride (dansyl-Cl), 16–17, 869–870
  - Dimethyl disulfide (DMDS), 278
  - 2,5-Dimethyl-4-hydroxy-3(2*H*)-furanone (DMHF), 619
  - 4,4-Dimethyloxazoline (DMOX) derivatives, 222
  - Diode array detector (DAD), 92, 536, 585, 695
  - Dipsticks, *see* Lateral-Flow Immunoassays (LFIA), for milk protein detection
  - Direct thermal desorption (DTD) technique, usage, 617
  - Disaccharide determination, multienzyme biosensors, 312
  - Dithiothreitol (DTT), 533
  - Divinylbenzene (DVB), 624
  - D-lactate dehydrogenase (D-LDH) enzyme, 261
  - DNA-based methods, in adulteration detection, 742–748; *see also* Adulterations detection, in milk and dairy products
  - DNA, isolation, 519–520
  - Double blind placebo-controlled food challenge (DBPCFC), 845
  - Double focusing/sector field mass spectrometry (DF/SFMS), 561
  - Dried milk particles, microscopic techniques, 298–299
  - Dry ashing, usage, 546, 548
  - Duo-trio tests, in dairy flavor analysis, 636; *see also* Dairy flavor
  - Dynamic headspace (DHS) technique, usage, 618
  - Dynamic headspace dilution assay (DHDA), 630
  - Dynamic head space-gas chromatography–mass spectrometry (DHS-GC–MS), 367
- ## E
- Electroanalysis; *see also* Milk products
    - of milk and dairy products, 556–557
    - of minerals, 556–557
  - Electron capture detector (ECD), usage and features, 836
  - Electronic impact ionization (EII), 222
  - Electronic noses
    - definition, 672
    - technique, usage, 353
    - and tongue, in dairy flavor analysis, 632–633 (*see also* Dairy flavor)
  - Electron microscopy (EM), 296



- Electrophoresis, usage, 6, 410–411; *see also* Cheese, proteolysis
- Electrophoretic methods  
 in adulterations detection, 734–737 (*see also* Adulterations detection, in milk and dairy products)  
 for milk protein analysis  
 capillary electrophoresis, 99  
 one-dimensional PAGE, 98–99  
 two-dimensional (2D) electrophoresis, 99  
 peptide analysis, 34, 38–40
- Electrospray ionization (ESI), 537, 810
- Electrospray ionization-mass spectrometry (ESI-MS), 111, 127–132, 738, 847
- Electrospray ionization-tandem mass spectrometry (ESI-MS/MS), usage, 872
- Electrospray-ion trap, usage, 54
- Electrospray mass spectrometry (ESMS), 162, 571
- Electrothermal atomic spectrometry (ETAAS), 547
- Electrothermal vaporization (ETV), 561
- Emden–Meyerhof–Parnas pathway, 388
- Emetic syndrome, cause, 708
- Emmental cheeses  
 discrimination, 365  
 geographic origin determination, 377
- Energy dispersive (ED)-XRF, usage, 555
- Enrofloxacin determination, biosensor, 317
- Enterobacter sakazakii*, 318, 679, 682–683
- Enterococcus faecalis*, 318
- Enterococcus faecium*, 504
- Enzymatic hydrolysis, 14–15  
 in milk protein modification, 34  
 of proteins, usage, 44  
 usage, 849 (*see also* Food processing effects, in milk allergens)
- Enzymatic methods  
 for cholesterol determination, 244–245  
 for glycolysis determination, 395  
 for lactose determination, 143–144  
 in probiotics microorganisms, 518 (*see also* Probiotics)
- Enzyme-based methods, usage, 261–262
- Enzyme-coagulated soft cheeses, 11
- Enzyme-linked immunoaffinity chromatography (ELIAC), 47
- Enzyme-linked immunofiltration assay (ELIFA), 709
- Enzyme-linked immunosorbent assay (ELISA), 44, 475, 669, 694–695, 725  
 in adulteration detection, 739–740 (*see also* Milk products)  
 in lipolytic activity determination, 443  
 in milk allergens estimation, 850–851
- Enzymes, in flavor development, 10
- Epithermal instrumental neutron activation analysis (EINAA), 553
- Equivalent carbon number (ECN), 177
- Escherichia coli*, 316
- Essential amino acids, 9–10
- Esterases enzyme, role, 428–429
- Esters and milk flavor, 617; *see also* Dairy flavor
- Ethanol determination, 399; *see also* Glycolysis determination, in dairy foods
- Ethanol-soluble fraction (EtSF), 41
- Ethylene diamine tetraacetic acid (EDTA), 549
- ETV reaction cell inductively coupled plasma mass spectrometry (ETV-RC-ICP-MS), 566
- European Union's Community Reference Laboratory for Milk and Milk Products, 692
- Evaporative light-scattering detector (ELSD), 204, 723  
 usage, 442
- Exogenous enzymes, in dairy technology, 7
- Exopolysaccharides (EPS), production, 459–460; *see also* Lactic acid bacteria (LAB)

## F

- Factorial discriminant analysis (FDA), 371
- Fast bombardment mass spectrometry (FAB-MS), 158
- Fat-soluble vitamin (FSV); *see also* Vitamins  
 extraction, 535–536  
 forms, 533
- Fatty acid methyl esters (FAMES), 213, 440
- Fatty acids (FAs), in milk, 170, 211–212; *see also* Milk products  
 analysis, 721–723  
 in bovine milk, 429  
 determination, 221–222  
 GC analysis, 213–217  
 identification, 222–224  
 isolation and fractionation, 217–219  
 lipolysis and catabolism, 286–288  
 preparation of derivatives, 212–213  
 silver ion HPLC, 219–221
- Federation Internationale de Laiterie – International Dairy Federation (FIL-IDF) method, 236–237
- Fermentation, application, 278
- Fermentation effect, in milk allergens, 848; *see also* Milk allergens
- Fermented products, dairy flavor formation pathways, 278
- Field-effect transistors (FETs), 309
- Flame atomic absorption spectrometry (FAAS), 554, 560; *see also* Milk products
- Flame atomic emission spectrometry (FAES), 560
- Flame ionization detector (FID), 19, 171, 213, 262, 440–441
- Flame photometric detector (FPD), defects, 836–837
- Flavin adenine dinucleotide (FAD), 309, 532
- Flavin mononucleotide (FMN), 532

- Flavor formation
- in cheese
    - amino acids proteolysis and catabolism, 284–286
    - lactose fermentation and citrate conversion, 282–283
    - lipolysis and catabolism of fatty acids, 286–288
  - of dairy products, pathways, 278
  - in milk
    - from autoxidation of milk lipids, 280–281
    - during heat treatment and storage, 279–280
    - light-induced, 281
    - package component migration, 281–282
- Flavor profile method (FPM), 635
- Flow-injection analysis (FIA), 145, 311, 551
- 9-Fluorenylmethyl chloroformate (FMOC), 14, 17
- Fluorescein isothiocyanate (FITC), 534
- Fluorescence detection (FLD), 442, 534, 695
- Fluorescence methods, in probiotics microorganisms, 516–518; *see also* Probiotics
- Fluorescence resonance energy transfer (FRET), 678
- Fluorescence spectroscopic technique, 46
- Fluorescent *in situ* hybridization (FISH), 453, 516, 655
- Fluorimetric methods, for free amino acids, 409–410
- 1-Fluoro-2,4-dinitrobenzene (FDNB), 10
- Food; *see also* Dairy foods
- analysis, 4
  - authentication, 6
  - functions, 3
  - and milk processing, enzyme preparations analysis, 7
  - safety, aspects, 3
  - simulants, usage, 764–765 (*see also* Food contact materials (FCM))
  - texture, definition, 603–604
- Food Analysis Proficiency Assessment Scheme (FAPAS), 692
- Foodborne bacterial pathogens detection, in dairy products
- PCR-based methods, 677–680
    - Enterobacter sakazakii*, 682–683
    - future perspectives, 684–685
    - Listeria monocytogenes*, 681–682
    - Mycobacterium avium subsp. paratuberculosis*, 683–684
    - Salmonella*, 680–681
- Food contact materials (FCM), 762
- and chemical migration, 756–759
    - contact with foodstuff, 759–761
    - duration and temperature of contact, 762
    - foodstuff, nature, 759
    - migrating substance, nature, 759
    - nature, 759
  - definition, 756
  - testing of residues, 762–763
    - extraction tests, 763–764
    - food simulants, 764–765
    - migration and total extractables, 763
    - specific migration limits, 763
- Food flavor, definition, 616; *see also* Dairy flavor
- Food flavor release
- characterization
    - diffusion measurement, 348–351
    - flavor transfer measurement, 352–353
    - mechanistic approach, 348
  - from dairy foods, rheological properties
    - cheeses, 357
    - custards, 355–356
    - gel model systems, 353–354
    - yoghurts, 354–355
  - rheological properties effect, 347–348
- Food processing effects, in milk allergens, 846–847; *see also* Milk allergens
- enzymatic hydrolysis, 849
  - fermentation, 848
  - heat treatment, 847–848
  - homogenization, 849
  - ripening, 848
- Food products, milk allergens detection, 849
- hidden allergens, 853–854
  - immunodetection, 850–852
  - proteomic techniques, 853
- Fourier transform infrared (FTIR) spectroscopy, 143, 650
- for cholesterol determination, 232, 241–242
  - FA determination, 223
  - in organic acids determination, 271–272
  - usage, 439
- Fourier transform near-infrared (FT-NIR) spectroscopy, 232, 242
- Fracturability, definition, 606; *see also* Dairy foods
- Free amino acids, 10, 12, 409–410; *see also* Cheese, proteolysis
- Free fatty acid phase (FFAP), 263–264
- Free fatty acids (FFAs), determination, 221–222
- Front-face fluorescence spectroscopy (FFFS), 364
- Fructans, determination, 489; *see also* Prebiotics
- Fructose-6P shuttle pathway, usage, 389–390
- Fumonisin B1 (FB1), 690
- Fumonisin B2 (FB2), 690
- Furosine method, usage, 23
- Fusarenon-X (FUS-X), 690
- ## G
- Galactooligosaccharides (GOS), production, 140
- Galactose determination, 312, 398; *see also* Glycolysis determination, in dairy foods
- Galactose oxidase (GAO) enzyme, usage, 312
- Gas chromatography (GC), 454, 616

- in dairy flavor analysis, 619–621 (*see also* Dairy flavor)
    - and mass spectrometry, 621–622
    - odor-activity assessment, 624–630
    - two-dimensional, 622–624
  - in fatty acids analysis, 213–217
  - in lipolytic activity determination, 440–441
  - in organic acids determination, 262–264
  - for POPs analysis, 835
  - in quality and identity of dairy foods, 367
  - in TAG composition determination
    - molecular species of TAGs, separation, 173–177
    - separation on carbon number, 171–173
  - Gas-liquid chromatography, 19–20, 170
  - Gas sensing electrodes (GSEs), 309
  - Gastrointestinal (GI), 485–486
  - GC capillary column, for phthalates separation, 795
  - GC×GC coupled with a time-of-flight mass spectrometer (GC×GC-TOF-MS), 624
  - GC/MS, in phthalates analysis, 796
  - GC with olfactometry (GC-O), 616, 627
  - Gel diffusion assays, *see* Agar plate assays, usage
  - Gel model systems, usage, 353–354
  - Genetically modified organisms (GMOs), 6
  - Genomic DNA polymorphism, study, 452
  - Geotrichum candidum*, 42, 285, 649
  - Glucose determination, 311, 397–398; *see also* Biosensor techniques, for dairy products; Glycolysis determination, in dairy foods
  - Glucose oxidase (GOD), 308
  - Glucose-6-phosphate dehydrogenase (G-6-PDH), 145
  - Glutamate–pyruvate transaminase (GPT), 261
  - Glycerophospholipids, in dairy products, 190, 192
  - 3-Glycidyoxypropyl trimethoxysilane (GOPS), 317
  - Glycolysis determination, in dairy foods, 386–387
    - metabolic pathways, 387–394
    - metabolites detection, 396–399
    - methodologies, 394–396
  - Gravimetric methods, for carbohydrate determination, 141
  - Grease-proofed paper, usage, 767
  - Gruyère cheeses, geographical origin determination, 378
  - Gumminess, definition, 606; *see also* Dairy foods
- ## H
- Hazard analysis and critical control points (HACCPs), 479
  - Headspace techniques (HS) technique, usage, 617
  - Health and nutritional benefits, of functional foods, 507; *see also* Probiotics
  - Heat treatment, in milk, 847–848; *see also* Milk allergens
  - Hedonic tests, in dairy flavor analysis, 633; *see also* Dairy flavor
  - Helicobacter pylori*, 506
  - Hemolytic-uremic syndrome (HUS), 707
  - Heterofermentative pathway, *see* Pentose phosphate pathway, usage
  - Hexamethyl disilane (HMDS), 233
  - Hierarchical cluster analysis (HCA), 365
  - High-density lipoprotein (HDL), 231
  - High hydrostatic pressure (HHP), 299
  - High-molecular weight soluble dietary fiber (HMWSDF), 498
  - High-performance anion-exchange chromatography (HPAEC), 155
  - High-performance anion-exchange chromatography with electrochemical detection (HPAEC-ED), 495
  - High performance gel permeation chromatography (HPGPC), 412
  - High-performance ion-exchange chromatography (HPIEC), 412
  - High-performance liquid chromatography (HPLC), 455, 532, 557, 794
    - advantage, 723–724
    - for amine determination, 871
    - amino acid analysis, 15–19
    - for carbohydrate determination, 150–160
    - for cholesterol determination, 239–241
    - in dairy food color analysis, 585–586
    - milk protein analysis, 93
    - in organic acids determination, 264–267
      - ion-exchange HPLC, 269
      - ion-exclusion HPLC, 269–270
      - reverse-phase type HPLC, 270
    - sample extraction and pretreatment, 267–269
    - for polar lipids analysis, 202–204
    - for protein separation, 120–124
    - TAGs composition determination
      - detection systems, 177–178
      - molecular species of TAGs, determination, 178–180
  - High-pressure homogenization (HPH), 589–590
  - High resolution (HR) GC
    - advantages, 835
    - selection, 835–836
    - selective detectors, 836–837
  - High-resolution mass spectrometry (HRMS),
    - definition, 814
  - High-temperature/short-time (HTST), 280
  - Histamine, role, 862
  - Homofermentative pathway, usage, 388–389; *see also* Glycolysis determination, in dairy foods
  - Hydride generation atomic absorption spectrometry (HG-AAS), 551
  - Hydride generation atomic fluorescence spectrometry (HG-AFS), 548

Hydrolyzed amino acid analysis, sample preparation, 13–15  
 Hydrophilic interaction liquid chromatography (HILIC), 45  
   for amine determination, 871  
   usage, 805, 810  
 Hydroxymethylfurfural (HMF), 280  
 3-Hydroxy-3-methylglutaryl-CoA (HMG-CoA), 230–231  
 Hyperspectral imaging (HIS), 332, 335–337

## I

Ice cream, microstructure techniques, 302–303  
 ICP-MS, limitations, 561  
 Image analysis techniques, in dairy food color analysis, 585; *see also* Dairy foods  
 Imaging techniques, of dairy products  
   computer vision systems, 333–335  
   hyperspectral imaging, 335–337  
   magnetic resonance imaging, 337–338  
   ultrasound imaging, 337  
 Immobilized enzymes, usage, 308  
 Immobilized metal ion affinity chromatography (IMAC), 59  
 Immunochemical methods, for peptide analysis, 46–47  
 Immunodiffusion techniques, in milk allergens estimation, 850; *see also* Milk allergens  
 Immunoglobulins (IG), 87; *see also* Milk protein  
 Individual organic acid determination, analytical methods, 260–262; *see also* Milk products  
 Indoxyl acyl substrate analogs, usage, 437  
 Inductively coupled plasma atomic emission spectrometry (ICP-AES), 547  
 Inductively coupled plasma mass spectrometry (ICP-MS), 546  
   in minerals and trace elements determination, 567–569  
   usage, 561  
 Inductively coupled plasma-optical emission spectroscopy (ICP-OES), 199  
 Infant formulae (IF)  
   liquid chromatography–mass spectrometry methods, 537  
   multivitamin methods, 536  
   optical biosensor methods, 536–537  
   sources, 531–532  
   vitamins extraction and HPLC quantification  
   fat-soluble vitamin extraction, 535–536  
   water-soluble vitamin extraction, 533–535  
   vitamins, forms  
   fat-soluble vitamins, 533  
   water-soluble vitamins, 532  
 Infant milk, phthalates, 780, 786

Infrared spectroscopic methods  
   for carbohydrate determination, 143  
   for dairy foods  
   mid-infrared spectroscopy, 331–332  
   near-infrared technology, 330–331  
 Injection method, milk fat TAGs determination, 172–173  
 Insoluble dietary fiber (IDF), 487  
 Intelligent packaging materials, definition, 773  
 Internal amplification controls (IACs), 679  
 International Atomic Energy Agency (IAEA), 559, 694  
 International Dairy Federation (IDF), 515, 649, 694  
 International Organization of Standardization (ISO), 603–604, 649  
 Inulin, usage, 486  
 Iodine, determination, 566  
 Ion chromatography (IC), 557–559, 871  
 Ion-exchange chromatography (IEC)  
   in carbohydrate analysis, 154  
   milk-peptide analysis, 45  
   for organic acids analysis, 264, 269  
 Ion-exchange HPLC, application, 123  
 Ion-exclusion chromatography, for organic acid determination, 264, 269–270  
 Ion-selective electrodes (ISEs), 309  
 Ion selective, in dairy products manufacture, 555–556  
 Ion-trap mass analyzer analyzers, 48  
 Isoascorbic acid (IAA), 532  
 Isoelectric focusing (IEF), 99, 109, 735  
 2-Isopropylthioxanthone (ITX), 765  
 Isotope dilution technique, role, 566  
 Italian PDO cheeses ripening, monitoring, 372

## J

Joint Meeting on Pesticide Residues (JMPR), 824

## K

Kefir starter culture, definition, 649  
 Kjeldahl method, in milk protein analysis, 100  
*Kluyveromyces lactis*, 649  
*Kluyveromyces marxianus*, 594, 649

## L

$\alpha$ -Lactalbumin ( $\alpha$ -LA), 87–88; *see also* Milk protein  
 Lactic acid, 313–314, 398; *see also* Glycolysis  
   determination, in dairy foods  
 Lactic Acid Bacteria Beverages Association, 504  
 Lactic acid bacteria (LAB), 109, 282, 450, 647  
   in dairy fermentations

- metabolism, 388–394
    - sugar transport, 387
  - future perspectives, 462–463
  - occurrence, 450
  - production and maintenance, 461–462
  - in starter cultures
    - culture methods, 450–451
    - molecular methods, 452–454
    - phenotypic methods, 451–452
  - technological properties
    - acidification and diacetyl production, 454
    - amino acid catabolism, 455–458
    - antimicrobial compounds, production, 460–461
    - bacteriophage resistance analysis, 458–459
    - exopolysaccharides production, 459–460
    - proteolysis, 454–455
  - usage, 470
  - Lactobacillus acidophilus*, 450, 508, 515
  - Lactobacillus bulgaricus*, 636
  - Lactobacillus casei*, 515, 653
  - Lactobacillus casei* subsp. *casei*, 450
  - Lactobacillus delbrueckii*, 477
  - Lactobacillus delbrueckii* ssp. *bulgaricus*, 413, 515
  - Lactobacillus delbrueckii* subsp. *bulgaricus*, 451
  - Lactobacillus delbrueckii* susp. *bulgaricus*, 450
  - Lactobacillus helveticus*, 126, 455
  - Lactobacillus kefir*, 650
  - Lactobacillus lactis*, 286
  - Lactobacillus reuteri*, 650
  - Lactobacillus rhamnosus*, 515
  - Lactobacillus* species, PCR primers, 521; *see also* Probiotics
  - Lactobacillus* strain, detection, 510–514
  - Lactococcus lactis*, 118, 317, 387, 455, 475, 651
  - Lactoferrin in bovine milk, determination, 311
  - Lactose catabolism in milk, biochemical pathways, 283
  - Lactose determination, 396–397; *see also* Glycolysis
    - determination, in dairy foods
  - Lactose fermentation, in flavor formation, 282–283
  - Lactulose determination, FIA, 145
  - Lactuloselysine, estimation, 23
  - Lane–Eynon method, for carbohydrate quantification, 141
  - Lateral-Flow Immunoassays (LFIA), for milk protein detection, 851–852
  - LC-DAD methods, in dairy products, 597–598; *see also* Dairy foods
  - LC/ESI-MS, application, 128
  - Leloir pathway, *see* Tagatose-6P pathway, usage
  - Leuconostoc*, 450
  - Light-induced flavor formation, 281; *see also* Flavor formation
  - Light microscopy (LM), 296–297
  - Limit of detection (LoD), 534
  - Linear discriminant analysis (LDA), 375
  - Lipases enzyme, role, 428–429
  - Lipases, usage, 431
  - Lipids
    - and fatty acids, biosensors, 313
    - in milk, 169
    - in milk and dairy products, authentication testing, 721–724
    - nomenclature, 428
  - Lipolysis
    - aspects, 428–430
    - and cheese rancidity, 671
    - role, 431
  - Lipolytic determination, in milk and dairy products, 432–433
    - chromatographic methods, 440–443
    - immunological methods, 443
    - methods, 433
    - radioactive assays, 439
    - spectrophotometric assays, 435–439
    - surface tension methods, 443–444
    - titrimetric assays, 433–435
    - turbidimetric assays, 433
  - Lipolytic enzymes
    - industrial uses, 430–431
    - role, 430
  - Liquid chromatographic (LC) techniques, for dairy products, 365–366, 496
    - for amine determination, 871
    - in antibiotics analysis, 805–810 (*see also* Milk products)
    - in lipolytic activity determination, 441–443
  - Liquid chromatography-mass spectrometry (LC-MS), 461, 532, 537
    - analysis, of antibiotic residue, 806–809
    - usage, 442, 534
  - Liquid-liquid extraction (LLE), in dairy foods, 825–826; *see also* Pesticides
  - Liquid-phase extraction (LPE), for pesticide detection, 828–829; *see also* Pesticides
  - Liquid-solid extraction (LSE), *see* Liquid-phase extraction (LPE), for pesticide detection
  - Listeria monocytogenes*, 318, 679, 681–682
  - Low-density lipoprotein (LDL), 231
  - Low-fat dairy desserts, rheological properties, 356
  - Low-molecular weight RMD (LMWRMD), 498
  - Lysine, 10, 21–23; *see also* Milk protein
  - Lysinoalanine (LAL), 20
  - Lysogens, usage, 470
  - Lysophosphatidylcholine (LPC), 199
- ## M
- Magnetic resonance imaging (MRI), in food quality assessment, 337–338
  - MALDI-TOF-MS, *see* Matrix-assisted laser desorption/ionization-time-of-flight mass spectrometry

- MALDI-TOF, *see* Matrix-assisted laser desorption/ionization-time-of-flight
- Mass spectrometric detector, usage, 837–838; *see also* Pesticides
- Mass spectrometry detection (MSD), 695
- Mass spectrometry (MS), 454, 616
- in adulteration detection, 725–726 (*see also* Milk products)
  - in antibiotics analysis, 810–811
  - in carbohydrate determination, 161–162
  - and dairy flavor fingerprint, 630–632
  - and gas chromatography, in dairy flavor analysis, 621–622 (*see also* Dairy flavor)
  - in lipolytic activity determination, 441
  - for peptide analysis
    - applications to dairy peptides, 50–63
    - instrumentation, 47–49
    - interpretation, 49–50
    - tandem mass spectrometry, 49
- Matrix assisted laser desorption ionization (MALDI), 571
- Matrix-assisted laser desorption/ionization-time-of-flight, 39, 109, 125
- Matrix-assisted laser desorption/ionization-time-of-flight mass spectrometry, 412–413, 671, 726
- Matrix solid-phase dispersion (MSPD), usage, 617, 830–832
- MECC, *see* Micellar electrokinetic capillary chromatography
- Mercaptopropionic acid (MPA), 319
- Metal cans, usage in dairy products, 769–770
- 4-Methylumbelliferone methods, role, 438
- Micellar casein, features, 80
- Micellar electrokinetic capillary chromatography, 21
- Micellar electrokinetic chromatography (MEKC), 99
- Micellar liquid chromatography (MIC), for amine determination, 871
- Micelle, in milk, 720
- Microbial flora, in dairy products, 647–648
- microbial analysis, methods
    - culture-dependent methods, 649–654
    - culture-independent methods, 654–655
  - microbial ecology, 648–649
- Microbial spoilage detection, in milk and dairy products, 665–667
- chemical and physical spoilage, 672
  - future perspectives, 673
  - microbial metabolites, 670–671
  - modeling spoilage, 672–673
  - sensorial detection, 670
  - spoilage microorganisms, detection methods, 668–669
  - volatile compounds, 671–672
- Microbiological assay (MBA), 537
- Microorganisms, in dairy industry, 7
- Microstructure and microscopy techniques, for dairy products, 295–297
- Microtiter plate assay method, usage, 461; *see also* Lactic acid bacteria (LAB)
- Microwave-assisted extraction (MAE), 267
- Microwave radiation-induced hydrolysis, 13
- Midinfrared (MIR) spectroscopy, 143, 232, 331–332
- Milk allergens
- characteristics, 844–845
  - detection, 849
    - hidden allergens, 853–854
    - immunodetection, 850–852
    - proteomic techniques, 853
  - food processing effects, 846–847
    - enzymatic hydrolysis, 849
    - fermentation, 848
    - heat treatment, 847–848
    - homogenization, 849
    - ripening, 848
  - identification and characterization
    - allergen recognition, 846
    - DBPCFC, 845
    - patch tests, 846
    - skin prick test and RAST/EAST inhibition, 845–846
- Milk, bacteriophage detection systems, 471
- microbiological assays
    - conductance measurement, 473
    - electron microscopy, 473–474
    - flow cytometric detection, 475
    - growth test, 473
    - spot/plaque assay, 472–473
  - molecular methods
    - DNA-hybridization, 476
    - ELISA, 475
    - multiplex PCR, 477–478
    - PCR, 476
    - RT-qPCR, 478–479
- Milk-derived antimicrobial peptides, 58
- Milk fat
- detection methods, 742 (*see also* Adulterations detection, in milk and dairy products)
  - and triacylglycerides, 428
- Milk fat globule membrane (MFGM), 192
- Milk fat, TAG composition determination, 170; *see also* Milk products
- gas chromatography
    - molecular species separation, 173–177
    - separation on carbon number, 171–173
  - HPLC analysis
    - detection systems, 177–178
    - molecular species determination, 178–180
    - positional distribution of FAs, 180–182
- Milk flavor formation
- from autoxidation of milk lipids, 280–281
  - during heat treatment and storage, 279–280

- light-induced, 281
- package component migration, 281–282
- Milk intolerance, definition, 844
- Milk microstructure, 298–299; *see also* Microstructure and microscopy techniques, for dairy products
- Milk, mycotoxins analysis, 696–702
- Milk powder composition and adulteration, near-infrared spectroscopy, 331
- Milk processing, milk structure and properties changes, 90–92
- Milk products; *see also* Dairy foods
  - adulterations detection, 720, 733–734
    - antibody-based analytical methods, 738–741
    - chromatographic methods, 737–738
    - electrophoretic methods, 734–737
    - lipids, authentication testing, 721–724
    - lipids, proteins and authentication testing, 720–721
    - milk fat, 742
    - proteins, authentication testing, 724–728
    - species-specific PCR, 742–748
  - amino acids, analysis, 9–12
    - free amino acid analysis, sample preparation, 12
    - hydrolyzed amino acid analysis, sample preparation, 13–15
    - lysine analysis, 21–23
    - profile analysis, 15–21
    - tryptophan analysis, 23
    - whole amino acid content analysis, 15
  - antibiotics analysis, 802–803
    - confirmatory methods, 804–814
    - screening methods, 803
    - validation and measurement uncertainty, 814
  - biosensor techniques
    - for alkaline phosphatase, 315
    - amino acids and biogenic amines, 319–320
    - for antibiotics, 315–317
    - bacteria population determination, 318
    - for carbohydrates determination, 331–312
    - for drug residues, 317
    - hydrogen peroxide, 319
    - for lactic acid, 313–314
    - for lipids and fatty acids, 313
    - milk progesterone, 314
    - for milk protein, 310–311
    - for pesticides, herbicides, phenols and dioxins, 317–318
    - principle, 308–310
    - toxins, 318–319
    - for vitamins, 313
  - carbohydrates, quantitation methods
    - capillary electrophoresis, 160–161
    - classical methods, 141–143
    - enzymatic methods, 143–145
    - flow-injection analysis, 145
    - gas chromatography, 147–150
    - HPLC, 150–160
    - infrared spectroscopic methods, 143
    - mass spectrometry, 161–162
    - NMR spectroscopy, 162
    - planar chromatography, 146–147
  - cholesterol, determination
    - AOAC method, 233–235
    - biosensor techniques, 313
    - capillary gas chromatographic method, 237–239
    - enzymatic methods, 244–245
    - FIL-IDF method, 236–237
    - FTIR and FT-NIR spectroscopic methods, 241–242
    - HPLC, 239–241
    - SFC, 245–246
    - spectrometric methods, 242–244
  - dielectric spectroscopy, 338–340
  - fatty acids, 211–212
    - determination, 221–222
    - GC analysis, 213–217
    - identification, 222–224
    - isolation and fractionation, 217–219
    - preparation of derivatives, 212–213
    - silver ion HPLC, 219–221
  - flavor formation
    - amino acids proteolysis and catabolism, 284–286
    - from autoxidation of milk lipids, 280–281
    - during heat treatment and storage, 279–280
    - lactose fermentation and citrate conversion, 282–283
    - light-induced, 281
    - lipolysis and catabolism of fatty acids, 286–288
    - package component migration, 281–282
  - imaging techniques
    - computer vision systems, 333–335
    - hyperspectral imaging, 335–337
    - magnetic resonance imaging, 337–338
    - ultrasound imaging, 337
  - infrared spectroscopy
    - mid-infrared spectroscopy, 331–332
    - near-infrared technology, 330–331
  - lipolytic determination, 432–433
    - chromatographic methods, 440–443
    - immunological methods, 443
    - methods, 433
    - radioactive assays, 439
    - spectrophotometric assays, 435–439
    - surface tension methods, 443–444
    - titrimetric assays, 433–435
    - turbidimetric assays, 433
  - microbial spoilage detection, 665–667
    - chemical and physical spoilage, 672
    - future perspectives, 673
    - microbial metabolites, 670–671

- modeling spoilage, 672–673
- sensorial detection, 670
- spoilage microorganisms, detection methods, 668–669
- volatile compounds, 671–672
- mineral and trace element content, 545–546
  - analysis, 546–549
  - atomic spectrometry techniques, 559–569
  - chromatographic methods, 557–559
  - electroanalysis, 556–557
  - ion selective, 555–556
  - NAA, 551–553
  - speciation, 570–571
  - spectrofluorometry, 551
  - titrimetric methods, 549
  - visible spectrophotometric methods, 549–551
  - XRF, 553–555
- organic acids determination, 259–260
  - individual organic acid, 260–262
  - instrument-based methods, 262–272
- peptide, analysis
  - applications to dairy peptides, 50–63
  - chromatographic techniques, 40–45
  - electrophoretic methods, 34, 38–40
  - future perspectives, 63
  - immunochemical methods, 46–47
  - instrumentation, 47–49
  - interpretation, 49–50
  - spectroscopic techniques, 45–46
  - tandem mass spectrometry, 49
- polar lipids, 189–193
  - analysis, 199–205
  - sample preparation, 193–199
- protein
  - casein, molecular properties, 80–81, 85–86
  - characteristics of major bovine, 92–93, 95–98
  - electrophoretic methods, in analysis, 98–99
  - functional property, 88–89
  - hydrolysates peptides analysis, mass spectrometry, 60–61
  - Kjeldahl method, in analysis, 100
  - nutritional and functional roles, 43
  - proteolysis, 59
  - structure and properties changes, 90–92
  - system, types, 80
  - whey protein, molecular properties, 86–88
- proteomic technique, 110–111
  - future perspectives, 132
  - identification techniques, 124–132
  - sample preparation, 111–113
  - separation techniques, 113–124
- TAGs composition determination, 170
  - gas chromatography, 171–177
  - HPLC analysis, 177–180
  - positional distribution of FAs, 180–182
- viscosity measurement, 340–341
- Milk progesterone, biosensor techniques, 314
- Milk protein; *see also* Milk products
  - biosensor, 310–311
  - casein, molecular properties, 80–81, 85–86
  - characteristics of major bovine, 92–93, 95–98
  - electrophoretic methods, in analysis
    - capillary electrophoresis, 99
    - one-dimensional PAGE, 98–99
    - two-dimensional (2D) electrophoresis, 99
  - functional property, 88–89
  - hydrolysates peptides analysis, mass spectrometry, 60–61
  - Kjeldahl method, in analysis, 100
  - nutritional and functional roles, 43
  - proteolysis, 59
  - structure and properties changes, 90–92
  - system, types, 80
  - whey protein, molecular properties, 86–88
- Missing pulse steady-state free precession (MP-SSFP)
  - imaging, 338
- Mitomycin C drug, 459
- Modified MRS (mMRS), 509
- Molecular biology methods, in probiotics
  - microorganisms, 518–519; *see also* Probiotics
  - culture-dependent techniques, 519–522
  - culture-independent techniques, 522–523
- Molecular genetic techniques, application, 742; *see also* Adulterations detection, in milk and dairy products
- Molecular methods, for species identification, 452–454; *see also* Starter cultures, LAB
- Molecular species of TAGs in dairy fats, separation; *see also* Triacylglycerols (TAGs) composition determination, in milk
  - gas chromatography, 173–177
  - HPLC, 178–180
- 15-Monoacetoxyscirpenol (MAS), 690
- Monomolecular films, usage, 444; *see also* Milk products
- Monospecific antibodies (MAbs), 741
- Monounsaturated fatty acid (MUFA), 215
- Mozzarella cheese
  - microstructure, 301
  - processing, 591 (*see also* Dairy foods)
- MTBSTFA, *see* *N*-methyl-*N*-(*t*-butyldimethylsilyl)-trifluoroacetamide
- Multilocus enzyme electrophoresis method, 452; *see also* Lactic acid bacteria (LAB)
- Multilocus sequence-typing (MLST), 653
- Multiple linear regression (MLR) analysis, 727; *see also* Milk products
- Multivariate data analysis (MVDA), 632
- Multivitamin methods, for WSV quantification, 536; *see also* Infant formulae (IF)



*Mycobacterium avium* subsp. *paratuberculosis*, 679, 683–684

Mycotoxins, in dairy foods  
analysis  
analytical quality assurance, 690–692  
cleanup methods, 694  
detection systems, 695, 703–704  
extraction procedures, 693  
laboratory precautions, 693  
quantitative methods, 695  
sample preparation, 693  
screening tests, 694–695  
sources, 690

## N

NAA, *see* Neutron activation analysis  
 $\beta$ -/ $\alpha$ -Naphthyl acyl substrate analogs, 436  
NanoESI-MS/MS analysis, application, 128  
NanoLC/ESI-tandem mass spectrometry (MS/MS), 123  
Nasal impact frequency (NIF), 627  
Near-infrared reflectance (NIR) spectrophotometers, 583  
Near-Infrared Spectroscopy (NIRS)  
in adulteration detection, 726–728  
in dairy foods, 330–331  
*N*- $\epsilon$ -(2,4-dinitrophenyl)-l-lysine (DNP-Lys), 22  
Neosolaniol (NEO), 690  
Neutron activation analysis, 550–554; *see also* Milk products  
Newtonian fluids, definition, 609–610  
Nicotinamide-adenine dinucleotide (NAD), 143, 261  
Ninhydrin  
in amino acid derivatization, 16  
role, 410  
Nitrogen phosphorous detection (NPD), 20, 620  
Nivalenol (NIV), 690  
*N*-methyl-*N*-(*t*-butyldimethylsilyl)-trifluoroacetamide, 19–20  
2-(*N*-morpholino) ethanesulfonic acid/  
tris(hydroxymethyl) aminomethane (MES-TRIS), 488  
Noncasein nitrogen (NCN), 39  
Non-MS-based techniques, in proteins identification, 124–125  
Nonprotein nitrogen (NPN), 10  
Normal phase HPLC (NP-HPLC), 177  
*N*-*tert*-butyl dimethylsilyl (tBDMSi), 22  
Nuclear magnetic resonance (NMR), 162, 460  
Nutritional and health features, of probiotic foods, 506–508; *see also* Probiotics

## O

Ochratoxin A (OTA), 690  
Odor-activity value (OAV) concept, 634–635  
Odorant receptor (OR), 616  
Off-flavors, definition, 637; *see also* Dairy flavor  
Oil drop method, usage, 443; *see also* Milk products  
Olson and Price method, usage, 333  
One-dimensional (1D) electrophoretic technique,  
in cheese analysis, 411; *see also* Cheese, proteolysis  
One-dimensional PAGE, in milk protein analysis, 98–99  
OPA application, limitations, 870  
*o*-phthaldialdehyde (OPA), 15, 17–18, 455  
Optical biosensor methods, usage, 536–537; *see also* Infant formulae (IF)  
Optical biosensors, usage, 309  
Optical waveguide lightmode spectroscopy (OWLS), 309  
Organic acids, in dairy products, 259–260; *see also* Milk products  
analytical methods for determining  
for individual organic acid, 260–262  
instrument-based methods, 262–272  
Organic contaminants, in dairy foods, 822  
Ovine  $\kappa$ -casein isoforms, separation, 120

## P

Package component migration, in flavor development, 281–282; *see also* Flavor formation  
Packaging formats, of dairy products  
active and intelligent packaging, 773–774  
metal cans, 769–770  
multilayer packaging materials, 771–772  
paper/cartonboard, 767–769  
plastics, 765–766  
surface-active biocides, 774–775  
Paper chromatography (PC), usage, 411; *see also* Cheese, proteolysis  
Paper, usage in dairy products, 767–769  
Parallel affinity sensor array (PASA), 317  
Parmigiano Reggiano cheese, 287–288  
Partial least square-discriminant analysis (PLS-DA), 722  
*p*-bromophenacyl (PBP) esters, 221  
PCR-restriction fragment length polymorphism (PCR-RFLP), 519  
*Pediococcus acidilactici*, 653  
*Penicillium camemberti*, 649  
*Penicillium camemertii*, 42  
*Penicillium roqueforti*, 649  
*Penicillium* spp., 286

- Pentose phosphate pathway, usage, 389; *see also*  
 Glycolysis determination, in dairy foods
- Peptide, analysis; *see also* Milk products  
 conventional methods  
 chromatographic techniques, 40–45  
 electrophoretic methods, 34, 38–40  
 immunochemical methods, 46–47  
 spectroscopic techniques, 45–46  
 future perspectives, 63  
 mass spectrometry  
 applications to dairy peptides, 50–63  
 instrumentation, 47–49  
 interpretation, 49–50  
 tandem mass spectrometry, 49
- Peptide mass fingerprint (PMF), 109, 125
- Peptides, fractionation, 408–409
- Peptidomic technique, in dairy products; *see also* Milk products  
 future perspectives, 132  
 identification techniques  
 ESI-MS, 127–132  
 MALDI-MS, 125–126  
 non-MS-based techniques, 124–125  
 separation techniques  
 capillary electrophoresis, 118–120  
 2D-PAGE, 113–118  
 HPLC techniques, 120–124
- Persistent organic pollutants (POPs), 822–823, 835
- Pesticides, 823–824  
 definition, 823  
 and milk contamination, 823–824  
 and POPs analysis, in dairy foods  
 cleanup, 833–834  
 HRGC, selective detectors, 836–837  
 identification and quantitation, 835–836  
 liquid foodstuff and analyte extraction, 825–827  
 mass spectrometric detector, 837–838  
 semiliquid and analyte extraction, 827–833
- Phanerochaete sordida*, 144
- Phenotypic methods, for LAB identification, 451–452;  
*see also* Starter cultures, LAB
- Phenylisothiocyanate (PITC), in amino acid  
 derivatization, 16
- Phosphate-buffered saline (PBS), 516
- Phosphoenol pyruvate (PEP), 388
- Phosphoglucose-isomerase (PGI), 144
- <sup>31</sup>P-hosphorus nuclear magnetic resonance (<sup>31</sup>P-NMR),  
 204–205
- Phosphotungstic acid (PTA), 93, 407–408
- pH stat method, in lipolytic determination, 434–435;  
*see also* Milk products
- Phthalates, 777–780  
 in dairy products, detection, 787  
 in infant milk, 780, 786  
 instrumental conditions, 795–796  
 migration, 790–792  
 milk consumption, 786–787  
 in nondairy products, 787–789  
 sample contamination, 792  
 sample pretreatment, 792–795  
 total diet, 789–790  
 physical properties, 779  
 structure, 778
- Plaque assay method, usage, 472–473; *see also*  
 Bacteriophage detection systems, in milk
- Plasticized polyvinyl chloride (PVC), 551
- Plastics, usage in dairy products, 765–766
- p*-Nitrobenzofurazan (NBD), usage, 438–439
- p*-Nitrophenyl acyl substrate analogs, usage, 435–436
- Polarimetric methods, for carbohydrate  
 determination, 141
- Polar lipids, in dairy products, 189–193; *see also* Milk products  
 analysis  
 HPLC, 202–204  
<sup>31</sup>P-NMR, 204–205  
 thin-layer chromatography, 200–202  
 total phospholipid content, 199–200  
 total sphingolipid content, 200  
 sample preparation  
 extraction methods, 193, 195  
 fractionation, 195, 197, 199
- Polyacrylamide gel electrophoresis (PAGE), 34, 410
- Polyamines (PA), 861  
 analysis, 866  
 in cell growth, 863  
 in cheese, 866  
 chemical structure, 862  
 in dairy foods, 864  
 detection method, 872–873  
 determination in cheese, 868  
*N*-nitroso compounds formation, 864
- Polydextrose, determination, 489, 495–496; *see also*  
 Prebiotics
- Polydimethylsiloxane (PDMS), 624
- Poly(glycidyl methacrylate) (PGMA), 519
- Poly lactate (PLA), 595
- Polymerase chain reaction (PCR), 6, 475–476, 506,  
 520–522  
 in adulteration detection, 743–745 (*see also* Milk products)  
 features, 678–679  
 for foodborne pathogens, 679–680  
*Enterobacter sakazakii*, 682–683  
 future perspectives, 684–685  
*Listeria monocytogenes*, 681–682  
*Mycobacterium avium subsp. paratuberculosis*,  
 683–684  
*Salmonella*, 680–681  
 in microorganisms identification, 652  
 principles and applications, 678

- Polystyrene (PS), 595
- Polyunsaturated fatty acids (PUFAs), 177, 213
- Polyvinylidene fluoride (PVDF) filters, 113
- Positional distribution of FAs, in TAGs, 180–182; *see also*  
Milk fat, TAG composition determination
- Potentiometric biosensors, usage, 309
- Powdered infant formula (PIF), 682
- Prebiotics  
analytical methods  
fructans, determination, 489  
polydextrose, determination, 489, 495–496  
resistant maltodextrins, determination,  
496–498  
total dietary fiber, determination, 487–489  
*trans*-galactooligosaccharides,  
determination, 489  
applications, 485  
beneficial properties, 486  
definition, 485  
determination, 490–494  
food ingredients, 487  
origin, manufacture and physicochemical properties,  
486–487
- Prefractionation, of milk proteins, 92–93
- Pressurized solvent extraction (PLE) technique, usage,  
829–830
- Principal component analysis (PCA), 44, 621
- Probiotic cultures, definition, 648
- Probiotics, 503–506  
analytical methods, 523–524  
definition, 503  
foods, nutritional and health features, 506–508  
identification, 524  
microorganisms, detection and identification,  
508–509  
conventional methods, 509, 515  
enzymatic methods, 518  
fluorescence methods, 516–518  
molecular biology methods, 518–523  
selection, 506
- Programmed temperature vaporizer (PTV) injection,  
173
- Prophage, definition, 470
- Propidium monoazide (PMA), 454
- Propionate pathway, in propionibacteria, 393–394
- Propionibacteria, role, 393–394
- Propionibacterium freudenreichii*, 283
- Propionic acid bacteria, role, 648
- Protected Designation of Origin (PDO), 39, 588
- Protected geographical indication (PGI), 588
- Protein efficiency ratio (PER), 10
- Protein identification, UV spectra derivatives,  
93–96
- Protein metabolic pathways, in flavor formation, 284
- Proteins, in dairy products; *see also* Milk products  
authentication testing, 724–728  
casein, molecular properties, 80–81, 85–86  
characteristics of major bovine, 92–93, 95–98  
electrophoretic methods, in analysis, 98–99  
functional property, 88–89  
hydrolysates peptides analysis, mass spectrometry,  
60–61  
Kjeldahl method, in analysis, 100  
nutritional and functional roles, 43  
proteolysis, 59  
structure and properties changes, 90–92  
system, types, 80  
whey protein, molecular properties, 86–88
- Proteolysis, in cheese, 405–406  
chemometric analysis, 414–417  
chromatographic methods, 411–412  
colorimetric and fluorimetric methods, 409–410  
electrophoresis, 410–411  
extraction methods, 406–408  
MALDI-ToF-MS, 412–413  
methods, 409  
peptides fractionation, 408–409
- Proteolysis of milk proteins, mass spectrometry  
techniques, 59
- Proteolytic peptides in dairy products, analysis, 120
- Proteomic analysis of milk proteins, mass spectrometry,  
50–54
- Proteomic technique, in dairy products, 110–111; *see also*  
Milk products  
future perspectives, 132  
identification techniques  
ESI-MS, 127–132  
MALDI-MS, 125–126  
non-MS-based techniques, 124–125  
in milk allergens detection, 853 (*see also* Milk  
allergens)  
sample preparation, 111–113  
separation techniques  
capillary electrophoresis, 118–120  
2D-PAGE, 113–118  
HPLC techniques, 120–124
- Proton-transfer reaction-mass spectrometry (PTR-MS),  
8, 352, 631
- Pseudomonas fluorescens*, 667
- Pseudomonas fragi*, 667
- Pseudomonas putida*, 667
- Psychrotrophic microorganisms, definition, 667
- Pulsed amperometric detection (PAD), 155
- Pulsed field gel electrophoresis (PFGE), 453,  
519, 653
- Pyrenic acylglycerol derivatives, role, 438
- Pyridoxal (PL), 532
- Pyridoxamine (PM), 532
- Pyridoxine (PN), 532
- Pyruvate, alternative pathways, 391–393

## Q

- Quadrupole mass spectrometer analyzers, 48
- Quadrupole-time-of-flight (QTOF), 49
- Quantitative descriptive analysis (QDA), 635–636
- Quantitative structure–property relationship (QSPR) method, 778
- Quartz crystal microbalance (QCM), 309

## R

- Radial immunodiffusion, principle, 850
- Radio-allergosorbent/enzyme-allergosorbent (RAST/EAST), 845–846
  - in milk allergens estimation, 850
  - principle, 850–851
- Radioimmunoassay (RIA), 694
- Raman spectroscopic technique, 46
- Randomly amplified polymorphic DNA (RAPD), 452, 519, 654
- Randomly amplified polymorphic DNA (RAPD)-PCR analysis, role, 651
- Rapid One Step Assay (ROSA), 694–695
- Reactive sulfhydryl groups (RSH), 99
- Real-time PCR (RTi-PCR), 454, 678
- Real-time quantitative PCR (RT-qPCR), 478–479
- Reference daily intake (RDI), 10
- Refractive index (RI)
  - detector, 460
  - of organic acids, 264, 267
  - role, 442
- Reinforced clostridial agar (RCA), 509
- Relative standard deviations (RSD), 559
- Repeated sequence extragenic palindrom PCR (REP-PCR), 519
- Resistant maltodextrins, determination, 496–498; *see also* Prebiotics
- Resorufin ester, usage, 436–437
- Restriction enzyme analysis (REA), 519
- Restriction fragment length polymorphism (RFLP), 452
- Reversed passive latex agglutination (RPLA), 709
- Reverse phase high-performance liquid chromatography (RP-HPLC), 19, 151, 154, 270, 671
  - for amine determination, 871
  - for bovine milk detection, 737
  - usage, 441
- Rf-binding protein (RBP), 313
- Rheological techniques, for dairy foods, 367–368
- Rhodamine B, usage, 439
- Rhodotorula gracilis*, 320
- Ribosomal RNA (rRNA), 509
- Roese–Gottlieb method, 5
- Rotational viscometers, usage, 611; *see also* Dairy foods

## S

- Saccharides, determination, 496
- Saccharomyces cerevisiae*, 314
- Saccharomyces unisporus*, 649
- Sale of Food & Drugs Act, 1875, 5
- Salmonella enterica*, 680
- Salmonella typhimurium*, 318
- Sandwich enzyme-linked immunosorbent assay (S-ELISA), 100
- Saturated fatty acids, 212
- SBR extraction method, for polar lipids, 195
- Scanning electron microscopy (SEM), 296–297
- Screen-printed carbon electrode (SPCE), 312
- Screen-printed electrodes (SPEs), 317
- SDE, *see* Simultaneous distillation-extraction
- Selected ion-monitoring (SIM), for phthalates detection, 795
- Selected reaction monitoring (SRM), definition, 837
- Sensorial detection, of milk and dairy products spoilage, 670; *see also* Milk products
- Sensors based on injection of the recognition element (SIRE), 319
- Sensory evaluation technique, usage, 670; *see also* Milk products
- Sensory measurements, of dairy foods, 609; *see also* Dairy foods
- Sepharose columns, usage, 112
- SFC, *see* Supercritical fluid chromatography
- Shiga toxin-producing *E. coli* (STEC), 707
- Shiga toxins (Stxs), 707
- Shigella dysenteriae*, 707
- Short-chain FFAs, GC analysis, 263
- Shredded Cheddar cheese, 594
- Silver ion HPLC (Ag<sup>+</sup>-HPLC), 177, 218–221
- Silver ion TLC, in milk fat analysis, 218
- Simultaneous distillation-extraction, 263, 617–618
- Sinapinic acid, usage, 126
- Single-stranded conformational polymorphism analysis (SSCP), 522, 655
- Size exclusion chromatography (SEC), 570
- Size exclusion (SE)-fast protein liquid chromatography (FPLC), 40
- Skimmed milk powder (SMP), 123
- Skin prick test, for food allergy diagnosis, 845–846; *see also* Milk allergens
- Smear cheeses, 591
- Smear-ripened cheeses, characteristics, 648
- Sodium caseinate, chromatogram, 97
- Sodium dodecyl sulfate polyacrylamide gel electrophoresis (SDS-PAGE), 98, 451–452, 650, 724
- Sodium dodecyl sulfate (SDS), 21, 109
- Solid-phase extraction, 195, 534, 622, 694, 825–826; *see also* Pesticides

- Solid-phase microextraction (SPME), 347  
 in dairy foods, 826–827 (*see also* Pesticides)  
 technique, for pesticides detection, 827  
 usage, 617–619, 623
- Soluble dietary fiber (SDF), 487
- Solvent-assisted flavor evaporation (SAFE) technique,  
 usage, 617–618
- Solvent extraction (SE), 617
- Somatic cell counts (SCC), of milk, 747
- Soxhlet extraction, for pesticides detection, 828; *see also*  
 Pesticides
- Soy protein isolate (SPI), 590
- SPE, *see* Solid-phase extraction
- Spectra-characterizing parameters, selection, 96
- Spectrocolorimetry, usage, 592
- Spectrofluorometric method; *see also* Milk products  
 in dairy products manufacture, 551  
 in minerals and trace elements, 553
- Spectrometric/colorimetric methods, for cholesterol  
 determination, 242–244
- Spectrophotometers, in dairy food color analysis,  
 584–585; *see also* Dairy foods
- Spectroscopic techniques  
 for dairy foods, 369–379  
 for glycolysis determination, 396  
 for peptide analysis, 45–46
- Spectrum™ method, in dairy flavor analysis, 635, 637;  
*see also* Dairy flavor
- Sphingolipids, in dairy products, 190–191
- Springiness, calculation, 606; *see also* Dairy foods
- SPR technology biosensor, advantage, 803
- Standard error of calibration (SEC), 371
- Standard plate count procedures, usage, 668
- Staphylococcal enterotoxin A (SEA), 319
- Staphylococcal enterotoxin B (SEB), 319
- Staphylococcal enterotoxins (SEs), 707
- Staphylococcus aureus*, 318, 704, 707
- Starter bacteria, function, 648; *see also* Dairy foods
- Starter cultures, LAB  
 identification  
 culture methods, 450–451  
 molecular methods, 452–454  
 phenotypic methods, 451–452  
 technological properties  
 acidification and diacetyl production, 454  
 amino acid catabolism, 455–458  
 antimicrobial compounds, production, 460–461  
 bacteriophage resistance analysis, 458–459  
 exopolysaccharides production, 459–460  
 proteolysis, 454–455
- Static headspace (SHS) technique, usage, 618
- Steam distillation (SD), 617
- Sterols in dairy products, extraction methods, 247;  
*see also* Cholesterol, in dairy products
- Streptococcus thermophilus*, 112, 126, 387, 413, 450, 455,  
 515, 648, 653
- Stripping voltammetry (SV), 557
- Sulfonamides (SMZs), 316
- Sulfonated polystyrene–divinylbenzene (SPD), 264
- Sulfosalicylic acid (SSA), 408
- Supelcowax 10 capillary column, usage, 215
- Supercritical fluid chromatography, 171, 180, 232,  
 245–246
- Supercritical fluid extraction (SFE), advantage and  
 usage, 617, 832–833
- Surface-active biocides, of dairy products, 774–775
- Surface-enhanced laser desorption/ionization (SELDI),  
 63
- Surface of NIF (SNIF), 627
- Surface plasmon resonance (SPR), 309, 537, 852
- Surface tension methods, in lipolytic activity  
 determination, 443–444

## T

- Tagatose-6P pathway, usage, 390–391
- Tandem mass spectrometry (MS/MS)  
 for peptide analysis, 49  
 for TAGs determination, 178  
 usage, 837
- TA-XT2 Texture Analyser, usage, 357
- TDF, *see* Total dietary fiber
- Temperature-gradient gel electrophoresis (TGGE), 453,  
 522–523, 654–655
- Terminal restriction fragment length polymorphism  
 (T-RFLP), 653
- Terminal restriction fragments (T-RFs), 653
- Tetramethylammonium hydroxide (TMAH), 221
- Texture; *see also* Dairy foods  
 definition, 605  
 measurement techniques, of dairy foods  
 butter, 607–608  
 cheese, 607  
 yogurt, 608–609
- Texture analyzer (TA), 606
- Texture profile analysis (TPA), 8, 606–607
- Theoretical carbon number (TCN), 177
- Thin layer chromatography (TLC), 171, 200–202  
 for AFM1 in milk, 694  
 for amine determination, 871  
 in lipolytic activity determination, 440
- Titrate acidity (TA), usage, 260
- Titrimetric methods  
 in dairy products manufacture, 549  
 in mineral determination, 550 (*see also* Milk  
 products)  
 usage, 434
- Total amino acid analysis, sample  
 preparation, 13–15
- Total dietary fiber, 487–489; *see also* Prebiotics

- Total internal reflectance fluorescence (TIRF)  
 biosensor, 314
- Total phospholipid content, analysis, 199–200; *see also*  
 Polar lipids, in dairy products
- Total sphingolipid content, analysis, 200; *see also* Polar  
 lipids, in dairy products
- Toxins, in dairy foods  
 analysis  
 biological assays, 708  
 biologic-immunologic-phenotypic combination  
 studies, 710–711  
 future perspectives, 711–712  
 phenotypic assays, 709–710  
 bacterial toxins, 704, 707–708
- Trametes villosa*, 144
- Trans*-galactooligosaccharides, determination, 489;  
*see also* Prebiotics
- Trans*-galactooligosaccharides (TGOS), 486
- Transmission electron microscopy (TEM), 296
- Triacylglycerols (TAGs) composition determination, in  
 milk, 169–170; *see also* Milk products  
 analysis, 723–724  
 enzymatic hydrolysis and acyl migration, 431  
 gas chromatography  
 molecular species separation, 173–177  
 separation on carbon number, 171–173  
 HPLC analysis  
 detection systems, 177–178  
 molecular species determination, 178–180  
 positional distribution of FAs, 180–182
- Trichloroacetic acid (TCA), 43, 93
- Trichospora beigeli*, 649
- Trifluoroacetic acid (TFA), 19
- Triglycerides (TGs), analysis, 723
- 2,4,6-Trinitrobenzene sulfonic acid (TNBS), 15,  
 409–410
- Tris(2-carboxyethyl) phosphine (TCEP), 533
- Tristimulus colorimetry, in dairy food color analysis,  
 584; *see also* Dairy foods
- Triton X-100, usage, 432
- Tryptophan, analysis, 23; *see also* Milk protein
- Two-dimensional (2D) electrophoresis, in milk protein  
 analysis, 99
- Two-dimensional GC, in dairy flavor analysis, 622–624;  
*see also* Dairy flavor
- Two-dimensional HPLC (2D-HPLC), usage, 412
- Two-dimensional polyacrylamide gel electrophoresis  
 (2D-PAGE), 109, 113–118
- Tyramine, importance, 862
- U**
- Ultrafiltered milk, microscopic techniques, 298
- Ultrafiltration, usage, 113
- Ultra heat treatment (UHT), 89, 280, 635
- Ultrapformance liquid chromatography (UPLC),  
 805–810
- Ultrasound imaging, of dairy products, 337
- Ultraviolet–visible (UV–vis)  
 of organic acids, 264  
 spectrophotometry, 549
- Umbelliferol esters, role, 438
- United Kingdom Ministry of Agriculture Fisheries and  
 Food (UK MAFF), 692
- Urea-polyacrylamide gel electrophoresis (PAGE),  
 734–735
- Uridine diphosphate (UDP), 87
- U.S. Environmental Protection Agency (USEPA), 835
- UV spectra derivatives, in protein identification, 93–96
- V**
- Vaccenic acid (VA), 212
- Vapor-phase hydrolysis method, 13
- Verotoxin (VT), 707
- Viscometers, usage, 340–341
- Viscosity measurement, of dairy foods, 609–610; *see also*  
 Dairy foods  
 capillary tube viscometer, 611  
 rotational viscometers, 611
- Visible and near-infrared reflectance (VNIR)  
 spectrophotometry, 583–584
- Visible spectrophotometric methods; *see also* Milk  
 products  
 in dairy products manufacture, 549–551  
 in Fe determination, 551  
 in minerals and trace elements, 552
- Vitamins  
 biosensor techniques, 313  
 extraction and HPLC quantification  
 fat-soluble vitamin extraction, 535–536  
 water-soluble vitamin extraction, 533–535  
 forms  
 fat-soluble vitamins, 533  
 water-soluble vitamins, 532  
 role, 531
- W**
- Wall-coated open tubular (WCOT) capillary columns,  
 213
- Water-soluble extract (WSE), 406
- Water-soluble fraction (WSF), 41
- Water-soluble nitrogen (WSN), 332, 406–408
- Water-soluble vitamins (WSV); *see also* Vitamins  
 extraction, 533–535  
 forms, 532

Wavelength-dispersive (WD)-XRF, usage, 555  
Western blotting technique, usage, 852; *see also* Milk allergens  
Whey protein nitrogen index (WNPI), 99  
Whey proteins, 14, 80  
    in adulteration detection, 736–738 (*see also* Adulterations detection, in milk and dairy products)  
    chromatographic analysis, 737  
    molecular properties, 86–88 (*see also* Milk protein)  
Whole amino acid content, analysis, 15  
Whole powdered milk, microscopic techniques, 298

## X

X-ray fluorescence (XRF), 553–556

## Y

*Yarrowia lipolytica*, 649  
Yellowness index (YI), calculation, 595  
Yoghurt; *see also* Dairy foods  
    aroma release, 354–355  
    microstructure techniques, 302

## Z

$\alpha$ -Zearalanol ( $\alpha$ -ZAL), 690  
 $\beta$ -Zearalanol ( $\beta$ -ZAL), 690  
 $\alpha$ -Zearalenol ( $\alpha$ -ZEL), 690  
 $\beta$ -Zearalenol ( $\beta$ -ZEL), 690  
Zearalenone (ZEN), 690

## HANDBOOK OF

# Dairy Foods Analysis

Dairy foods account for a large portion of the Western diet, but due to the potential diversity of their sources, this food group often poses a challenge for food scientists and their research efforts. Bringing together the foremost minds in dairy research, *Handbook of Dairy Foods Analysis* compiles the top dairy analysis techniques and methodologies from around the world into one, well-organized volume.

Exceptionally comprehensive in both its detailing of methods and the range of products covered, this handbook includes tools for analyzing chemical and biochemical compounds and also bioactive peptides, prebiotics, and probiotics. It describes noninvasive chemical and physical sensors and starter cultures used in quality control.

Discussing the full range of tools available for analyzing the chemistry and biochemistry of dairy foods, this cohesive resource:

- Describes the methodologies for analyzing nutritional, sensory quality, and safety aspects
- Covers a variety of dairy foods including milk, cheese, butter, yogurt, and ice cream
- Details methods for analyzing nutritional quality including for prebiotics, probiotics, essential amino acids, and bioactive peptides
- Includes a series of chapters on analyzing sensory qualities, including color, textures, and flavor

Under the editorial guidance of renowned authorities, Leo M.L. Nollet and Fidel Toldrá, this handbook is one of the few references that is completely devoted to dairy food analysis — an extremely valuable reference for those in the dairy research, processing, and manufacturing industries.

